

LAMILUX Lichtkuppel F100 rund

Montageanleitung

LAMILUX Rooflight F100 Circular
Assembly instruction

Allgemeines

General remarks

Deutsch:

Der Inhalt der Montageanleitung wurde nach bestem Wissen erstellt.
Alle Hinweise, technischen und bildlichen Angaben entsprechen dem derzeitigen technischen Stand, sowie unseren darauf basierenden Erfahrungen.

Rechtliche Ansprüche können daraus nicht abgeleitet werden.
LAMILUX behält sich Änderungen der technischen Angaben vor.

Alle Arbeiten sind nach den anerkannten Regeln der Technik, den Vorschriften und Richtlinien von Behörden, Berufsgenossenschaften, Unfallverhütungsvorschriften und Fachverbänden der Bundesrepublik Deutschland, der Europäischen Union und des Bestimmungslandes auszuführen. Soweit Normen, Regeln der Technik oder Richtlinien (beispielsweise EN, DIN, VDE, VDI, VDS oder ihnen gleichzusetzende Normen) bestehen, so ist unter Einhaltung dieser zu arbeiten.

Revisionsindex:
Diese Ausgabe ersetzt vorhergehende Ausgaben komplett.

English:

The content of this mounting instruction has been established to the best of our knowledge.
All notes, technical and visual information reflect the current state of technology and are based on our experiences.

Legal claims cannot be derived from the content of this installation manual.
LAMILUX reserves the right to change technical specifications.

Every work has to be done in accordance with the current state of technology, the regulations and guidelines of authorities, trade associations, accident prevention regulations and professional associations of the Federal Republic of Germany, the European Union and the country of destination. As far as standards, technical regulations or guidelines (e.g. EN, DIN, VDE, VDI, VDS or equal standards) exist, the work has to be done in compliance with those directives.

Revision index:
This version replaces previous editions completely.



Die Betriebsanleitung ist zu beachten
Insbesondere Sicherheits- und Bedienungshinweise

*The instruction manual must be observed
Especially safety and operating instructions*



Kunststoffdächer dürfen nicht betreten werden DURCHBRUCHGEFAHR

Plastic rooftops are not walkable - RISK OF BREAKING THROUGH



Immer absturzsichernde Maßnahmen vornehmen

Always use fall arrest equipment and follow national regulations for fall-through protection



Vollständigkeit der Lieferung gemäß Ladestückliste prüfen

Check if the delivery is complete (according to the bill of materials)

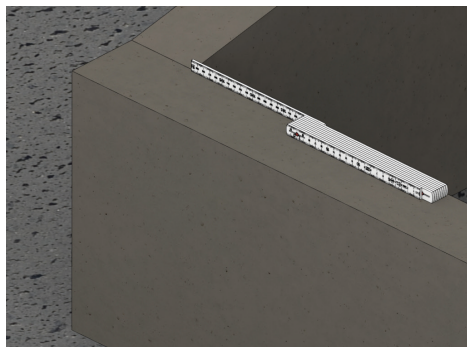

Prüfung der Rohbausituation

Im Allgemeinen gelten die Baukörper toleranzen welche auf unserer Homepage zum Downloaden zur Verfügung stehen.

(www.lamilux.de/downloads)

Check and prepare for mounting and installation

In general, the building tolerances apply which can be found on our homepage.

(www.lamilux.com/downloads)

Inhaltsverzeichnis

Table of Contents

Diese Montageanleitung ist nach der Reihenfolge der Montageschritte aufgebaut.
This installation manual is structured according to the sequence of assembly steps.

Transport Montage <i>transport assembly</i>	5
Bauanschluss <i>structural attachment</i>	6 - 7
Transportschutz entfernen <i>removal of transport protection</i>	8
Starr verriegelt - innen <i>rigid locked - inside</i>	9
Lüftbar verriegelt - solo <i>ventilated locked - solo</i>	10 - 11
Lüftbar verriegelt - tandem <i>ventilated locked - tandem</i>	12 - 13
24V Motor solo "Typ JM-DC" <i>24V drive solo "type JM-DC"</i>	14 - 15
24V Motor tandem "Typ JM-DC" <i>24V drive tandem "type JM-DC"</i>	16 - 17
230V Motor "Typ SP8" <i>230V drive "type SP8"</i>	18 - 19
Anschlusspläne Elektromotoren <i>wiring diagrams of electric drives</i>	20
Notizen <i>notes</i>	21 - 22
Kontakte <i>contacts</i>	23

Transport | Montage

Transport | Assembly

Bauteile der Serie Lichtkuppel F100 Rund werden komplett auf ihren Aufsatzkranz montiert ausgeliefert. Die Elemente werden zum Versand in einem Holzverschlag verpackt. Dieser Holzverschlag ist auf der Standfläche mit Holzbohlen versehen und kann mit einem Gabelstapler transportiert werden. Das Hochziehen der Elemente, auf die Dachfläche, sollte mit der Palette erfolgen. Zum Schutz der Konstruktion sollte sie so lang wie möglich in der Transportkiste verbleiben. Das Element nicht an den Rahmenprofilen anheben (Bruchgefahr), es kann zum Vertragen auf dem Dach am Fußflansch des Kranzes angehoben werden.

Rooflights of the F100 series will be delivered already completely pre-assembled onto our curb. The rooflights will be therefore packed on a wooden crate. The bottom of the wooden crate is designed with square timbers and can be transported with a forklift truck. Lifting up the rooflights to the roof should be done including the wooden crate. For safety reasons, the rooflights should be kept as long as possible inside the wooden crate. Do NOT lift up the rooflights on the frame (risk of breakage). Rooflights can be touched on the bottom flange to carry it to the roof opening.



!! ACHTUNG | ATTENTION !!

Lichtkuppeln durchlüftet auf Holzbalken ablegen.
Place the rooflight on wooden beams that the element can aerate.

Verformungsgefahr | Risk of deformation



HITZESTAU VERMEIDEN!
Avoid heat accumulation!

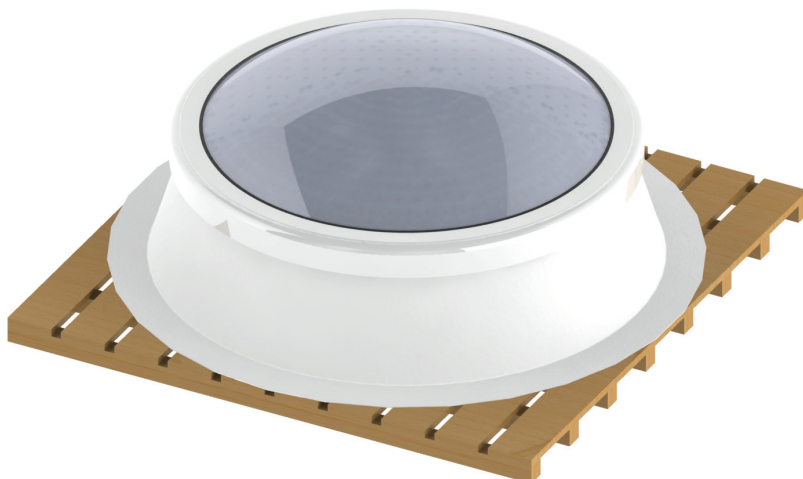

Bauanschluss

Structural attachment

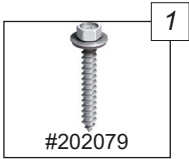

#202079
Holzschraube
JA3-6,5x50-E16/2
Wood screw
JA3-6,5x50-E16/2

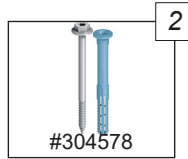

#304578
Schraubdübel
SDF-KB-10Vx50-V
Screw-in wall plug
SDF-KB-10Vx50-V

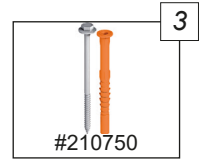

#210750
Schraubdübel
SDP-KB-10Gx80-V
Screw-in wall plug
SDP-KB-10Gx80-V

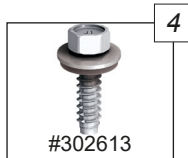

#302613
Dichtschraube
JA3-6,5x32-E16/2
Sealing screw
JA3-6,5x32-E16/2

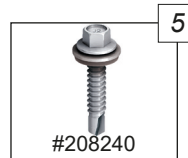

#208240
Bohrschraube
JT3-6-5,5x30 E16/2
Drilling screw
JT3-6-5,5x30 E16/2

Unterkonstruktion <i>Substructure</i>	Positionsnummer <i>Item number</i>	Bohrung im Kranz <i>Drill hole in upstand</i>
Holzbohle <i>Plank</i>	1	Ø 7mm
Stahlbeton <i>Reinforced concrete</i>	2	Ø 10,5mm
Porenbeton <i>Aerated concrete</i>	3	Ø 10,5mm
Stahl <i>Steel 0,63 - 1,5mm</i>	4	Ø 7mm
Stahl <i>Steel 1,5 - 3mm</i>	5	Ø 6mm



Befestigungsmittel gehören nicht zum Lieferumfang.
Gleichwertige Alternativen mit bauaufsichtlicher Zulassung sind verwendbar.

*Fastening material is not included in scope of delivery.
Equivalent fasteners with technical approval could also be used.*

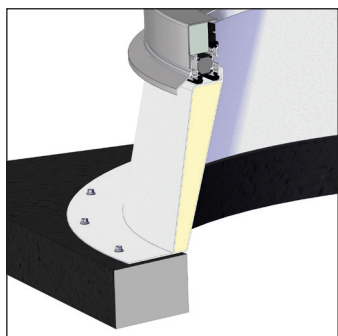
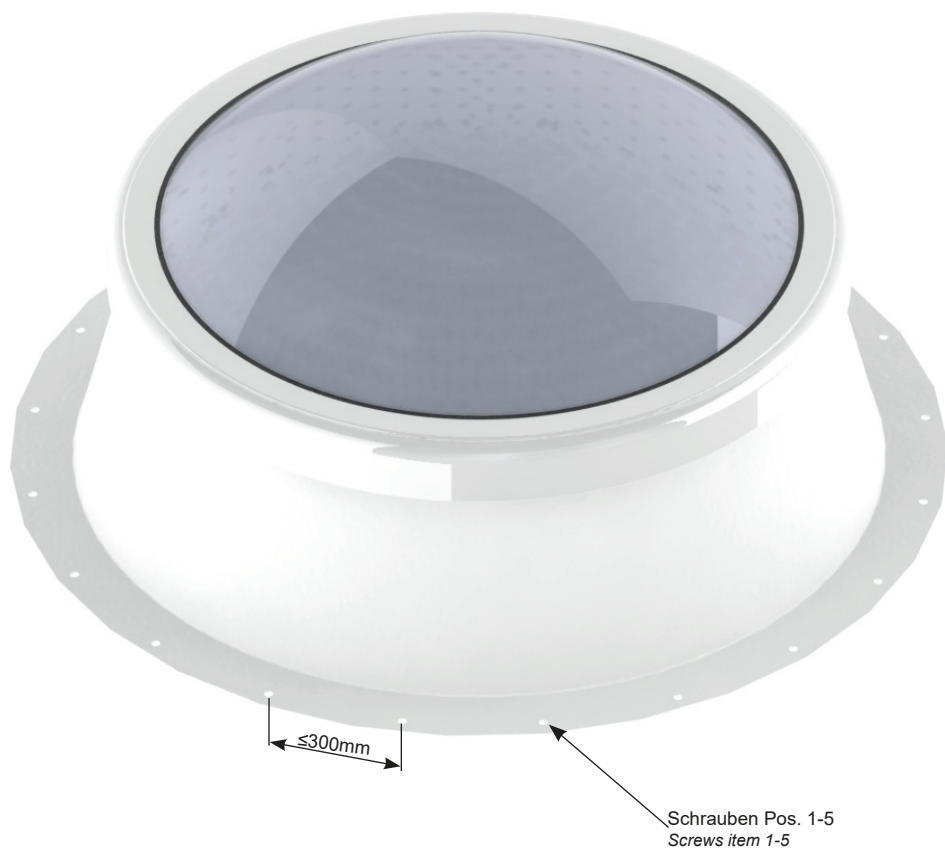

Prinzipdarstellung!
Dachabdichtungsarbeiten sind nach den entsprechenden Fachregeln durch den Dachdecker auszuführen.

Basic principle!
According to the relevant rules, the work of roof waterproofing has to be executed by the roofer.

Wir empfehlen zum Anschluss der Abdichtung an runde Aufsatzkränze das Hochführen mit Flüssigkunststoff.

We recommend using liquid plastic to connect the seal to round curbs.

Transportschutz entfernen

Removal of transport protection

1. Kabelbinder aufschneiden
2. Oberteil anheben
3. Holzbalken entfernen
4. Motor in Motorkonsole einhängen (siehe Montageanleitung im Folgenden)

1. *cut the cable connector*
2. *raise the upper part*
3. *remove the wood truss*
4. *hinge the driver in the motor console (see assembly instruction below)*

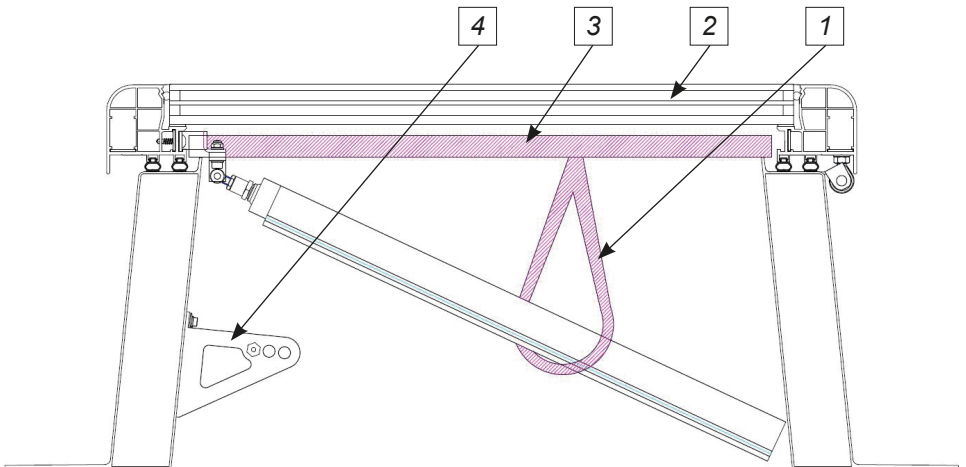

Starr verriegelt - innen

Rigid locked - inside

Einzelteile:
Components:

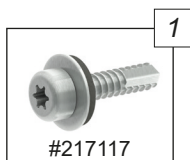

Bohrschraube
JT3-FR-6 5,5x35
drilling screw
JT3-FR-6 5,5x35

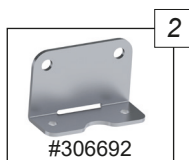

Verriegelungsblech
locking sheet



Blindniet $\varnothing 4,8 \times 16$
blind rivet $\varnothing 4,8 \times 16$

Montage:
Assembly:

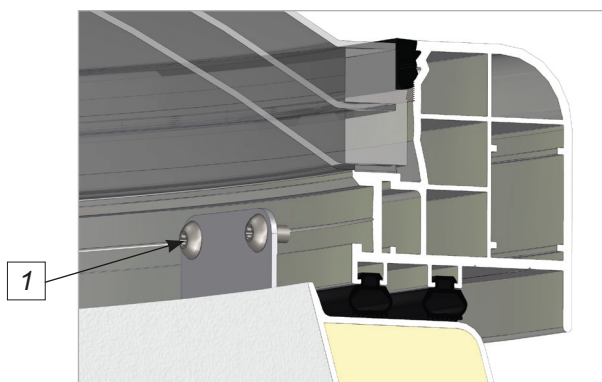
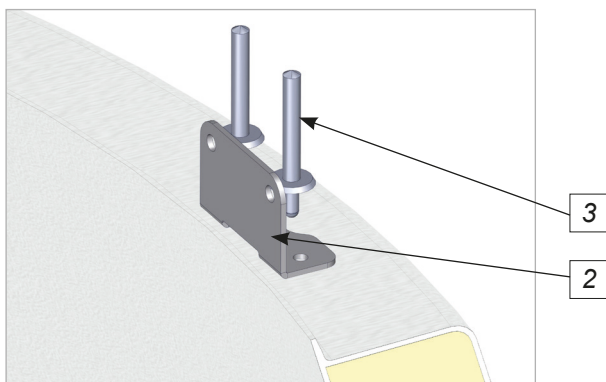

Lüftbar verriegelt - solo

Ventilated locked - solo

Einzelteile:
Components:

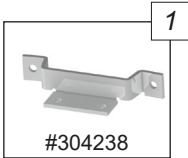

Flügelbockkonsole
wing bent console



Innensechskant-
schraube M6x16
cylinder head screw
M6x16

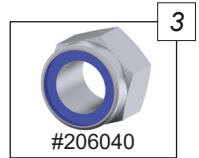

Mutter selbstsichernd
M6
self-locking nut M6

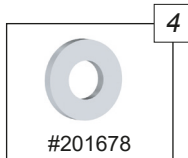

Unterlegscheibe
ø6,4
washer ø6,4

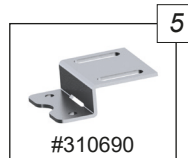

Verriegelungsblech
OKD 60-150
locking sheet
OKD 60-150

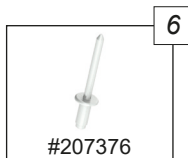

Niete 4,8x16
rivet 4,8x16

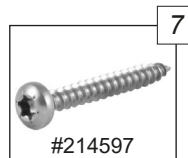

Bohrschraube
5,5x25
drilling screw 5,5x25

Montage:
Assembly:

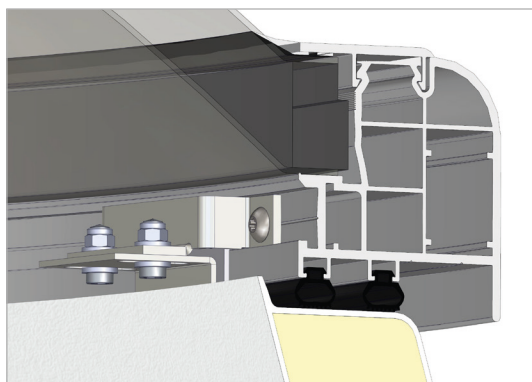
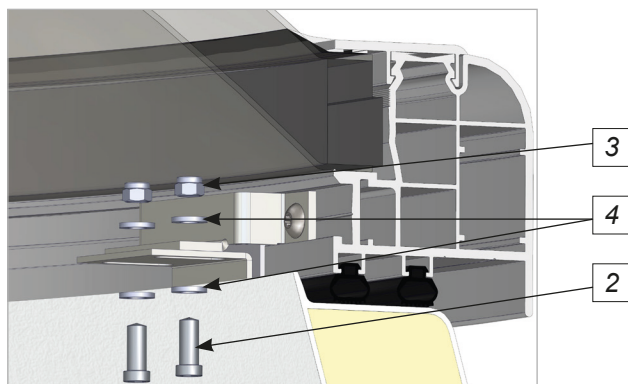
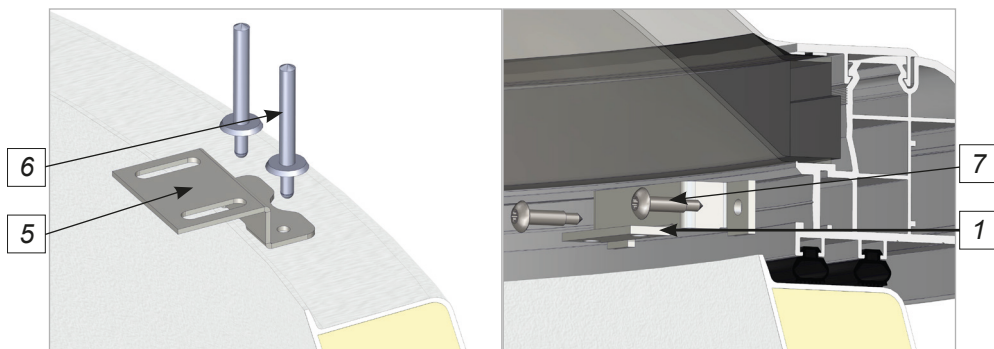

Lüftbar verriegelt - tandem

Ventilated locked - tandem

Einzelteile:
Components:

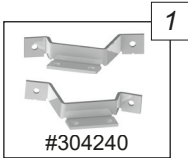

Flügelbockkonsolen-
paar
wing bent console - pair



Innensechskant-
schraube M6x16
cylinder head screw
M6x16

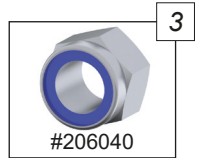

Mutter selbstsichernd
M6
self-locking nut M6

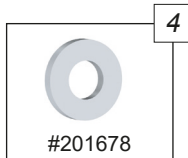

Unterlegscheibe
ø6,4
washer ø6,4

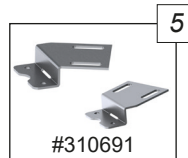

Verriegelungsblech
OKD 180
locking sheet
OKD 180

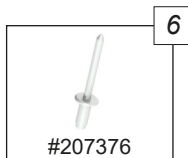

Niete 4,8x16
rivet 4,8x16

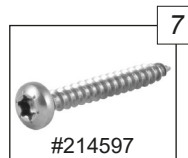

Bohrschraube
5,5x25
drilling screw 5,5x25

Montage:
Assembly:

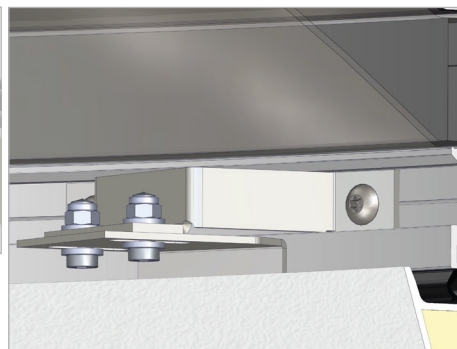
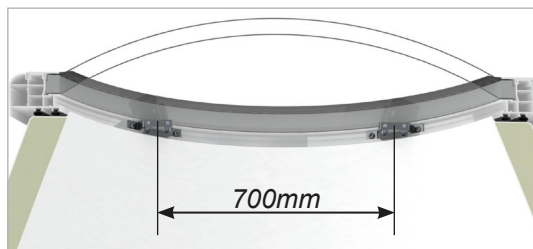
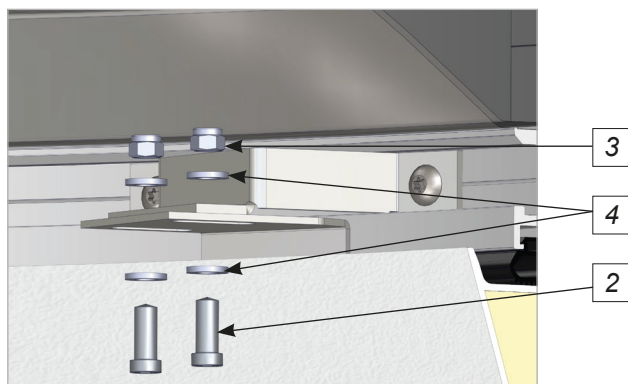
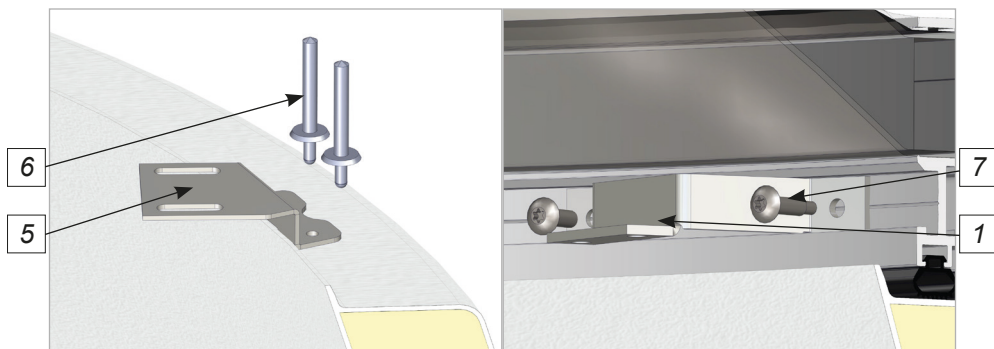

24V/230V Motor solo „Typ JM-DC“

24V/230V drive solo „Type JM-DC“

Einzelteile:
Components:

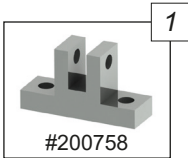

6er Flügelbock
wing bent

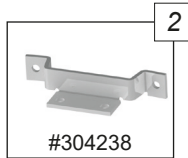

Flügelbockkonsole
wing bent console

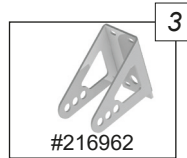

Motorkonsole
motor console

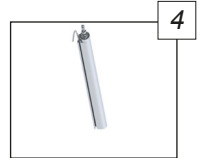

Motor 24V/230V
driver 24V/230V

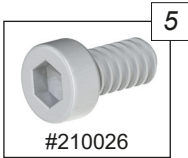

Zylinderschraube
DIN 912 M6x20
cylinder head screw
DIN 912 M6x20

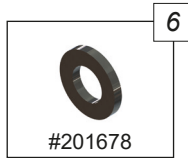

Scheibe
DIN 125 6,4
washer
DIN 125 6,4

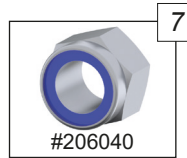

Mutter selbstsichernd
M6
self-locking nut M6

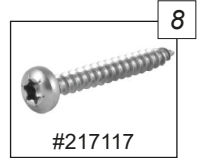

Bohrschraube
5,5x35
drilling screw 5,5x35

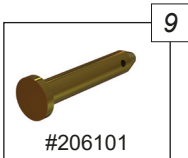

Aufnahmebolzen
locating bolt

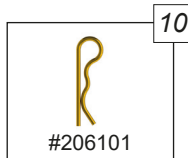

Sicherungssplint
lock splint

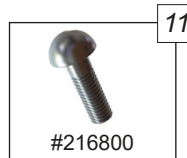

Stiftschraube
JM-DC
stud screw JM-DC

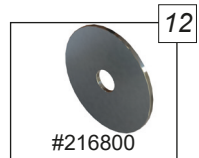

Unterlegscheibe 5,2
washer 5,2

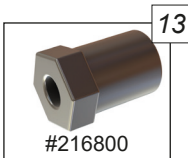

Schraubhülse M5
threaded bush

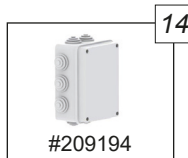

Lüftungsnetzteil
nur bei 230V Version
power pack for ven-
tilation only for 230V
version

Montage:
Assembly:

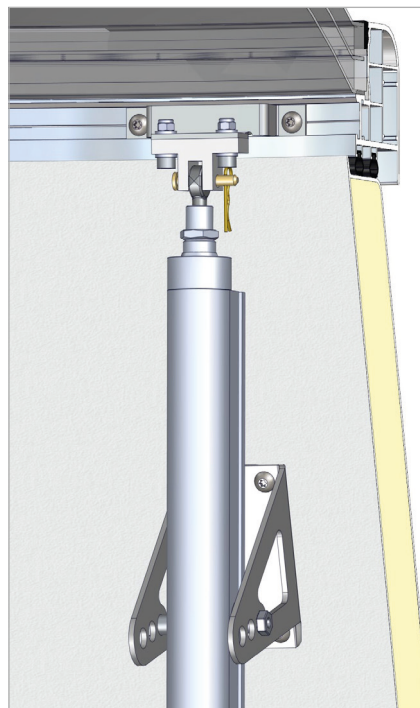
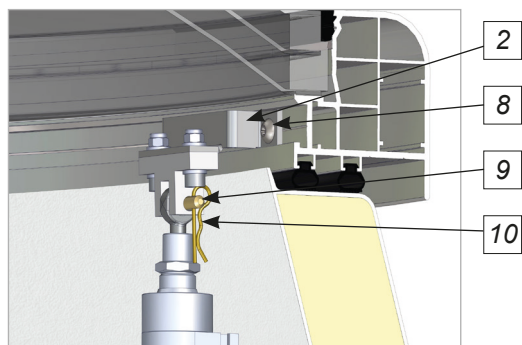
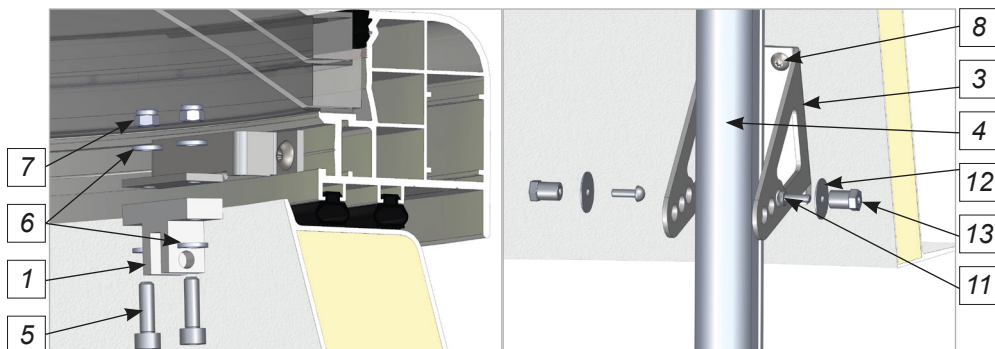

24V/230V Motor tandem „Typ JM-DC“

24V/230V drive tandem „Type JM-DC“

Einzelteile:
Components:

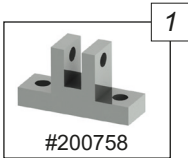

6er Flügelbock
wing bent

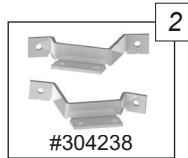

Flügelbockkonsole
wing bent console

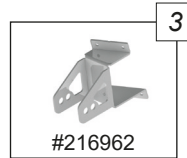

Motorkonsole
motor console

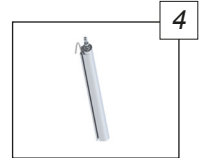

Motor 24V/230V
driver 24V/230V

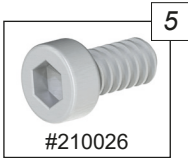

Zylinderschraube
DIN 912 M6x20
cylinder head screw
DIN 912 M6x20

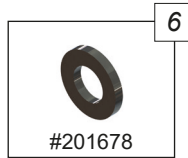

Scheibe
DIN 125 6,4
washer
DIN 125 6,4

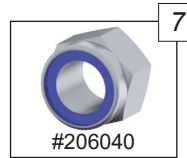

Mutter selbstsichernd
M6
self-locking nut M6

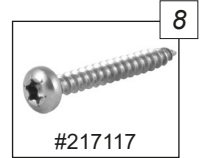

Bohrschraube
5,5x35
drilling screw 5,5x35

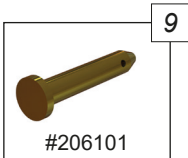

Aufnahmebolzen
locating bolt

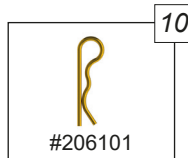

Sicherungssplint
lock splint

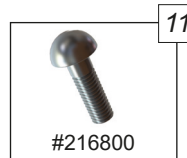

Stiftschraube
JM-DC
stud screw JM-DC



Unterlegscheibe 5,2
washer 5,2

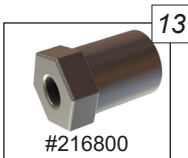

Schraubhülse M5
threaded bush

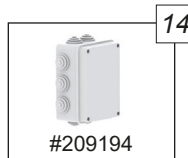

Lüftungsnetzteil
nur bei 230V Version
power pack for ven-
tilation only for 230V
version

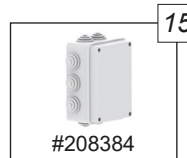

Gleichlaufsteuerung
LA-GL/2
synchronous-speed
control LA-GL/2

Montage:
Assembly:

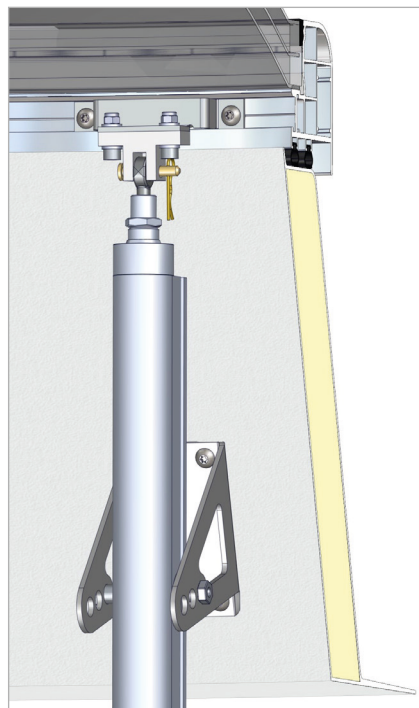
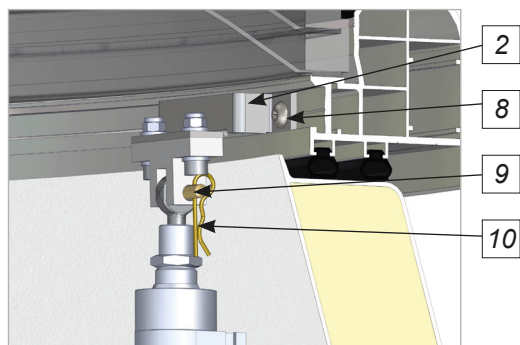

230V Motor „Typ SP8“ 230V drive solo „Type SP8“

Einzelteile:
Components:

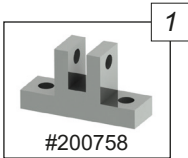

6er Flügelbock
wing bent

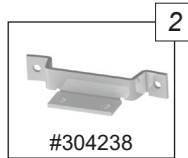

Flügelbockkonsole
wing bent console

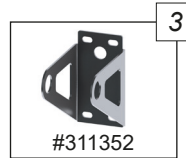

Motorkonsole
motor console

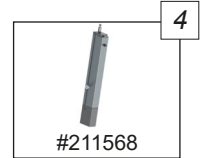

Motor 230V
drive 230V

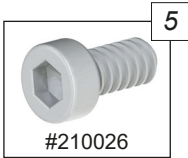

Zylinderschraube
DIN 912 M6x20
cylinder head screw
DIN 912 M6x20

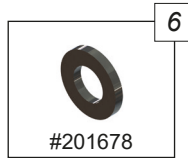

Scheibe
DIN 125 6,4
washer
DIN 125 6,4

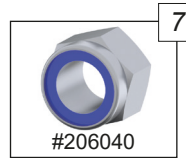

Mutter selbstsichernd
M6
self-locking nut M6

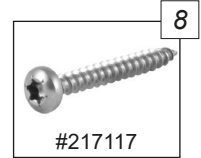

Bohrschraube
5,5x35
drilling screw 5,5x35

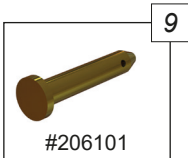

Aufnahmebolzen
locating bolt

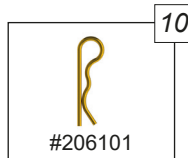

Sicherungssplint
lock splint

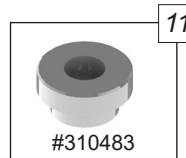

Buchse \varnothing 25mm
liner \varnothing 25mm

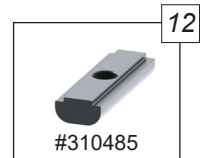

Mutter für T-Nut
nut for T furrow

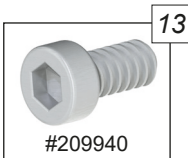

Zylinderschraube
DIN 912 M6x12
cylinder head screw
DIN 912 M6x12

Montage:
Assembly:

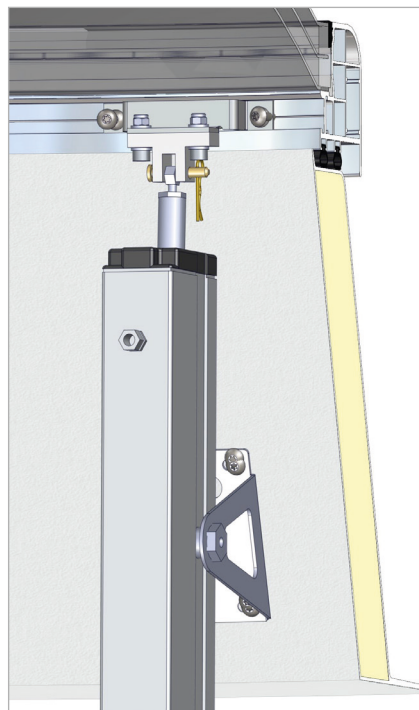
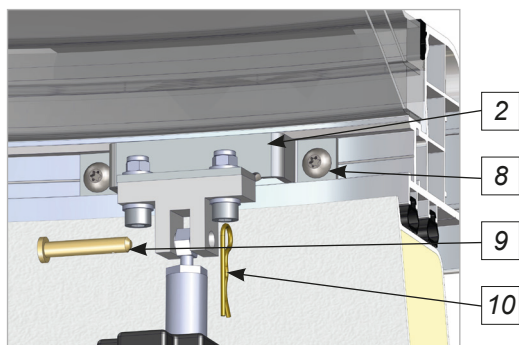
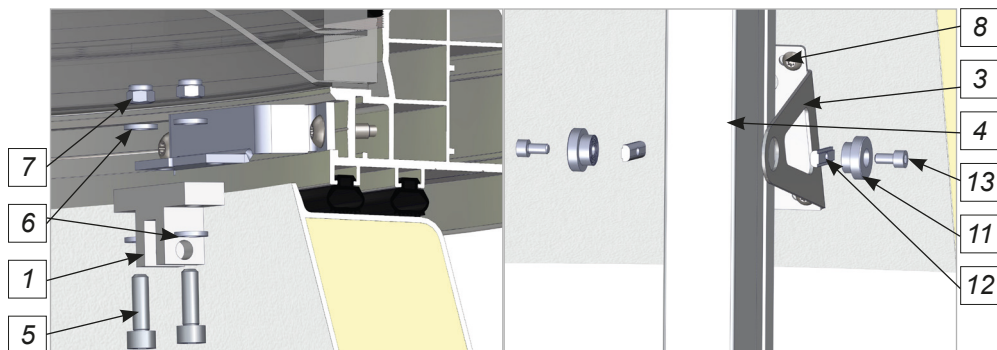

Anschlusspläne Elektromotoren

Wiring diagrams of electric drives

Lüftung elektrisch 24V/230V

Ventilation electric 24V/230V

Technische Daten technical details	Jo65	Jo100
Antriebstyp driving force	Spindelhubantrieb spindle drive	
Versorgung maintenance	24V DC, +4/-2V	
Bemessungsstrom rated current	0,8A / 19,2W	
Nennkraft nominal force	650N	1000N
Laufzeit run-time	ca. 375mm/min	ca. 200mm/min
Gehäuse case	Aluminium aluminium	
Schutzart safety class	IP65	
Lastabschaltung load breaking	integriert integrated	
Kabellänge cable length	1,7m - 2,4m	

Solo / Tandem 24V

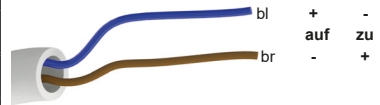

Um einen störungsfreien Betrieb zu gewährleisten müssen die Antriebe über eine externe Gleichaufreglung synchronisiert werden!

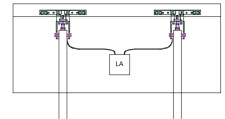

Solo / Tandem 24V



To ensure a smooth operation, the drives need to be synchronised via an external synchronisation control!

Lüftung elektrisch 230V

Ventilation electric 230V

Technische Daten technical details	SP8
Antriebstyp driving force	Spindelhubantrieb spindle drive
Versorgung maintenance	230V AC, 0,2A
Nennkraft nominal force	800N
Laufzeit run-time	ca. 420 mm/min
Gehäuse case	Aluminium aluminium
Schutzart safety class	IP54
Lastabschaltung load breaking	integriert integrated
Kabellänge cable length	1m

Solo 230V

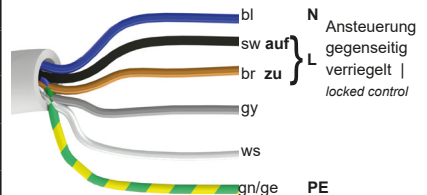

Notizen
Notes

Kontakte

Contacts

Abteilung Lichtkuppel | Flachdach Fenster
Department Rooflight | Glass Skylight



Heiko Sachs
Telefon | *Phone*: +49 9283 595-1677
E-Mail: Heiko.Sachs@lamilux.de



Ingo Michel
Telefon | *Phone*: +49 9283 595-222
E-Mail: Ingo.Michel@lamilux.de

Abteilung Steuerungstechnik | Gebäudesteuerung
Department Control Technology | Building Automation



Fabian Sachs
Telefon | *Phone*: +49 9283 595-1648
E-Mail: Fabian.Sachs@lamilux.de



Lukas Hoffmann
Telefon | *Phone*: +49 9283 595-228
E-Mail: Lukas.Hoffmann@lamilux.de



Hier scannen und mehr zu
LAMILUX Tageslichtsystemen erfahren!



LICHTKUPPEL F100



FLACHDACH FENSTER F100



FLACHDACH FENSTER FE



GLASARCHITEKTUR



SANIERUNG



MIROTEC STAHLKONSTRUKTIONEN



LICHTBAND B



LICHTBAND S



LICHTBAND W|R



RAUCH- UND
WÄRMEABZUGSANLAGEN



GEBÄUDESTEUERUNGEN



RODA LICHT-
UND LÜFTTECHNIK

Die in diesem Prospekt aufgeführten technischen Daten entsprechen dem aktuellen Stand bei Drucklegung und können sich ändern. Unsere technischen Angaben beziehen sich auf Berechnungen, Lieferantangaben oder wurden im Rahmen einer Prüfung von einem unabhängigen Prüfinstitut nach den jeweils gültigen Normen ermittelt. Die Berechnung der Wärmedurchgangskoeffizienten für unsere Kunststoffverglasungen erfolgte nach der „Methode der finiten Elemente“ mit Referenzwerten nach DIN EN 673 für Isoliergläser. Dabei wurde – der Praxis und den spezifischen Kunststoff-Merkmalen Rechnung tragend – die Temperaturdifferenz 15 K zwischen den Materialaußenflächen definiert. Die Funktionswerte beziehen sich nur auf Prüfstücke in den für die Prüfung vorgesehenen Abmessungen. Eine weitergehende Garantie für technische Werte wird nicht übernommen. Dies gilt insbesondere für veränderte Einbausituationen oder wenn Nachmessungen am Bau erfolgen.



LAMILUX Heinrich Strunz GmbH

Zehstraße 2 · Postfach 1540 · 95111 Rehau · Tel.: +49 (0) 92 83 / 5 95-0 · Fax +49 (0) 92 83 / 5 95-29 0

E-Mail: information@lamilux.de · www.lamilux.de

