



Überfahrbar / Traversable

ABS-Lock[®] SYS IV 6 mm



MoA 208-04



Werkzeuge | Tools

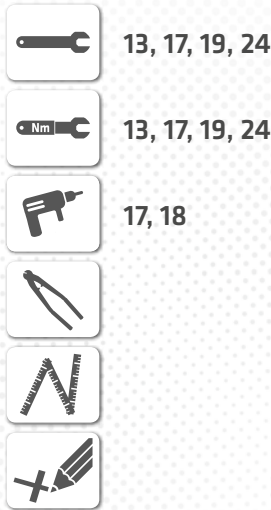

Sicherheitshinweise | Safety instructions



- DE** Die Anweisungen der Montageanleitung (1) und Sicherheitshinweise (2) sind strikt einzuhalten.
- EN** The information contained in the assembly instructions (1) and safety instructions (2) must be strictly observed.
- NL** De aanwijzingen in de montagehandleiding (1) en de veiligheidsvoorschriften (2) moeten strikt worden nageleefd.
- ES** Respete estrictamente las instrucciones del manual de montaje (1) y las indicaciones de seguridad (2).
- IT** È assolutamente necessario attenersi alle istruzioni di montaggio (1) e alle norme di sicurezza (2).
- FR** Les instructions de la notice de montage (1) et les consignes de sécurité (2) doivent être formellement respectées.
- PL** Należy ściśle przestrzegać instrukcji montażu (1) i wskazań bezpieczeństwa (2).
- DK** Montagevejledningens (1) anvisninger som også sikkerhedshenvisningerne (2) skal overholdes.
- CZ** Je nutné striktně dodržovat instrukce obsažené v montážním návodu (1) a v bezpečnostních pokynech (2).
- GR** Πρέπει να τηρούνται αυστηρά οι οδηγίες του χειριδίου συναρμολόγησης (1) και των υποδείξεων ασφαλείας (2).
- SK** Dôsledne dodržiavajte pokyny montážneho návodu (1) a bezpečnostné pokyny (2).
- TR** Montaj kılavuzunun (1) ve güvenliik uyarılarının talimatlarına (2) kesinlikle uyulmalıdır.
- NO** Det er svært viktig at instruksjonene i monteringshåndboken (1) og sikkerhetsheftet (2) følges.
- RUS** Необходимо строго соблюдать требования руководства по монтажу (1) и инструкции по безопасности (2).
- RO** Indicațiile din instrucțiunile de montare (1) și din broșura cu indicații de siguranță (2) trebuie respectate cu strictețe.
- FI** Asennusohjeen (1) ja turvaohjevhikosen (2) ohjeita on ehdottomasti noudatettava.
- SE** Anvisningarna till monteringsanvisningen (1) och säkerhetsmanualen (2) måste iakttas under alla omständigheter.
- HI** इंस्ट्रक्शन के निर्देशों (1) और सुरक्षा निर्देश मैनुअल (2) में दिये गये निर्देशों का सख्ती से अनुसरण किया जाना चाहिए।
- ZH** 必须严格遵守装配说明书 (1) 和安全须知单 (2) 中的指示。
- SQ** Jëpb alntzãm baltelimebt wawwde fë dëfil tkrëb (1) wkëtb aršadat sllame (2) bmtëti dëqë.

Kontakte | Contact persons

Vertrieb & Technische Beratung
Sales & Technical Support
+49 (0) 28 32 - 972 81 - 0
vertrieb@absturzicherung.de

Schulung
Training
+49 (0) 28 32 - 972 81 - 254
schulung@absturzicherung.de

Montagevorbereitung
Assembly
+49 (0) 28 32 - 972 81 - 260
service@absturzicherung.de

Mustertypenschild | Sample label

[ABS]

ABS SAFETY GMBH 3

Kevelaer, Germany
info@absturzicherung.de
www.absturzicherung.de

Mustertypenschild /
Sample only

Chargennummer /
Batch number

6	Normen / Standards	-
7	Max. Nutzer gleichzeitig (DIN EN 795:2012) Max. No. of simultaneous users	-
11	Modellnummer / Model number	-
-	-	-
-	-	-
-	-	-

8	CE
9	[ABS] Z-14.9-668
10	DEKRA

Inhalt | Content



06

ABS Systemschild /
ABS specification plate



07

ABS SP



08

ABS TI-Bracket



10

**Befestigung für Fassaden-
kurven / Attachment for
facade corners**



12

**Universeller Befestigungswinkel / Universal
attachment bracket**



14

ABS TI-FlexCurve



16

**ABS Gabelkopf
(lose) / ABS clevis (loose)**



18

**ABS Gabelkopf
(eingepresst) / ABS clevis
(swaged)**



19

ABS ForceLimiter



20

**ABS Spannelement / ABS
tensioning element**



24

ABS CompactForce

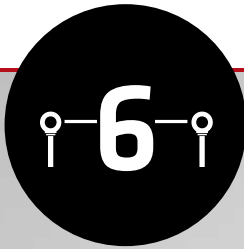

6

ABS TI-FlexCurve
Seite / Page 14



ABS TI-FlexCurve
Seite / Page 14

ABS Systemschild /
ABS specification plate
Seite / Page 06



ABS Gabelkopf (eingepresst) /
ABS clevis (swaged)
Seite / Page 18



ABS TI-Bracket
Seite / Page 08

ABS SP
Seite / Page 07



max.
10
m

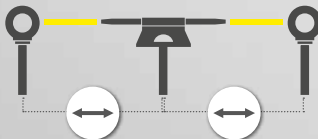



ABS TI-Bracket
Seite / Page 08



ABS TI-FlexCurve
Seite / Page 14



ABS ForceLimiter
Seite / Page 19



ABS CompactForce
Seite / Page 24

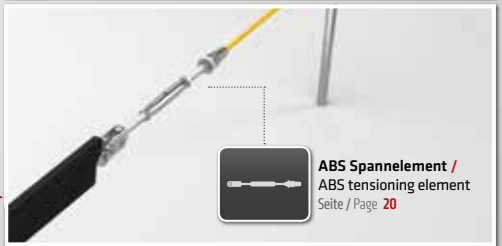

**ABS Spannelement /
ABS tensioning element**
Seite / Page 20









10 | Befestigung für Fassadenkurven / Attachment for facade corners

SV-1016-FA

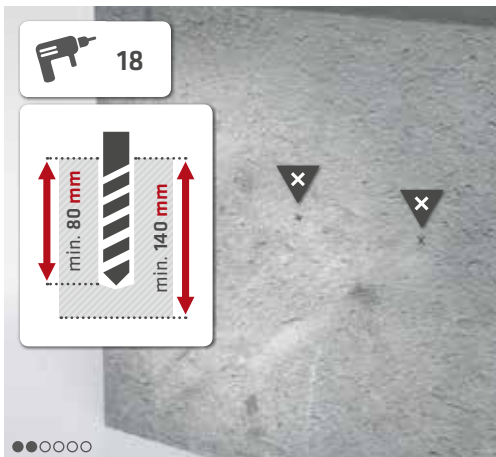
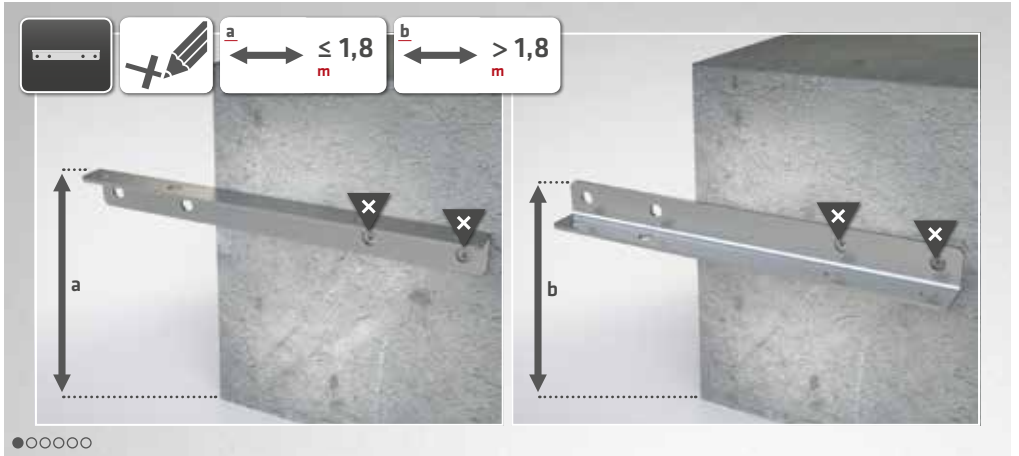
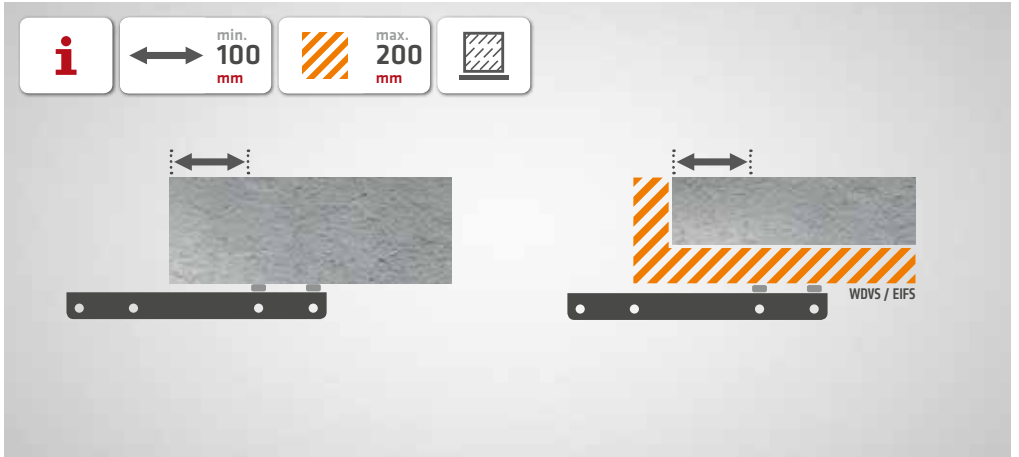



12 | Universeller Befestigungswinkel / Universal attachment bracket

L3-WINK-60-1X17

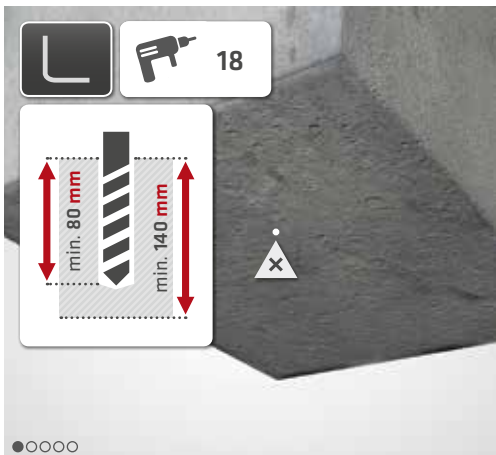

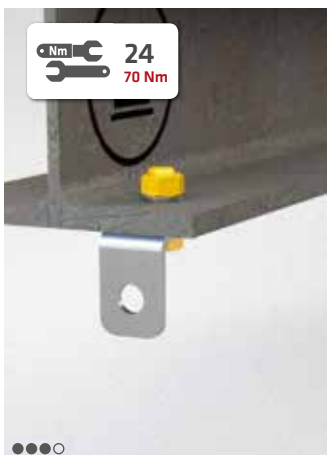
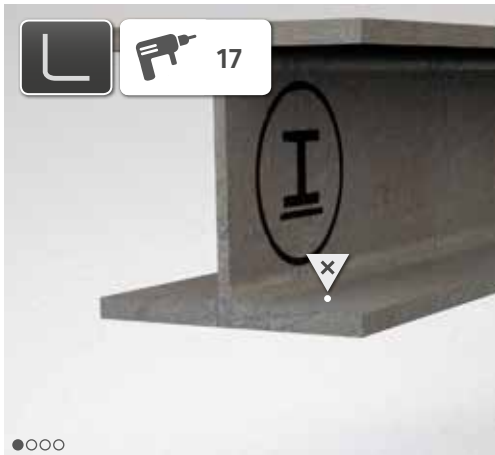
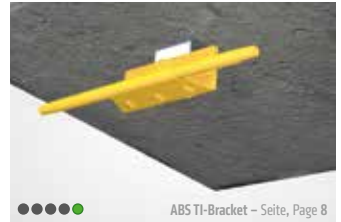
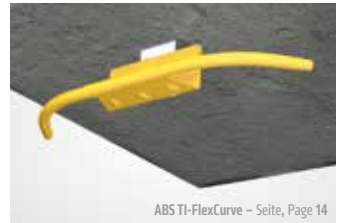



Biegen per Hand nur in Richtung der Schlitz

Bend by hand only in direction of the slots

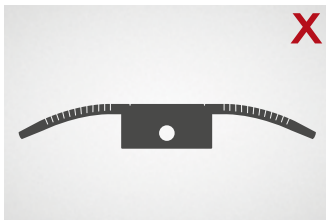
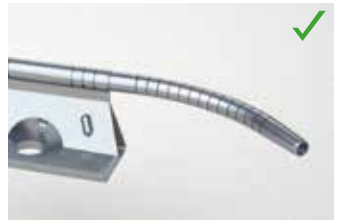
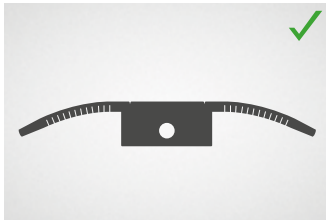



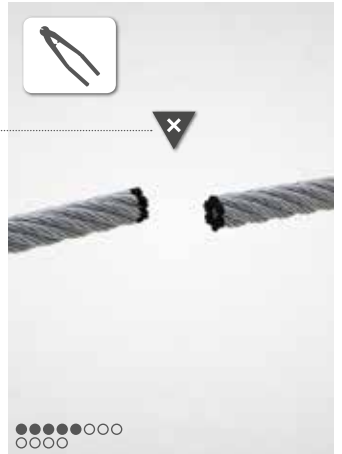
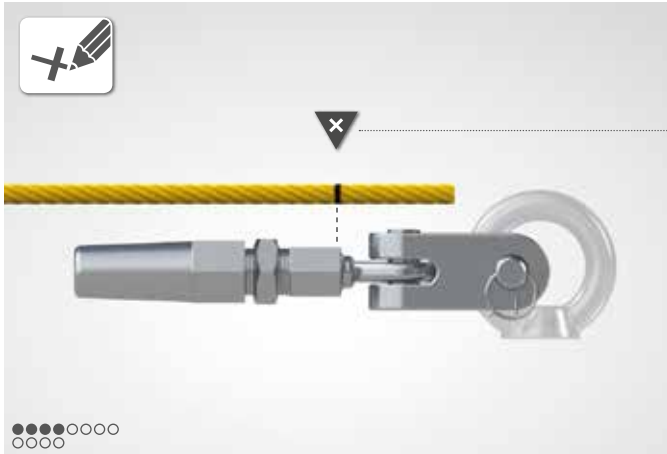

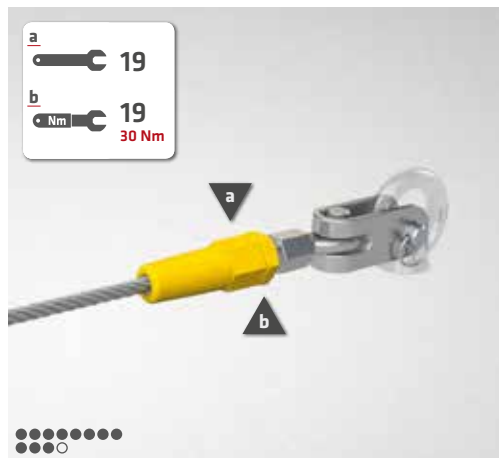
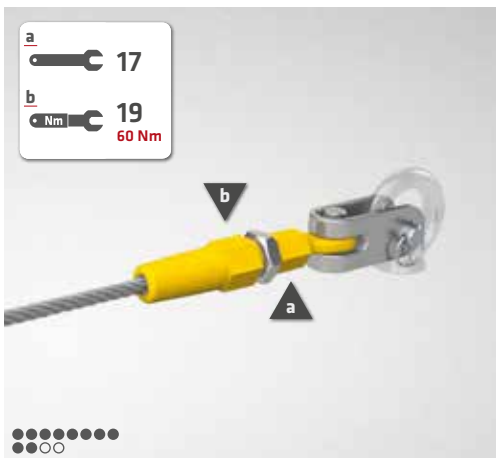
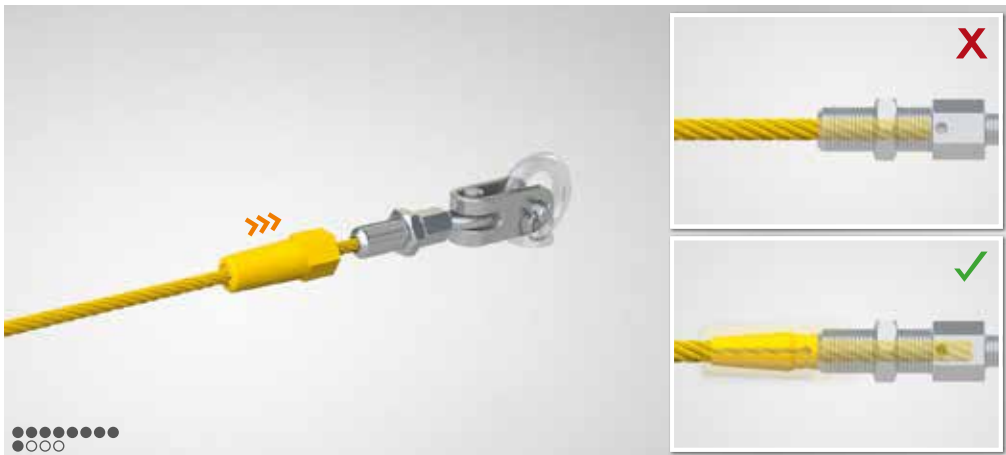





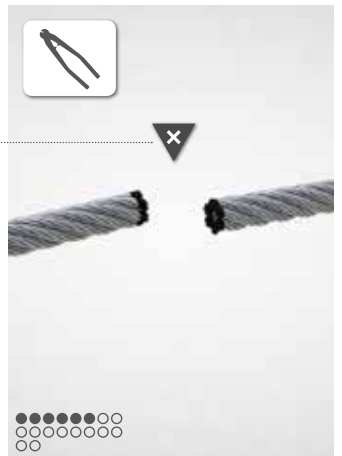
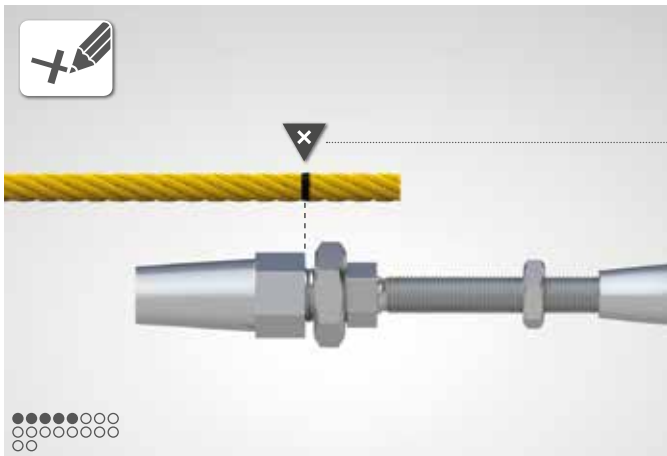
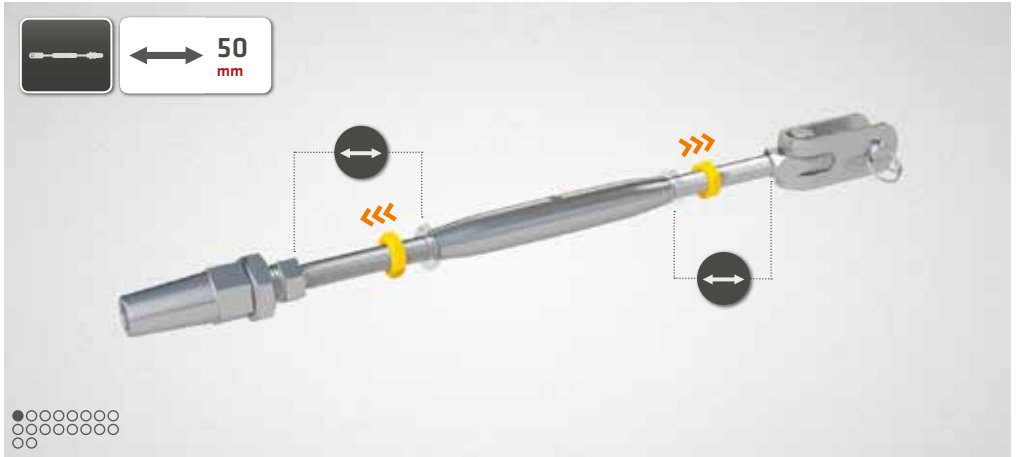

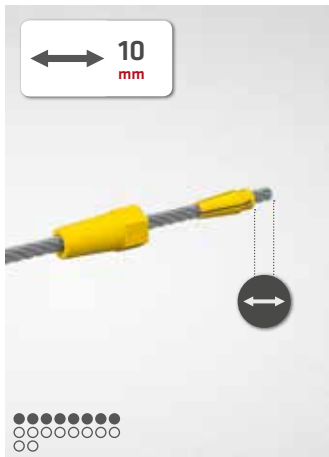



a
 17

b
 19
 60 Nm



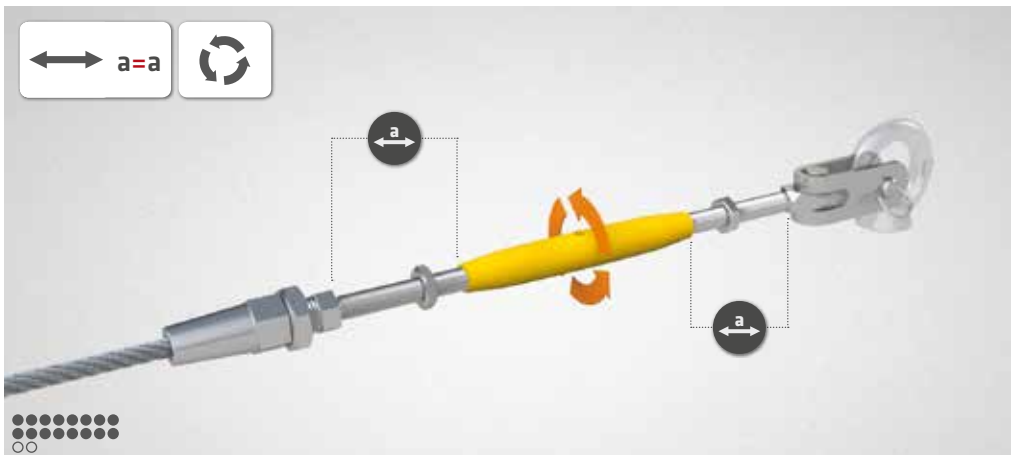

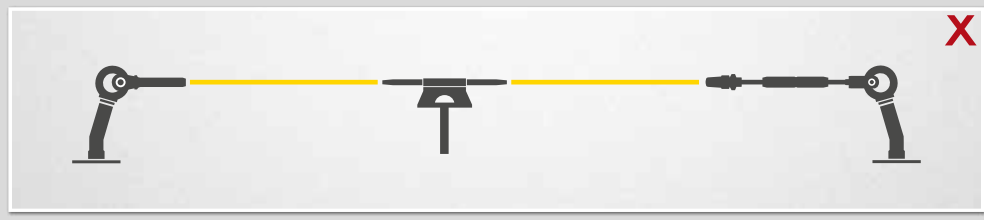
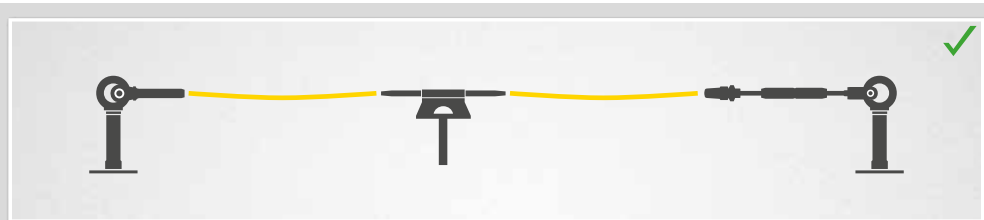
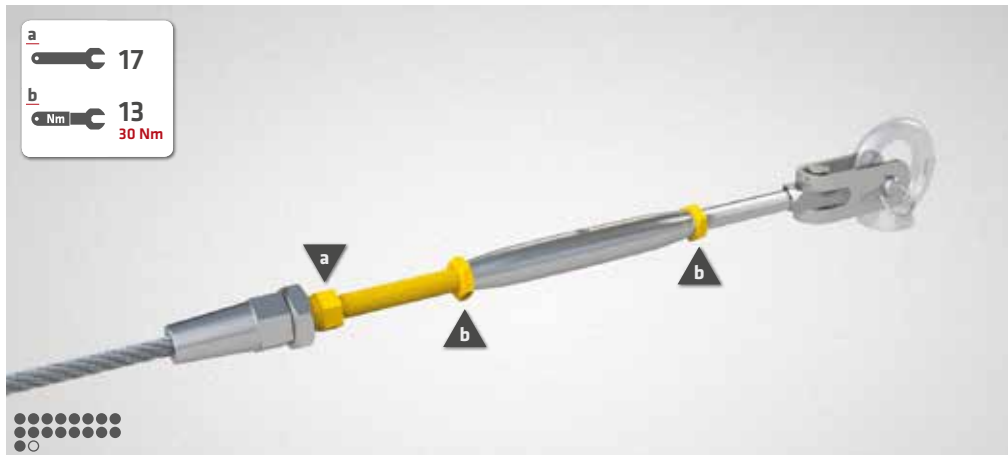

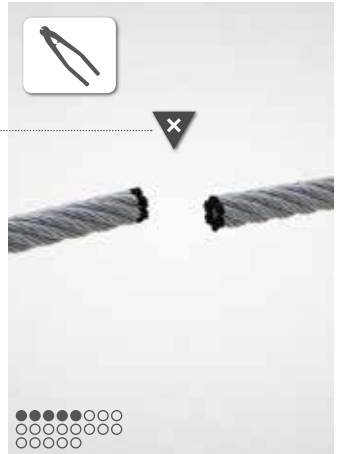
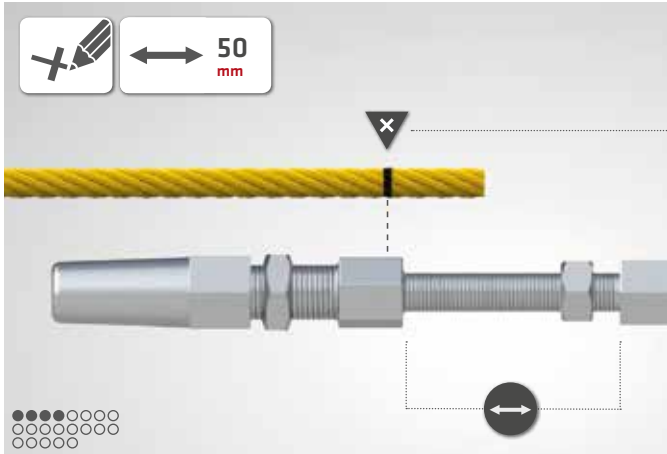

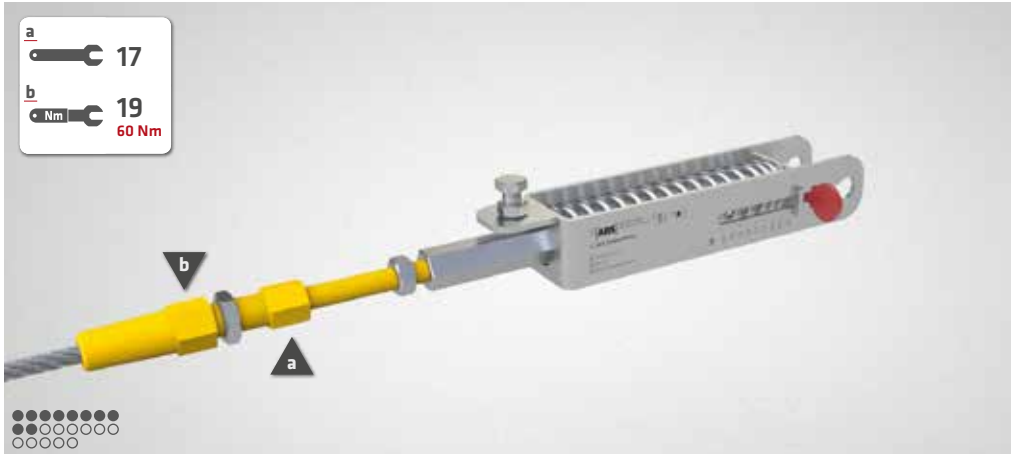
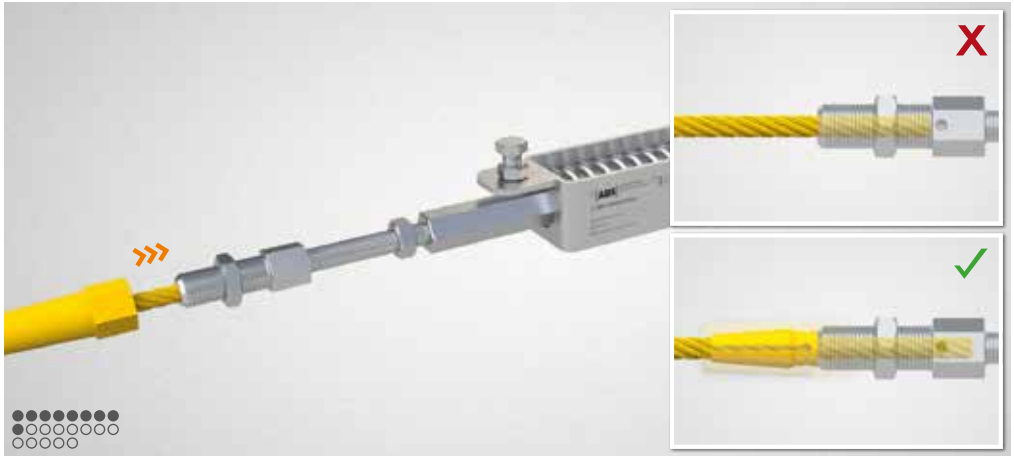

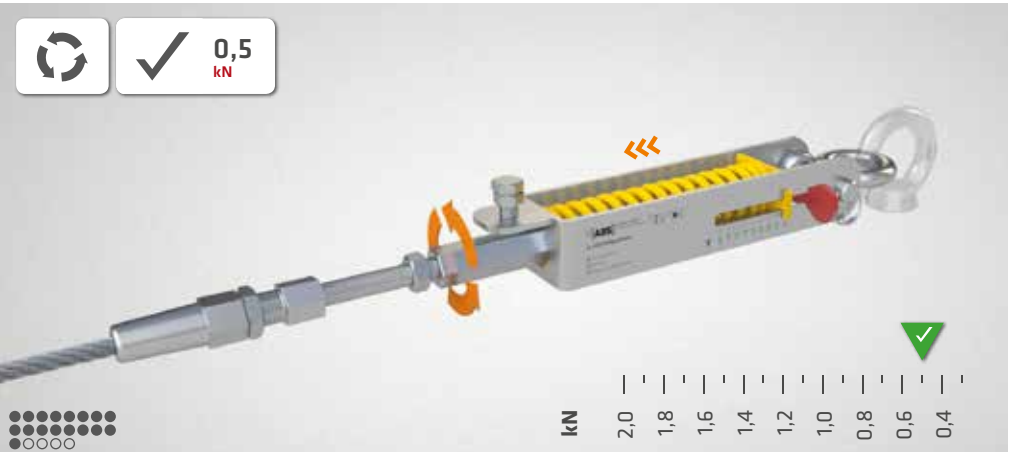
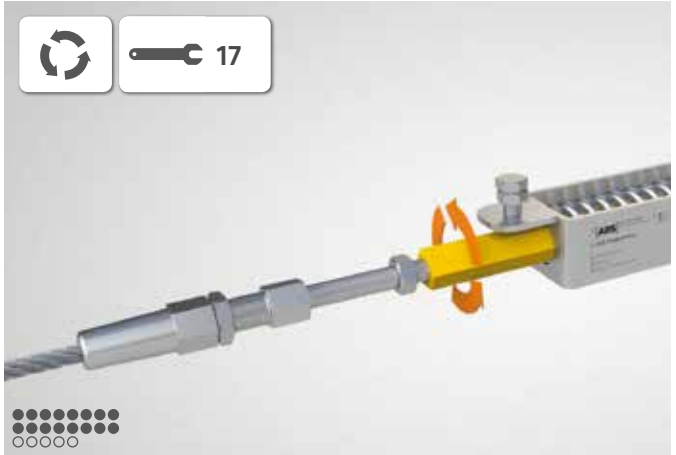



- a 17
- b 17
 30 Nm

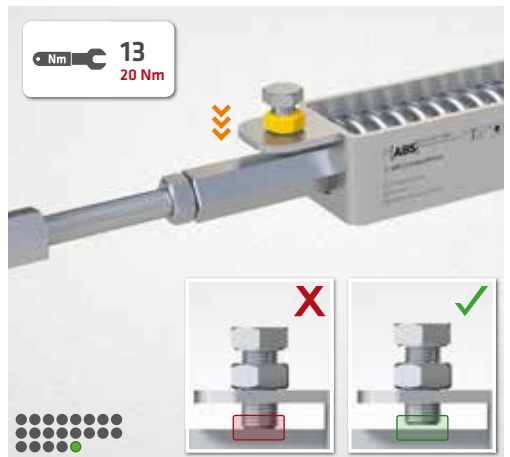
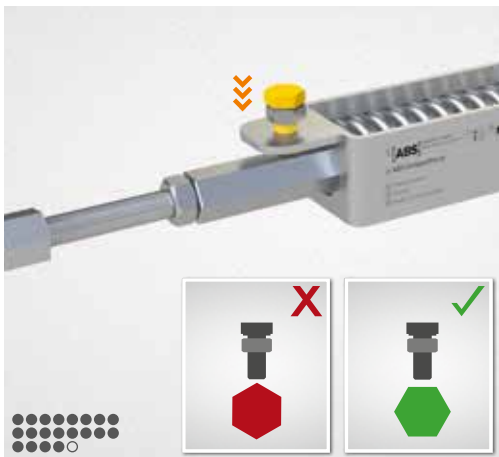

ALWAYS ON TOP!

ABS Safety GmbH

Gewerbering 3
D-47623 Kevelaer
Germany

Tel.: +49 (0) 28 32 - 972 81 - 0
Fax: +49 (0) 28 32 - 972 81 - 29

info@absturzsicherung.de

www.absturzsicherung.de
www.protection-anti-chute.fr
www.fall-arrest.eu

KW 7. März 2017



youtube.com/abssafetygmbh



facebook.com/ABS.Safety