

ABS-Lock[®] DH06

DH06



MoA 214-04



DIN EN 517
TYP B



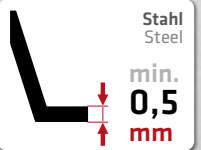
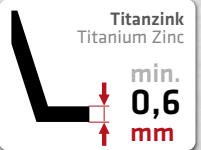

Montageschritte dokumentieren

Document assembly step



Dokumentation ist Pflicht!
Documentation is compulsory!

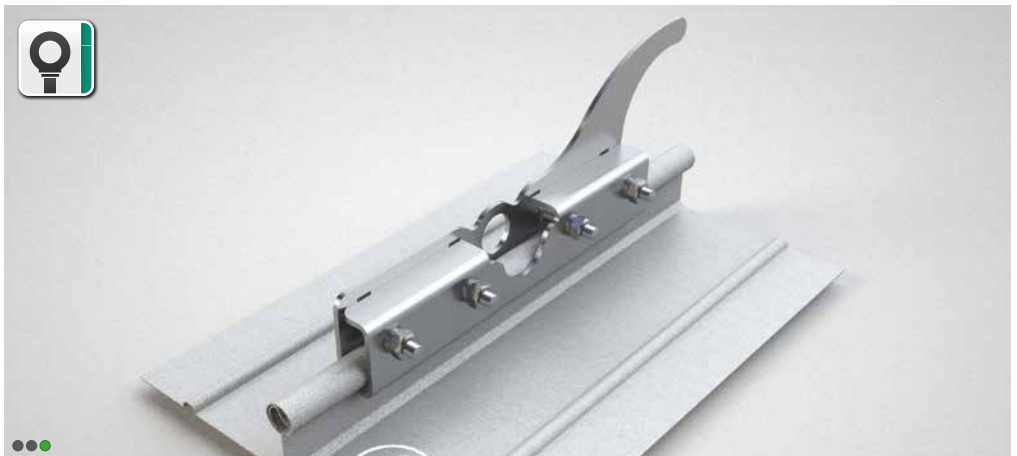
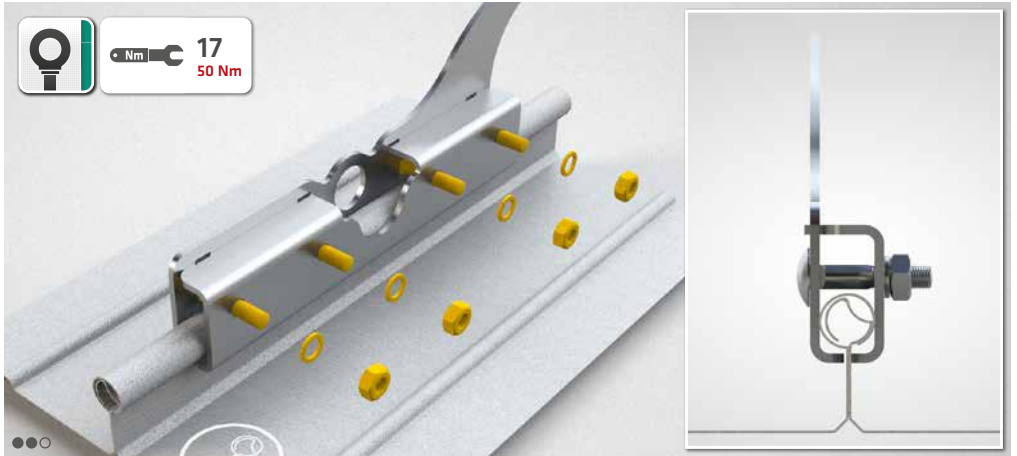
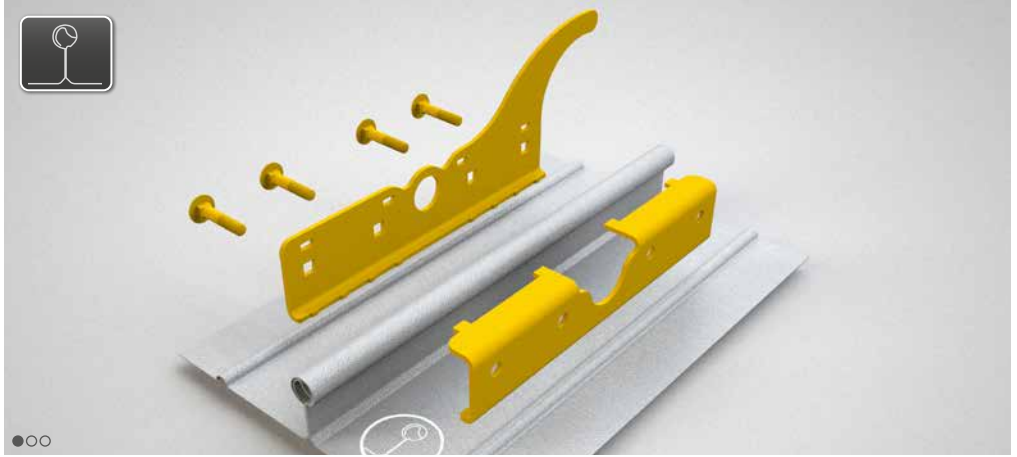

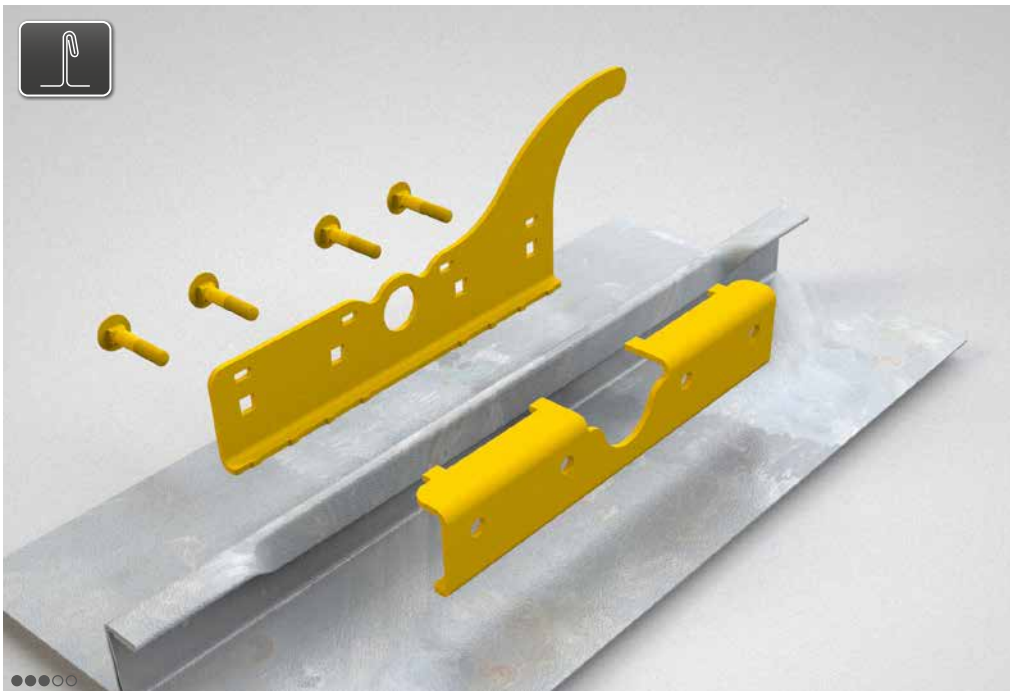
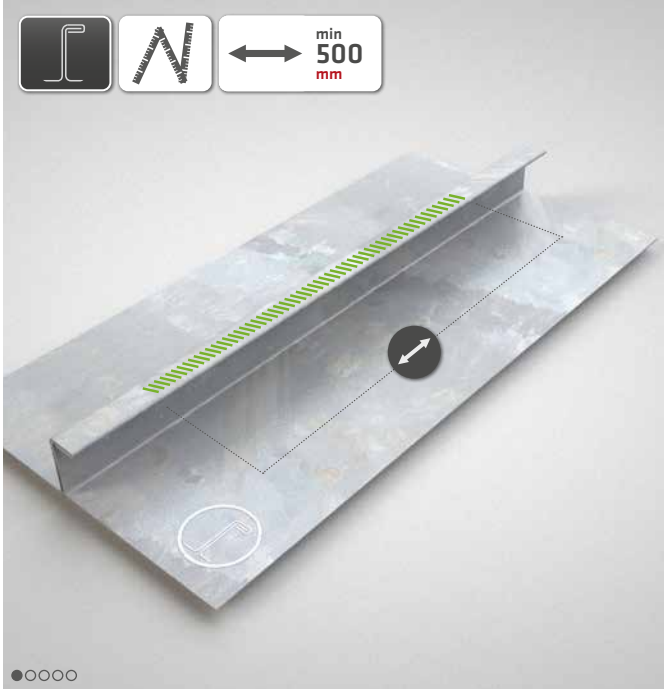



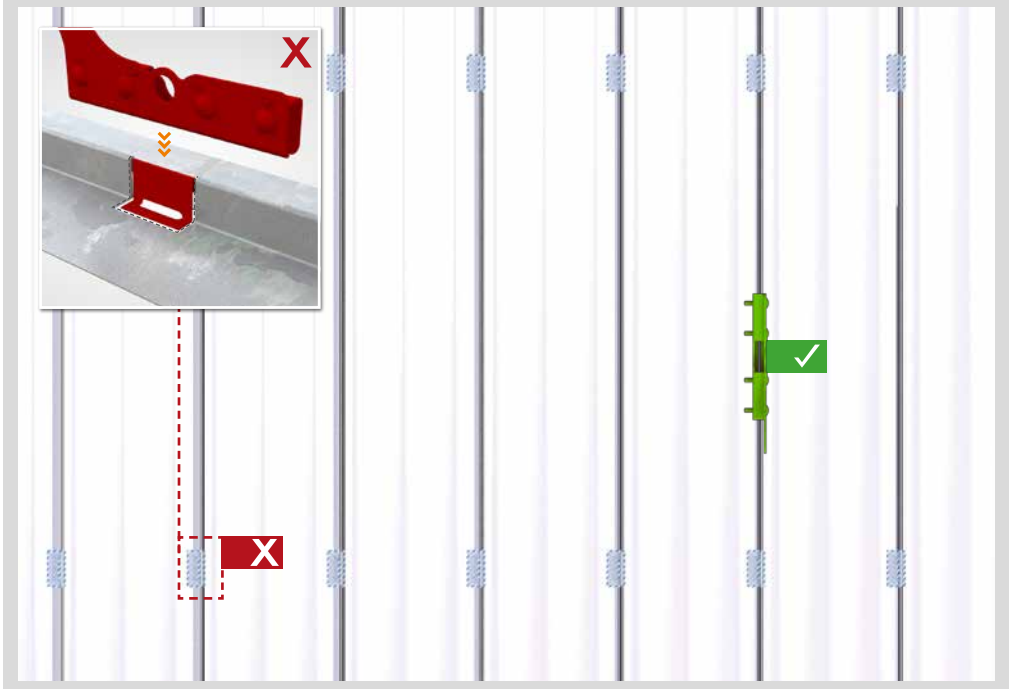
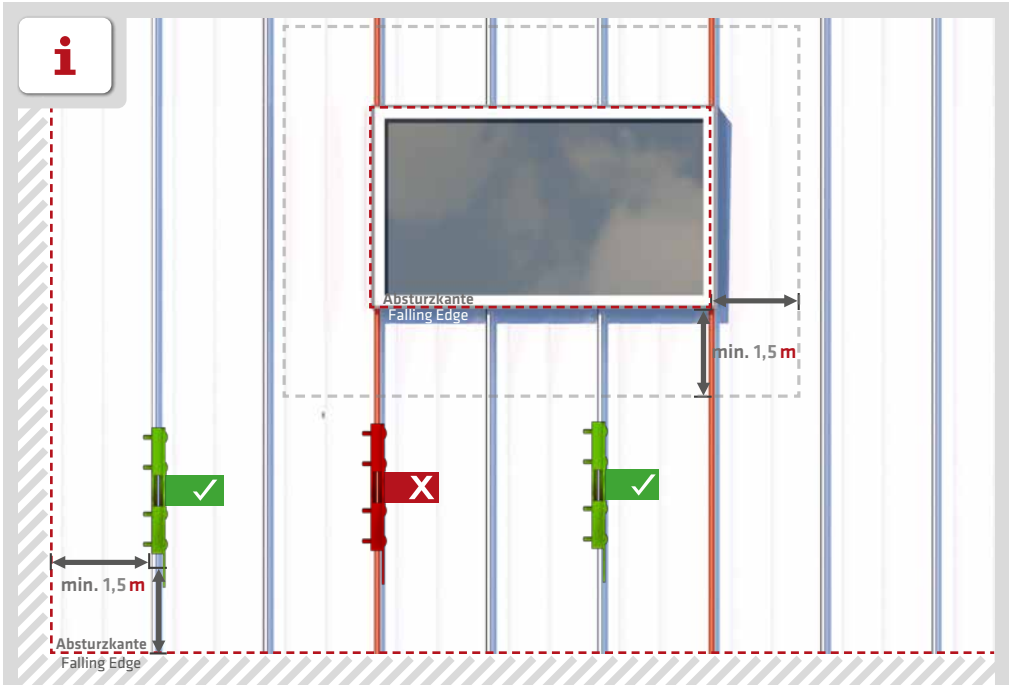

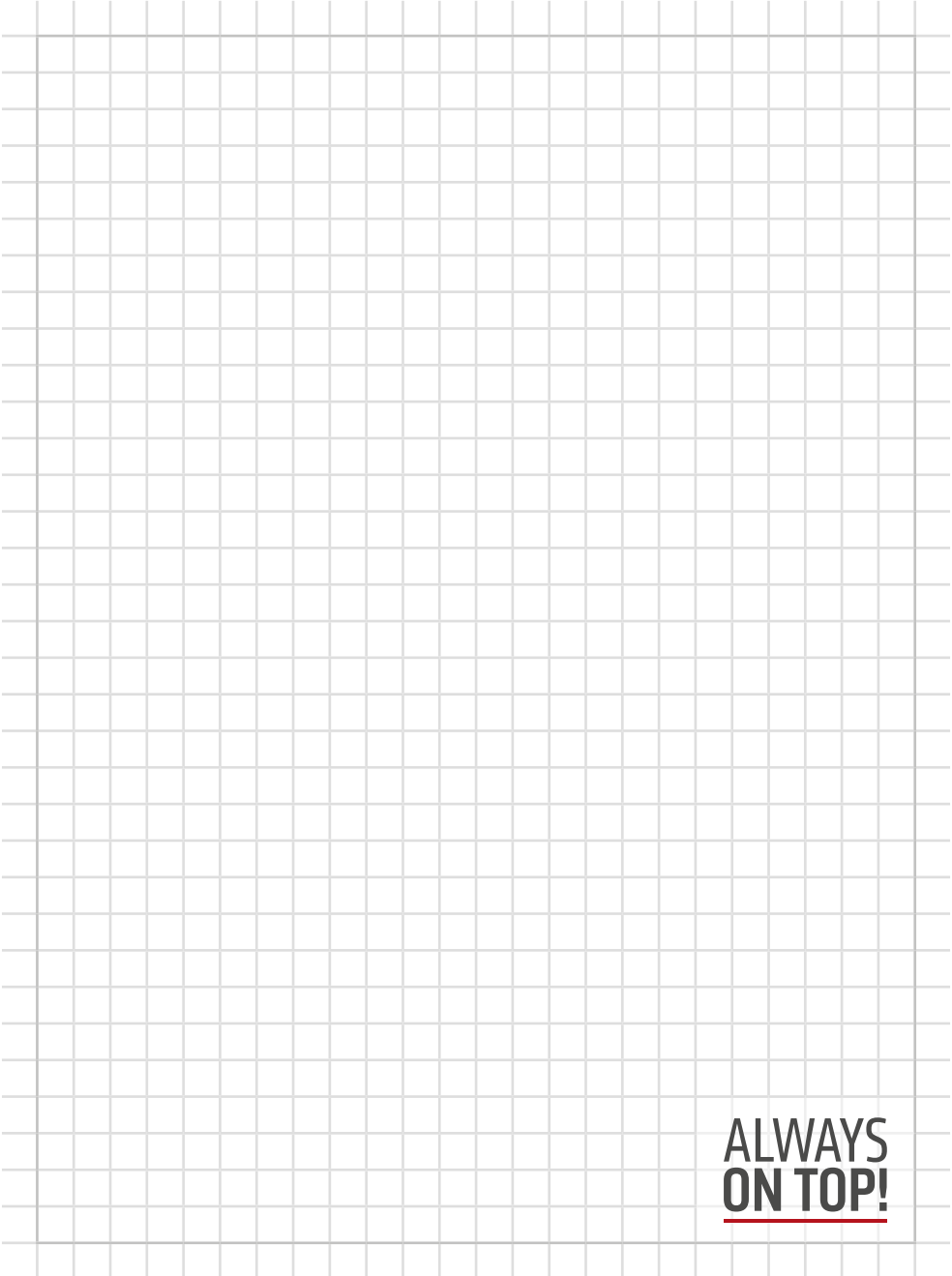

**ALWAYS
ON TOP!**

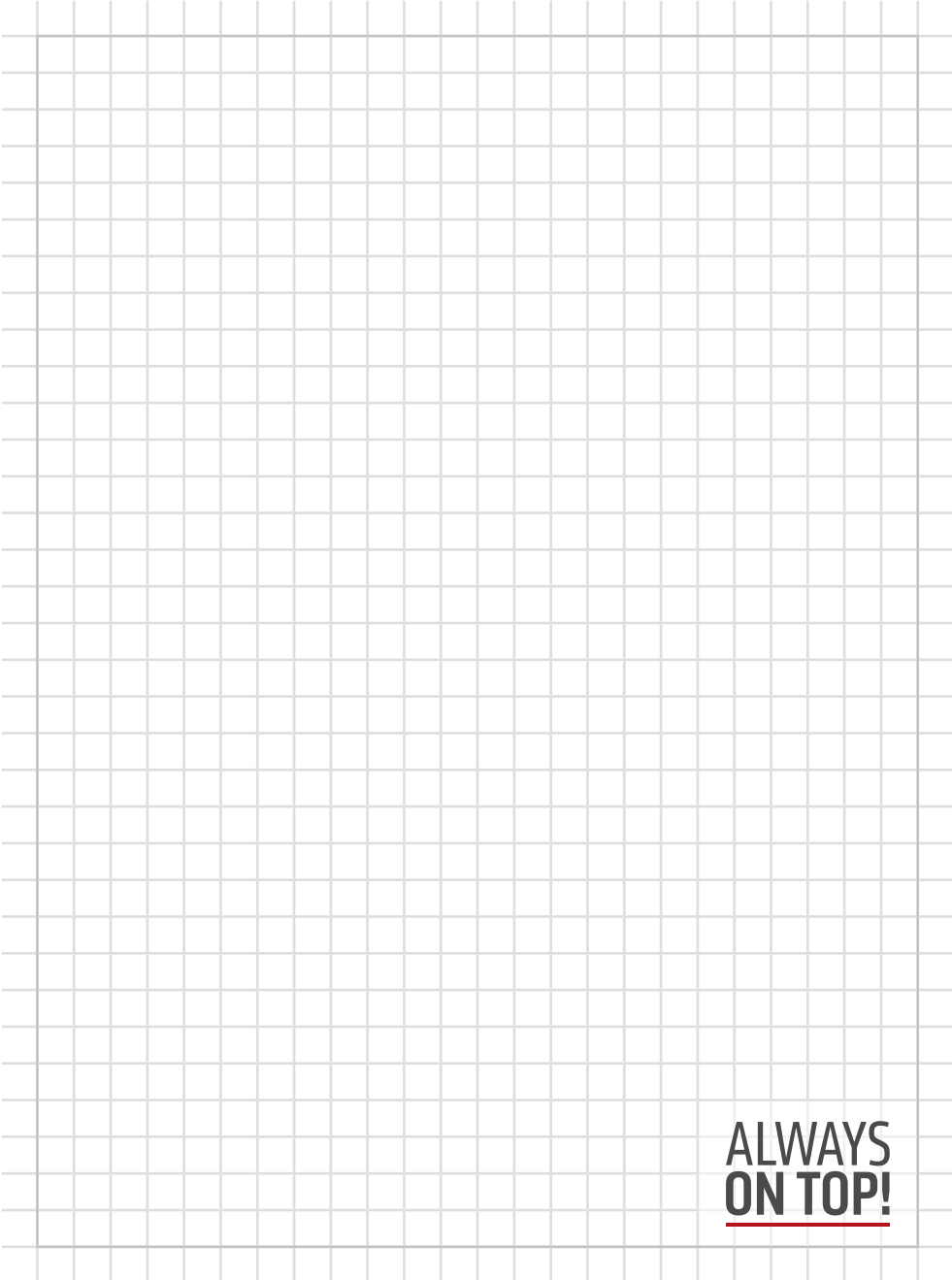

**ALWAYS
ON TOP!**

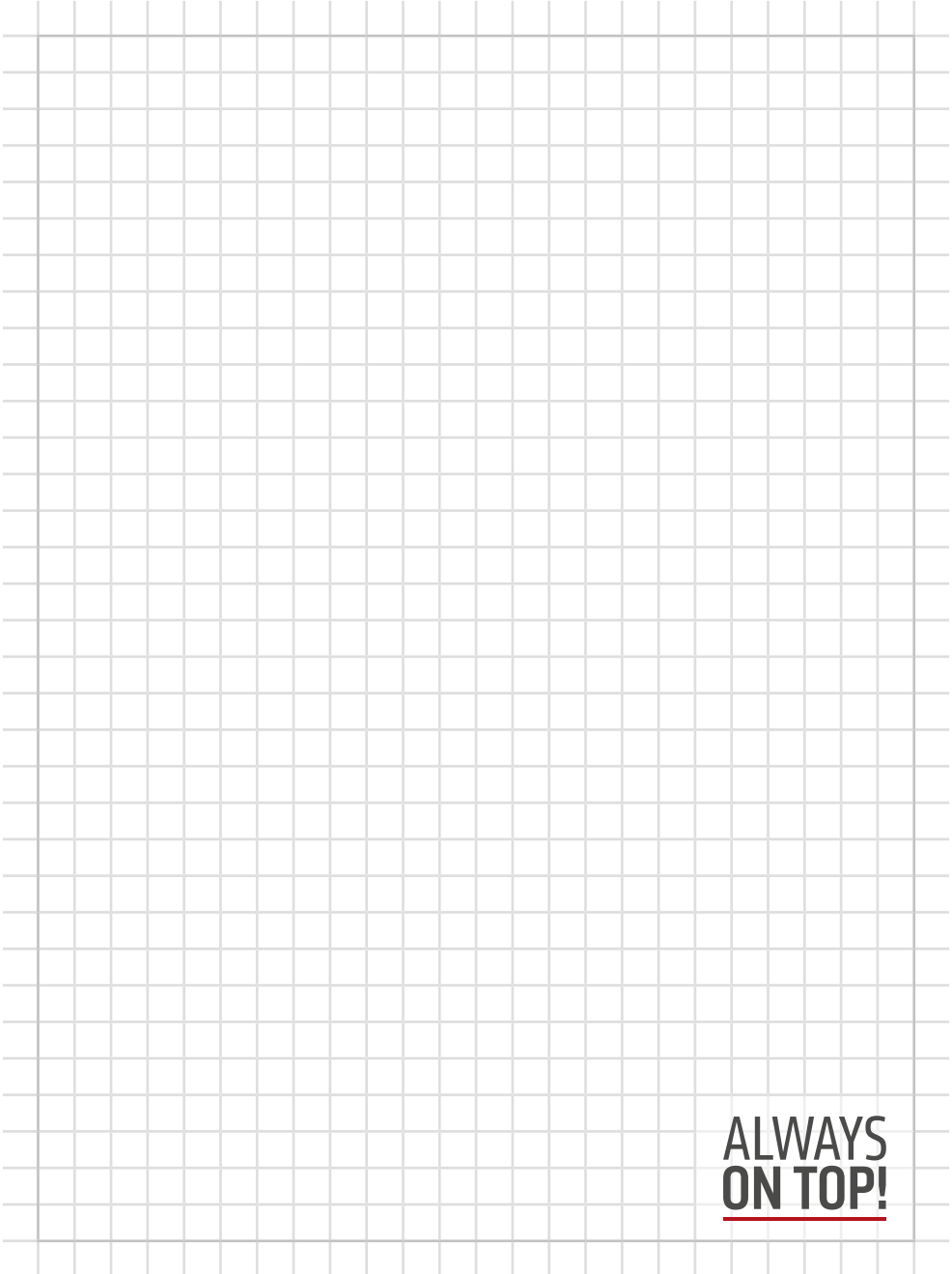

**ALWAYS
ON TOP!**

ALWAYS ON TOP!

ABS Safety GmbH

Gewerbering 3
D-47623 Kevelaer
Germany

Tel.: +49 28 32 972 81 - 0
Fax: +49 28 32 972 81 - 285

info@absturzsicung.de

 www.absturzsicung.de

 .de/en

 .de/fr

 .de/nl

RS 5. Oktober 2021



[instagram.com/abssafety](https://www.instagram.com/abssafety)



[youtube.com/abssafetygmbh](https://www.youtube.com/abssafetygmbh)



[facebook.com/ABS.Safety](https://www.facebook.com/ABS.Safety)