

# ABS AluTrax

AT



MoA 209-05



## Werkzeuge | Tools



## Sicherheitshinweise | Safety instructions



- DE** Die Anweisungen der Montageanleitung (1) und Sicherheitshinweise (2) sind strikt einzuhalten.
- EN** The information contained in the assembly instructions (1) and safety instructions (2) must be strictly observed.
- NL** De aanwijzingen in de montagehandleiding (1) en de veiligheidsvoorschriften (2) moeten strikt worden nageleefd.
- ES** Respete estrictamente las instrucciones del manual de montaje (1) y las indicaciones de seguridad (2).
- IT** È assolutamente necessario attenersi alle istruzioni di montaggio (1) e alle norme di sicurezza (2).
- FR** Les instructions de la notice de montage (1) et les consignes de sécurité (2) doivent être formellement respectées.
- PL** Należy ściśle przestrzegać instrukcji montażu (1) i wskázówek bezpieczeñstwa (2).
- DK** Montagevejledningens (1) anvisninger som også sikkerhedshenvisningerne (2) skal overholdes.
- CZ** Je nutné striktně dodržovat instrukce obsažené v montážním návodu (1) a v bezpečnostních pokynech (2).
- GR** Πρέπει να τηρούνται αυστηρά οι οδηγίες του εγχειριδίου συναρμολόγησης (1) και των υποδείξεων ασφαλείας (2).
- SK** Dósledne dodržiavajte pokyny montážneho návodu (1) a bezpečnostné pokyny (2).
- TR** Montaj kılavuzunun (1) ve güvenliik uyarılarının talimatlarına (2) kesinlikle uyulmalıdır.
- NO** Det er svært viktig at instruksjonene i monteringshåndboken (1) og sikkerhetsheftet (2) følges.
- RUS** Необходимо строго соблюдать требования руководства по монтажу (1) и инструкции по безопасности (2).
- RO** Indicațiile din instrucțiunile de montare (1) și din broșura cu indicații de siguranță (2) trebuie respectate cu strictețe.
- FI** Asennusohjeen (1) ja turvaohjeikkosen (2) ohjeita on ehdottomasti noudatettava.
- SE** Anvisningarna till monteringsanvisningen (1) och säkerhetsmanualen (2) måste iaktas under alla omständigheter.
- HI** इंस्ट्रक्शन के निर्देशों (1) और सुरक्षा निर्देश मैनुअल (2) में दिये गये निर्देशों का सख्ती से अनुसरण किया जाना चाहिए।
- ZH** 必须严格遵守装配说明书 (1) 和安全须知单 (2) 中的指示。
- SQ** Jëpib ialtزام بالاعليمااء الواراءة في اءليل التركيب (1) واءيب ارشاءااء السلامة (2) بماءنأى اءقا

## Kontakte | Contact persons

**Vertrieb & Technische Beratung**  
Sales & Technical Support  
+49 (0) 28 32 - 972 81 - 0  
vertrieb@absturzsicherung.de

**Schulung**  
Training

+49 (0) 28 32 - 972 81 - 254  
schulung@absturzsicherung.de

**Montagevorbereitung**  
Assembly

+49 (0) 28 32 - 972 81 - 260  
service@absturzsicherung.de

## Mustertypenschild | Sample label



**ABS SAFETY GMBH** [3]  
Kevelaer, Germany  
info@absturzsicherung.de  
www.absturzsicherung.de

[1]
 [2]

---

**Mustertypenschild /**  
**Sample only**

**Chargennummer /**  
**Batch number**

---

<b>6</b>	Normen / Standards	<input type="checkbox"/>	-
<b>7</b>	Max. Nutzer gleichzeitig (DIN EN 795:2012) Max. No. of simultaneous users	<input type="checkbox"/>	-
<b>11</b>	Modellnummer / Model number	<input type="checkbox"/>	-
<input type="checkbox"/>	-	<input type="checkbox"/>	-
<input type="checkbox"/>	-	<input type="checkbox"/>	-
<input type="checkbox"/>	-	<input type="checkbox"/>	-

<b>8</b>	<b>9</b>	<b>10</b>
0158		



# Montageschritte dokumentieren

Document assembly step

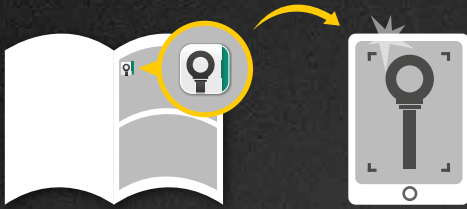

[abs.lock-book.com](https://abs.lock-book.com)

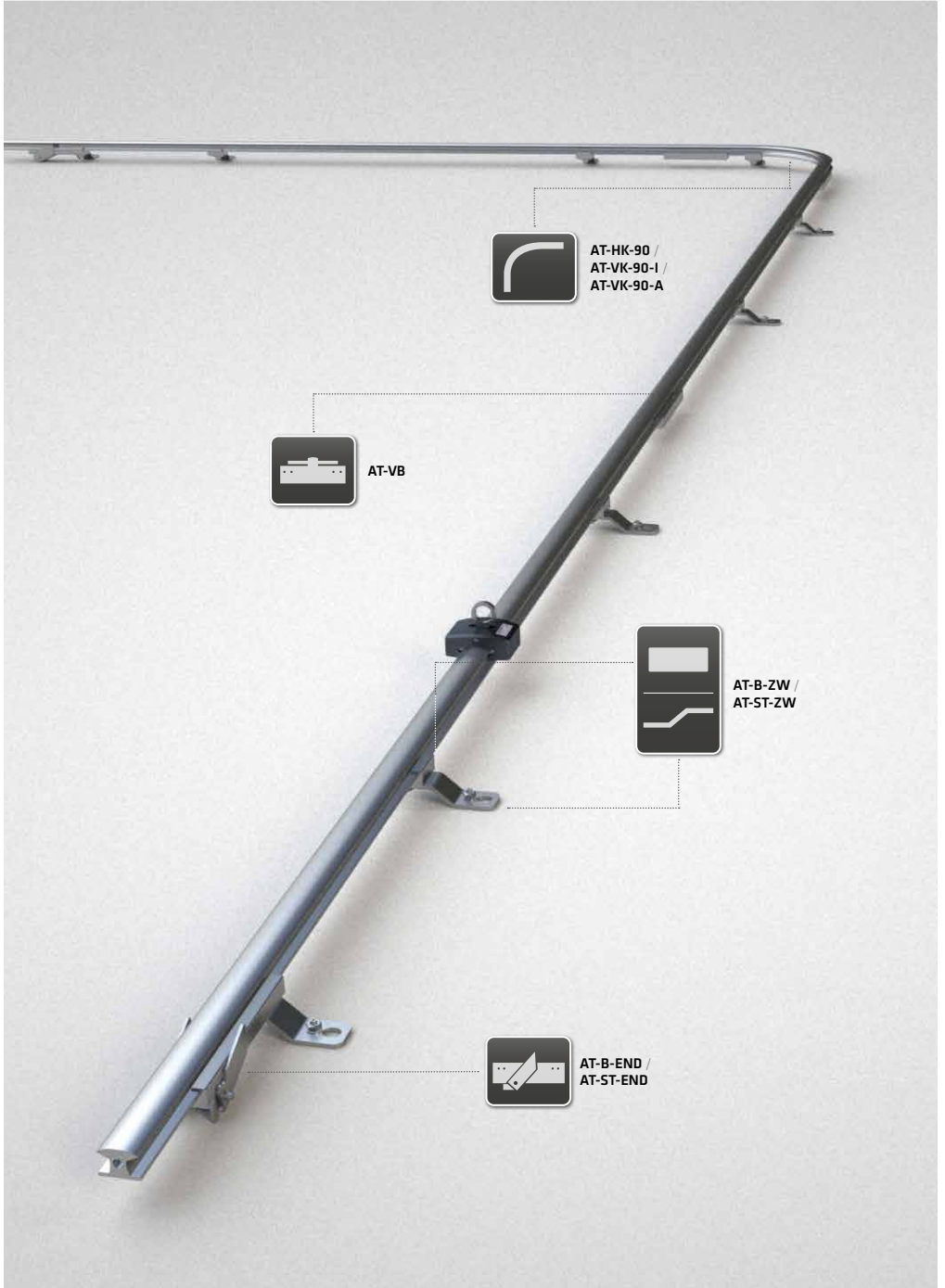



AT-B-END /  
AT-ST-END



AT-B-ZW /  
AT-ST-ZW



AT-VB



AT-B-ZW /  
AT-ST-ZW



AT-VB



AT-B-ZW /  
AT-ST-ZW



AT-B-END /  
AT-ST-END

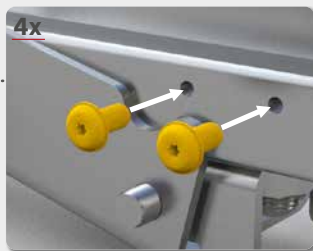
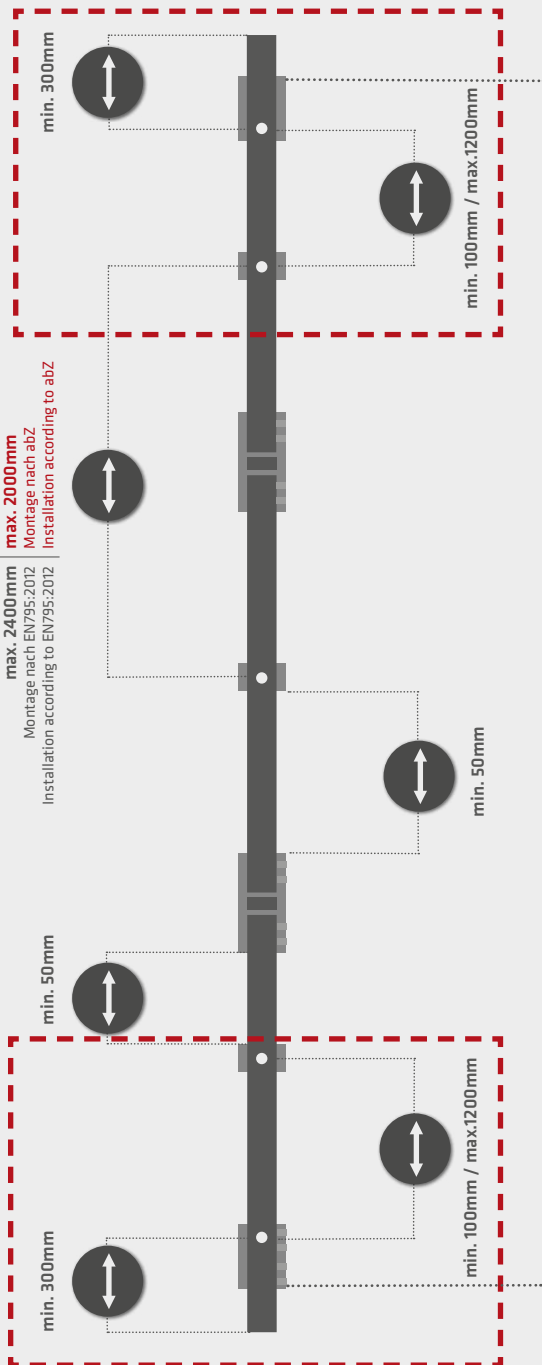

START

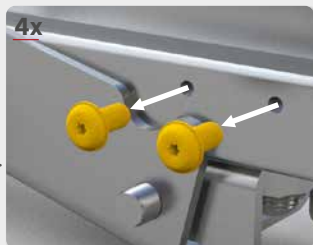

END

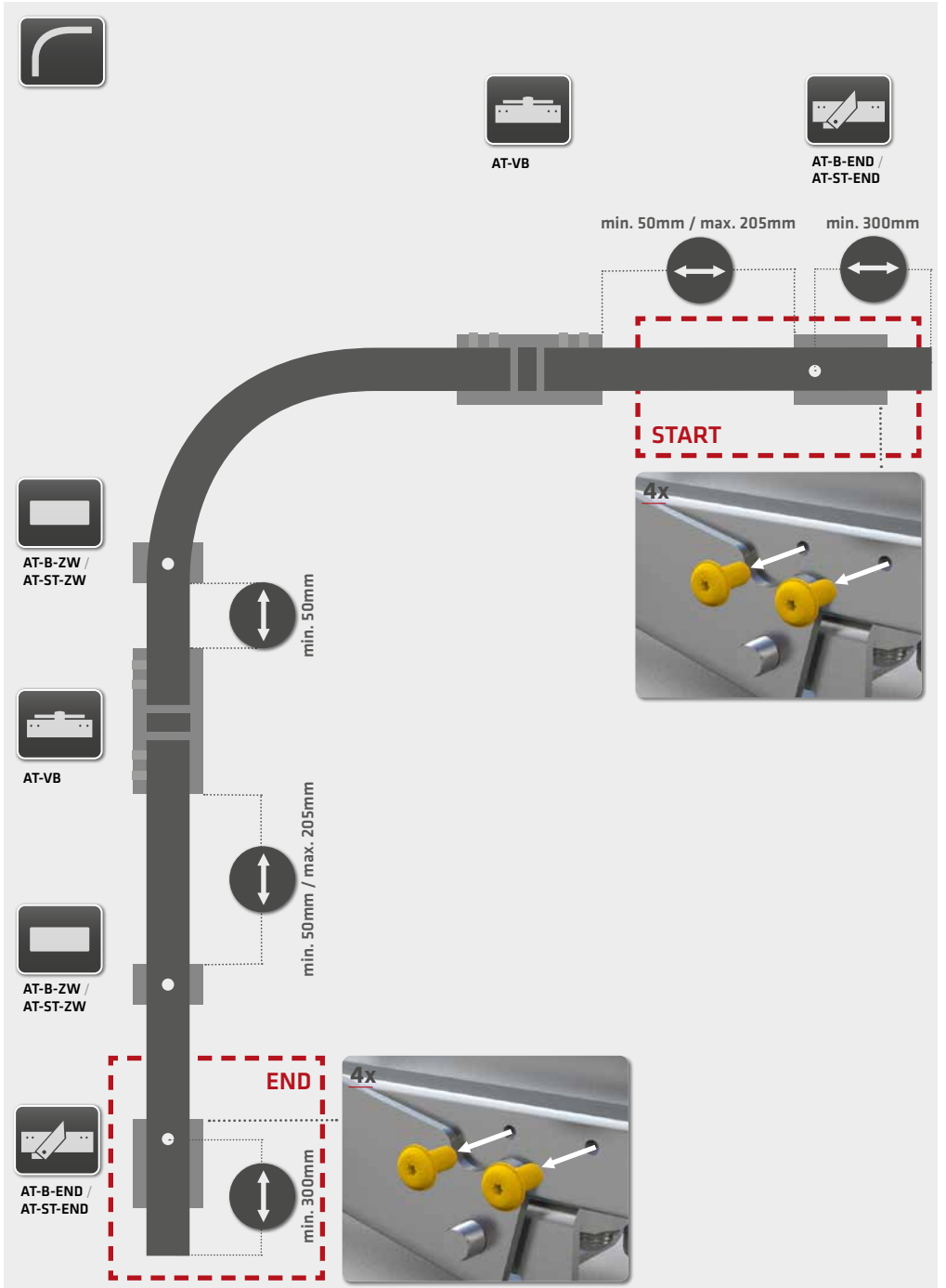

Optional

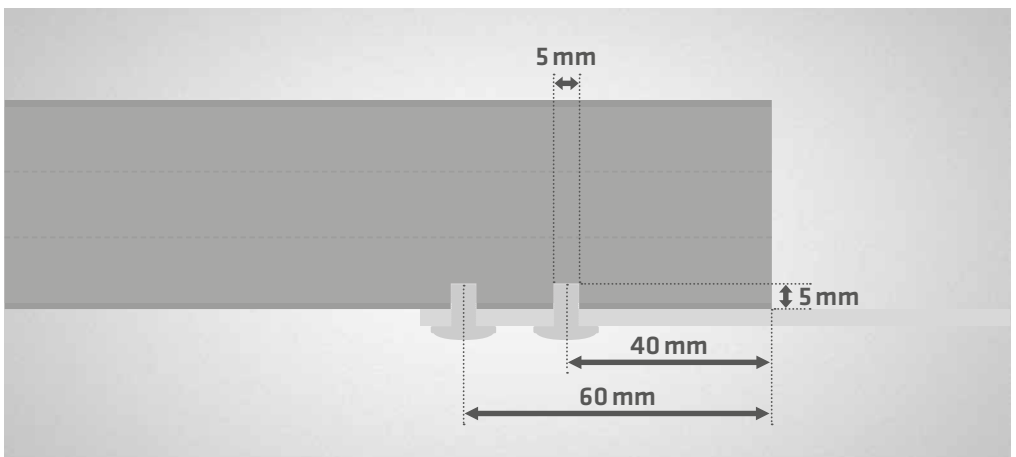
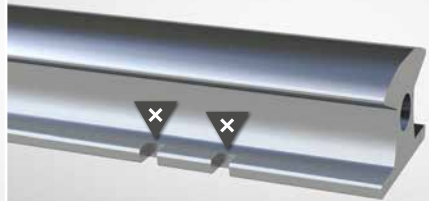
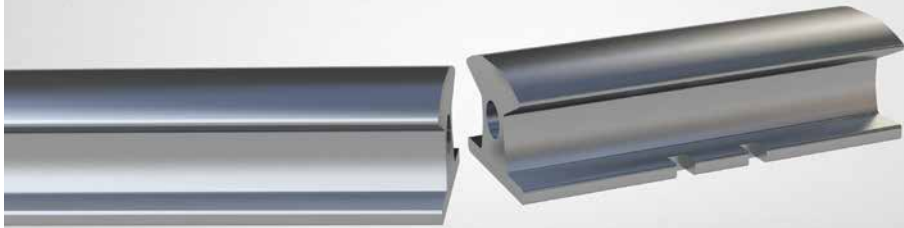

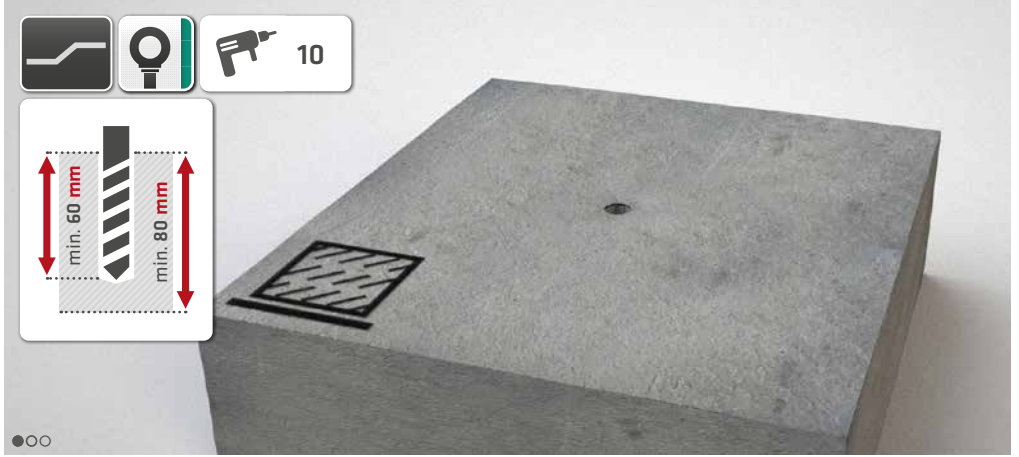



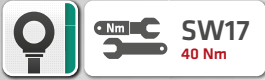

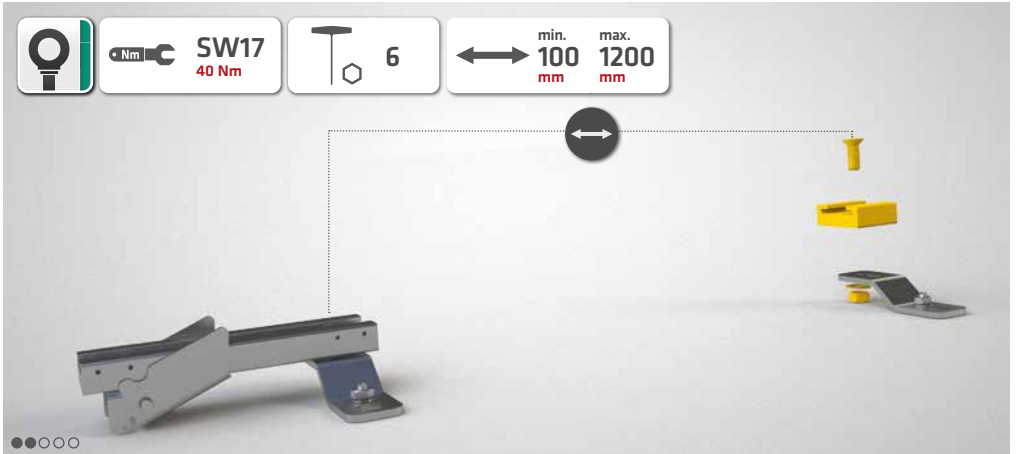
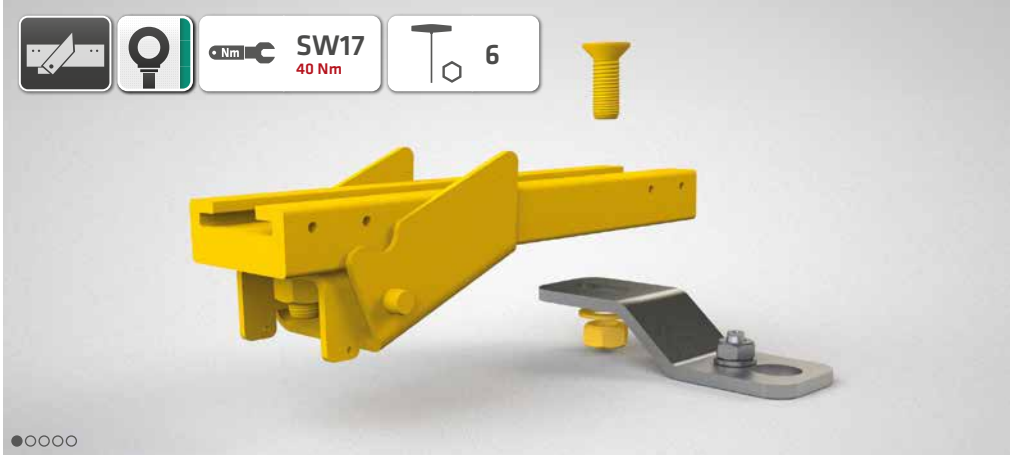





●○○○



●○○○



**i** Seite 6  
page 6



**TX20**

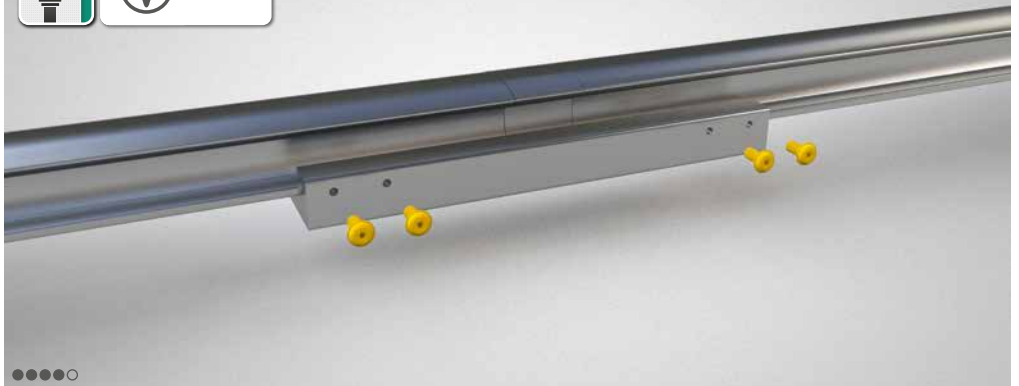

**a** max. 2400 (EN795:2012) mm  
max. 2000 (abZ) mm

**b** min. 50 mm



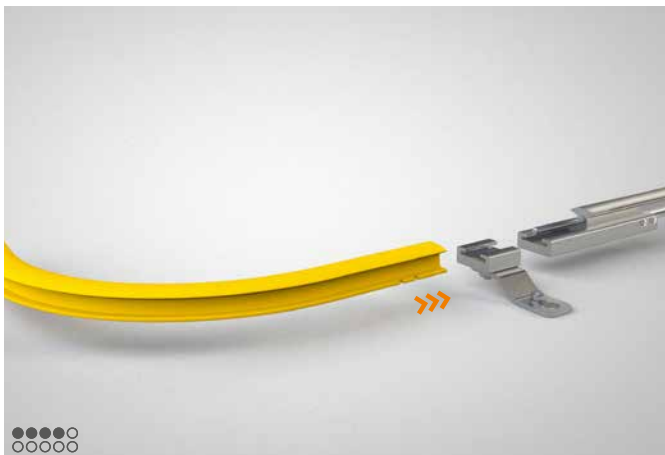
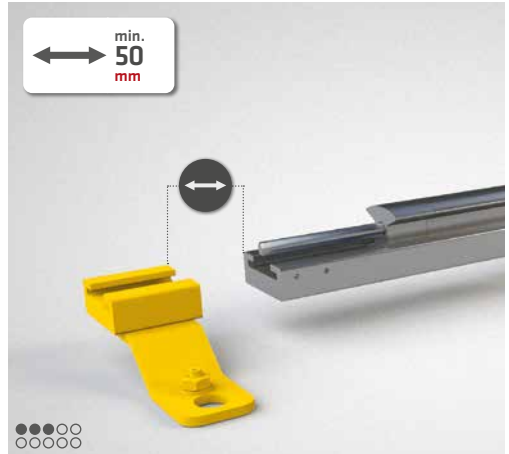
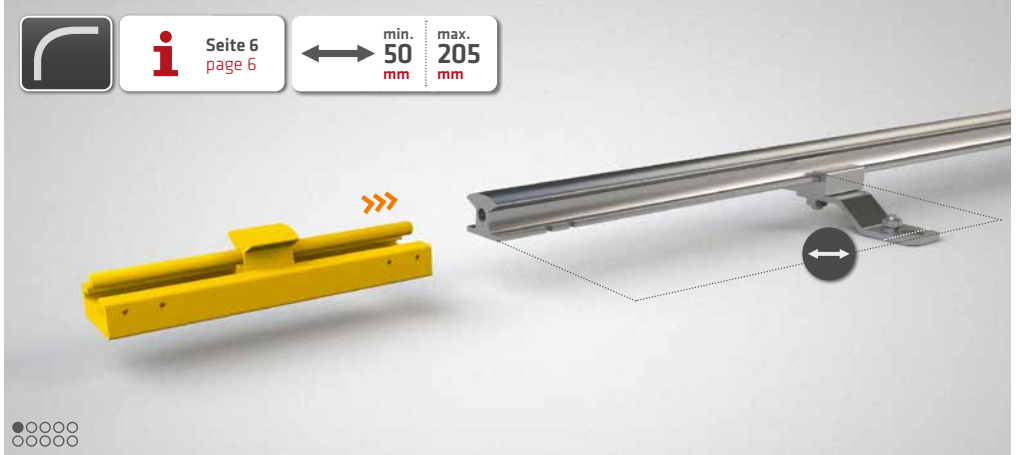



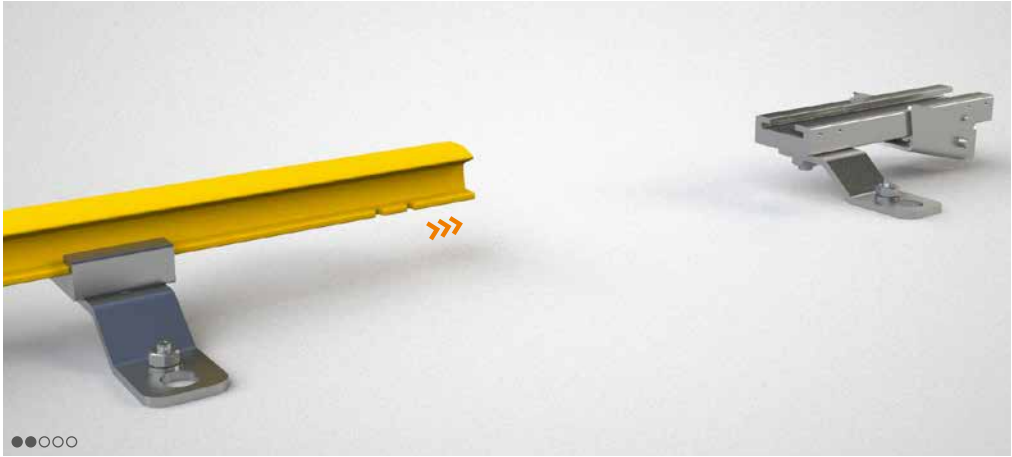
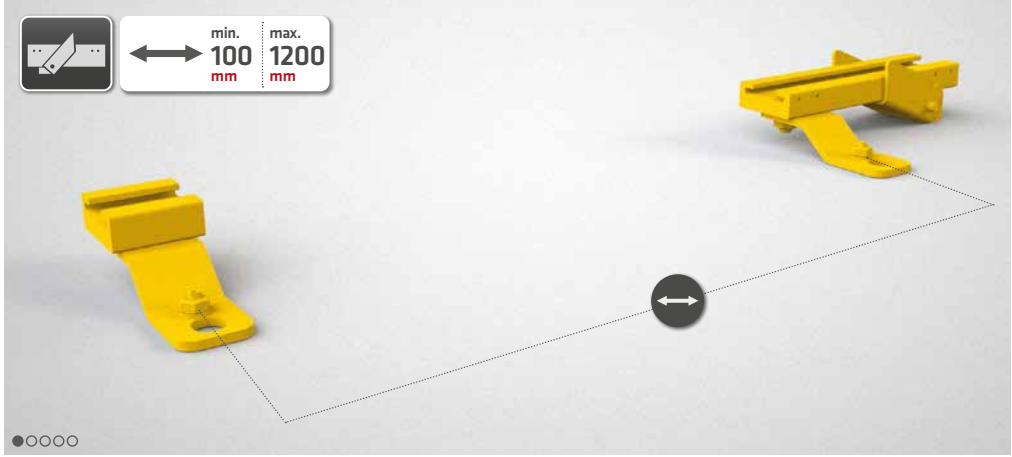



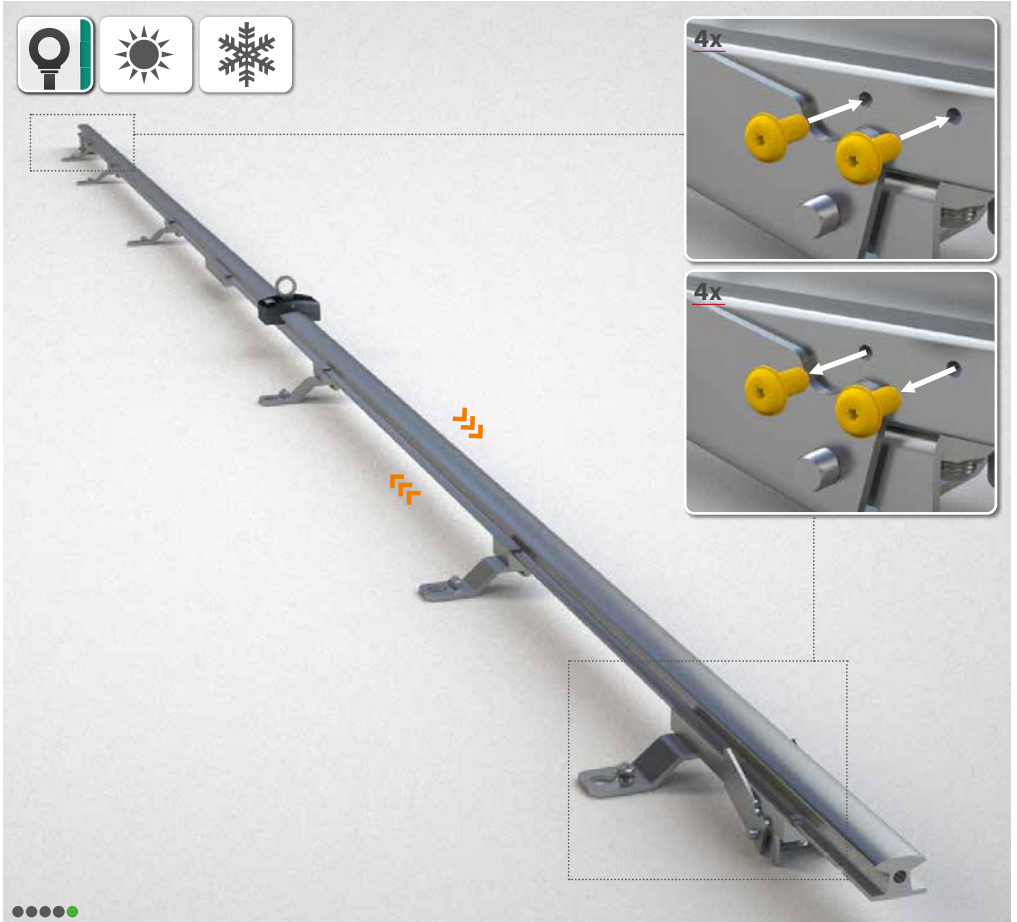

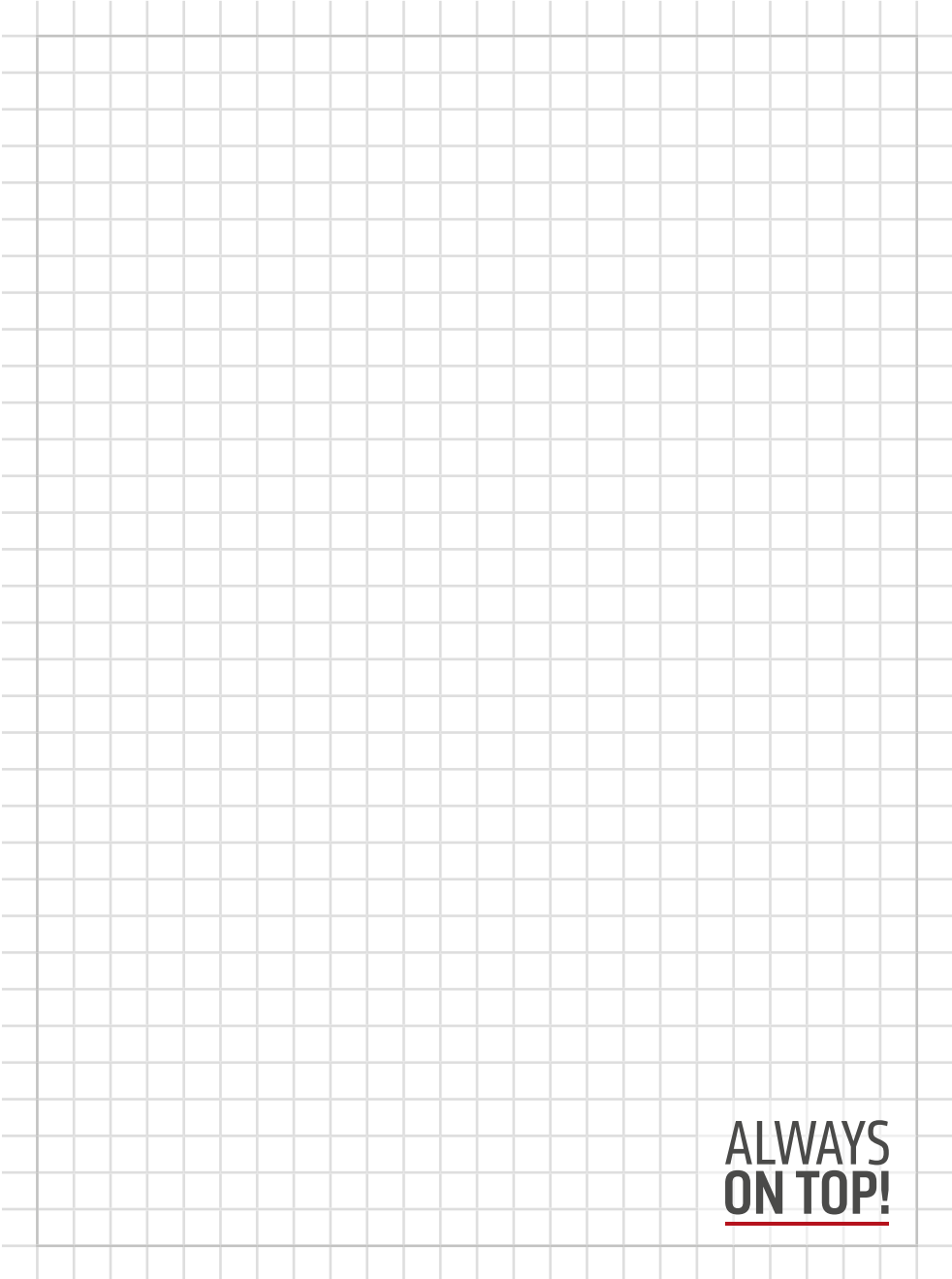

**ALWAYS  
ON TOP!**

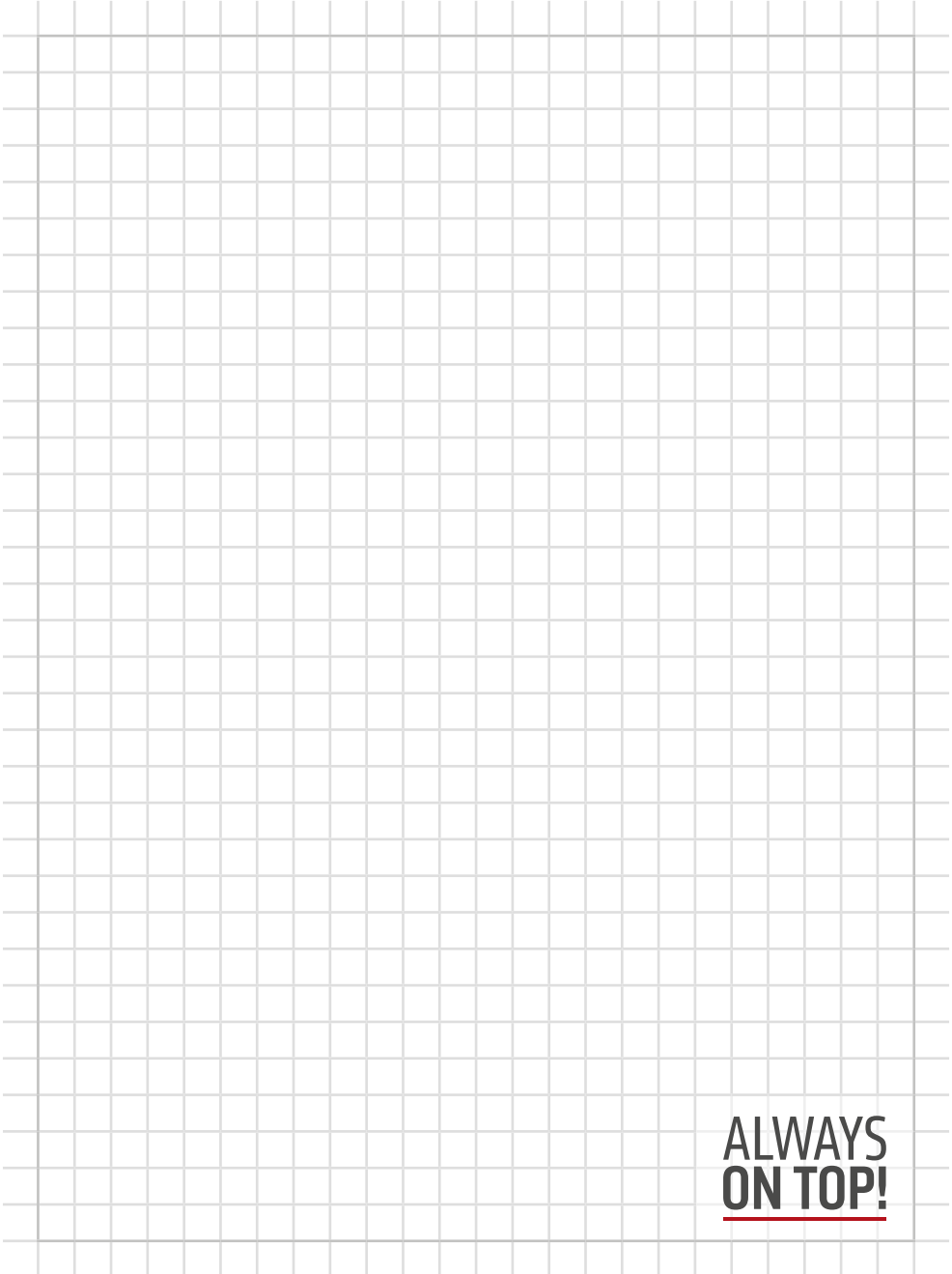

**ALWAYS  
ON TOP!**

# ALWAYS ON TOP!

## ABS Safety GmbH

Gewerbering 3  
D-47623 Kevelaer  
Germany

Tel.: +49 28 32 972 81 - 0  
Fax: +49 28 32 972 81 - 285

[info@absturzschutz.de](mailto:info@absturzschutz.de)



[www.absturzschutz.de](http://www.absturzschutz.de)



[.de/en](http://.de/en)



[.de/fr](http://.de/fr)



[.de/nl](http://.de/nl)

RS 74 September 2020



[instagram.com/abssafety](https://www.instagram.com/abssafety)



[youtube.com/abssafetygmbh](https://www.youtube.com/abssafetygmbh)



[facebook.com/ABS.Safety](https://www.facebook.com/ABS.Safety)