



CAD-Bibliothek
CAD Library

Stahl-Systeme
Fassadensysteme

VISS Basic Fassade

Steel Systems
Façade Systems

VISS Basic Façade

Schnittpunkte im Massstab 1:1
Coupe de détails à l'échelle 1:1
Section details on scale 1:1

VISS Basic Fassade
VISS Basic façade
VISS Basic façade

VISS Basic HI

Pfosten-Detail
Ansichtsbreite 50 mm
Schraubbolzen

VISS Basic HI

Détail du montant
Largeur de face 50 mm
Goujon à visser

VISS Basic HI

Detail of mullion
Width 50 mm
Screw bolt

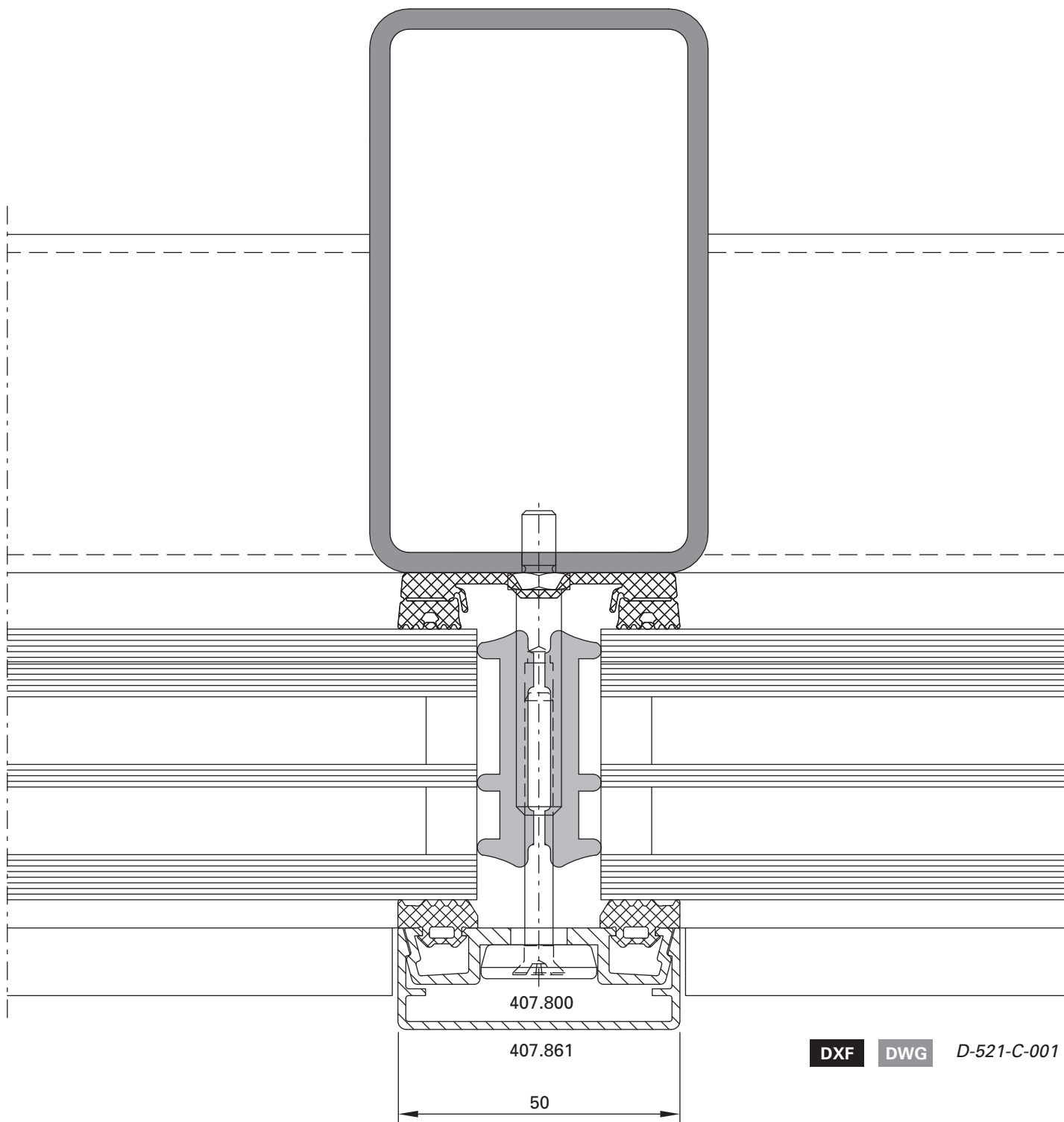

DXF DWG D-521-C-001

U_f-Werte siehe Seiten 24-63/64/65

Valeurs U_f voir pages 24-63/64/65

U_f values see pages 24-63/64/65

Schnittpunkte im Massstab 1:1
Coupe de détails à l'échelle 1:1
Section details on scale 1:1

VISS Basic Fassade
VISS Basic façade
VISS Basic façade

VISS Basic HI
Riegel-Detail
Ansichtsbreite 50 mm
Schraubbolzen

VISS Basic HI
Détail de la traverse
Largeur de face 50 mm
Goujon à visser

VISS Basic HI
Detail of transom
Width 50 mm
Screw bolt

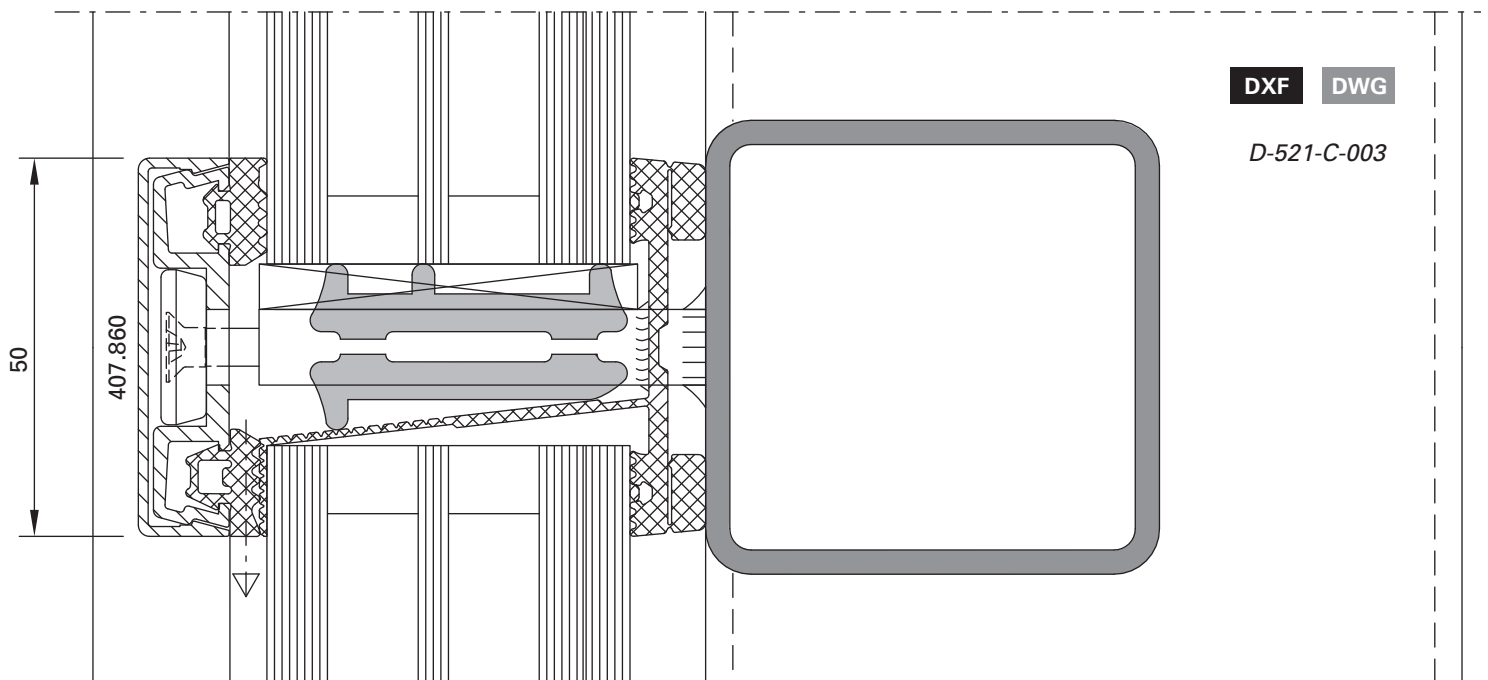
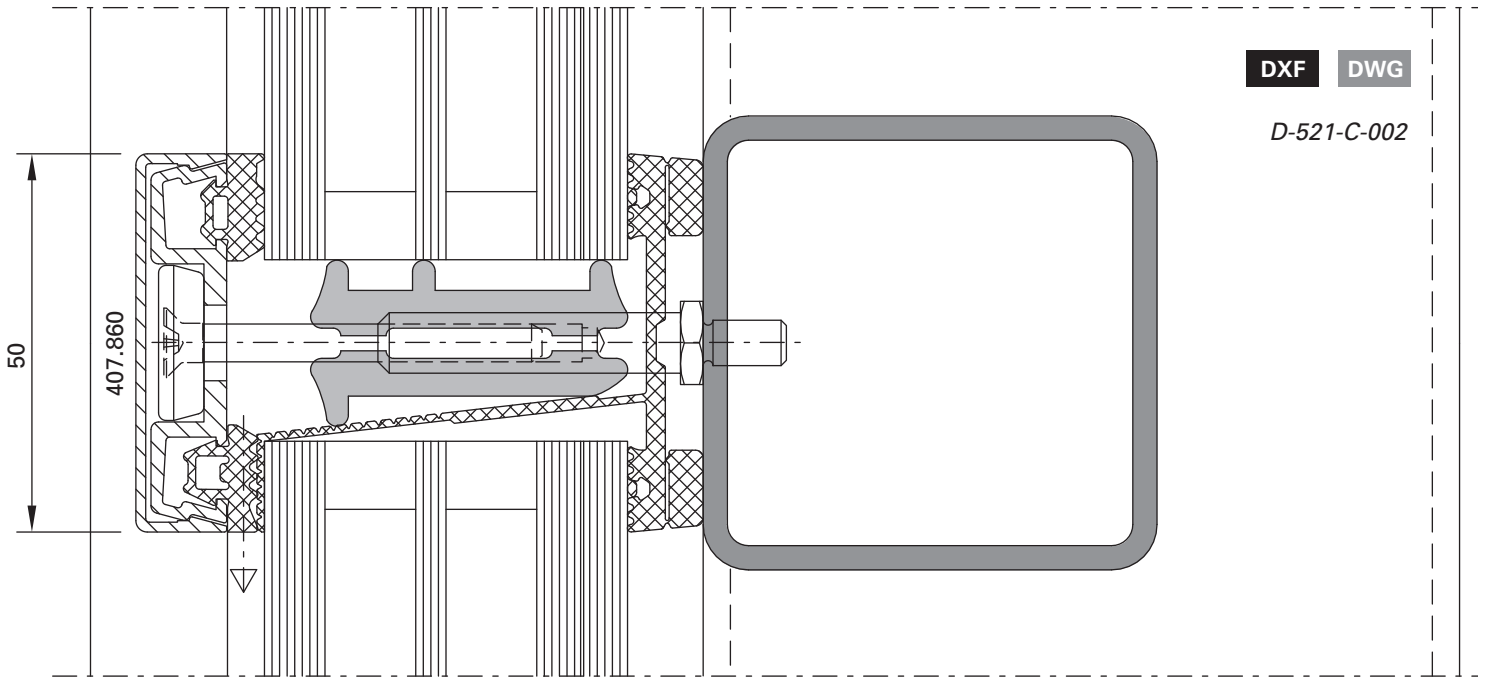

Schnittpunkte im Massstab 1:1
Coupe de détails à l'échelle 1:1
Section details on scale 1:1

VISS Basic Fassade
VISS Basic façade
VISS Basic façade

Pfosten-Detail
Ansichtsbreite 50 mm
Schraubbolzen

Détail du montant
Largeur de face 50 mm
Goujon à visser

Detail of mullion
Width 50 mm
Screw bolt

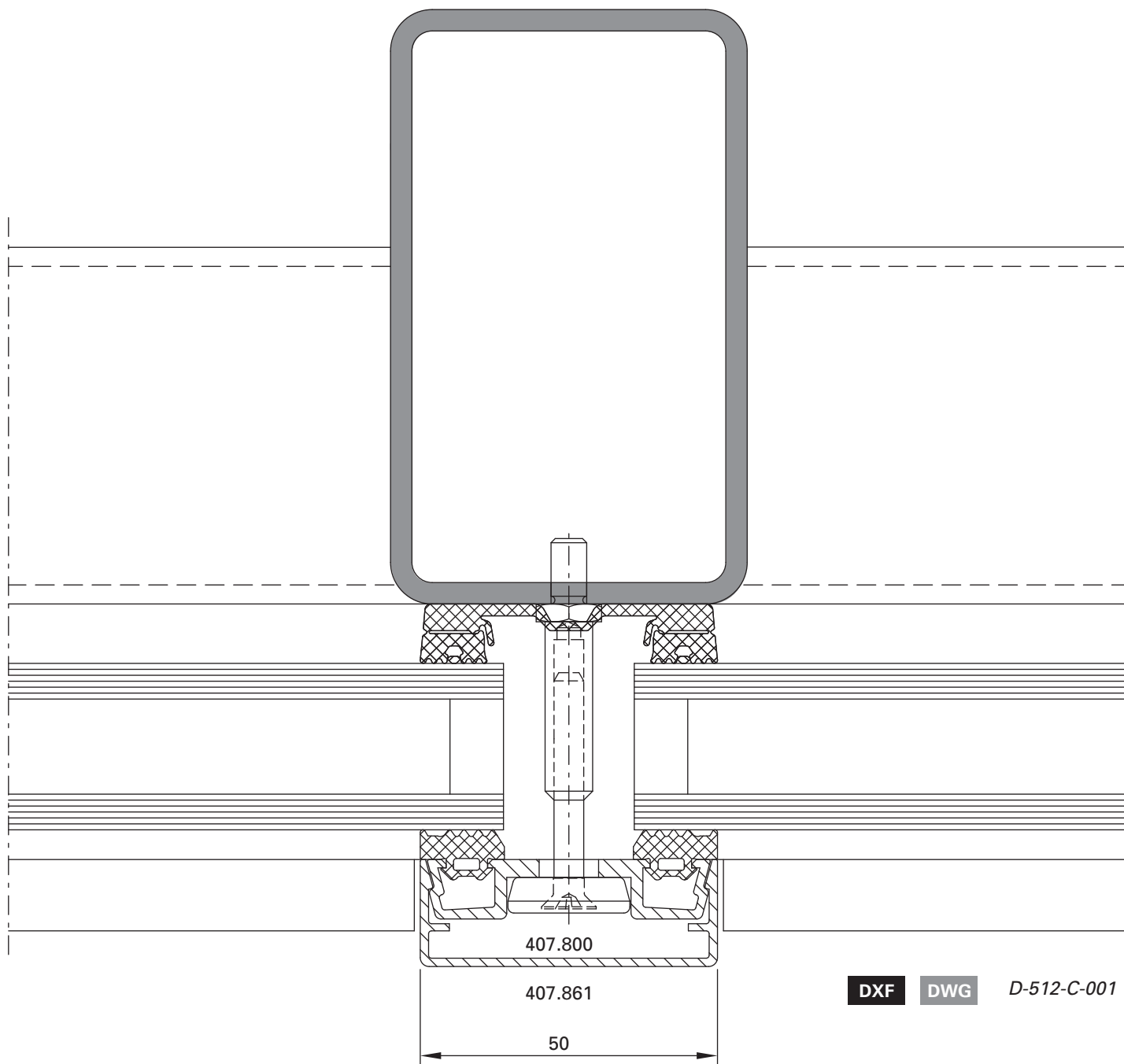

U_f-Werte siehe Seiten 24-63/64/65

Valeurs U_f voir pages 24-63/64/65

U_f values see pages 24-63/64/65

Pfosten-Detail VISS I_x tra
Ansichtsbreite 50 mm
Schraubbolzen

Détail du montant VISS I_x tra
Largeur de face 50 mm
Goujon à visser

Detail of mullion VISS I_x tra
Width 50 mm
Screw bolt

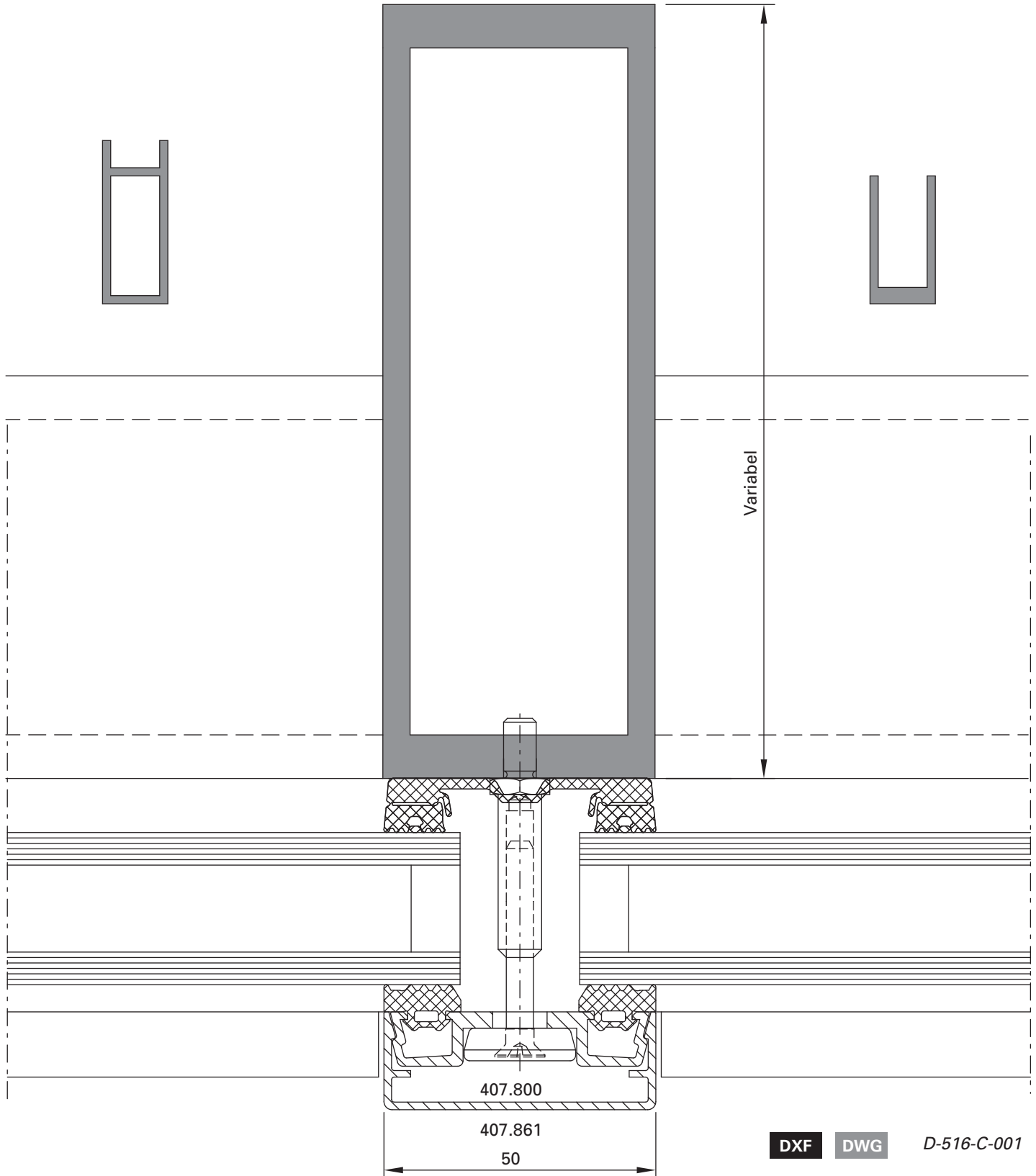

Schnittpunkte im Massstab 1:1
Coupe de détails à l'échelle 1:1
Section details on scale 1:1

VISS Basic Fassade
VISS Basic façade
VISS Basic façade

Pfosten-Detail
Ansichtsbreite 50 mm
Schweissbolzen

Détail du montant
Largeur de face 50 mm
Goujon à souder

Detail of mullion
Width 50 mm
Welding stud

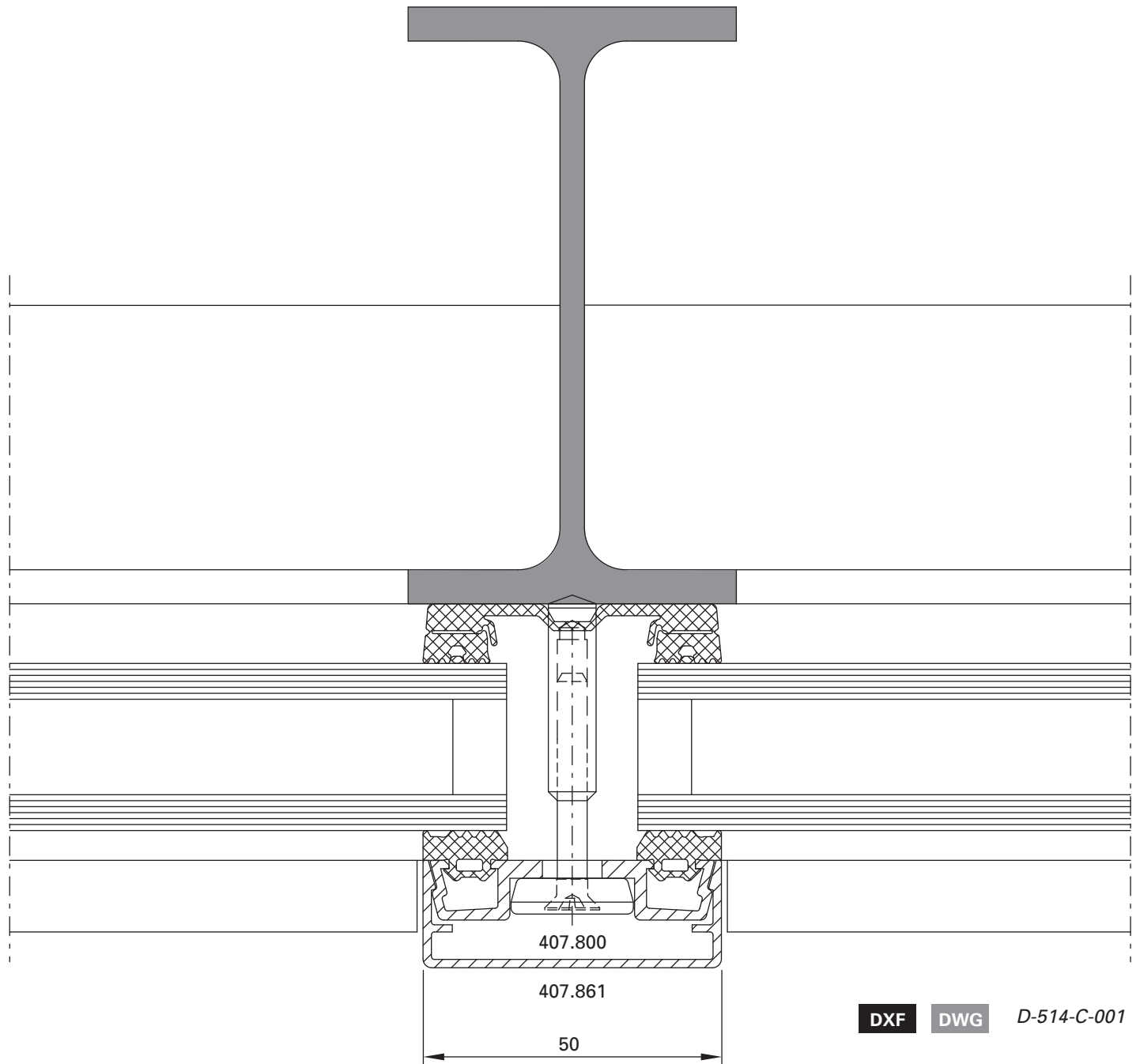

DXF

DWG

D-514-C-001

U_f-Werte siehe Seiten 24-63/64/65

Valeurs U_f voir pages 24-63/64/65

U_f values see pages 24-63/64/65

Pfosten-Detail VISS I_x tra
Ansichtsbreite 50 mm
Schweissbolzen

Détail du montant VISS I_x tra
Largeur de face 50 mm
Goujon à souder

Detail of mullion VISS I_x tra
Width 50 mm
Welding stud

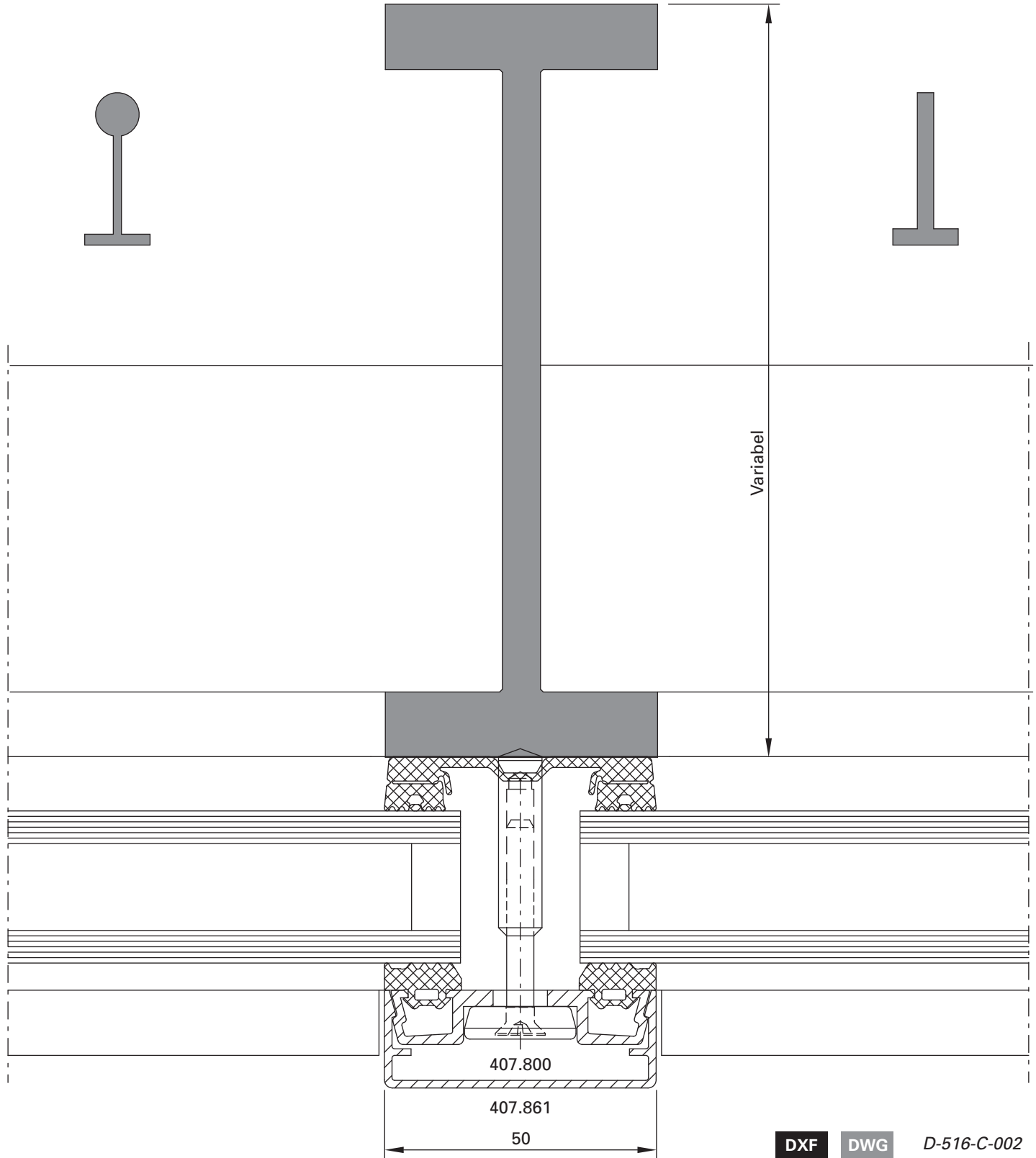

DXF

DWG

D-516-C-002

Schnittpunkte im Massstab 1:1
Coupe de détails à l'échelle 1:1
Section details on scale 1:1

VISS Basic Fassade
VISS Basic façade
VISS Basic façade

Riegel-Detail
Ansichtsbreite 50 mm
Schraubbolzen

Détail de la traverse
Largeur de face 50 mm
Goujon à visser

Detail of transom
Width 50 mm
Screw bolt

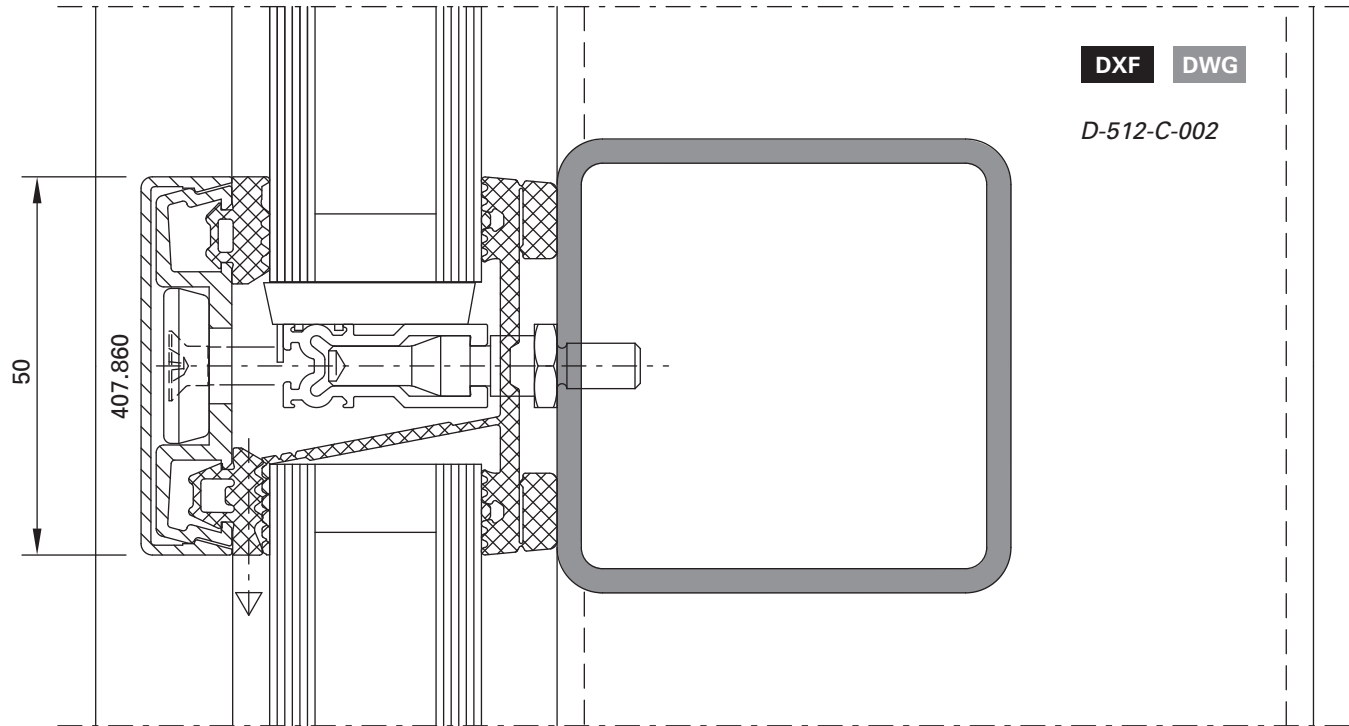

Riegel-Detail
Ansichtsbreite 50 mm
Schweissbolzen

Détail de la traverse
Largeur de face 50 mm
Goujon à souder

Detail of transom
Width 50 mm
Welding stud

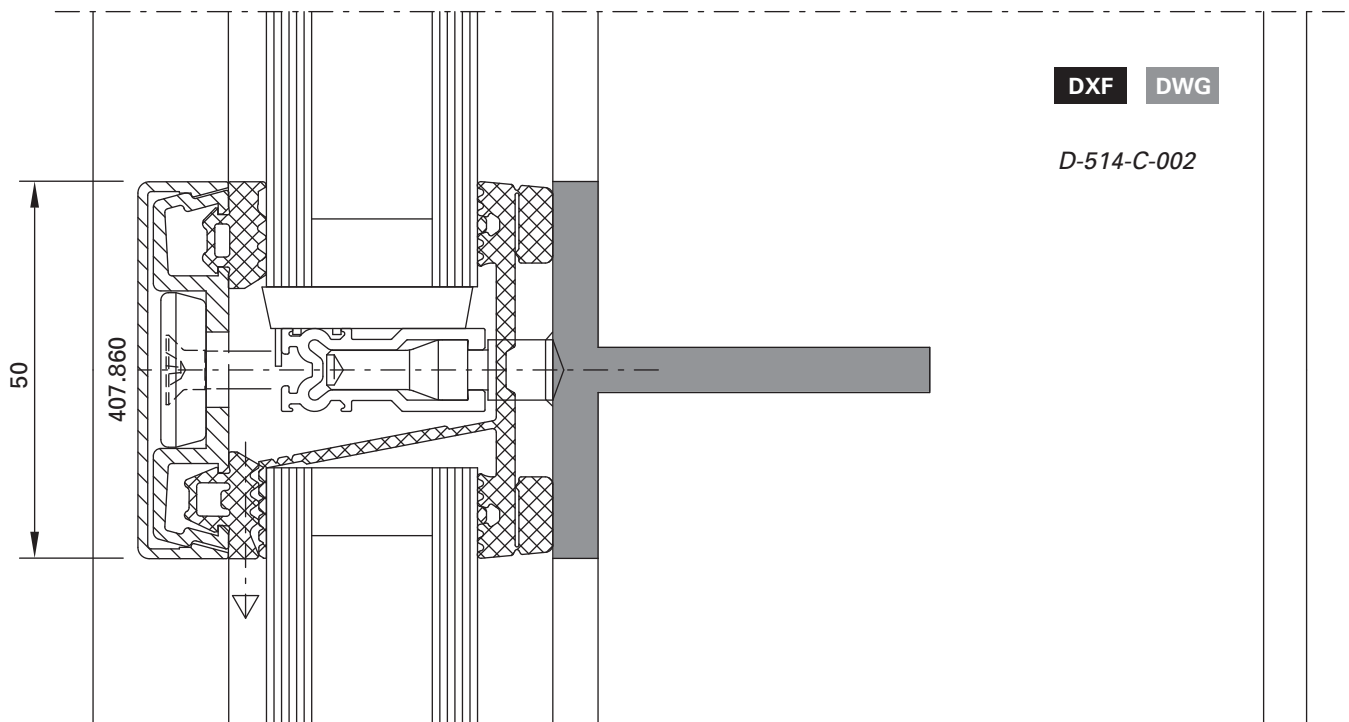

Schnittpunkte im Massstab 1:1
Coupe de détails à l'échelle 1:1
Section details on scale 1:1

VISS Basic Fassade
VISS Basic façade
VISS Basic façade

Pfosten-Detail
Ansichtsbreite 60 mm
Schraubbolzen

Détail du montant
Largeur de face 60 mm
Goujon à visser

Detail of mullion
Width 60 mm
Screw bolt

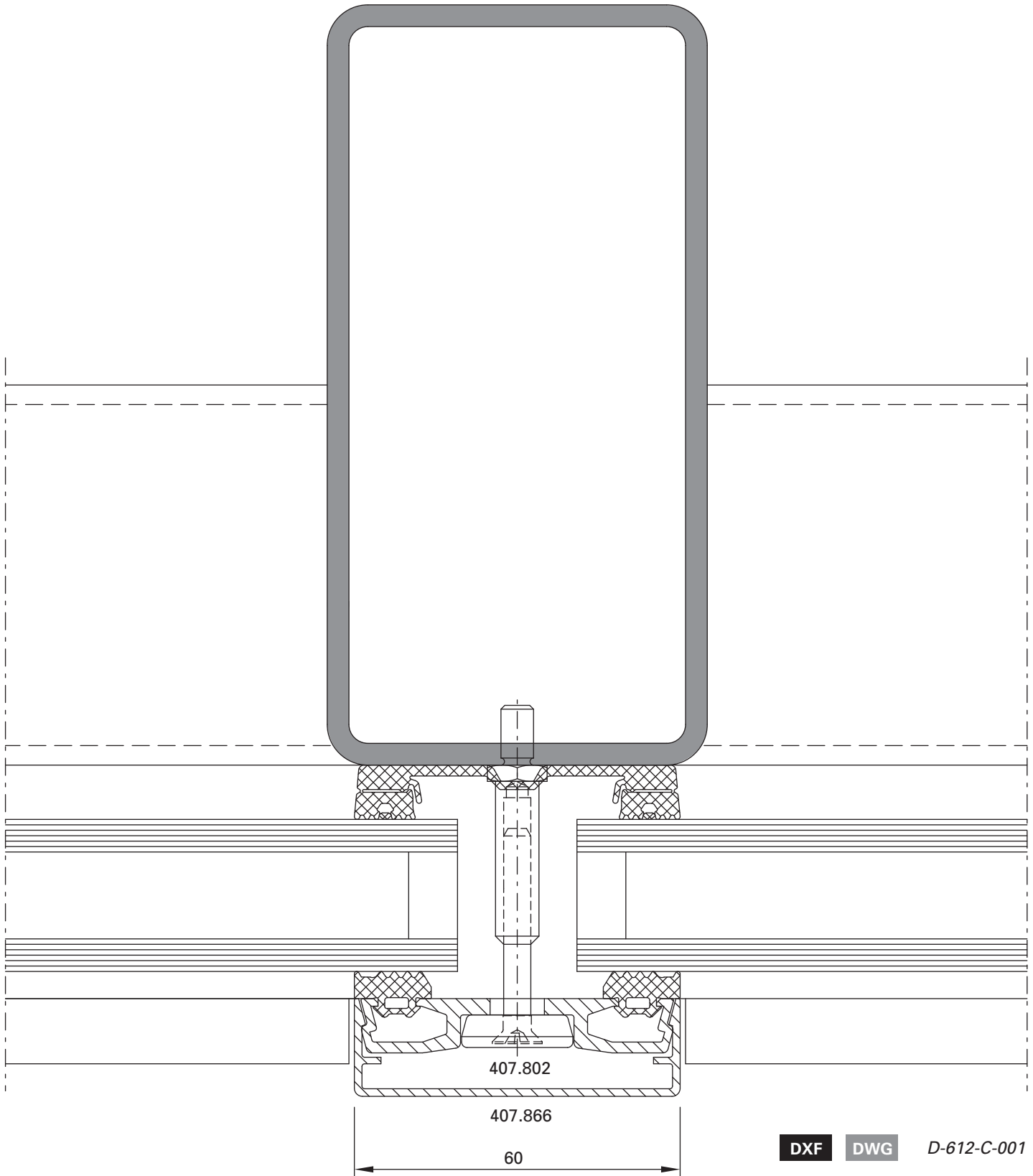

DXF

DWG

D-612-C-001

Schnittpunkte im Massstab 1:1
Coupe de détails à l'échelle 1:1
Section details on scale 1:1

VISS Basic Fassade
VISS Basic façade
VISS Basic façade

Pfosten-Detail VISS I_xtra
Ansichtsbreite 60 mm
Schraubbolzen

Détail du montant VISS I_xtra
Largeur de face 60 mm
Goujon à visser

Detail of mullion VISS I_xtra
Width 60 mm
Screw bolt

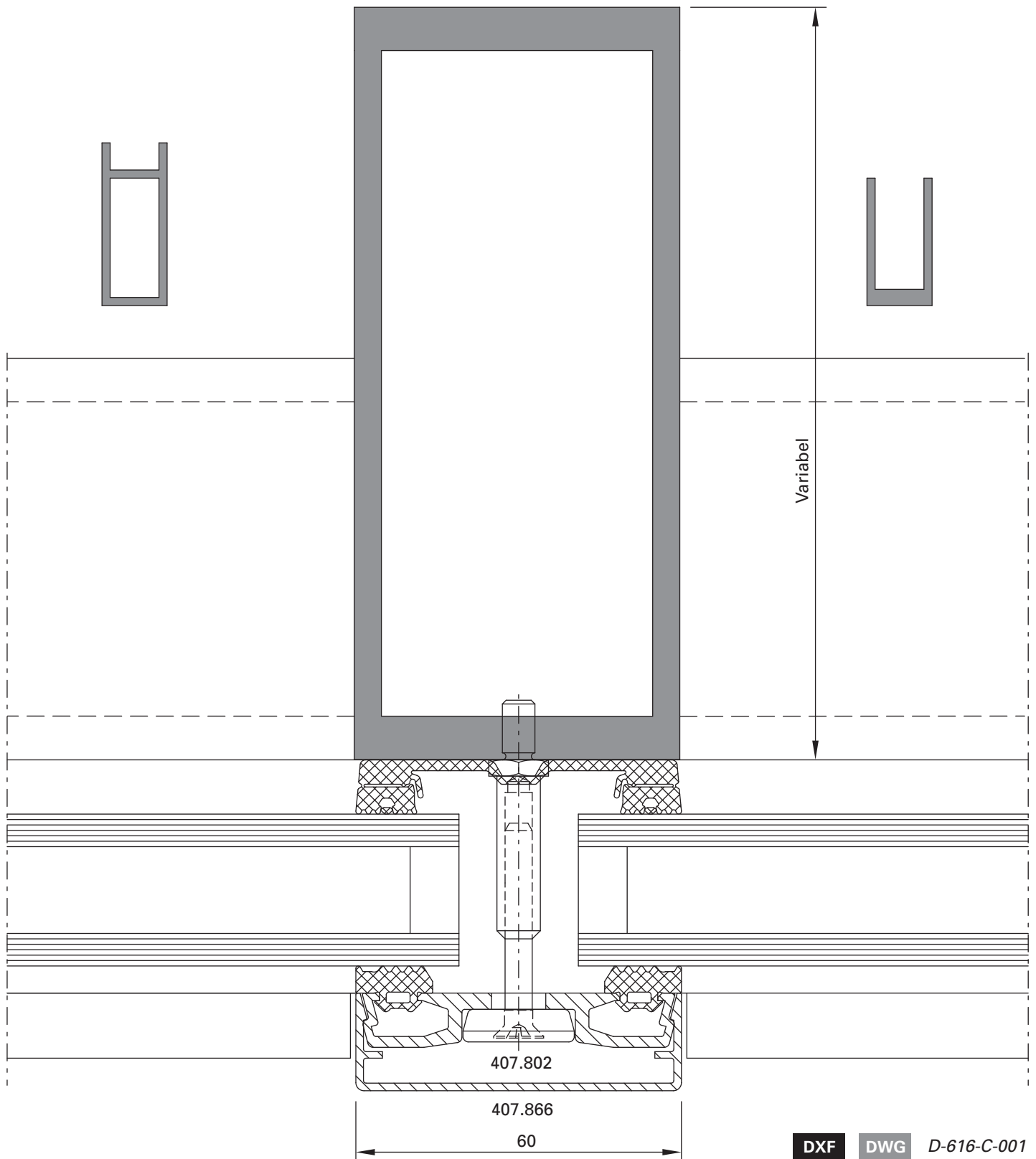

DXF DWG D-616-C-001

Schnittpunkte im Massstab 1:1
Coupe de détails à l'échelle 1:1
Section details on scale 1:1

VISS Basic Fassade
VISS Basic façade
VISS Basic façade

Pfosten-Detail
Ansichtsbreite 60 mm
Schweissbolzen

Détail du montant
Largeur de face 60 mm
Goujon à souder

Detail of mullion
Width 60 mm
Welding stud

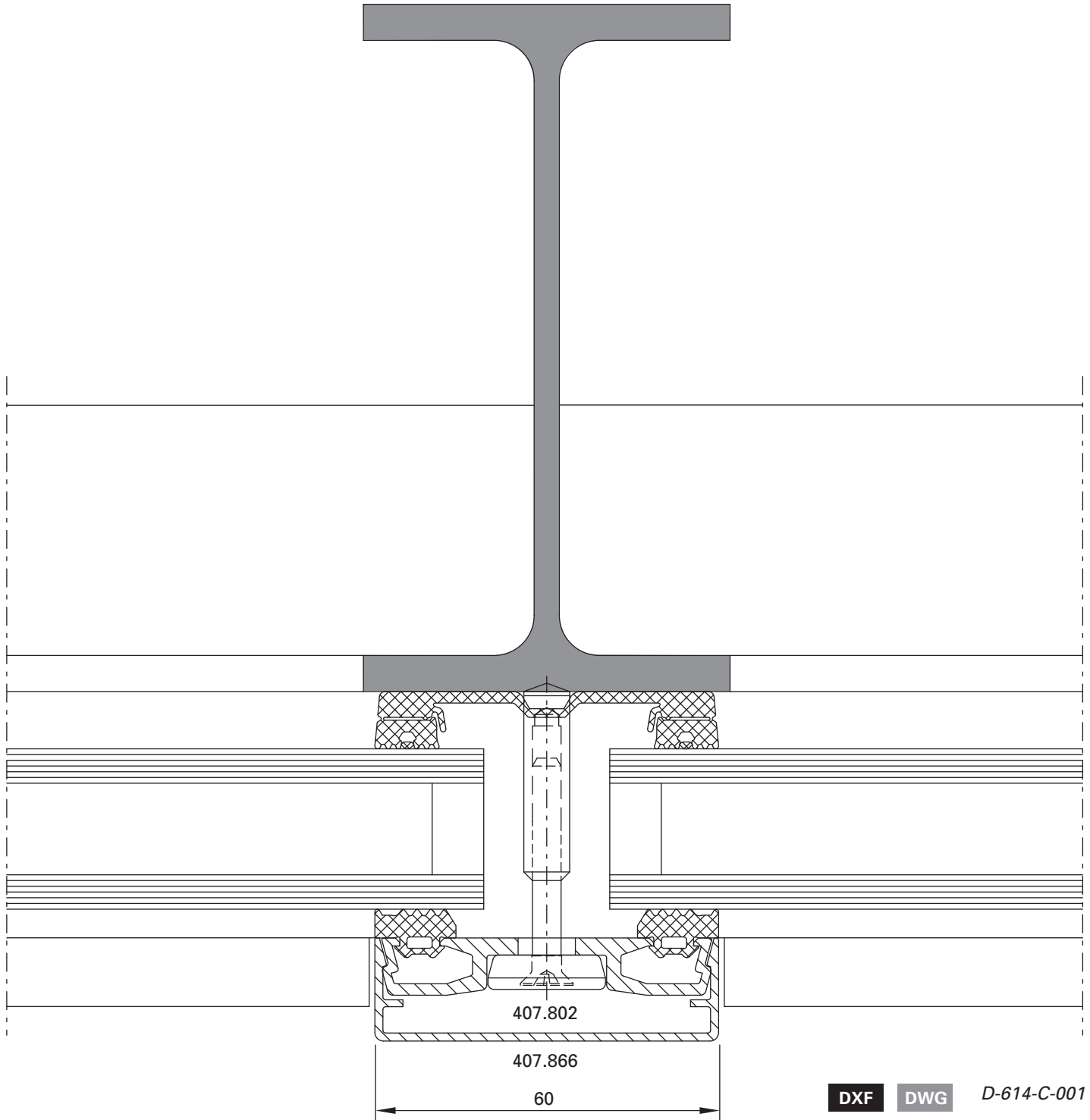

DXF

DWG

D-614-C-001

U_f-Werte siehe Seiten 24-63/64/65

Valeurs U_f voir pages 24-63/64/65

U_f values see pages 24-63/64/65

Schnittpunkte im Massstab 1:1
Coupe de détails à l'échelle 1:1
Section details on scale 1:1

VISS Basic Fassade
VISS Basic façade
VISS Basic façade

Pfosten-Detail VISS I_x tra
Ansichtsbreite 60 mm
Schweissbolzen

Détail du montant VISS I_x tra
Largeur de face 60 mm
Goujon à souder

Detail of mullion VISS I_x tra
Width 60 mm
Welding stud

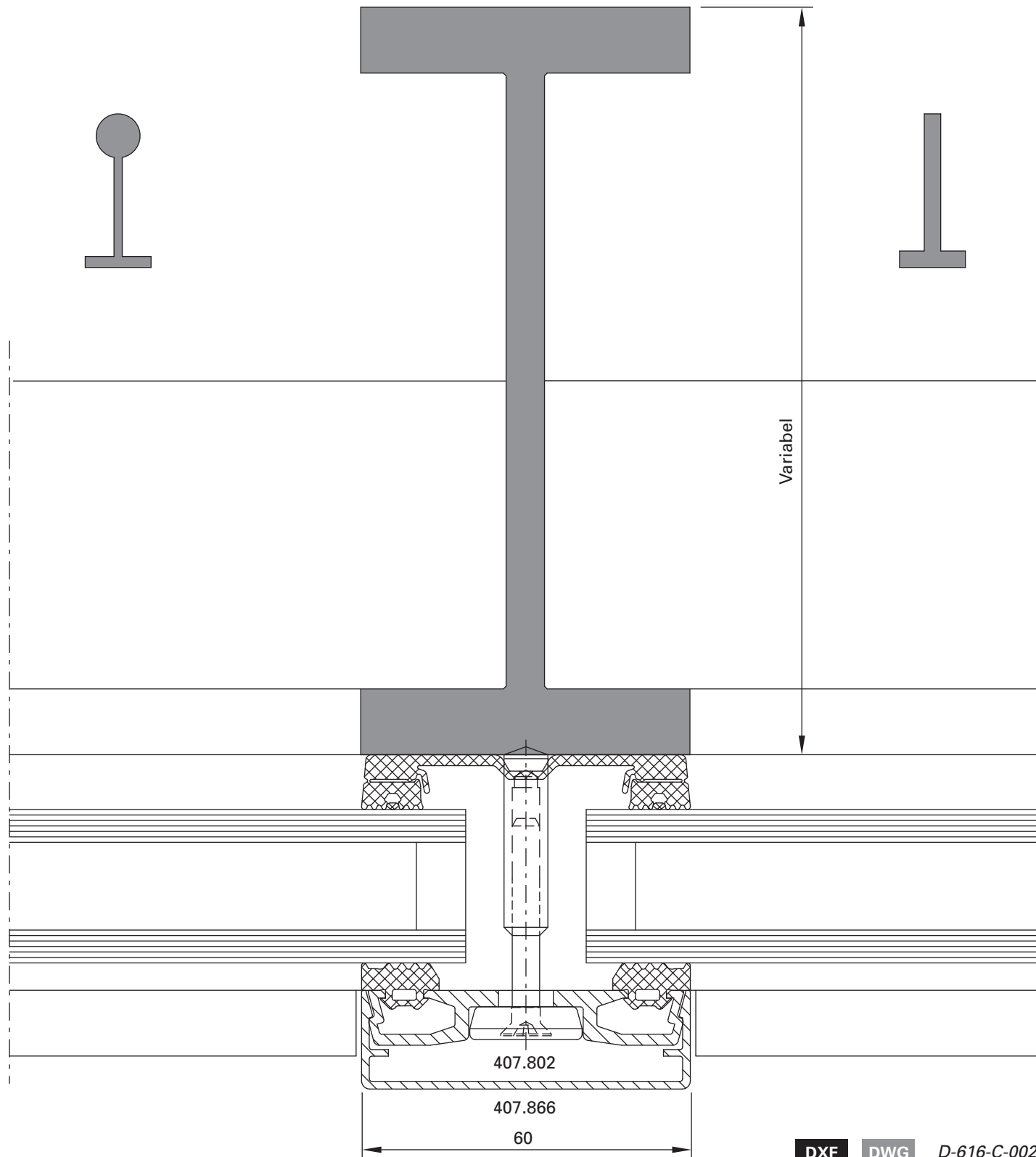

DXF DWG D-616-C-002

Schnittpunkte im Massstab 1:1
Coupe de détails à l'échelle 1:1
Section details on scale 1:1

VISS Basic Fassade
VISS Basic façade
VISS Basic façade

Riegel-Detail
Ansichtsbreite 60 mm
Schraubbolzen

Détail de la traverse
Largeur de face 60 mm
Goujon à visser

Detail of transom
Width 60 mm
Screw bolt

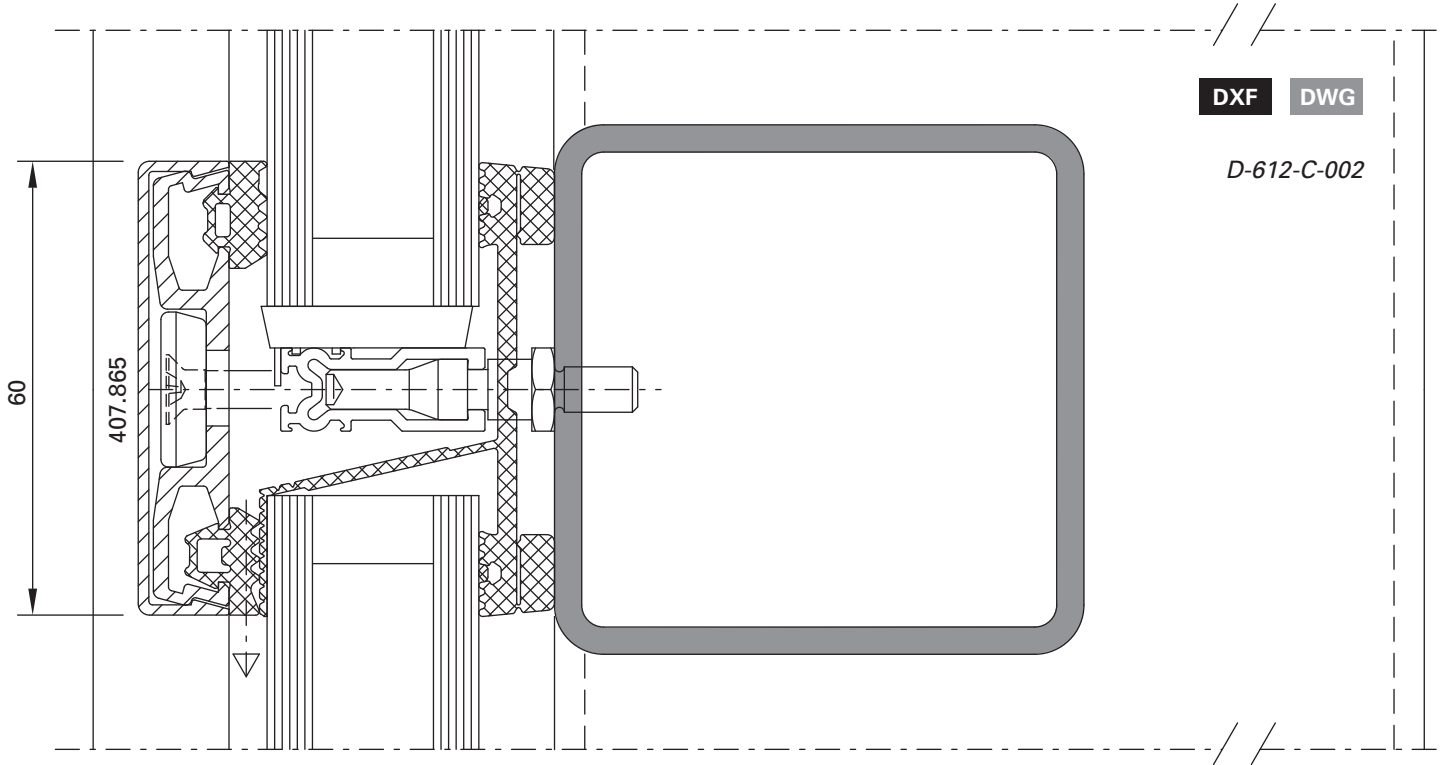

Riegel-Detail
Ansichtsbreite 60 mm
Schweissbolzen

Détail de la traverse
Largeur de face 60 mm
Goujon à souder

Detail of transom
Width 60 mm
Welding stud

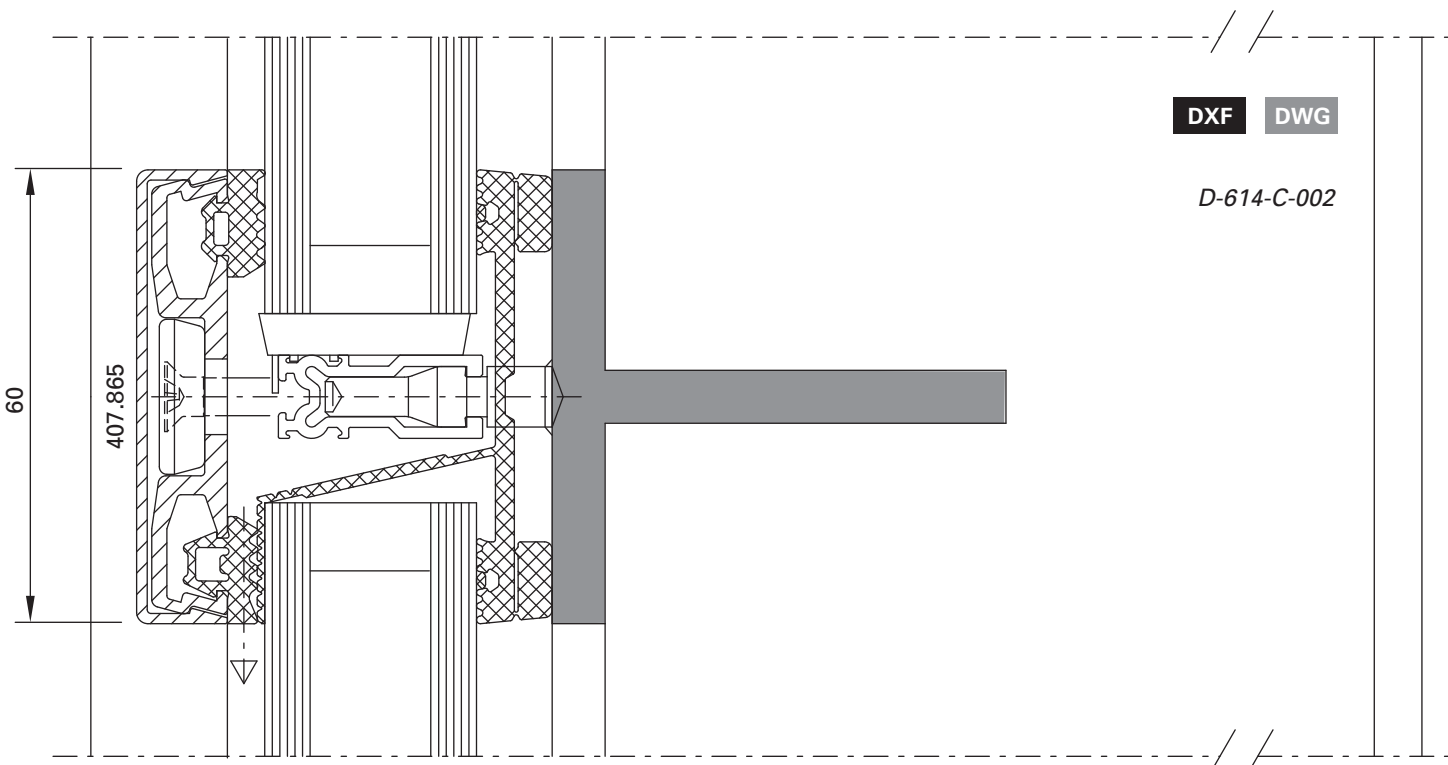

Einsatzelement
 Janisol HI Türe

Élément de remplissage
 Porte Janisol HI

Infill element
 Janisol HI door

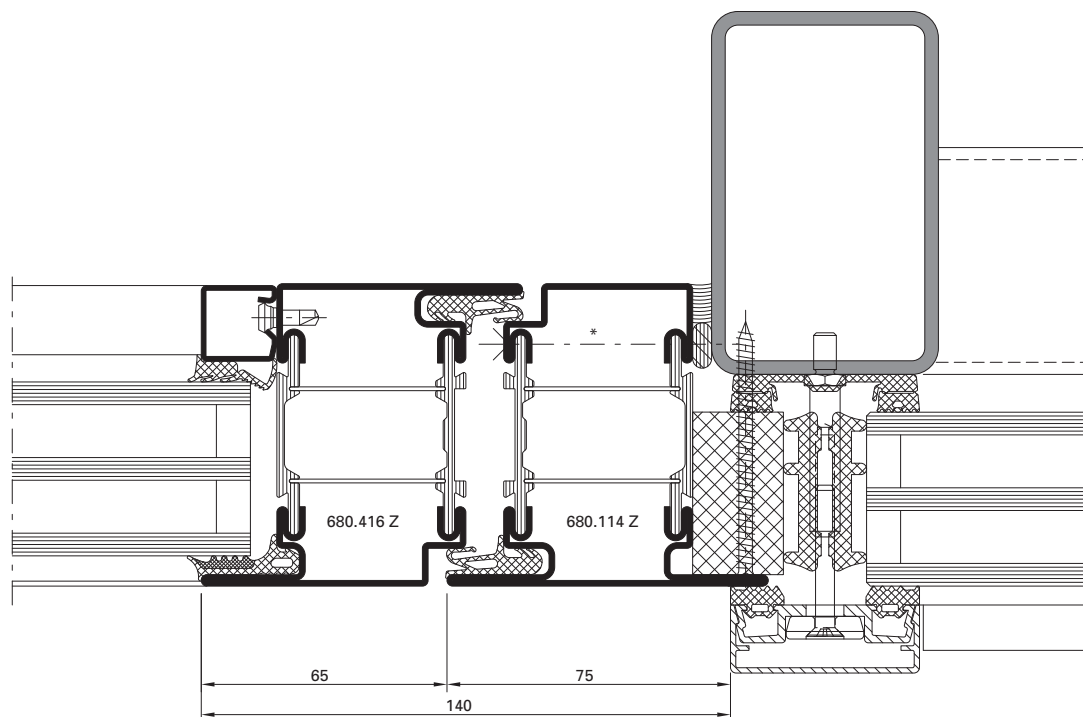

DXF DWG

D-160-A-016

Einsatzelement
 Janisol HI Fenster

Élément de remplissage
 Fenêtre Janisol HI

Infill element
 Janisol HI window

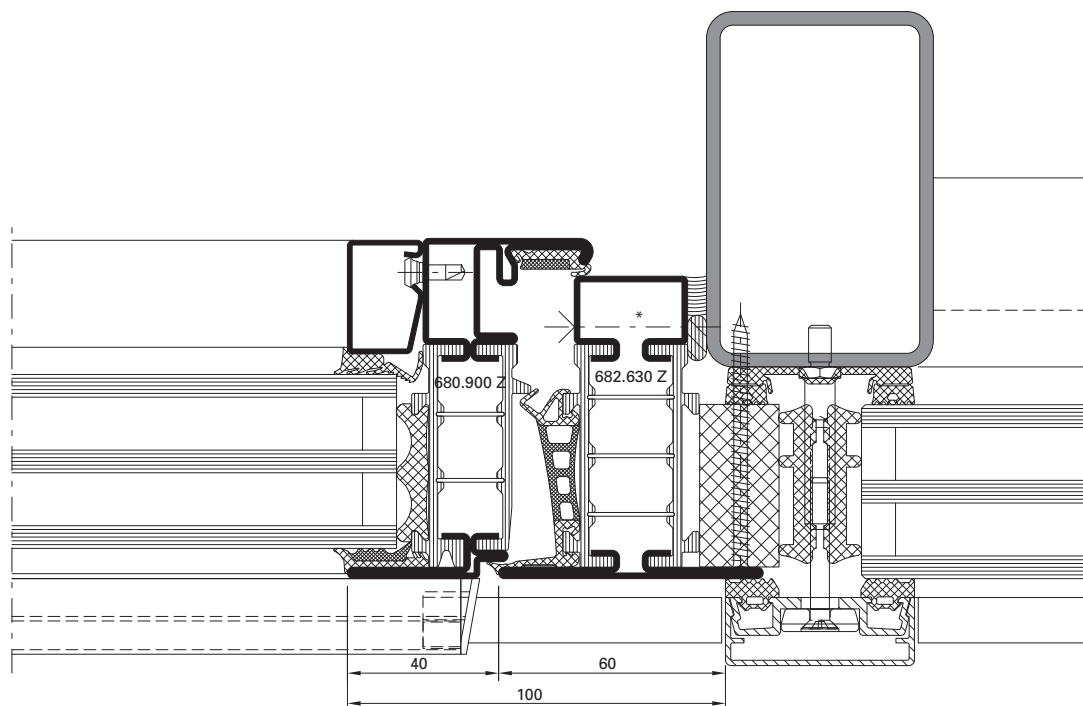

DXF DWG

D-161-A-020

* Bei grossen, schweren und/oder stark frequentierten Türanlagen ist eine zusätzliche Verschraubung im Bandbereich erforderlich.

* Pour les portes lourdes de grandes dimensions et/ou fortement fréquentées, un vissage supplémentaire au niveau des paumelles est nécessaire.

* for large heavy and/or frequently used door systems, additional screw connections are required in the hinge area.

Einsatzelement
 Janisol Türe

Élément de remplissage
 Porte Janisol

Infill element
 Janisol door

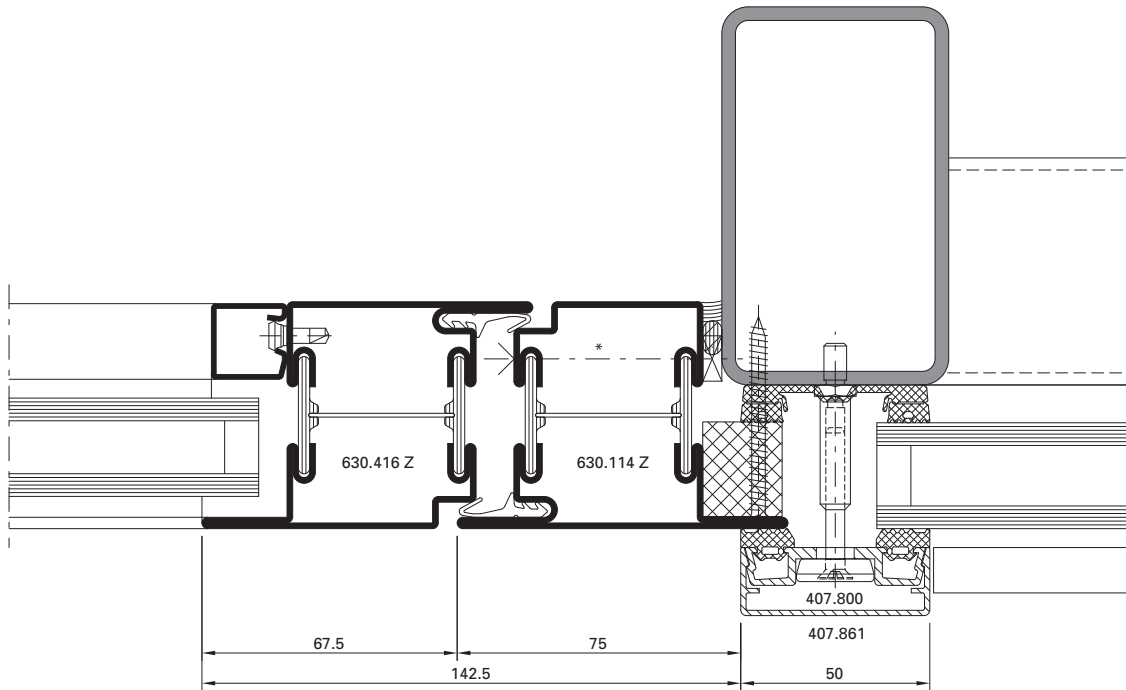

DXF DWG

D-512-K-001

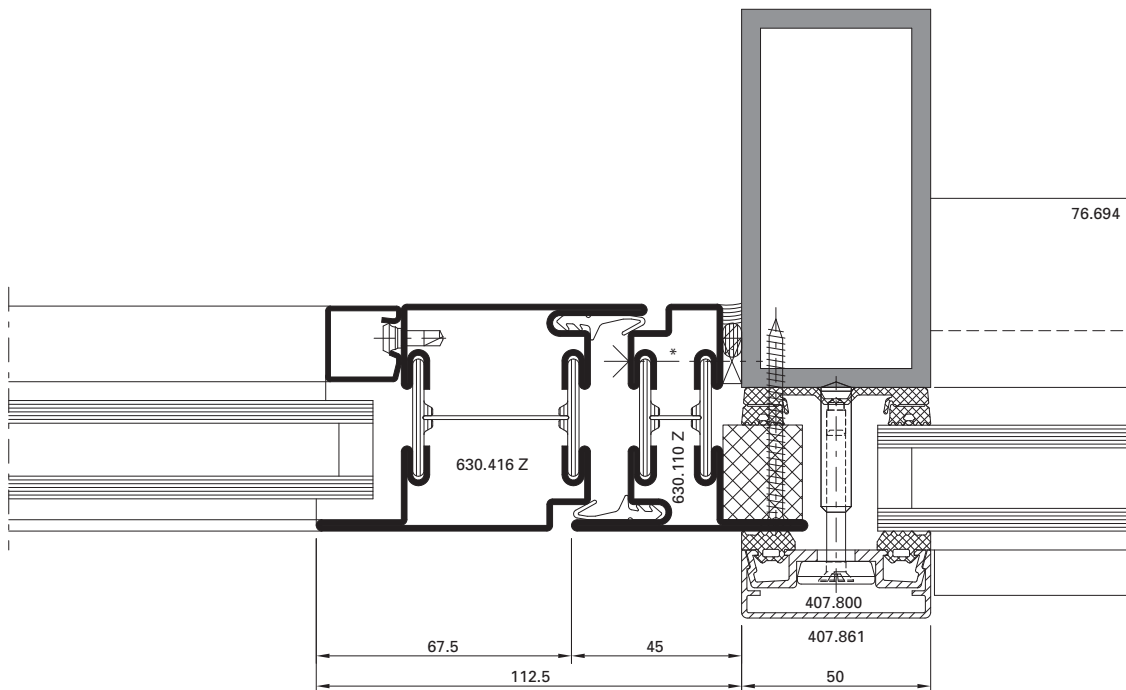

DXF DWG

D-514-K-002

* Bei grossen, schweren und/oder stark frequentierten Türanlagen ist eine zusätzliche Verschraubung im Bandbereich erforderlich.

* Pour les portes lourdes de grandes dimensions et/ou fortement fréquentées, un vissage supplémentaire au niveau des paumelles est nécessaire.

* for large heavy and/or frequently used door systems, additional screw connections are required in the hinge area.

Einsatzelement Fenster
 Janisol Primo

Elément de remplissage
 Janisol Primo

Infill element
 Janisol Primo

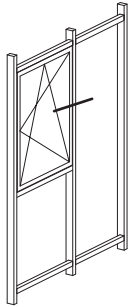
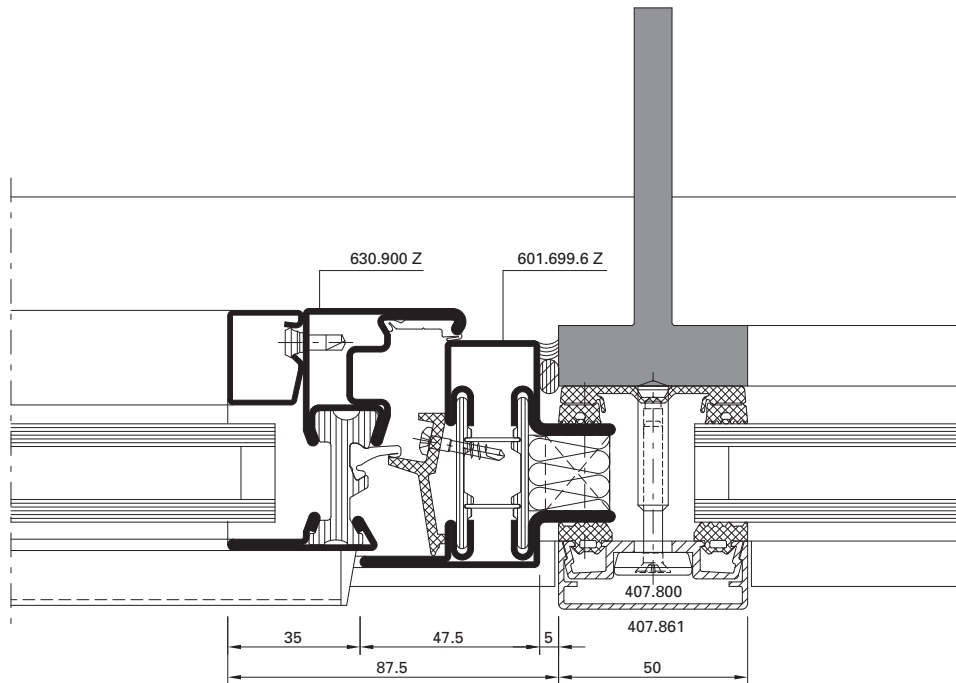

DXF **DWG**

D-514-K-001

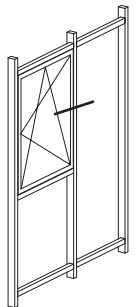
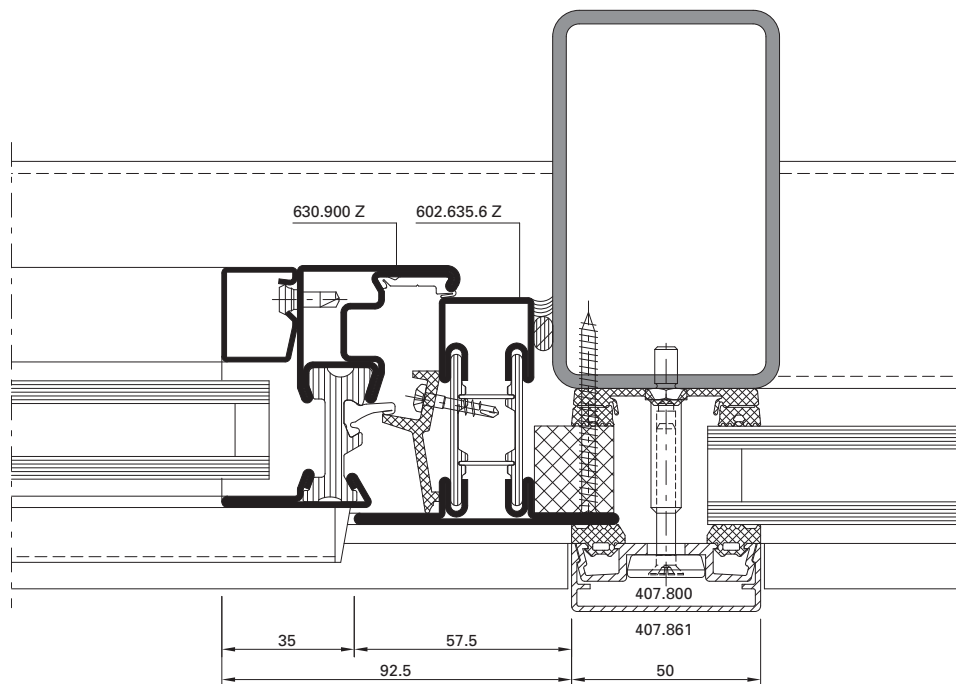

DXF **DWG**

D-512-K-002

Aussenecke 90°

Angle extérieur 90°

Outer corner 90°

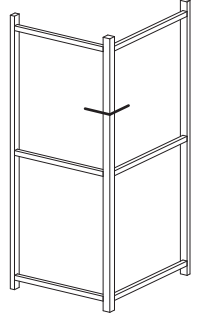
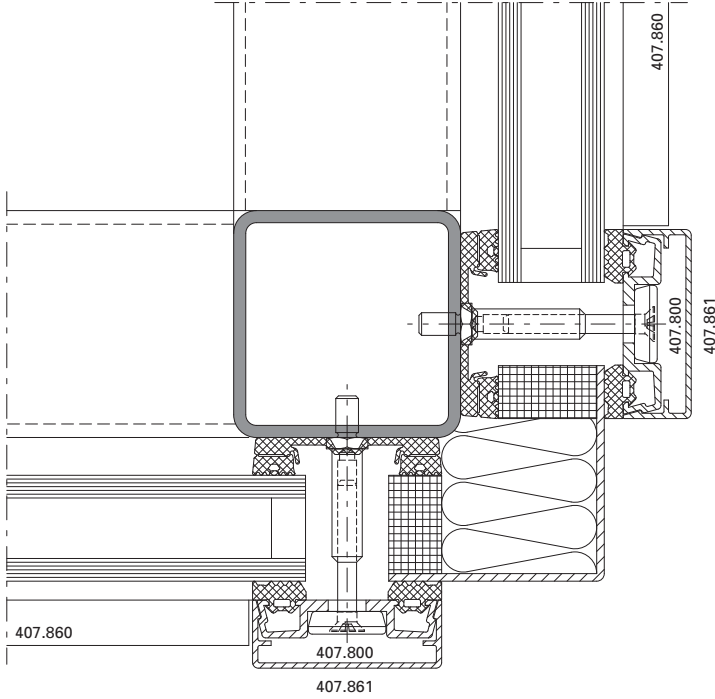

DXF DWG

D-512-K-004

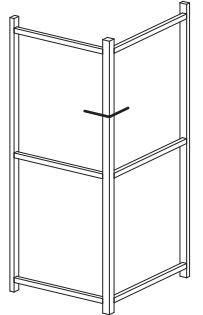
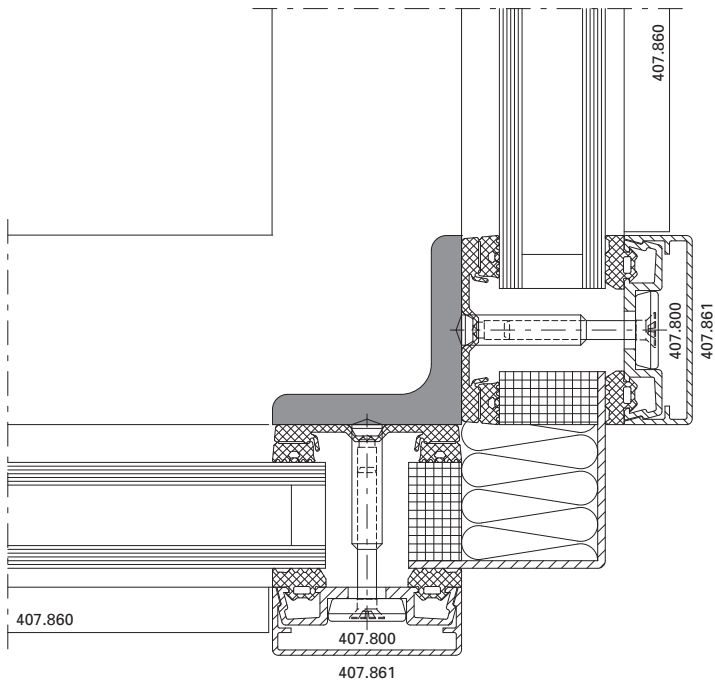

DXF DWG

D-514-K-003

Aussenecke 135°

Angle extérieur 135°

Outer corner 135°

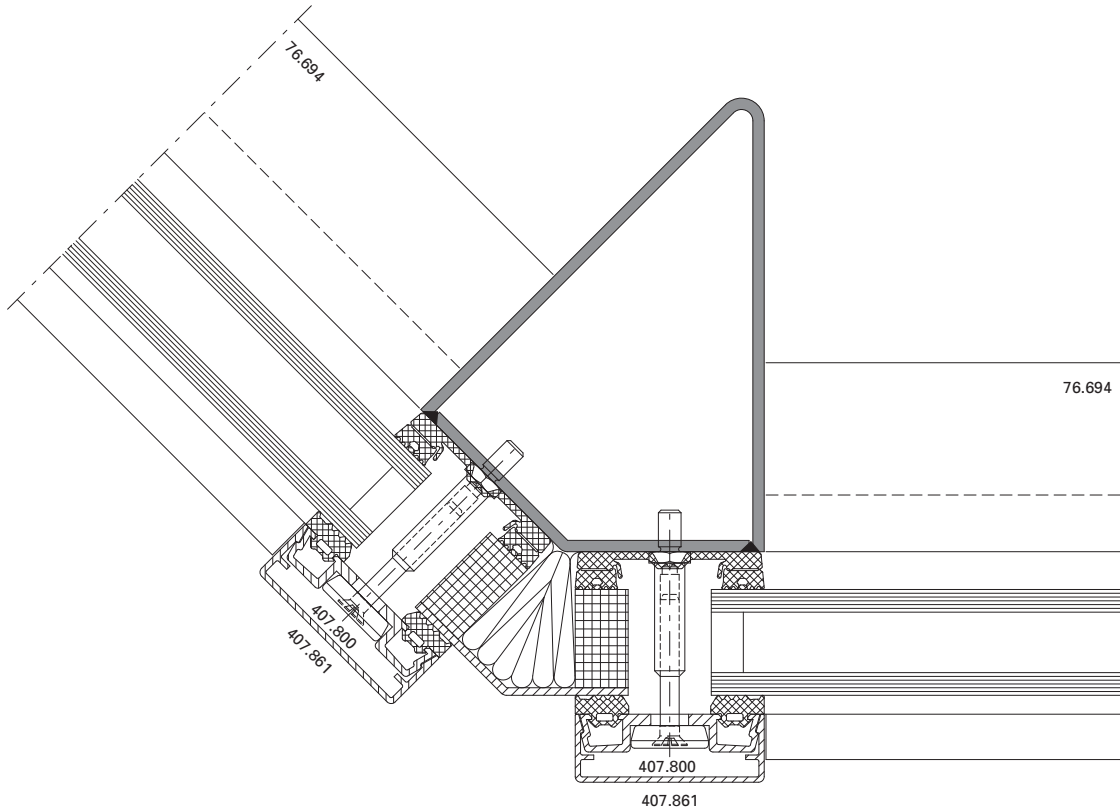

DXF DWG

D-512-K-003

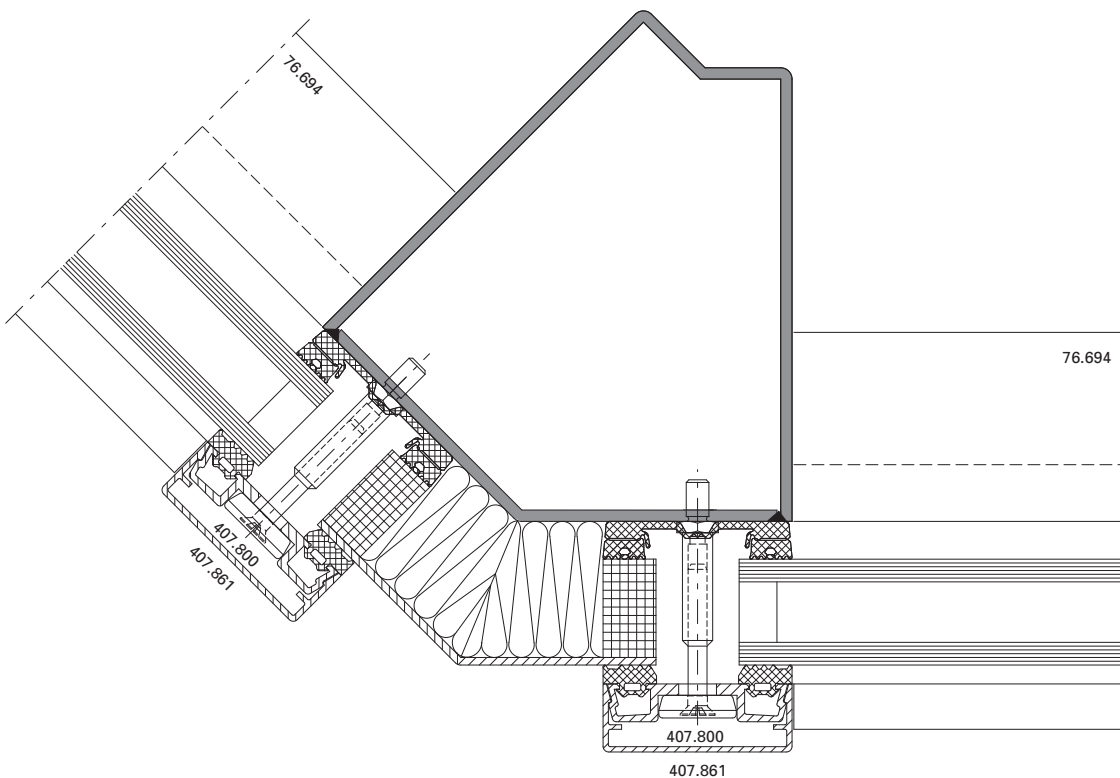

DXF DWG

D-512-K-005

VISS I_xtra
 Varianten T-Verbindungen

VISS I_xtra
 Variantes raccords en T

VISS I_xtra
 Alternatives connecting spigots

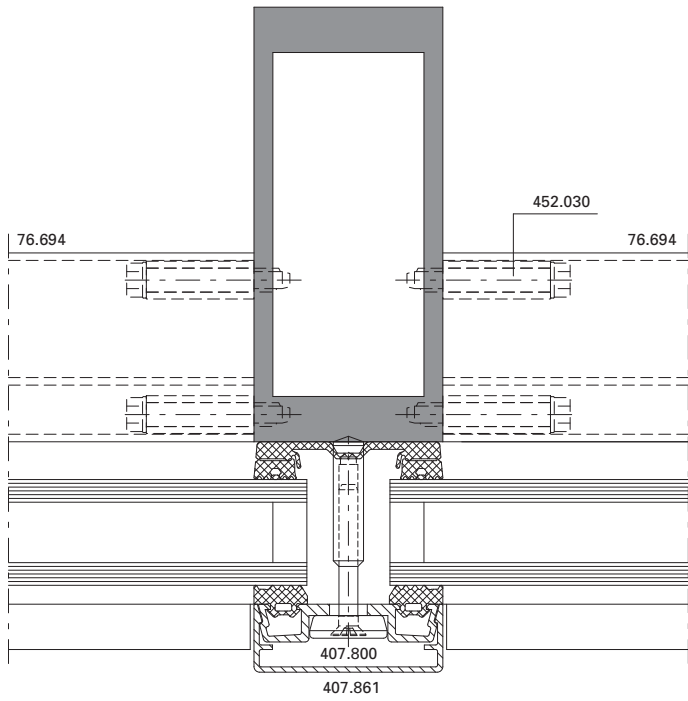

DXF DWG D-516-K-007

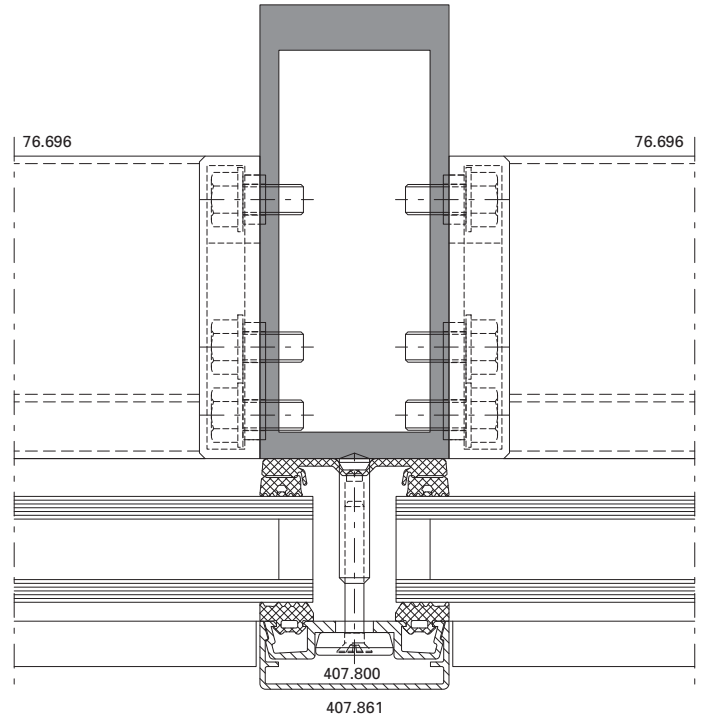

DXF DWG D-516-K-015

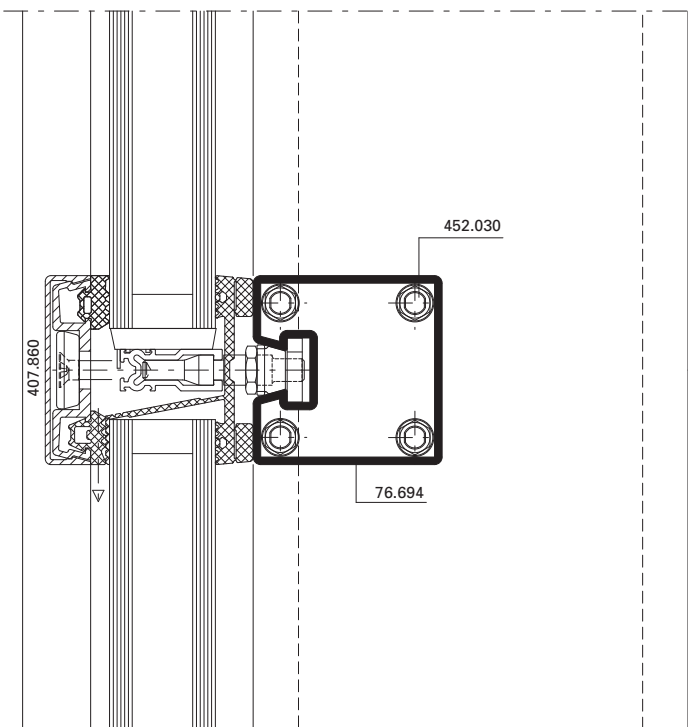

DXF DWG D-516-K-008

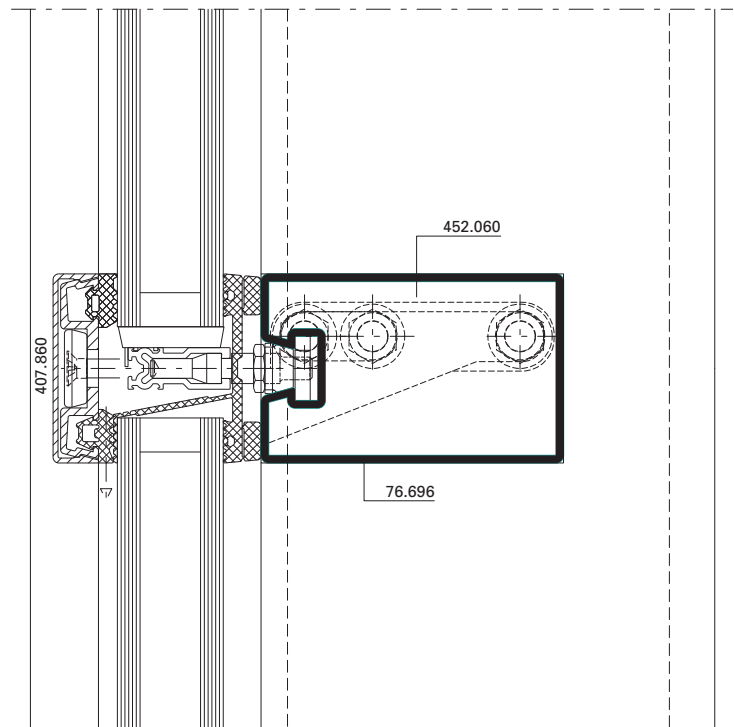

DXF DWG D-516-K-016

VISS I_xtra
 Varianten T-Verbindungen

VISS I_xtra
 Variantes raccords en T

VISS I_xtra
 Alternatives connecting spigots

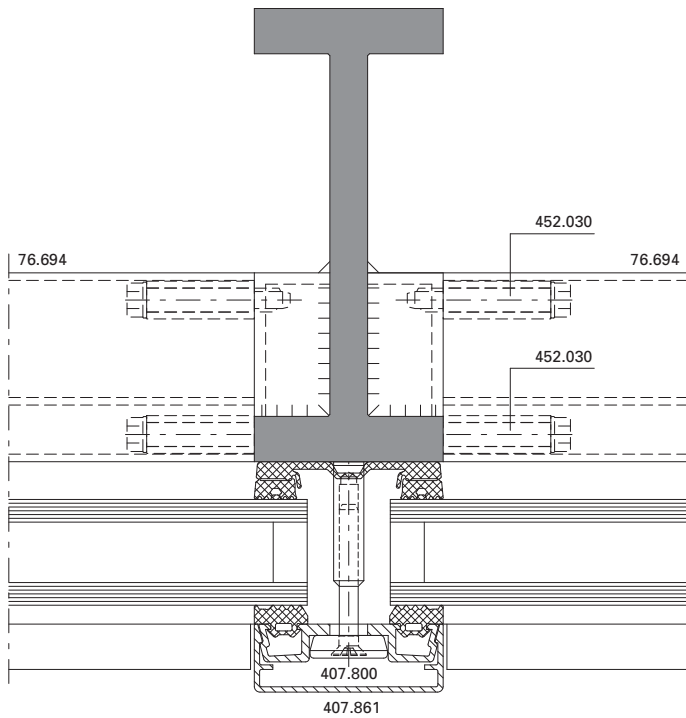

DXF **DWG** D-516-K-001

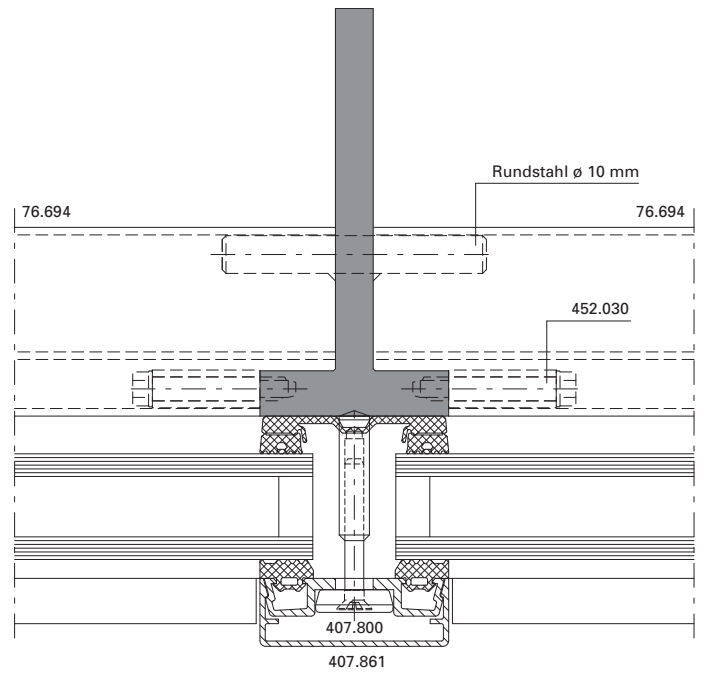

DXF **DWG** D-516-K-003

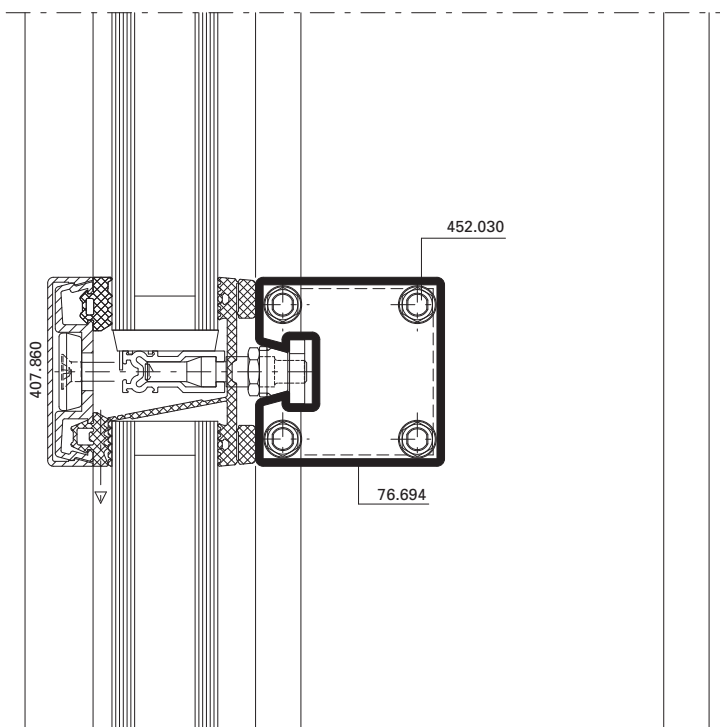

DXF **DWG** D-516-K-002

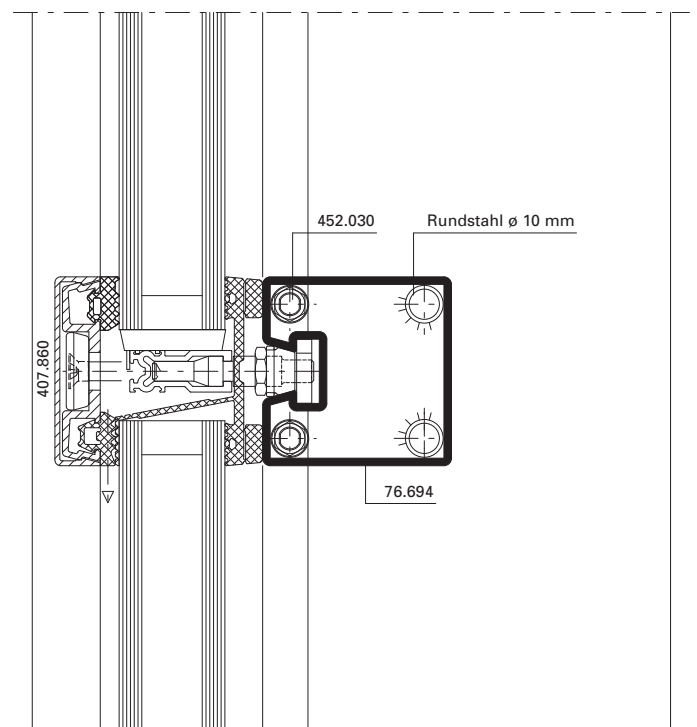

DXF **DWG** D-516-K-004

VISS I_xtra
 Varianten T-Verbindungen*

VISS I_xtra
 Variantes raccords en T*

VISS I_xtra
 Alternatives connecting spigots*

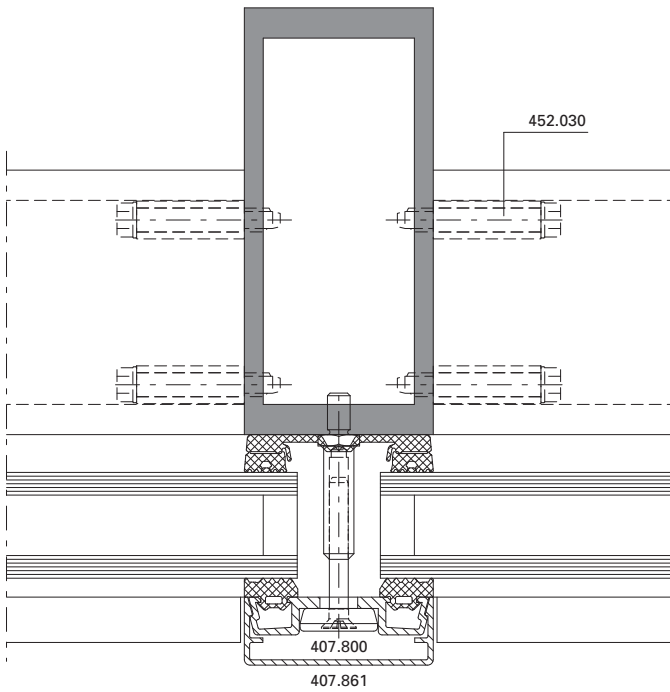

DXF DWG D-516-K-013

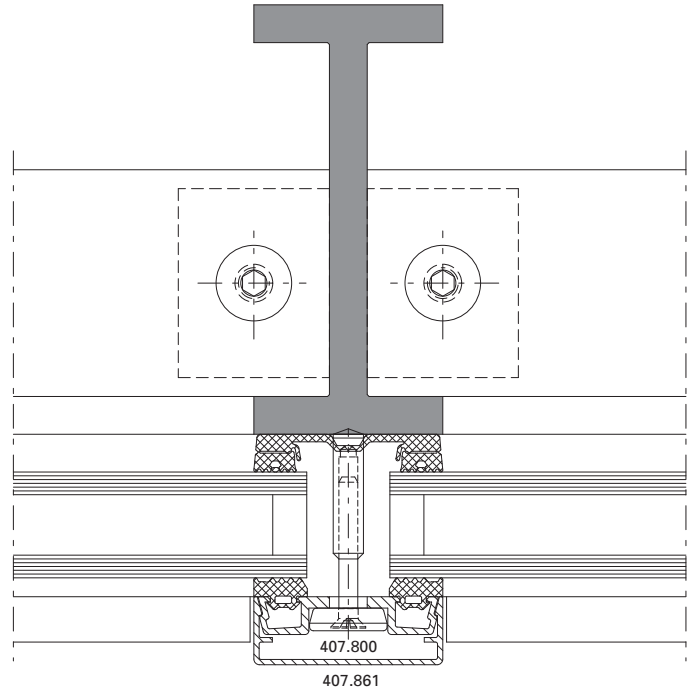

DXF DWG D-516-K-009

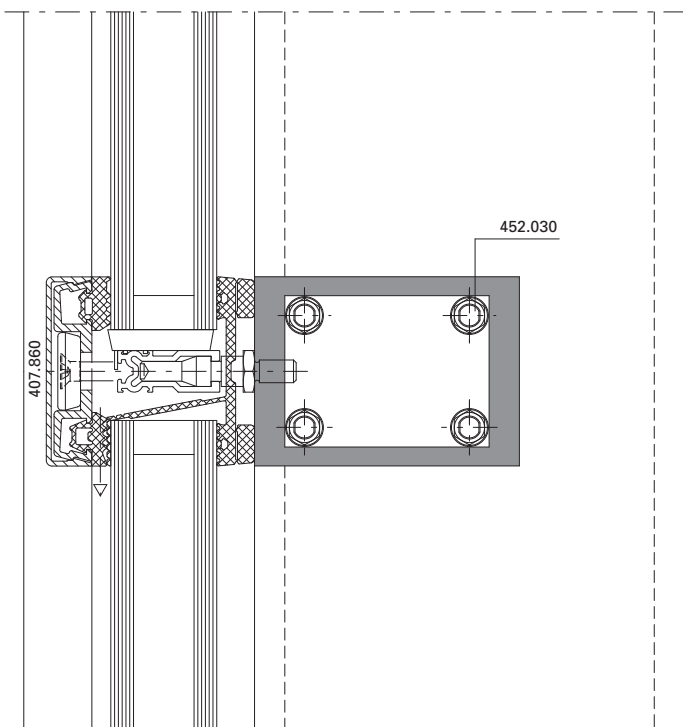

DXF DWG D-516-K-014

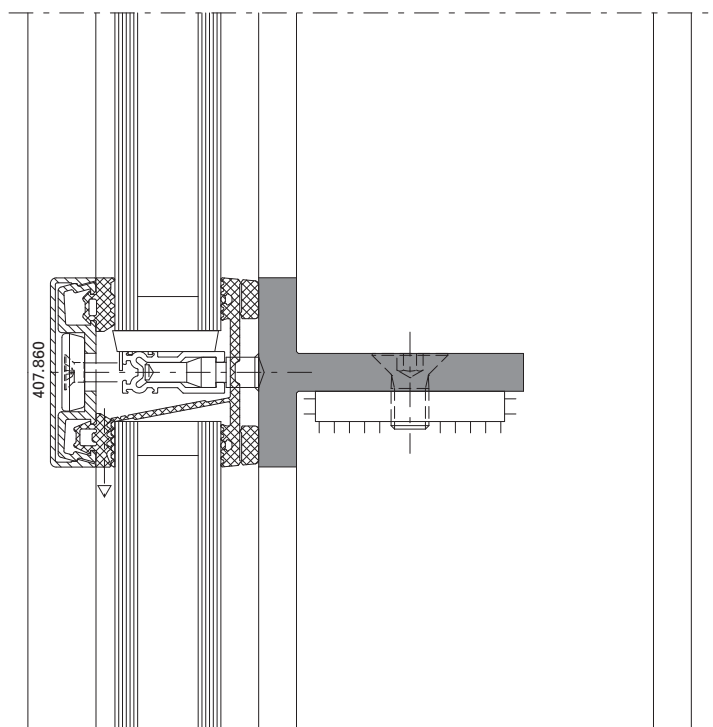

DXF DWG D-516-K-010

VISS I_xtra
Varianten T-Verbindungen*

VISS I_xtra
Variantes raccords en T*

VISS I_xtra
Alternatives connecting spigots*

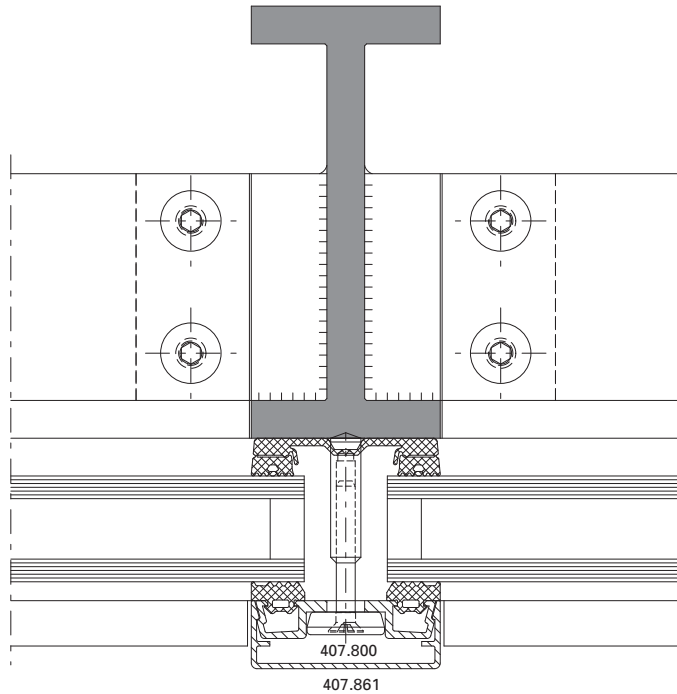

DXF

DWG

D-516-K-011

* Sonderkonstruktion
(durch Metallbauer zu fertigen)

* Construction spéciale
(à fabriquer par le métallier)

* Special construction
(to made by metal constructor)

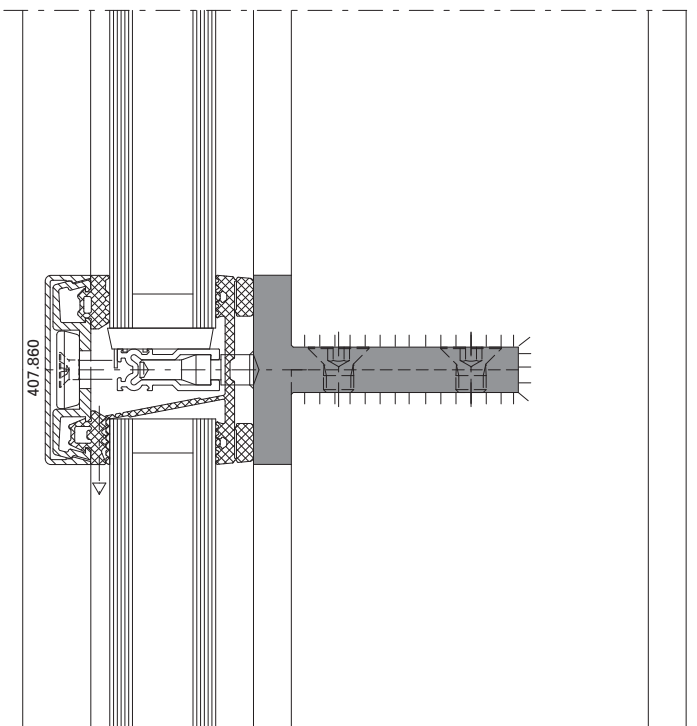

DXF

DWG

D-516-K-012

Anschlüsse am Bau im Massstab 1:2
Raccords au mur à l'échelle 1:2
Attachment to structure on scale 1:2

VISS Basic Fassade
VISS Basic façade
VISS Basic façade

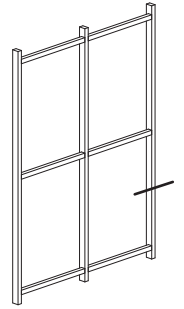
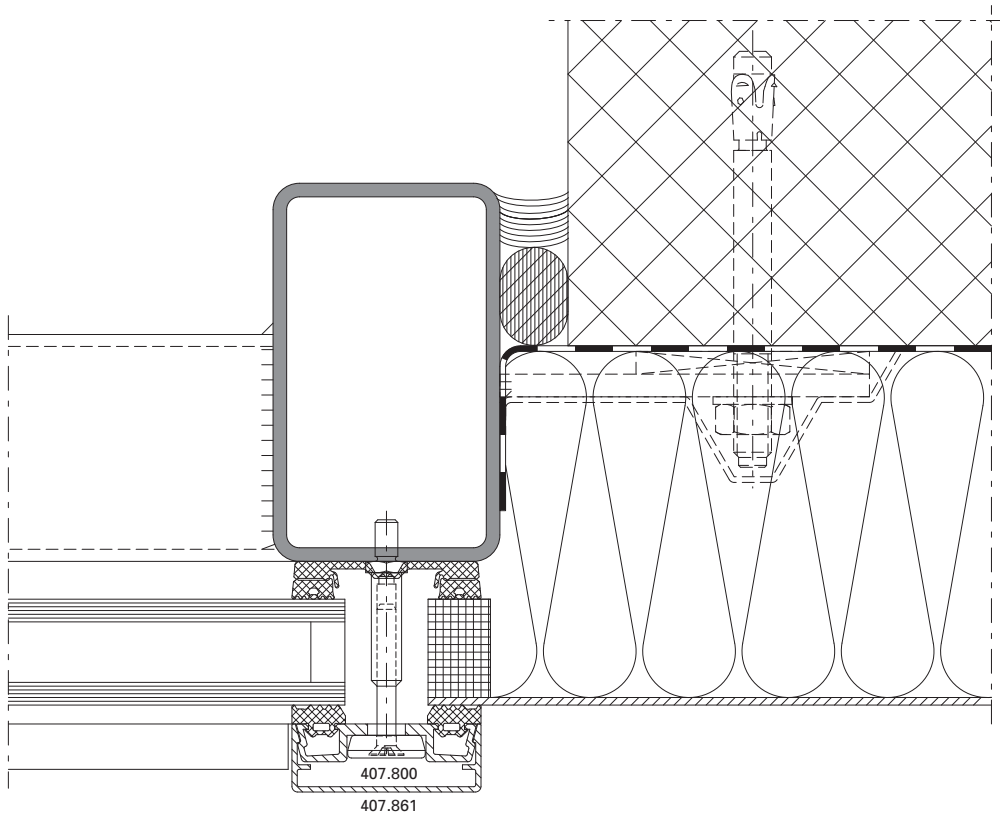

DXF DWG

D-512-A-001

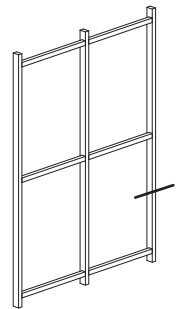
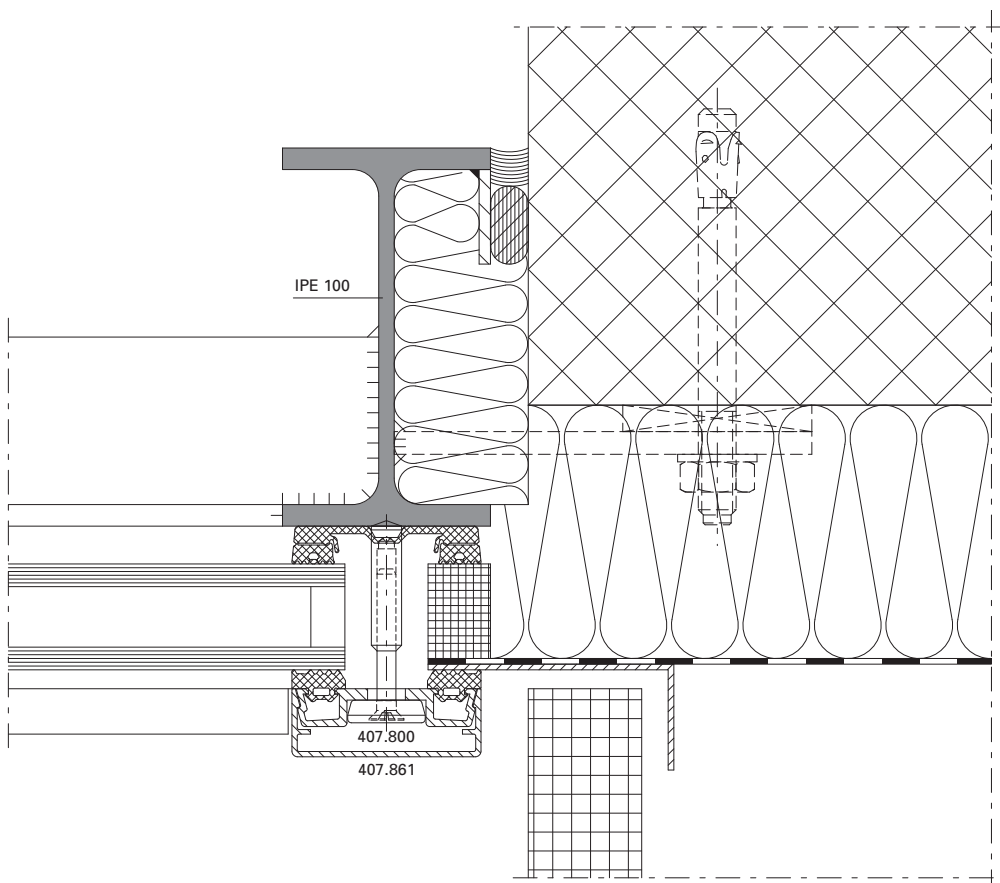

DXF DWG

D-514-A-002

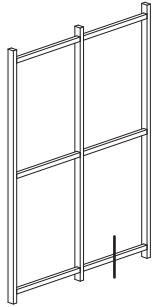
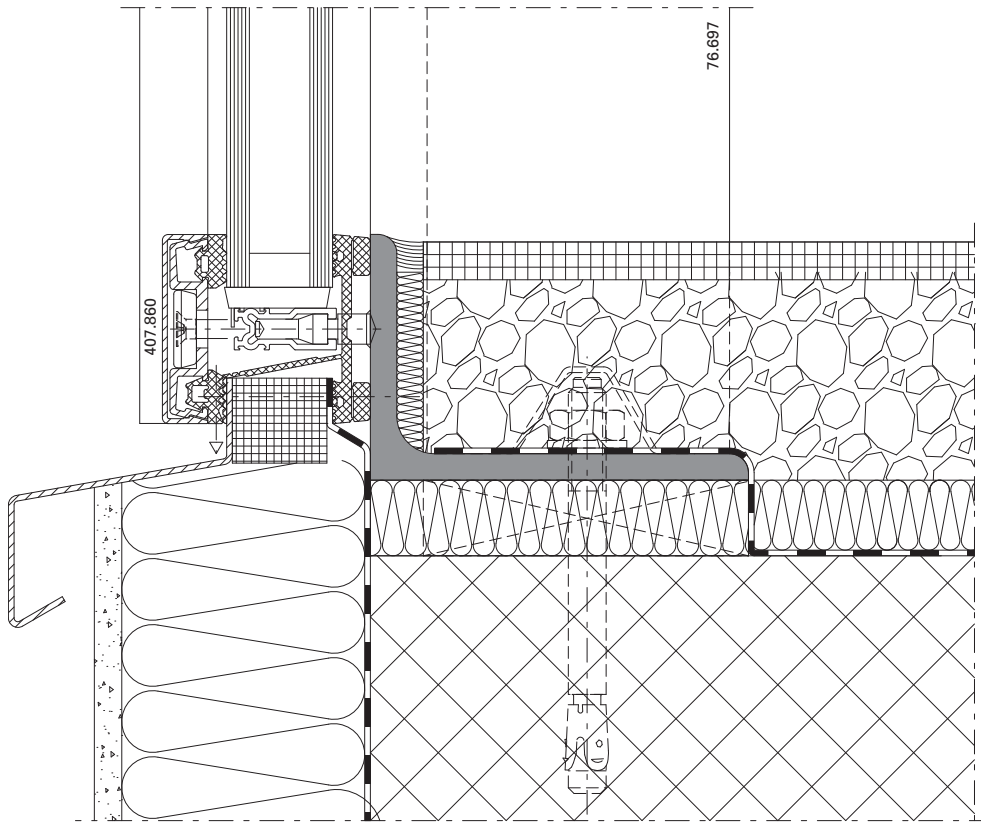

DXF DWG

D-514-A-001

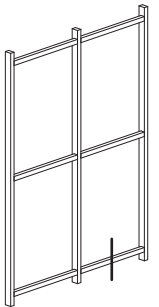
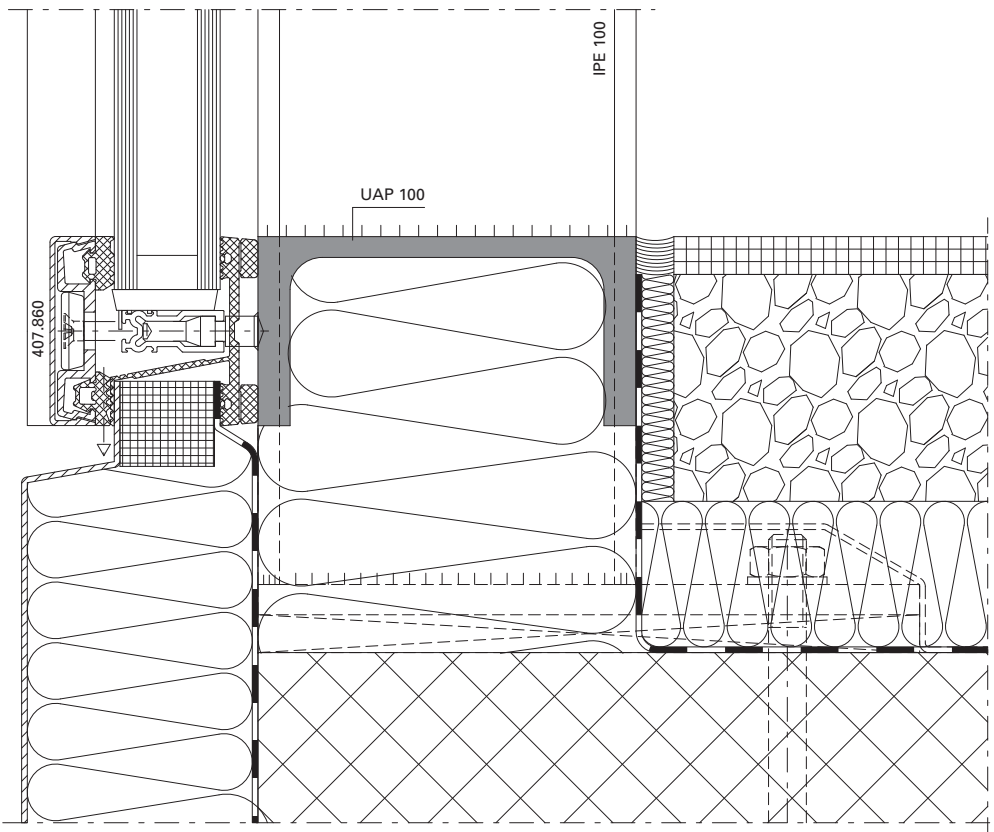

DXF DWG

D-514-A-003

Anschlüsse am Bau im Massstab 1:2
Raccords au mur à l'échelle 1:2
Attachment to structure on scale 1:2

VISS Basic Fassade
VISS Basic façade
VISS Basic façade

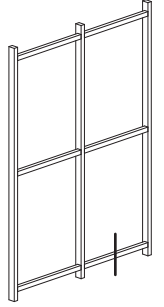
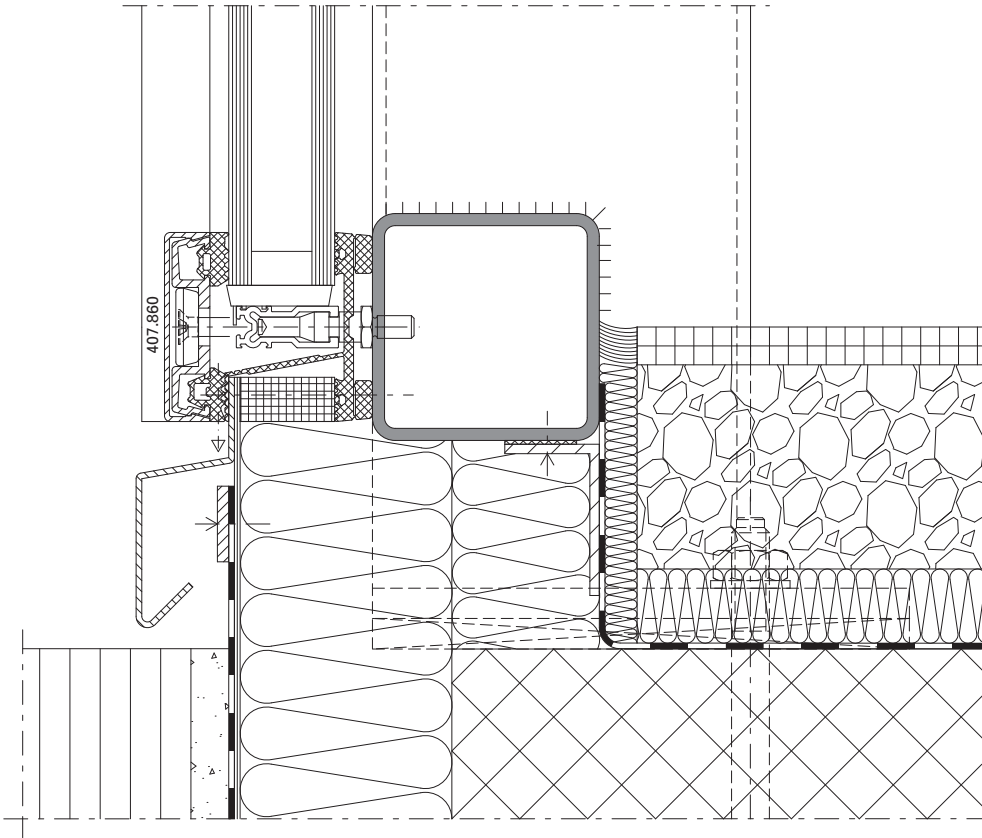

DXF DWG

D-512-A-003

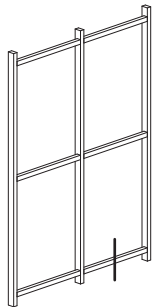
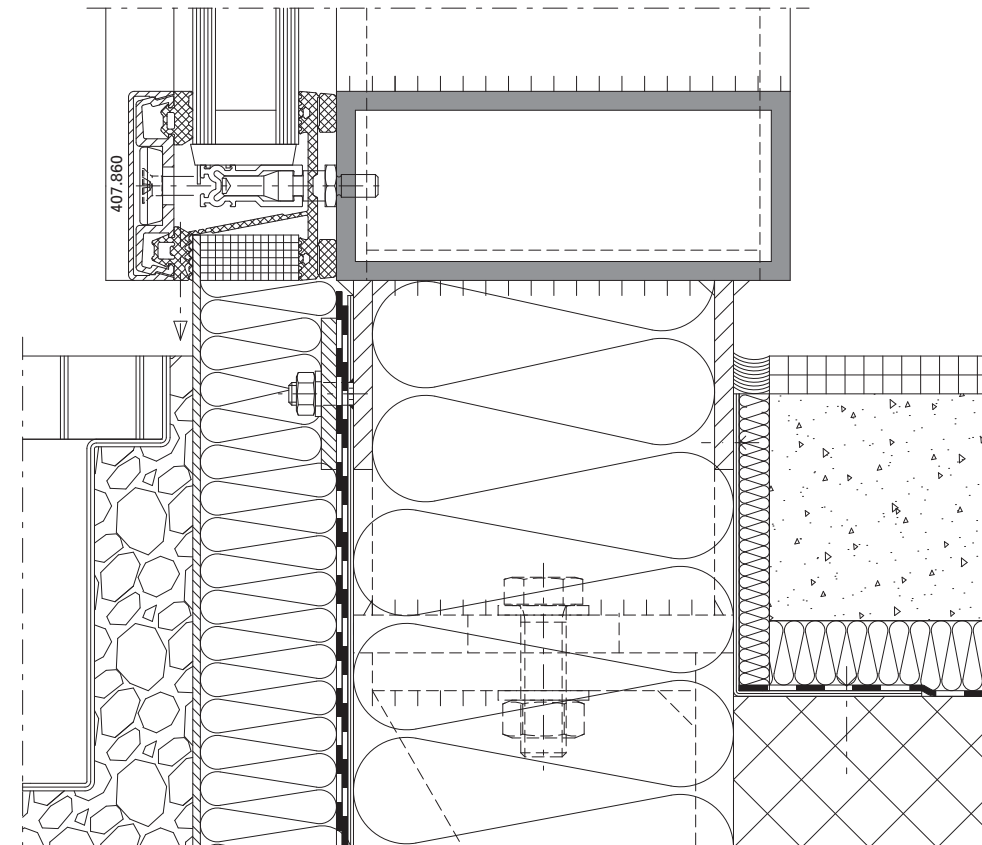

DXF DWG

D-512-A-004

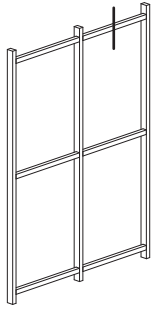
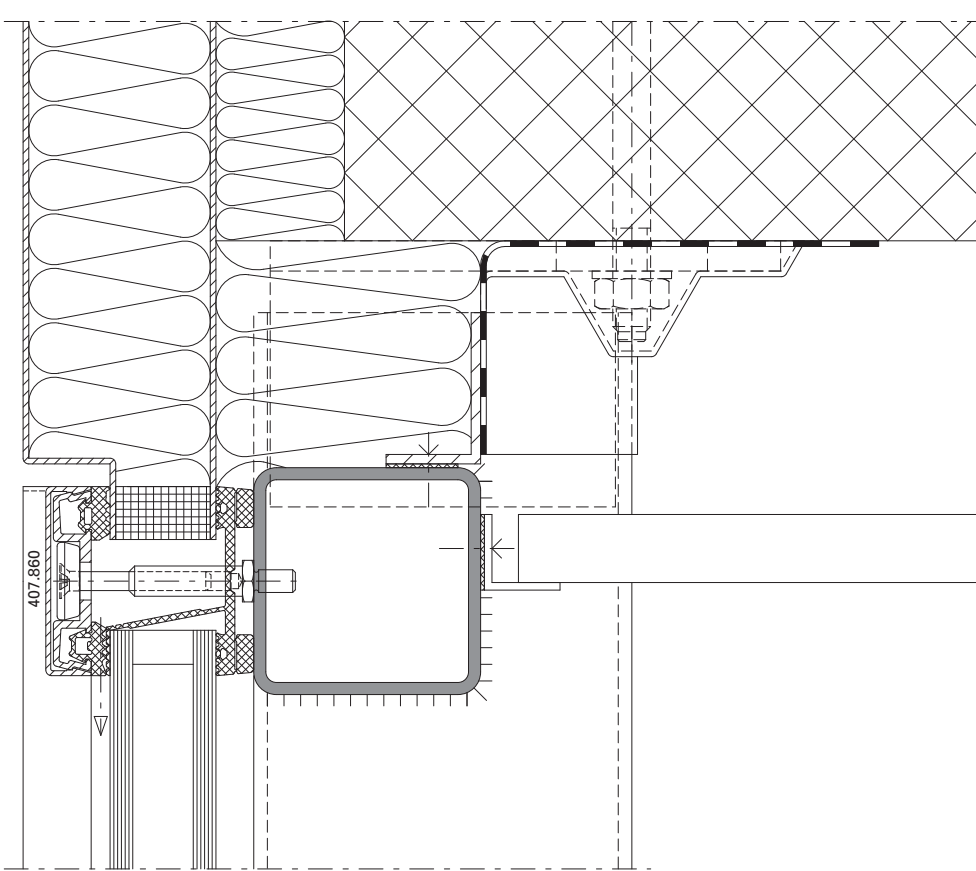

DXF DWG

D-512-A-002

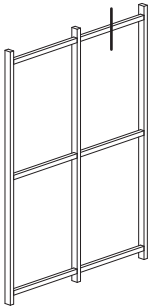
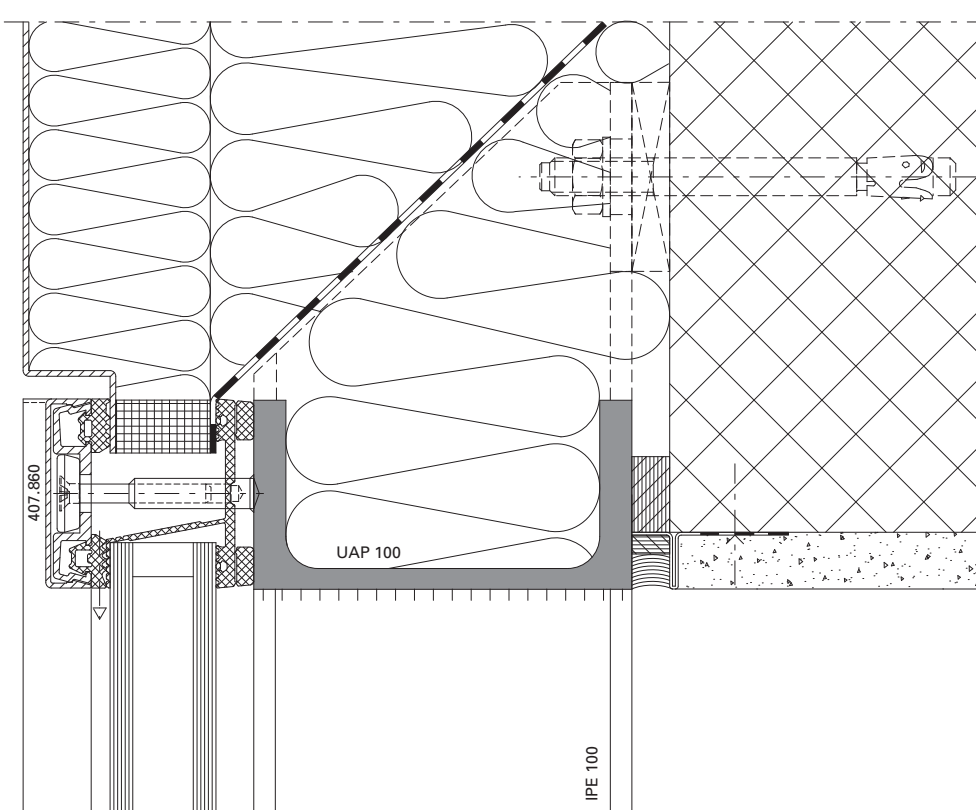

DXF DWG

D-514-A-004