

① 2x

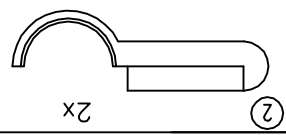

② 2x

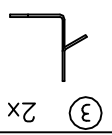

③ 2x

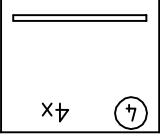

④ 4x

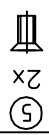

⑤ 2x

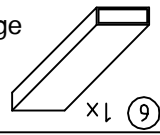

⑥ 1x

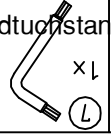

⑦ 1x

Handtuofstange

Montageanleitung
 Mounting instruction
 Guide de pose
 Istruzione di montaggio
 655 05 368
 07.05.2003, Rev.1
 MMU

() x A = L	4 x A	182
	5 x A	228
	6 x A	274
	7 x A	320
	8 x A	366
	9 x A	412
	10 x A	458
	11 x A	504
	12 x A	550
	13 x A	596
	14 x A	642
	15 x A	688
	16 x A	734
	17 x A	780
	18 x A	826
	19 x A	872
	20 x A	918

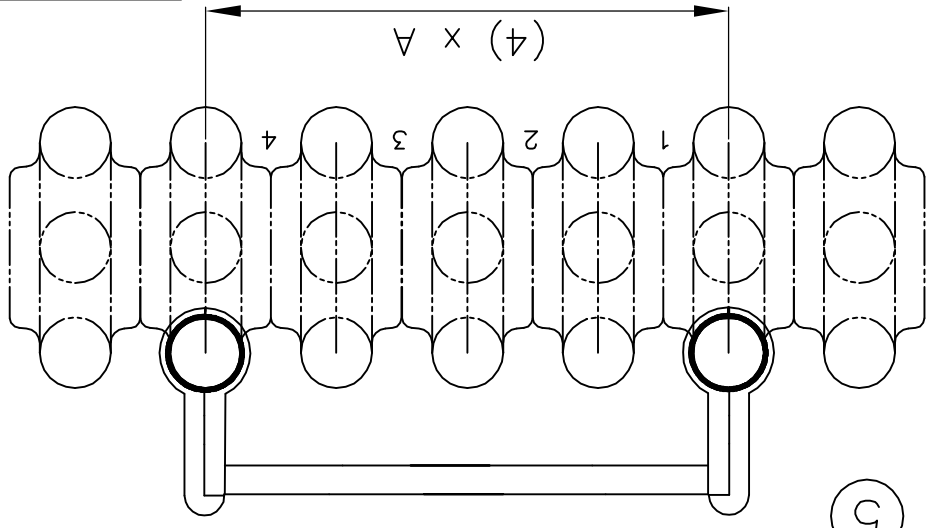

Beispiel / Example / Exemple / Esempio

⑤

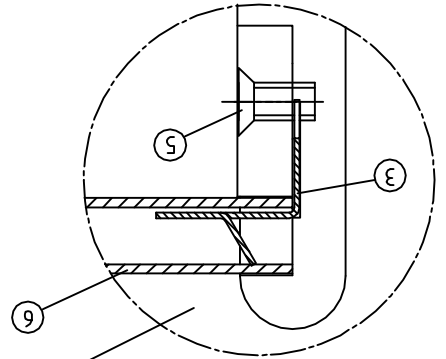
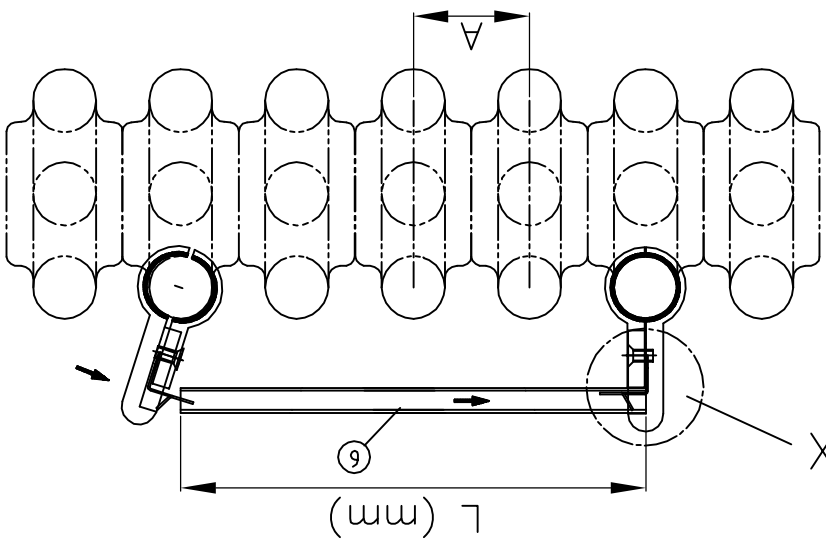

④

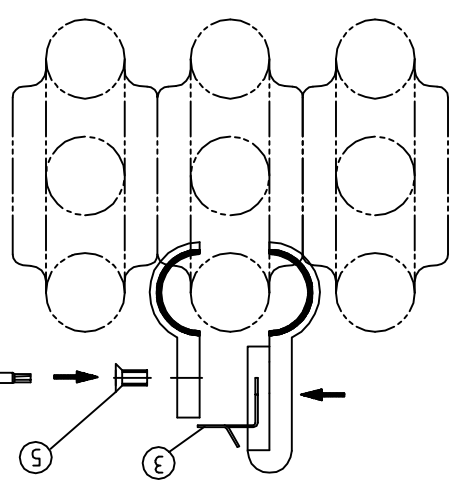

②

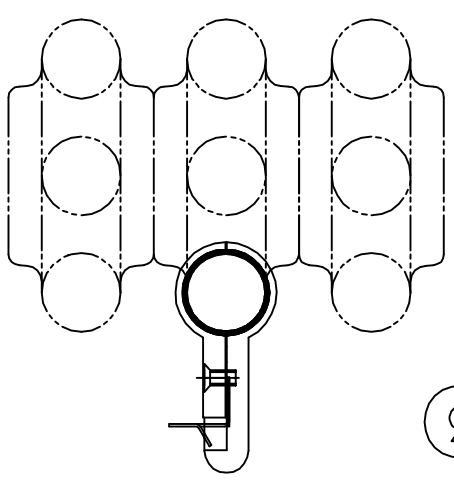

③

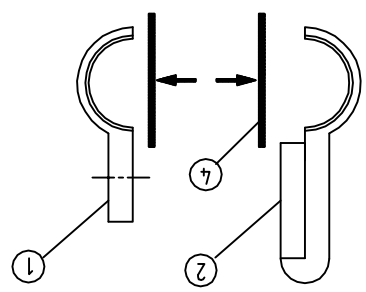

①

