

INSTALLATION MANUAL

MONTAGEANLEITUNG
INSTRUCTIONS DE MONTAGE
ISTRUZIONI PER IL MONTAGGIO

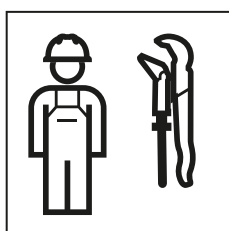



WARNUNG

Unsachgemässe Montage

Herabfallen des Produkts kann zu schweren Verletzungen führen.

- ▶ Vor der Montage die Tragfähigkeit der Wand prüfen.
- ▶ Vor der Montage prüfen, ob das Befestigungsmaterial für den Wandtyp geeignet ist.



WARNING

Incorrect installation

If the product falls, it can cause serious injuries.

- ▶ Before installation, check the bearing capacity of the wall.
- ▶ Before installation, check whether the fastening material is suitable for the wall type.



AVERTISSEMENT

Montage inapproprié

La chute du produit peut entraîner des blessures graves.

- ▶ Avant le montage, contrôler la capacité portante de la paroi.
- ▶ Contrôler avant le montage que le matériel de fixation est adapté au type de paroi.



AVVERTENZA

Montaggio improprio

La caduta del prodotto può provocare gravi lesioni.

- ▶ Testare la capacità di carico della parete prima del montaggio.
- ▶ Prima del montaggio, controllare che il materiale di fissaggio sia adatto al tipo di parete.



WAARSCHUWING

Ondeskundige montage

Het eraf vallen van het product kan tot ernstig letsel leiden.

- ▶ Vóór de montage het draagvermogen van de wand controleren.
- ▶ Vóór de montage controleren, of het bevestigingsmateriaal voor het wandtype geschikt is.



ADVERTENCIA

Montaje inadecuado

La caída del producto puede ocasionar lesiones graves.

- ▶ Antes del montaje, comprobar la capacidad de carga de la pared.
- ▶ Antes del montaje, comprobar si el material de fijación es el apropiado para el tipo de pared.



AVISO

Montagem incorreta

A queda do produto pode provocar ferimentos graves.

- ▶ Verificar a capacidade de carga da parede antes da montagem.
- ▶ Antes da montagem, verificar se o material de fixação é adequado para o tipo de parede.



ADVARSEL

Uhensigtsmæssig montering

Hvis produktet falder ned, kan det føre til alvorlige kvæstelser.

- ▶ Kontroller væggens bæreevne inden monteringen.
- ▶ Kontroller inden monteringen, om det fastgørelsesmateriale er egnet til vægtypen.



ADVARSEL

Ufagmessig montering

Hvis produktet faller ned, kan det føre til alvorlige personskader.

- ▶ Kontroller bæreevnen til veggen før monteringen.
- ▶ Kontroller før monteringen om det festematerialet egner seg for veggtypen.



VARNING

Felaktig montering

Om produkten faller ned kan den orsaka allvarliga personskador.

- ▶ Kontrollera väggens bärförmåga före monteringen.
- ▶ Kontrollera före monteringen om det infästningsmaterialet lämpar sig för veggtypen.



VAROITUS

Epäsianmukainen asennus

Tuotteen putoaminen voi aiheuttaa vakavia vammoja.

- ▶ Tarkasta ennen asennusta seinän kantavuus.
- ▶ Tarkasta ennen asentamista, sopiiko kiinnitysmateriaali seinän tyyppiin.



VIÐVÖRUN

Ekki farið rétt að við uppsetningu

Ef varan fellur niður getur það valdið alvarlegum meiðslum.

- ▶ Kanna skal burðargetu veggs áður en uppsetning fer fram.
- ▶ Ganga skal úr skugga um að festibúnaður henti fyrir vegginn áður en uppsetning fer fram.



OSTRZEŻENIE

Nieprawidłowy montaż

Spadnięcie produktu może skutkować ciężkimi obrażeniami.

- ▶ Przed montażem sprawdzić nośność ściany.
- ▶ Przed montażem sprawdzić, czy elementy mocujące są odpowiednie do danego typu ściany.



FIGYELMEZTETÉS

Szakszerűtlen szerelés

A termék leesése súlyos sérüléseket okozhat.

- ▶ Szerelés előtt ellenőrizze a fal teherbíró képességét.
- ▶ Szerelés előtt ellenőrizze, hogy a rögzítési anyag megfelelő-e a faltípushoz.



VAROVANIE

Neodborná montáž

Spadnutie výrobku môže viesť k ťažkým zraneniam.

- ▶ Pred montážou skontrolujte nosnosť steny.
- ▶ Pred montážou skontrolujte, či prípevňovací materiál je vhodný pre príslušný typ skrine.



VÝSTRAHA

Nesprávná montáž

Pád výrobku může způsobit vážné úrazy.

- ▶ Před montáží zkontrolujte nosnost zdi.
- ▶ Před montáží zkontrolujte, zda je upevňovací materiál vhodný pro daný typ zdi.



OPOZORILO

Nestrokovna montaža

Posledica padca izdelka so lahko težke poškodbe.

- ▶ Pred montažo preverite nosilnost stene.
- ▶ Pred montažo preverite, ali je pritrdilni material primeren za tip stene.



UPOZORENJE

Nestručna montaža

Pad proizvoda može uzrokovati teške ozljede.

- ▶ Prije montaže provjerite nosivost zida.
- ▶ Prije montaže provjerite je li pričvršni materijal prikladan za tip zida.



UPOZORENJE

Nestručna montaža

Padanje proizvoda može da dovede do teških povreda.

- ▶ Pre montaže ispitati nosivost zida.
- ▶ Pre montaže ispitati da li je materijal za pričvršćenje pogodan za vrstu zida.



HOIATUS

Asjatundmatu montaaž

Toote allakukkumine võib põhjustada raskeid vigastusi.

- ▶ Enne paigaldamist kontrollige seina kandevõimet.
- ▶ Enne paigaldamist kontrollige, kas kinnitusmaterjal sobib seina tüübiga.



BRĪDINĀJUMS

Nelietpratīga montāža

Produkta nokrišana var izraisīt smagas traumas.

- ▶ Pirms montāžas pārbaudiet sienas nestspēju.
- ▶ Pirms montāžas pārbaudiet, vai stiprinājuma materiāls ir piemērots sienas tipam.



ĮSPĖJIMAS

Netinkamas montavimas

Produkto nukritimas gali sukelti sunkių sužalojimų.

- ▶ Prieš montuodami patikrinkite sienos patvarumą.
- ▶ Prieš montuodami patikrinkite, ar kartu tvirtinimo priemonė tinka tokiam sienos tipui.



ПРЕДУПРЕЖДЕНИЕ

Неправилен монтаж

Падането на продукта може да доведе до тежки наранявания.

- ▶ Преди монтажа проверете товароносимостта на стената.
- ▶ Преди монтажа проверете дали материалите за закрепване са подходящи за типа стена.



AVERTIZARE

Instalare necorespunzătoare

Căderea produsului poate cauza leziuni grave.

- ▶ Înainte de instalare, verificați capacitatea portantă a peretelui.
- ▶ Înainte de instalare, verificați dacă materialul de fixare este adecvat pentru tipul de perete.



ΠΡΟΕΙΔΟΠΟΙΗΣΗ

Λανθασμένη εγκατάσταση

Η πτώση του προϊόντος μπορεί να επιφέρει σοβαρούς τραυματισμούς.

- ▶ Πριν από την εγκατάσταση ελέγξτε τη φέρουσα ικανότητα του τοίχου.
- ▶ Πριν από την εγκατάσταση ελέγξτε αν το υλικό στερέωσης είναι κατάλληλο για τον τύπο του τοίχου.



UYARI

Hatalı Montaj

Ürünün düşürülmesi ciddi yaralanmalara yol açabilir.

- ▶ Montaj öncesinde duvarın taşıma kapasitesini kontrol ediniz.
- ▶ Montaj öncesinde birlikte sabitleme materyalinin duvar tipi için uygun olup olmadığını kontrol ediniz.



ПРЕДУПРЕЖДЕНИЕ

Неквалифицированный монтаж

Падение изделия может привести к тяжелым травмам.

- ▶ Перед монтажом проверить несущую способность стены.
- ▶ Перед монтажом проверить, подходит ли в комплект поставки крепежный материал для типа стены.



警告

不恰当的安装

产品掉落可能会导致严重伤害。

- ▶ 安装前检查墙壁的承载能力。
- ▶ 安装前检查紧固件是否适用于此类墙壁。



تحذير

التركيب غير السليم

قد يؤدي سقوط المنتج إلى حدوث إصابات خطيرة.

- ◀ قبل التركيب قم بفحص قدرة تحمل الحائط.
- ◀ قبل التركيب، تحقق مما إذا كانت مادة التثبيت مناسبة لنوع الحائط.

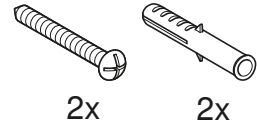
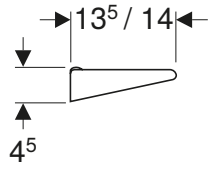
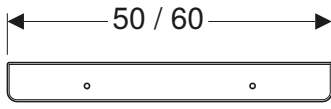



1

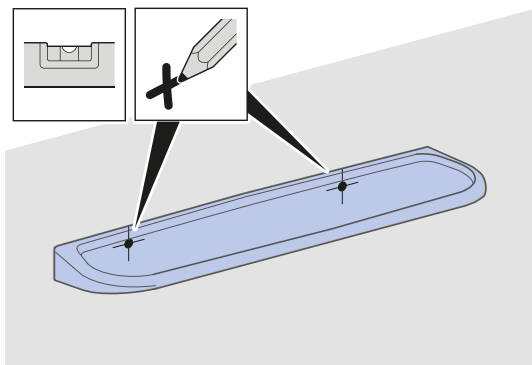

2

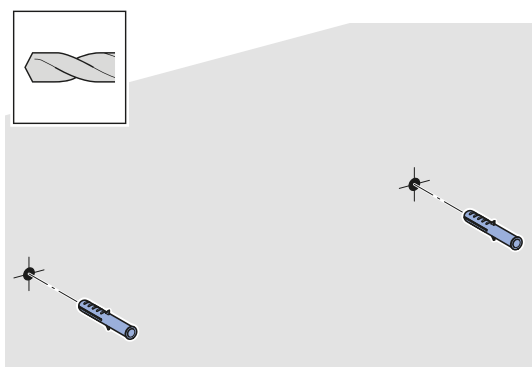

3

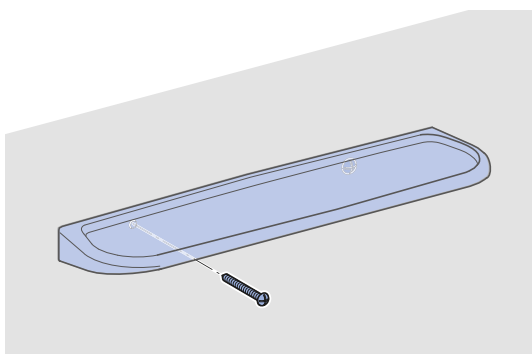

Geberit International AG
Schachenstrasse 77, CH-8645 Jona
documentation@geberit.com
www.geberit.com

