

MAINTENANCE MANUAL

INSTANDHALTUNGSANLEITUNG

MANUEL D'ENTRETIEN

ISTRUZIONI PER LA MANUTENZIONE

**KNOW
HOW**
INSTALLED



1

1

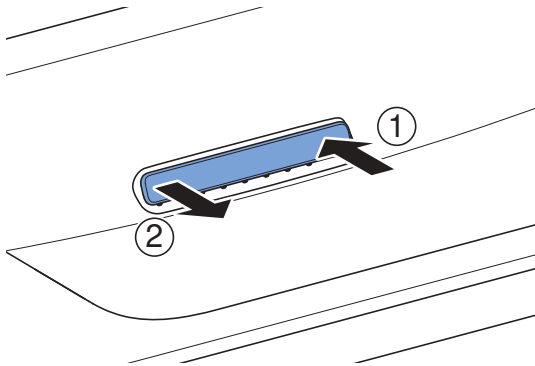

2

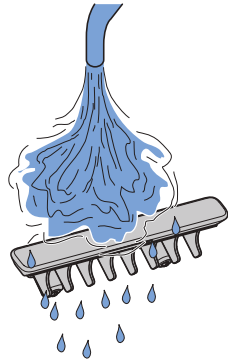

3

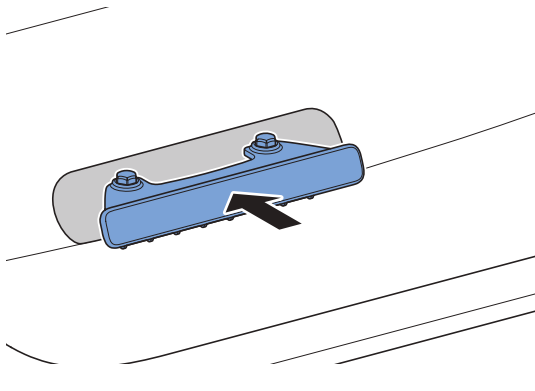

4

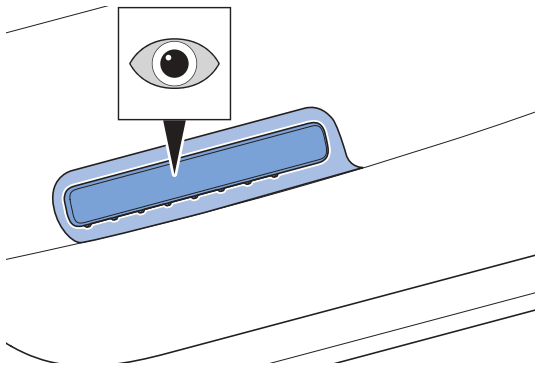

2

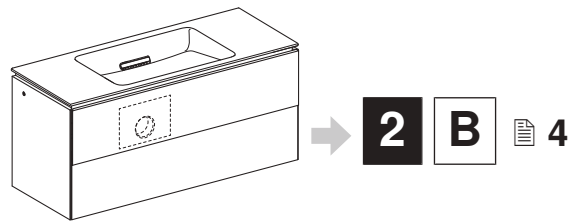
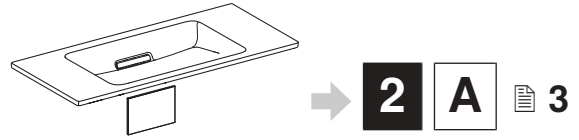

2 A

1

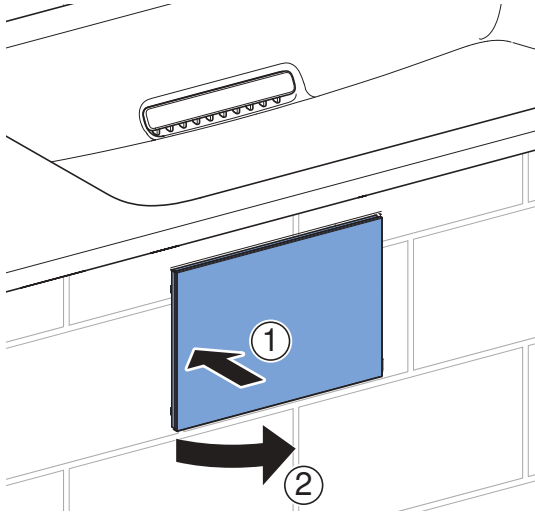

2

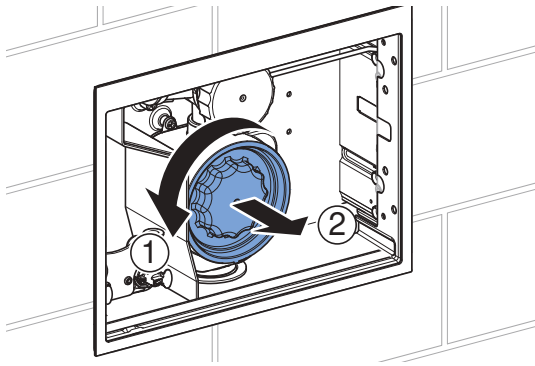

3

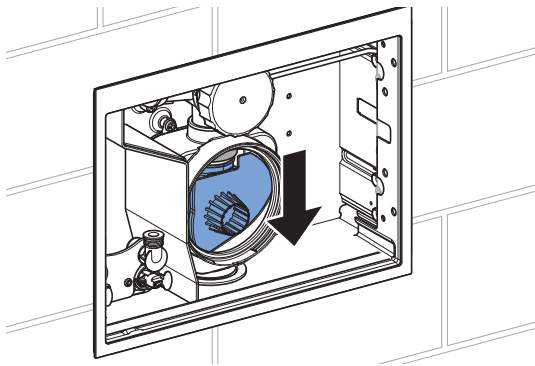

4

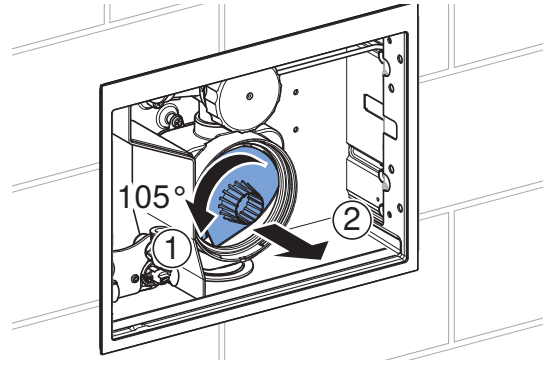

i

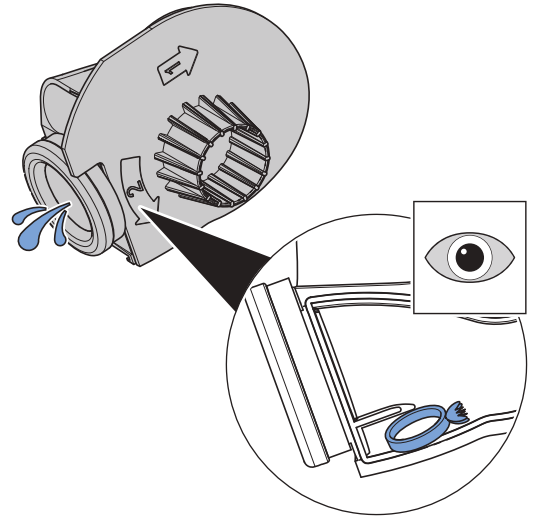

2 B

1

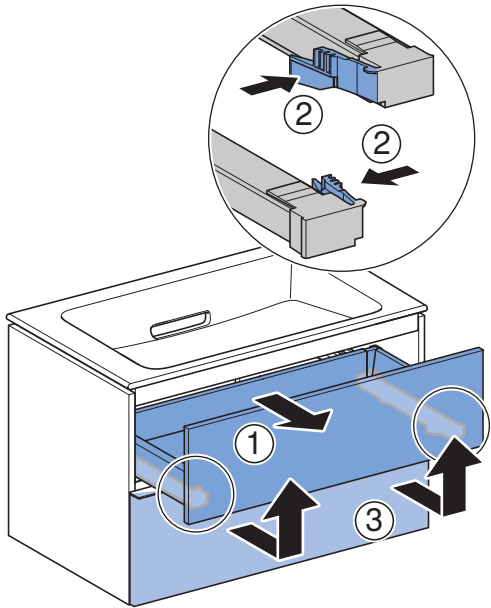

i

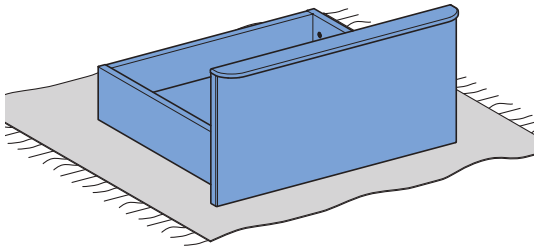

2

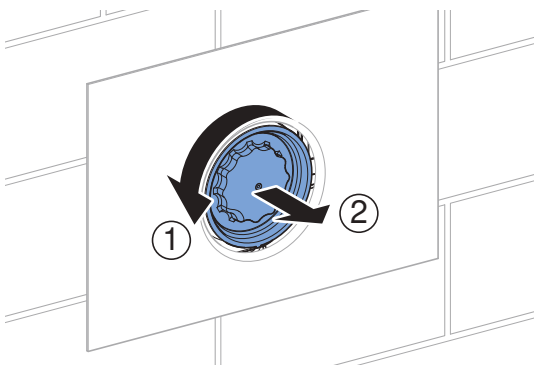

3

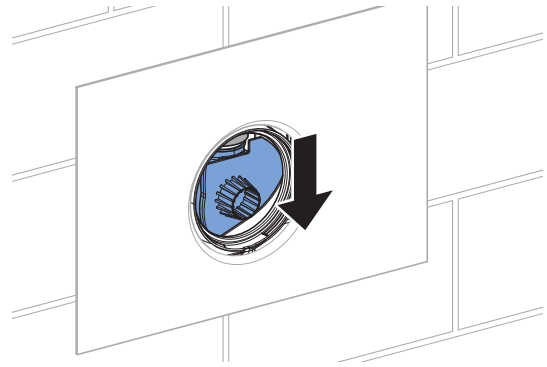

4

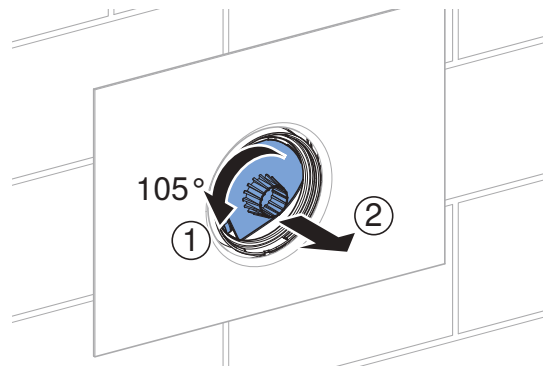

i

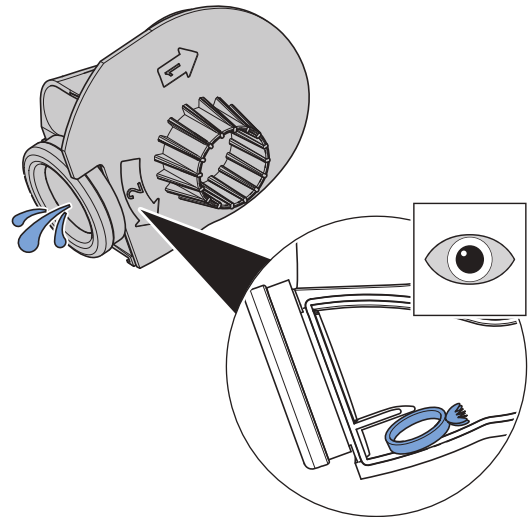

Geberit International AG
 Schachenstrasse 77, CH-8645 Jona
 documentation@geberit.com
 www.geberit.com

