

WICLINE 75
Fenstersysteme
Window systems

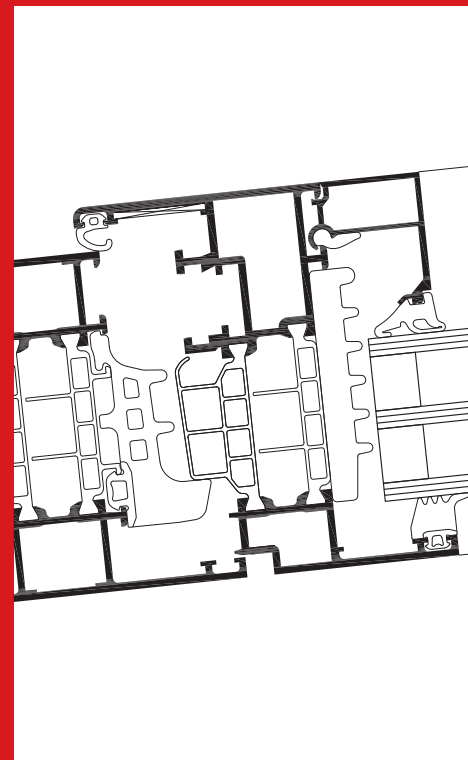

Programm 03.2015
Product range



Die in dieser Dokumentation enthaltenen Daten und Hinweise entsprechen den uns bekannten Informationen zum Zeitpunkt der Drucklegung. Eine Haftung für die hier enthaltenen Informationen ist ausgeschlossen, es sei denn, die Fehler beruhen auf Vorsatz oder grober Fahrlässigkeit seitens unseres Unternehmens.

Die in den Unterlagen dargestellten und beschriebenen Produkte und Anwendungen sind für Fachunternehmen ausgelegt. Sämtliche Beschreibungen erfolgen als Serviceleistung ohne Anerkennung von Rechtspflichten und entbinden nicht von eigener Prüfung bei der Verwendung für Zwecke des Anwenders. Branchenübliche Fachkenntnisse sowie Kenntnis des aktuellen gültigen Standes der Technik werden als bekannt vorausgesetzt und daher nicht gesondert beschrieben oder erläutert.

Die Benutzung des Markenzeichens WICONA® ist nur zulässig, sofern ausschließlich die in den jeweils gültigen WICONA-Profilprogrammen aufgenommenen Konstruktionsteile (Profile, Zubehör und Beschläge) verwendet werden. Die Echtheit der Artikel bzw. Teile und die Einheit der Konstruktion ist erkennbar durch die entsprechende Kennzeichnung bei diesen Teilen. Von Sapa Building Systems entwickelte und geprüfte WICONA-Systeme für Fassaden, Fenster und Türen erhalten mit entsprechenden Prüfungen und Prüfzeugnissen durch anerkannte Institute ihre endgültige Bestätigung. Für jeden verarbeitenden Fachbetrieb sind diese Prüfzeugnisse und Dokumentationen verpflichtende Arbeitsrichtlinien. Bei festgestellten Mängeln, die an WICONA Fassaden, -Fenstern und -Türen sichtbar werden, weil systemfremde Teile verwendet wurden, wird in diesen Fällen jede Haftung durch Sapa Building Systems ausgeschlossen. Desweiteren verlieren die attestierte Prüfzeugnisse für diese Elemente ihre Gültigkeit. Bitte beachten Sie auch die „Wichtigen Hinweise“ im Vorspann unserer Profilprogramme und Verarbeitungsrichtlinien.

Sapa Building Systems

® = eingetragene Markenzeichen
Sapa Building Systems

The data and instructions contained in this documentation correspond to the information known to us at the time of printing. There is no liability on our part for the information contained herein, unless the errors are deliberate on our part or attributable to gross negligence by our company.

The products and applications shown and described in these documents are designed for specialist companies. All descriptions are provided as a service, without admitting legal responsibility, and do not release the user from the need to check that a product or application is suitable for the particular purpose envisaged. Specialist knowledge customary in this branch of business and awareness of the latest technology are assumed and consequently are not separately described or explained.

Use of the trademark WICONA® is permitted only if the structural parts included in the applicable WICONA profile programmes (profiles, accessories and fittings) are exclusively used. The genuineness of the items or parts and the uniformity of the design is identifiable by the corresponding markings on these parts. WICONA systems developed and tested by Sapa Building Systems for facades, windows and doors are ultimately qualified by the appropriate tests and test certificates from recognised institutes. Each processing company is subject to these test certificates and documentation as mandatory work guideline specifications. Sapa Building Systems is not liable for any defects visible on WICONA facades, windows and doors and attributable to the use of parts not belonging to the system or to a lack of maintenance of these products. The corresponding test certificates also lose their validity for these items. Please also note the "Important indications" in the opening sections of our profile programmes and processing guideline specifications.

Sapa Building Systems

® = registered trademarks
Sapa Building Systems

1 Technischer Vorspann / *Technical Prefix*

Nummernverzeichnis, Wichtige Hinweise, Wichtige Hinweise zum Beschlag, Öffnungsarten, Symbole und Hinweise, Technische Informationen
Numerical index, Important indications, Important indications on fittings, Opening types, Symbols and indications, Technical Information

Vorspann
Prefix

2 WICLINE 75 TOP

Serienbeschreibung, Profilübersicht, Profile sichtbarer Flügel / verdeckter Flügel, Anwendungsbeispiele, Glasleistenprofile - Auswahltabellen, Zulässige Flügelgrößen, Zulässige Formatgrößen, Beschlagsübersichten
Description of series, Survey of profiles, Profiles visible sash / concealed sash, Examples of application, Glazing bead profiles - Selection tables, Admissible sash sizes, Admissible format sizes, Survey of fittings

WICLINE 75
TOP

3 WICLINE 75 evo

Serienbeschreibung, Profilübersicht, Profile sichtbarer Flügel / verdeckter Flügel, Anwendungsbeispiele, Glasleistenprofile - Auswahltabellen, Zulässige Flügelgrößen, Zulässige Formatgrößen, Beschlagsübersichten
Description of series, Survey of profiles, Profiles visible sash / concealed sash, Examples of application, Glazing bead profiles - Selection tables, Admissible sash sizes, Admissible format sizes, Survey of fittings

WICLINE 75
evo

4 Profile universell / *Profiles universal*

Glasleistenprofile, Zusatzprofile, Eckwinkelprofile
Glazing bead profiles, Additional profiles, Corner angle profiles

Profile universell
Profiles universal

5 Zubehör / *Accessories*

Zubehörübersicht, Dichtungen Meterware, Dichtungen Stückware, Kunststoffprofile / Formstücke, Eckwinkel / Blechteile, Verbinder, Verbindungselemente, Verschiedenes, Schrauben-Tabellen
Survey of accessories, Gaskets metre ware, Gaskets single parts, Plastic profiles / moulded pieces, Corner angles / Metal sheet parts, Butt joint connectors, Connecting components, Miscellaneous, Screw tables

Zubehör
Accessories

6 Beschläge / *Fittings*

Beschläge für Fenster / *Fittings for windows*

Beschläge
Fittings

7 Werkzeuge / *Tools*

Sägebeilagen, Schablonen, Stanzwerkzeuge, Prestawerkzeuge, Verschiedenes, Hilfsstoffe
Sawing shims, Templates, Punching tools, Crimping tools, Miscellaneous, Auxilliary means

Werkzeuge
Tools

8 Kompendium / *Comprisal*

Statikseiten, EN Normen, Statische Werte, Eckwinkelzuschnitt - Auswahltabellen, Zuordnung Gelenkeckwinkel, Zuordnung Gelenkverbinder, Sprossenstoßverbindungen, Informationen zur Durchschusshemmung / Einbruchhemmung, Zertifikate
Static pages, European standards, Statical values, Cutting corner angle - Selection tables, Assignments hinged corner angles, Assignments hinged connectors, crossbar butt-joint connection, Information on bullet resistant / burglar resistant, Certificates

Kompendium
Comprisal

	Seite <i>Page</i>
Nummernverzeichnis <i>Numerical index</i>	N1
Wichtige Hinweise <i>Important indications</i>	1/3
Wichtige Hinweise zum Beschlag <i>Important indications on fittings</i>	1/11
Öffnungsarten <i>Opening types</i>	1/13
Symbole / Hinweise <i>Symbols / Indications</i>	1/15
Mindest Stulpfenster Format <i>Minimum double casement window format</i>	1/19
Abkürzungsverzeichnis <i>List of abbreviations</i>	1/20
Eckverbindungstechnik <i>Corner connection technique</i>	1/22

Artikel-Nr. <i>Article-no.</i>	Seite <i>Page</i>	Artikel-Nr. <i>Article-no.</i>	Seite <i>Page</i>	Artikel-Nr. <i>Article-no.</i>	Seite <i>Page</i>	Artikel-Nr. <i>Article-no.</i>	Seite <i>Page</i>	Artikel-Nr. <i>Article-no.</i>	Seite <i>Page</i>
123943	4/15	1017101	2/23	1917086	3/151	1917258	3/95	3900014	4/31
125776	4/15	1017102	2/24	1917089	3/155	1917259	3/96	3900015	4/32
126762	4/12	1017103	2/25	1917092	3/46	1917260	3/97	3900030	4/29
126763	4/13	1017104	2/26	1917093	3/47	1917270	3/98	3900048	4/29
126793	4/12	1017105	2/27	1917101	3/50	1917271	3/99	3900049	4/29
126807	4/12	1017111	2/49	1917102	3/51	1917272	3/100	3900050	4/30
126808	4/12	1017112	2/50	1917103	3/52	1917273	3/100	3900051	4/33
126809	4/12	1017113	2/51	1917104	3/54	1917301	3/103	3900052	4/34
126855	4/15	1017120	2/28	1917105	3/57	1917303	3/104	3900053	4/35
149346	4/15	1017124	2/52	1917110	3/156	1917304	3/101	3900066	4/30
149362	4/15	1017125	2/53	1917111	3/157	1917305	3/101	3900067	4/31
151063	4/15	1017126	2/54	1917112	3/158	1917307	3/102	3910026	4/22
151198	4/13	1017203	2/30	1917113	3/159	1917331	3/76	3910040	3/106
160747	4/18	1017204	2/30	1917115	3/56	1917334	3/75	3991001	4/3
1010344	3/48	1017205	2/31	1917116	3/58	1917336	3/77	3991002	4/3
1010346	3/49	1017206	2/31	1917117	3/59	1917337	3/78	3991003	4/3
1010374	4/20	1017207	2/32	1917118	3/60	1917338	3/79	3991004	4/3
1010375	3/63	1017209	2/32	1917120	3/82	1917339	3/80	3991005	4/3
1010383	3/64	1017213	2/33	1917121	2/29	3000074	4/29	3991006	4/3
1010434	3/148	1017215	2/33	1917121	3/83	3011015	4/9	3991007	4/3
1010452	3/81	1017220	2/34	1917122	3/84	3011021	4/9	3991008	4/3
1010453	3/65	1017231	2/55	1917124	3/161	3011022	4/9	3991009	4/3
1010463	2/35	1310991	3/45	1917126	3/162	3011029	4/4	3991010	4/3
1010463	2/56	1910134	3/43	1917161	3/61	3090192	4/28	3991011	4/3
1010463	3/103	1910135	3/44	1917163	3/62	3090244	4/27	3991012	4/4
1010463	3/163	1910146	3/53	1917165	3/105	3090258	4/5	3991013	4/4
1010464	2/35	1910147	3/55	1917166	3/106	3090259	4/5	3991014	4/4
1010464	2/56	1910148	3/31	1917167	3/85	3090262	4/5	3991015	4/4
1010464	3/103	1910149	3/68	1917201	3/66	3090263	4/5	3991016	4/4
1010464	3/163	1910170	3/154	1917202	3/66	3091031	4/18	3991017	4/4
1010488	3/27	1910172	3/39	1917203	3/67	3091036	4/14	3991022	4/5
1010489	3/28	1917001	3/26	1917204	3/67	3091037	4/17	3991023	4/5
1010490	3/149	1917002	3/26	1917205	3/68	3091039	4/16	3991024	4/5
1010491	3/29	1917003	3/27	1917206	3/69	3091040	4/16	3991025	4/5
1010492	3/29	1917004	3/28	1917207	3/69	3091041	4/23	3991026	4/5
1010493	3/152	1917005	3/30	1917208	3/70	3091042	4/23	3991027	4/5
1010494	3/153	1917009	3/33	1917209	3/71	3091044	4/10	3991028	4/5
1010495	3/32	1917055	3/33	1917211	3/71	3091045	4/10	3991029	4/6
1017001	2/14	1917056	3/33	1917213	3/72	3091046	4/26	3991030	4/6
1017003	2/14	1917057	3/34	1917215	3/72	3091047	4/18	3991031	4/6
1017004	2/15	1917058	3/34	1917220	3/73	3091048	4/24	3991032	4/6
1017005	2/16	1917059	3/34	1917224	3/74	3091049	4/25	3991033	4/6
1017006	2/17	1917060	3/35	1917231	3/160	3091050	4/25	3991034	4/6
1017008	2/18	1917062	3/36	1917235	3/160	3091051	4/24	3991035	4/6
1017050	2/15	1917064	3/37	1917241	3/86	3091052	4/10	3991036	4/6
1017051	2/47	1917067	3/38	1917244	3/87	3091053	4/10	3991037	4/6
1017062	2/19	1917068	3/40	1917246	3/88	3091054	4/11	3991213	4/20
1017064	2/20	1917069	3/41	1917247	3/89	3091055	4/17	3991214	4/20
1017066	2/21	1917073	3/42	1917248	3/90	3091056	4/17	3991215	4/14
1017077	2/22	1917076	3/42	1917249	3/91	3091057	4/17	3991216	4/14
1017081	2/46	1917077	3/43	1917250	3/92	3091058	4/23	3991217	4/14
1017082	2/46	1917081	3/148	1917251	3/93	3091059	4/23	3991220	4/21
1017090	2/48	1917082	3/150	1917256	3/94	3091069	4/11	3991234	4/19

Artikel-Nr. <i>Article-no.</i>	Seite <i>Page</i>	Artikel-Nr. <i>Article-no.</i>	Seite <i>Page</i>	Artikel-Nr. <i>Article-no.</i>	Seite <i>Page</i>	Artikel-Nr. <i>Article-no.</i>	Seite <i>Page</i>	Artikel-Nr. <i>Article-no.</i>	Seite <i>Page</i>
3991236	4/21								
3991237	4/19								
3991238	4/11								
3991239	4/11								
3991240	4/22								
3991253	4/27								
3991254	4/27								
3991263	4/7								
3991264	4/7								
3991265	4/7								
3991266	4/7								
3991267	4/7								
3991268	4/7								
3991269	4/7								
3991270	4/7								
3991271	4/7								
3991272	4/7								
3991273	4/7								
3991274	4/8								
3991275	4/8								
3991276	4/8								
3991277	4/8								
3991278	4/8								
3991279	4/8								
3991280	4/21								

Artikel-Nr. <i>Article-no.</i>	Seite <i>Page</i>	Artikel-Nr. <i>Article-no.</i>	Seite <i>Page</i>	Artikel-Nr. <i>Article-no.</i>	Seite <i>Page</i>	Artikel-Nr. <i>Article-no.</i>	Seite <i>Page</i>	Artikel-Nr. <i>Article-no.</i>	Seite <i>Page</i>
180172	5/82	4030019	5/42	4070030	5/48	4070162	5/89	4090200	5/85
180179	5/82	4030022	5/43	4070036	5/79	4070163	5/89	4390002	5/85
180311	5/77	4030026	5/43	4070040	5/88	4070164	5/89	4900187	5/84
186016	5/77	4030035	5/43	4070041	5/88	4070165	5/89	4910002	5/18
188206	5/82	4030036	5/43	4070042	5/89	4070169	5/88	4910004	5/18
188250	5/82	4030038	5/43	4070043	5/88	4070170	5/88	4910016	5/29
188413	5/41	4030039	5/44	4070044	5/88	4070175	5/88	4910018	5/23
188719	5/41	4030040	5/44	4070045	5/88	4070176	5/88	4910021	5/23
197157	5/41	4030043	5/44	4070046	5/88	4070177	5/89	4910022	5/24
197158	5/41	4030365	5/44	4070047	5/88	4070178	5/89	4910023	5/24
197159	5/42	4040008	5/44	4070048	5/88	4070179	5/89	4910024	5/24
198069	5/77	4040026	5/45	4070049	5/88	4070180	5/92	4910025	5/25
4010003	5/18	4040027	5/46	4070050	5/88	4070221	5/92	4910026	5/25
4010015	5/18	4040028	5/46	4070051	5/88	4070222	5/92	4910027	5/25
4010016	5/19	4040029	5/46	4070052	5/89	4070223	5/92	4910028	5/26
4010017	5/19	4040030	5/46	4070053	5/89	4070224	5/92	4910029	5/26
4010018	5/20	4040036	5/46	4070054	5/89	4070225	5/88	4910030	5/26
4010045	5/21	4040037	5/47	4070055	5/89	4070226	5/91	4910040	5/28
4010046	5/21	4040040	5/47	4070056	5/89	4070227	5/91	4910041	5/27
4010047	5/22	4040085	5/54	4070057	5/89	4070228	5/91	4910048	5/27
4010052	5/22	4040086	5/47	4070058	5/89	4070229	5/89	4910065	5/27
4010060	5/22	4040087	5/45	4070059	5/88	4070230	5/91	4910066	5/27
4010065	5/24	4040088	5/47	4070060	5/88	4070231	5/88	4910068	5/27
4010066	5/22	4040682	5/47	4070061	5/89	4070232	5/90	4910069	5/28
4010067	5/82	4040727	5/54	4070062	5/88	4070233	5/90	4910070	5/28
4010082	5/21	4040729	5/48	4070063	5/89	4070234	5/90	4910073	5/29
4010090	5/22	4040730	5/48	4070066	5/89	4070240	5/94	4910076	5/29
4010114	5/28	4040731	5/48	4070067	5/89	4070241	5/79	4910077	5/29
4010117	5/28	4040732	5/48	4070068	5/79	4070242	5/95	4910081	5/30
4010180	5/23	4040744	5/54	4070069	5/79	4070243	5/95	4920018	5/39
4010235	5/19	4050150	5/66	4070070	5/89	4070244	5/93	4920019	5/39
4010236	5/19	4050153	5/66	4070071	5/89	4070245	5/93	4920029	5/40
4010237	5/20	4050567	5/55	4070080	5/88	4070246	5/93	4920048	5/33
4010238	5/20	4050568	5/55	4070081	5/88	4070247	5/93	4920049	5/34
4010243	5/18	4050571	5/55	4070082	5/88	4070248	5/93	4920050	5/35
4010245	5/21	4050574	5/55	4070083	5/88	4070249	5/93	4920051	5/35
4010436	5/23	4050577	5/55	4070084	5/88	4070443	5/89	4920052	5/37
4010494	5/29	4060056	5/71	4070085	5/88	4080006	5/81	4920053	5/34
4010495	5/20	4070000	5/77	4070086	5/88	4080007	5/81	4920054	5/34
4020005	5/32	4070002	5/77	4070087	5/88	4080008	5/83	4920055	5/35
4020006	5/37	4070003	5/78	4070088	5/88	4080444	5/83	4920056	5/36
4020049	5/42	4070004	5/78	4070089	5/94	4080445	5/83	4920057	5/37
4020114	5/32	4070008	5/78	4070090	5/94	4080446	5/81	4920070	5/31
4020132	5/33	4070009	5/78	4070091	5/94	4080447	5/81	4920076	5/39
4020133	5/36	4070010	5/78	4070092	5/94	4080448	5/81	4920082	5/31
4020422	5/32	4070011	5/78	4070093	5/94	4090097	5/86	4920083	5/38
4020425	5/32	4070012	5/79	4070094	5/94	4090098	5/86	4920085	5/38
4020426	5/33	4070013	5/79	4070095	5/94	4090099	5/86	4920086	5/40
4020427	5/36	4070025	5/88	4070096	5/94	4090100	5/87	4920087	5/40
4020580	5/38	4070026	5/88	4070097	5/94	4090101	5/87	4920098	5/38
4020637	5/33	4070027	5/88	4070110	5/89	4090152	5/84	4920105	5/39
4020662	5/39	4070028	5/88	4070115	5/89	4090157	5/84	4920111	5/31
4030001	5/42	4070029	5/88	4070161	5/88	4090158	5/84	4930047	5/49

Artikel-Nr. <i>Article-no.</i>	Seite <i>Page</i>	Artikel-Nr. <i>Article-no.</i>	Seite <i>Page</i>	Artikel-Nr. <i>Article-no.</i>	Seite <i>Page</i>	Artikel-Nr. <i>Article-no.</i>	Seite <i>Page</i>	Artikel-Nr. <i>Article-no.</i>	Seite <i>Page</i>
4940071	5/49	4950038	5/61	4960045	5/76				
4940072	5/50	4950047	5/61	4960046	5/76				
4940075	5/49	4950049	5/61	4960047	5/76				
4940077	5/50	4950051	5/61	4960048	5/76				
4940078	5/45	4950052	5/61	4960050	5/72				
4940079	5/45	4950053	5/62	4960052	5/72				
4940083	5/50	4950054	5/62	4960053	5/72				
4940090	5/45	4950055	5/62	4960054	5/72				
4940121	5/50	4950056	5/62	4960055	5/72				
4940141	5/54	4950057	5/62	4960056	5/73				
4940145	5/54	4950060	5/63	4960057	5/73				
4940171	5/51	4950061	5/63	4960058	5/73				
4940178	5/51	4950062	5/63	4960059	5/73				
4940187	5/51	4950063	5/63	4960060	5/74				
4940406	5/52	4950065	5/63	4960061	5/74				
4940408	5/52	4950066	5/64	4960062	5/74				
4940426	5/52	4950067	5/64	4960063	5/74				
4940433	5/52	4950075	5/64	4960229	5/75				
4940434	5/52	4950076	5/64	4960230	5/75				
4940435	5/53	4950077	5/64	4970074	5/96				
4940440	5/53	4950078	5/65	4970077	5/80				
4940441	5/53	4950079	5/65	4970079	5/80				
4940442	5/53	4950082	5/66	4970081	5/96				
4940443	5/53	4950083	5/66	4970082	5/96				
4940474	5/49	4950085	5/65	4970086	5/96				
4940493	5/51	4950086	5/65	4970087	5/96				
4950005	5/55	4950087	5/65	4980054	5/83				
4950006	5/56	4950349	5/62	4980055	5/83				
4950007	5/56	4960002	5/67	4980067	5/84				
4950008	5/56	4960003	5/67	4990001	5/85				
4950009	5/56	4960004	5/67	4990003	5/85				
4950010	5/56	4960005	5/67	4990004	5/86				
4950011	5/57	4960006	5/68	4990006	5/86				
4950012	5/57	4960007	5/68	4990014	5/87				
4950013	5/57	4960008	5/68	4990016	5/87				
4950014	5/57	4960009	5/68	6041192	5/77				
4950018	5/57	4960010	5/69						
4950019	5/57	4960011	5/69						
4950020	5/58	4960012	5/69						
4950021	5/58	4960013	5/69						
4950022	5/58	4960020	5/70						
4950024	5/58	4960021	5/70						
4950025	5/58	4960025	5/70						
4950028	5/59	4960026	5/70						
4950029	5/59	4960030	5/70						
4950030	5/59	4960031	5/71						
4950031	5/59	4960035	5/71						
4950032	5/59	4960036	5/71						
4950033	5/60	4960037	5/71						
4950034	5/60	4960040	5/75						
4950035	5/60	4960041	5/75						
4950036	5/60	4960042	5/75						
4950037	5/60	4960043	5/76						

Artikel-Nr. <i>Article-no.</i>	Seite <i>Page</i>	Artikel-Nr. <i>Article-no.</i>	Seite <i>Page</i>	Artikel-Nr. <i>Article-no.</i>	Seite <i>Page</i>	Artikel-Nr. <i>Article-no.</i>	Seite <i>Page</i>	Artikel-Nr. <i>Article-no.</i>	Seite <i>Page</i>
4070443	6/43	6060328	6/62	6940277	6/17	6940506	6/4	6950123	6/89
6040548	6/58	6060329	6/62	6940278	6/17	6940507	6/4	6950132	6/85
6041073	6/58	6060330	6/62	6940281	6/58	6940510	6/6	6950133	6/90
6041165	6/54	6060331	6/62	6940282	6/58	6940511	6/6	6950134	6/91
6041192	6/43	6061030	6/67	6940283	6/56	6940514	6/7	6950135	6/90
6050238	6/22	6061038	6/75	6940285	6/20	6940515	6/5	6950139	6/87
6050238	6/23	6061040	6/75	6940286	6/55	6940516	6/5	6950147	6/91
6050239	6/22	6061042	6/76	6940287	6/55	6940517	6/56	6950148	6/70
6050239	6/23	6061045	6/75	6940288	6/56	6940518	6/56	6950149	6/70
6050351	6/21	6061047	6/76	6940289	6/58	6940519	6/25	6950150	6/69
6050352	6/21	6081001	6/36	6940292	6/55	6940521	6/6	6950153	6/91
6050353	6/21	6081003	6/37	6940293	6/55	6940522	6/6	6950155	6/69
6050356	6/21	6081005	6/37	6940294	6/55	6950062	6/69	6950156	6/87
6050358	6/21	6081006	6/38	6940295	6/55	6950063	6/71	6950165	6/70
6050359	6/21	6081007	6/38	6940296	6/54	6950064	6/71	6950166	6/70
6051014	6/28	6081008	6/38	6940297	6/54	6950065	6/86	6950167	6/70
6051016	6/29	6081009	6/38	6940299	6/54	6950068	6/89	6950168	6/70
6051018	6/29	6081010	6/38	6940300	6/58	6950069	6/89	6950180	6/40
6051021	6/30	6920741	6/77	6940300	6/71	6950071	6/68	6950181	6/40
6051022	6/30	6920742	6/77	6940302	6/58	6950071	6/82	6950182	6/40
6051023	6/30	6930010	6/76	6940308	6/18	6950071	6/86	6950183	6/40
6051024	6/30	6930035	6/76	6940309	6/18	6950072	6/81	6950184	6/40
6051028	6/30	6930093	6/77	6940310	6/19	6950073	6/68	6950185	6/40
6051029	6/26	6930094	6/77	6940311	6/19	6950073	6/81	6950186	6/39
6051030	6/26	6940027	6/69	6940314	6/25	6950074	6/68	6950187	6/39
6051031	6/32	6940027	6/86	6940315	6/25	6950074	6/81	6950189	6/39
6051032	6/32	6940028	6/71	6940317	6/11	6950075	6/81	6950190	6/39
6051033	6/32	6940031	6/86	6940318	6/11	6950076	6/81	6950192	6/41
6051034	6/32	6940095	6/67	6940319	6/51	6950078	6/68	6950193	6/41
6051036	6/32	6940097	6/69	6940320	6/51	6950081	6/71	6950194	6/41
6051037	6/33	6940100	6/68	6940321	6/52	6950082	6/71	6950195	6/41
6051038	6/33	6940250	6/8	6940322	6/52	6950083	6/69	6950196	6/41
6051039	6/31	6940251	6/8	6940323	6/52	6950085	6/83	6950197	6/41
6051040	6/31	6940252	6/9	6940325	6/51	6950086	6/83	6950198	6/42
6051041	6/31	6940253	6/9	6940326	6/51	6950087	6/83	6950199	6/42
6051042	6/31	6940254	6/10	6940326	6/57	6950088	6/84	6950200	6/44
6051044	6/31	6940255	6/10	6940328	6/57	6950089	6/84	6950201	6/44
6051045	6/32	6940256	6/56	6940329	6/57	6950090	6/84	6950202	6/44
6051047	6/33	6940257	6/53	6940330	6/57	6950091	6/85	6950203	6/44
6051048	6/34	6940258	6/53	6940331	6/57	6950092	6/90	6950204	6/44
6051049	6/34	6940259	6/53	6940333	6/57	6950098	6/87	6950205	6/44
6051050	6/34	6940260	6/12	6940334	6/51	6950099	6/88	6950216	6/45
6051062	6/27	6940261	6/12	6940335	6/53	6950102	6/83	6950217	6/45
6051063	6/34	6940262	6/13	6940336	6/53	6950103	6/88	6950218	6/45
6051064	6/35	6940263	6/13	6940341	6/15	6950104	6/24	6950219	6/45
6051065	6/35	6940266	6/54	6940342	6/15	6950105	6/24	6950220	6/45
6051066	6/27	6940267	6/14	6940347	6/56	6950106	6/28	6950221	6/46
6051067	6/28	6940268	6/14	6940500	6/3	6950108	6/29	6950222	6/46
6051068	6/27	6940269	6/15	6940501	6/3	6950109	6/29	6950223	6/46
6051069	6/33	6940270	6/15	6940502	6/3	6950118	6/90	6950224	6/46
6051070	6/28	6940273	6/57	6940503	6/3	6950119	6/90	6950225	6/46
6051186	6/29	6940275	6/16	6940504	6/4	6950121	6/87	6950226	6/46
6051209	6/33	6940276	6/16	6940505	6/4	6950122	6/88	6950227	6/46

Artikel-Nr. <i>Article-no.</i>	Seite <i>Page</i>	Artikel-Nr. <i>Article-no.</i>	Seite <i>Page</i>	Artikel-Nr. <i>Article-no.</i>	Seite <i>Page</i>	Artikel-Nr. <i>Article-no.</i>	Seite <i>Page</i>	Artikel-Nr. <i>Article-no.</i>	Seite <i>Page</i>
6950228	6/46	6960275	6/77						
6950251	6/47	6960276	6/78						
6950252	6/47	6960277	6/66						
6950253	6/47	6960278	6/70						
6950254	6/47	6960279	6/66						
6950255	6/47	6960282	6/64						
6950256	6/47	6960283	6/64						
6950257	6/47	6960284	6/65						
6950258	6/47	6960285	6/65						
6950262	6/48	6980250	6/59						
6950263	6/48	6980251	6/60						
6950264	6/48	6980252	6/61						
6950265	6/48								
6950266	6/48								
6950267	6/48								
6950268	6/49								
6950269	6/49								
6950270	6/49								
6950271	6/49								
6950272	6/49								
6950273	6/49								
6950274	6/49								
6950275	6/49								
6950276	6/50								
6950278	6/43								
6960034	6/91								
6960035	6/91								
6960037	6/67								
6960038	6/67								
6960039	6/90								
6960043	6/74								
6960044	6/74								
6960046	6/78								
6960047	6/79								
6960048	6/79								
6960049	6/79								
6960050	6/80								
6960052	6/78								
6960257	6/53								
6960259	6/62								
6960260	6/63								
6960261	6/42								
6960261	6/63								
6960262	6/43								
6960262	6/63								
6960263	6/63								
6960264	6/64								
6960265	6/64								
6960266	6/64								
6960270	6/72								
6960271	6/72								
6960272	6/73								
6960273	6/73								

Artikel-Nr. <i>Article-no.</i>	Seite <i>Page</i>	Artikel-Nr. <i>Article-no.</i>	Seite <i>Page</i>	Artikel-Nr. <i>Article-no.</i>	Seite <i>Page</i>	Artikel-Nr. <i>Article-no.</i>	Seite <i>Page</i>	Artikel-Nr. <i>Article-no.</i>	Seite <i>Page</i>
5010034	7/9	5060020	7/44	5910006	7/11	5930029	7/39	5950039	7/7
5010035	7/9	5060021	7/44	5910008	7/11	5940001	7/23	5950040	7/7
5010115	7/9	5060024	7/44	5910009	7/11	5940005	7/23	5950041	7/7
5010119	7/9	5060025	7/44	5910010	7/12	5940006	7/24	5950045	7/7
5010589	7/10	5060031	7/45	5910011	7/12	5940007	7/24	5950046	7/7
5010590	7/10	5060032	7/45	5910012	7/12	5940008	7/25	5950049	7/7
5010611	7/10	5060051	7/45	5910013	7/13	5940010	7/25	5950050	7/8
5010628	7/10	5060053	7/45	5910016	7/13	5940019	7/25	5950051	7/8
5010629	7/10	5060055	7/46	5910019	7/13	5940021	7/25	5950052	7/8
5010632	7/11	5060056	7/46	5910020	7/13	5940022	7/25	5950053	7/8
5030076	7/37	5060060	7/46	5910021	7/13	5940023	7/26	5950054	7/8
5030100	7/39	5060061	7/46	5910022	7/14	5940024	7/26	5950056	7/8
5030101	7/39	5060070	7/47	5910025	7/14	5940035	7/26	5960006	7/48
5030102	7/39	5060071	7/47	5910027	7/14	5940038	7/26	5960007	7/45
5030103	7/40	5060073	7/47	5910029	7/14	5940039	7/27	5960009	7/48
5040000	7/21	5060075	7/48	5910030	7/15	5940040	7/27	5960012	7/43
5040003	7/21	5060076	7/48	5910031	7/15	5940051	7/32	5960013	7/43
5040004	7/21	5060077	7/48	5910032	7/15	5940055	7/32	5960014	7/50
5040005	7/21	5060080	7/48	5910037	7/15	5940057	7/33	5960016	7/42
5040024	7/21	5060089	7/49	5910038	7/15	5940058	7/33	5960018	7/51
5040025	7/21	5060101	7/49	5910040	7/16	5940059	7/33	5960019	7/51
5040026	7/22	5060102	7/49	5910042	7/16	5940060	7/33	5960020	7/51
5040027	7/22	5060103	7/49	5910043	7/16	5940061	7/33	5960021	7/42
5040036	7/26	5060104	7/49	5910044	7/16	5940062	7/34	5960024	7/50
5040090	7/28	5060105	7/50	5910045	7/16	5940065	7/34	5960025	7/51
5040101	7/28	5060107	7/50	5910046	7/17	5940067	7/34	5970002	7/52
5040124	7/31	5060369	7/44	5910049	7/17	5940068	7/35	5970003	7/55
5040132	7/32	5060378	7/50	5910050	7/17	5940069	7/35	5970004	7/56
5040150	7/35	5060396	7/41	5910053	7/17	5940070	7/35	5970006	7/56
5040151	7/36	5060397	7/41	5910054	7/17	5940075	7/27	5970008	7/57
5040152	7/36	5060418	7/49	5910055	7/18	5940101	7/29		
5040154	7/36	5060422	7/46	5910061	7/18	5940104	7/29		
5040166	7/36	5060424	7/47	5910071	7/18	5940105	7/30		
5040410	7/22	5060425	7/47	5910079	7/18	5940107	7/30		
5040415	7/22	5060426	7/47	5910080	7/18	5940110	7/30		
5040416	7/22	5070000	7/52	5910081	7/19	5940116	7/31		
5040426	7/23	5070001	7/52	5910101	7/19	5940117	7/31		
5050009	7/3	5070002	7/52	5910102	7/19	5940118	7/31		
5050030	7/3	5070003	7/53	5910104	7/19	5950004	7/4		
5050266	7/3	5070004	7/53	5910105	7/19	5950007	7/4		
5050267	7/3	5070012	7/53	5910107	7/20	5950008	7/4		
5050292	7/3	5070015	7/54	5910109	7/20	5950009	7/4		
5060001	7/41	5070016	7/54	5910110	7/20	5950010	7/5		
5060002	7/41	5070024	7/54	5930003	7/37	5950011	7/5		
5060003	7/41	5070025	7/54	5930005	7/37	5950012	7/5		
5060004	7/41	5070043	7/55	5930009	7/37	5950015	7/5		
5060005	7/42	5070044	7/55	5930010	7/38	5950016	7/5		
5060012	7/42	5070224	7/52	5930019	7/38	5950029	7/5		
5060013	7/42	5070225	7/53	5930020	7/38	5950030	7/6		
5060014	7/43	5070227	7/53	5930025	7/38	5950031	7/6		
5060015	7/43	5070229	7/54	5930026	7/38	5950032	7/6		
5060016	7/43	5370004	7/55	5930027	7/39	5950033	7/6		
5060017	7/43	5370005	7/55	5930028	7/39	5950038	7/6		

1. Werkstoff, Maßtoleranzen

WICONA-Profile werden im Strangpressverfahren aus der Aluminium-Legierung EN AW-6060 T66 (AlMgSi_{0,5}F22) warm ausgehärtet nach DIN EN 573-3, DIN EN 573-4 und DIN EN 755-2 hergestellt. Diese Legierung ist sehr korrosionsbeständig, gut anodisierbar und von hoher Festigkeit. Die Technischen Lieferbedingungen und Maßtoleranzen sind in DIN EN 12020-1 und DIN EN 12020-2 festgelegt.

2. Auswahl der Profile, Zubehörteile und Beschläge

Die Auswahl von Profilen, Zubehör und Beschlägen erfolgt eigenverantwortlich durch den Verarbeiter, abhängig von den baulichen Gegebenheiten, den statischen Erfordernissen, den architektonischen Vorstellungen und den Kundenwünschen, sowie unter Beachtung unserer Verarbeitungsrichtlinien. Bei der Festlegung von Elementgrößen müssen zur Aufnahme von Wärmedehnungen und Bauwerksbewegungen Fugen in der Rahmenkonstruktion und gegebenenfalls auch im Bauanschluss vorgesehen werden. Die in unseren Unterlagen dargestellten Bauanschlüsse müssen vom Verarbeiter den jeweiligen baulichen Bedingungen angepasst werden.

Zu beachten sind unsere Angaben über zulässige Flügelgrößen, -gewichte und -formate sowie Normen, Hinweise und Vorschriften von Fachverbänden und behördliche Verordnungen.

3. Bestellung

Alle Artikel der Profilprogramme können bei den eingerichteten Verkaufsbüros von WICONA und bei unseren anderen Vertriebspartnern bestellt werden. Pressblanke Profile, Zubehörteile und Beschläge werden aus Lagervorrat geliefert. Zwischenverkauf bleibt vorbehalten.

Bis auf wenige Ausnahmen sind die Profile dieser Liste objektbezogen nach Terminvereinbarung auch oberflächenveredelt lieferbar. Die Verkaufsbedingungen sind der WICONA-Preisliste zu entnehmen.

Lieferlängen sind in den Datenblöcken und der Preisliste der Profile angegeben. Die dort angegebenen Außenabwicklungen enthalten bei Verbundprofilen die gesamte sichtbare Abwicklung ohne Dämmleisten.

4. Transport

WICONA-Profile werden werkseitig mit äußerster Sorgfalt behandelt um Korrosion und mechanische Beschädigungen beim Transport und in den WICONA-Lagern auszuschließen. Diesem Zweck dient die Portionsverpackung in PE-Folie, gegebenenfalls unter Anwendung von Schutzöl.

Der Transport erfolgt durch WICONA oder durch Vertragsspediteure ausschließlich auf Fahrzeugen mit gedeckter Ladefläche und unter Beachtung unserer Verpackungs-, Verlade- und Transportvorschriften. Damit ist die größtmögliche Sicherheit gegeben, dass WICONA-Profile unbeschädigt beim Empfänger ankommen.

Mit der Übergabe der Ware an einen Spediteur oder Frachtführer, spätestens jedoch mit verlassen des Lagers oder des Lieferwerks, geht die Gefahr auf den Käufer über. Wird beim Eingang der Ware festgestellt, dass Verpackungen nass oder beschädigt sind, so muss dies beim Fahrer reklamiert werden; die Beanstandung muss mit Gegenzeichnung des Fahrers auf dem Lieferschein vermerkt werden. Zusätzlich muss dies dem Lieferer innerhalb von 7 Tagen schriftlich mitgeteilt werden. Nicht transportbedingte Sachmängel müssen, soweit durch zumutbare Untersuchungen feststellbar, unverzüglich, spätestens 7 Tage nach Warenanlieferung schriftlich mitgeteilt werden. Bei der ersten Untersuchung nicht erkennbare Mängel sind unverzüglich nach Feststellung unter sofortiger Einstellung laufender Be- oder Verarbeitung schriftlich anzuzeigen. Schadensmeldungen, die diese Fristen überschreiten, können wir nicht anerkennen. Zum Abladen am besten geeignet ist ein Kran mit Traverse und zwei Gurten mit mindestens 80 mm Breite. Wird mit Stapler abgeladen und transportiert, so nur mit breiten, auf großen Abstand eingestellten Gabelzinken. Die Auslieferungsfahrer sind angewiesen, unsachgemäßes Abladen zu melden.



1. Material, Dimensional tolerances

WICONA profiles are manufactured in extrusion process from aluminium alloy EN AW-6060 T66 (AlMgSi_{0,5}F22) and age hardened according to DIN EN 573-3, DIN EN 573-4 and DIN EN 755-2. This alloy is highly corrosion-resistant, good for anodic treatment and is of high strength. The technical delivery terms and dimensional tolerances are predetermined in DIN EN 12020-1 and DIN EN 12020-2.

2. Selection of profiles, accessories and fittings

Selection of profiles, accessories and fittings is the fabricator's own responsibility, dependent on the structural conditions, the static requirements, the architectural conceptions and customer wishes whilst observing the guidelines of our Workshop Manual. Gaps in the frame construction and if necessary, also in the junctions to structure should be provided with regard to thermal expansions and structural movements when determining unit sizes. The junctions to structure, represented in our documents, must be adapted to the respective structural conditions by the fabricator.

Please follow our specifications concerning admissible sash/leaf sizes, weights and formats as well as standards, hints and instructions of professional associations and regulations of public authorities.

3. Ordering

All articles of our Profile Programme can be ordered from the established WICONA sales offices and other sales partners. Extruded profiles, accessories and fittings are delivered ex stock and are subject to prior (intermediate) sale.

Apart from few exceptions, the profiles included in this Programme List are also deliverable project based and surface treated according to the stipulated delivery time. Please refer to the current WICONA price list for sales conditions.

The delivery lengths are indicated in the data blocks and price list of profiles. The outer perimeter listed therein includes the total visible perimeter of composite profiles without the perimeter of thermal break strips.

4. Transport

WICONA profiles are treated with utmost care in the factory in order to prevent corrosion and avoid mechanical damages during transport and at the WICONA stocks. For this purpose, the profiles are bundled in portion packs in polyethylene foil and, when necessary, with application of a protective oil film.

The transport takes place through WICONA or contract forwarding agents, exclusively on vehicles with covered loading area considering our packaging, loading and transport prescriptions. This provides maximum safety for WICONA profiles to reach the addressee undamaged.

With the transfer of goods to a forwarding agent or freight carrier, the responsibility goes over to the purchaser, at the latest however on leaving the warehouse or supplying factory. If on receipt, the goods are found to be damaged or the packages are wet, complaint should be noted in the delivery receipt with countersignature of the driver. In addition, written notice should be sent to the supplier within 7 days. Quality defects other than transport damages, as far as identifiable through reasonable inspections, should be reported through written notice immediately, at the latest 7 days after delivery of goods. Not identifiable defects at the initial stage of inspection should be reported immediately by written notification after the identification while stopping the running processing. We cannot accept damage reports received after this time limit. A crane with traverse and two belts with minimum 80 mm width is best suited for unloading. If a fork lift truck is used for unloading and transport, then only with wide and widely spaced fork prongs. The truck drivers have instructions to report improper unloading procedures.

5. Lagerung beim Verarbeiter

Jede Einwirkung von Feuchtigkeit, auch durch Handschweiß oder durch Tauwasserbildung, kann bei pressblanken Aluminiumprofilen Korrosion auslösen. Auch eloxierte Oberflächen können durch alkalische Stoffe, z. B. Zement, Kalk, Mörtel oder durch Flugrost, Stahlspäne und dergleichen angegriffen werden. Wichtig ist daher eine trockene Lagerung in einem gedeckten Raum und die Vermeidung starker Temperaturschwankungen im Lager. Ein optimaler Schutz pressblanker Aluminiumprofile wird dadurch erreicht, dass sie erst unmittelbar vor der Weiterverarbeitung aus der werkseitigen PE-Folienverpackung entnommen werden. Eine starke Aufheizung der verpackten Profile durch direkte Sonneneinstrahlung muss vermieden werden.

Auflageflächen und seitliche Anlagen von Lagergestellen müssen aus nicht aggressivem Holz oder Kunststoff bestehen. Beim Entnehmen werden die Profile nur herausgehoben, keinesfalls aus dem Stapel herausgezogen. Bei jedem Handling von pressblanken Profilen sollten trockene, saubere Handschuhe getragen werden. Oberflächenbehandelte Profile sind gegen Korrosionsangriff durch Bewitterung und normale atmosphärische Einflüsse bestens und dauerhaft geschützt. Stoß-, Druck- und Biegebeanspruchungen können zu Beschädigungen von Eloxal und Beschichtung führen. Solche Schäden können in der Regel durch Nachbehandlung nicht beseitigt werden.

6. Verarbeitung

Genaue, vollständige und verbindliche Angaben zur Profilbearbeitung, Profilverbindung und zum Einbau von Beschlägen und Zubehör sind in unseren Verarbeitungsunterlagen enthalten.

Zur spanenden Bearbeitung von Aluminium sind Werkzeuge mit spezieller Schneidengeometrie über den Fachhandel lieferbar. Für saubere Schnitte ist das regelmäßige Nachschärfen der Werkzeuge und die Verwendung geeigneter Kühlschmiermittel wichtig. Für die wirtschaftliche Verarbeitung aller WICONA-Systeme bieten wir ein umfassendes Sortiment von Bearbeitungs- und Einbauschablonen, Montagehilfsmitteln, systembezogenen Spezialwerkzeugen, Stanzwerkzeugen und kompletten Stanzeinheiten an. Auch bei der Verarbeitung ist größte Sorgfalt geboten, um Schäden auf veredelten Oberflächen zu vermeiden. Eckverbindung mit Hülse: bei erhöhten optischen Anforderungen, oder sehr empfindlichen Sichtflächen, welche die in den Merkblättern VFF* Al.02 und VFF Al.03 dargestellten Mindestanforderungen unter Punkt "Fertigungsbedingte mechanische Beschädigungen" überschreiten, sollte an Stelle der vorgegebenen Hülse mit Bund (4070000), die Hülse ohne Bund (4070008) verwendet werden. Damit lassen sich bei Verbolzungsstellen, die sehr dicht an der Sichtfläche liegen, Abzeichnungen vermeiden.

Bei der Verwendung der Hülse ohne Bund (4070008) ist bei der Verarbeitung auf eine flächenbündige Setztiefe zu achten.

Spannbacken und Auflagen von Arbeitstischen sollten aus Holz oder Kunststoff bestehen und regelmäßig von darauf haftenden Spänen gereinigt werden; Stahlhämmer dürfen zur Profilbearbeitung nicht verwendet werden. Die meisten WICONA-Beschläge sind werkseitig gefettet; hingegen müssen Treibstangenkanäle, Drehkippscheren und Riegelschieber, Verriegelungsgarnituren und die zugänglichen beweglichen Teile von Fenstergetrieben, Handhebeln und Oberlichtöffnern beim Einbau leicht gefettet werden. Für die Reinigung fertiger Elemente liefert WICONA geeignete Mittel, die bei vorschriftsmäßiger Anwendung mit eloxierten bzw. beschichteten Oberflächen verträglich sind. Wir weisen besonders darauf hin, dass manche im Handel erhältlichen Produkte farbbeschichtete Oberflächen angreifen können.



5. Storage at the fabricator

Any influence of moisture, also through hand perspiration or formation of condensation water, can cause corrosion of extruded aluminium profiles. Even anodized surfaces can be attacked by alkaline substances, e.g. cement, lime, mortar or volatile rust, steel chips or similar. Hence, it is important to store profiles in a dry and covered room and avoid higher temperature fluctuations in the warehouse. Optimum protection of extruded aluminium profiles is achieved by unpacking from the factory packed Polyethylene foil just before further machining.

Strong heating through direct solar radiation of packaged profiles should be avoided.

The bearing surfaces and lateral supports of storage racks must be made of non-aggressive wood or plastic.

Only remove the profiles from the storage rack by lifting, never by pulling them out of stacks. Always wear dry and clean gloves whenever handling millfinished extruded profiles.

Surface treated profiles are well and durably protected against corrosive attacks through weathering and normal atmospheric influences. Impact, compressive and bending stress can lead to damages of anodized and coated surfaces of profiles.

Usually, such damages cannot be eliminated through after-treatment.

6. Processing

Our Workshop Manual provides precise, complete and binding specifications for processing and connecting profiles as well as for the assembly of fittings and accessories.

Tools with special cutting edge geometry for machining aluminium can be obtained from specialized dealers. Regular re-sharpening of tools and application of appropriate cooling lubricants is important for obtaining clean cuts. We offer a comprehensive range of processing and assembly templates, assembly auxiliary means, system specific special tools, punching tools and complete punching units for most efficient and economical processing of all WICONA systems.

The machining should also be done with utmost care to avoid damages on surface treated aluminium profiles. Corner junction with bush: for increased optical requirements or for very delicate visible surfaces which exceed the minimum requirements set out by the VFF* Al.02 and VFF Al.03 leaflets under point "Manufacturing-related mechanical damages", the bush without collar (4070008) should be used instead of the specified bush with collar (4070000). That way, for bolting areas which are very close to the visible surface of the profile, slight surface deformations can be avoided.

When using the bush without collar (4070008), it is important to pay attention during manufacture that the seating depth is flush with the surrounding profile area.

Clamping jaws and supports of work benches should be made of wood or plastic and must be cleaned regularly from chips adhering to them. Steel hammers should not be used for processing profiles. Most of WICONA fittings are delivered greased ex factory, however drive rod channels, turn/tilt retainer arms, lock slide rod, locking sets and the accessible movable parts of window gears, hand levers and fanlight openers must be slightly greased while assembling.

WICONA provides appropriate cleaning agents for fabricated units which are compatible with the anodized and coated surfaces when used according to prescriptions. Particularly, we would like to point out that some products offered on the market could attack colour coated profile surfaces.

7. Oberflächenbeschaffenheit und -behandlung

Auf den Sichtflächen der pressblanken Aluminiumprofile sind nach EN 12020-1 leichte Riefen und andere leichte Aufrauungen, z.B. Scheuerstellen, zulässig. Inwieweit diese bei der nachfolgenden Oberflächenbehandlung beseitigt werden, hängt von der Art der Behandlung ab.

Die **Eloxalbehandlung** ist nach EN 12373 und den Bestimmungen der GÜTEGEMEINSCHAFT ANODISIERTES ALUMINIUM E.V. (GAA), bzw. den Bestimmungen für das Gütezeichen für anodisch erzeugte Oxidschichten auf Aluminium Halbzeug (Ausgabe Sept. 2004) der Qualanod-Zürich, CH-8027 Zürich oder vergleichbaren lokalen Vorschriften und Bestimmungen auszuführen.

Bei einer Vorbehandlung ohne wesentlichen Oberflächenabtrag nach E0 bleibt die durch Herstellung und Bearbeitung bedingte Oberflächenbeschaffenheit erhalten. Auch bei einer chemischen Vorbehandlung in Spezialbeizen nach E6 werden leichte Riefen und Aufrauungen nicht beseitigt, sondern höchstens ausgeglichen und bei beiden Vorbehandlungen können Korrosionserscheinungen, die in pressblankem Zustand nicht oder kaum wahrgenommen wurden, sichtbar werden. Gefügeunregelmäßigkeiten und Strangpressnähte können insbesondere bei E6 hervorgehoben werden. Bei höheren Ansprüchen an das dekorative Aussehen muss eine mechanische Vorbehandlung nach einem der in EN 12373 aufgeführten Verfahren E1...E5 vorgenommen werden.



Zulässige Abweichungen in Aussehen und Farbe müssen zwischen den Vertragspartnern vereinbart werden, am besten mit Hilfe von Grenzmustern. EN 12373 enthält Kriterien für die Beurteilung des dekorativen Oberflächenaussehens.

Die **Beschichtung** von Aluminiumprofilen ist nach den Güte- und Prüfbestimmungen der GSB INTERNATIONAL Gütegemeinschaft bzw. den Vorschriften zur Erlangung eines Gütezeichens für Beschichtungen auf Aluminium durch Nass- und Pulverlackierung bei Architekturanwendungen (Ausgabe 2003) der Qualicoat Gütegemeinschaft, Zürich, oder vergleichbaren lokalen Vorschriften und Bestimmungen auszuführen. Auch diese Richtlinien enthalten Angaben zur Beurteilung der Oberflächen. Bei Pulverlacken beträgt die Schichtdicke auf Sichtflächen bei Außenanwendung 50...120 µm.

Zu vermeiden sind örtliche Lackanhäufungen bei Einschub-, Schnapp-, Klips- oder Drehverbindungen oder in den Aufnahmen von Dichtungen. Derartige Profilpassungen sind von uns auf die normalen Wanddickenveränderungen durch Oberflächenbehandlung ausgelegt; übermäßiger Lackauftrag kann Funktion und Verbindungsmöglichkeit beeinträchtigen. Schieberstangen sollten möglichst nur eloxiert werden; eine Beschichtung, falls unumgänglich, sollte auf eine Schichtdicke von 30 µm beschränkt werden. Der Verarbeiter muss dafür Sorge tragen, dass die in seinem Auftrag arbeitende Eloxal- bzw. Beschichtungsanstalt angelieferte pressblanken Profile mit erkennbaren Oberflächenschäden (auch Korrosion) oder mit starken Verwindungen nicht bearbeitet, wenn absehbar ist, dass diese Profile nach der Oberflächenbehandlung verworfen werden. WICONA übernimmt keine Kosten, die aus der Nichtbeachtung dieser Auflage entstehen.

8. Verhütung von Korrosions- und Oberflächenschäden am Bau

Aluminium kann beim Zusammenbau mit anderen metallischen Werkstoffen, ausgenommen rostfreier Stahl der Werkstoffgruppe 1.4301 (A2) und 1.4401 (A4) nach EN 10088-1, durch Bildung von Kontaktelementen angegriffen werden. Dies gilt besonders für die Verbindung mit Kupfer und Kupferlegierungen. Abhilfe ist möglich durch Vermeiden von direktem metallischem Kontakt, z.B. mittels geeigneten Schutzanstrichen oder Kunststoff-Zwischenlagen.

Ein optimaler Schutz von Aluminiumbauteilen während der Bauarbeiten wird durch Verwendung von Einputz-Zargen erreicht, in welche die Bauteile erst nach Abschluss der Maurer- und Putzarbeiten eingesetzt werden. Bei Anwendung anderer Schutzverfahren (Abzieh- oder Klarlacke, selbstklebende Kunststoff-Folien) ist ausschließlich der Anwender dafür verantwortlich, dass die verwendeten Produkte uneingeschränkt mit eloxierten oder farb-

7. Surface finish and treatment

Slight score marks and other slight roughness such as chafe marks on visible surfaces of extruded aluminium profiles are admissible according to EN 12020-1. The extent of removal of these defects depends on the kind of subsequent surface treatment.

The anodic treatment has to be performed according to the European Standard EN 12373 and the regulations of GÜTEGEMEINSCHAFT ANODISIERTES ALUMINIUM E. V. (GAA) (Association for quality mark of anodic oxide layer on semi finished aluminium, September 2004 Edition) of Qualanod-Zürich, CH-8027 Zürich, Switzerland or comparable local rules and regulations.

In case of a pretreatment without significant surface abrasion, the consistency of profile surface at the stage of extrusion and processing remains preserved even after the anodic treatment E0. Even after a chemical pretreatment of special pickling and anodic treatment of E6, the slight score marks and roughness are not eliminated but at the most counterbalanced and in both cases of pretreatment, the signs of corrosion, hardly perceived in extruded condition, may become visible. Structural irregularities and extrusion seams can be visible especially after the anodic treatment of E6. For higher requirements on decorative appearance, a mechanical pretreatment should be carried out according to one of the procedures of E1 up to E5 described in EN 12373. Admissible deviations in

appearance and colour must be stipulated between the contracting partners, preferably with the help of limiting samples. The European Standard EN 12373 includes criteria for evaluation of decorative appearance of the surface.

The coating of aluminium profiles has to be carried out according to quality and test regulations of GSB INTERNATIONAL (Quality association for coating of construction parts) and according to regulations for attainment of quality mark for wet and powder coatings on aluminium in architectural applications (Edition of 2003) of Qualicoat Gütegemeinschaft, Zürich or comparable local rules and regulations. Also these guidelines include specifications for evaluation of surfaces. The powder coat thickness for outer application is 50 up to 120 µm.

Local lacquer accumulation in areas of sliding, snapping, turning connections and in retaining grooves of gaskets should be avoided. Such profile fitting is designed for normal changes of profile wall thickness through surface treatment; excessive coating can impair the function and connecting possibility. As far as possible, slide rods should only be anodized. If a coating is unavoidable, then the coating thickness should be limited up to 30 µm. The processor should ensure that the anodizing or coating factory working for him do not process extruded profiles with visible surface damages (also corrosion) if it is predictable that these profiles cannot be used for fabrication after the surface treatment.

WICONA cannot be held responsible for resulting damages and costs.

8. Prevention of corrosion and surface damages of profiles at site
Aluminium can be attacked due to assembly with other metallic materials except stainless steel of material group 1.4301 (A2) and 1.4401 (A4) corresponding to EN 10088-1. Especially, this applies to connection with copper and copper alloys. Direct metallic contact can be avoided with the help of e.g. plastic inter layers or protective coating.

Optimum protection of aluminium construction parts is achieved during the construction works by using plastering frames, in which the structural components are mounted after the completion of masonry and plastering works. For application of other protection procedures (strip lacquer or clear lacquer, self-adhesive plastic foils) the user is solely responsible with regard to the absolute compatibility of used products with the anodized or colour coated aluminium structural parts. In order to obviate rights of recourse for damages caused by

beschichteten Aluminiumbauteilen verträglich sind. Um Regressansprüchen für von Dritten verursachte Schäden vorzubeugen, empfiehlt sich bei größeren Objekten die Zwischenabnahme von Bauabschnitten sofort nach deren Fertigstellung. Die üblichen Hinweisschilder, mit denen andere Gewerke zur sorgfältigen Behandlung von Aluminium-Bauteilen aufgefordert werden, reichen nicht aus, um den Verarbeiter von möglichen Schadenersatzansprüchen zu entlasten. Korrosionsschutz für Stahlteile, Anschlüsse und Verstärkungen nach DIN 55928.

Bei der Oberflächenbehandlung von WICONA-Verbundprofilen müssen die Hinweise im nachfolgenden Anhang beachtet werden.

9. Verglasung, Fugenabdichtung

Glasmaße werden mit den Formeln unserer Stücklisten-Beispiele bzw. mit den Angaben unserer sonstigen Planunterlagen errechnet. Die Verglasung erfolgt entsprechend DIN 18361, den Verklotzungsvorschriften des Glaserhandwerks und den Richtlinien der Isolierglas-Hersteller. Besonders zu beachten sind die Vorschriften hinsichtlich des Dampfdruckausgleichs (zugleich Entwässerung) aus freien Falzräumen. Alle WICONA-Systeme sind für die Verglasung zwischen Elastomer-Dichtprofilen eingerichtet. Diese bestehen bis auf wenige Ausnahmen aus EPDM nach DIN 7863; zur Erleichterung des Einbaus sind sie mit Gleitpolymer beschichtet. Die Zuordnung von Füllungsdicke (einschließlich Dickentoleranz), Glasleiste und Dichtungsprofil ist in den Auswahltabellen dieser Lagerliste dargestellt. Dichtungsprofile dürfen nicht unter Zug eingebaut werden, sondern sind bei rund umlaufenden Dichtungen in den Ecken zu stauchen und oben zu stoßen. Hilfswerkzeuge hierfür sind lieferbar. Vulkanisierte Dichtungsrahmen werden von den Rahmenecken ausgehend zur Feldmitte hin verlegt.

Andere Verglasungssysteme mit ein- oder beidseitiger Anwendung von Dichtstoffen setzen die Verwendung spezieller Glasleisten voraus.

Bei Füllungen aus Acrylglas (PMMA) und Polycarbonat (PC) kann im Kontakt mit unseren EPDM-Dichtungen die Gefahr von Spannungsrissen in diesen Platten nicht ausgeschlossen werden. Das Risiko der Unverträglichkeit liegt außerhalb unserer Kontrolle und ist vom Verarbeiter mit den Herstellern solcher Füllungen abzuklären.

Für die Abdichtung von Bauanschluss- und Konstruktionsfugen bieten wir in unserem Programm geeignete Dichtstoffe, bei denen Adhäsion und Verträglichkeit auch mit farbbeschichteten Aluminiumflächen gesichert sind. Die Verarbeitungsmerkmale und die Sicherheitsdatenblätter dieser Stoffe sind zu beachten. Bei anderweitig beschafften Dichtstoffen obliegt dem Verarbeiter die Verantwortung für deren Auswahl.

10. Reinigung von WICONA-Bauteilen

Außenwandelemente sind neben der Beanspruchung durch Sonne und Regen aggressiven Luftbestandteilen ausgesetzt und unterliegen damit unvermeidlich einer Verschmutzung. Diese beeinträchtigt nicht nur das Aussehen der Fassade, sondern stellt durch die ständige Einwirkung der Schmutzablagerungen auch ein Korrosionsrisiko dar. Die Bauteile müssen daher in Intervallen, die je nach Standort unterschiedlich sind, gereinigt werden.

Ausführliche Hinweise zur Reinigung von Aluminiumbauteilen sind in unserem WICONA-Bedienungs- und Wartungshandbuch, sowie im technischen Merkblatt:

A05 Reinigen von Aluminium im Bauwesen

bei der Aluminium-Zentrale e. V., Am Bonnhof 5, 40474 Düsseldorf enthalten; diese stellt auch eine Liste geeigneter neutral reagierender Reinigungsmittel zur Verfügung. Speziell zur Reinigung von Fassadenobjekten verweisen wir auf die GÜTEGEMEINSCHAFT FÜR DIE REINIGUNG VON METALL-FASSADEN E.V. (GRM), deren Mitglieder eine RAL gütegesicherte Reinigung von Fassaden anbieten.

third party, it is recommended to have intermediate inspection of construction stages of major projects immediately after completion. The usual information signs for careful treatment of aluminium construction parts are not sufficient to relieve the processor from possible indemnity claims.



Corrosion protection for steel parts, junctions and reinforcements according to DIN 55928 (German Industrial Standard).

Indications in the following appendix should be observed for surface treatment of WICONA composite profiles.

9. Glazing, Joint sealing

Glass dimensions are calculated with the help of formulas of our material schedule examples and specifications in other planning documents. Glazing follows according to DIN 18361 and the shimming regulations of glazier trade and guidelines of insulation glass manufacturers. Pay attention especially to the regulations with regard to air pressure equalization (drainage at the same time) of open rebate areas. All WICONA systems are designed for glazing between Elastomer gasket profiles. Apart from few exceptions, these gaskets are made of EPDM according to DIN 7863 (German Industrial Standard). They are coated with Polymer (glide-polymerized) to facilitate assembly. The assignment of infill thickness (including thickness tolerance), glazing bead and gasket profile is shown in the selection tables of this profile programme catalogue. The gasket profiles should not be stretched during installation, but continuous gaskets must be compressed in the corners and butt-joined at the top. Auxiliary tools for this purpose are available. Vulcanized gasket frames are mounted starting from the frame corners to field centre. Other glazing systems with single or both sided use of sealants imply the use of specifically designed glazing beads.

The danger of tension cracks caused by contact with our EPDM gaskets while using infill plates made of acrylic glass (PMMP=Polymethyl methacrylate) and Polycarbonate (PC) cannot be ruled out.

The risk of incompatibility lies beyond our control and the fabricator should clarify this with manufacturers of such infills.

We offer in our programme suitable sealants for sealing junctions to structure and construction joints, ensuring adhesion and compatibility also with colour coated aluminium surfaces. The processing and security data leaflets of these sealants should be considered. The fabricator (processor) bears the responsibility for choice and procurement of sealants elsewhere.



10. Cleaning WICONA construction units

Besides stress from sun radiation and rain, the outer wall units are exposed to aggressive air constituents and thus soiling is unavoidable. This impairs not only the appearance of façade, but also constitutes the risk of corrosion through constant effect of dirt accumulations. Hence, the components must be cleaned at regular intervals, the length of which being dependent on the different locations and respective environmental loads.

Detailed indications for cleaning aluminium structural components are included in our WICONA operating and maintenance handbook and the technical leaflet:

A05 Cleaning of Aluminium in civil engineering available at the Aluminium-Zentrale e.V., Am Bonnhof 5, 40474 Düsseldorf.

They also provide a list of appropriate and neutral cleaning agents. Especially for cleaning of façade projects, we refer you to the GÜTEGEMEINSCHAFT FÜR DIE REINIGUNG VON METALL-FASSADEN E.V. (GRM), whose members offer a RAL quality assured cleaning procedure of façades.

Wir beschränken uns nachfolgend auf einige wesentliche Hinweise:

- Leichte Verschmutzungen mit Wasser unter Zusatz eines neutralen Reinigungsmittels (keine Seifenlauge!) mit Schwamm und Tuch entfernen. Danach mit klarem Wasser gründlich spülen.
- Stärkere Verschmutzungen erfordern schwach abrasiv wirkende Reiniger, diese dürfen jedoch nicht auf Glas angewandt werden.
- Bei beschichteten Oberflächen sollte zuvor durch eine Probenanwendung auf einer verdeckt liegenden Fläche sichergestellt werden, dass der Lack weder mechanisch noch chemisch angegriffen wird.
- Auszuschließen sind in jedem Fall Reinigungsmittel mit pH-Werten unter 5 oder über 8 sowie scheuernd oder schmirgelnd wirkende Mittel ebenso Stahlwolle oder Drahtbürsten.

11. Wartung von WICONA-Bauteilen

Sofern keine Funktionsstörungen oder durch unsachgemäßen Umgang verursachte Schäden vorliegen, kann die Wartung durch den privaten Hausbesitzer sich darauf beschränken, zugängliche gleitende Beschlagteile in größeren Zeitabständen leicht zu ölen oder zu fetten. Wartungsarbeiten bei größeren Objekten und bei öffentlichen Gebäuden gehören in die Hand des Fachmanns, zumal wenn sie mit weitergehenden Erhaltungsmaßnahmen verbunden sind.

Hier kann der Verarbeiter durch den Abschluss eines Wartungsvertrags mit der Bauherrschaft sicherstellen, dass die Qualität seiner Arbeit über einen langen Nutzungszeitraum zur Zufriedenheit seines Kunden erhalten bleibt.

12. Funktionsfähigkeit

WICONA-Fenster erfüllen die Anforderungen hinsichtlich der Fugendurchlässigkeit, (EN 12207), Schlagregendichtheit (EN 12208), Widerstandsfähigkeit bei Windlast (EN 12210) und den Richtlinien der Gütegemeinschaft Aluminiumfenster. Systemprüfberichte stehen zur Verfügung, ebenso Prüfzeugnisse über Sonderprüfungen bezüglich Schallschutz, Angriffshemmung und Rauchdichtheit bei Türen. Die Dichtungs- und Entwässerungssysteme der dargestellten Serien funktionieren in der Regel nur bei lotrechtem Einbau. Im Zweifelsfall bitten wir um Rückfrage.

WICONA-Fenster und -Fenstertüren entsprechen bei Kombination mit geeigneten Isoliergläsern, insbesondere Wärmeschutzgläsern den Anforderungen der Energieeinsparverordnung von 2009.

Über die Einstufung unserer wärmedämmten WICONA-Systeme nach EN ISO 10077-1(2) geben entsprechende Unterlagen Auskunft.

Mit dieser Einstufung und den von den Glasherstellern angegebenen U_g -Werten lassen sich die U_w -Rechenwerte für verglaste Fenster und Fenstertüren ermitteln.



13. Technische Service-Leistungen

Unsere Planungs- und Zeichnungsunterlagen, Verarbeitungsrichtlinien und Beschlagseinbaupläne erleichtern Ihnen die Verarbeitung unserer Systeme. Darüber hinaus stehen Ihnen die Beratungsdienste von WICONA und unseren Vertriebspartnern zur Verfügung. Unterlagen und Beratungen entsprechen unserem besten Wissen. Eine Gewähr für Fehlerfreiheit kann jedoch nicht übernommen werden, es sei denn, die Fehler beruhen auf Vorsatz oder grober Fahrlässigkeit unsererseits.

Unsere Verarbeiter bieten wir Schulungen vor Ort oder Seminare in unserem Technologie-Zentrum mit mehrtägiger intensiver Unterweisung in Theorie und Praxis des Metallbaus. Unser PC-Softwarepaket WICTOP/WICPLOT eröffnet die vielseitigen Möglichkeiten moderner Datenverarbeitung bei Angebotskalkulation, Arbeitsvorbereitung, Zuschnittoptimierung, Zeichnungserstellung bis hin zur Steuerung der Profilsäge. Auch auf diesem Gebiet werden unsere Verarbeiter in die Anwendung eingeführt. Durch aktuelle Infos halten wir unsere Kunden in Technik und Normung auf dem laufenden.

In the following, we confine ourselves to some essential hints:

- Remove slight soiling with water containing a neutral cleaning agent (no soapsuds!) using sponge and cloth, thereafter rinse thoroughly with clear water.
- Stronger soiling requires slightly abrasive acting cleaning agents which, however, should not be used on glass.
- For coated surfaces, we recommend to test the agents on a concealed surface to make sure that the agents do not attack lacquer either mechanically or chemically.
- By no means use cleaning agents with pH-values below 5 and above 8 as well as abrasive or sanding agents or steel wool and wire brushes.

11. Maintenance of WICONA structural components

As far as there are no malfunctions or damages caused by improper handlings, the maintenance by the private house owner can be restricted to slightly oiling or greasing accessible gliding fitting parts at larger intervals. Maintenance works on larger projects and public buildings should be carried out by professionals, especially when they are connected with further preservation measures.

In this case, the fabricator can assure the quality of his work over a long period of time and the satisfaction of his client by concluding a maintenance contract with the building owner.

12. Functional capability

WICONA windows fulfil the requirements with regard to air permeability (EN 12207), water tightness (EN 12208), resistance to wind load (EN 12210) and the guidelines of Gütegemeinschaft Aluminiumfenster (Association for quality mark of aluminium windows). System test reports are available, as well as test certificates for sound insulation, assault resistance and smoke tightness of doors. As a rule, the sealing and drainage systems of the represented series will work correctly only when installed vertically. Please revert in case of doubt.

In combination with appropriate insulation glazing, especially heat protecting glass, WICONA windows and casement doors comply with the requirements of the energy saving ordinance 2009.

The classification of our thermally insulated WICONA systems according to EN ISO 10077-1(2) can be found in our documentation.

Based on this classification and the U_g -values supplied by the glass manufacturers, the U_w -values for glazed windows and casementdoors can be calculated.

13. Technical service performances

Our planning documents and technical drawings, workshop manuals and fittings installation plans facilitate processing of our systems. Furthermore, the support services of WICONA and of our distribution partner are at your disposal. Our documents and services are provided to the best of our knowledge. However, we cannot assume liability for correctness except for errors based on intent or gross negligence on our part.

We offer trainings for our system fabricators on site or seminars of several days' intensive theoretical and practical instructions in metal construction at our Technology Centre. Our PC-Software packet WICTOP/WICPLOT offers a variety of possibilities of modern data processing for tender estimating, work scheduling, optimization of profile cutting, drafting and even control of profile saw. Our fabricators are also introduced into this field of application. We keep our customers updated with regard to the latest technique and standards through continuous informations.

14. Werksgarantie

Den Verarbeitern unserer wärmegeämmten Fenstersysteme bieten wir eine Garantie über die Einhaltung einer Reihe der in dieser Liste gemachten Angaben.

Die Garantieerklärung stellen wir dem Verarbeiter auf Anforderung gern zur Verfügung.

Wir weisen darauf hin, dass die Garantie erlischt, sofern andere als die im jeweils gültigen WICONA-Lieferprogramm aufgeführten Profile, Zubehörteile und Beschläge verwendet werden. Der gleiche Vorbehalt gilt als Haftungsausschluss sinngemäß auch für unsere nicht wärmegeämmten Systeme.

15. Warenzeichen WICONA

Verschiedene Profile und Konstruktionen des WICONA-Programms sind patentrechtlich geschützt.

In unseren Technischen WICONA-Unterlagen sind die Ergebnisse unserer Entwicklungsarbeit, unsere Erfahrungen und unser Fachwissen als Systemhersteller eingebracht. Die Wiedergabe des Inhalts dieser Liste wie auch des Inhalts unserer anderen Unterlagen ist deshalb nur mit unserer schriftlichen Genehmigung und unter Benutzung unseres Warenzeichens WICONA mit dem Hinweis gestattet:

® = eingetragenes Warenzeichen der Sapa Building Systems GmbH, Ulm.

Die Benutzung dieses Warenzeichens zu Werbezwecken oder als Produktbezeichnung ist nur zulässig, sofern ausschließlich Profile, Zubehörteile und Beschläge des jeweils gültigen WICONA-Lieferprogrammes vorgesehen oder verwendet worden sind. Wer also WICONA-Konstruktionsteile ganz oder teilweise mit fremden Konstruktionsteilen verarbeitet, ist nicht zur Benutzung unseres Warenzeichens berechtigt. Insbesondere dürfen mit fremden Konstruktionsteilen hergestellte Bauteile nicht gegenüber Architekten, Bauherren usw. als „WICONA-Fenster, -Türen“ oder ähnlich bezeichnet werden. Änderungen von Profilen, Zubehörteilen, Beschlägen und Konstruktionen bleiben vorbehalten. Angegebene DIN-Normen werden sinngemäß von den WICONA-Landesorganisationen in landesübliche Normen und Richtlinien übertragen.

16. Beschläge

Beschläge und vergleichbare Bauteile sind gemäß den zu erwartenden Belastungen und unseren Angaben dimensioniert und durch Nanosil-Qualität verstärkt gegen Korrosion geschützt (Schutzklasse 5 nach EN 1670:2007). Der Verarbeitungsbetrieb wählt nach zulässigen Beanspruchungen unsere Beschläge aus. Wartung beweglicher Beschlagteile gegen Verschleiß und Korrosionsanfälligkeit sowie Häufigkeit der Reinigung und Pflege sind entsprechend den Anforderungen mechanischer und chemischer Belastungen aus der Umgebung durchzuführen. Alle Abbildungen sind DIN R dargestellt.

Gütesicherung der Beschläge:

Notwendige Güteeigenschaften für

- Fenster und Fenstertüren nach RAL-RG 636/1 und RAL-RG 716/1 bewertet. Dauerfunktionstüchtigkeit, Korrosionsschutz, Leibungstest, Bedienbarkeit usw. von Dreh- Kipp-Beschlägen nach europäischer Norm EN 13126-8 beurteilt.
- Türen- und Spezial-Beschläge nach Anforderungen der VOB-Teil C, DIN 18357 und den jeweiligen EN-Prüfungen.

14. Factory guarantee

We offer the fabricators of our thermally insulated window systems a guarantee with regard to the compliance with the sequence of specifications made in this programme list.

This guarantee declaration is provided to fabricators on request.

We would like to point out that the guarantee becomes void if other profiles, accessory parts and fittings than the ones listed in the valid WICONA product range are used.

The same conditions also apply to our non thermally broken systems.

15. WICONA Trademark

Several profiles and constructions of the WICONA Programme are protected by patent rights.



Our technical WICONA documents include results of our development work, our experiences and our specialized knowledge as system producer. Hence, reproduction of contents of this list as well as contents of our other documents is only allowed

with our written permission and using our trade mark WICONA with the indication:

® = Registered trade mark of Sapa Building Systems GmbH, Ulm.

The use of this trade mark for advertising purposes or as product name is only admissible provided that profiles, accessories and fittings exclusively out of the respective, valid WICONA product range are used or intended to be used. Fabricators using WICONA components partially or exclusively in conjunction with foreign components is not entitled to use our trade mark. Particularly, structural components fabricated with external constructions parts should not be designated as „WICONA windows and doors“ or similar towards Architects, Building owners etc. We reserve the right to alter profiles, accessory parts, fittings and constructions. The specified DIN standards are transferred by the local WICONA organizations into local customary standards and guidelines.

16. Fittings

Fittings and comparable structural components are dimensioned according to the expected loads and our specifications and are highly protected against corrosion through Nanosil quality coating (protection class 5 to EN 1670:2007). The fabricating company selects our fittings according to the admissible loads. Maintenance of movable fitting parts against wear and corrosion as well as frequency of cleaning and maintenance should be performed depending on the requirements regarding mechanical stress and chemical attacks from the surroundings. All displayed pictures are DIN R.

Quality assurance of fittings:

Necessary qualitative properties for:

- windows and casement doors according to RAL*-RG 636/1 and RAL*-RG 716/1. Evaluation of long term functionality, corrosion protection, soffit test, operability etc. of turn/tilt fittings according to European Standard EN 13126-8.
- Doors and special fittings according to requirements of VOB (German construction contract procedures), Part C, DIN 18357 and the respective EN tests.

Für die Vielzahl von Tür-Beschlag-Einzelteilen gelten eine Reihe von Normen wie die RAL-RG 607/8-3 ausweist.

Geltende Regelwerke sind mit dem ÜZ (Übereinstimmungsnachweis) belegt. Genannte Normen in der Bauregelliste, wie DIN EN 1627 für einbruchhemmende Türen, bestimmen die Qualität der jeweiligen Bauprodukte. Für die Sicherheitstechnik wie Rauch- und Feuerschutzelemente gelten neben den Normen die aktuellen Zulassungen und Prüfberichte.

Oberflächenschutz der Beschläge:

- Teile aus rostfreiem Stahl nach EN 10088-1, ohne Oberflächen-Behandlung.
- Teile aus Stahl mit Spezialverfahren oder nach EN 1403 verzinkt, chromatiert und zusätzlich mit verstärktem Korrosionsschutz beschichtet.
- Nichteisenmetalle: Alle sichtbaren Teile nach vereinbartem Farbmuster eloxiert bzw. beschichtet.

Die Oberflächenschutz-Vorschriften der Gütegemeinschaften werden eingehalten.

Anhang: Oberflächenbehandlung bei WICONA-Verbundprofilen

Bei unseren wärmegeprägten Verbundprofilen erfolgt die Verbindung der Aluminiumprofilschalen durch glasfaserverstärkte Polyamideleisten. Der Werkstoff dieser Leisten und das Verbindungsverfahren erlauben eine nachträgliche Oberflächenbehandlung der Profile nach dem heutigen Stand der Technik entsprechenden Eloxal- und Beschichtungsverfahren unter Einhaltung bestimmter Bearbeitungsbedingungen.

1. Aufrüsten

Die Wärmedämmzone darf nicht auf Druck, Zug, Biegung oder Torsion beansprucht werden. Ein Durchhängen der Profile muss gegebenenfalls durch zusätzliche Unterstützung abgefangen werden. Die Kontaktierung beim Beschichten muss an beiden Profilschalen und an beiden Stabenden, also insgesamt vierfach, erfolgen.

2. Vorbehandlung

Die in der Praxis gebräuchlichen Vorbehandlungen beim Eloxieren nach EN 12373 bzw. das dem Farbbeschichten vorausgehende Chromatieren nach DIN EN 12487 schädigen unsere Verbundprofile nicht.

Auf folgende Punkte weisen wir besonders hin:

- Überbeizen muss wegen seiner Auswirkungen auf den Verbund vermieden werden.
- Zwischen den einzelnen Behandlungsstufen muss gründlich gespült werden, um Korrosion durch Badrückstände in den Verbindungszonen und in den Profilhohlkammern auszuschließen.
- Die Objekttemperatur bei Haftwassertrocknung darf 100 °C nicht überschreiten.

3. Grenzbedingungen bei Pulverbeschichtung

Bei der Aushärtung darf die am Profil im Ofen zu messende Objekttemperatur 200 °C über 15 Minuten nicht überschreiten. Die Einhaltung dieser Bedingungen ist durch Aufzeichnungen regelmäßig zu dokumentieren.

Number of Standards included in RAL-RG 607/8-3 are valid for a variety of door fitting components.

The prevailing regulations are covered by ÜZ (conformity evidence mark). The Standards listed in the list of building rules, such as DIN EN 1627 for burglary resistant doors determine the quality of respective building products. For the safety technique such as smoke control and fire protection units, besides the standards, the current approvals and test reports are valid.

Surface protection of fittings:

- *Parts made of stainless steel according to EN 10088-1 without surface treatment.*
- *Parts made of steel with special procedure or galvanized, chromated and additionally corrosion protection coated according to EN 1403.*
- *Nonferrous metals:
All visible parts anodized or coated according to stipulated colour sample.*

The surface protection regulations of Association for quality mark are complied with.

**: German Institut for Quality Assurance and Certification*

Appendix: Surface treatment of WICONA composite profiles

The aluminium profile shells of our thermally insulated composite profiles are connected with glass fibre reinforced polyamide strips. The material of these strips and connecting procedure allow a subsequent surface treatment of profiles corresponding to the latest technologically developed procedures of anodizing and coating, complying with certain processing conditions.

1. Equipment

The thermal insulation zone should not be stressed by pressure, traction, deflection or torsion. When necessary, sagging of profiles must be intercepted by additional support. For coating, electrodes must be placed on both profile shells and on both profile bar ends, i.e. totally fourfold contacts.

2. Pretreatment

The customary pre-treatment for anodizing according to EN 12373 or the preceding chromating according to DIN EN 12487 for colour coating in the practice does not damage our composite profiles.

Refer particularly to the following points:

- *Due to its effect on composite zone, the over pickling should be avoided.*
- *Rinse thoroughly between individual treatment stages to avoid corrosion through bath residues in connecting zones and in profile hollow chambers.*
- *The object temperature during the drying period of adhered water should not exceed 100 °C.*

3. Marginal conditions for powder coating

The maximum hardening temperature of profile in the furnace should not exceed 200 °C during 15 minutes. Compliance with these conditions should be documented regularly through records.

4. Entlacken/Wiederbeschichten von Verbundprofilen

Auf Grund bisheriger Erfahrungen mit Polyamideleisten halten wir eine einmalige Entlackung und Wiederbeschichtung für möglich. Für Isolierleisten aus anderen speziellen Kunststoffen gilt diese Aussage nicht. Bei Isolierleisten aus speziellen Kunststoffen ist vor dem Entlacken die Verträglichkeit der Entlackungsmittel vom Entlackungsbetrieb zu prüfen. Die Verantwortung für eine ordnungsgemäße Entlackung und Wiederbeschichtung liegt ausschließlich beim Entlackungsbetrieb. Sie sollte sich jedoch auf Ausnahmefälle beschränken.

Folgendes ist dabei zu beachten:

Zum Entlacken dürfen nur solche Chemikalien verwendet werden, die nachweislich Polyamid nicht angreifen. Mittel, die z.B. Ameisensäure enthalten, sind daher auszuschließen. Tragglieder nach DIN 18056 (Rahmen, Riegel, Pfosten) sollten nicht wieder beschichtet werden. Vor dem erneuten Beschichten muss das Verbundprofil mindestens 24 Stunden bei Raumtemperatur zwischengelagert werden. Unsere WICONA-Werksgarantie gilt nicht für solchermaßen mehrmals oberflächenbehandelte Profile.

4. Stripping and re coating composite profiles

Based on our past experiences with polyamide strip, we consider the possibility of stripping and re-coating only once. This predication does not apply to thermal break strips made of other special plastic materials. The compatibility for lacquer stripping agents should be checked by the stripping company for insulation strips made of special plastic prior to stripping lacquer. The stripping company is wholly responsible for proper stripping and re-coating. However, it should be limited to exceptional cases.

Thereby, following has to be considered:

Only approved chemicals which do demonstrably not attack polyamide should be used for stripping. Agents containing formic acid for instance should not be used. Load bearing elements (frame, transom, mullion profiles) according to DIN 18056 should not be re-coated again. The stripped composite profile must be stored at room temperature for at least 24 hours prior to re-coating.

Our WICONA factory guarantee is not valid for profile surface treated several times in such a way.

Werkstoff-Kenndaten / Material data specifications

Aluminium EN AW-6060 T66 (AlMgSi0,5 F22)
DIN EN 573, DIN EN 755

Dichte / Density	ρ	2,7 g/cm ³	(2700 kg/m ³)
Zugfestigkeit / Tensile strength	R_m	21,5 kN/cm ²	(215 MPa)
Mindeststreckgrenze / Minimum yield strength	R_e	16,0 kN/cm ²	(160 MPa)
Längenausdehnungskoeffizient / Linear expansion coefficient	α	23,5 x10 ⁻⁶ /K	
E-Modul / Modulus of elasticity	E	7000 kN/cm ²	(70000 MPa)
Wärmeleitfähigkeit / Thermal conductivity	λ	160 W/mK	
- σ : im Lastfall H / for load combination H DIN 4113-1/A1		8,8 kN/cm ²	(88 MPa)
- σ : im Lastfall HZ / for load combination HZ		10,0 kN/cm ²	(100 MPa)
- τ : im Lastfall H / for load combination H		5,0 kN/cm ²	(50 MPa)
- τ : im Lastfall HZ / for load combination HZ		5,8 kN/cm ²	(58 MPa)

Hinweis

Gewährleistung und Oberflächenschutz

Der Oberflächenschutz entspricht den Vorgaben der DIN EN 1670. Eine Gewährleistung für die Oberflächenqualität wird dann übernommen, wenn keine aggressiven Stoffe den Beschlag angreifen (z.B. in Molkereien und an der Meeresküste), säurevernetzende Dichtstoffe, Kalk usw. Die Gewährleistung beginnt mit dem Tag, an dem der Beschlag eingebaut wird. Im Gewährleistungsfall leisten wir kostenlosen Ersatz der defekten Teile. Weitere Kostenerstattungen unsererseits sind ausgeschlossen.

Oberflächenbehandlung

Die Bandseite und andere sichtbare Beschlagsteile sind silber eloxiert bzw. RAL 9016 beschichtet. Sonderfarben, Sondereloxal oder die Sonderoberfläche Niro-Design sind ebenfalls ausführbar.

Zulässige Flügelgrößen

Die im Beschlägeteil angegebenen maximalen Breiten und Höhen gelten nur für die Anwendungsbereiche der Grundbeschläge. Durch unterschiedliche Flügelprofile und der angenommenen Wind- und Schlagregenbelastung sowie das zulässige Maximalgewicht werden diese Flügelgrößen eingeschränkt bzw. durch den Einsatz von optional zusätzlichen Beschlagteilen, wie z.B. Mittelverriegelungen, erweitert (siehe Tabellen "Zulässige Flügelgrößen").

Die profilabhängigen maximalen Flügelgrößen können durch die beschlagsabhängigen maximalen Formatgrößen eingeschränkt werden (siehe Tabellen "Zulässige Formatgrößen"). Sondergrößen und erhöhte Flügelgewichte können im Einzelfall mit zusätzlichen Beschlagskomponenten ausgeführt werden. Hierzu ist die Anfrage bei WICONA erforderlich.

Zulässige Formatgrößen

Die in den Diagrammen "Zulässige Formatgrößen" angegebenen maximalen Flügelgewichte dürfen nicht überschritten werden. Die beschlagsabhängigen Maximalformate und Zusatzmaßnahmen sind anhand der Diagramme zu ermitteln. Diese Daten sind bei Flügelquerformaten besonders zu beachten. Die ermittelten Formatgrößen können durch die profilspezifischen Flügelgrößen weiteren Einschränkungen unterliegen (siehe Tabellen "Zulässige Flügelgrößen").

Zubehör - Drehbegrenzer

In Drehstellung wird mit dem Drehbegrenzer der Öffnungswinkel des Fensterflügels begrenzt. Der Einsatz wird empfohlen, wenn Fensterflügel unkontrolliert (z.B. durch Wind) so gegen die Fensterlaibung oder Aluminium-Stützprofile schlagen können, dass die Beschläge bzw. Profile beschädigt oder zerstört werden können.

Mindestplatzbedarf

Zum Anbringen von Beschlagteilen muss bei der Auswahl der Blendrahmen der Mindestplatzbedarf und die Bohrlage der Beschlagteile berücksichtigt werden.

Fenster mit verdecktem Beschlag

Durch die Kinematik des verdeckt liegenden Beschlages ist die Öffnungsweite auf 100° begrenzt.

Dabei ist die Endposition durch ein in den Beschlag integriertes, dämpfend wirkendes Federelement mit Rastfunktion fixiert (Endlagendämpfung ELD).

Ein Überdrücken des Flügels führt zu einer Überbeanspruchung des Ecklagers, dadurch ist eine Beschädigung des Lagers nicht auszuschließen.

Die Anwendung eines Drehbegrenzers ist ab FAB > 1300 mm verbindlich vorzusehen.

Für Fenster mit erhöhter Beanspruchung (z. B. Schulen, Krankenhäuser, o.ä.) oder ab FAB > 800 mm wird die Verwendung eines gedämpften Drehbegrenzers empfohlen.

Weitere zusätzliche Maßnahmen, wie die Ausführung als Tilt-First Beschlag mit abschließbarem Fenstergriff sind empfehlenswert.

Note

Warranty and surface protection

The surface protection corresponds to the specifications of DIN EN 1670 (European Standard). Warranty for surface quality will only apply if no aggressive material attacks the fittings (e.g. in dairies and coastal areas), such as acid polymerizing sealing compounds, lime etc. The warranty begins with the installation day of the fitting. In cases under warranty, we replace defect parts free of charge. Further cost reimbursements claims on our part are excluded.

Surface treatment

Hinge sided and other visible fitting parts are silver anodized, resp. RAL 9016 powder coated. Further options regarding colours, anodizing or the stainless steel design surface finish are also available.

Admissible sash sizes

The maximum width and height dimensions specified in the fitting chapter are only valid for the application areas of the standard fittings. By selecting different sash profiles in combination with assumed wind and rain loads as well as the maximum admissible weight, these could be restricted, resp. extended through the use of optionally available supplementary fitting parts such as, for example, centre locking points (see table "Admissible sash sizes").

The profile dependent maximum sash sizes could be restricted through the fitting depended maximum format sizes (see table "Admissible format sizes"). Special sizes and increased sash weights can be accommodated individually using additional fitting components. In such a case, please consult WICONA.

Admissible format sizes

The maximum sash weights specified in the diagrams "Admissible format sizes" may not be exceeded. The fitting dependent maximum formats and additional measures must be determined using the diagrams. These data are particularly important for sash landscape formats. The determined format sizes could be subject to further profile related sash sizes restrictions (see table "Admissible sash sizes").

Accessory - Turn limiter

The opening angle in turn position of the window sash is restricted with the help of turn limiter. The use is recommended for window sashes likely to hitting uncontrolled (e.g. by wind) against the window reveal or aluminium mullion profiles resulting in damaged fittings or profiles.

Minimum space required

When selecting the frame profiles, please take into account the minimum space required for mounting the fitting parts as well as the drilling position of the fitting parts.

Window with concealed fitting

Due to the kinematics of the concealed fitting, the opening width is limited to 100°.

The end position is fixed by means of a spring part with damping and catching function integrated into the fitting (End of stroke damper ELD).

Forceful opening of the sash beyond this point causes over stressing and possible damage of the corner bearing.

The use of a turn limiter is compulsory for a sash overall width > 1300 mm.

For windows subjected to increased strain (f. ex. schools, hospitals or similar) or for sash overall width > 800 mm, the use of a damped turn limiter is recommended.

Further additional measures such as the option of a tilt-first fitting with lockable window handle are advisable.

WICLINE

Auswahl der Beschläge und Zubehörteile *Selection of fittings and accessory parts*

Zubehör - Mittelverriegelungen

Optional zusätzlich erforderliche Artikel zum Grundbeschlag.
Der Einsatz der senkrechten und waagerechten Mittelverriegelungen ist von dem jeweiligen Flügelprofil und der Windlast abhängig.
(siehe Tabellen "Zulässige Flügelgrößen")

Verarbeitung

Der Beschlageinbau und die Profilbearbeitung ist aus der jeweiligen, systembezogenen Verarbeitungsrichtlinie und den entsprechenden Beschlag-Einbauplänen zu entnehmen.

Ergänzende Hinweise:

siehe WICSTYLE - Türbeschläge
siehe WICSLIDE - Hebe-Schiebe-, Schiebebeschläge

Bedienung und Wartung

Ergänzende Hinweise:
siehe Broschüre "Bedienungs- und Wartungsanleitung für Fenster, Türen und Fassaden-Elemente aus Aluminium."

Wichtige Hinweise zum Beschlag *Important indications on fittings*

Accessory - Centre locks

*Optionally required additional article for basic fitting. The use of vertical and horizontal centre locks is dependent on the respective sash profile and on the wind load.
(see tables "Admissible sash sizes")*

Processing

















Please refer to the respective system specific processing guidelines and corresponding fitting installation plan for installation of fittings and the processing of profiles.

Additional information:

















*see WICSTYLE - door fittings
see WICSLIDE - lifting/sliding, sliding fittings*

Operating and maintenance







*Additional information:
see booklet "Operating and maintenance instructions for aluminium windows, doors and façade units."*

Symbol Symbols	Bezeichnung Designation	Symbol Symbols	Bezeichnung Designation
	Dreh-Kipp-Fenster (DK) <i>Turn/Tilt window</i>		Senk-Klapp-Fenster (SK) <i>Lowering and projecting top-hung window</i>
	Tilt-First-Fenster (TF) <i>Tilt-First window</i>		Klapp-Fenster (KF) auswärts <i>Top hung window outwards</i>
	Dreh-Fenster (D) <i>Turn window</i>		Schwing-Fenster (SW) <i>Horizontal pivot window</i>
	Dreh-Kipp-Stulp-Fenster (ST) <i>Turn/tilt double casement window</i>		Wende-Fenster (SW) <i>Vertical pivot window</i>
	Tilt-First-Stulp-Fenster (ST) <i>Tilt-first double casement window</i>		Dreh-Kipp-Fenstertür (FT) einwärts, barrierefrei <i>Turn/tilt casement door inwards, accessible</i>
	Dreh-Stulp-Fenster (ST) <i>Turn double casement window</i>		Fenstertür (FT) einwärts, barrierefrei <i>Casement door inwards, accessible</i>
	Kipp-Fenster, Hochformat (K) <i>Tilt window, portrait</i>		Tilt-First-Fenstertür (FT) einwärts, barrierefrei <i>Tilt-First casement door inwards, accessible</i>
	Kipp-Fenster, Querformat (K) <i>Tilt window, landscape</i>		Fenstertür (FT-A) auswärts, barrierefrei <i>Casement door outwards, accessible</i>
	Oberlicht-Fenster (OL) <i>Fanlight window</i>		

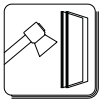















Symbol Symbols	Bezeichnung Designation	Symbol Symbols	Bezeichnung Designation
	DK-Fenstertür (FT) zweifl. einwärts, beidseitig barrierefrei <i>Turn/tilt double casement door inwards, both sided accessible</i>		Rundbogen-Drehkipp-Fenster <i>Semi-circular arch turn/tilt window</i>
	Fenstertür (FT) zweifl. einwärts, beidseitig barrierefrei <i>Double casement door inwards, both sided accessible</i>		Rundbogen-Dreh-Fenster <i>Semi-circular arch turn window</i>
	TF-Fenstertür (FT) zweifl. einwärts, beidseitig barrierefrei <i>Tilt-First double casement door inwards, both sided accessible</i>		Segment-Drehkipp-Fenster <i>Segmental turn/tilt window</i>
	Fenstertür (FT-A) zweifl. auswärts, beidseitig barrierefrei <i>Double casement door outwards, both sided accessible</i>		Segment-Dreh-Fenster <i>Segmental turn window</i>
	Parallelschiebe-Kipp-Fenster (PSK) <i>Parallel slide tilt window</i>		Stichbogen-Drehkipp-Fenster <i>Segmental arch turn/tilt window</i>
	Parallelausstell-Fenster <i>Parallel outward opening window</i>		Stichbogen-Dreh-Fenster <i>Segmental arch turn window</i>
	Schräg-Drehkipp-Fenster <i>Sloped turn/tilt window</i>		
	Schräg-Dreh-Fenster <i>Sloped turn window</i>		
	Schräg-Oberlicht <i>Sloped fanlight</i>		

Symbol Symbols	Bezeichnung Designation	Symbol Symbols	Bezeichnung Designation
	Windlast <i>Wind Load</i>		Verdeckte Beschläge <i>Concealed fittings</i>
	Schlagregendichtheit <i>Tightness against driving rain force</i>		Stulpaufsatzprofil mit Kniehebel <i>Double casement supplement profile with toggle lever</i>
	Einbruchhemmung RC1 N/RC2N/RC2 DIN EN 1627:2011 <i>Burglary resistance class RC1 N/RC2N/RC2</i>		Stulpaufsatzprofil mit Stulpgetriebe <i>Double casement supplement profile with double casement gear</i>
	Einbruchhemmung RC 3 DIN EN 1627:2011 <i>Burglary resistance class WK 3</i>		Klotzabstand 50 mm zur Ecke <i>Shim distance to corner 50 mm</i>
	Durchschusshemmung nach DIN EN 1522 <i>Bullet resistance</i> <i>according to DIN EN 1522</i>		
	Maximal zulässiges Flügelgewicht <i>Maximum admissible sash weight</i>		Hinweis <i>Indication</i>
	Mittelverriegelung (MV) <i>Centre lock (MV)</i>		1000 Pa = 1 kN/m ² <i>1000 Pa = 1 kN/m²</i>
	Mittelband (MB) <i>Centre hinge (MB)</i>		Diagramme zulässige Formatgrößen beachten <i>Mind diagrams admissible format sizes</i>
	Wichtiger Hinweis zu beachten! <i>Important hints pay attention to!</i>		Profil-Nr. in () sind ohne Darstellung <i>Profile-No. in () are without picture</i>

Beschläge Fittings

Symbol Symbols	Bezeichnung Designation	Symbol Symbols	Bezeichnung Designation
	Einbruchhemmung RC1N/RC2N/RC2 DIN EN 1627:2011 <i>Burglary resistance class RC1N/RC2N/RC2</i>		
	Einbruchhemmung RC 1 N DIN EN 1627:2011 <i>Burglary resistance class RC 1 N</i> DIN EN 1627:2011		
	Einbruchhemmung RC 2 N DIN EN 1627:2011 <i>Burglary resistance class RC 2 N</i> DIN EN 1627:2011		
	Einbruchhemmung RC 2 DIN EN 1627:2011 <i>Burglary resistance class RC 2</i> DIN EN 1627:2011		
	Einbruchhemmung RC 3 DIN EN 1627:2011 <i>Burglary resistance class RC 3</i> DIN EN 1627:2011		
	Durchschusshemmung nach DIN EN 1522 <i>Bullet resistance according to DIN EN 1522</i>		

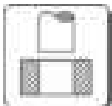
Profilseiten
Profile pages

Symbol Symbols	Bezeichnung Designation	Symbol Symbols	Bezeichnung Designation
	Profil-Außenschale <i>Profile outer shell</i>		Eckwinkel <i>Corner angle</i>
	Profil-Innenschale <i>Profile inner shell</i>		Hülse <i>Bush</i>
	Profilstablänge <i>Profile bar length</i>		Stoßverbinder <i>Butt-joint connector</i>
	Äußerer Umfang Eloxal, ohne Wärmedämmleisten <i>External perimeter Anodic, without thermal insulation strips</i>		Leitteil <i>Guide part</i>
	Mechanisch bearbeitbare Fläche <i>Mechanically processible surface</i>		Bohrschablone <i>Drilling template</i>
	Eckverbindung <i>Corner connection</i>		Handstanzwerkzeug <i>Hand punching tool</i>
	Stoßverbindung (Blendrahmen/ Kämpfer, Kämpfer/Kämpfer) <i>Butt-joint connection (Frame/Transom, Transom/Transom)</i>		Multifunktionsstanzwerkzeug <i>Multi-function punching tool</i>
	Stanzen <i>Punching</i>		Presstawerkzeugsatz <i>Crimping tool set</i>

Profilseiten
Profile pages

Symbol Symbols	Bezeichnung Designation	Symbol Symbols	Bezeichnung Designation
	Selbstzuschnitt <i>Self-cut</i>		Gelenkeckwinkel, vertikal <i>Hinged corner angle, vertical</i>
	Presstaverbindung <i>Crimped connection</i>		Stift <i>Pin</i>
	Al-Strangpresseckwinkel <i>Extr. aluminium corner angle</i>		Kegelschraube <i>Conical screw</i>
	Breite Selbstzuschnitt <i>Width self-cut</i>		Gelenkeckwinkel <i>Hinged corner angle</i>
	Gelenkeckverbindung <i>Hinged corner connection</i>		Gelenkverbindung <i>Hinged connection</i>
	Bohren <i>Drilling</i>		Gelenkverbinder Außenschale <i>Hinged connector outer shell</i>
			Gelenkverbinder Innenschale <i>Hinged connector inner shell</i>
	Hauptsichtfläche <i>Main visible surface</i>		Nebensichtfläche <i>Secondary visible surface</i>

WICLINE

Mindest Stulpfenster Format
Minimum double casement window format

Technische Information *Technical Information*



Mindest Flügel- und Griffhöhen für Stulp-Beschlag
Minimum sash and handle heights for double casement fitting



Stulp-Beschlag, Kniehebel
Double casement fitting, toggle lever



Stulp-Beschlag, Stulpgetriebe
Double casement fitting, double casement gear

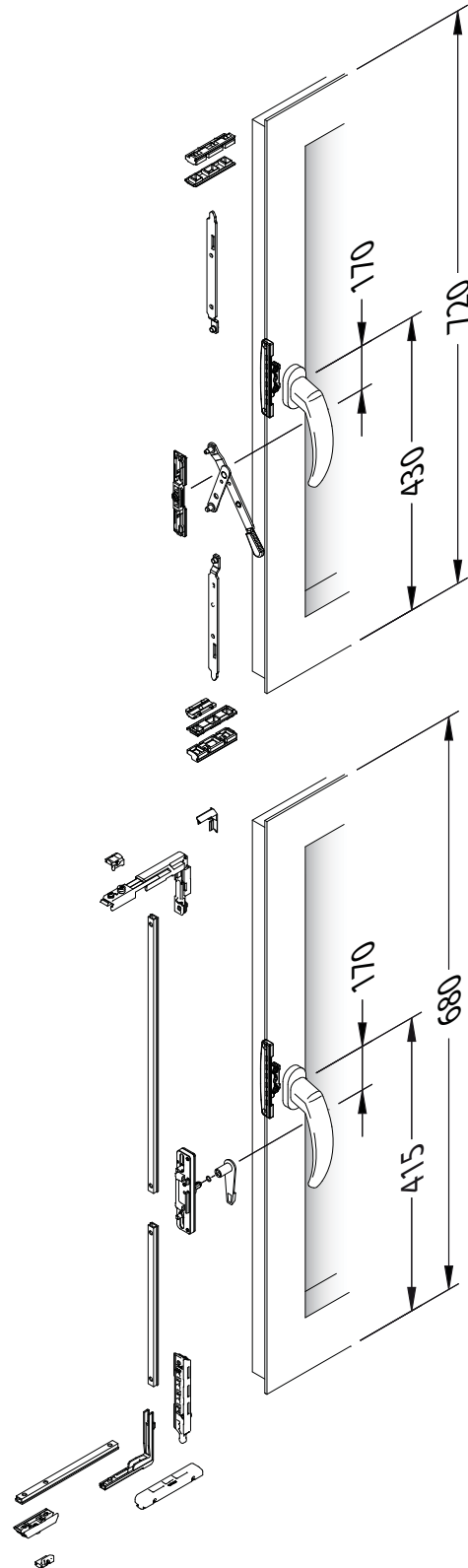

FAB Flügel - Außenmaß - Breite
Sash outer width dimension

FAH Flügel - Außenmaß - Höhe
Sash outer height dimension

Schräg-Fenster
Sloped window

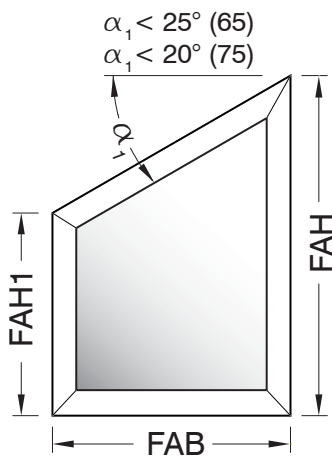

Segment-Fenster
Segmental window

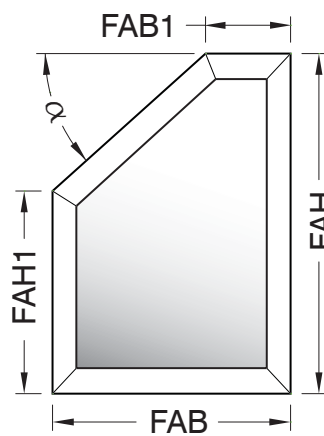

FAB (m)	α
0 - 1.0	$\leq 45^\circ$
1.0 - 1.1	$\leq 40^\circ$
1.1 - 1.2	$\leq 35^\circ$
1.2 - 1.3	$\leq 25^\circ$



FAB1 min. = 0.3 m

Rundbogen-Fenster
Semi-circular arch window

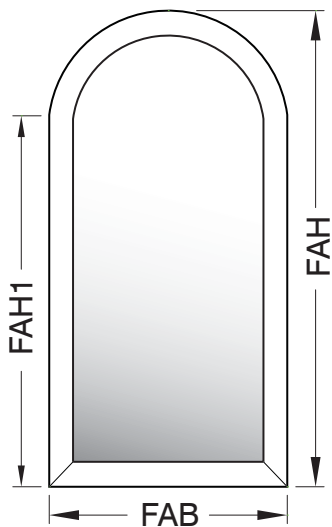

Stichbogen-Fenster
Segmental arch window

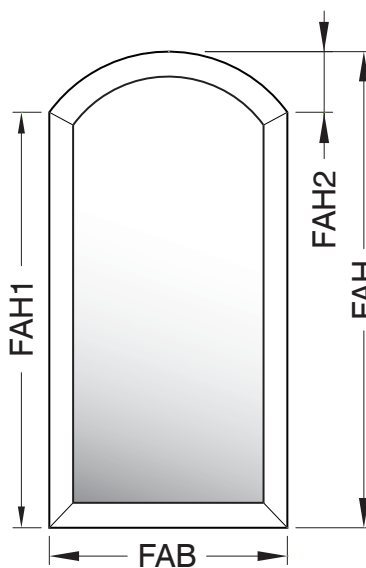

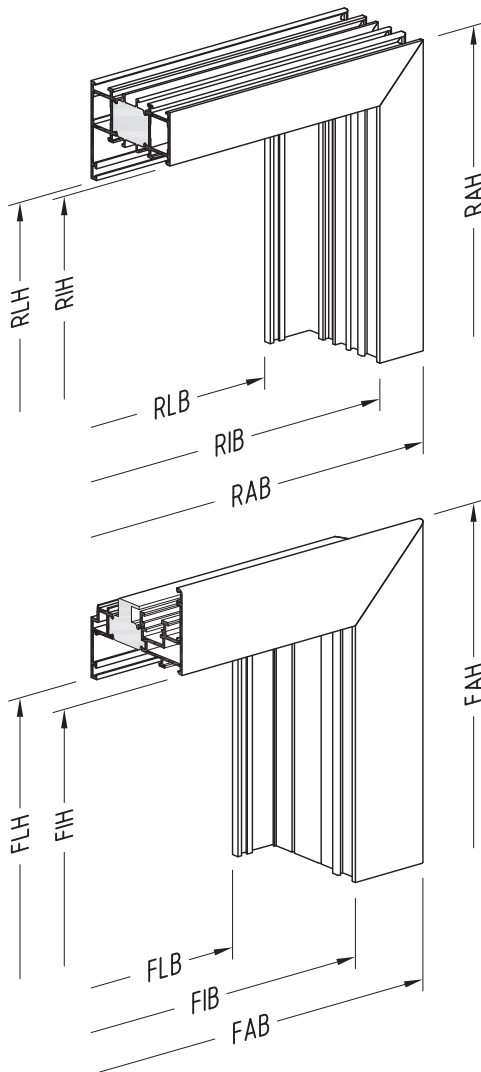

RAB	Rahmen - Außenmaß - Breite <i>Frame outer width dimension</i>
RIB	Rahmen - Innenmaß - Breite <i>Frame inner width dimension</i>
RLB	Rahmen - Lichtmaß - Breite <i>Frame width clearance dimension</i>
RAH	Rahmen - Außenmaß - Höhe <i>Frame outer height dimension</i>
RIH	Rahmen - Innenmaß - Höhe <i>Frame inner height dimension</i>
RLH	Rahmen - Lichtmaß - Höhe <i>Frame height clearance dimension</i>
FAB	Flügel - Außenmaß - Breite <i>Sash outer width dimension</i>
FIB	Flügel - Innenmaß - Breite <i>Sash inner width dimension</i>
FLB	Flügel - Lichtmaß - Breite <i>Sash width clearance dimension</i>
FAH	Flügel - Außenmaß - Höhe <i>Sash outer height dimension</i>
FIH	Flügel - Innenmaß - Höhe <i>Sash inner height dimension</i>
FLH	Flügel - Lichtmaß - Höhe <i>Sash height clearance dimension</i>

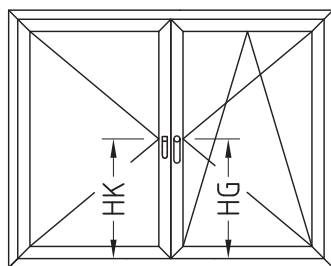

HG	Höhe Griff <i>Height of handle</i>
HK	Höhe Kniehebel, Stulp-Getriebe oder Stulpriegel-Verschluss <i>Height of toggle lever, double casement gear or double casement bolt lock</i>

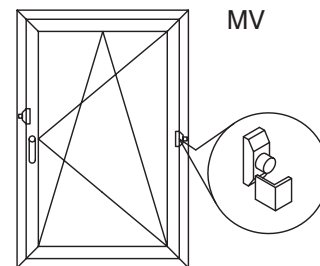

MV	Mittelverriegelung <i>Centre lock</i>
-----------	--



OKFF	Oberkante Fertig- fußboden <i>Top edge of finished floor</i>
-------------	--

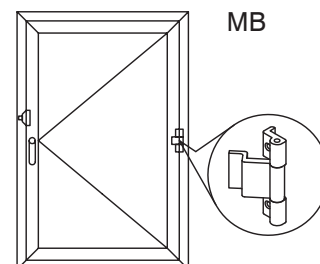

MB	Mittelband <i>Centre hinge</i>
-----------	-----------------------------------

Rahmen - Eckverbindungstechnik Frame corner connecting technique

Al-Gusseckwinkel / Cast aluminium corner angle

- Verbindung mit Schlaghülsen / Connection with drive bush
- Verbindung mit Kegelschrauben / Connection with conical screws
- Presstaverbindung / Crimped connection

Injektionsmethode / Injection method

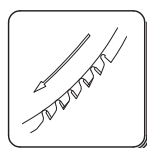

- Zuschnitt Profile (siehe Verarbeitungsrichtlinien / Bearbeitungsmittel)

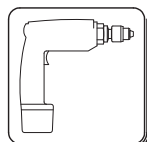

- Hülsenbohrungen von außen einbringen durch
 - Bohren (Schablone siehe Programm / WICPRO)
- oder

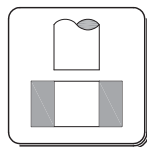

- Stanzen (Stanzwerkzeug siehe Programm / WICPRO)

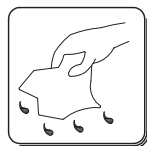

- Bearbeitungsstellen mit geeignetem Reinigungsmittel staub- u. fettfrei reinigen
- Profile mit Druckluft abblasen
- Angaben des Klebstoffherstellers beachten

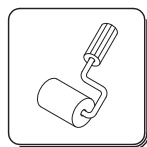

- Gehungsschnittfläche dichtend kleben

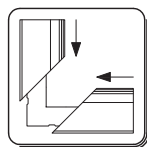

- Zusammenfügen der Profile gemäß Konstruktionspunkt (siehe nächste Seite und Programm / Profelseiten)
 - Pressta Verbindung
- oder
- Bolzen- oder Kegelschraubenverbindung

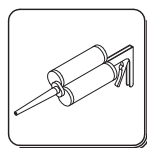

- Klebstoffinjektion durch
- Hülsen
- oder
- Injektionsbohrungen

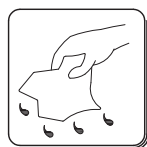

- Klebstoffreste mit geeignetem Reiniger entfernen

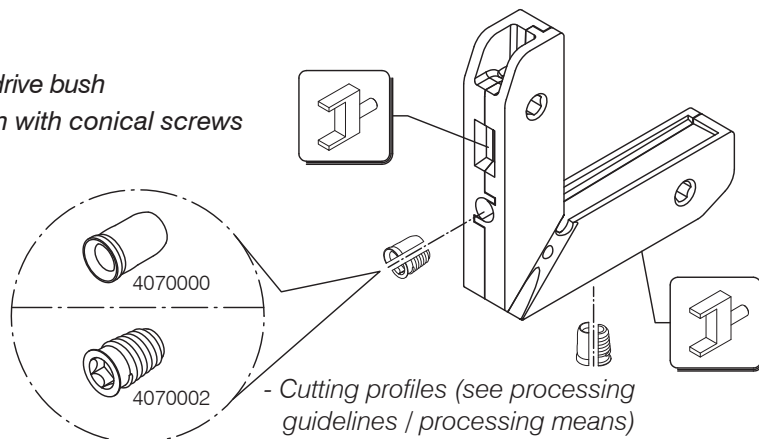

- Cutting profiles (see processing guidelines / processing means)

- Drill boreholes from outside for drive bushes (see Programme List / WICPRO for drill templates)

or

- Punching (see Programme List / WICPRO for punching tool)

- Clean processing areas dust and grease free with appropriate cleaning agents
- Blow off profiles with compressed air
- Consider instructions of adhesive manufacturers

Glue compact mitre cut surface

Join profiles according to construction point (see next page and profile pages in the Programme List)

- Crimped connection
- or
- Connection with drive bush or conical screw

- Glue injection through
- drive bush
- or
- injection holes

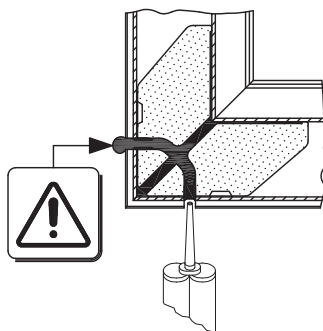

Remove glue residue with appropriate cleaner

	Seite Page
Serienbeschreibung <i>Description of series</i>	2/3
Profilübersichten <i>Survey of profiles</i>	2/7
Profile sichtbarer Flügel <i>Profiles visible sash</i>	2/13
Blendrahmenprofile <i>Frame profiles</i>	2/14
Flügelprofile <i>Sash profiles</i>	2/23
Stulpflügelprofile <i>Double casement sash profiles</i>	2/28
Kämpferprofile <i>Transom profiles</i>	2/30
Aufsatzprofile <i>Supplementary profiles</i>	2/35
Anwendungsbeispiele sichtbarer Flügel <i>Examples of application visible sash</i>	2/36
Profile verdeckter Flügel <i>Profiles concealed sash</i>	2/45
Blendrahmenprofile <i>Frame profiles</i>	2/46
Flügelprofile <i>Sash profiles</i>	2/49
Stulpflügelprofile <i>Double casement sash profiles</i>	2/52
Kämpferprofile <i>Transom profiles</i>	2/55
Aufsatzprofile <i>Supplementary profiles</i>	2/56
Anwendungsbeispiele verdeckter Flügel <i>Examples of application concealed sash</i>	2/57
Glasleistenprofile - Auswahltabellen <i>Glazing bead profiles - Selection tables</i>	2/65

	Seite Page
Verdeckte Beschläge <i>Concealed fittings</i>	2/75
Zulässige Flügelgrößen <i>Admissible sash sizes</i>	2/76
Zulässige Formatgrößen <i>Admissible format sizes</i>	2/92
Beschlagsübersichten <i>Survey of fittings</i>	2/101
Aufliegende Beschläge <i>Top mounted fittings</i>	2/117
Zulässige Flügelgrößen <i>Admissible sash sizes</i>	2/118
Zulässige Formatgrößen <i>Admissible format sizes</i>	2/135
Beschlagsübersichten <i>Survey of fittings</i>	2/149

WICLINE 75 TOP

Serienbeschreibung Description of series

Passivhaustaugliches Fenstersystem Sichtbare Flügelprofile

Window system on passive house level
Visible sash profiles

Technische Werte:

Beschreibung	Norm	Klasse
Wärmedämmung U_f	EN ISO 10077-2	0,79 - 1,3 W/(m ² K)
Wärmedämmung U_w	EN ISO 10077-1	bis 0,77 W/(m ² K) *
Schalldämmung R_w (C;C _{tr})	EN ISO 717-1	bis 47 (-1;-4) dB
Einbruchhemmung	EN 1627	bis RC 3
Durchschusshemmung	EN 1522	bis FB 4NS
Luftdurchlässigkeit	EN 12207	4
Schlagregendichtheit	EN 12208	bis E1050
Windlastwiderstand	EN 12210	bis C5/B5
Mechanische Festigkeit	EN 13115	bis 4
Dauerfunktion	EN 12400	bis 3

* Für Fenster 1230 x 1480 mit Flügel-Rahmenkombinationen (Ansichtsbreit 142 mm) in Verbindung mit 3-fach Verglasung und thermisch optimiertem Randverbund

Technical values:

Description	Technical standard	Class
Thermal insulation U_f	EN ISO 10077-2	0,79 - 1,3 W/(m ² K)
Thermal insulation U_w	EN ISO 10077-1	to 0,77 W/(m ² K) *
Sound insulation R_w (C;C _{tr})	EN ISO 717-1	to 47 (-1;-4) dB
Burglar resistance	EN 1627	to RC 3
Bullet resistance	EN 1522	to FB 4NS
Air permeability	EN 12207	4
Water tightness	EN 12208	to E1050
Wind load resistance	EN 12210	to C5/B5
Mechanical strength	EN 13115	to 4
Long term functionality	EN 12400	to 3

* For windows 1230 x 1480 with sash-frame combinations (sight lines 142 mm) with triple glazing and thermally optimized compound edge

Systemprüfung des Fenstersystems mit ift-Produktpass als Basis für CE-Kennzeichnung nach DIN EN 14351-1 und Erfüllung der Mindestanforderungen für das RAL-Gütezeichen RAL-GZ 695

System testing of the window system with ift product pass as base for the CE marking to DIN EN 14351-1 and compliance with the minimum requirements for the RAL quality marking RAL-GZ 695

Profiltechnik:

Rahmenbautiefe: 75 mm
Rahmenfalzhöhe: 25 mm
Gesamtbautiefe Profilsystem: 85 mm

Profile technique:

Frame construction depth: 75 mm
Frame rebate height: 25 mm
Overall construction depth profile system: 85 mm

Profilansichtsbreiten:

Blendrahmenprofile von 48 mm bis 155 mm
Kämpferprofile von 80 mm bis 250 mm
Flügelprofile von 34 mm bis 71 mm

Profile sight lines:

Frame profiles from 48 mm to 155 mm
Transom profiles from 80 mm to 250 mm
Sash profiles from 34 mm to 71 mm

Öffnungsarten:

- Dreh-, Dreh-Kipp-, Kippfenster, Tilt-First
- Oberlicht
- Stulpfenster

Opening types:

- Turn, turn/tilt, tilt, tilt-first,
- Fanlight
- Double casement window

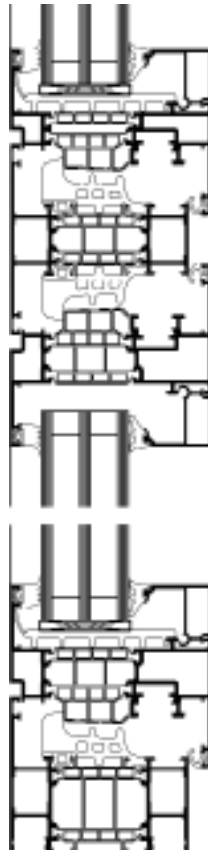

Dreh-, Dreh-Kipp-, Kippfenster
mit innerem Überschlag,
kombiniert mit Oberlichtflügel
Turn, turn/tilt, tilt window
with overlapping sash
combined with fanlight sash

WICLINE 75 TOP

Serienbeschreibung Description of series

Passivhaustaugliches Fenstersystem Sichtbare Flügelprofile

Window system on passive house level
Visible sash profiles

Konstruktionsmerkmale:

Hauptprofile als Mehrkammer-Verbundprofile,
Kantenradius $\leq 0,5$ mm

ETC Intelligence® Verbundzone:

Die neuen ETC Intelligence® Verbundzonen ermöglichen durch ihren intelligenten Materialmix U_f -Werte für Flügel-Blendrahmen-Kombinationen bis $1,0$ $W/(m^2K)$ ohne Dämmeinschübe.

Profilverbundherstellung ausschließlich werksseitig mit Qualitätssicherung und Werksgarantie auch für nachträgliche Oberflächenbehandlungen (Anodisieren, Nass- und Pulverbeschichtung)

Gerundete Flügelüberschläge mit 10 mm Flächenversatz und 5 mm Rahmenüberschlag. Flügel- und Rahmenaußen-schalen flächenbündig bei sichtbarem Flügelrahmen.

Gehrungsverbindung durch systemeigene hohlkammerfüllende Gusseckwinkel mit Spreiz- und Klebemengen- Kontrollfunktion.

Stumpfe Verbindungen mit systemeigenen, hohlkammerfüllenden Aluminium-Profilverbindern und mengenbegrenzter Klebstoffinjektion.

Gesicherte Entwässerung und Dampfdruckausgleich wahlweise über außen sichtbare Entwässerungsabdeckungen oder verdeckt über Profilaußenschale.

Vierseitig umlaufender Mitteldichtungsrahmen in Eigenfertigung aus EPDM-Schaum koextrudiert, in den Fensterecken unterbrechungsfrei ohne Einschnitte verlegt.

Innere Anschlagdichtung umlaufend, unterbrechungsfrei, ohne Aussparung im Bereich der Bänder

Verglasungsdichtung außen aus EPDM-Schaum koextrudiert.

Füllungsdicken Festverglasung von 1 – 55 mm
Füllungsdicken Flügel von 11 – 65 mm

Konstruktionsvarianten

- Verdeckter Flügel
- Alternative Ausführung Mitteldichtung
- Einbruchhemmung RC 1N-RC3
- Durchschusshemmung FB4
- Einspannblendrahmen für Fassade

WICSTAR DPS Systembeschläge:

Hochwertige vollständig verdeckte Systembeschläge mit Direkt- Positioning- System (DPS). Bauteilmontage in beliebiger Reihenfolge. Zulässige Flügelgewichte für verdeckte Bänder 160 kg, für aufliegend Bänder 200 kg

Systemkombinationen:

WICLINE 75 TOP Fenster sind kombinierbar mit WICLINE 75 evo Fenstern und WICSTYLE 75 evo Türen und über Einspannblendrahmen mit dem aktuellen WICTEC-Fassaden-Programm.

Design characteristics:

Main profiles as multi cavities compound profiles,
edge radii $\leq 0,5$ mm

ETC Intelligence® compound zone:

The new ETC Intelligence® compound zone achieves through its intelligent material mix U_f -values for sash-frame combinations down to 1.0 $W/(m^2K)$ without intersion of insulation parts. Profile compound production exclusively in the workshop with quality assurance and factory warranty also for subsequent surface treatments (anodizing, wet and powder coating)

Rounded sash overlaps with 10 mm offset and 5 mm frame profile overlap. Sash and frame outer shells flush for visible sashes.

Mitre corner connection by system specific cavity filling cast aluminium expanding corner angles and quantity controlled glue injection.

Butt joint connections by system specific, cavity filling aluminium connectors and quantity controlled glue injection.

Safe drainage and pressure equalization either through externally visible weephole covers or concealed through profile outer shells.

Perimetric, self-made centre gasket frame made of coextruded EPDM foam, running around window corners without interruptions and incisions.

Perimetric, continuous inner overlap gasket, without cutout in hinge areas.

Outer glazing gasket made of coextruded EPDM foam.

Infill thicknesses for fixed glazing from 1 - 55 mm
Infill thicknesses for sash from 11 - 65 mm

Design variants

- Concealed sash
- Alternative version of central gasket
- Burglary resistance RC 1N-RC3
- Bullet resistance FB4
- Insertion frame for façade

WICSTAR DPS system fittings:

High quality completely concealed system hardware with Direct Positioning System (DPS). Component installation possible in any order. Admissible sash weights for concealed hinges 160 kg, for visible hinges 200 kg.

System combinations:

WICLINE 75 TOP windows can be combined with WICLINE 75 evo windows and WICSTYLE 75 evo doors and by means of insertion frames with the present WICTEC façade range.

WICLINE 75 TOP

Serienbeschreibung Description of series

Passivhaustaugliches Fenstersystem
Verdeckte Flügelprofile

Window system on passive house level
Concealed sash profiles

Technische Werte:

Beschreibung	Norm	Klasse
Wärmedämmung U_f	EN ISO 10077-2	0,97 - 1,3 W/(m ² K)
Wärmedämmung U_w	EN ISO 10077-1	bis 0,75 W/(m ² K) *
Schalldämmung R_w ($C;C_w$)	EN ISO 717-1	bis 46 (-1;-4) dB
Einbruchhemmung	EN 1627	bis RC 3
Luftdurchlässigkeit	EN 12207	4
Schlagregendichtheit	EN 12208	bis E1050
Windlastwiderstand	EN 12210	bis C5/B5
Mechanische Festigkeit	EN 13115	bis 4
Dauerfunktion	EN 12400	bis 3

* Für Fenster 1230 x 1480 mit Flügel-Rahmenkombinationen (Ansichtsbreit 74 mm) in Verbindung mit 3-fach Verglasung und thermisch optimiertem Randverbund

Technical values:

Description	Technical standard	Class
Thermal insulation U_f	EN ISO 10077-2	0,97 - 1,3 W/(m ² K)
Thermal insulation U_w	EN ISO 10077-1	to 0,75 W/(m ² K) *
Sound insulation R_w ($C;C_w$)	EN ISO 717-1	to 46 (-1;-4) dB
Burglar resistance	EN 1627	to RC 3
Air permeability	EN 12207	4
Water tightness	EN 12208	to E1050
Wind load resistance	EN 12210	to C5/B5
Mechanical strength	EN 13115	to 4
Long term functionality	EN 12400	to 3

* For windows 1230 x 1480 with sash-frame combinations (sight lines 74 mm) with triple glazing and thermally optimized compound edge

Systemprüfung des Fenstersystems mit ift-Produktpass als Basis für CE-Kennzeichnung nach DIN EN 14351-1 und Erfüllung der Mindestanforderungen für das RAL-Gütezeichen RAL-GZ 695

System testing of the window system with ift product pass as base for the CE marking to DIN EN 14351-1 and compliance with the minimum requirements for the RAL quality marking RAL-GZ 695

Profiltechnik:

Rahmenbautiefe: 75 mm
Rahmenfalzhöhe: 25 mm
Gesamtbautiefe Profilsystem: 85 mm

Profile technique:

Frame construction depth: 75 mm
Frame rebate height: 25 mm
Overall construction depth profile system: 85 mm

Profilansichtsbreiten:

Blendrahmenprofile 74 mm und 84 mm
Kämpferprofile 118 mm
Flügelprofile 65 mm (innere Ansichtsbreite)

Profile sight lines:

Frame profiles 74 mm and 84 mm
Transom profiles 118 mm
Sash profiles 65 mm (inner sight line)

Öffnungsarten:

- Dreh-, Dreh-Kipp-, Kippfenster, Tilt-First
- Oberlicht
- Stulpfenster

Opening types:

- Turn, turn/tilt, tilt, tilt-first,
- Fanlight
- Double casement window

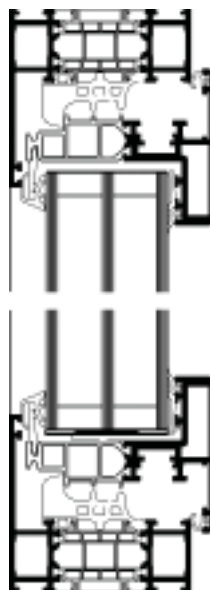

Dreh-, Dreh-Kipp-, Kippfenster mit verdeckliegendem Flügel Verglasung von außen
Turn, turn/tilt, tilt window with concealed sash glazing from outside

WICLINE 75 TOP

Serienbeschreibung Description of series

Passivhaustaugliches Fenstersystem Verdeckte Flügelprofile

Window system on passive house level
Concealed sash profiles

Konstruktionsmerkmale:

Hauptprofile als Mehrkammer-Verbundprofile,
Kantenradius $\leq 0,5$ mm

ETC Intelligence® Verbundzone:

Die neuen ETC Intelligence® Verbundzonen ermöglichen durch ihren intelligenten Materialmix U_f -Werte für Flügel-Blendrahmen-Kombinationen bis $1,2 \text{ W}/(\text{m}^2\text{K})$ ohne Dämmeinschübe.

Profilverbundherstellung ausschließlich werksseitig mit Qualitätssicherung und Werksgarantie auch für nachträgliche Oberflächenbehandlungen (Anodisieren, Nass- und Pulverbeschichtung).

Gerundete Flügelüberschläge mit 10 mm Flächenversatz und 5 mm Rahmenüberschlag. Flügel- und Rahmenaußen-schalen flächenbündig bei sichtbarem Flügelrahmen.

Gehrungsverbindung durch systemeigene hohlkammerfüllende Gusseckwinkel mit Spreiz- und Klebemengen- Kontrollfunktion.

Stumpfe Verbindungen mit systemeigenen, hohlkammerfüllenden Aluminium-Profilverbindern und mengenbegrenzter Klebstoffinjektion.

Gesicherte Entwässerung und Dampfdruckausgleich wahlweise über außen sichtbare Entwässerungsabdeckungen oder verdeckt über Profilaußenschale.

Vierseitig umlaufender Mitteldichtungsrahmen in Eigenfertigung aus EPDM-Schaum koextrudiert, in den Fensterecken unterbrechungsfrei ohne Einschnitte verlegt.

Innere Anschlagdichtung umlaufend, unterbrechungsfrei, ohne Aussparung im Bereich der Bänder

Verglasungsdichtung außen aus EPDM-Schaum koextrudiert.

Füllungsdicken Festverglasung von 1 – 55 mm
Füllungsdicken Flügel von 33 – 50 mm

Konstruktionsvarianten

- Alternative Ausführung Mitteldichtung
- Einbruchhemmung RC 1N-RC3
- Einspannblendrahmen für Fassade

WICSTAR DPS Systembeschläge:

Hochwertige vollständig verdeckte Systembeschläge mit Direkt- Positioning- System (DPS).
Bauteilmontage in beliebiger Reihenfolge.
Zulässige Flügelgewichte für verdeckte Bänder 130 kg, für aufliegend Bänder 130 kg

Systemkombinationen:

WICLINE 75 TOP Fenster mit verdeckten Flügelprofilen sind kombinierbar mit WICLINE 75 evo Fenstern und über Einspannblendrahmen mit dem aktuellen WICTEC-Fassaden-Programm.

Design characteristics:

Main profiles as multi cavities compound profiles,
edge radii $\leq 0,5$ mm

ETC Intelligence® compound zone:

The new ETC Intelligence® compound zone achieves through its intelligent material mix U_f -values for sash-frame combinations down to $1.2 \text{ W}/(\text{m}^2\text{K})$ without intersion of insulation parts. Profile compound production exclusively in the workshop with quality assurance and factory warranty also for subsequent surface treatments (anodizing, wet and powder coating).

Rounded sash overlaps with 10 mm offset and 5 mm frame profile overlap. Sash and frame outer shells flush for visible sashes.

Mitre corner connection by system specific cavity filling cast aluminium expanding corner angles and quantity controlled glue injection.

Butt joint connections by system specific, cavity filling aluminium connectors and quantity controlled glue injection.

Safe drainage and pressure equalization either through externally visible weephole covers or concealed through profile outer shells.

Perimetric, self-made centre gasket frame made of coextruded EPDM foam, running around window corners without interruptions and incisions.

Perimetric, continuous inner overlap gasket, without cutout in hinge areas.

Outer glazing gasket made of coextruded EPDM foam.

Infill thicknesses for fixed glazing from 1 - 55 mm
Infill thicknesses for sash from 33 - 50 mm

Design variants

- Alternative version of central gasket
- Burglary resistance RC 1N-RC3
- Insertion frame for façade

WICSTAR DPS system fittings:

High quality completely concealed system hardware with Direct Positioning System (DPS).
Component installation possible in any order.
Admissible sash weights for concealed hinges 130 kg, for visible hinges 130 kg.

System combinations:

WICLINE 75 TOP windows with concealed sash profiles can be combined with WICLINE 75 evo windows and by means of insertion frames with the present WICTEC façade range.

Profilübersicht
Survey of profiles

Blendrahmenprofile
Frame profiles

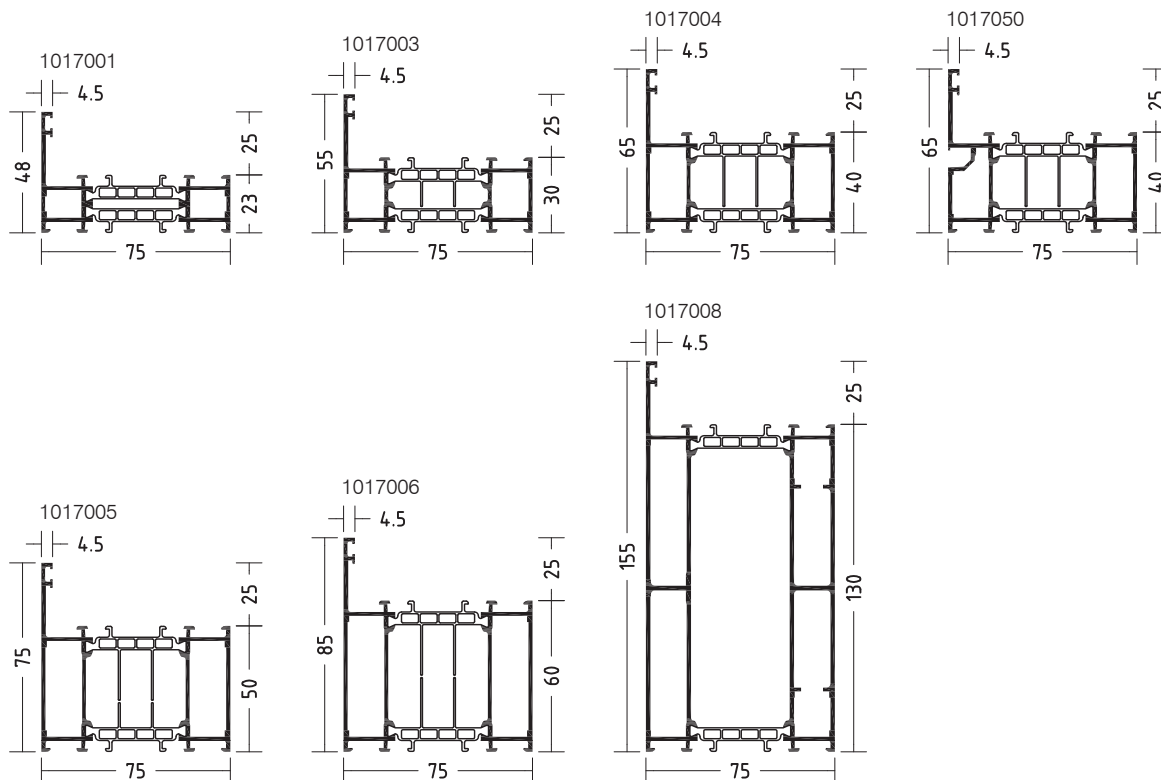

Einspann-Blendrahmenprofile
Clamping frame profiles

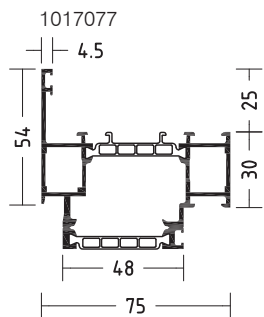

Dehnstoßprofile
Expansion joint profiles

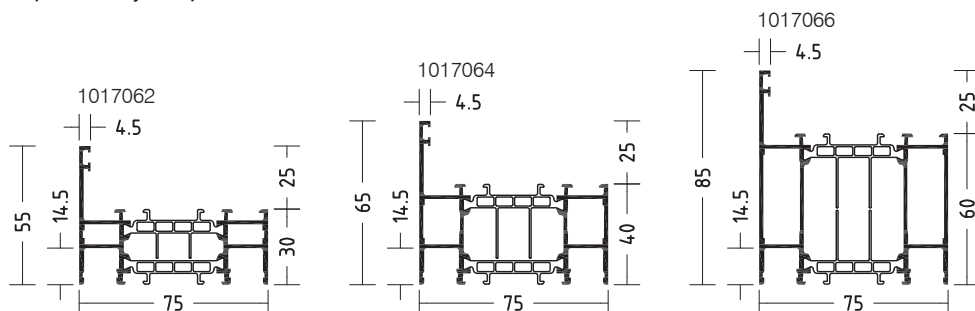

Profilübersicht
Survey of profiles

Flügelprofile
Sash profiles

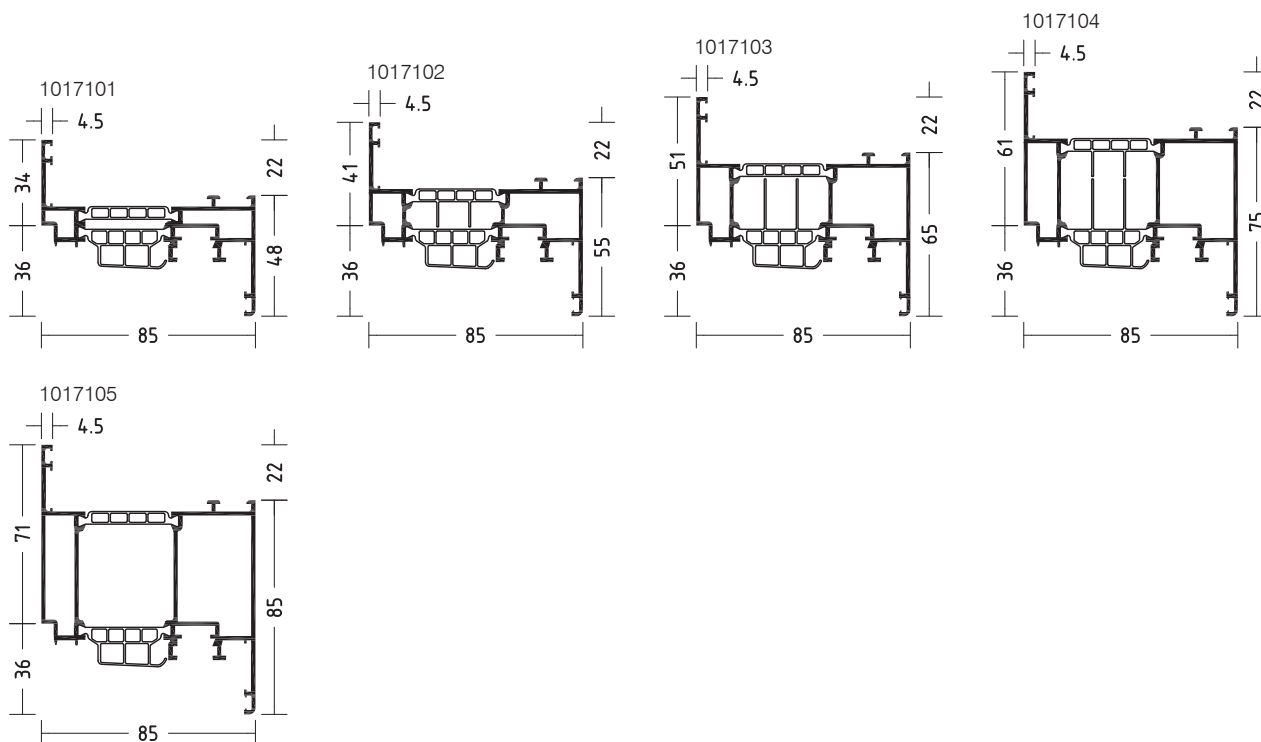

Stulpflügelprofile
Double casement sash profiles

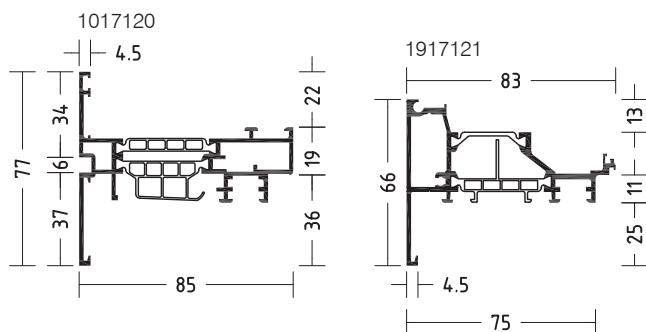

Kämpferprofile
Transom profiles

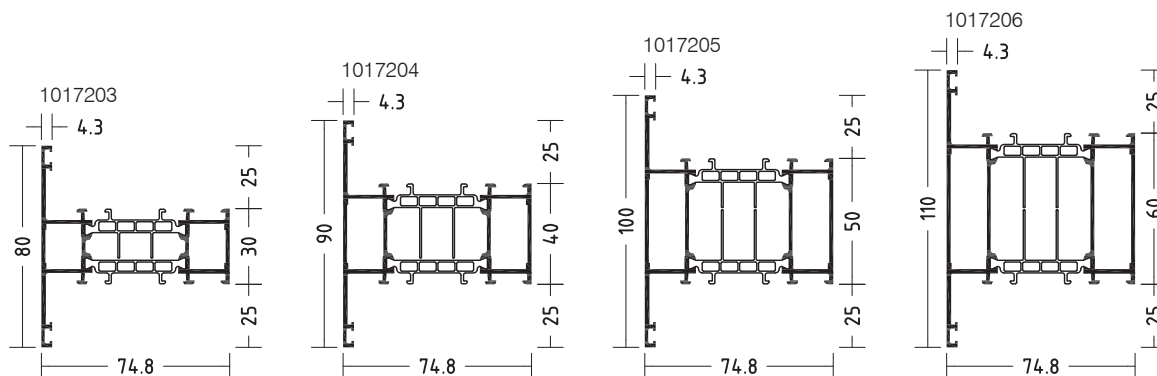

WICLINE 75 TOP

Profilübersicht
Survey of profiles

Kämpferprofile
Transom profiles

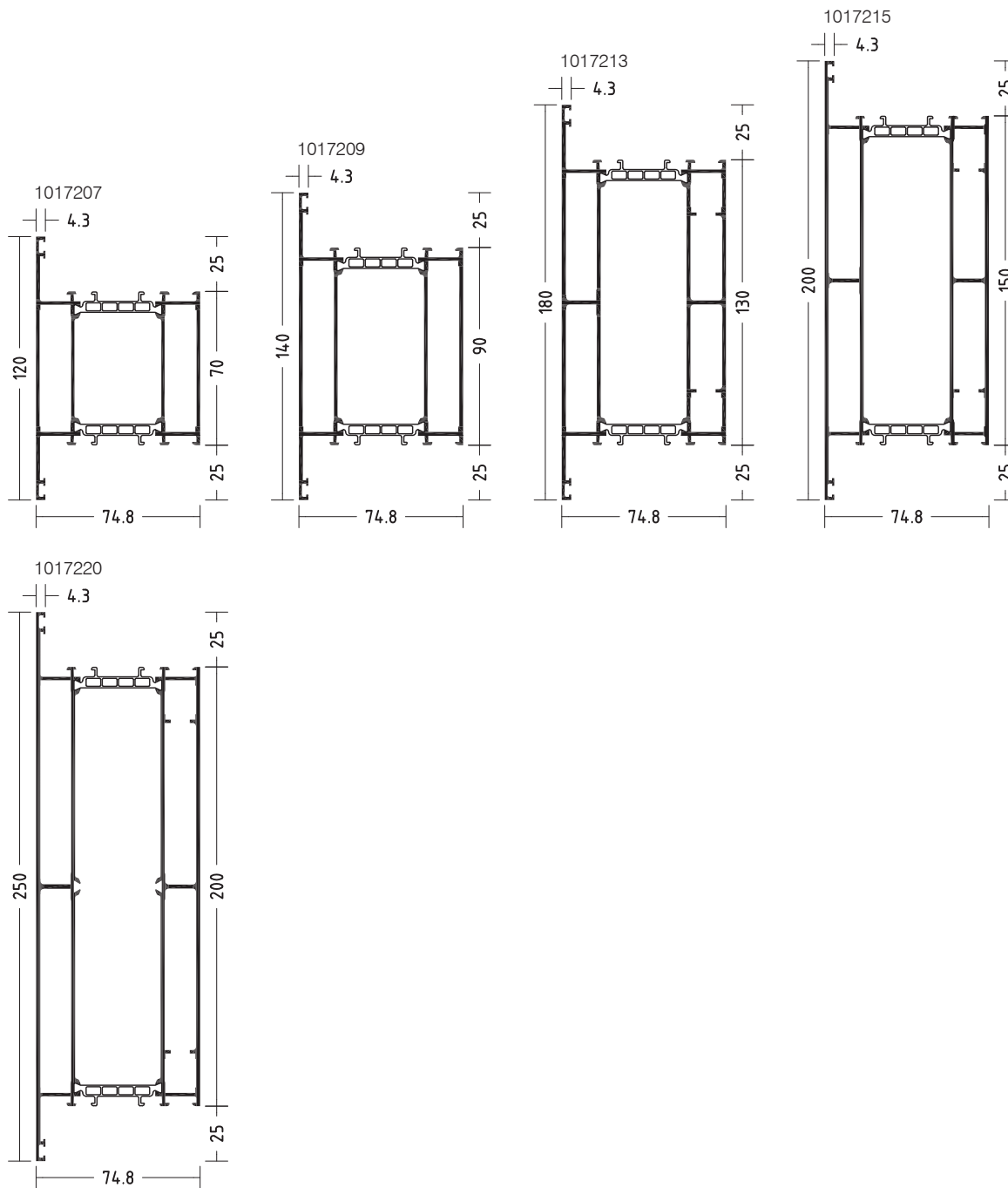

Profilübersicht
Survey of profiles

Blendrahmenprofile verdeckter Flügel
Frame profiles for concealed sash

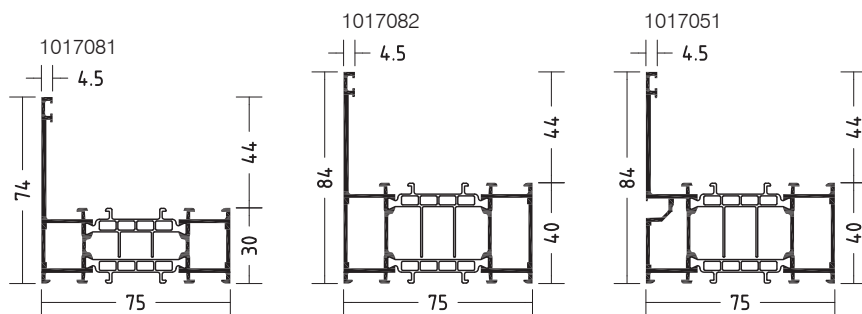

Einspann-Blendrahmenprofil verdeckter Flügel
Clamping frame profile for concealed sash

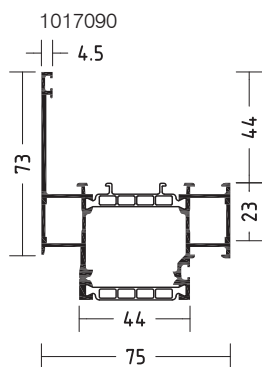

Aufsatzprofile
Supplementary profiles

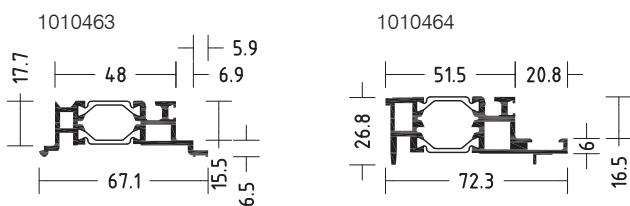

Profilübersicht
Survey of profiles

Verdecktliegende Flügelprofile

Concealed sash profiles

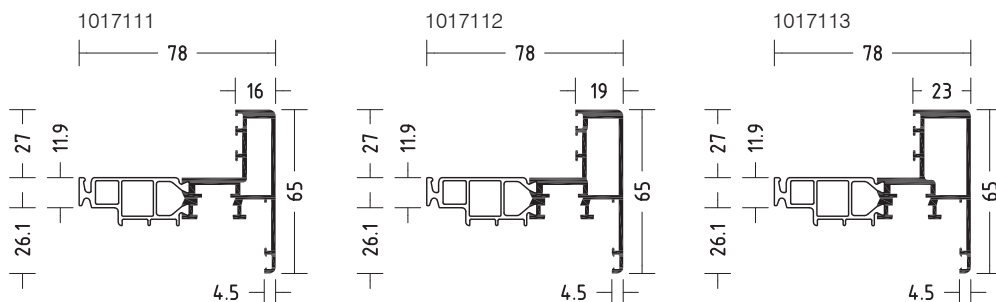

Verdecktliegende Stulpflügelprofile

Concealed double casement sash profiles

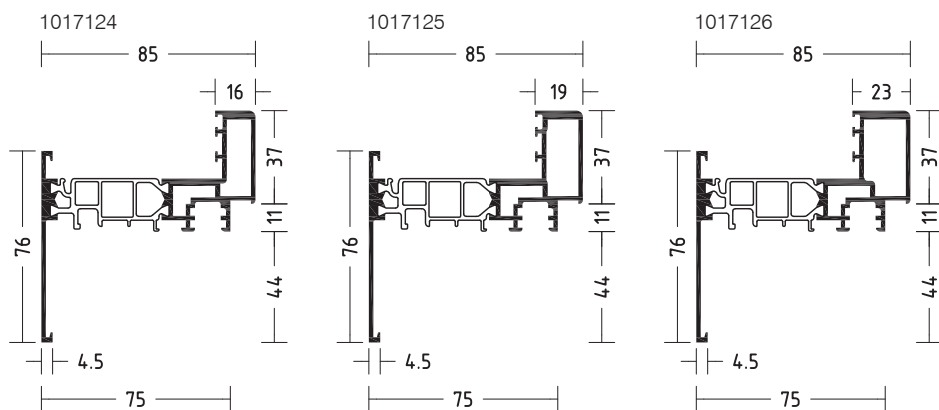

Kämpferprofile verdeckter Flügel

Transom profiles for concealed sash

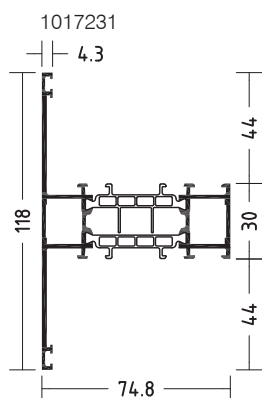

Profilübersicht
Survey of profiles

Glasleistenprofile 18 mm

Glazing bead profiles 18 mm

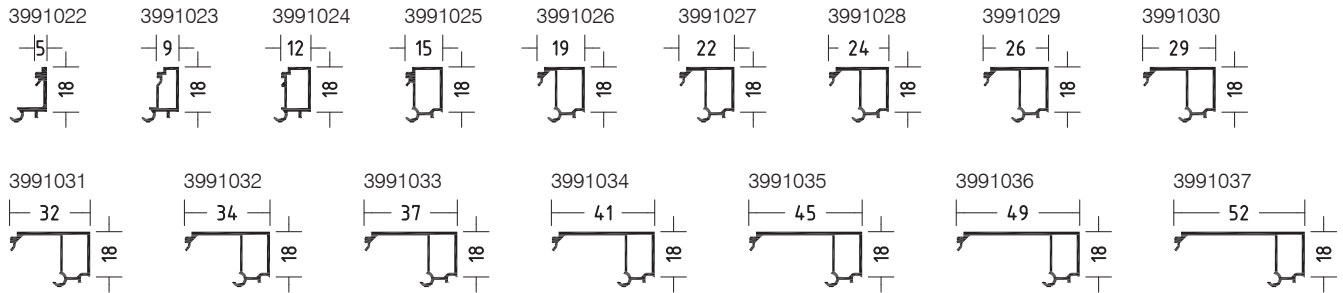

Glasleistenprofile 22 mm

Glazing bead profiles 22 mm

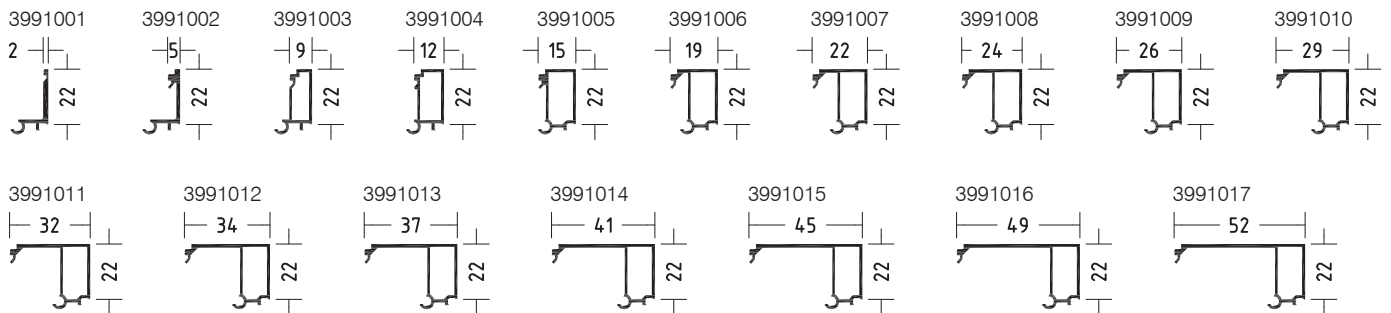

Glasleistenprofil für Senk-Klappfenster

Glazing bead profile for italian style window



Glasleistenprofile Trockenverglasung / Nassverglasung

Glazing bead profiles dry glazing / wet glazing

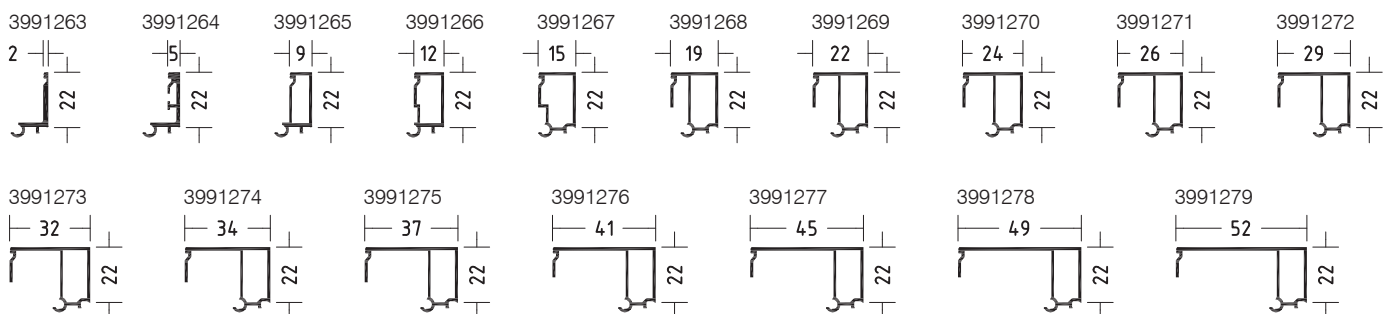

Glasleistenprofile Industrie-Design

Glazing bead profiles Industrial design

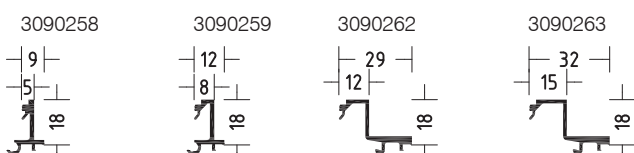

Sichtbarer Flügel

Visible sash

Profile

Profiles

2/14















Anwendungsbeispiele

Examples of application

2/36

WICLINE 75 TOP

Blendrahmenprofile Frame profiles

	 m	 mm	 mm									
 1017001	6,5	285	71	4950006	2x4070000	1x4960002	1x4070000	-	5910006	5940101	5940001	5930003
				4950006	2x4070000	1x4960002	1x4070000	-	5910006	5940101	5940001	5930003
1017003	6,5	299	85	4950008	2x4070000	1x4960004	1x4070000	1x4070030	5910006	5940101	5940001	5930003
				4950008	2x4070000	1x4960004	1x4070000	1x4070030	5910006	5940101	5940001	5930003

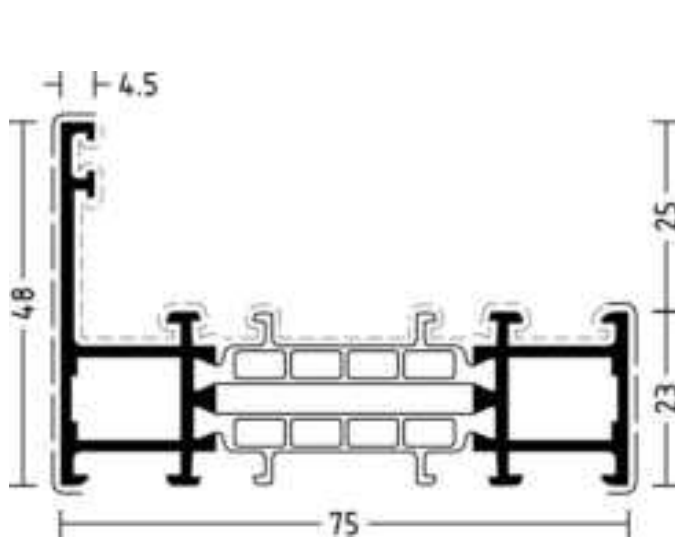





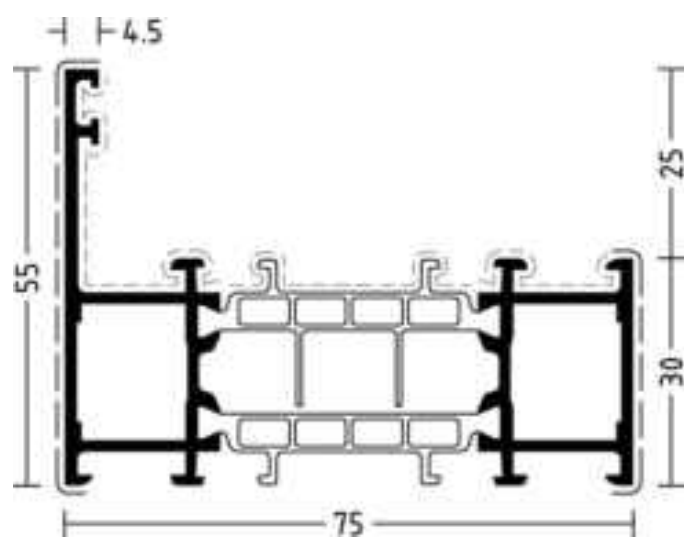









1017001

Gelenckwinkel und Gelenkverbinder siehe Zusatzartikel.
See additional articles for hinged corner angles and hinged connectors.



1017003

Gelenckwinkel und Gelenkverbinder siehe Zusatzartikel.
See additional articles for hinged corner angles and hinged connectors.

												
	m	mm	mm									
 1017004	6,5	319	105	4950009	2x4070000	1x4960005	1x4070000	1x4070030	5910006	5940101	5940001	5930003
				4950009	2x4070000	1x4960005	1x4070000	1x4070030	5910006	5940101	5940001	5930003
1017050	6,5	336	98	4050574	2x4070000	-	-	-	5910006	5940101	5940001	5930003
				4950009	2x4070000	-	-	-	5910006	5940101	5940001	5930003

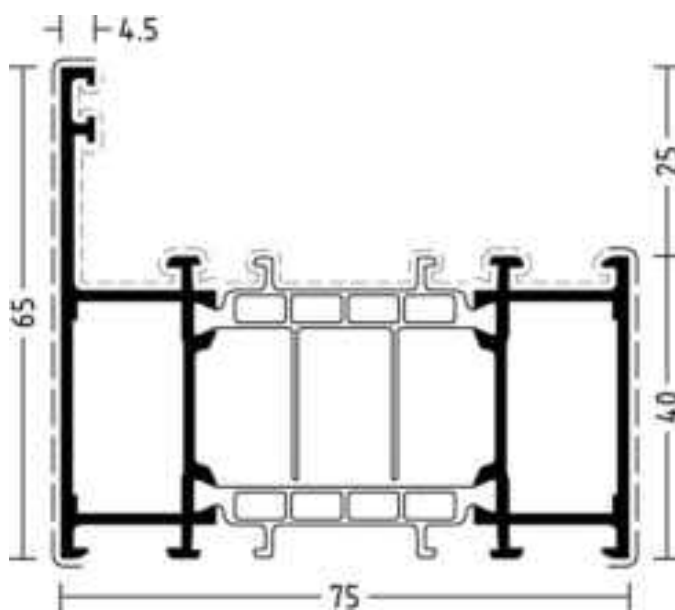

1017004

Gelenckwinkel und Gelenkverbinder siehe Zusatzartikel.
See additional articles for hinged corner angles and hinged connectors.

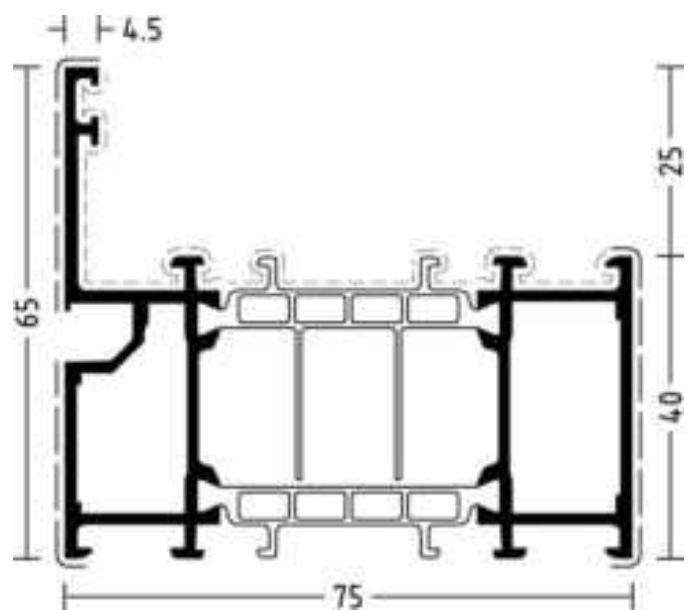















1017050

Stoßverbinder für Kämpferprofile siehe Seiten „Kämpferstoßverbinder“.
See pages „Transom butt-joint connection“ for butt-joint connectors for transom profiles.

WICLINE 75 TOP

Blendrahmenprofile
Frame profiles



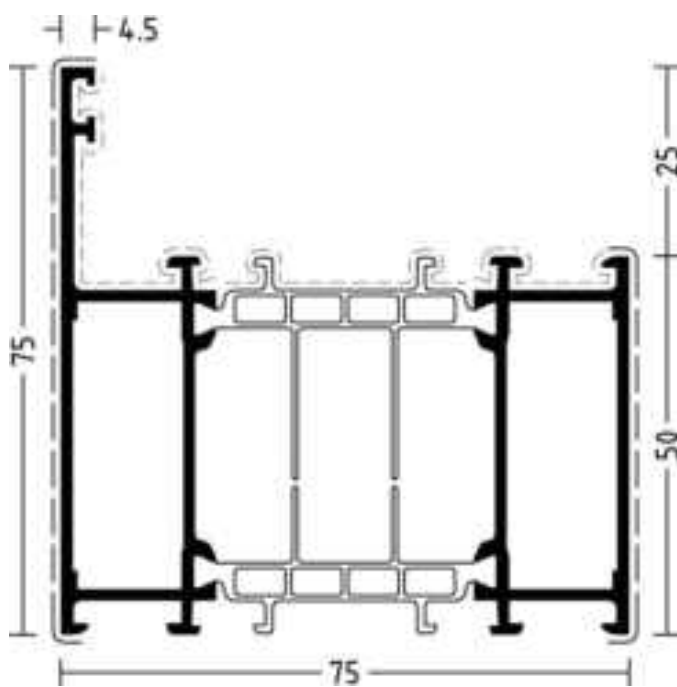











	 m	 mm	 mm									
 1017005	6,5	339	125	4950010	2x4070000	1x4960006	1x4070000	1x4070030	5910006	5940101	5940001	5930003
				4950010	2x4070000	1x4960006	1x4070000	1x4070030	5910006	5940101	5940001	5930003



1017005

WICLINE 75 TOP

Blendrahmenprofile
Frame profiles

												
	m	mm	mm									
 1017006	6,5	359	145	4950011	2x4070000	1x4960007	2x4070000	2x4070030	5910006	5940101	5940001	5930003
				4950011	2x4070000	1x4960007	2x4070000	2x4070030	5910006	5940101	5940001	5930003

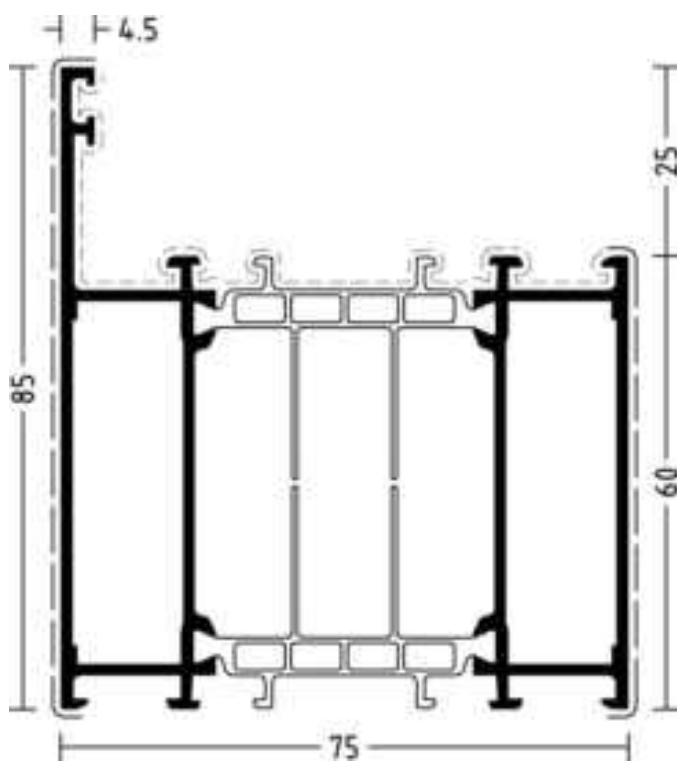

1017006

WICLINE 75 TOP

Blendrahmenprofile
Frame profiles

Icon	m	mm	mm	Icon		Icon			Icon				
				Icon	Icon	Icon	Icon	Icon	Icon	Icon	Icon	Icon	
☒	1017008	6,5	499	285	-	-	2x4960008	2x4070000	2x4070030	5910006	5940101	5940001	-
☒					-	-	2x4960004	2x4070000	2x4070030	5910006	5940101	5940001	-

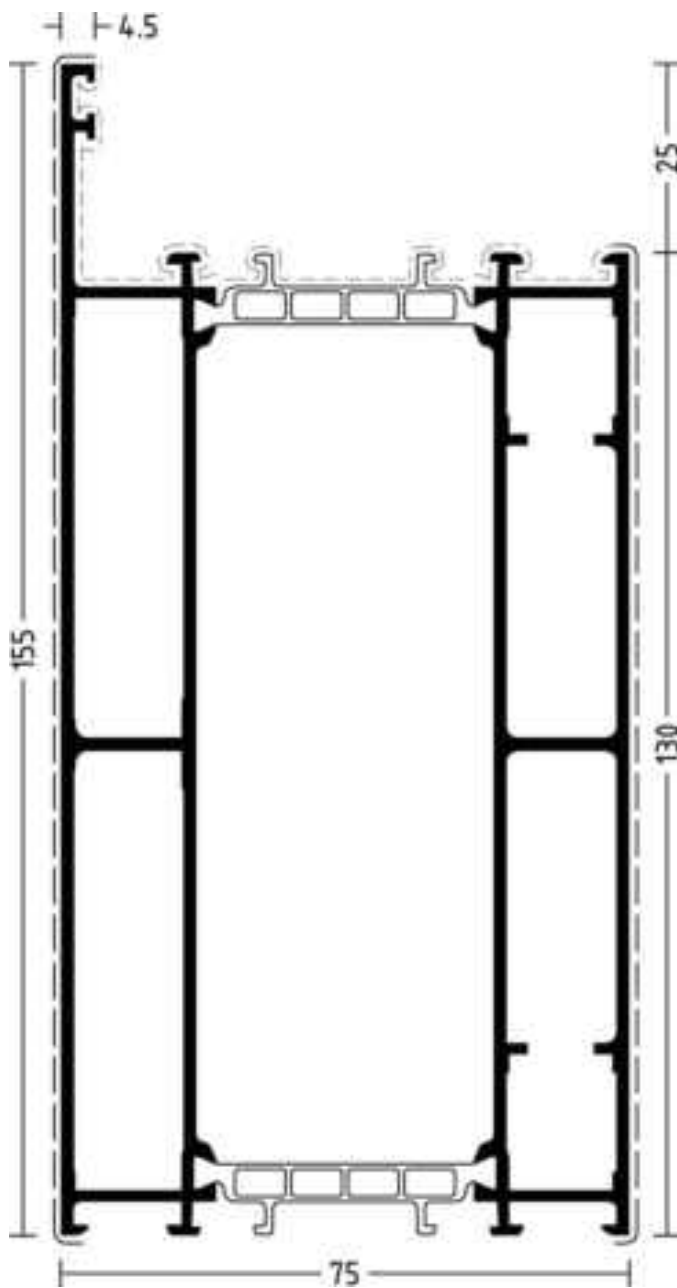

1017008

WICLINE 75 TOP

Blendrahmenprofile Frame profiles

Icon	1017062	Dimensions			Material		Accessories			Other			
		m	mm	mm	4950005	2x4070009	4950005	2x4070009	5910006	5910006	5910006	5910006	5930003
☒	1017062	6,5	330	85	4950005	2x4070009	-	-	-	5910006	-	-	5930003
☒					4950005	2x4070009	-	-	-	5910006	-	-	5930003

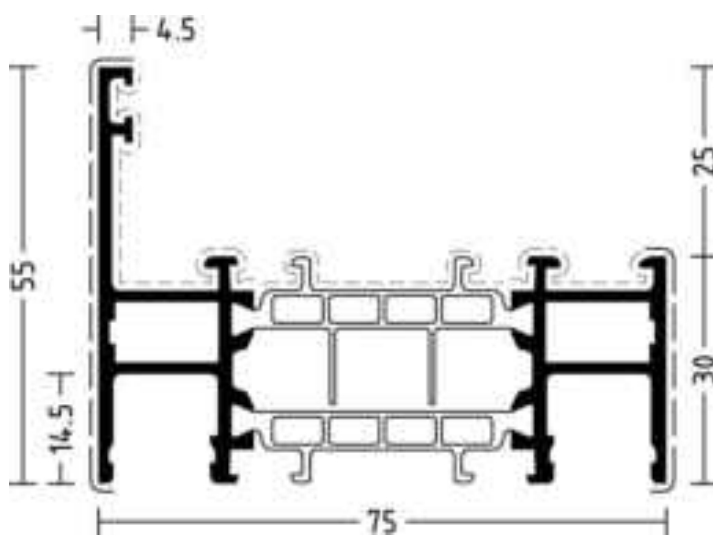



1017062

Gelenckwinkel und Gelenkverbinder siehe Zusatzartikel.
See additional articles for hinged corner angles and hinged connectors.

WICLINE 75 TOP

Blendrahmenprofile Frame profiles

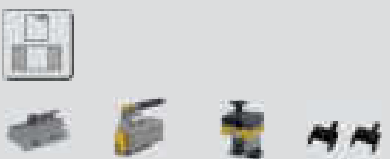
□ 1017064	 m mm mm											
	□	6,5	350	105	4950008	2x4070000	1x4960004	1x4070000	1x4070030	5910006	5940101	5940001
□				4950008	2x4070000	1x4960004	1x4070000	1x4070030	5910006	5940101	5940001	5930003

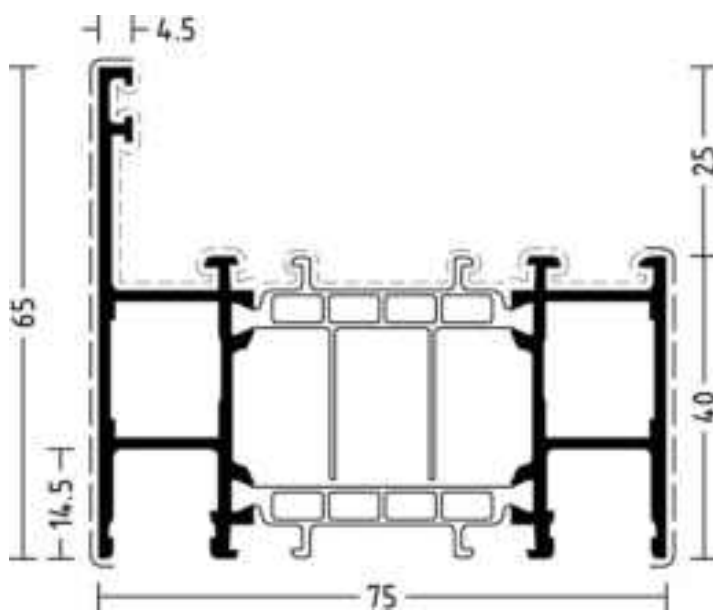

1017064

Gelenkeckwinkel und Gelenkverbinder siehe Zusatzartikel.
See additional articles for hinged corner angles and hinged connectors.

WICLINE 75 TOP

Blendrahmenprofile
Frame profiles



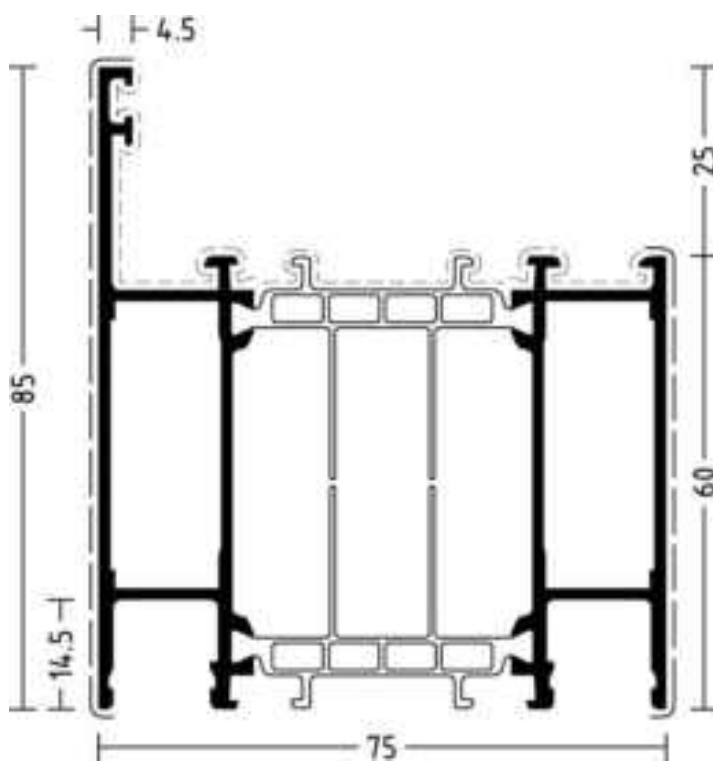











Icon	1017066	Dimensions			Part 1		Part 2			Part 3			
		m	mm	mm	Part	Quantity	Part	Quantity	Part	Quantity	Part	Quantity	
	1017066	6,5	390	145	4950010	2x4070000	1x4960006	1x4070000	1x4070030	5910006	5940101	5940001	5930003
					4950010	2x4070000	1x4960006	1x4070000	1x4070030	5910006	5940101	5940001	5930003



1017066

WICLINE 75 TOP

Blendrahmenprofile Frame profiles

													
	m	mm	mm										
 1017077	6,5	321	84	4950014	2x4070008	-	-	-	5910016	5940107	5940010	5930010	
				4950008	2x4070008	-	-	-	5910016	5940101	5940010	5930010	

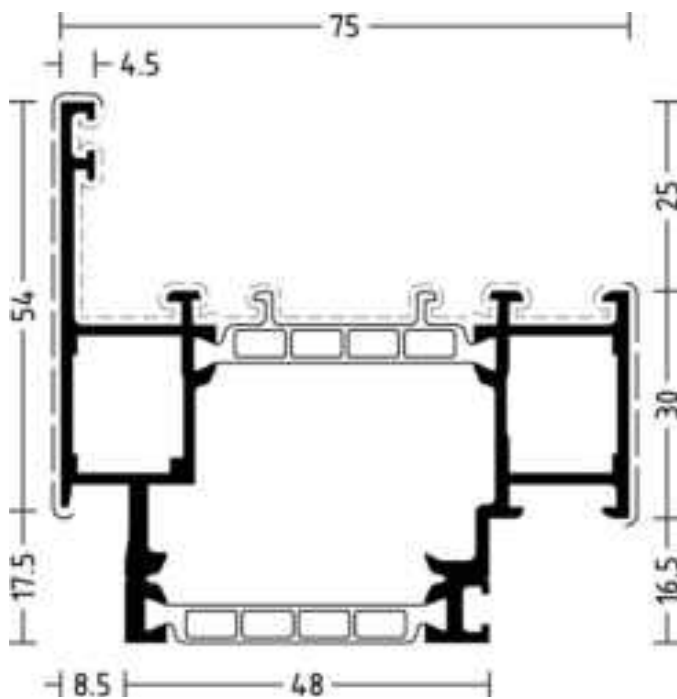















1017077

Einspannblendrahmen
Clamping frame

WICLINE 75 TOP

Flügelprofile
Sash profiles

	 m	 mm	 mm									
 1017101	6,5	387	82	4950018	2x4070000	-	-	-	5910061	5940118	5940022	5930019
				4950028	2x4070000	-	-	-	5910061	5940118	5940022	5930019

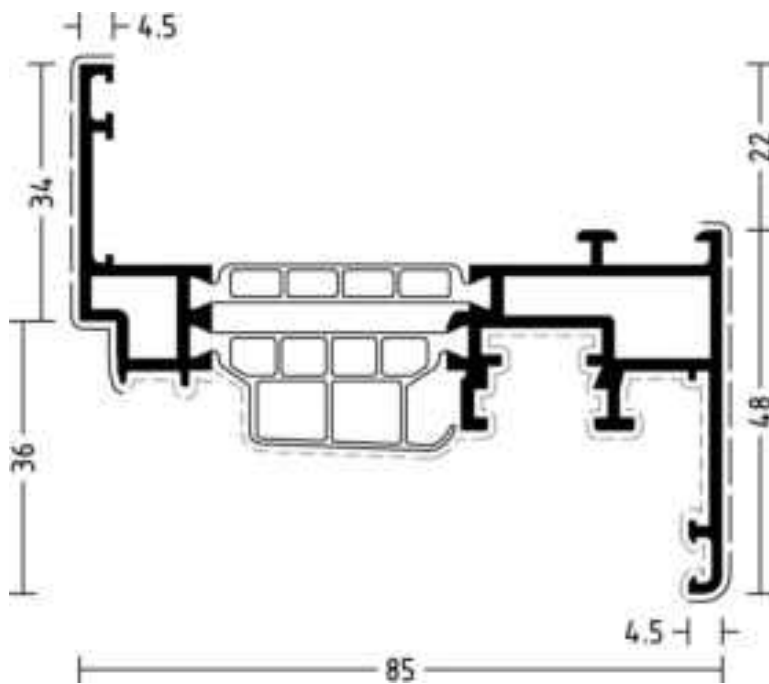















1017101

Gelenckwinkel und Gelenkverbinder siehe Zusatzartikel.
See additional articles for hinged corner angles and hinged connectors.

WICLINE 75 TOP

Flügelprofile
Sash profiles

												
	m	mm	mm									
 1017102	6,5	401	96	4950019	2x4070000	-	-	-	5910061	5940116	5940022	5930019
				4950029	2x4070000	-	-	-	5910061	5940116	5940022	5930019

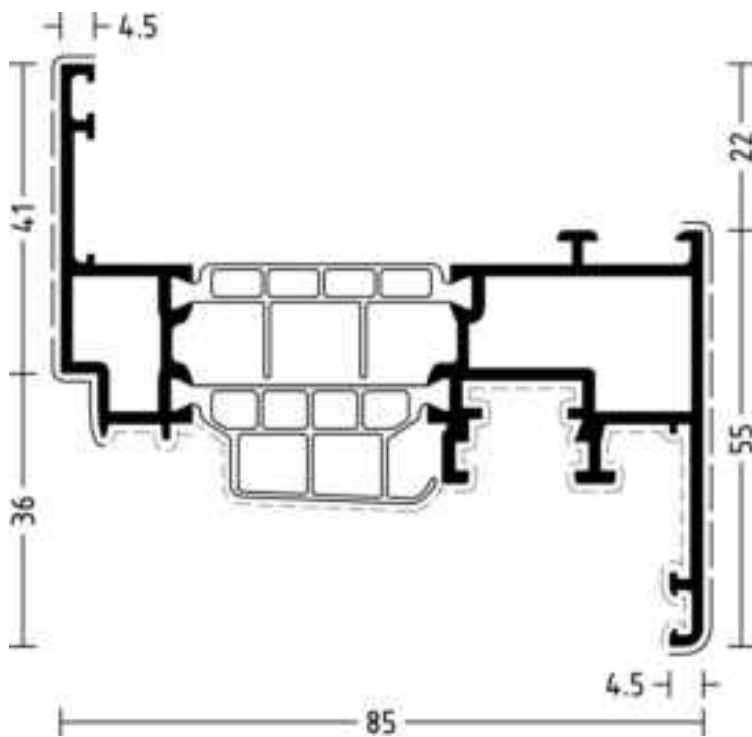















1017102

Gelenkeckwinkel und Gelenkverbinder siehe Zusatzartikel.
See additional articles for hinged corner angles and hinged connectors.

WICLINE 75 TOP

Flügelprofile
Sash profiles

	 m	 mm	 mm									
 1017103	6,5	421	116	4950020	2x4070000	-	-	-	5910061	5940116	5940022	5930019
				4950030	2x4070000	-	-	-	5910061	5940116	5940022	5930019

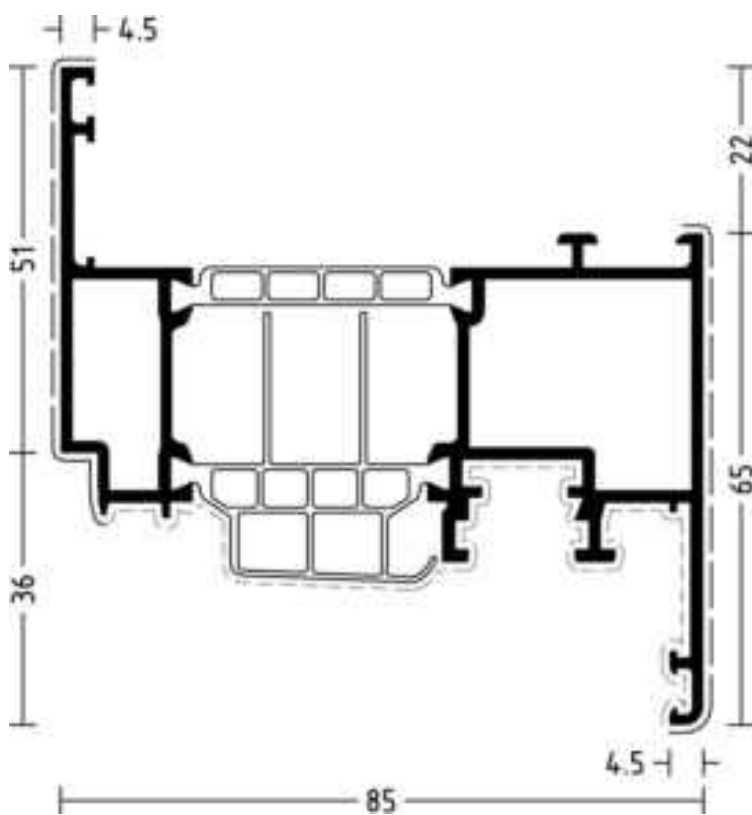















1017103

Gelenkeckwinkel und Gelenkverbinder siehe Zusatzartikel.
See additional articles for hinged corner angles and hinged connectors.

WICLINE 75 TOP

Flügelprofile
Sash profiles

	 m	 mm	 mm									
 1017104	6,5	441	136	4950021	2x4070000	-	-	-	5910061	5940116	5940022	5930019
				4950031	2x4070000	-	-	-	5910061	5940116	5940022	5930019

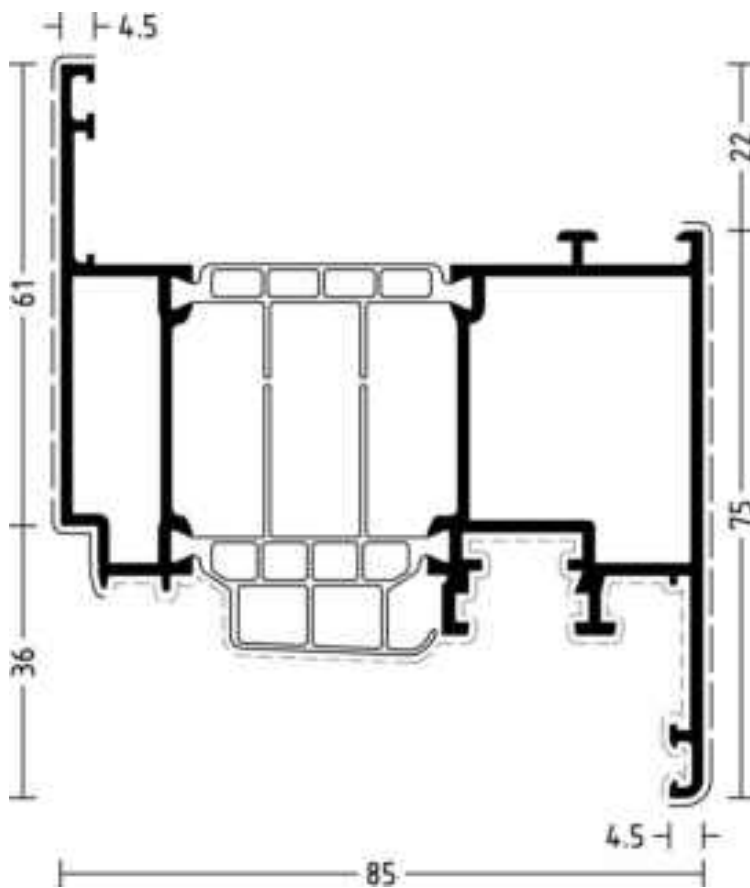















1017104

Fenstertüre einwärts.
French window inwards.

WICLINE 75 TOP

Flügelprofile
Sash profiles

	 m	 mm	 mm									
 1017105	6,5	461	156	4950022	2x4070000	-	-	-	5910061	5940116	5940022	5930019
				4950032	2x4070000	-	-	-	5910061	5940116	5940022	5930019

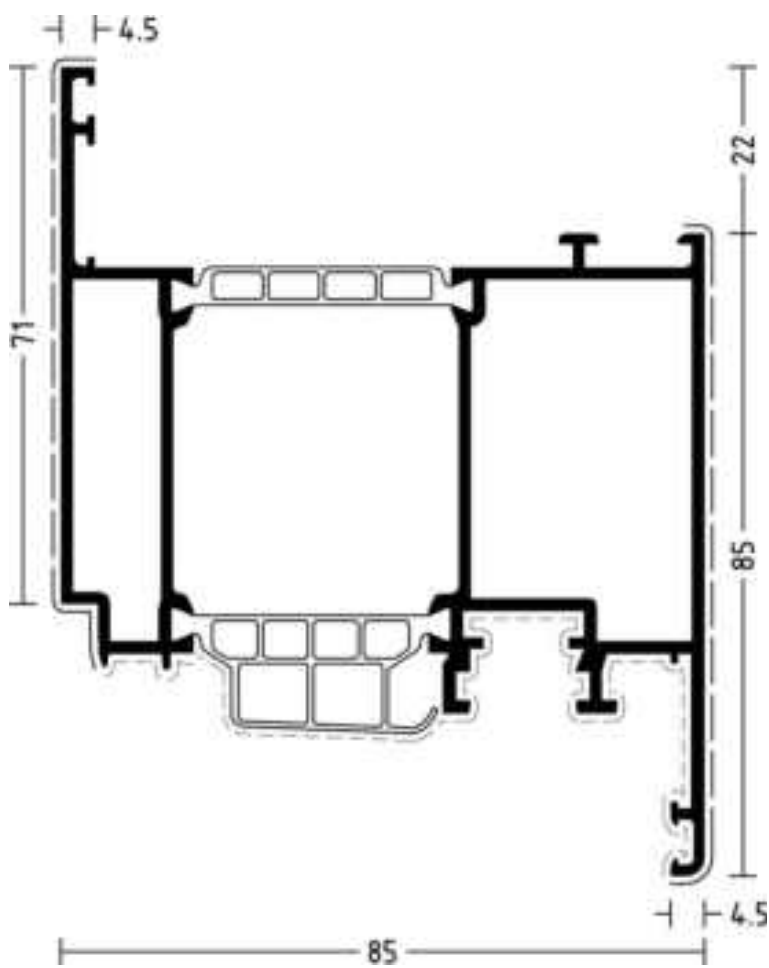















1017105

Fenstertüre einwärts.
French window inwards.

WICLINE 75 TOP

Stulpflügelprofile Double casement sash profiles

	 m	 mm	 mm									
 1017120	6,5	422	90	4950018	2x4070000	-	-	-	5910027	5940118	-	5930020
				4950028	1x4070004	-	-	-	5910027	5940117	-	5930020

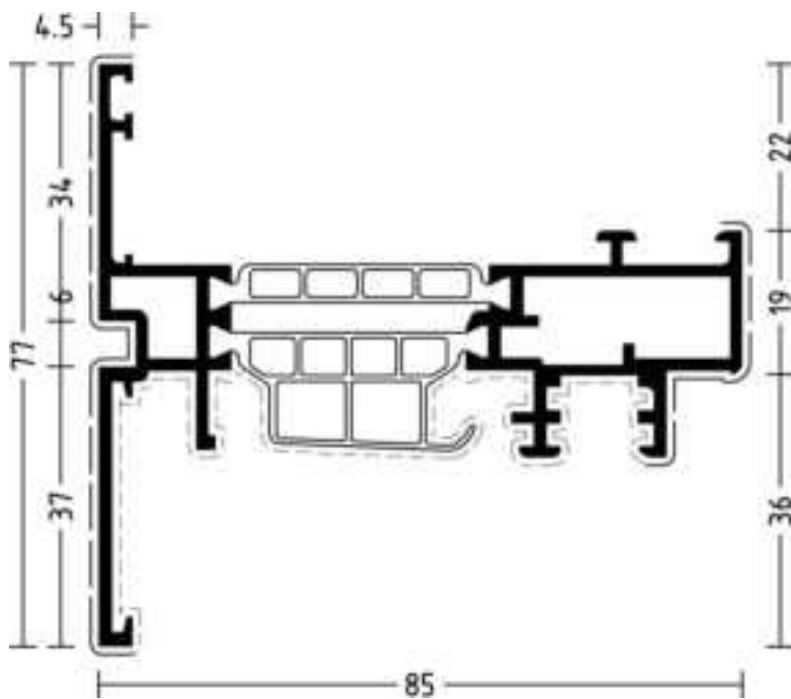









1017120

Verbindungselemente für Eckverbindung innen:
1x 4070004 (Stulpflügelprofil) und 1x 4070000 (Flügelprofil)
Connecting elements for corner connection inside:
1x 4070004 (double casement sash profile) and 1x 4070000 (sash profile)







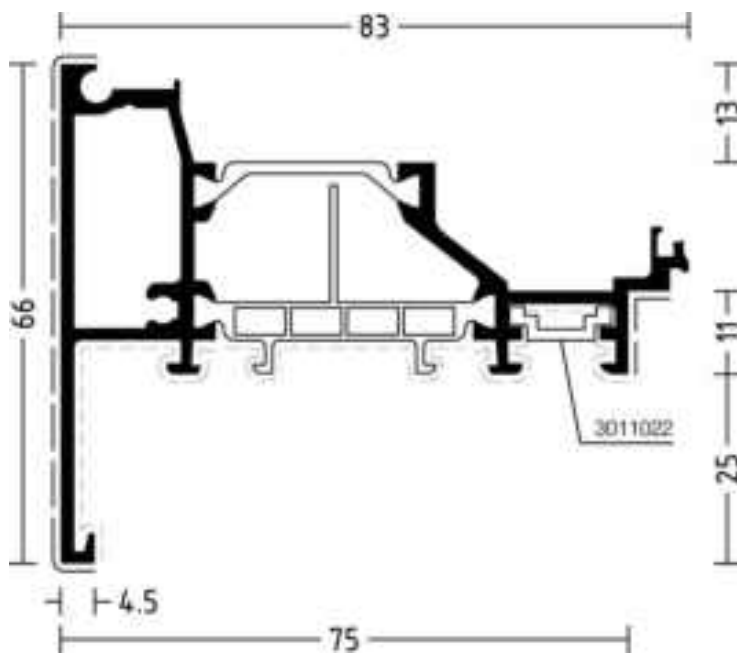







WICLINE 75 TOP

Stulpflügelprofile
Double casement sash profiles

	 m	 mm	 mm										
 1917121	6,5	334	76	-	-	-	-	-	-	-	-	-	-
	-	-	-	-	-	-	-	-	-	-	-	-	-



1917121

	 m	 mm	 mm										
 1017203	6,5	359	110	4950008	2x4070000	1x4960004	1x4070000	1x4070030	5910006	5940101	5940001	5930003	
				4950008	2x4070000	1x4960004	1x4070000	1x4070030	5910006	5940101	5940001	5930003	
1017204	6,5	379	130	4950009	2x4070000	1x4960005	1x4070000	1x4070030	5910006	5940101	5940001	5930003	
				4950009	2x4070000	1x4960005	1x4070000	1x4070030	5910006	5940101	5940001	5930003	

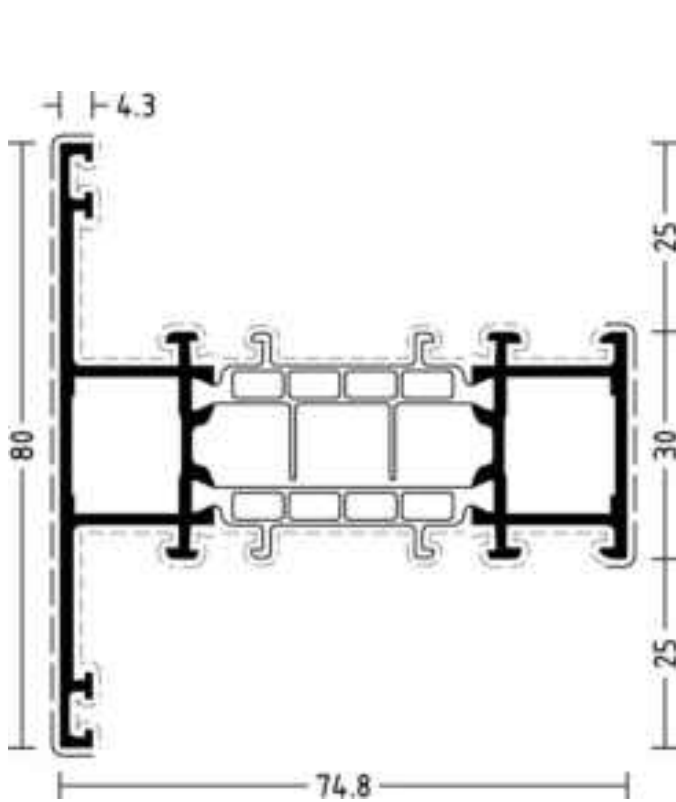

1017203

Gelenkeckwinkel und Gelenkverbinder siehe Zusatzartikel.
Stoßverbindungen mit Tür-Flügelprofilen WICSTYLE 75 Verbinder 4960054 (außen).
See additional articles for hinged corner angles and hinged connectors.
Butt joint connections with WICSTYLE 75 door leaf profiles connector 4960054 (outwards).

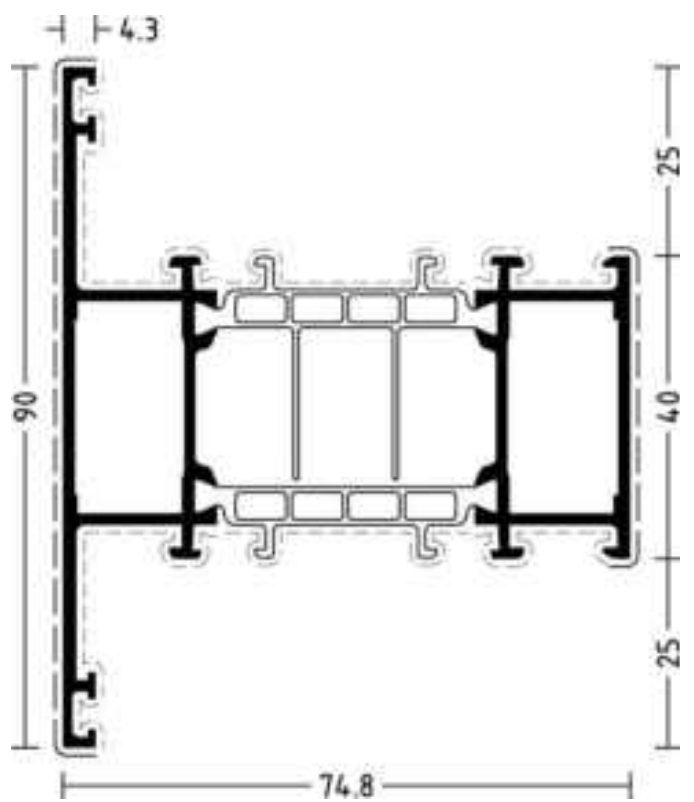















1017204

Gelenkeckwinkel und Gelenkverbinder siehe Zusatzartikel.
Stoßverbindungen mit Tür-Flügelprofilen WICSTYLE 75 Verbinder 4960055 (außen).
See additional articles for hinged corner angles and hinged connectors.
Butt joint connections with WICSTYLE 75 door leaf profiles connector 4960055 (outwards).

WICLINE 75 TOP

Kämpferprofile
Transom profiles

	 m	 mm	 mm									
 1017205	6,5	399	150	4950010	2x4070000	1x4960006	1x4070000	1x4070030	5910006	5940101	5940001	5930003
				4950010	2x4070000	1x4960006	1x4070000	1x4070030	5910006	5940101	5940001	5930003
1017206	6,5	419	170	4950011	2x4070000	1x4960007	2x4070000	2x4070030	5910006	5940101	5940001	5930003
				4950011	2x4070000	1x4960007	2x4070000	2x4070030	5910006	5940101	5940001	5930003

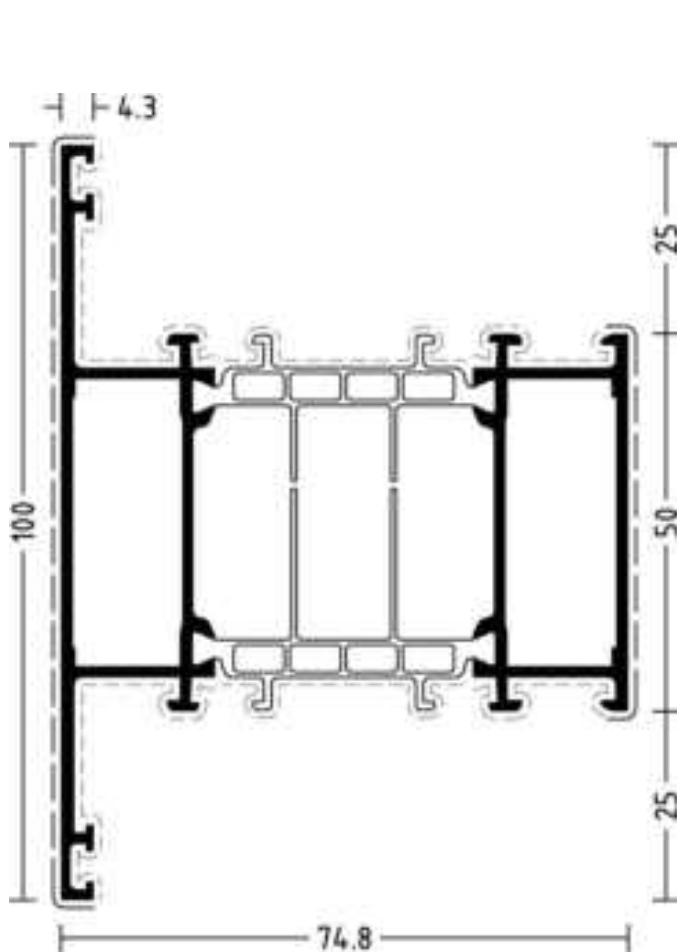

1017205

Stoßverbindungen mit Tür-Flügelprofilen WICSTYLE 75 Verbinder 4960056 (außen).
Butt joint connections with WICSTYLE 75 door leaf profiles connector 4960056 (outwards).

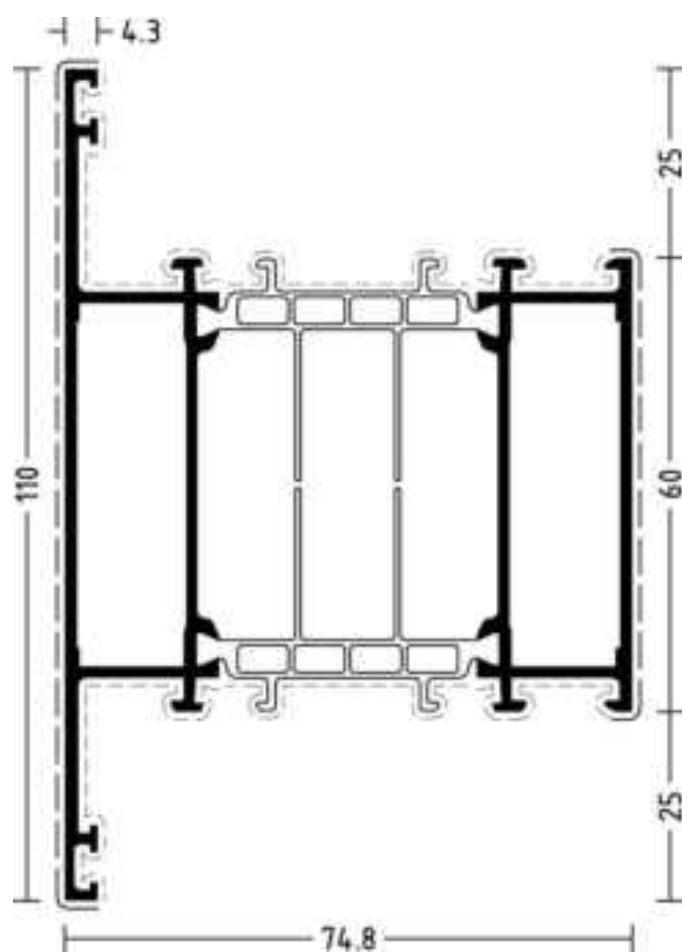



















1017206

Stoßverbindungen mit Tür-Flügelprofilen WICSTYLE 75 Verbinder 4960057 (außen).
Butt joint connections with WICSTYLE 75 door leaf profiles connector 4960057 (outwards).

WICLINE 75 TOP

Kämpferprofile
Transom profiles

																
	m	mm	mm													
 1017207	6,5	439	190	-	-	1x4960008	2x4070000	2x4070030	5910006	5940101	5940001	5930003				
 1017209	6,5	479	230	-	-	1x4960010	2x4070000	2x4070030	5910006	5940101	5940001	-				
				-	-	1x4960010	2x4070000	2x4070030	5910006	5940101	5940001	-				

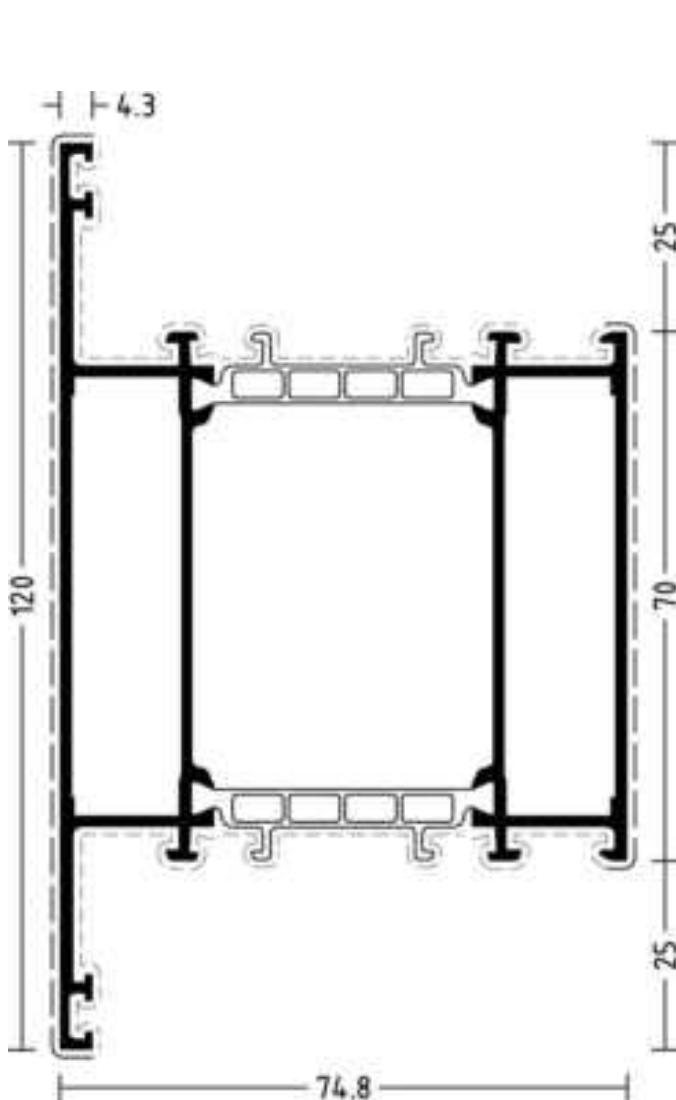

1017207

Eckverbindung außen/innen:
Zuschnitt aus 3900040 oder 3900053 (13.20) + 2x 4070000
Stoßverbindungen mit Tür-Flügelprofilen WICSTYLE 75 Verbinder 4960058 (außen).
Corner connection outside/inside:
Cutting with 3900040 or 3900053 (13.20) + 2x 4070000
Butt joint connections with WICSTYLE 75 door leaf profiles connector 4960058 (outside).

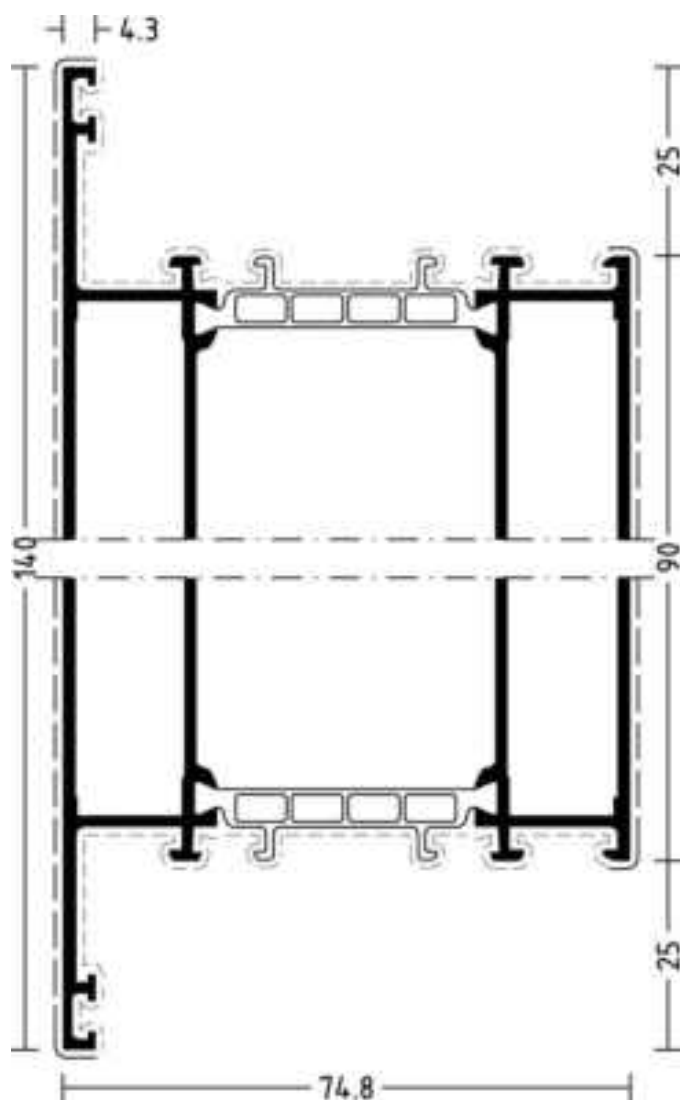















1017209

Stoßverbindungen mit Tür-Flügelprofilen WICSTYLE 75 Verbinder 4960060 (außen).
Butt joint connections with WICSTYLE 75 door leaf profiles connector 4960060 (outwards).

WICLINE 75 TOP

Kämpferprofile
Transom profiles

	 m	 mm	 mm									
 1017213	6,5	559	310	-	-	2x4960008	2x4070000	2x4070030	5910006	5940101	5940001	-
 1017215	6,5	516	350	-	-	2x4960004	2x4070000	2x4070030	5910006	5940101	5940001	-
				-	-	2x4960009	2x4070000	2x4070030	5910006	5940101	5940001	-
				-	-	2x4960004	2x4070000	2x4070030	5910006	5940101	5940001	-

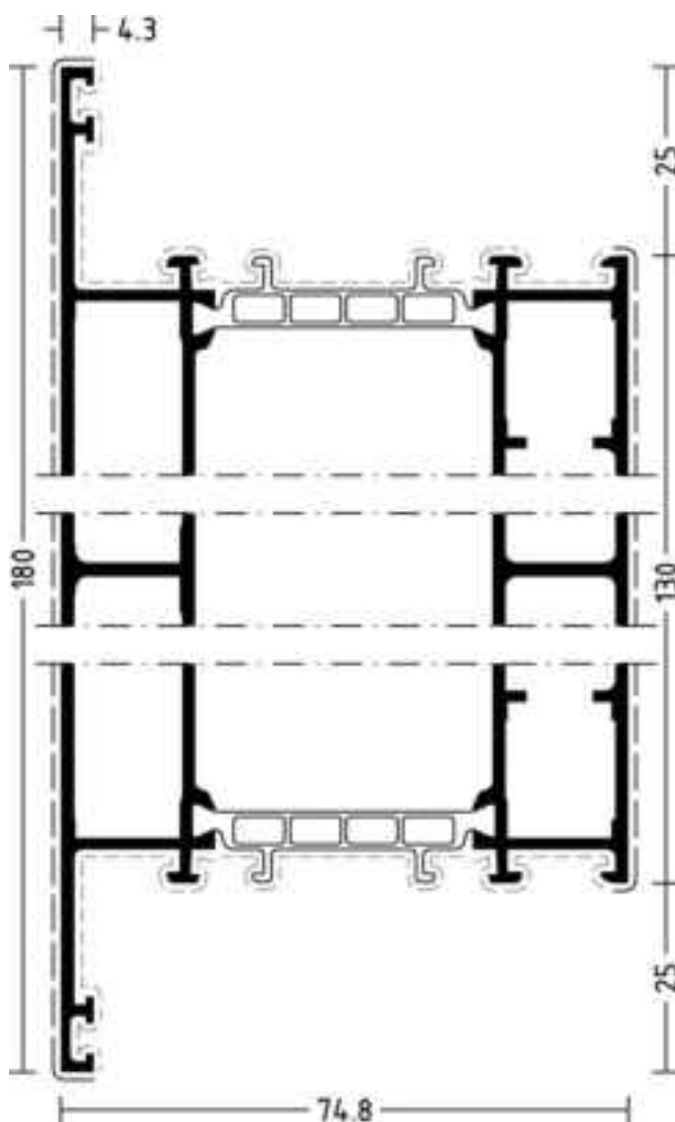

1017213

Stoßverbindungen mit Tür-Flügelprofilen WICSTYLE 75 Verbinder 4960058 (außen).
Butt joint connections with WICSTYLE 75 door leaf profiles connector 4960058 (outwards).

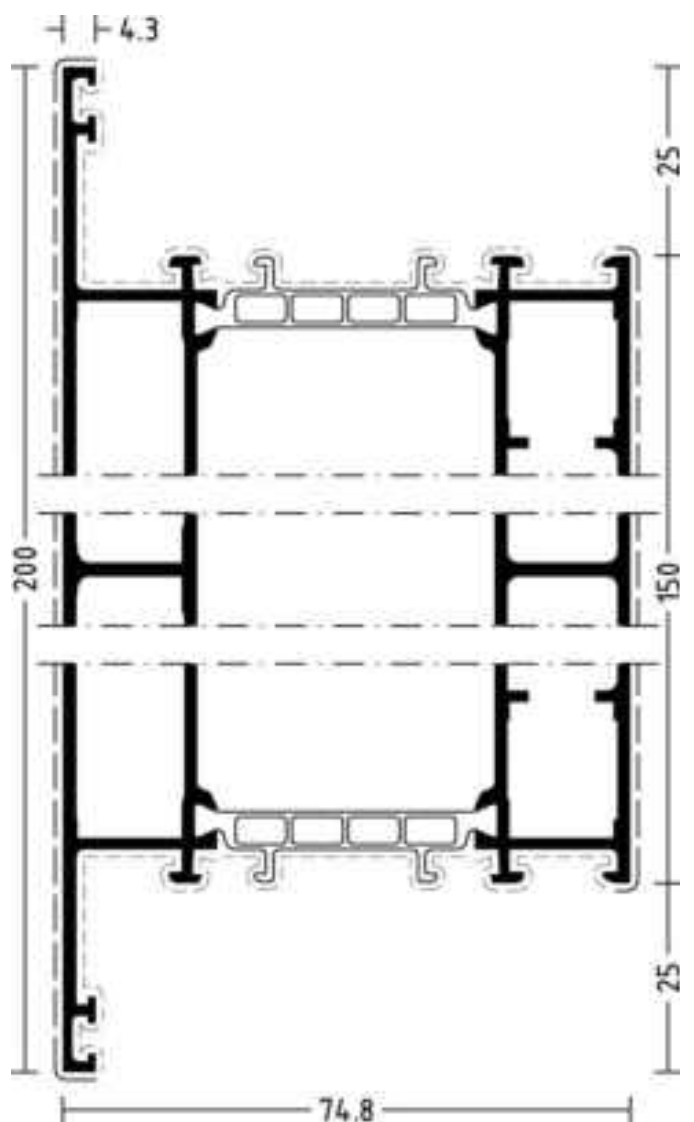















1017215

Stoßverbindungen mit Tür-Flügelprofilen WICSTYLE 75 Verbinder 4960059 (außen).
Butt joint connections with WICSTYLE 75 door leaf profiles connector 4960059 (outwards).

WICLINE 75 TOP

Kämpferprofile
Transom profiles

	 m	 mm	 mm									
 1017220	6,5	699	450	-	-	2x4960011	2x4070000	2x4070030	5910006	5940101	5940001	-
	-	-	-	-	-	2x4960004	2x4070000	2x4070030	5910006	5940101	5940001	-

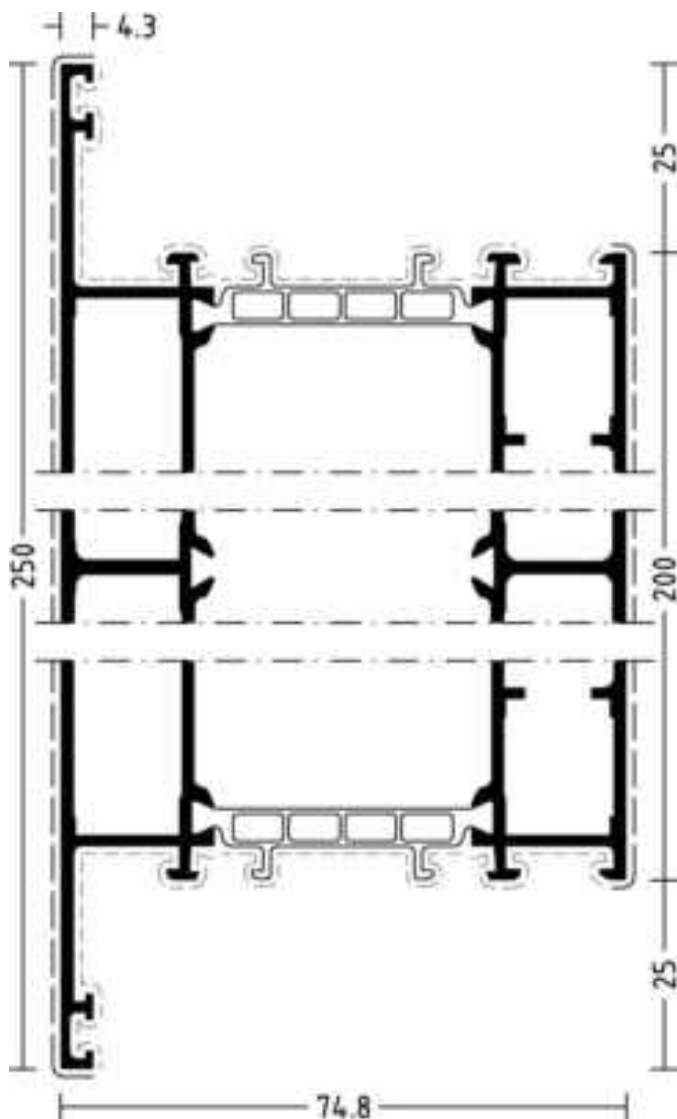











1017220

Stoßverbindungen mit Tür-Flügelprofilen WICSTYLE 75 Verbinder 4960061 (außen).
Butt joint connections with WICSTYLE 75 door leaf profiles connector 4960061 (outwards).

WICLINE 75 TOP

Aufsatzprofile
Supplementary profiles

	 m	 mm	 mm										
 1010463	6,5	196	1	-	-	-	-	-	-	-	-	-	-
 1010464	6,5	233	6	-	-	-	-	-	-	-	-	-	-

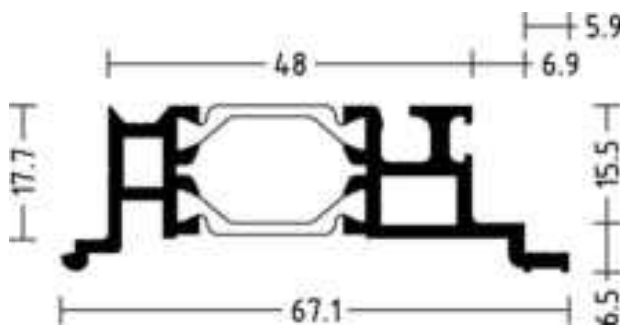

1010463

Verwendung:
Aufsatzprofil für Blendrahmenprofile zur Einspannung in WICTEC Serie
Application:
Supplementary profile of frame profiles for clamping

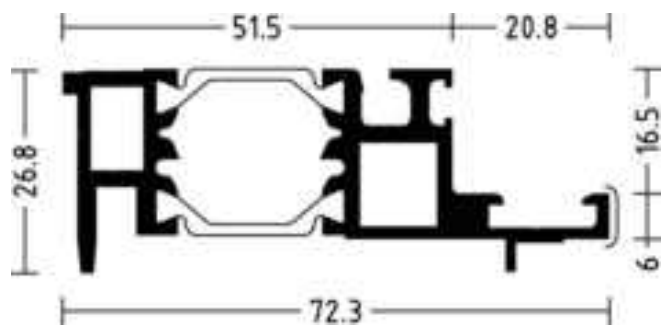

1010464

Verwendung:
Aufsatzprofil für Blendrahmenprofile zur Einspannung in WICTEC Serie
Application:
Supplementary profile of frame profiles for clamping

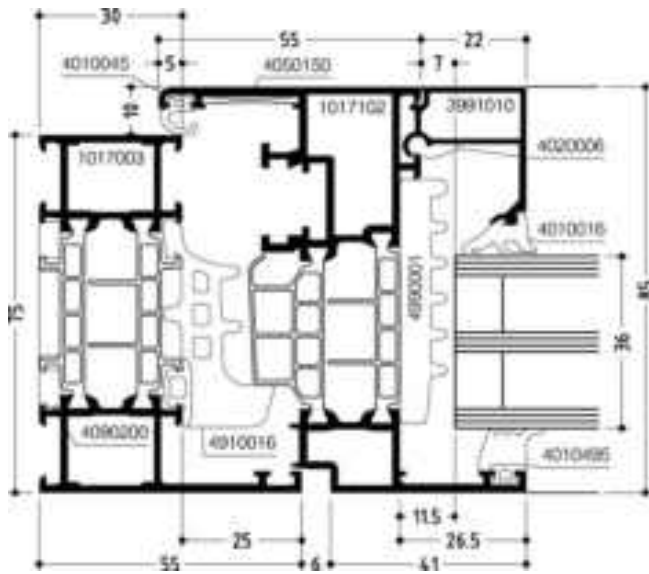

DOC-0001003531

Flügelprofil im
Blendrahmen mit
Spezial-Dämmprofil
*Sash profile in
frame with special
insulation profile*

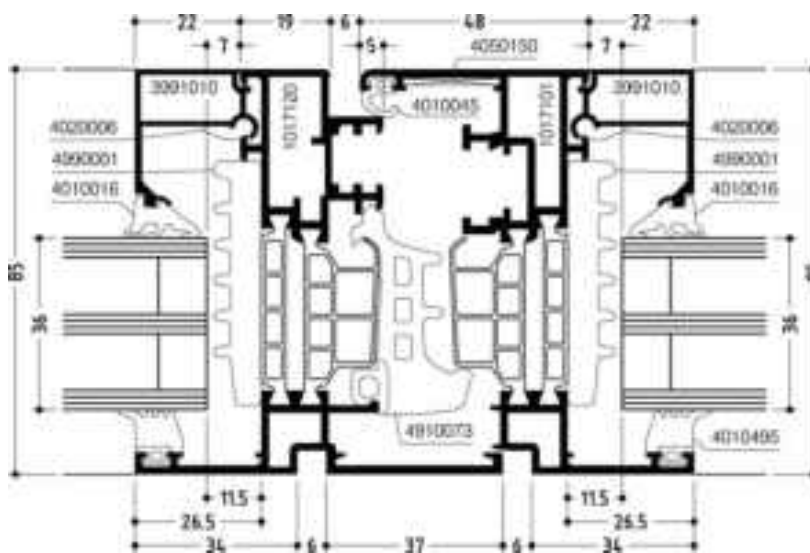

DOC-0000992080

Stulpfenster -
Mittelstoß
*Double casement
window - Meeting
stiles*

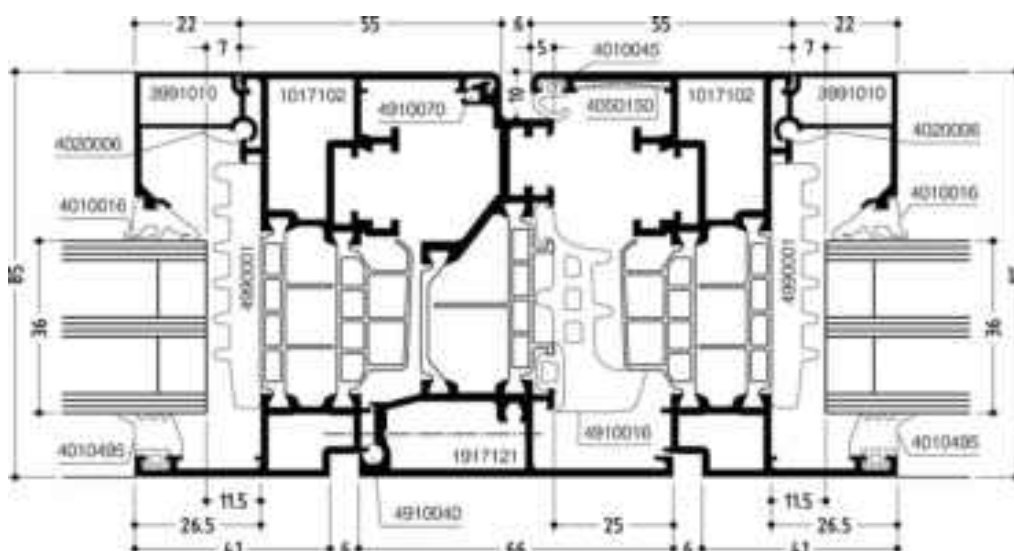

DOC-0001003760

Stulpfenster mit
Aufsatzprofil -
Mittelstoß
*Double casement
window with
supplem. profile -
Meeting stiles*

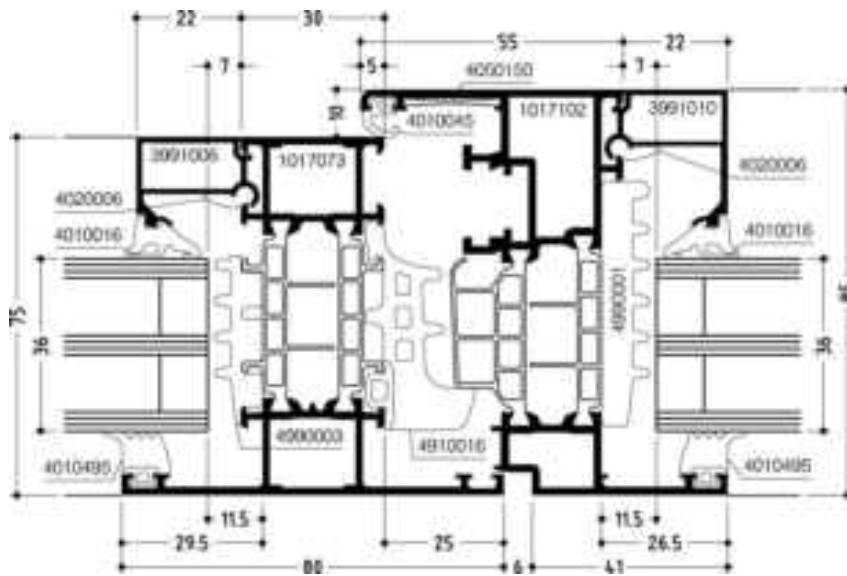

DOC-0001003869

Flügelprofil im
Blendrahmen mit
Kämpfer
*Sash profile in
frame with transom*

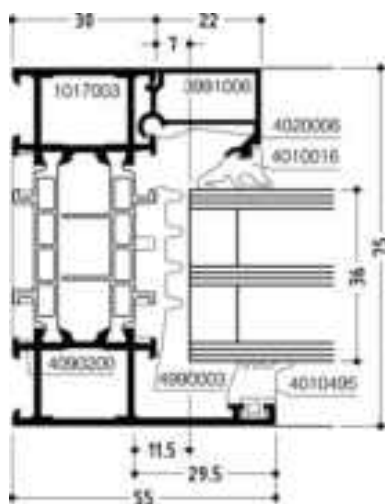

DOC-0001006299

Festverglasung
Fixed glazing

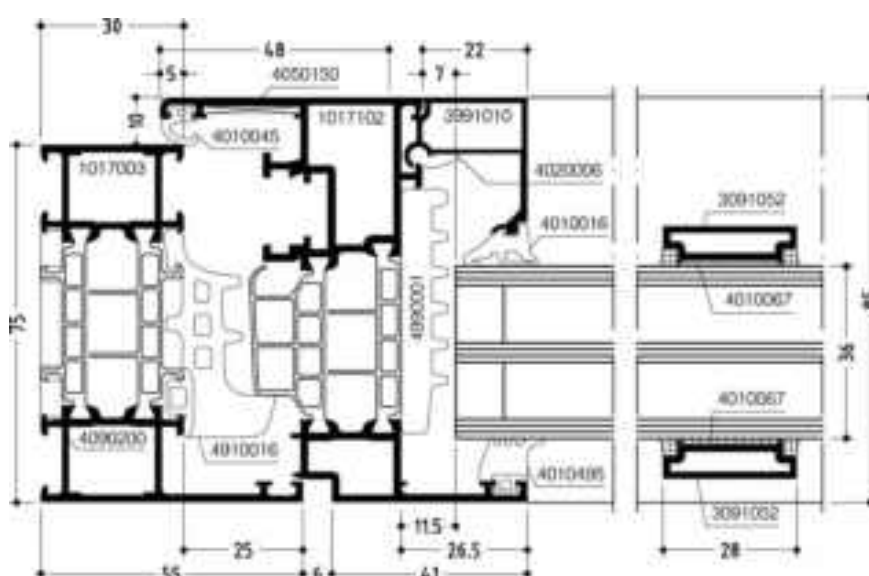

DOC-0001004498

Flügelprofil im
Blendrahmen mit
Ziersprossenprofil
*Sash profile in
frame with glazing
bar profile*

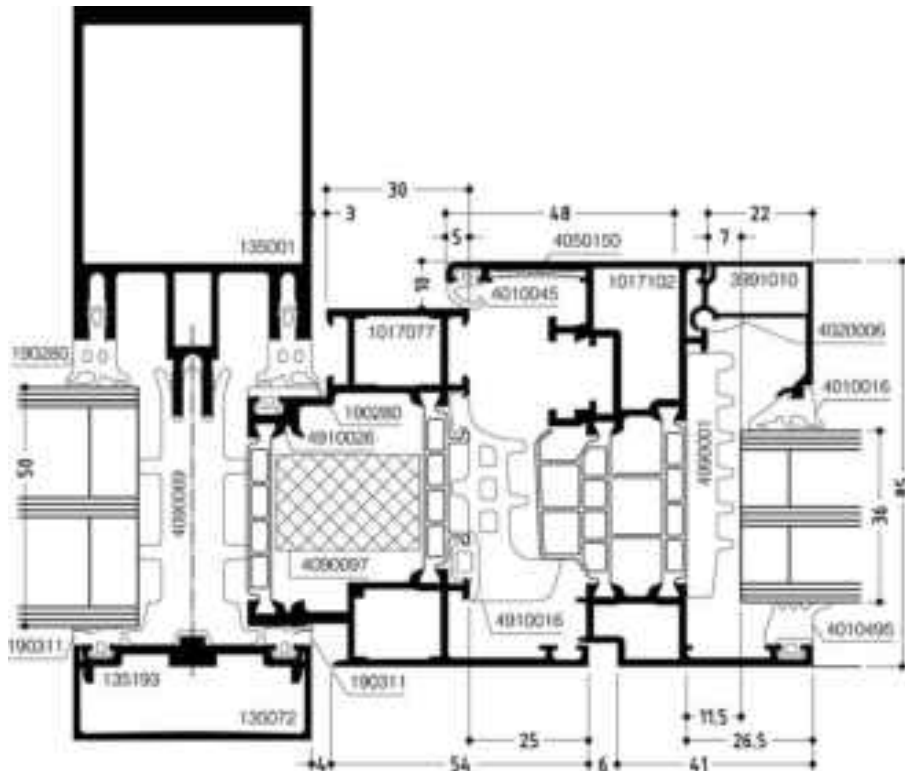

DOC-0001004874

Flügelprofil im
Einspannblenderahmen

*Sash profile in
clamping frame*

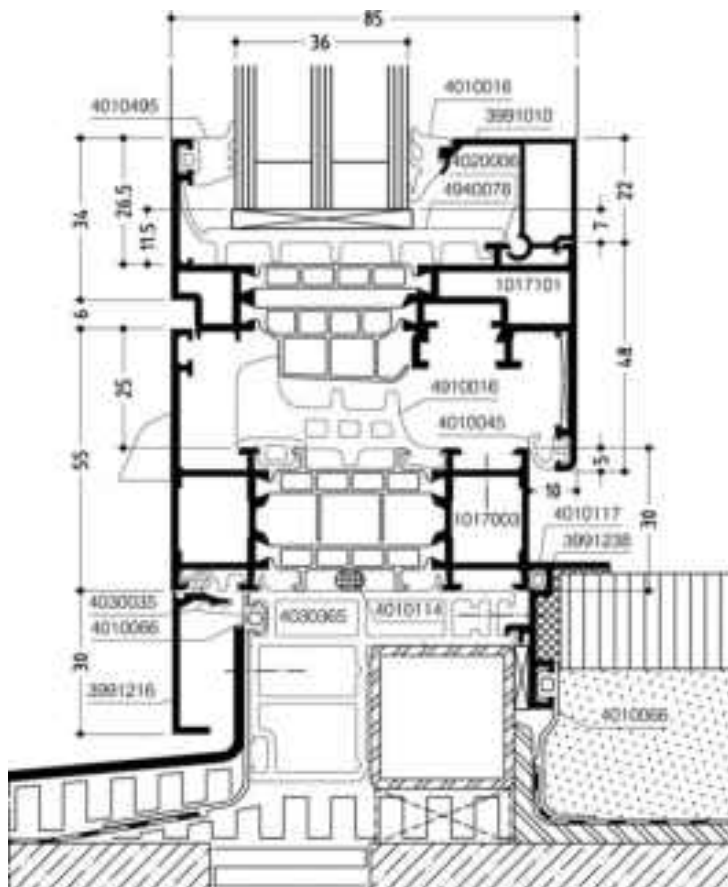

DOC-0000992457

Bauanschluss
unten mit Dämm-
auflage 4030365

*Bottom junction
to structure with
insulation support
4030365*

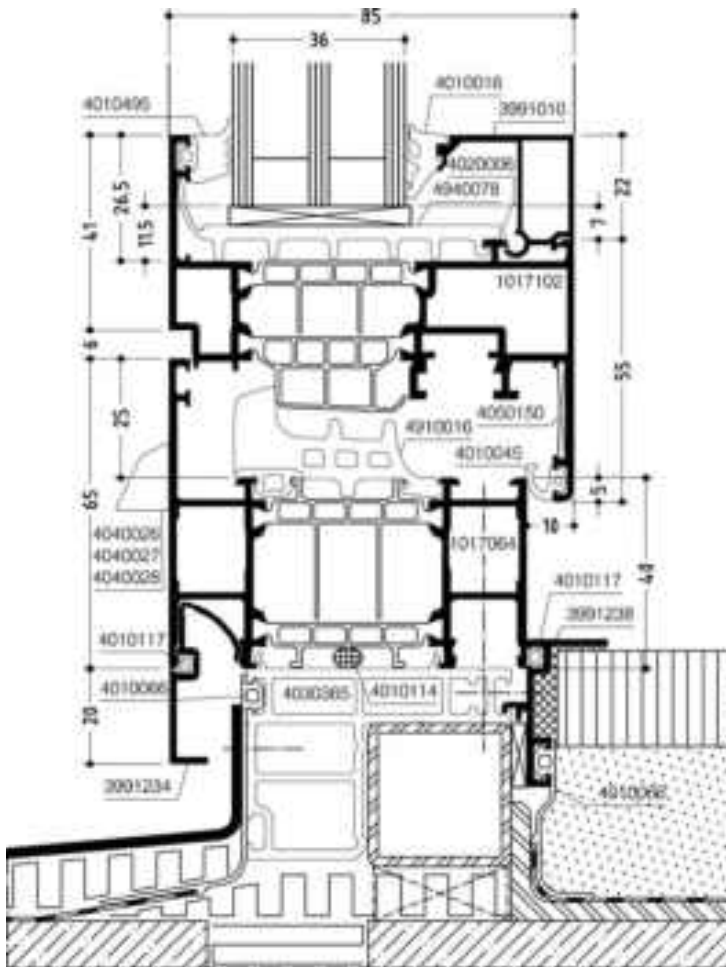

DOC-0000992463

Bauanschluss
unten mit Dämm-
auflage 4030365
*Bottom junction
to structure with
insulation support
4030365*

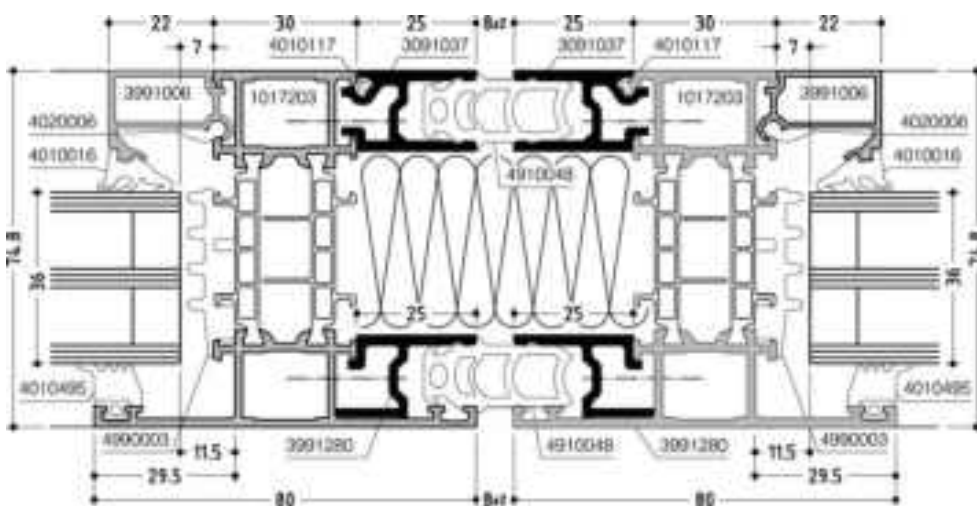

DOC-0000994518

Zusatzprofil
3091037 und
3991280
*Additional profile
3091037 and
3991280*

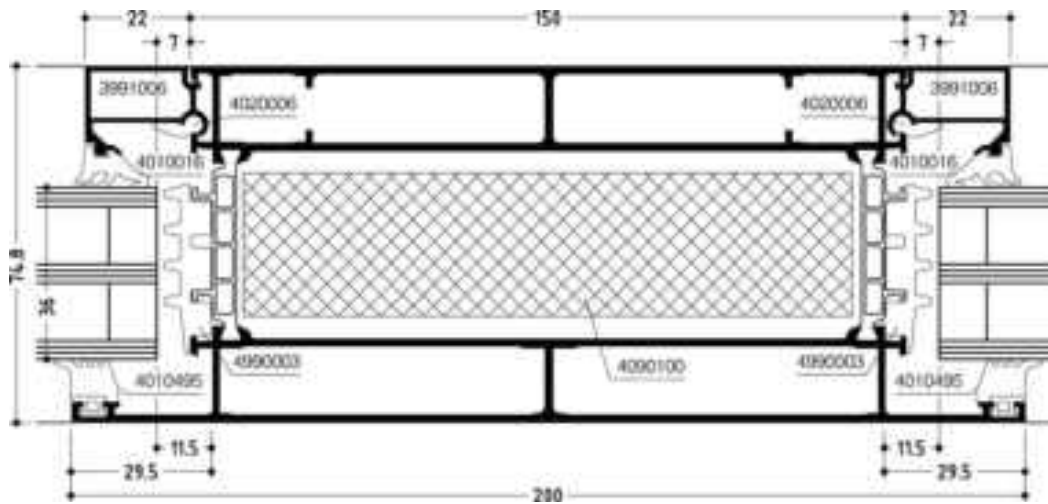

DOC-0000997338

Kämpferprofil mit
Festverglasung
und Spezial-
Dämmprofil

*Transom profile
with fixed glazing
and special
insulation profile*

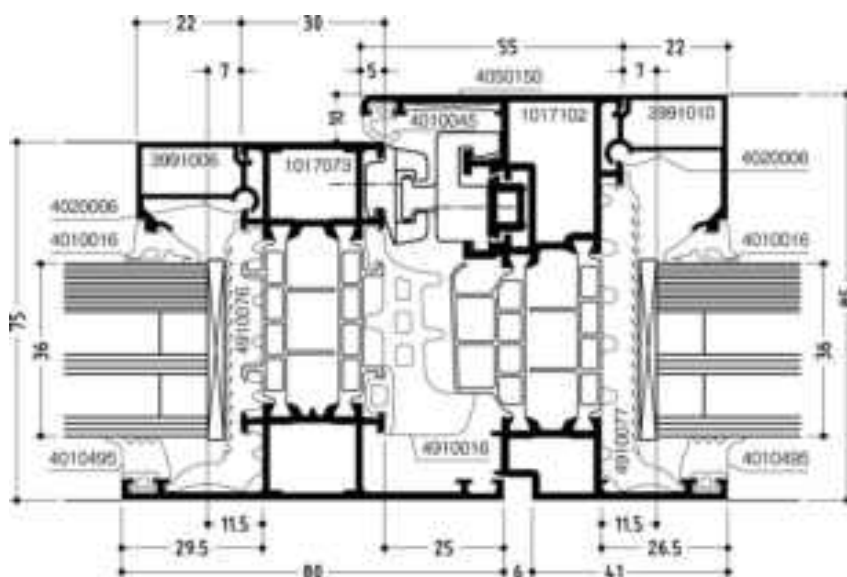

DOC-0001004917

Flügelprofil im
Blendrahmen mit
Kämpfer, EH-Verriegelung / Füllungs-
sicherung

*Sash profile in
frame with transom,
burglar resistant
locking / Infill
safeguard*

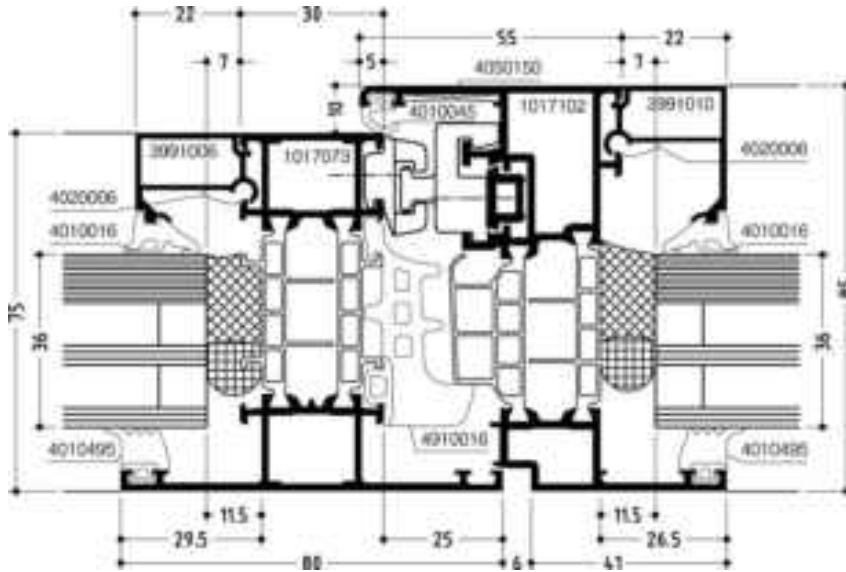

DOC-0001004953

Flügelprofil im
Blendrahmen mit
Kämpfer, EH-Verriegelung / Füllungs-
sicherung

Sash profile in
frame with transom,
burglar resistant
locking / Infill
safeguard

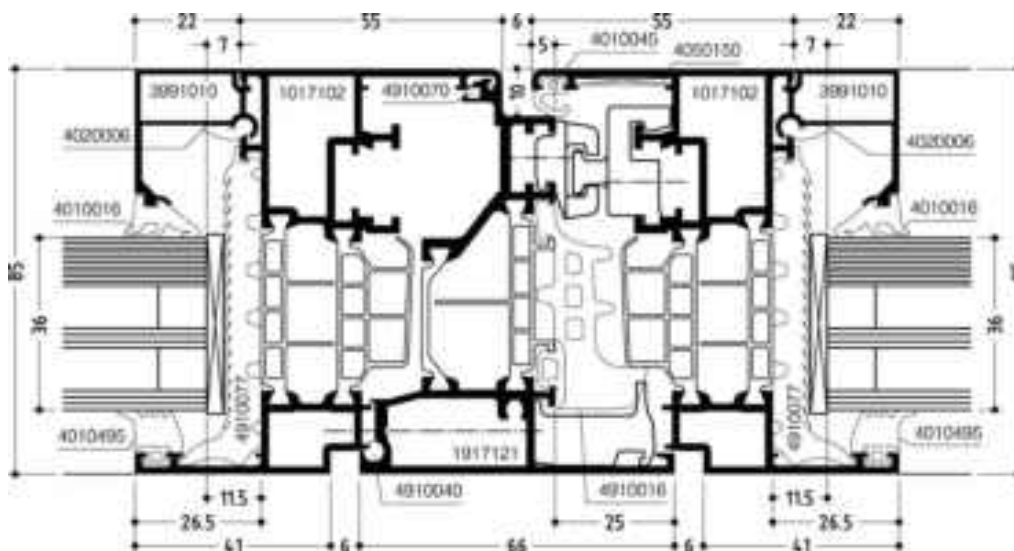

DOC-0001005184

Stulpfenster
mit Aufsatzpro-
fil - Mittelstoß,
EH-Verriegelung /
Füllungssicherung

Double casement
window with
supplem. profile
- Meeting stiles,
burglar resistant
locking / Infill
safeguard

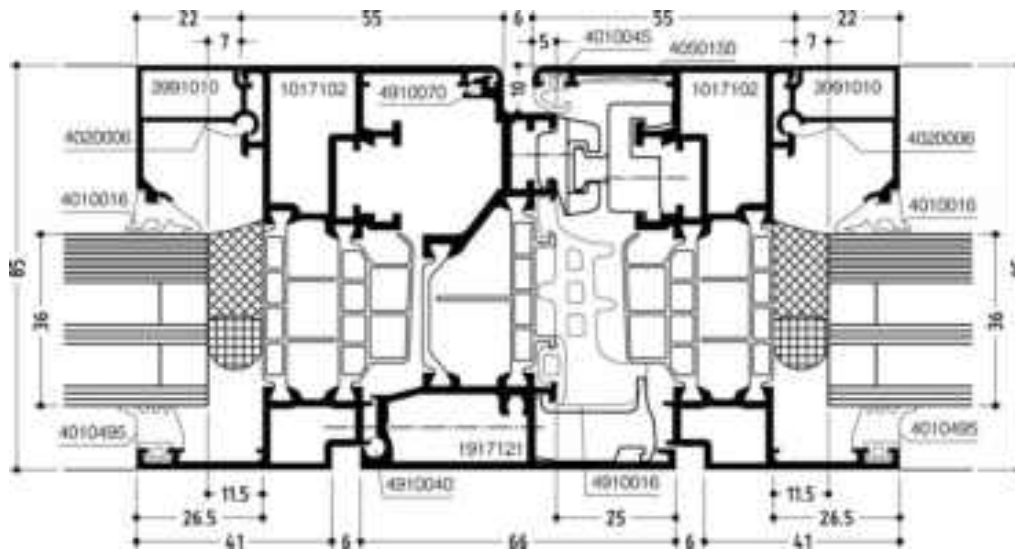

DOC-0001005366

Stulpfenster
mit Aufsatzpro-
fil - Mittelstoß,
EH-Verriegelung /
Füllungssicherung

*Double casement
window with
supplem. profile
- Meeting stiles,
burglar resistant
locking / Infill
safeguard*

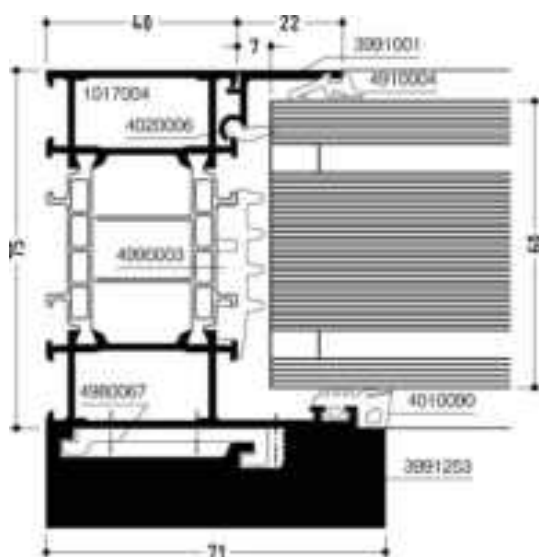

DOC-0001005436

Blendrahmen, Fest-
verglasung

*Frame profile, fixed
glazing*

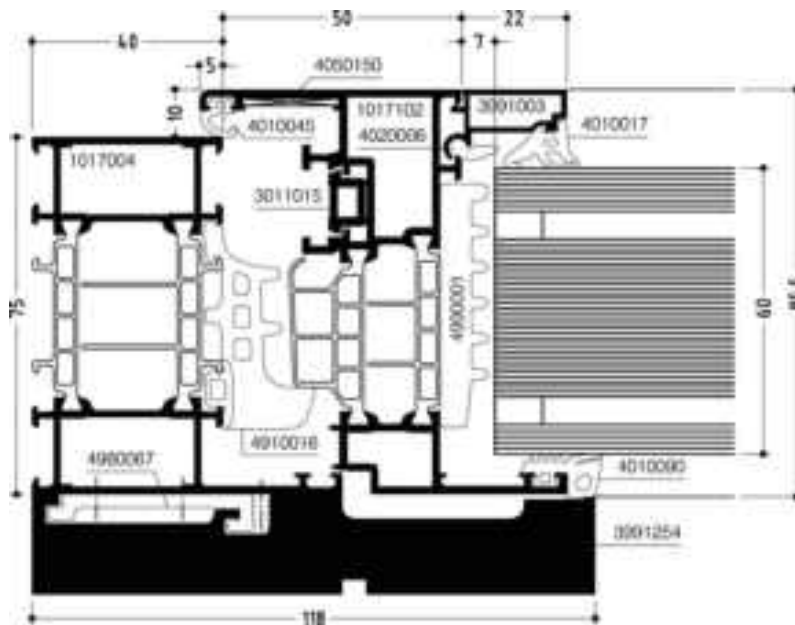

DOC-0001005437

Blendrahmen,
Fensterflügel
*Frame profile,
window sash*

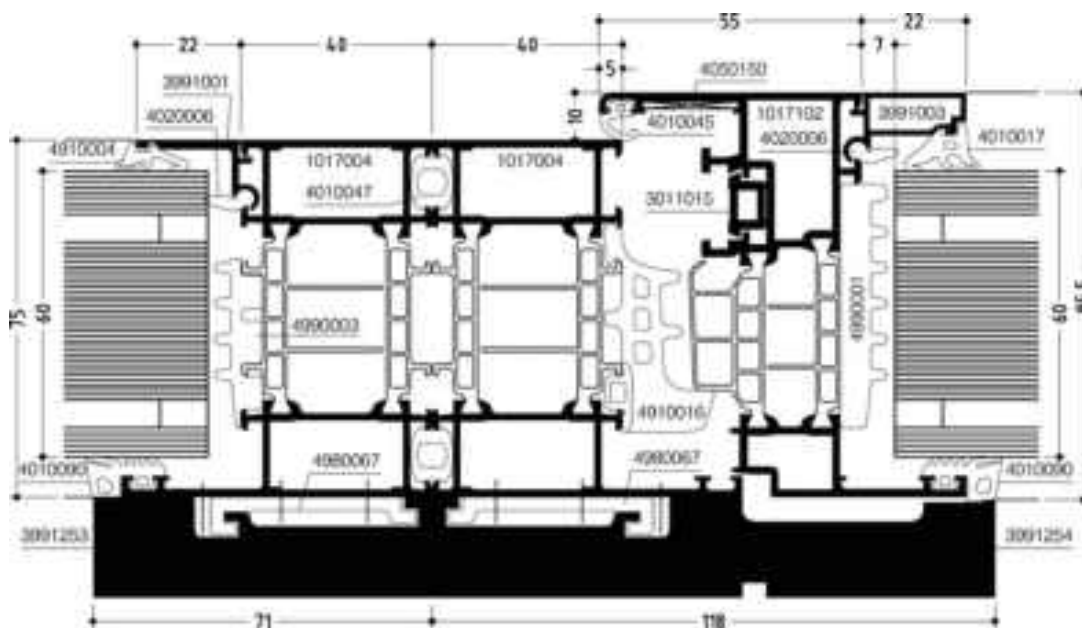

DOC-0001005605

Flügelprofil im
Blendrahmen Fensterflügel / Elementkopplung
*Sash profile in
frame Window sash
/ Unit coupling*

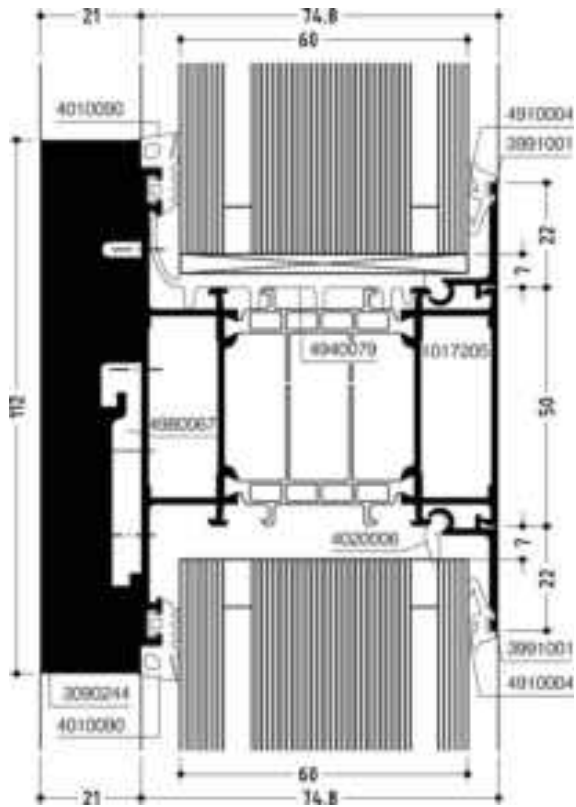

DOC-0001005702

Kämpferprofil, Fest-
verglasung
*Transom profile,
Fixed glazing*

Verdeckter Flügel

Concealed sash

Profile

Profiles

2/46















Anwendungsbeispiele

Examples of application

2/57

WICLINE 75 TOP

Blendrahmenprofile Frame profiles

												
	m	mm	mm									
 1017081	6,5	336	178	4950008	2x4070000	1x4960020	1x4070000	1x4070030	5910006	5940101	5940001	5930003
				4950008	2x4070000	1x4960020	1x4070000	1x4070030	5910006	5940101	5940001	5930003
1017082	6,5	356	124	4950009	2x4070000	1x4960021	1x4070000	1x4070030	5910006	5940101	5940001	5930003
				4950009	2x4070000	1x4960021	1x4070000	1x4070030	5910006	5940101	5940001	5930003

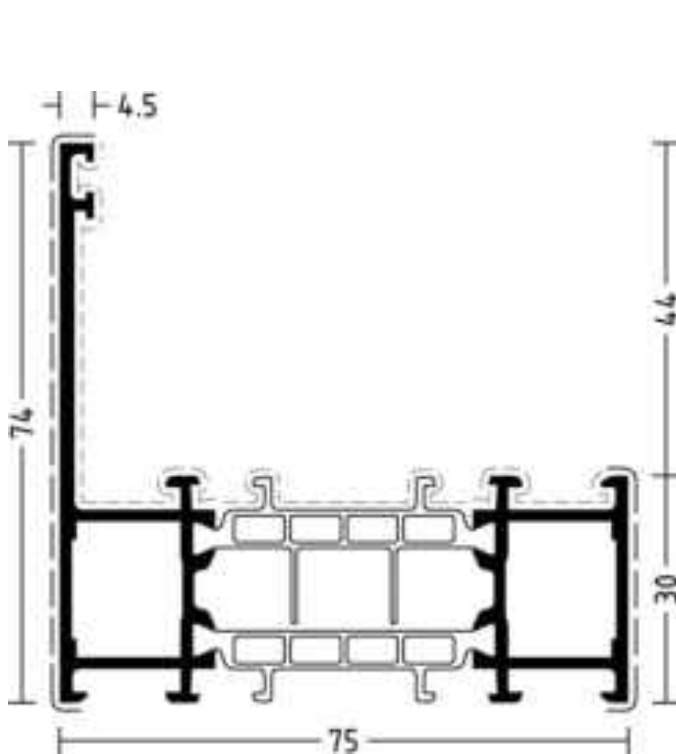





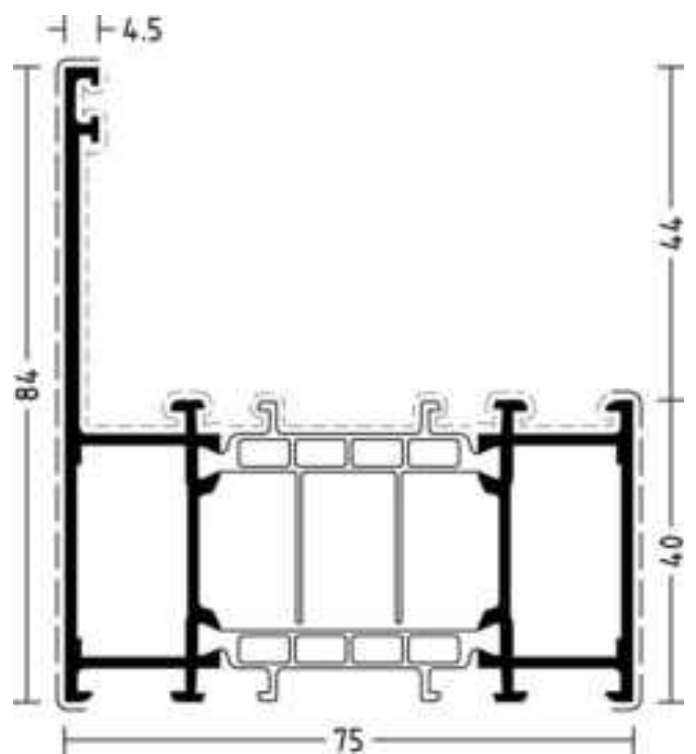









1017081

Gelenkeckwinkel und Gelenkverbinder siehe Zusatzartikel.
See additional articles for hinged corner angles and hinged connectors.



1017082

Gelenkeckwinkel und Gelenkverbinder siehe Zusatzartikel.
See additional articles for hinged corner angles and hinged connectors.

	 m	 mm	 mm										
 1017051	6,5	374	117	4050574	2x4070000	-	-	-	5910006	5940101	5940001	5930003	
				4950009	2x4070000	-	-	-	5910006	5940101	5940001	5930003	

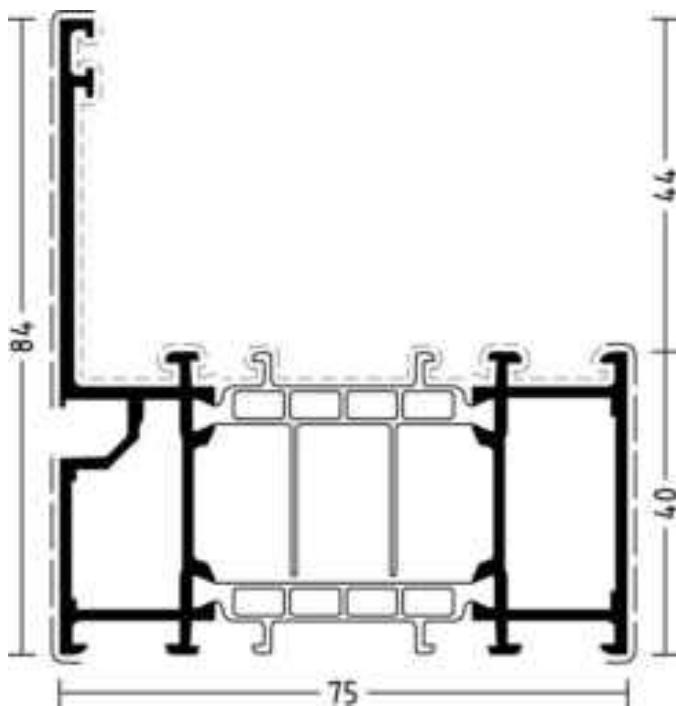















1017051

Stoßverbinder für Kämpferprofile siehe Seiten „Kämpferstoßverbindung“.

See pages „Transom butt-joint connection“ for butt-joint connectors for transom profiles.

WICLINE 75 TOP

Blendrahmenprofile Frame profiles

	 m	 mm	 mm									
 1017090	6,5	359	103	4950008	2x4070000	-	-	-	5010629	5940101	5940001	5030076
				4950008	2x4070000	-	-	-	5010629	5940101	5940001	5030076

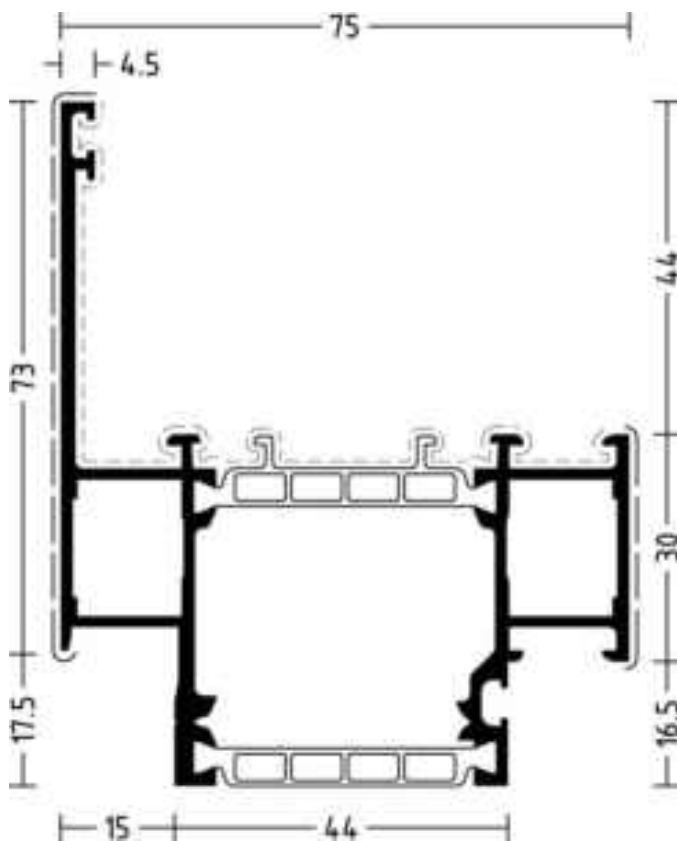

1017090

Einspannblendrahmen, verdeckter Flügel
Clamping frame, concealed sash

Icon	1017111	Dimensions			Accessories		Tools			Other			
		m	mm	mm	4950038	2x4070000	5910071	5940110	5040426	-	-	-	
Icon	6,5	297	83	4950038	2x4070000	-	-	-	5910071	5940110	5040426	-	
Icon				4050568	2x4070000	-	-	-	5910071	5940116	5040426	-	

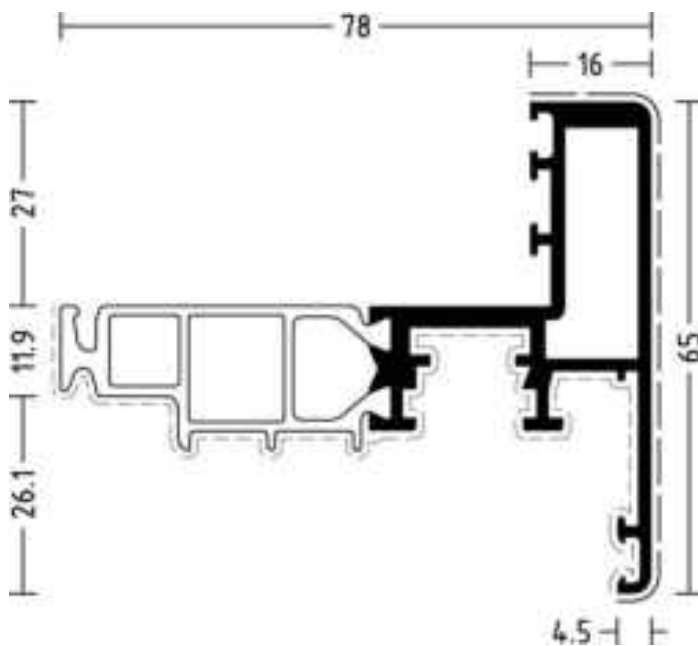

1017111

Die Eckverbindung muss unmittelbar nach dem Zuschnitt der Profile erfolgen.















Stanzwerkzeug 5940023 mit Wechselmatrize 5040426 verwenden.

The corner connection has to be done immediately after the sawing.

Use punching tool 5940023 with interchangeable matrix 5040426.

WICLINE 75 TOP

Flügelprofile
Sash profiles

	 m	 mm	 mm									
 1017112	6,5	297	83	4950038	2x4070000	-	-	-	5910071	5940110	5940023	-
				4950049	2x4070000	-	-	-	5910071	5940116	5940023	-

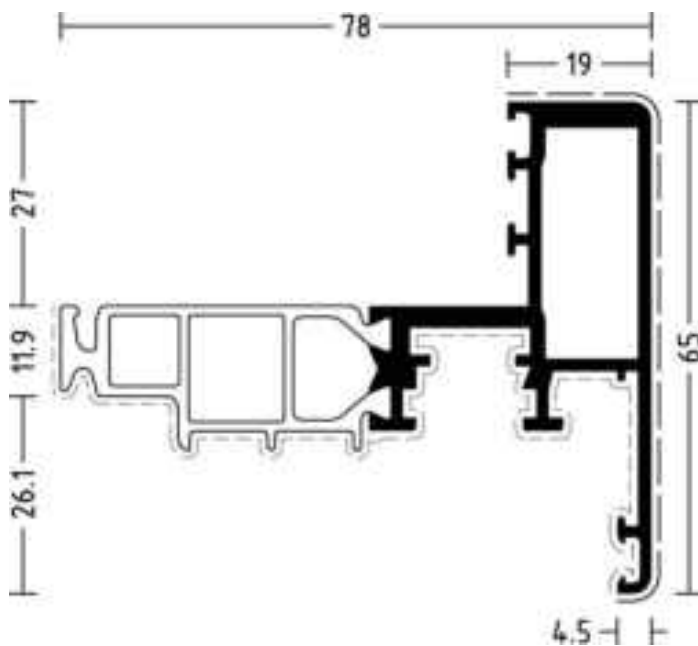















1017112

Die Eckverbindung muss unmittelbar nach dem Zuschnitt der Profile erfolgen.

The corner connection has to be done immediately after the sawing.

WICLINE 75 TOP

Flügelprofile
Sash profiles

	 m	 mm	 mm									
 1017113	6,5	297	87	4950038	2x4070000	-	-	-	5910071	5940110	5940023	-
				4950053	2x4070000	-	-	-	5910071	5940116	5940023	-

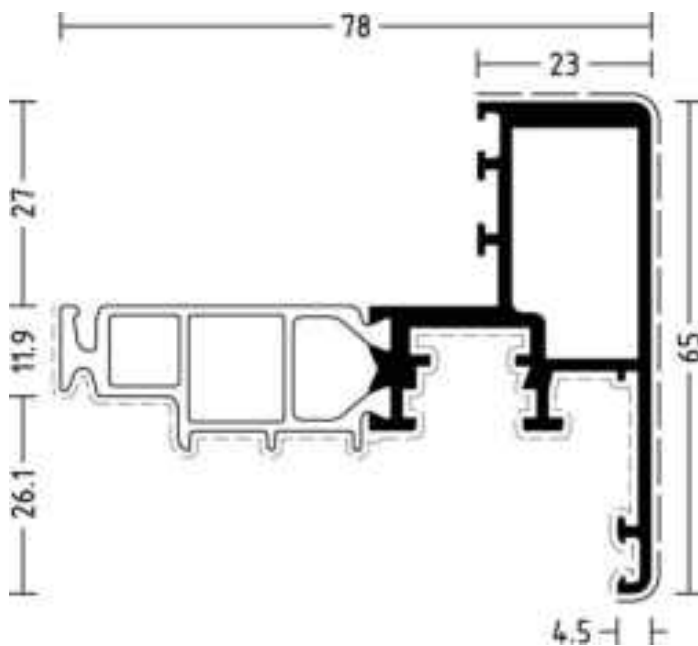















1017113

Die Eckverbindung muss unmittelbar nach dem Zuschnitt der Profile erfolgen.

The corner connection has to be done immediately after the sawing.

WICLINE 75 TOP

Stulpflügelprofile Double casement sash profiles

	 m	 mm	 mm										
 1017124	6,5	398	129	4950038	2x4070000	-	-	-	5910027	5940110	-	-	
				4050568	1x4070004	-	-	-	5910027	5040132	-	-	

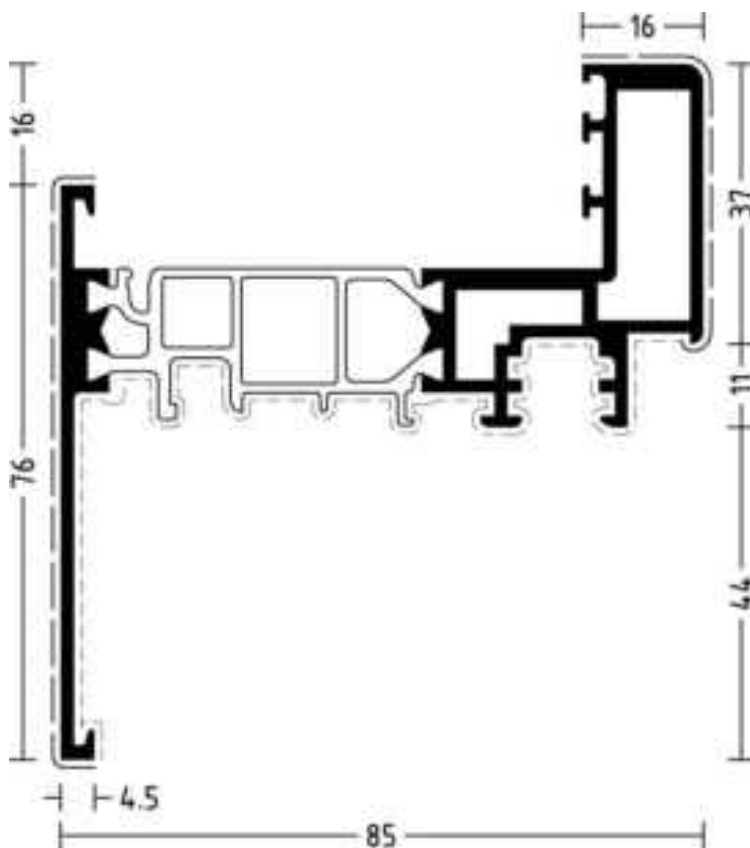















1017124

Verbindungselemente für Eckverbindung innen:
 1x 4070004 (Stulpflügelprofil) und 1x 4070000 (Flügelprofil)
 Connecting elements for corner connection inside:
 1x 4070004 (double casement sash profile) and 1x 4070000 (sash profile)

WICLINE 75 TOP

Stulpflügelprofile Double casement sash profiles

	 m	 mm	 mm										
 1017125	6,5	398	132	4950038	2x4070000	-	-	-	5910027	5940110	-	-	
				4950049	1x4070004	-	-	-	5910027	5040132	-	-	

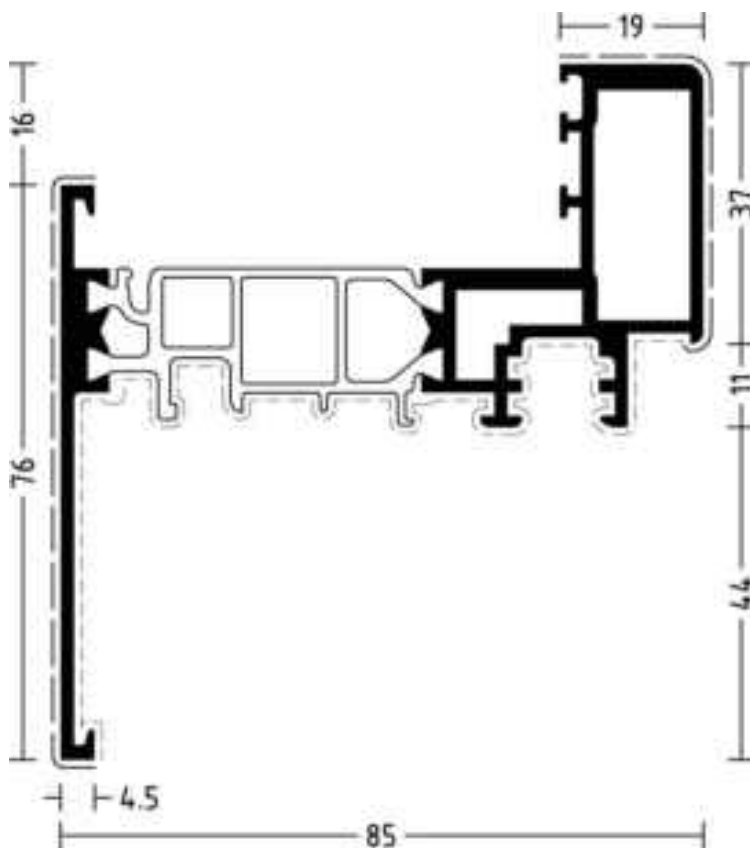















1017125

Verbindungselemente für Eckverbindung innen:
 1x 4070004 (Stulpflügelprofil) und 1x 4070000 (Flügelprofil)
 Connecting elements for corner connection inside:
 1x 4070004 (double casement sash profile) and 1x 4070000 (sash profile)

WICLINE 75 TOP

Stulpflügelprofile Double casement sash profiles

	 m	 mm	 mm										
 1017126	6,5	398	133	4950038	2x4070000	-	-	-	5910027	5940110	-	-	
				4950053	1x4070004	-	-	-	5910027	5040132	-	-	

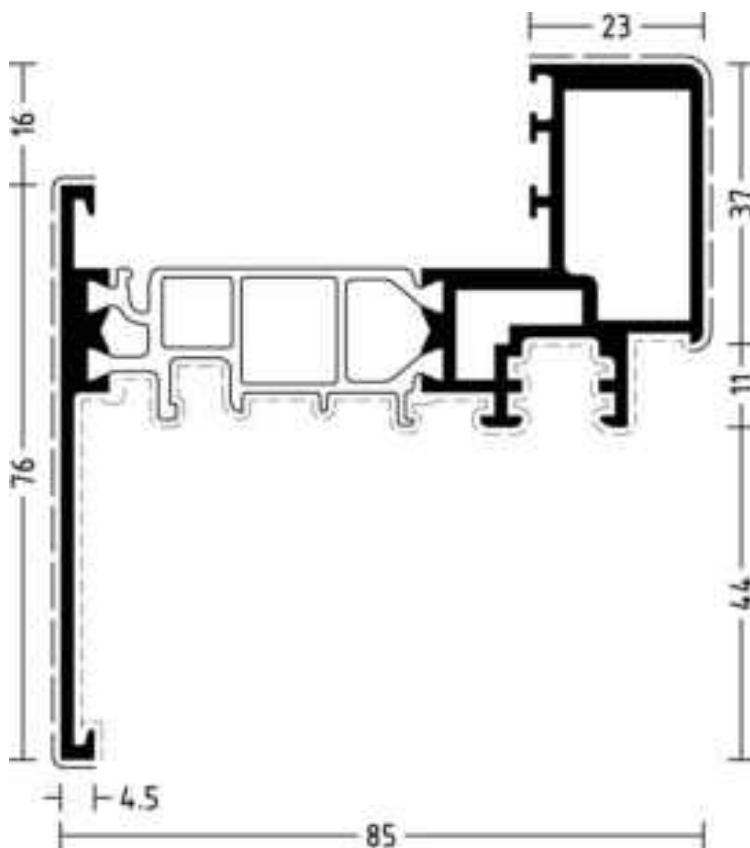















1017126

Verbindungselemente für Eckverbindung innen:
 1x 4070004 (Stulpflügelprofil) und 1x 4070000 (Flügelprofil)
 Connecting elements for corner connection inside:
 1x 4070004 (double casement sash profile) and 1x 4070000 (sash profile)

WICLINE 75 TOP

Kämpferprofile
Transom profiles



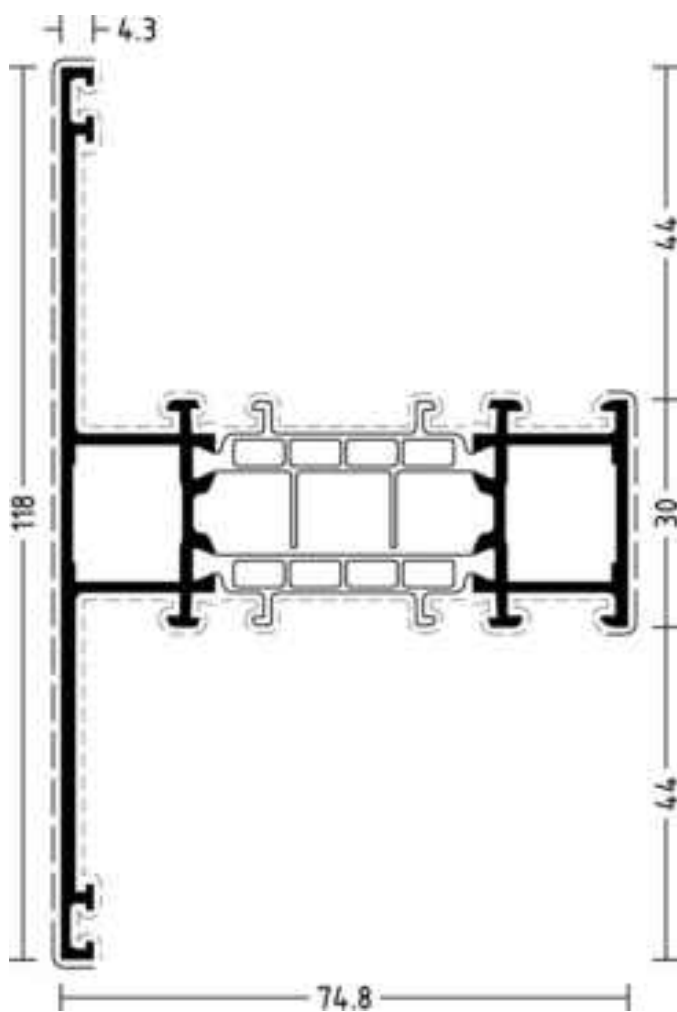







	 m	 mm	 mm										
 1017231	6,5	435	148	4950008	2x4070000	1x4960020	1x4070000	1x4070030	5910006	5940101	5940001	5930003	5930003
				4950008	2x4070000	1x4960020	1x4070000	1x4070030	5910006	5940101	5940001	5930003	5930003



1017231

WICLINE 75 TOP

Aufsatzprofile Supplementary profiles

	 m	 mm	 mm									
 1010463	6,5	196	1	-	-	-	-	-	-	-	-	-
 1010464	6,5	233	6	-	-	-	-	-	-	-	-	-

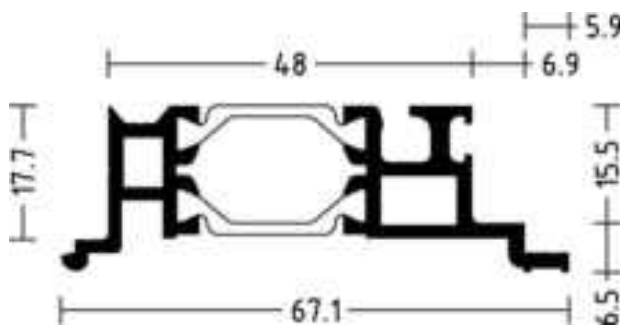

1010463

Verwendung:
Aufsatzprofil für Blendrahmenprofile zur Einspannung in WICTEC Serie
Application:
Supplementary profile of frame profiles for clamping

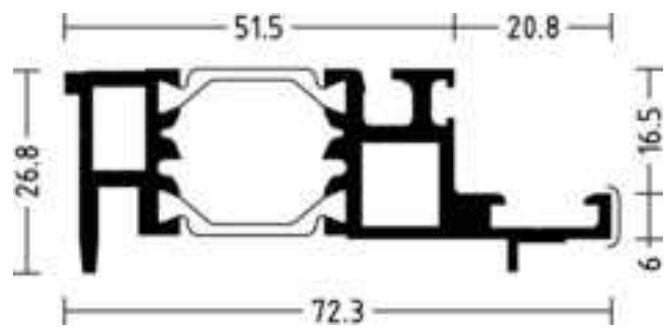

1010464

Verwendung:
Aufsatzprofil für Blendrahmenprofile zur Einspannung in WICTEC Serie
Application:
Supplementary profile of frame profiles for clamping

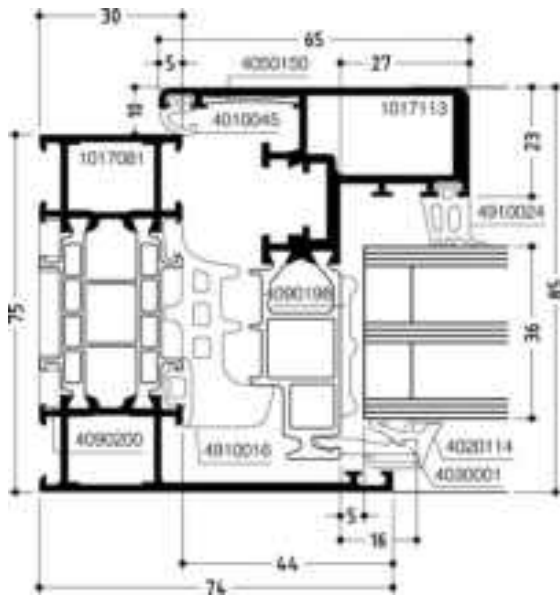

DOC-0000994033

Flügelprofil im
 Blendrahmen,
 verdeckter Flügel
*Concealed sash in
 frame*

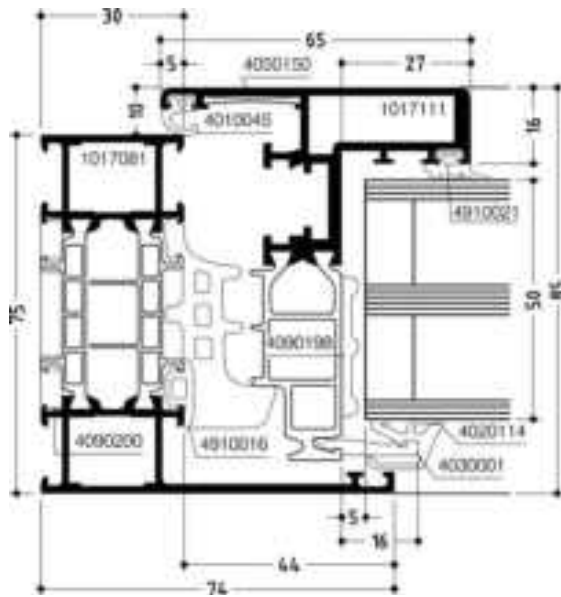

DOC-0001006400

Flügelprofil im
Blendrahmen,
verdeckter Flügel
*Concealed sash in
frame*

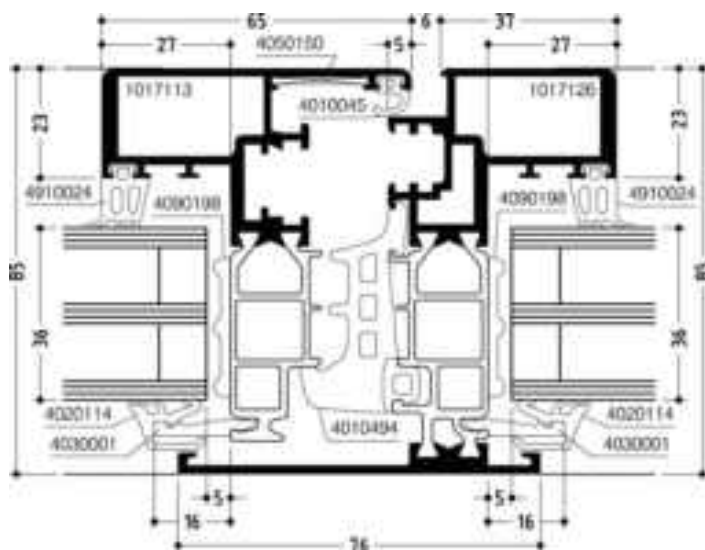

DOC-0000994242

Stulpfenster -
Mittelstoß, verdeck-
ter Flügel
*Double casement
window with
concealed sash -
Meeting stiles*

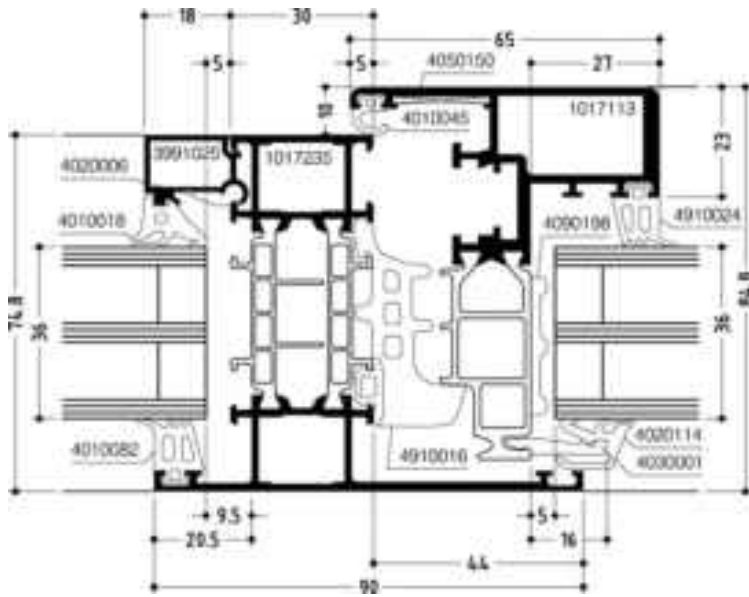

DOC-0000994267

Flügelprofil im
Blendrahmen mit
Kämpfer, verdeck-
ter Flügel

*Concealed sash in
frame with transom*

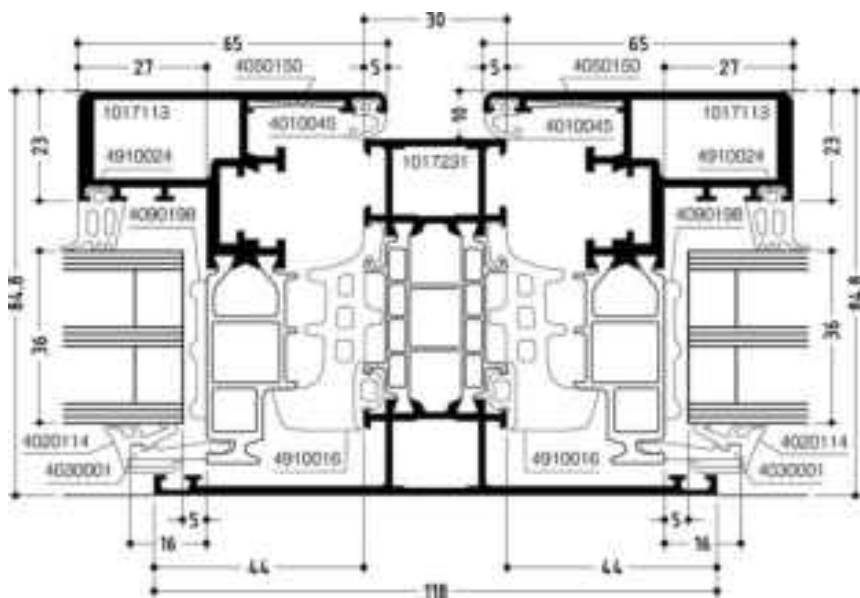

DOC-0000994276

Flügelprofil im
Blendrahmen mit
Kämpfer, verdeck-
ter Flügel

*Concealed sash in
frame with transom*

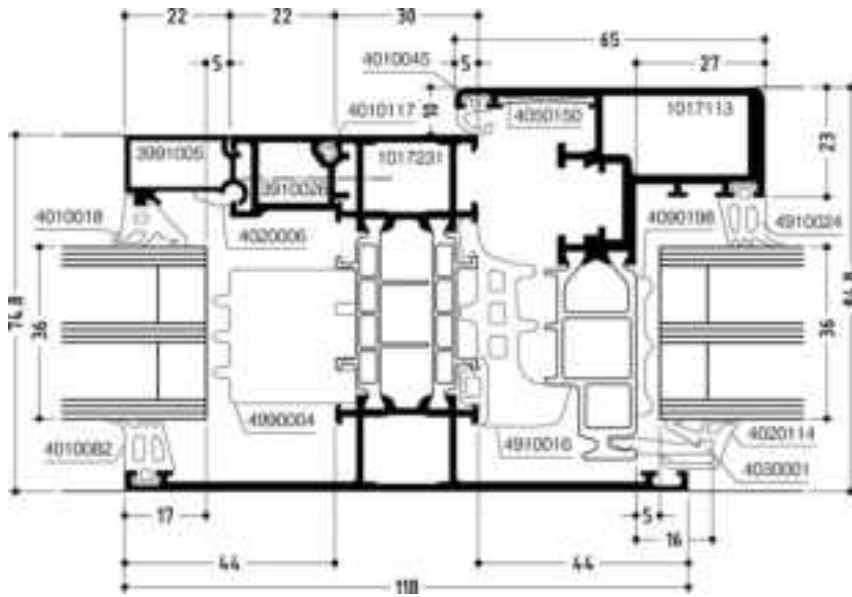

DOC-0000994294

Flügelprofil im
Blendrahmen mit
Kämpfer, verdeck-
ter Flügel

*Concealed sash in
frame with transom*

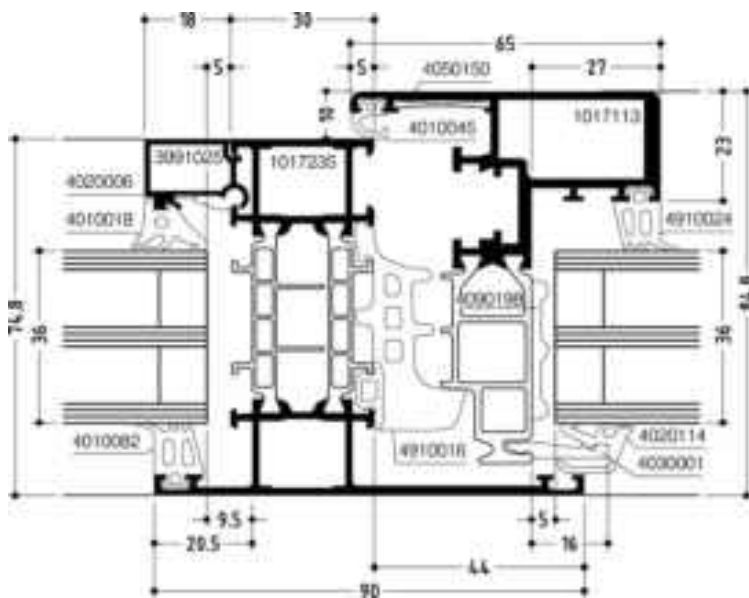

DOC-0000994327

Flügelprofil im
Blendrahmen mit
Kämpfer, verdeck-
ter Flügel

*Concealed sash in
frame with transom*

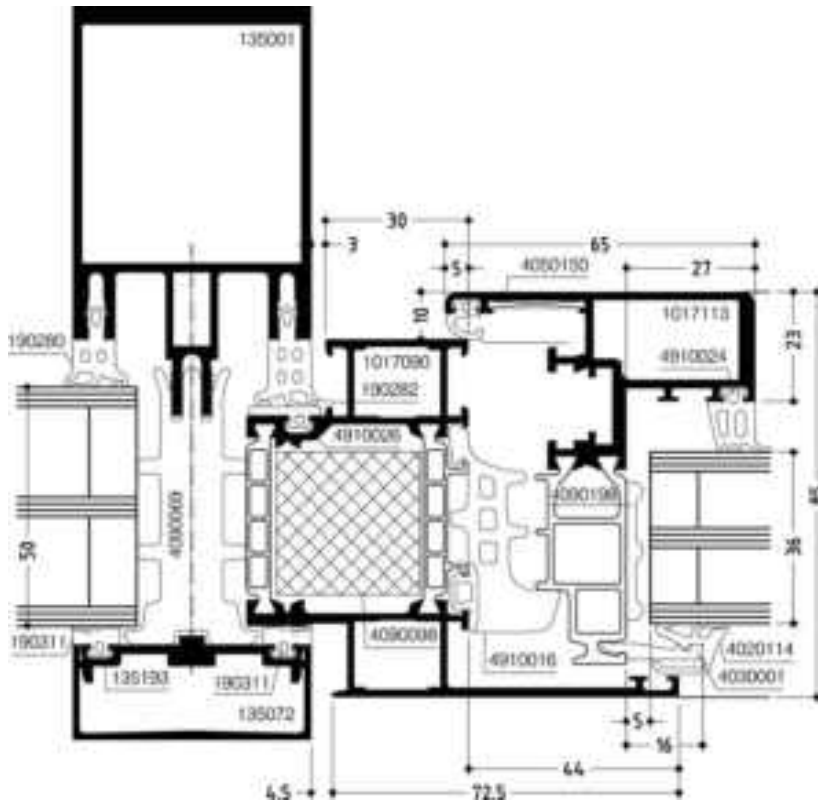

DOC-0000994384

Flügelprofil im
Einspannblendrah-
men, verdeckter
Flügel

*Concealed sash in
clamping frame*

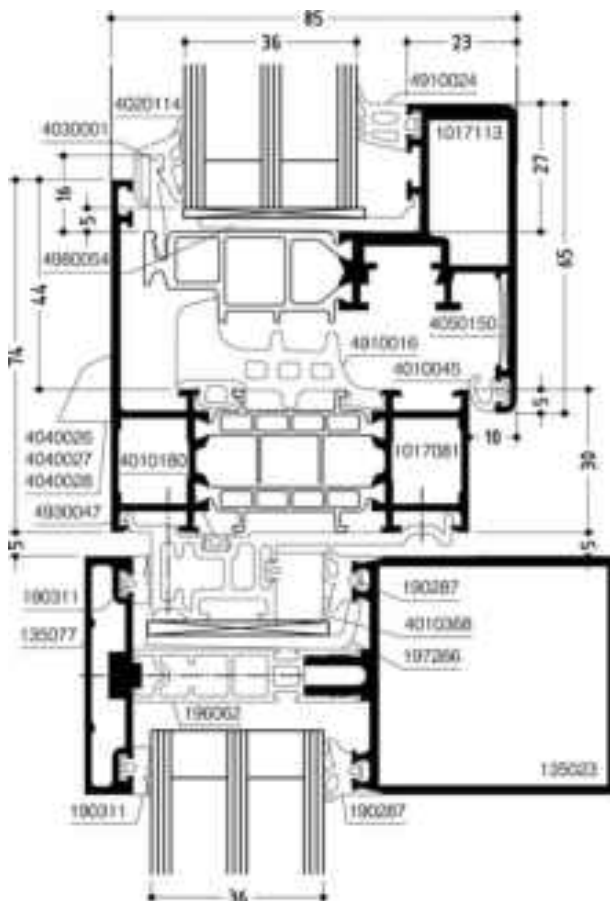

DOC-0000994415

Flügelprofil im
Blendrahmen mit
Einspannaufsatz,
verdeckter Flügel

*Concealed sash
in frame with
supplementary
clamping profile*

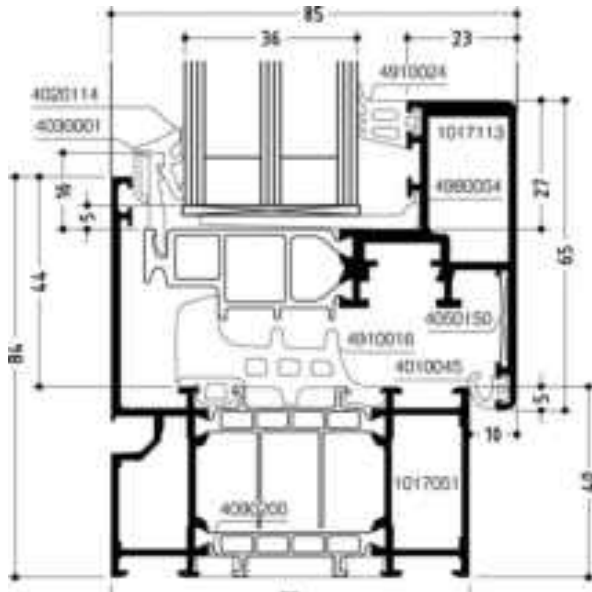

DOC-0001015394

Verdeckte Entwässerung, verdeckter Flügel

Concealed drainage, concealed sash in frame

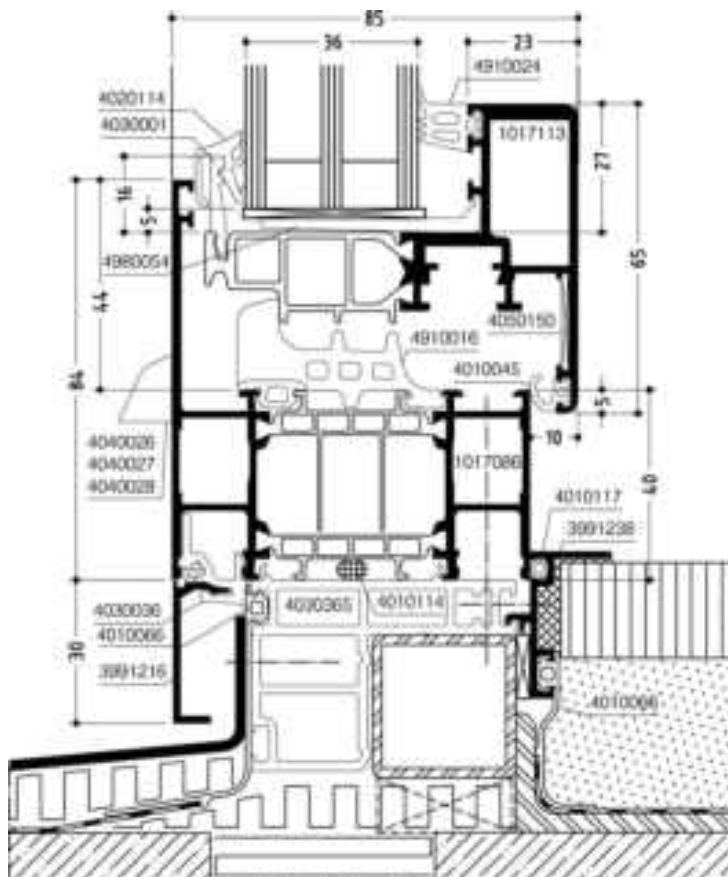

DOC-0000994477

Bauanschluss unten mit Dämm-
auflage 4030365, verdeckter Flügel

Bottom junction to structure with insulation support 4030365 and concealed sash

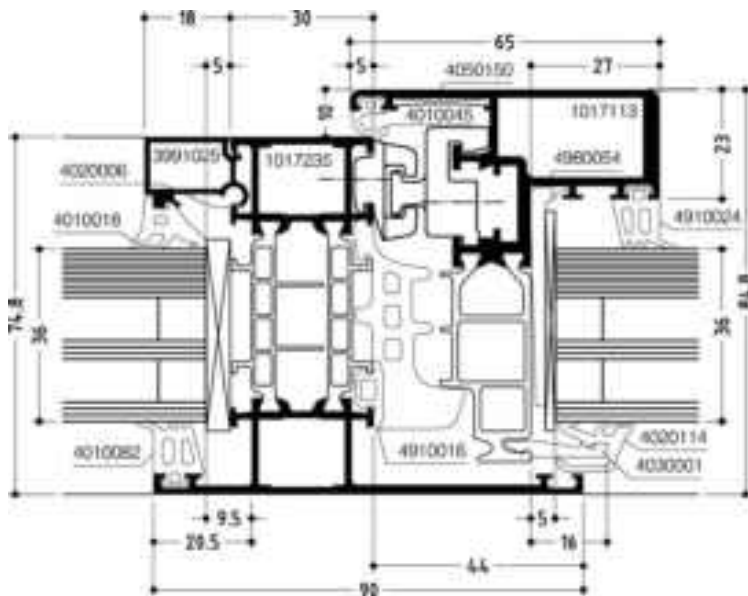

DOC-0001005414

Flügelprofil im
Blendrahmen
mit Kämpfer,
verdeckter Flügel,
EH-Verriegelung /
Füllungssicherung

*Concealed sash in
frame with transom,
burglar resistant
locking / Infill
safeguard*

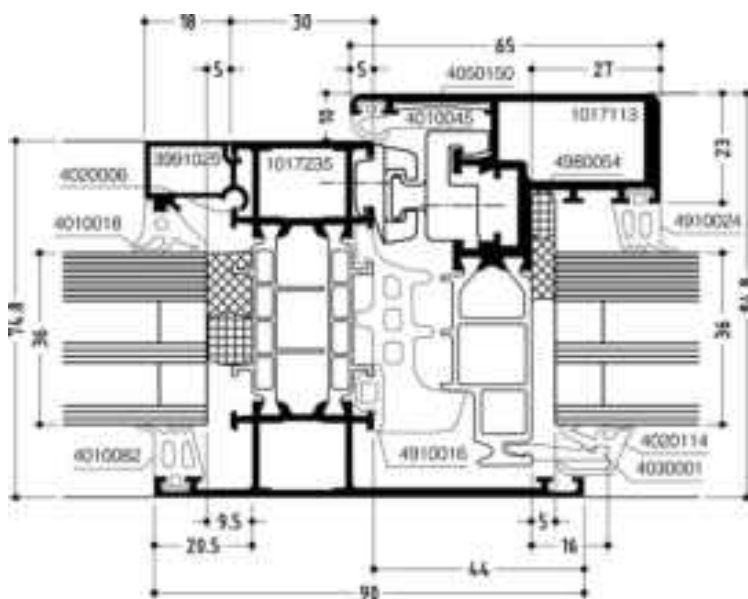

DOC-0001005431

Flügelprofil im
Blendrahmen
mit Kämpfer,
verdeckter Flügel,
EH-Verriegelung /
Füllungssicherung

*Concealed sash in
frame with transom,
burglar resistant
locking / Infill
safeguard*

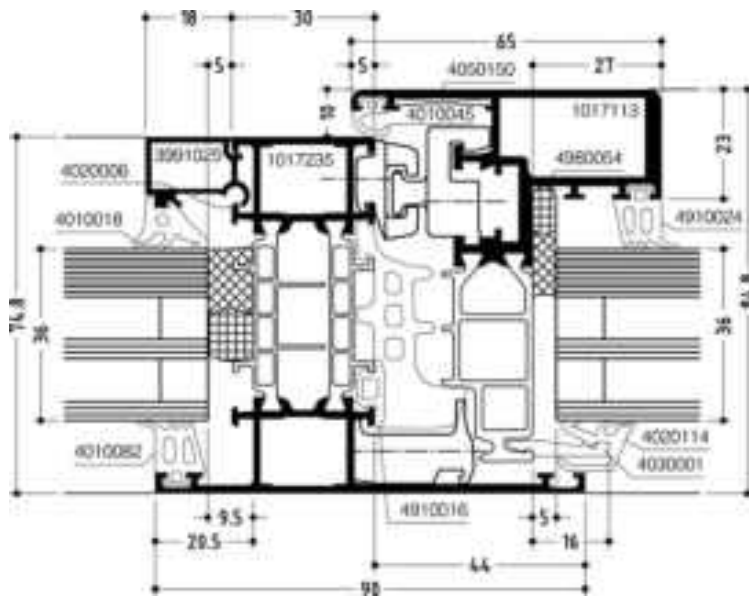

DOC-0001005454

Flügelprofil im
 Blendrahmen
 mit Kämpfer,
 verdeckter Flügel,
 EH-Verriegelung /
 Füllungssicherung

*Concealed sash in
 frame with transom,
 burglar resistant
 locking / Infill
 safeguard*

Glasleistenprofile, Auswahltabellen Glazing bead profiles, selection tables

Die Auswahltable zeigt die verschiedenen Glasleistenprofile und die zulässigen Füllungsdicken mit Toleranzen.

Die Auswahltable ist für Trockenverglasung mittels EPDM-Dichtungsprofilen ausgelegt.

Bei der Verglasung sind die Vorschriften der Glashersteller und der einschlägigen Fachverbände zu beachten, insbesondere die Forderung nach einem funktionssicheren Dampfdruckausgleich und Entwässerung der Hohlräume im Glasfalzraum zwischen Isolierglas-Scheibenkante und Falzgrund.

Die Auswahltabellen ermöglichen eine theoretische Vorplanung. Die Glastoleranzen sind zu berücksichtigen. Um extreme Toleranzen der Profile und Füllungsdicken ausgleichen zu können, ist es vorteilhaft, bei der Planung die Füllungsdicken aus den punktschraffierten Feldern der Auswahltable zu entnehmen.

Bei der Montage sind die Vorgaben praktisch zu prüfen und gegebenenfalls durch Variationen der Einrolldichtungen, dargestellt durch die schraffierten Felder, die notwendige Vorspannung aufzubringen.

In der Tabelle sind die Artikelnummern der schwarzen Dichtungen angegeben. Weitere Farben (z. B. grau), siehe Programm / Zubehör.

The selection table shows the different glazing bead profiles and the admissible infill thicknesses with tolerances.

The selection table is designed for dry glazing with EPDM glazing gaskets.

Please follow the glazing instructions of glass manufacturers and relevant professional associations, especially the demand for a functionally secure air pressure equalization and drainage of cavities in glazing rebate area between insulation glass pane edge and rebate base.

The selection tables enable a preliminary theoretical planning. The glass tolerances have to be considered while planning. It is recommended to select infill thicknesses from the dotted columns areas of the selection table in order to compensate for extreme tolerances of profiles and infill thicknesses.

Check the specifications practically and, if required, apply the correct gasket pressure by choosing the suitable roll-in gaskets listed in the hatched columns.

The gasket article numbers specified in the table are for black gaskets. For further colours (e. g. grey), please consult our Product range / Accessories.

empfohlen
recommended

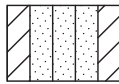

(XX) 402006
Anwendung bei beschichteten Profilen
Use on coated profiles



4020049
Anwendung bei eloxierten Profilen
Use on anodized profiles



Beispiel / Example

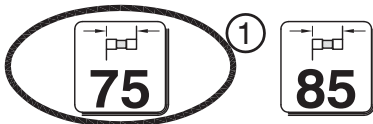

Glasleistenprofile Glazing bead profiles			(a) Füllungsdicke ± 1 mm mit Einrolldichtung Nr.: Infill thickness ± 1 mm with rolled gasket no.:				
Nr. / No. 18 mm	Nr. / No. 22 mm	(b) mm	4910004	4010015 blau / blue	4010016 rot / red	4010017 grün / green	4010018
3991022	3991001	2	60	59	58	57	56
3991023	3991002	5	57	56	55	54	53
3991024	3991003	9	53	52	51	50	49
3991025	3991004	12	50	49	48	47	46
3991026	3991005	15	47	46	45	44	43
3991027	3991006	19	43	42	41	40	39
3991028	3991007	22	40	39	38	37	36
3991029	3991008	24	38	37	36	35	34
3991030	3991009	26	36	35	34	33	32
3991031	3991010	29	33	32	31	30	29
3991032	3991011	32	30	29	28	27	26
3991033	3991012	34	28	27	26	25	24
3991034	3991013	37	25	24	23	22	21
3991035	3991014	41	21	20	19	18	17
3991036	3991015	45	17	16	15	14	13
3991037	3991016	49	13	12	11	10	9
	3991017	52	10	9	8	7	6

- ① Bautiefe auswählen
Select construction depth
- ② Füllungsdicke auswählen
Select infill thickness
- ③ Entsprechende Glasleiste
Appropriate glazing bead
- ④ Entsprechende innere Verglasungsdichtung
Appropriate inner glazing gasket

4010003
4020114
bei verdecktem Flügel
for concealed sash

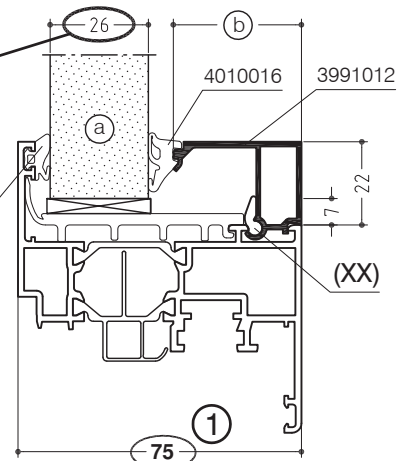

WICLINE 75 TOP

Glasleistenprofile, Auswahltabellen
Glazing bead profiles, selection tables



Glasleistenprofile Glazing bead profiles			(a) Füllungsdicke ±1 mm mit Einrolldichtung Nr.: Infill thickness ±1 mm with rolled gasket no.:				
Nr. / No. 18 mm	Nr. / No. 22 mm	(b) mm	4910004	4010015 blau / blue	4010016 rot / red	4010017 grün / green	4010018
	3991001	2	65	64	63	62	61
3991022	3991002	5	62	61	60	59	58
3991023	3991003	9	58	57	56	55	54
3991024	3991004	12	55	54	53	52	51
3991025	3991005	15	52	51	50	49	48
3991026	3991006	19	48	47	46	45	44
3991027	3991007	22	45	44	43	42	41
3991028	3991008	24	43	42	41	40	39
3991029	3991009	26	41	40	39	38	37
3991030	3991010	29	38	37	36	35	34
3991031	3991011	32	35	34	33	32	31
3991032	3991012	34	33	32	31	30	29
3991033	3991013	37	30	29	28	27	26
3991034	3991014	41	26	25	24	23	22
3991035	3991015	45	22	21	20	19	18
3991036	3991016	49	18	17	16	15	14
3991037	3991017	52	15	14	13	12	11

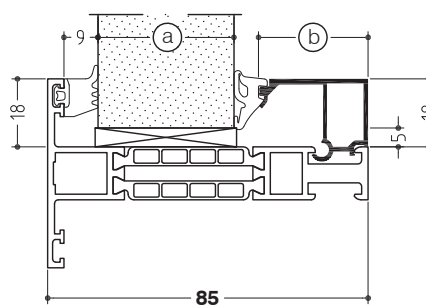
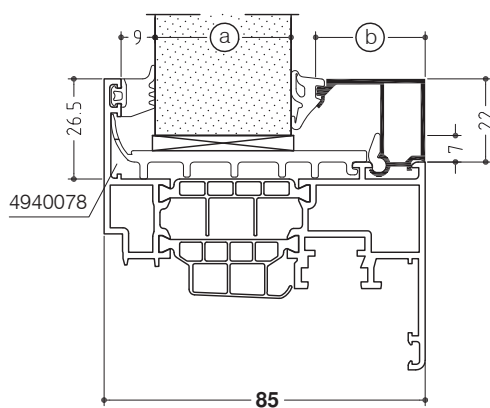

WICLINE 75 TOP

Glasleistenprofile, Auswahltabellen
Glazing bead profiles, selection tables



Glasleistenprofile Glazing bead profiles			(a) Füllungsdicke ±1 mm mit Einrolldichtung Nr.: Infill thickness ±1 mm with rolled gasket no.:				
Nr. / No. 18 mm	Nr. / No. 22 mm	(b) mm	4910004	4010015 blau / blue	4010016 rot / red	4010017 grün / green	4010018
	3991001	2	55	54	53	52	51
3991022	3991002	5	52	51	50	49	48
3991023	3991003	9	48	47	46	45	44
3991024	3991004	12	45	44	43	42	41
3991025	3991005	15	42	41	40	39	38
3991026	3991006	19	38	37	36	35	34
3991027	3991007	22	35	34	33	32	31
3991028	3991008	24	33	32	31	30	29
3991029	3991009	26	31	30	29	28	27
3991030	3991010	29	28	27	26	25	24
3991031	3991011	32	25	24	23	22	21
3991032	3991012	34	23	22	21	20	19
3991033	3991013	37	20	19	18	17	16
3991034	3991014	41	16	15	14	13	12
3991035	3991015	45	12	11	10	9	8
3991036	3991016	49	8	7	6	5	4
3991037	3991017	52	5	4	3	2	1

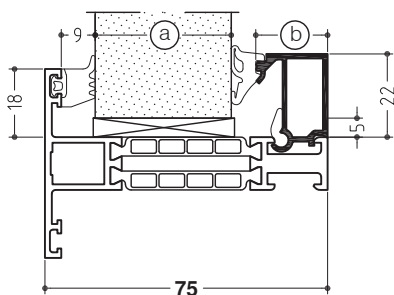
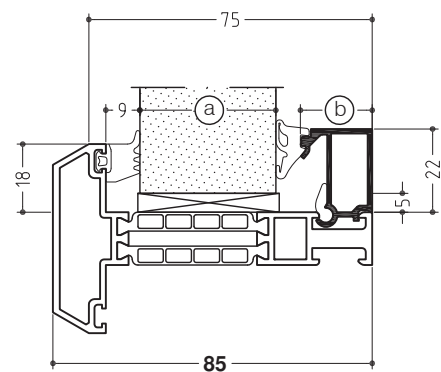
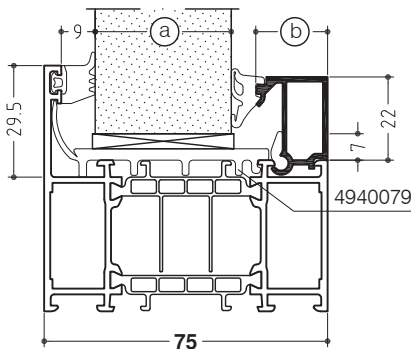
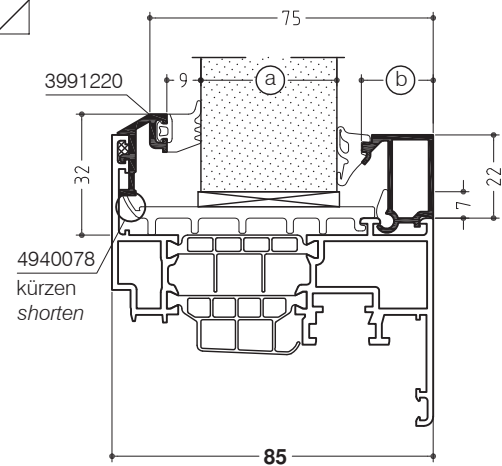
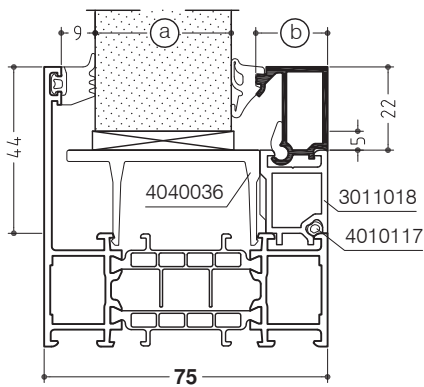

WICLINE 75 TOP

Glasleistenprofile, Auswahltabellen
Glazing bead profiles, selection tables



Verdeckter Flügel für Blendrahmen
Concealed sash for frame

1017111				
innere Dichtung inner gasket		(a) Füllungsdicke ± 1 mm Infill thickness ± 1 mm		
Nr. / No.	(c) Spaltmaß Gap dimension mm	48	49	50
4910021	4.5	48	49	50
4910022	6.5	46	47	48
4910023	8.5	44	45	46
4910024	10.5	42	43	44
4910025	12.5	40	41	42

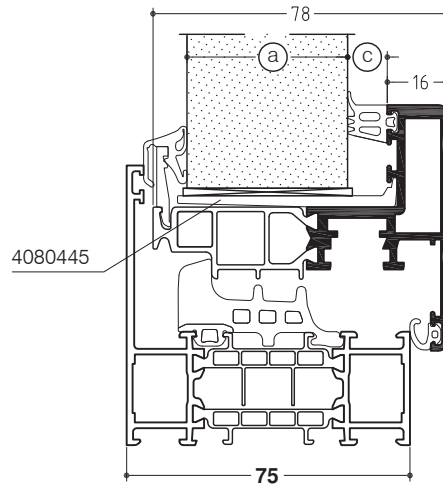

Verdeckter Flügel für Blendrahmen
Concealed sash for frame

1017112				
innere Dichtung inner gasket		(a) Füllungsdicke ± 1 mm Infill thickness ± 1 mm		
Nr. / No.	(c) Spaltmaß Gap dimension mm	45	46	47
4910021	4.5	45	46	47
4910022	6.5	43	44	45
4910023	8.5	41	42	43
4910024	10.5	39	40	41
4910025	12.5	37	38	39

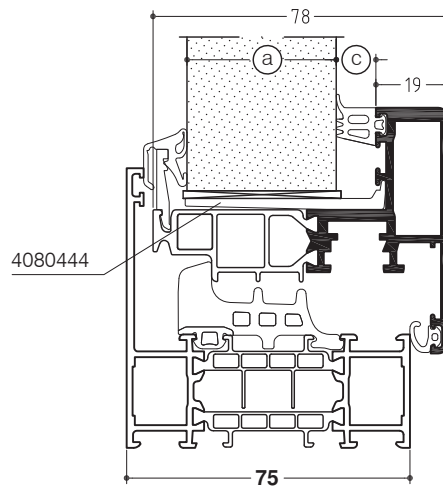

Verdeckter Flügel für Blendrahmen
Concealed sash for frame

1017113				
innere Dichtung inner gasket		(a) Füllungsdicke ± 1 mm Infill thickness ± 1 mm		
Nr. / No.	(c) Spaltmaß Gap dimension mm	41	42	43
4910021	4.5	41	42	43
4910022	6.5	39	40	41
4910023	8.5	37	38	39
4910024	10.5	35	36	37
4910025	12.5	33	34	35

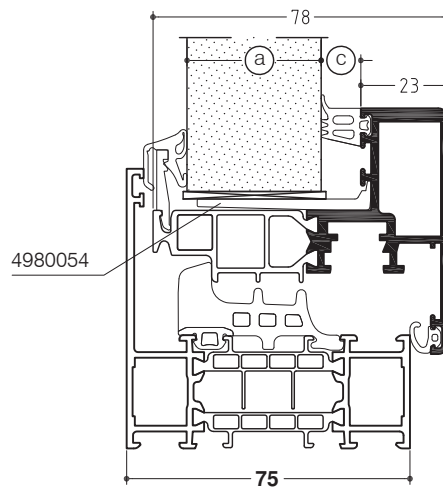

WICLINE 75 TOP

Glasleistenprofile, Auswahltabellen für Trockenverglasung
Glazing bead profiles, selection tables for dry glazing



Glasleistenprofile Glazing bead profiles		(a) Füllungsdicke ± 1 mm mit Einrolldichtung Nr.: Infill thickness ± 1 mm with rolled gasket no.:				
Nr. / No. 22 mm	(b) mm	4910004	4010015 blau / blue	4010016 rot / red	4010017 grün / green	4010018
3991001	2	65	64	63	62	61
3991264	5	62	61	60	59	58
3991265	9	58	57	56	55	54
3991266	12	55	54	53	52	51
3991267	15	52	51	50	49	48
3991268	19	48	47	46	45	44
3991269	22	45	44	43	42	41
3991270	24	43	42	41	40	39
3991271	26	41	40	39	38	37
3991272	29	38	37	36	35	34
3991273	32	35	34	33	32	31
3991274	34	33	32	31	30	29
3991275	37	30	29	28	27	26
3991276	41	26	25	24	23	22
3991277	45	22	21	20	19	18
3991278	49	18	17	16	15	14
3991279	52	15	14	13	12	11

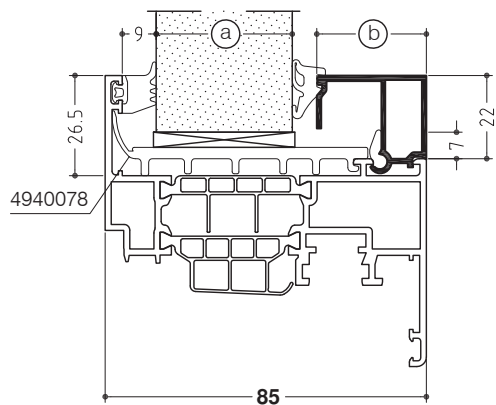

WICLINE 75 TOP

Technische Information
Technical Information

Glasleistenprofile, Auswahltabellen für Trockenverglasung
Glazing bead profiles, selection tables for dry glazing



Glasleistenprofile Glazing bead profiles		(a) Füllungsdicke ± 1 mm mit Einrolldichtung Nr.: Infill thickness ± 1 mm with rolled gasket no.:				
Nr. / No.	(b) mm	4910004	4010015 blau / blue	4010016 rot / red	4010017 grün / green	4010018
3991001	2	55	54	53	52	51
3991264	5	52	51	50	49	48
3991265	9	48	47	46	45	44
3991266	12	45	44	43	42	41
3991267	15	42	41	40	39	38
3991268	19	38	37	36	35	34
3991269	22	35	34	33	32	31
3991270	24	33	32	31	30	29
3991271	26	31	30	29	28	27
3991272	29	28	27	26	25	24
3991273	32	25	24	23	22	21
3991274	34	23	22	21	20	19
3991275	37	20	19	18	17	16
3991276	41	16	15	14	13	12
3991277	45	12	11	10	9	8
3991278	49	8	7	6	5	4
3991279	52	5	4	3	2	1

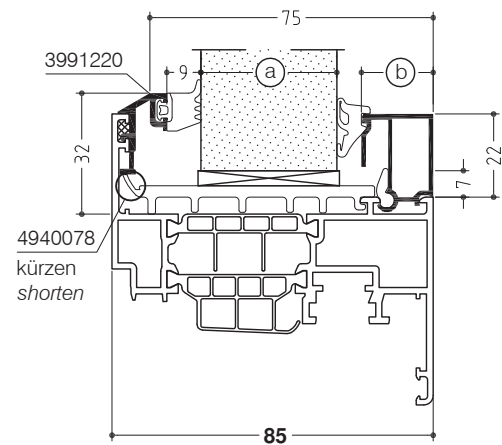
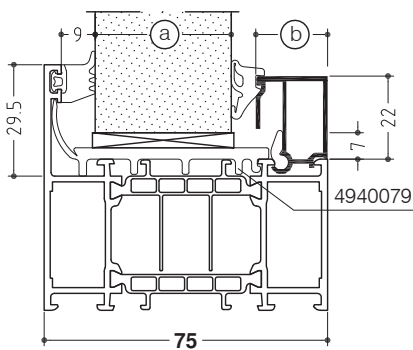
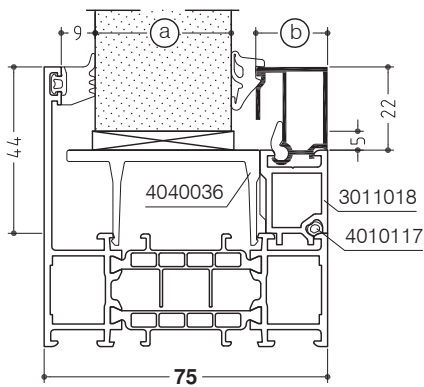

WICLINE 75 TOP

Glasleistenprofile, Auswahltabellen für Nassverglasung
 Glazing bead profiles, selection tables for wet glazing



Nr. / No. 22 mm	ⓑ mm	ⓐ Füllungsdicke ±1 mm Infill thickness ±1 mm			
		Spalt / Gap 4.5 mm	Spalt / Gap 5.5 mm	Spalt / Gap 6.5 mm	Spalt / Gap 7.5 mm
3991001	2	45	44	43	42
3991264	5	42	41	40	39
3991265	9	38	37	36	35
3991266	12	35	34	33	32
3991267	15	32	31	30	29
3991268	19	28	27	26	25
3991269	22	25	24	23	22
3991270	24	23	22	21	20
3991271	26	21	20	19	18
3991272	29	18	17	16	15
3991273	32	15	14	13	12
3991274	34	13	12	11	10
3991275	37	10	9	8	7
3991276	41	6	5	4	3
3991277	45	-	-	-	-

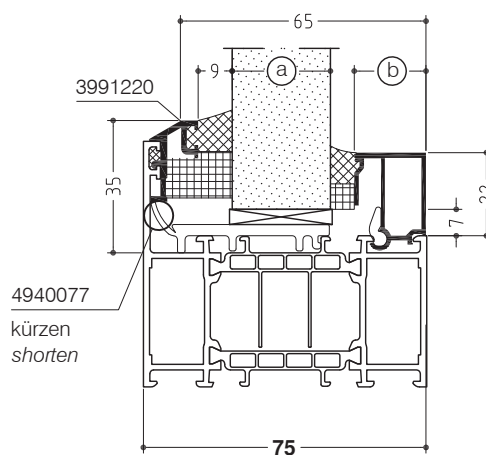
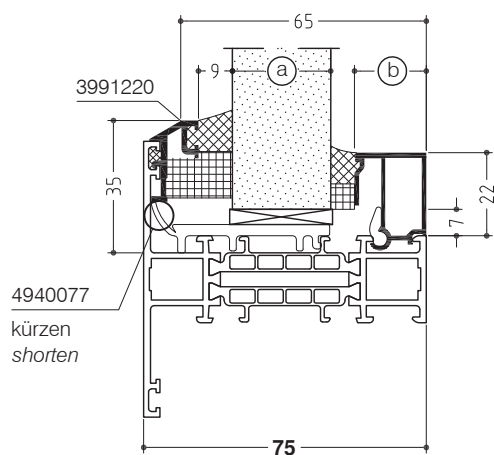

WICLINE 75 TOP

Glasleistenprofile, Auswahltabellen für Nassverglasung
Glazing bead profiles, selection tables for wet glazing



Nr. / No. 22 mm	ⓑ mm	ⓐ Füllungsdicke ±1 mm Infill thickness ±1 mm			
		Spalt / Gap 4.5 mm	Spalt / Gap 5.5 mm	Spalt / Gap 6.5 mm	Spalt / Gap 7.5 mm
3991001	2	55	54	53	52
3991264	5	52	51	50	49
3991265	9	48	47	46	45
3991266	12	45	44	43	42
3991267	15	42	41	40	39
3991268	19	38	37	36	35
3991269	22	35	34	33	32
3991270	24	33	32	31	30
3991271	26	31	30	29	28
3991272	29	28	27	26	25
3991273	32	25	24	23	22
3991274	34	23	22	21	20
3991275	37	20	19	18	17
3991276	41	16	15	14	13
3991277	45	12	11	10	9
3991278	49	8	7	6	5
3991279	52	5	4	3	2

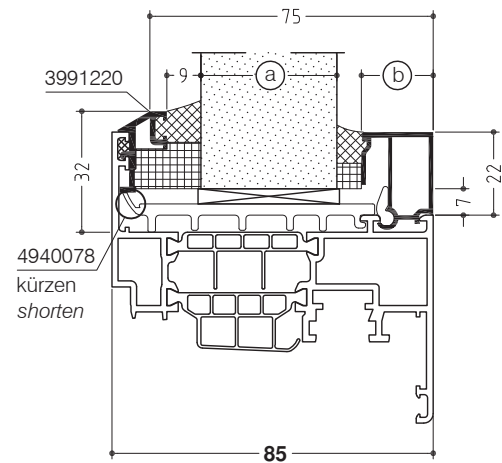
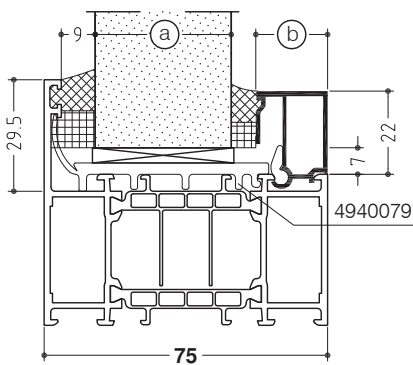
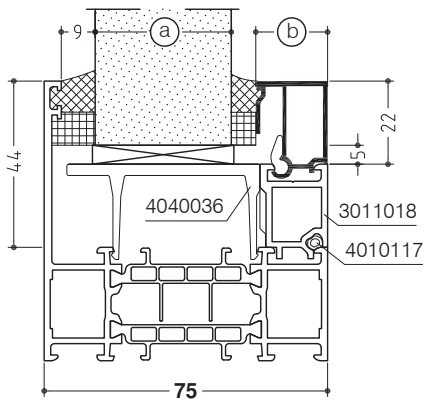

WICLINE 75 TOP

Glasleistenprofile, Auswahltabellen für Nassverglasung
Glazing bead profiles, selection tables for wet glazing



Glasleistenprofile Glazing bead profiles		(a) Füllungsdicke ±1 mm Infill thickness ±1 mm			
Nr. / No.	(b) mm	Spalt / Gap 4.5 mm	Spalt / Gap 5.5 mm	Spalt / Gap 6.5 mm	Spalt / Gap 7.5 mm
3991001	2	65	64	63	62
3991264	5	62	61	61	59
3991265	9	58	57	56	55
3991266	12	55	54	53	52
3991267	15	52	51	50	49
3991268	19	48	47	46	45
3991269	22	45	44	43	42
3991270	24	43	42	41	40
3991271	26	41	40	39	38
3991272	29	38	37	36	35
3991273	32	35	34	33	32
3991274	34	33	32	31	30
3991275	37	30	29	28	27
3991276	41	26	25	24	23
3991277	45	22	21	19	19
3991278	49	18	17	16	15
3991279	52	15	14	13	12

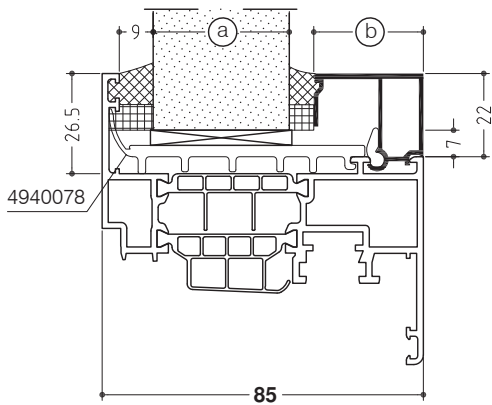

	Seite Page
Verdeckte Beschläge <i>Concealed fittings</i>	
Zulässige Flügelgrößen, sichtbarer Flügel <i>Admissible sash sizes, visible sash</i>	2/76
Zulässige Flügelgrößen, verdeckter Flügel <i>Admissible sash sizes, concealed sash</i>	2/85
Zulässige Formatgrößen <i>Admissible format sizes</i>	2/92
Beschlagsübersichten <i>Survey of fittings</i>	2/101

WICLINE 75 TOP

Verdeckte Beschläge
Concealed fittings



Zulässige Flügelgrößen
Admissible sash sizes



Profile Profiles		1017101				1017102				1017103				1017104 1017105				
	(Pa)	800	1200	2000	-	800	1200	2000	2000	800	1200	2000	2000*	800	1200	2000*	-	
	(Pa)	150	300	600	-	150	300	600	600	150	300	600	600	150	300	600	-	
Flügelgröße Sash size	max.	FAB (m)	1.3	1.2	1.1	-	1.6	1.5	1.4	1.0	1.6	1.6	1.5	1.0	1.7	1.7	1.6	-
		FAH (m)	1.7	1.7	1.7	-	2.0	2.0	2.0	2.25	2.25	2.25	2.25	2.5	2.5	2.5	2.5	-
	min.	FAB (m)	0.45	0.45	0.45	-	0.45	0.45	0.45	0.45	0.45	0.45	0.45	0.45	0.45	0.45	0.45	-
		FAH (m)	0.6	0.6	0.6	-	0.6	0.6	0.6	0.6	0.6	0.6	0.6	0.6	0.6	0.6	0.6	-
MV / MB	FAB (m)	-	-	-	-	-	-	1.3	-	-	-	1.3	-	-	-	1.3	-	
	FAH (m)	1.5	1.5	1.3	-	1.7	1.6	1.5	1.5	1.8	1.7	1.6	1.5*	1.8	1.7	1.6*	-	
	min.	FAB (m)	0.45	0.45	0.45	-	0.45	0.45	0.45	0.45	0.45	0.45	0.45	0.45	0.45	0.45	0.45	-
		FAH (m)	0.83	0.83	0.83	-	0.83	0.83	0.83	0.83	0.83	0.83	0.83	0.83	0.83	0.83	0.83	-
	min.	FAB (m)	0.65	0.65	0.65	-	0.65	0.65	0.65	0.65	0.65	0.65	0.65	0.65	0.65	0.65	0.65	-
		FAH (m)	0.9	0.9	0.9	-	0.9	0.9	0.9	0.9	0.9	0.9	0.9	0.9	0.9	0.9	0.9	-
	max. (kg)	100 (Klotzabst. 50 mm zur Ecke) (Shim dist. to corner 50 mm)				160												

* Windlast > 1600 Pa und FAH > 2.25 m werden zwei vertikale Zusatzverriegelungen benötigt

* Wind load > 1600 Pa and FAH 2.25 m requires two vertical additional locking points





WICLINE 75 TOP

Verdeckte Beschläge
Concealed fittings



Zulässige Flügelgrößen
Admissible sash sizes

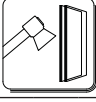

Profile Profiles		1017101				1017102				1017103								
	(Pa)	1600	-	-	-	1600	1600	-	-	1600	1600	-	-					
	(Pa)	600	-	-	-	600	600	-	-	600	600	-	-					
Flügelgröße Sash size	max.	FAB (m)	1.1	-	-	-	1.3	1.0	-	-	1.3	1.0	-	-				
		FAH (m)	1.7	-	-	-	2.0	2.25	-	-	2.25	2.5	-	-				
	min.	FAB (m)	0.45	-	-	-	0.45	0.45	-	-	0.45	0.45	-	-				
		FAH (m)	0.6*	-	-	-	0.6*	0.6*	-	-	0.6*	0.6*	-	-				
MV / MB	FAB (m)	-	-	-	-	-	-	-	-	-	-	-	-					
	FAH (m)	1.3	-	-	-	1.5	1.5	-	-	1.6	1.5	-	-					
	min.	FAB (m)	-	-	-	-	-	-	-	-	-	-	-					
		FAH (m)	-	-	-	-	-	-	-	-	-	-	-					
	min.	FAB (m)	-	-	-	-	-	-	-	-	-	-	-					
		FAH (m)	-	-	-	-	-	-	-	-	-	-	-					
	max.(kg)		100				160											

* FAH_{min.} begrenzt über FAH1_{min.} = 0.6 m
*FAH_{min.} limited through FAH1_{min.} = 0.6 m



FAB1_{min.} = 0.3 m

WICLINE 75 TOP

Verdeckte Beschläge
Concealed fittings



Zulässige Flügelgrößen
Admissible sash sizes



Profile
Profiles

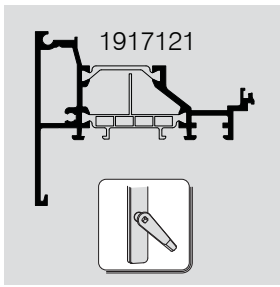

1017101	1017102	1017103	1017104 1017105	

	(Pa) (m ²)**	800	1200	1600 (1.5)**	-	800	1200	1600 (1.7)**	1600 (1.7)**	800	1200	1600 (1.8)**	1600* (1.8)**	800	1200	1600* (2.0)**	-		
	(Pa)	150	300	600	-	150	300	600	600	150	300	600	600	150	300	450	-		
Flügelgröße Sash size	max.	FAB (m)	1.3	1.2	1.1	-	1.6	1.5	1.4	1.0	1.6	1.6	1.5	1.0	1.7	1.7	1.6	-	
		FAH (m)	1.7	1.7	1.7	-	2.0	2.0	2.0	2.25	2.25	2.25	2.25	2.5	2.5	2.5	2.5	-	
	min.	FAB (m)	0.45	0.45	0.45	-	0.45	0.45	0.45	0.45	0.45	0.45	0.45	0.45	0.45	0.45	0.45	0.45	-
		FAH (m)	0.68	0.68	0.68	-	0.68	0.68	0.68	0.68	0.68	0.68	0.68	0.68	0.68	0.68	0.68	0.68	-
MV / MB	FAB (m)	-	-	-	-	-	-	1.3	-	1.3	1.3	1.3	-	1.3	1.3	1.3	-		
	FAH (m)	1.5	1.5	1.3	-	1.7	1.6	1.5	1.5	1.8	1.7	1.6	1.5*	1.8	1.7	1.6*	-		
	min.	FAB (m)	0.65	0.65	0.65	-	0.65	0.65	0.65	0.65	0.65	0.65	0.65	0.65	0.65	0.65	0.65	-	
		FAH (m)	1.05	1.05	1.05	-	1.05	1.05	1.05	1.05	1.05	1.05	1.05	1.05	1.05	1.05	1.05	-	
	min.	FAB (m)	0.65	0.65	0.65	-	0.65	0.65	0.65	0.65	0.65	0.65	0.65	0.65	0.65	0.65	0.65	-	
		FAH (m)	1.12	1.12	1.12	-	1.12	1.12	1.12	1.12	1.12	1.12	1.12	1.12	1.12	1.12	1.12	-	
	max. (kg)	100 (Klotzabst. 50 mm zur Ecke) (Shim dist. to corner 50 mm)				160													

* Windlast > 1200 Pa und FAH > 2.25 m werden zwei vertikale Zusatzverriegelungen benötigt
* Wind load > 1200 Pa and FAH 2.25 m requires two vertical additional locking points

** Flügelgröße > () m² benötigt eine horizontale Zusatzverriegelung
** Sash size > () m² requires a horizontal additional locking point

WICLINE 75 TOP

Verdeckte Beschläge
Concealed fittings



Zulässige Flügelgrößen
Admissible sash sizes



Profile
Profiles

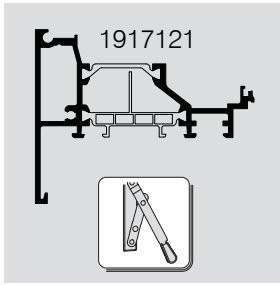

1017101	1017102	1017103	1017104 1017105	

	(Pa) (m ²)**	800	1200	1600 (1.5)**	-	800	1200	1600 (1.7)**	1600 (1.7)**	800	1200	1600 (1.8)**	1600 (1.8)**	800	1200	1600 (2.0)**	-		
	(Pa)	150	300	600	-	150	300	600	600	150	300	600	600	150	300	600	-		
Flügelgröße Sash size	max.	FAB (m)	1.2	1.2	1.2	-	1.3	1.3	1.3	1.0	1.3	1.3	1.3	1.0	1.3	1.3	1.3	-	
		FAH (m)	1.7	1.6	1.5	-	1.9	1.8	1.7	2.25	2.0	1.9	1.7	2.25	2.25	2.25	2.25	-	
	min.	FAB (m)	0.45	0.45	0.45	-	0.45	0.45	0.45	0.45	0.45	0.45	0.45	0.45	0.45	0.45	0.45	0.45	-
		FAH (m)	0.72	0.72	0.72	-	0.72	0.72	0.72	0.72	0.72	0.72	0.72	0.72	0.72	0.72	0.72	0.72	-
MV / MB	FAB (m)	-	-	-	-	-	-	-	-	-	-	-	-	-	-	-	-	-	
	FAH (m)	1.5	1.5	1.3	-	1.7	1.6	1.5	1.5	1.8	1.7	1.6	1.5	1.8	1.7	1.6	1.6	-	
	min.	FAB (m)	-	-	-	-	-	-	-	-	-	-	-	-	-	-	-	-	
		FAH (m)	-	-	-	-	-	-	-	-	-	-	-	-	-	-	-	-	-
	min.	FAB (m)	-	-	-	-	-	-	-	-	-	-	-	-	-	-	-	-	
		FAH (m)	-	-	-	-	-	-	-	-	-	-	-	-	-	-	-	-	-
	max. (kg)	100 (Klotzabst. 50 mm zur Ecke) (Shim dist. to corner 50 mm)				160													

** Flügelgröße > () m² benötigt eine horizontale Zusatzverriegelung am Gehflügel
** Sash size > () m² requires a horizontal additional locking point on the active leaf

WICLINE 75 TOP

Verdeckte Beschläge
Concealed fittings



Zulässige Flügelgrößen Admissible sash sizes



Profile
Profiles

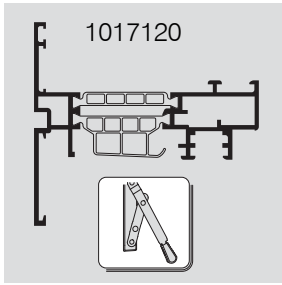
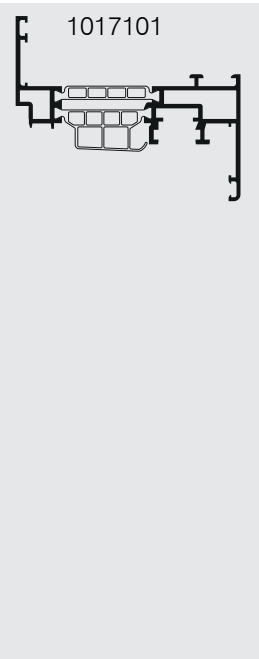

	(Pa)	800	1200	-	-	
	(Pa)	300	600	-	-	
Flügelgröße Sash size	max.	FAB (m)	1.2	1.2	-	-
		FAH (m)	1.6	1.5	-	-
	min.	FAB (m)	0.45	0.45	-	-
		FAH (m)	0.72	0.72	-	-
MV / MB	FAB (m)	-	-	-	-	
	FAH (m)	1.4	1.3	-	-	
	min.	FAB (m)	-	-	-	-
		FAH (m)	-	-	-	-
	min.	FAB (m)	-	-	-	-
		FAH (m)	-	-	-	-
	max. (kg)	100 (Klotzabst. 50 mm zur Ecke) (Shim dist. to corner 50 mm)				

Profile
Profiles

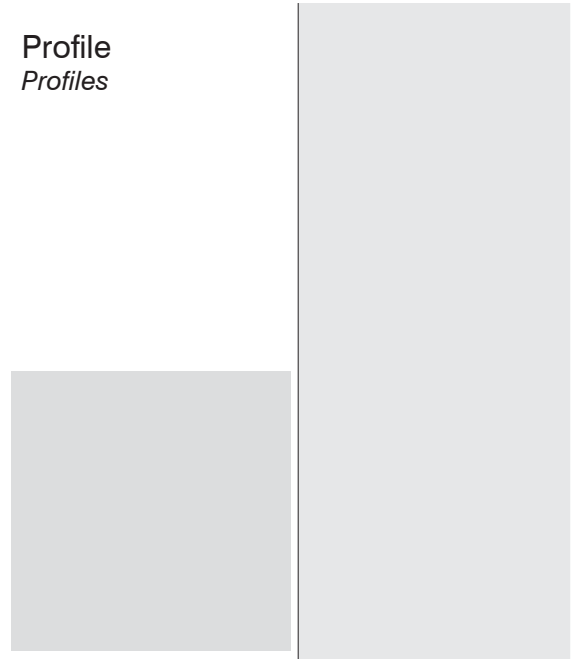

	(Pa)				
	(Pa)				
Flügelgröße Sash size	max.	FAB (m)			
		FAH (m)			
	min.	FAB (m)			
		FAH (m)			
MV / MB	FAB (m)				
	FAH (m)				
	min.	FAB (m)			
		FAH (m)			
	min.	FAB (m)			
		FAH (m)			
	max. (kg)				





WICLINE 75 TOP

Verdeckte Beschläge
Concealed fittings



Zulässige Flügelgrößen
Admissible sash sizes

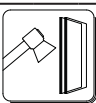
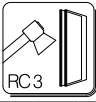

Profile Profiles		1017101				1017102				1017103				1017104 1017105				
	(Pa)	800	1200	2000	-	800	1200	2000	2000	800	1200	2000	2000*	800	1200	2000*	-	
	(Pa)	150	300	600	-	150	300	600	600	150	300	600	600	150	300	600	-	
Flügelgröße Sash size	max.	FAB (m)	1.3	1.2	1.1	-	1.6	1.5	1.4	1.0	1.6	1.6	1.5	1.0	1.7	1.7	1.6	-
		FAH (m)	1.7	1.7	1.7	-	2.0	2.0	2.0	2.25	2.25	2.25	2.25	2.5	2.5	2.5	2.5	-
	min.	FAB (m)	0.425	0.425	0.425	-	0.425	0.425	0.425	0.425	0.425	0.425	0.425	0.425	0.425	0.425	0.425	-
		FAH (m)	0.7	0.7	0.7	-	0.7	0.7	0.7	0.7	0.7	0.7	0.7	0.7	0.7	0.7	0.7	-
MV / MB	FAB (m)	-	-	-	-	-	-	1.3	-	-	-	1.3	-	-	-	1.3	-	
	FAH (m)	1.5	1.5	1.3	-	1.7	1.6	1.5	1.5	1.8	1.7	1.6	1.5*	1.8	1.7	1.6*	-	
	min.	FAB (m)	0.425	0.425	0.425	-	0.425	0.425	0.425	0.425	0.425	0.425	0.425	0.425	0.425	0.425	0.425	-
		FAH (m)	0.7	0.7	0.7	-	0.7	0.7	0.7	0.7	0.7	0.7	0.7	0.7	0.7	0.7	0.7	-
	min.	FAB (m)	0.68	0.68	0.68	-	0.68	0.68	0.68	0.68	0.68	0.68	0.68	0.68	0.68	0.68	0.68	-
		FAH (m)	0.9	0.9	0.9	-	0.9	0.9	0.9	0.9	0.9	0.9	0.9	0.9	0.9	0.9	0.9	-
	max.(kg)	100				130												

* Windlast > 1600 Pa und FAH > 2.25 m werden zwei vertikale Zusatzverriegelungen benötigt

* Wind load > 1600 Pa and FAH 2.25 m requires two vertical additional locking points

WICLINE 75 TOP

Verdeckte Beschläge
Concealed fittings



Zulässige Flügelgrößen
Admissible sash sizes



Profile Profiles		1017101				1017102				1017103				1017104 1017105				
	(Pa)	800	1200	2000	-	800	1200	2000	2000	800	1200	2000	2000*	800	1200	2000*	-	
	(Pa)	150	300	600	-	150	300	600	600	150	300	600	600	150	300	600	-	
Flügelgröße Sash size	max.	FAB (m)	1.7	1.7	1.7	-	2.0	2.0	2.0	2.25	2.25	2.25	2.25	2.5	2.5	2.5	2.5	-
		FAH (m)	1.3	1.2	1.1	-	1.6	1.5	1.4	1.0	1.6	1.6	1.5	1.0	1.7	1.7	1.6	-
	min.	FAB (m)	0.6	0.6	0.6	-	0.6	0.6	0.6	0.6	0.6	0.6	0.6	0.6	0.6	0.6	0.6	-
		FAH (m)	0.45	0.45	0.45	-	0.45	0.45	0.45	0.45	0.45	0.45	0.45	0.45	0.45	0.45	0.45	-
MV / MB	FAB (m)	1.5	1.5	1.3	-	1.7	1.6	1.5	1.5	1.8	1.7	1.6	1.5*	1.8	1.7	1.6*	-	
	FAH (m)	-	-	-	-	-	-	1.3	-	-	-	1.3	-	-	-	1.3	-	
	min.	FAB (m)	0.74	0.74	0.74	-	0.74	0.74	0.74	0.74	0.74	0.74	0.74	0.74	0.74	0.74	0.74	-
		FAH (m)	0.45	0.45	0.45	-	0.45	0.45	0.45	0.45	0.45	0.45	0.45	0.45	0.45	0.45	0.45	-
	min.	FAB (m)	0.9	0.9	0.9	-	0.9	0.9	0.9	0.9	0.9	0.9	0.9	0.9	0.9	0.9	0.9	-
		FAH (m)	0.6	0.6	0.6	-	0.6	0.6	0.6	0.6	0.6	0.6	0.6	0.6	0.6	0.6	0.6	-
	max. (kg)	100 (Klotzabst. 50 mm zur Ecke) (Shim dist. to corner 50 mm)				130												

*** Zusätzliche Verklebung, Angaben in den Verarbeitungsrichtlinien beachten!
*** Additional gluing, pay attention to specifications in the workshop manual!

WICLINE 75 TOP

Verdeckte Beschläge
Concealed fittings



Zulässige Flügelgrößen
Admissible sash sizes



Profile Profiles		1017101				1017102				1017103				1017104 1017105				
	(Pa)	800	1200	2000	-	800	1200	2000	2000	800	1200	2000	2000*	800	1200	2000*	-	
	(Pa)	150	300	600	-	150	300	600	600	150	300	600	600	150	300	600	-	
Flügelgröße Sash size	max.	FAB (m)	1.7	1.7	1.7	-	2.0	2.0	2.0	2.25	2.25	2.25	2.25	2.5	2.5	2.5	2.5	-
		FAH (m)	1.3	1.2	1.1	-	1.6	1.5	1.4	1.0	1.6	1.6	1.5	1.0	1.7	1.7	1.6	-
	min.	FAB (m)	0.55	0.55	0.55	-	0.55	0.55	0.55	0.55	0.55	0.55	0.55	0.55	0.55	0.55	0.55	-
		FAH (m)	0.51	0.51	0.51	-	0.51	0.51	0.51	0.51	0.51	0.51	0.51	0.51	0.51	0.51	0.51	-
MV / MB	FAB (m)	1.5	1.5	1.3	-	1.7	1.6	1.5	1.5	1.8	1.7	1.6	1.5*	1.8	1.7	1.6*	-	
	FAH (m)	-	-	-	-	-	-	1.3	-	-	-	1.3	-	-	-	1.3	-	
	min.	FAB (m)	-	-	-	-	-	-	-	-	-	-	-	-	-	-	-	-
		FAH (m)	-	-	-	-	-	-	-	-	-	-	-	-	-	-	-	-
	min.	FAB (m)	-	-	-	-	-	-	-	-	-	-	-	-	-	-	-	-
		FAH (m)	-	-	-	-	-	-	-	-	-	-	-	-	-	-	-	-
	max. (kg)	80 (Klotzabst. 50 mm zur Ecke) (Shim dist. to corner 50 mm)				80 / 120												

* Windlast > 1600 Pa und FAB > 2.25 m werden zwei horizontale Zusatzverriegelungen/Mittelbänder benötigt

* Wind load > 1600 Pa and FAB 2.25 m requires two horizontal additional locking points/centre hinges

WICLINE 75 TOP

Verdeckte Beschläge
Concealed fittings



Zulässige Flügelgrößen
Admissible sash sizes



Profile Profiles		1017101				1017102												
		(Pa)	800	1200	1600	-	800	1200	1600	-								
		(Pa)	150	300	600	-	150	300	600	-								
Flügelgröße Sash size	max.	FAB (m)	1.7	1.7	1.7	-	2.0	2.0	2.0	-								
		FAH (m)	1.3	1.2	1.1	-	1.6	1.5	1.3	-								
	min.	FAB (m)	0.55	0.55	0.55	-	0.55	0.55	0.55	-								
		FAH (m)	0.45	0.45	0.45	-	0.45	0.45	0.45	-								
MV / MB		FAB (m)	1.5	1.5	1.3	-	1.7	1.6	1.5	-								
		FAH (m)	-	-	-	-	-	-	-	-								
	min.	FAB (m)	-	-	-	-	-	-	-	-								
		FAH (m)	-	-	-	-	-	-	-	-								
	min.	FAB (m)	-	-	-	-	-	-	-	-								
		FAH (m)	-	-	-	-	-	-	-	-								
	max.	max. (kg)	80 (Klotzabst. 50 mm zur Ecke) (Shim dist. to corner 50 mm)				80 / 120											

WICLINE 75 TOP

Verdeckte Beschläge
Concealed fittings



Zulässige Flügelgrößen
Admissible sash sizes



Profile Profiles		1017111				1017113				1017111				1017113				
	(Pa)	800	1200	2000	-	800	1200	2000	-	800	1200	2000	-	800	1200	2000	-	
	(Pa)	150	300	600	-	150	300	600	-	150	300	600	-	150	300	600	-	
Flügelgröße Sash size	max.	FAB (m)	1.4	1.3	1.2	-	1.4	1.4	1.3	-	1.4	1.3	1.2	-	1.4	1.4	1.3	-
		FAH (m)	1.7	1.7	1.7	-	1.8	1.8	1.8	-	1.8	2.0	2.1	-	2.0	2.0	2.25	-
	min.	FAB (m)	0.45	0.45	0.45	-	0.45	0.45	0.45	-	0.45	0.45	0.45	-	0.45	0.45	0.45	-
		FAH (m)	0.6	0.6	0.6	-	0.6	0.6	0.6	-	0.6	0.6	0.6	-	0.6	0.6	0.6	-
MV / MB	FAB (m)	-	-	-	-	-	-	-	-	-	-	-	-	-	-	1.2	-	
	FAH (m)	1.5	1.4	1.3	-	1.5	1.5	1.4	-	1.5	1.4	1.3	-	1.5	1.5	1.4	-	
	min.	FAB (m)	0.45	0.45	0.45	-	0.45	0.45	0.45	-	0.45	0.45	0.45	-	0.45	0.45	0.45	-
		FAH (m)	0.83	0.83	0.83	-	0.83	0.83	0.83	-	0.83	0.83	0.83	-	0.83	0.83	0.83	-
	min.	FAB (m)	0.65	0.65	0.65	-	0.65	0.65	0.65	-	0.65	0.65	0.65	-	0.65	0.65	0.65	-
		FAH (m)	0.9	0.9	0.9	-	0.9	0.9	0.9	-	0.9	0.9	0.9	-	0.9	0.9	0.9	-
	max.(kg)	100								130***								

*** Zusätzliche Verklebung, Angaben in den Verarbeitungsrichtlinien beachten!
*** Additional gluing, pay attention to specifications in the workshop manual!

WICLINE 75 TOP

Verdeckte Beschläge
Concealed fittings



Zulässige Flügelgrößen Admissible sash sizes



		1017111				
		1017124				
	(Pa)	400	800	1200	-	
	(Pa)	150	300	450	-	
max.	FAB (m)	1.4	1.3	1.2	-	
	FAH (m)	1.7	1.7	1.6	-	
min.	FAB (m)	0.45	0.45	0.45	-	
	FAH (m)	0.6	0.6	0.6	-	
MV / MB	FAB (m)	1.2	1.2	1.0	-	
	FAH (m)	1.4	1.3	1.2	-	
	min.	FAB (m)	-	-	-	-
		FAH (m)	-	-	-	-
	min.	FAB (m)	-	-	-	-
		FAH (m)	-	-	-	-
	max.(kg)	100				

		1017111				
		1017124				
	(Pa)	400	800	1200	-	
	(Pa)	150	300	450	-	
max.	FAB (m)	1.4	1.3	1.1	-	
	FAH (m)	1.9	1.9	1.9	-	
min.	FAB (m)	0.45	0.45	0.45	-	
	FAH (m)	0.6	0.6	0.6	-	
MV / MB	FAB (m)	1.2	1.2	1.0	-	
	FAH (m)	1.4	1.3	1.2	-	
	min.	FAB (m)	-	-	-	-
		FAH (m)	-	-	-	-
	min.	FAB (m)	-	-	-	-
		FAH (m)	-	-	-	-
	max.(kg)	130***				

*** Zusätzliche Verklebung, Angaben in den Verarbeitungsrichtlinien beachten!
*** Additional gluing, pay attention to specifications in the workshop manual!

WICLINE 75 TOP

Verdeckte Beschläge
Concealed fittings



Zulässige Flügelgrößen Admissible sash sizes



		1017112				
		1017125				
	(Pa)	400	800	1200	-	
	(Pa)	150	300	450	-	
max.	FAB (m)	1.4	1.3	1.2	-	
	FAH (m)	1.7	1.7	1.6	-	
min.	FAB (m)	0.45	0.45	0.45	-	
	FAH (m)	0.6	0.6	0.6	-	
MV / MB	FAB (m)	1.2	1.2	1.0	-	
	FAH (m)	1.4	1.3	1.2	-	
	min.	FAB (m)	-	-	-	-
		FAH (m)	-	-	-	-
	min.	FAB (m)	-	-	-	-
		FAH (m)	-	-	-	-
	max.(kg)	100				

		1017112				
		1017125				
	(Pa)	400	800	1200	-	
	(Pa)	150	300	450	-	
max.	FAB (m)	1.4	1.3	1.1	-	
	FAH (m)	1.9	1.9	1.9	-	
min.	FAB (m)	0.45	0.45	0.45	-	
	FAH (m)	0.6	0.6	0.6	-	
MV / MB	FAB (m)	1.2	1.2	1.0	-	
	FAH (m)	1.4	1.3	1.2	-	
	min.	FAB (m)	-	-	-	-
		FAH (m)	-	-	-	-
	min.	FAB (m)	-	-	-	-
		FAH (m)	-	-	-	-
	max.(kg)	130***				

*** Zusätzliche Verklebung, Angaben in den Verarbeitungsrichtlinien beachten!
*** Additional gluing, pay attention to specifications in the workshop manual!

WICLINE 75 TOP

Verdeckte Beschläge
Concealed fittings



Zulässige Flügelgrößen Admissible sash sizes



		1017113				
		1017126				
	(Pa)	400	800	1200	-	
	(Pa)	150	300	450	-	
max.	FAB (m)	1.4	1.3	1.2	-	
	FAH (m)	1.7	1.7	1.6	-	
min.	FAB (m)	0.45	0.45	0.45	-	
	FAH (m)	0.6	0.6	0.6	-	
MV / MB	FAB (m)	1.2	1.2	1.0	-	
	FAH (m)	1.4	1.3	1.2	-	
	min.	FAB (m)	-	-	-	-
	FAH (m)	-	-	-	-	-
	min.	FAB (m)	-	-	-	-
	FAH (m)	-	-	-	-	-
	max.(kg)	100				

		1017113				
		1017126				
	(Pa)	400	800	1200	-	
	(Pa)	150	300	450	-	
max.	FAB (m)	1.4	1.2	1.1	-	
	FAH (m)	2.0	2.0	2.0	-	
min.	FAB (m)	0.45	0.45	0.45	-	
	FAH (m)	0.6	0.6	0.6	-	
MV / MB	FAB (m)	1.2	-	1.0	-	
	FAH (m)	1.4	1.3	1.2	-	
	min.	FAB (m)	-	-	-	-
	FAH (m)	-	-	-	-	-
	min.	FAB (m)	-	-	-	-
	FAH (m)	-	-	-	-	-
	max.(kg)	130***				

*** Zusätzliche Verklebung, Angaben in den Verarbeitungsrichtlinien beachten!
*** Additional gluing, pay attention to specifications in the workshop manual!

WICLINE 75 TOP

Verdeckte Beschläge
Concealed fittings



Zulässige Flügelgrößen
Admissible sash sizes



Profile Profiles		1017111				1017113				1017111				1017113				
	(Pa)	800	1200	2000	-	800	1200	2000	-	800	1200	2000	-	800	1200	2000	-	
	(Pa)	150	300	600	-	150	300	600	-	150	300	600	-	150	300	600	-	
Flügelgröße Sash size	max.	FAB (m)	1.4	1.3	1.2	-	1.4	1.4	1.3	-	1.4	1.3	1.2	-	1.4	1.4	1.3	-
		FAH (m)	1.7	1.7	1.7	-	1.8	1.8	1.8	-	1.8	2.0	2.1	-	2.0	2.0	2.25	-
	min.	FAB (m)	0.425	0.425	0.425	-	0.425	0.425	0.425	-	0.425	0.425	0.425	-	0.425	0.425	0.425	-
		FAH (m)	0.7	0.7	0.7	-	0.7	0.7	0.7	-	0.7	0.7	0.7	-	0.7	0.7	0.7	-
MV / MB	FAB (m)	-	-	-	-	-	-	-	-	-	-	-	-	-	-	1.2	-	
	FAH (m)	1.5	1.4	1.3	-	1.5	1.5	1.4	-	1.5	1.4	1.3	-	1.5	1.5	1.4	-	
	min.	FAB (m)	0.425	0.425	0.425	-	0.425	0.425	0.425	-	0.425	0.425	0.425	-	0.425	0.425	0.425	-
		FAH (m)	0.7	0.7	0.7	-	0.7	0.7	0.7	-	0.7	0.7	0.7	-	0.7	0.7	0.7	-
	min.	FAB (m)	0.68	0.68	0.68	-	0.68	0.68	0.68	-	0.68	0.68	0.68	-	0.68	0.68	0.68	-
		FAH (m)	0.9	0.9	0.9	-	0.9	0.9	0.9	-	0.9	0.9	0.9	-	0.9	0.9	0.9	-
	max.(kg)	100								130***								

*** Zusätzliche Verklebung, Angaben in den Verarbeitungsrichtlinien beachten!
*** Additional gluing, pay attention to specifications in the workshop manual!

WICLINE 75 TOP

Verdeckte Beschläge
Concealed fittings



Zulässige Flügelgrößen
Admissible sash sizes



Profile Profiles		1017111				1017113				1017111				1017113				
	(Pa)	800	1200	2000	-	800	1200	2000	-	800	1200	2000	-	800	1200	2000	-	
	(Pa)	150	300	600	-	150	300	600	-	150	300	600	-	150	300	600	-	
Flügelgröße Sash size	max.	FAB (m)	1.7	1.7	1.7	-	1.8	1.8	1.8	-	1.8	2.0	2.1	-	2.0	2.0	2.25	-
		FAH (m)	1.4	1.3	1.2	-	1.4	1.4	1.3	-	1.4	1.3	1.2	-	1.4	1.4	1.3	-
	min.	FAB (m)	0.6	0.6	0.6	-	0.6	0.6	0.6	-	0.6	0.6	0.6	-	0.6	0.6	0.6	-
		FAH (m)	0.45	0.45	0.45	-	0.45	0.45	0.45	-	0.45	0.45	0.45	-	0.45	0.45	0.45	-
MV / MB	FAB (m)	1.5	1.4	1.3	-	1.5	1.5	1.4	-	1.5	1.4	1.3	-	1.5	1.5	1.4	-	
	FAH (m)	-	-	-	-	-	-	-	-	-	-	-	-	-	-	1.2	-	
	min.	FAB (m)	0.74	0.74	0.74	-	0.74	0.74	0.74	-	0.74	0.74	0.74	-	0.74	0.74	0.74	-
		FAH (m)	0.45	0.45	0.45	-	0.45	0.45	0.45	-	0.45	0.45	0.45	-	0.45	0.45	0.45	-
	min.	FAB (m)	0.9	0.9	0.9	-	0.9	0.9	0.9	-	0.9	0.9	0.9	-	0.9	0.9	0.9	-
		FAH (m)	0.6	0.6	0.6	-	0.6	0.6	0.6	-	0.6	0.6	0.6	-	0.6	0.6	0.6	-
	max.(kg)	100								130***								

*** Zusätzliche Verklebung, Angaben in den Verarbeitungsrichtlinien beachten!
*** Additional gluing, pay attention to specifications in the workshop manual!

WICLINE 75 TOP

Verdeckte Beschläge
Concealed fittings



Zulässige Flügelgrößen
Admissible sash sizes



Profile Profiles		1017111				1017113				1017111				1017113				
		1017112								1017112								
	(Pa)	800	1200	2000	-	800	1200	2000	-	800	1200	2000	-	800	1200	2000	-	
	(Pa)	150	300	600	-	150	300	600	-	150	300	600	-	150	300	600	-	
Flügelgröße Sash size	max.	FAB (m)	1.7	1.7	1.7	-	1.8	1.8	1.8	-	1.8	2.0	2.1	-	2.0	2.0	2.25	-
		FAH (m)	1.4	1.3	1.2	-	1.4	1.4	1.3	-	1.4	1.3	1.2	-	1.4	1.4	1.3	-
	min.	FAB (m)	0.55	0.55	0.55	-	0.55	0.55	0.55	-	0.55	0.55	0.55	-	0.55	0.55	0.55	-
		FAH (m)	0.51	0.51	0.51	-	0.51	0.51	0.51	-	0.51	0.51	0.51	-	0.51	0.51	0.51	-
MV / MB	FAB (m)	1.5	1.4	1.3	-	1.5	1.5	1.4	-	1.5	1.4	1.3	-	1.5	1.5	1.4	-	
	FAH (m)	-	-	-	-	-	-	-	-	-	-	-	-	-	-	1.2	-	
	min.	FAB (m)	-	-	-	-	-	-	-	-	-	-	-	-	-	-	-	-
		FAH (m)	-	-	-	-	-	-	-	-	-	-	-	-	-	-	-	-
	min.	FAB (m)	-	-	-	-	-	-	-	-	-	-	-	-	-	-	-	-
		FAH (m)	-	-	-	-	-	-	-	-	-	-	-	-	-	-	-	-
	max.(kg)	80								120***								

*** Zusätzliche Verklebung, Angaben in den Verarbeitungsrichtlinien beachten!
*** Additional gluing, pay attention to specifications in the workshop manual!

WICLINE

Beschläge
Fittings

Zulässige Formatgrößen, verdeckte Beschläge
Admissible format sizes, concealed fittings

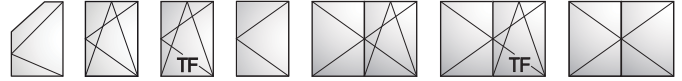

WICSTAR

Flügelgewicht max. 160 kg
Sash weight max. 160 kg

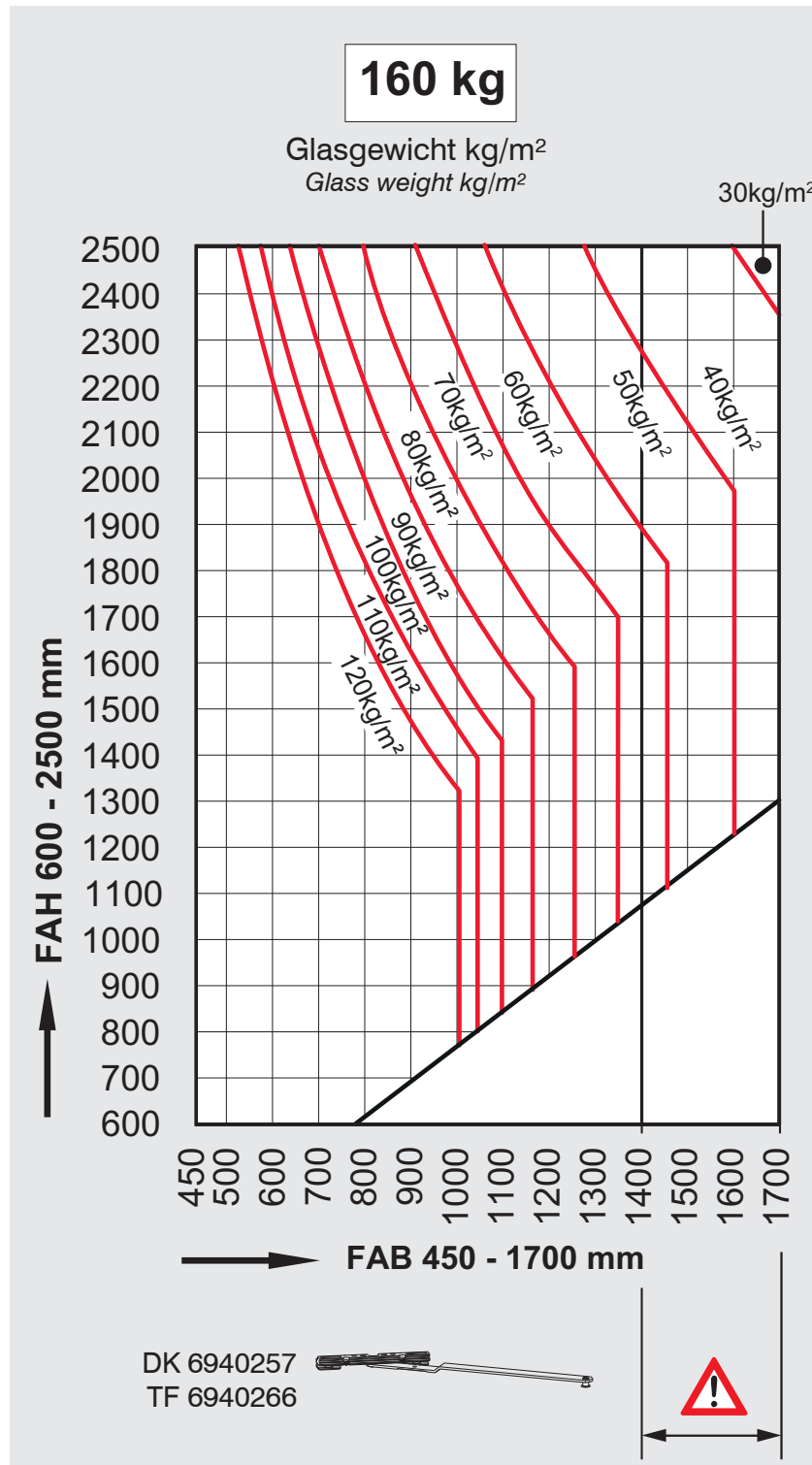

WICLINE

Zulässige Formatgrößen, verdeckte Beschläge
Admissible format sizes, concealed fittings

WICSTAR

Flügelgewicht max. 130 kg
Sash weight max. 130 kg

Beschläge
Fittings

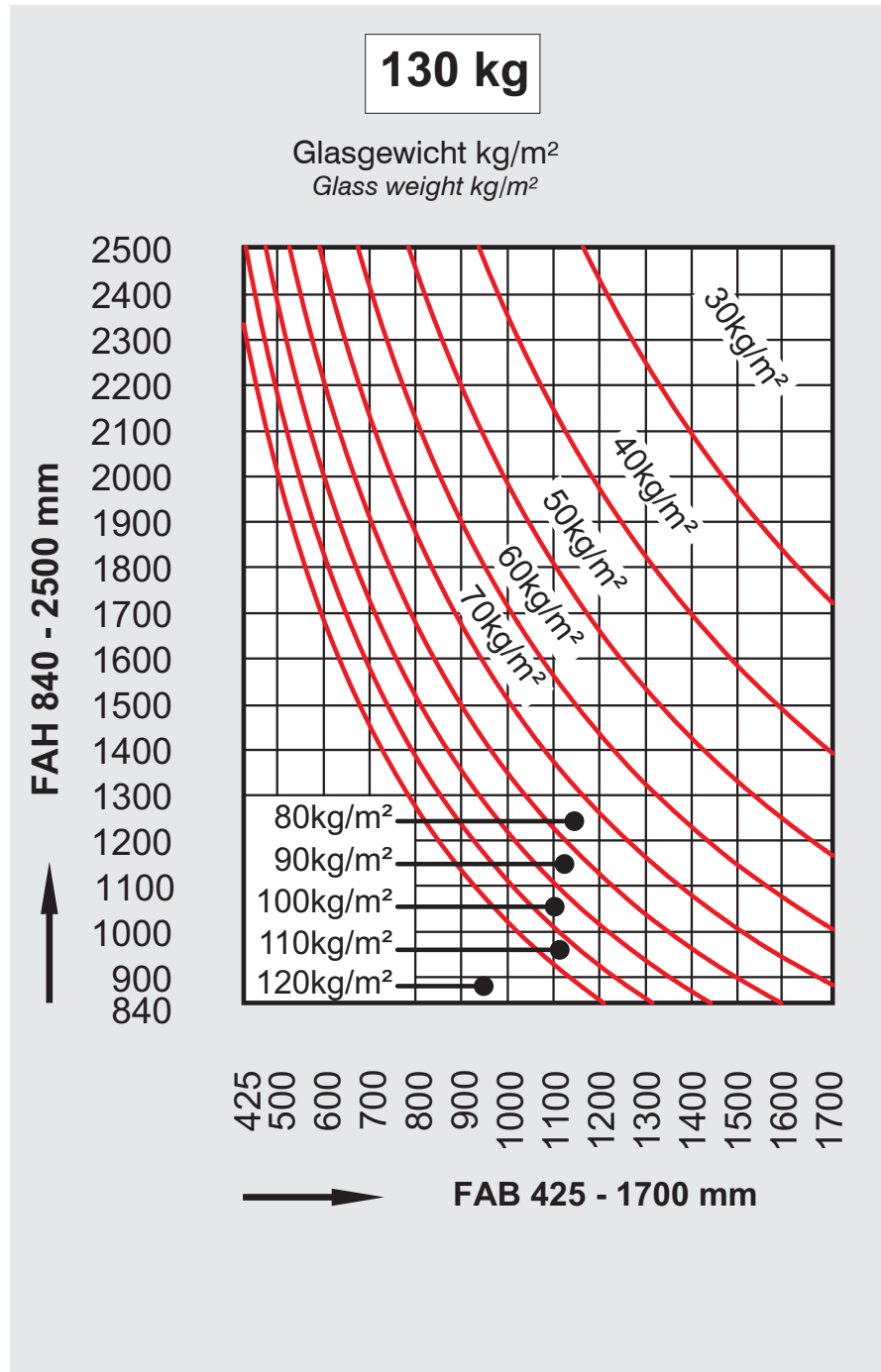

Zulässige Formatgrößen, verdeckte Beschläge
Admissible format sizes, concealed fittings



WICSTAR

Flügelgewicht max. 130 kg
Sash weight max. 130 kg



130 kg

Glasgewicht kg/m²
Glass weight kg/m²

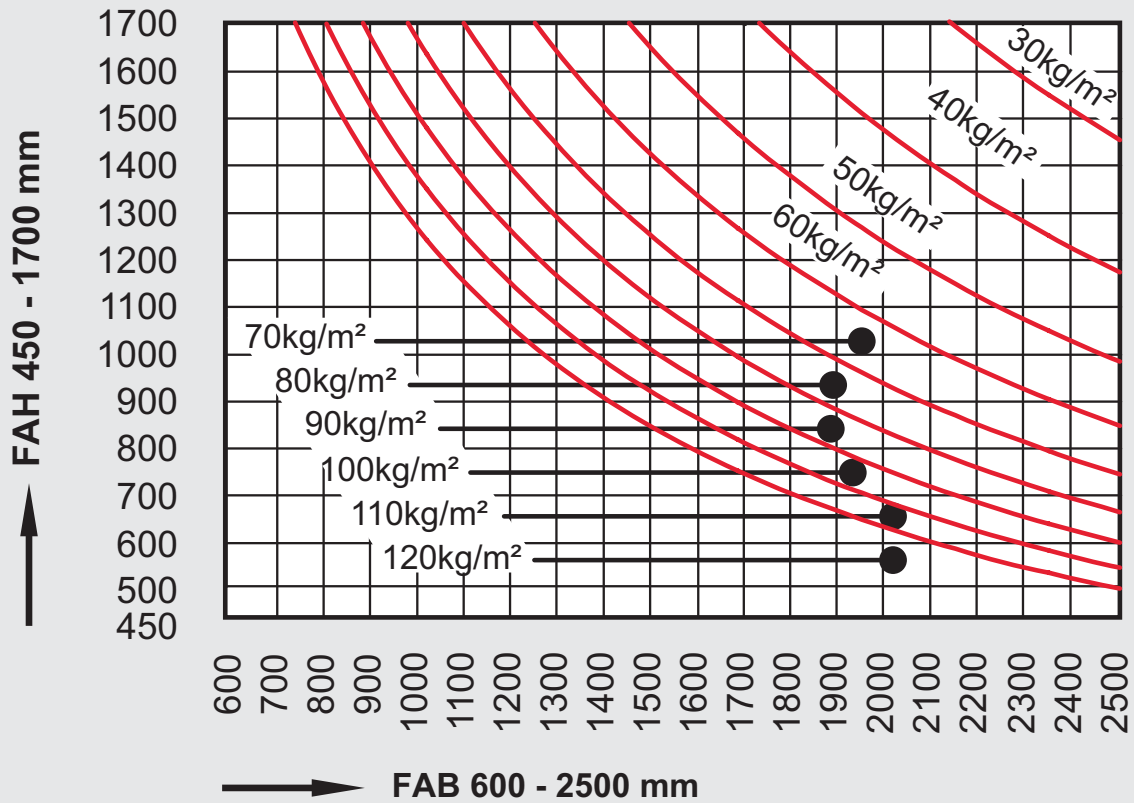

Zulässige Formatgrößen, aufliegende und verdeckte Beschläge
Admissible format sizes, top mounted and concealed fittings



WICSTAR

Flügelgewicht max. 80 kg
Sash weight max. 80 kg

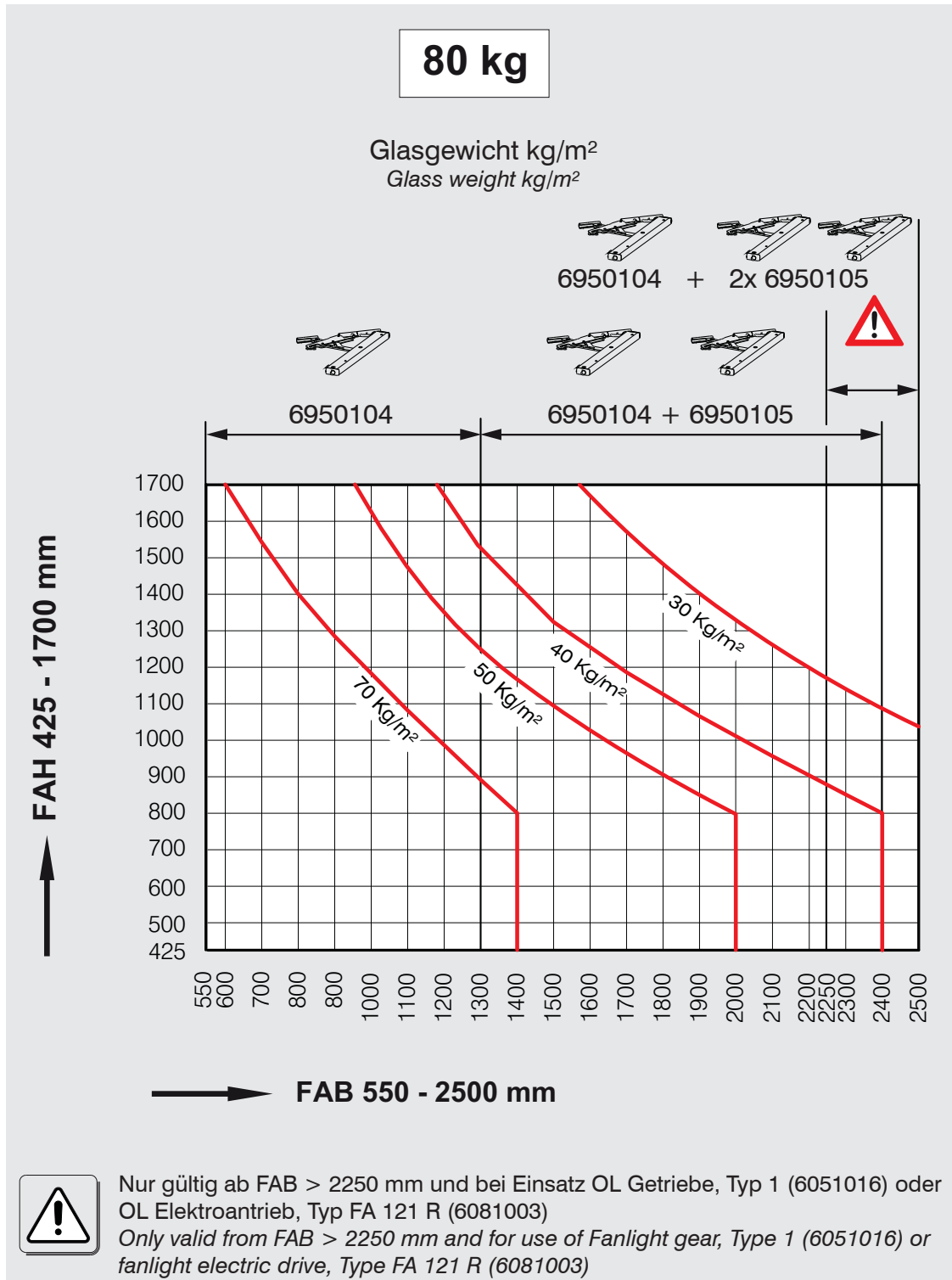

Zulässige Formatgrößen, aufliegende und verdeckte Beschläge
Admissible format sizes, top mounted and concealed fittings



WICSTAR

Flügelgewicht max. 120 kg mit Spindelgetriebe
Sash weight max. 120 kg with spindle gear

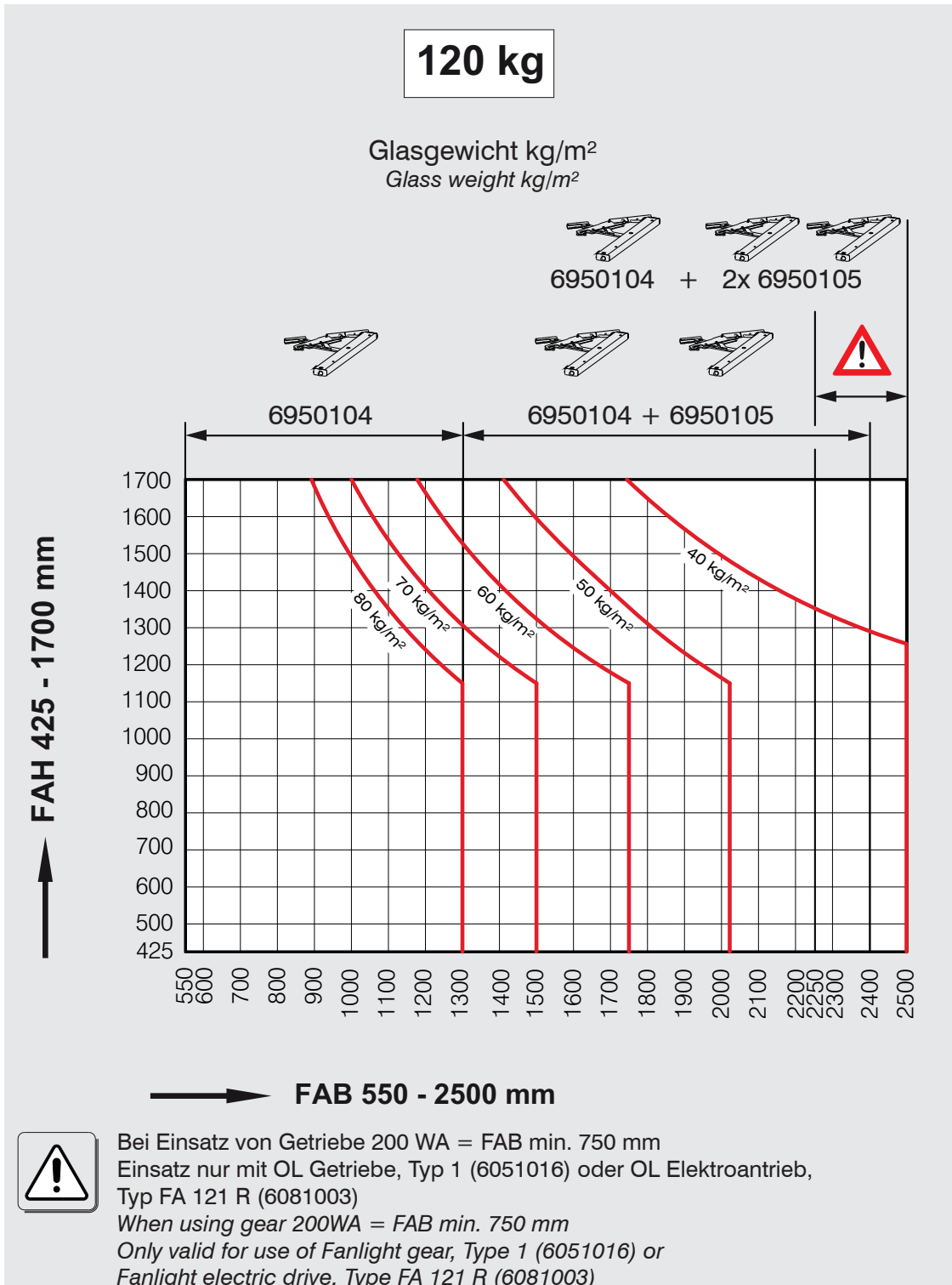

Zulässige Formatgrößen, aufliegende und verdeckte Beschläge
Admissible format sizes, top mounted and concealed fittings



WICSTAR

Flügelgewicht max. 120 kg mit Elektroantrieb
Sash weight max. 120 kg with electric drive

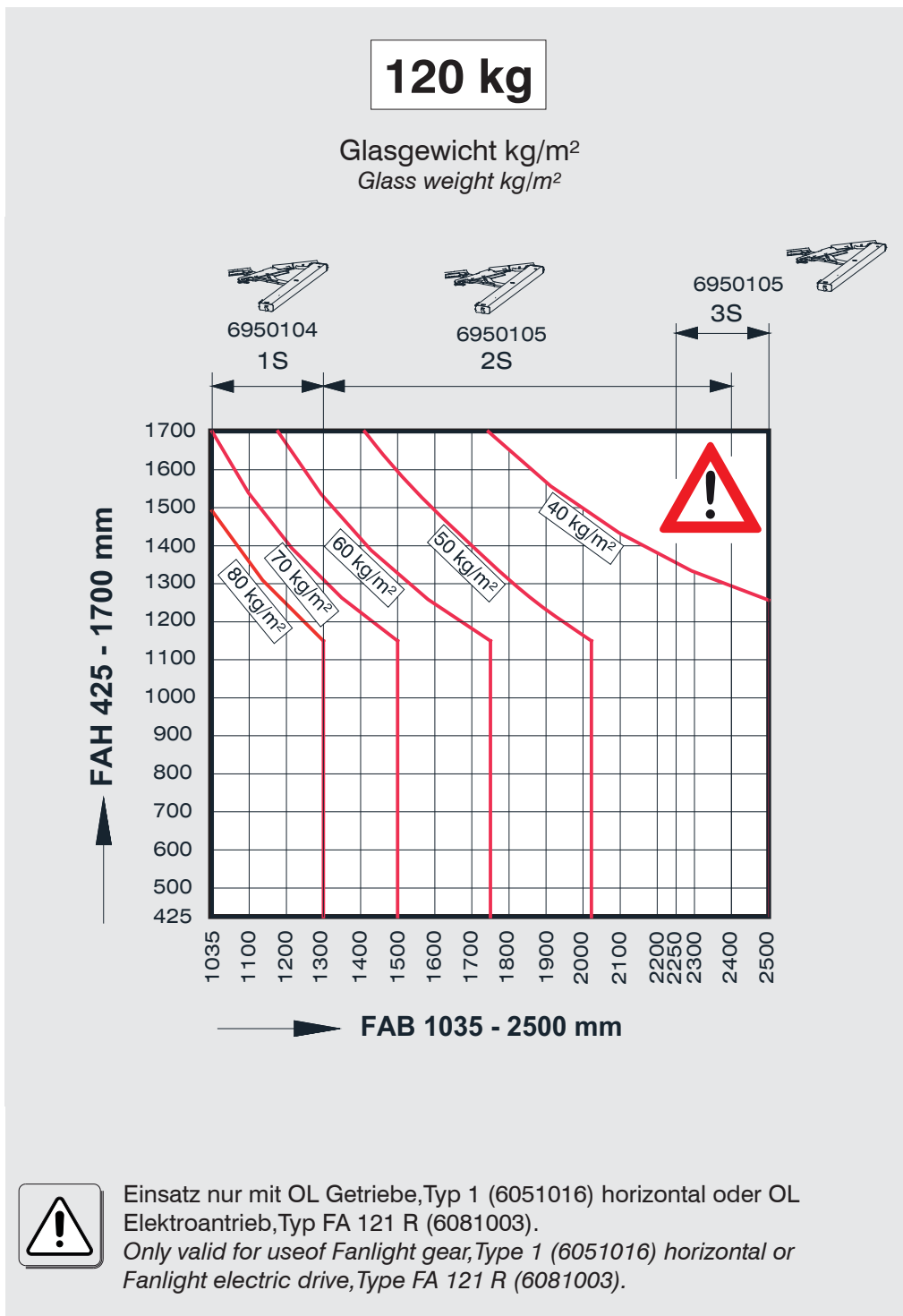

Zulässige Formatgrößen, aufliegende und verdeckte Beschläge
Admissible format sizes, top mounted and concealed fittings



WICSTAR

Flügelgewicht max. 80 kg
Einbruchhemmung RC 1N / RC 2N / RC 2
Sash weight max. 80 kg
Burglar resistance RC 1N / RC 2N / RC 2

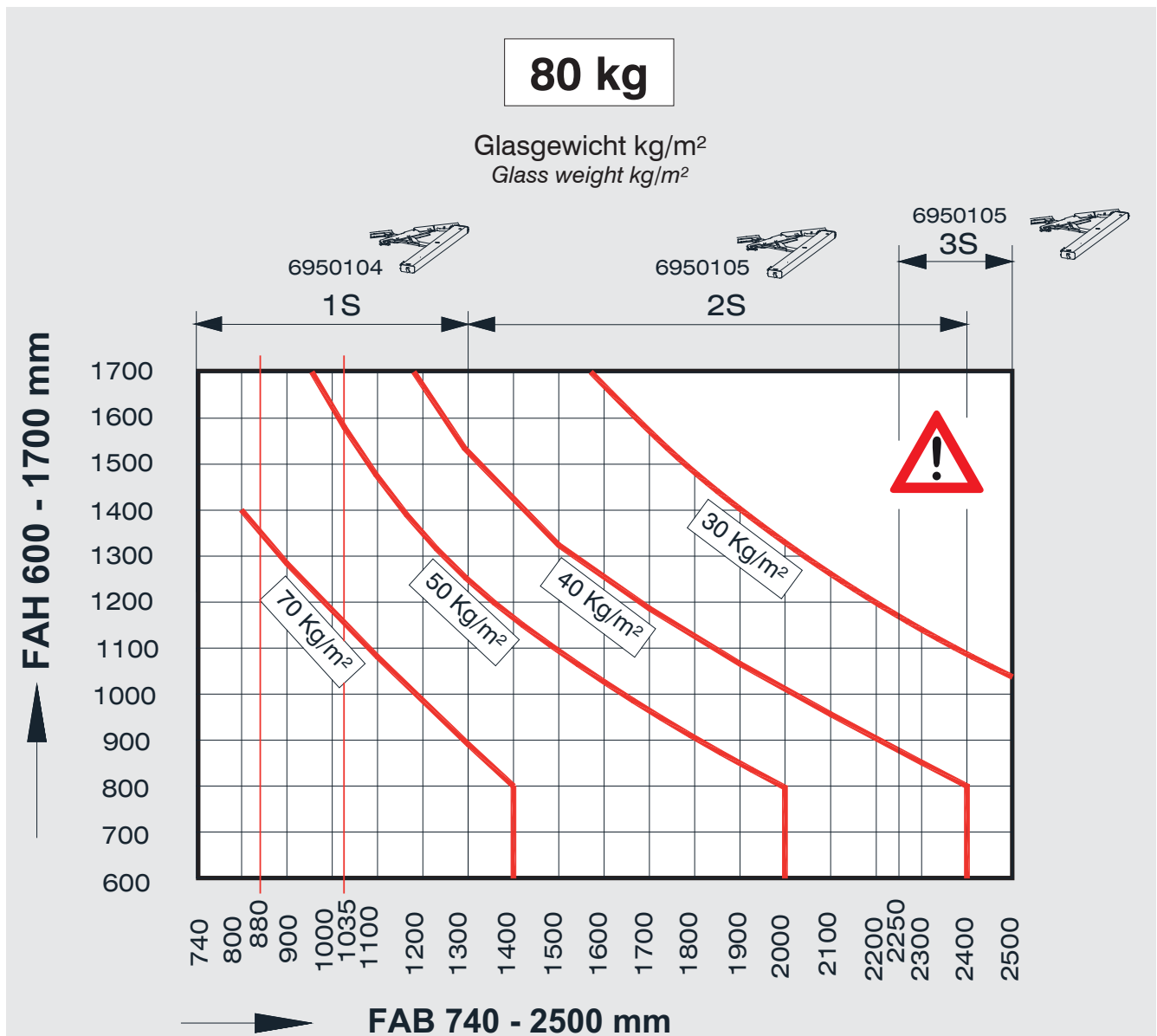

Bei Einsatz von Getriebe 200WA = FAB min. 880 mm; bei Elektroantrieb = FAB min. 1035 mm.
When using gear 200WA = FAB min. 880 mm; with electric drive = FAB min. 1035 mm.

Nur gültig ab FAB > 2250 mm und bei Einsatz OL Getriebe, Typ 1 (6051016) oder OL Elektroantrieb, Typ FA 121 R (6081003).

Flügelgewichte > 80kg nur in Verbindung mit Beschlageinbauplan 45401 (OL Getriebe, Typ 1) und 45601 (OL Elektroantrieb, Typ FA 121 R).

Only valid from FAB > 2250 mm and for use of fanlight gear, Type 1 (6051016) or fanlight electric drive, Type FA 121 R (6081003).

Sash weight > 80kg only in connection with fitting installation plan 45401 (fanlight gear, Type 1) and 45601 (fanlight electric drive, Type FA 121R).

Zulässige Formatgrößen, aufliegende und verdeckte Beschläge
Admissible format sizes, top mounted and concealed fittings



WICSTAR

Flügelgewicht max. 80 kg
Einbruchhemmung RC 3
Sash weight max. 80 kg
Burglar resistance RC 3

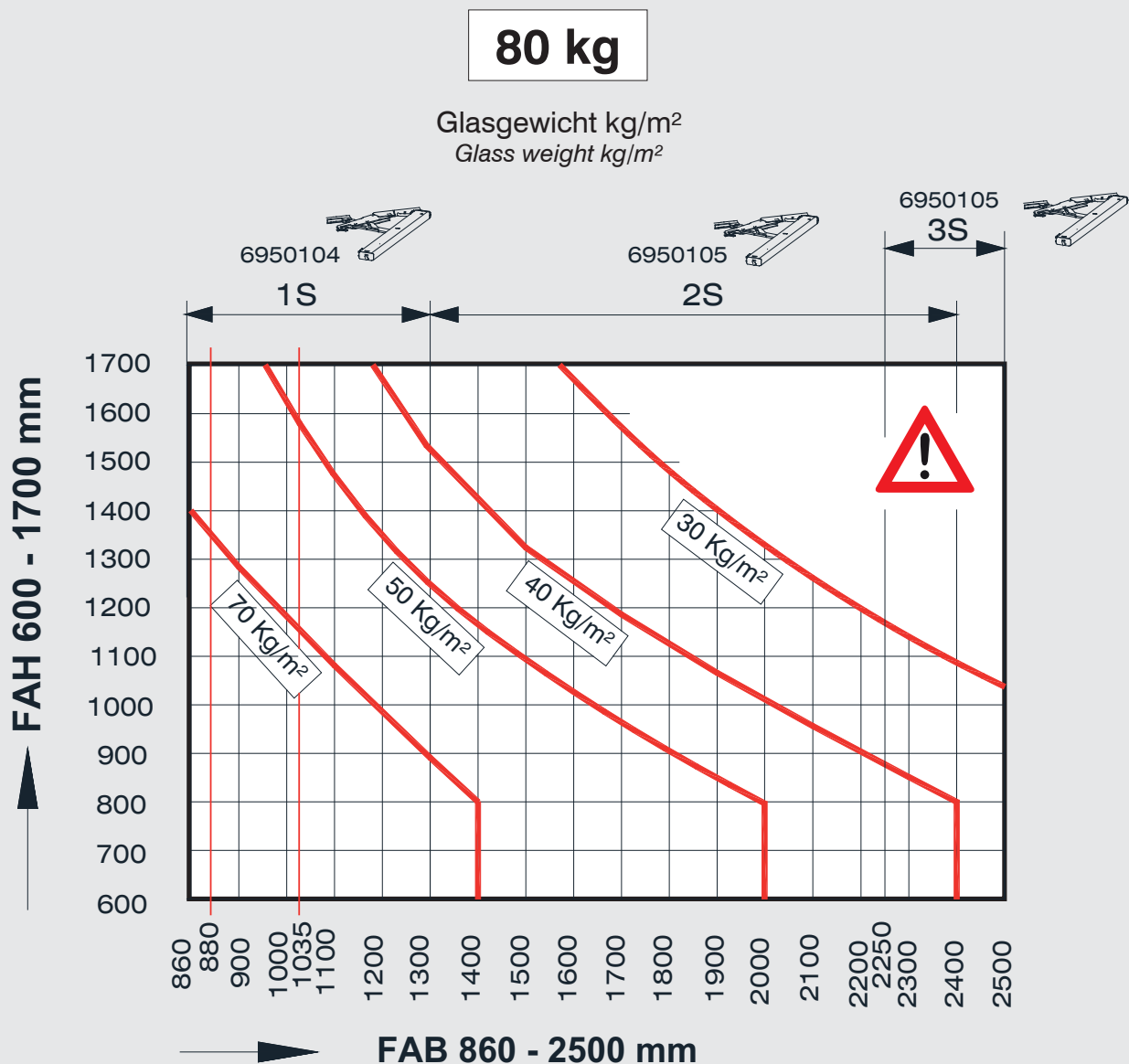

Bei Einsatz von Getriebe 200WA = FAB min. 880 mm; bei Elektroantrieb = FAB min. 1035 mm.
When using gear 200WA = FAB min. 880 mm; with electric drive = FAB min. 1035 mm.

Nur gültig ab FAB > 2250 mm und bei Einsatz OL Getriebe, Typ 1 (6051016) oder OL Elektroantrieb, Typ FA 121 R (6081003).

Flügelgewichte > 80kg nur in Verbindung mit Beschlageinbauplan 45401 (OL Getriebe, Typ 1) und 45601 (OL Elektroantrieb, Typ FA 121 R).

Only valid from FAB > 2250 mm and for use of fanlight gear, Type 1 (6051016) or fanlight electric drive, Type FA 121 R (6081003).

Sash weight > 80kg only in connection with fitting installation plan 45401 (fanlight gear, Type 1) and 45601 (fanlight electric drive, Type FA 121R).

Zulässige Formatgrößen, aufliegende und verdeckte Beschläge
Admissible format sizes, top mounted and concealed fittings



WICSTAR

Flügelgewicht max. 120 kg

Oberlicht-Schrägfenster

Sash weight max. 120 kg

Fanlight sloped window

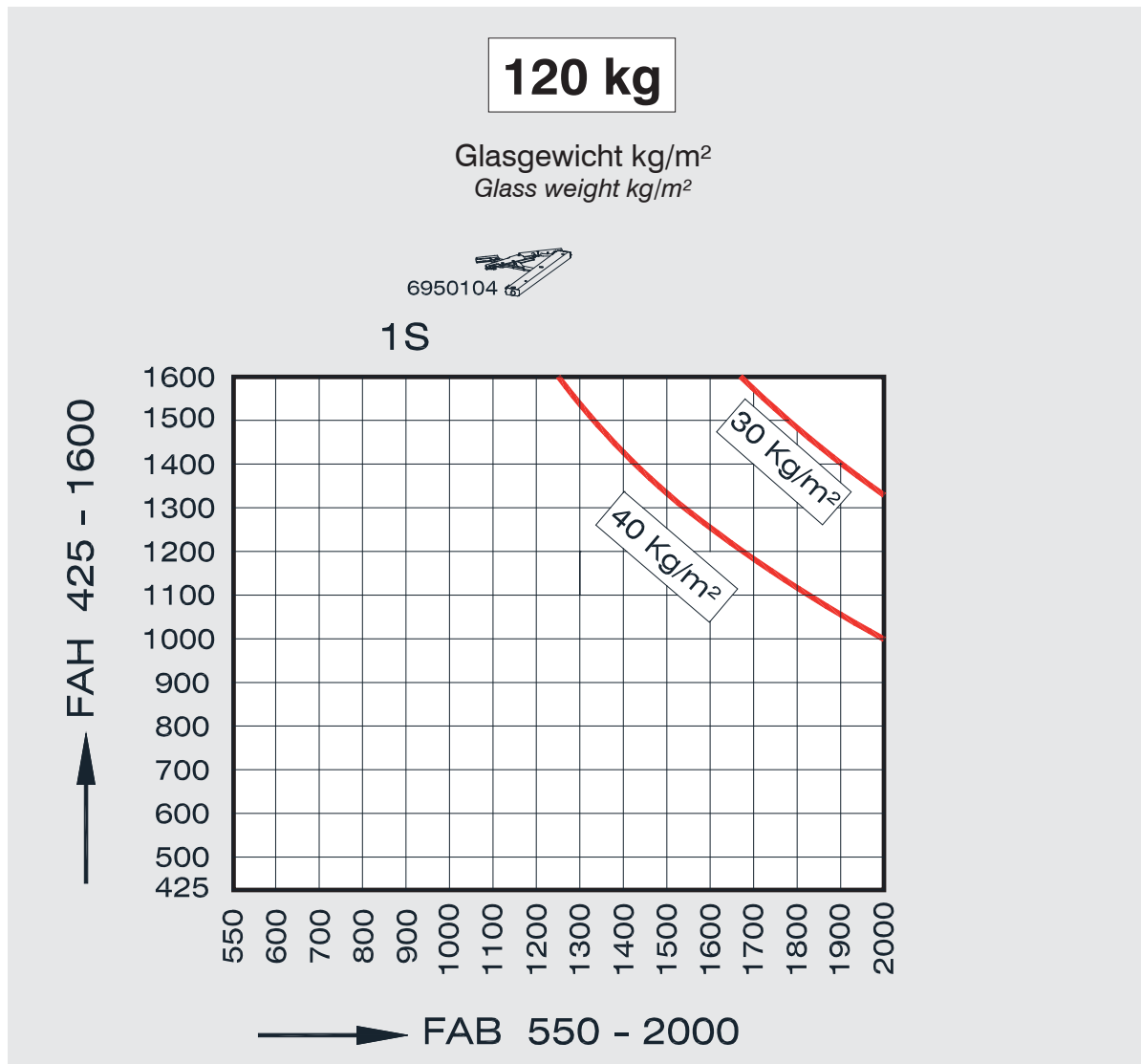

WICLINE 75 TOP

Grundbeschlag
Basic fitting



Beschläge
Fittings



Dreh-Kipp-Beschlag verdeckt
Turn/tilt fitting concealed

Griff Stellungen
Handle position

Kipp / tilted

Dreh / turned

Zu / closed

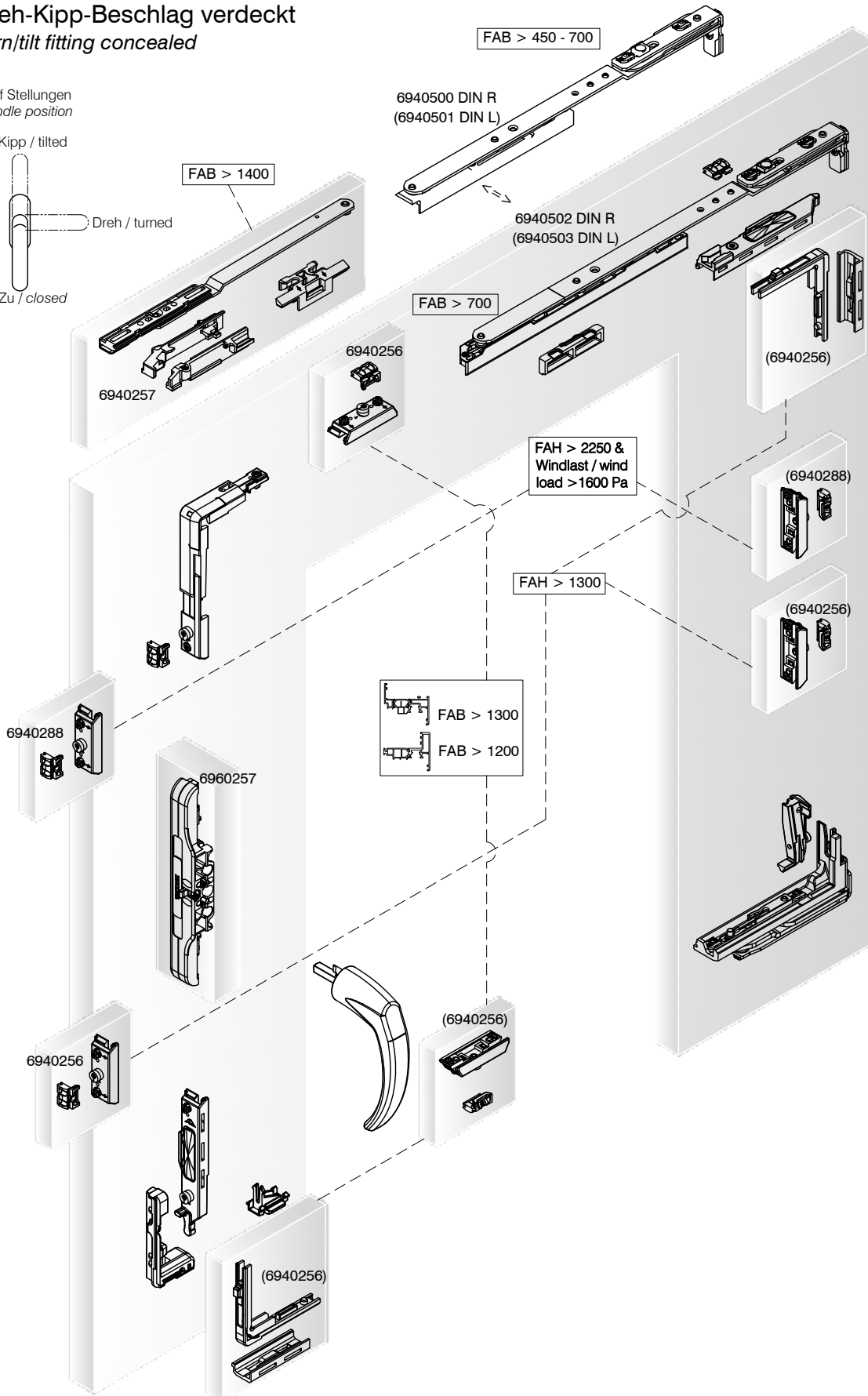

WICLINE 75 TOP

Grundbeschlag
Basic fitting



Beschläge
Fittings



Tilt-First-Beschlag verdeckt
Tilt-first fitting concealed

Griff Stellungen
Handle position

Dreh / turned



Kipp / tilted

Zu / closed

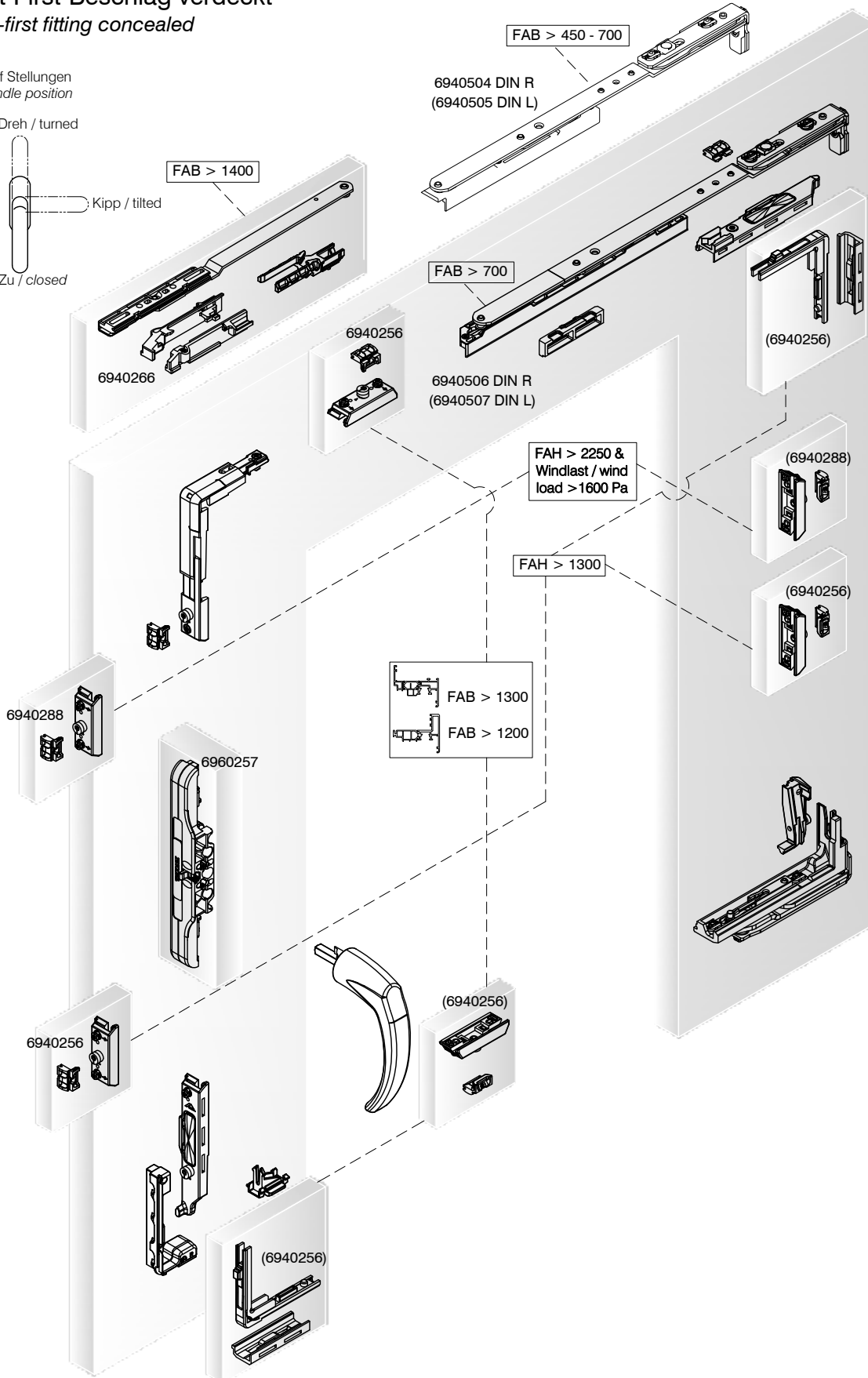

WICLINE 75 TOP

Grundbeschlag
Basic fitting



Beschläge
Fittings



Dreh-Beschlag verdeckt
Turn fitting concealed

Griff Stellungen
Handle position

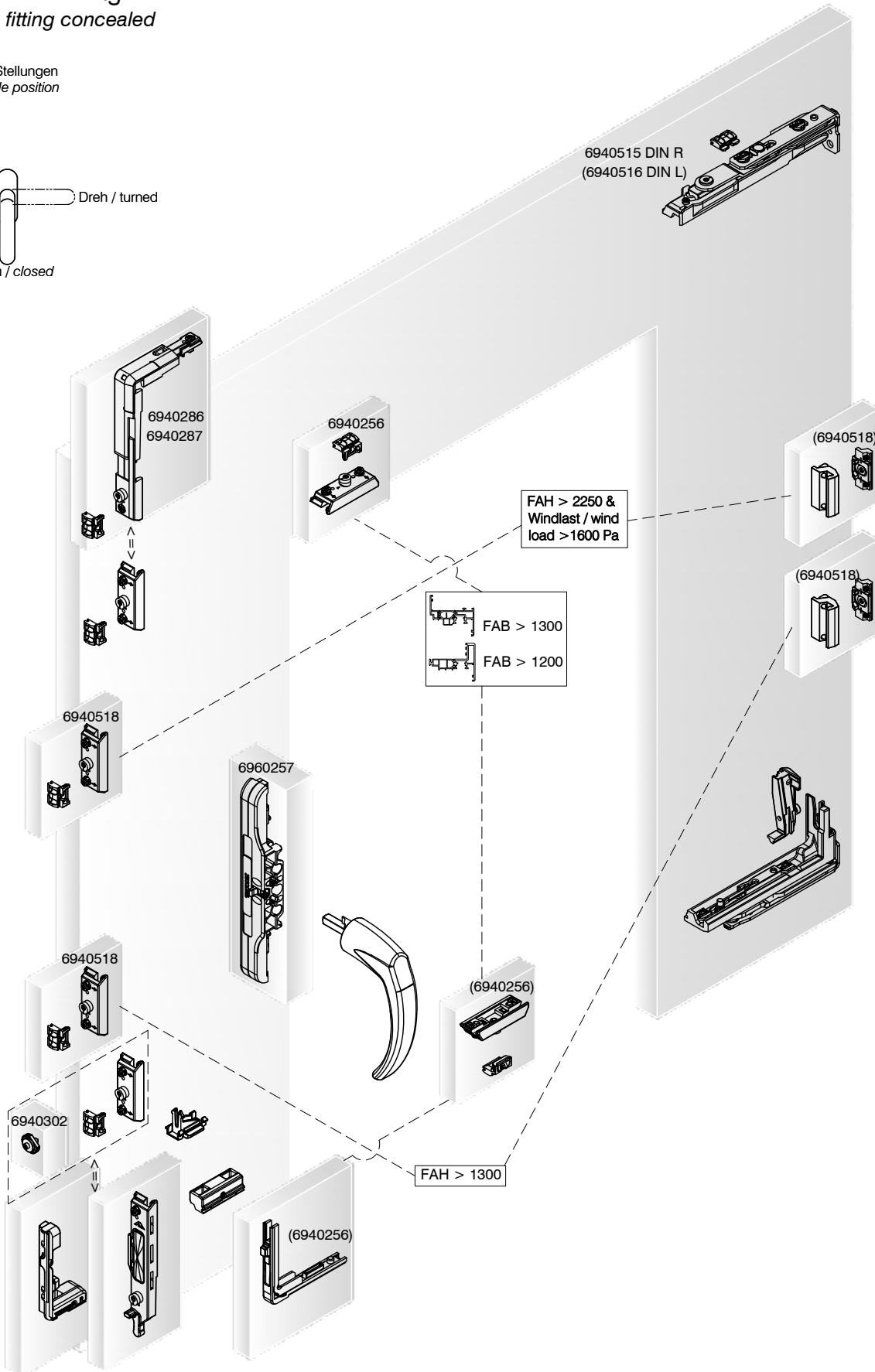
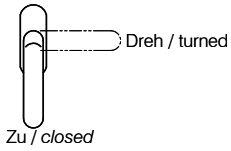

WICLINE 75 TOP

Grundbeschlag
Basic fitting



Beschläge Fittings

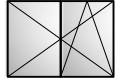

Stulp-Beschlag verdeckt 130 kg mit Kniehebel
Double casement door fitting concealed 130 kg with toggle lever

Kniehebel Stellungen
Toggle lever position



Offen / opened



Zu / closed

Standflügel DIN R
Inactive sash DIN R

Griff Stellungen
Handle position



Dreh / turned



Kipp / tilted

Zu / closed

Gehflügel DIN R
Active sash DIN R

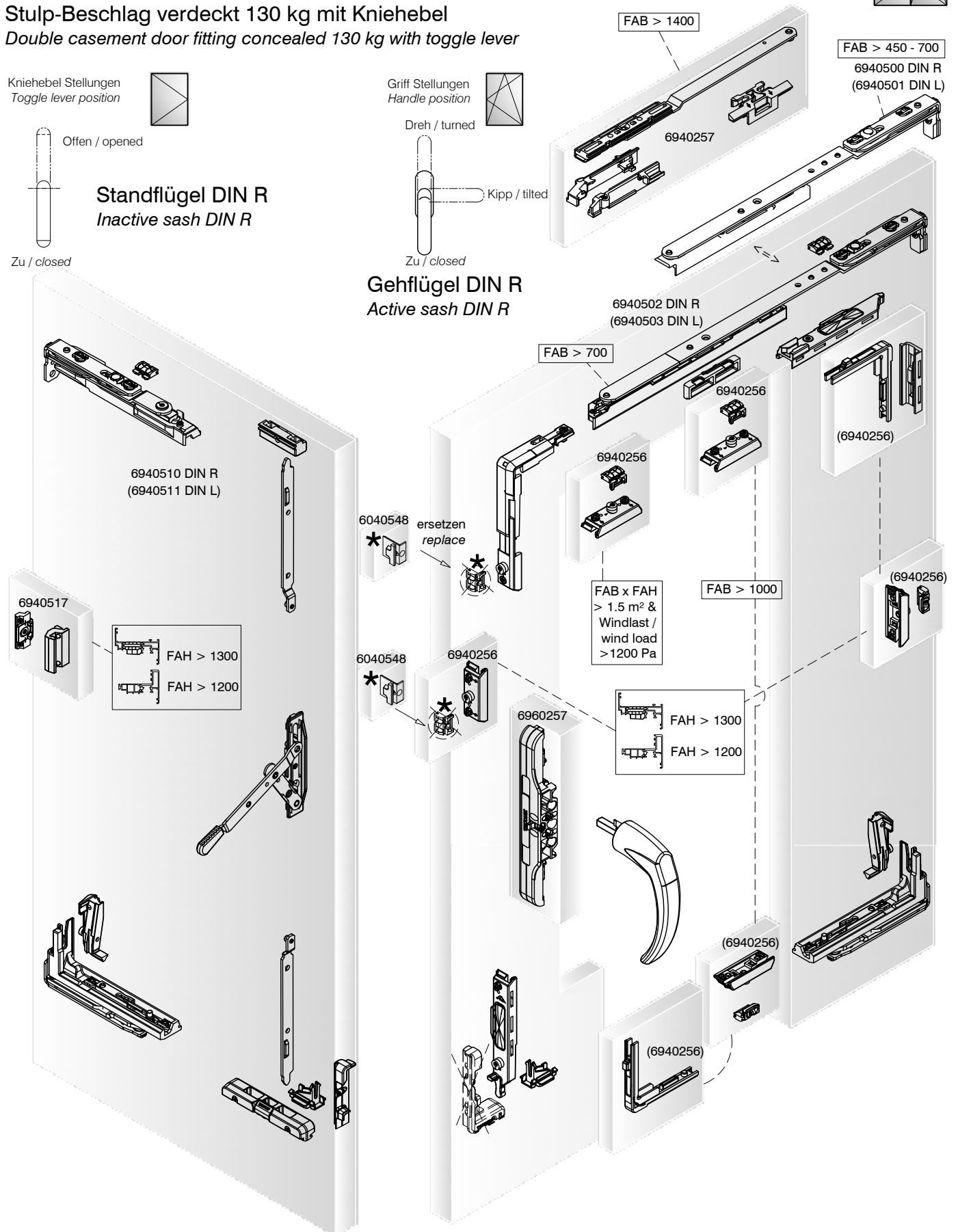

WICLINE 75 TOP

Grundbeschlag
Basic fitting



Beschläge Fittings



Stulp-Beschlag verdeckt 130 kg mit Kniehebel
Double casement door fitting concealed 130 kg with toggle lever

Kniehebel Stellungen
Toggle lever position



Offen / opened



Zu / closed

Standflügel DIN L
Inactive sash DIN L

Griff Stellungen
Handle position



Dreh / turned



Zu / closed

Kipp / tilted

Gehflügel DIN R
Active sash DIN R

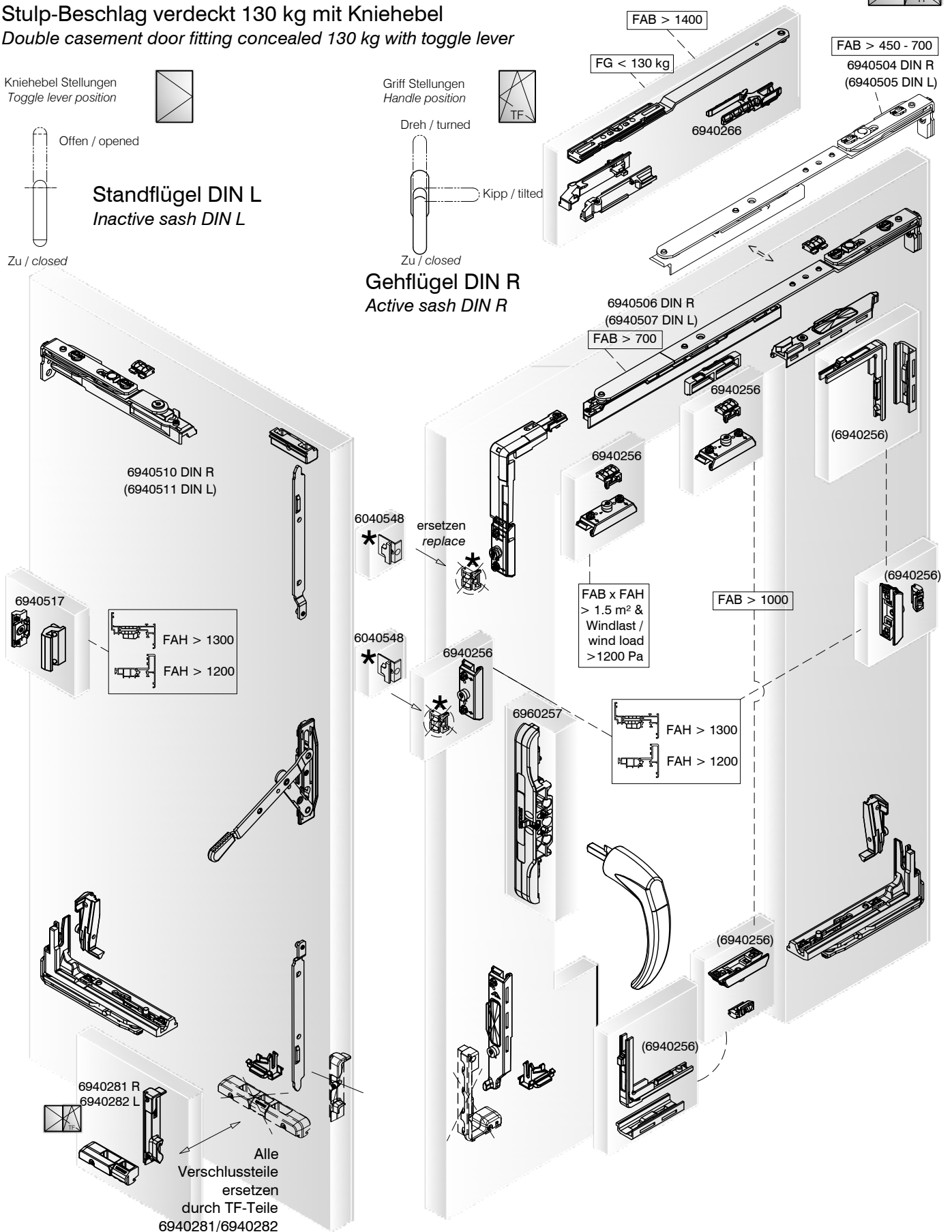

Alle Verschlusssteile ersetzen durch TF-Teile 6940281/6940282

WICLINE 75 TOP

Grundbeschlag
Basic fitting



Beschläge
Fittings

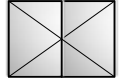

Stulp-Beschlag verdeckt 130 kg mit Kniehebel
Double casement door fitting concealed 130 kg with toggle lever

Kniehebel Stellungen
Toggle lever position

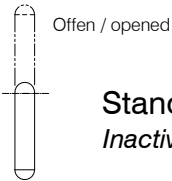

Standflügel DIN L
Inactive sash DIN L

Zu / closed

Griff Stellungen
Handle position

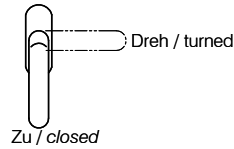

Gehflügel DIN R
Active sash DIN R

Zu / closed

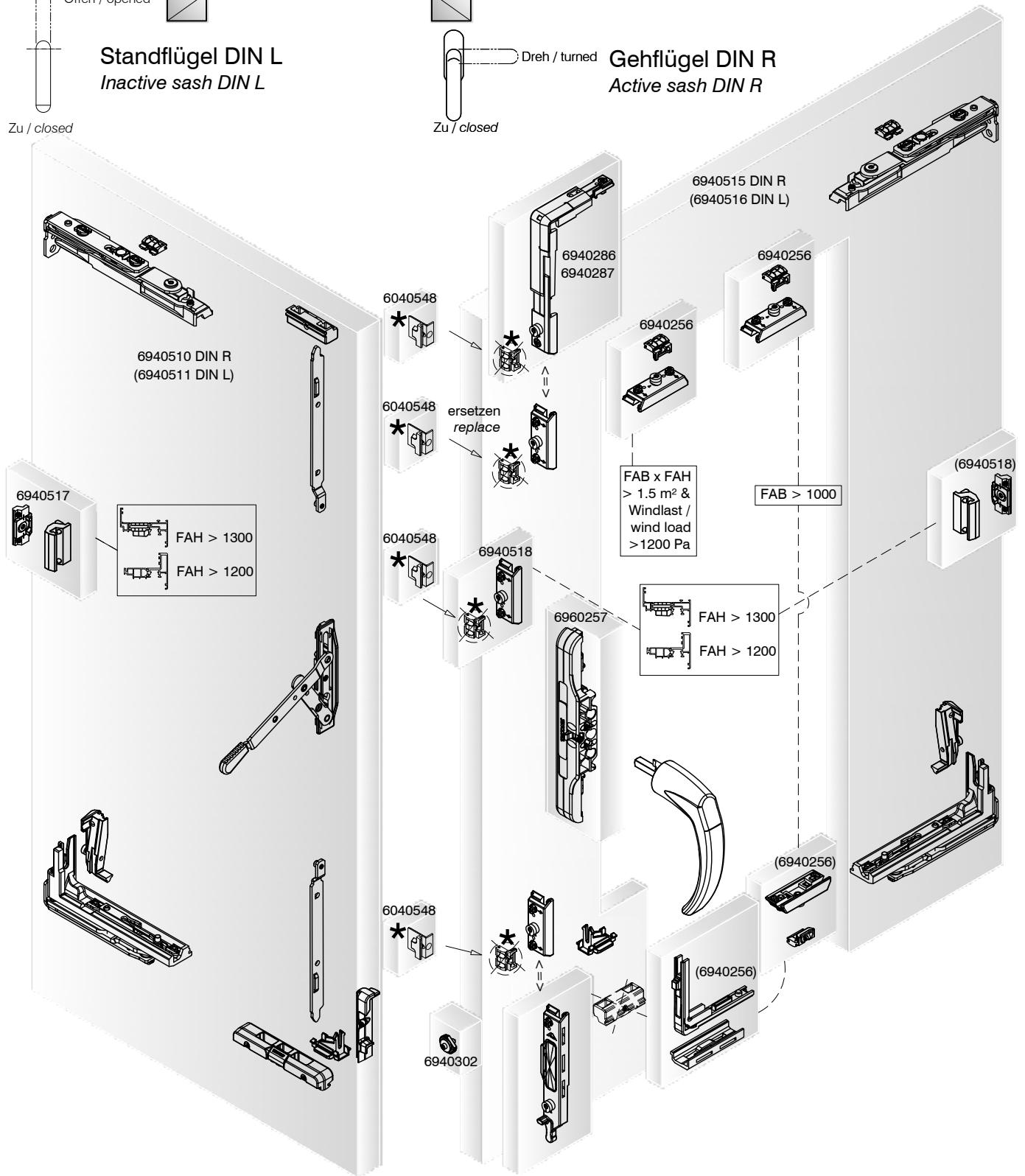



Stulp-Beschlag verdeckt 160 kg mit Stulpgetriebe Double casement door fitting concealed 160 kg with double casement gear

Stulpgetriebe Stellungen
Double casement gear
position

Zu / closed

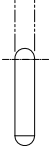

Standflügel DIN L
Inactive sash DIN L

Offen / opened

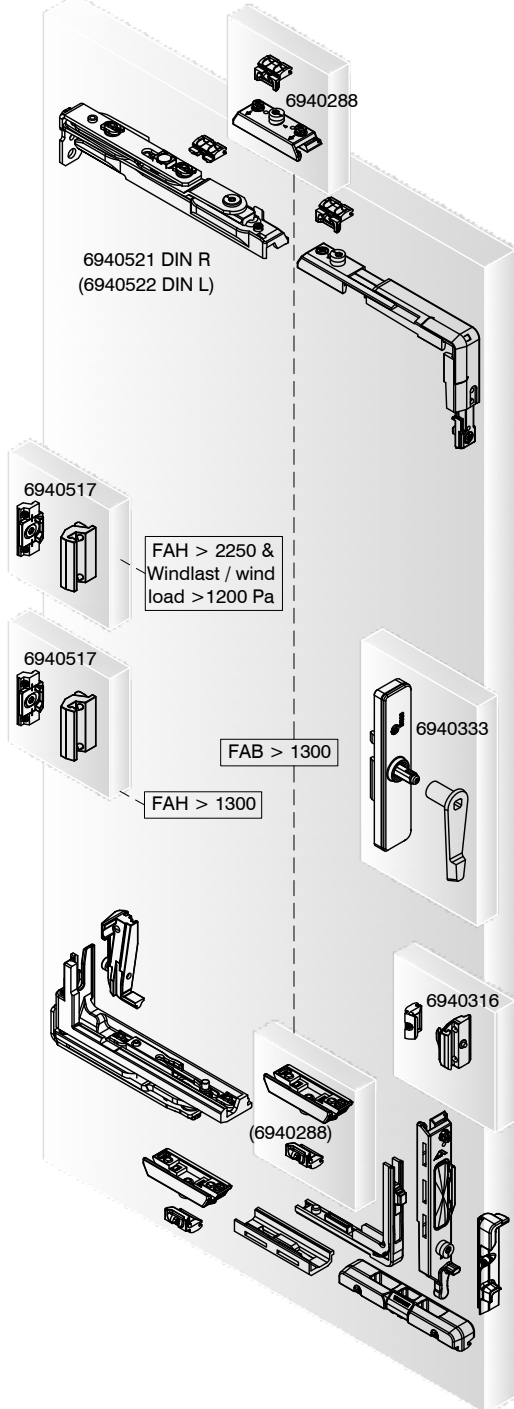

FAH > 2250 &
Windlast / wind
load > 1200 Pa

FAH > 1300

FAB > 1300

Griff Stellungen
Handle position



Dreh / turned



Kipp / tilted

Zu / closed

Gehflügel DIN R
Active sash DIN R

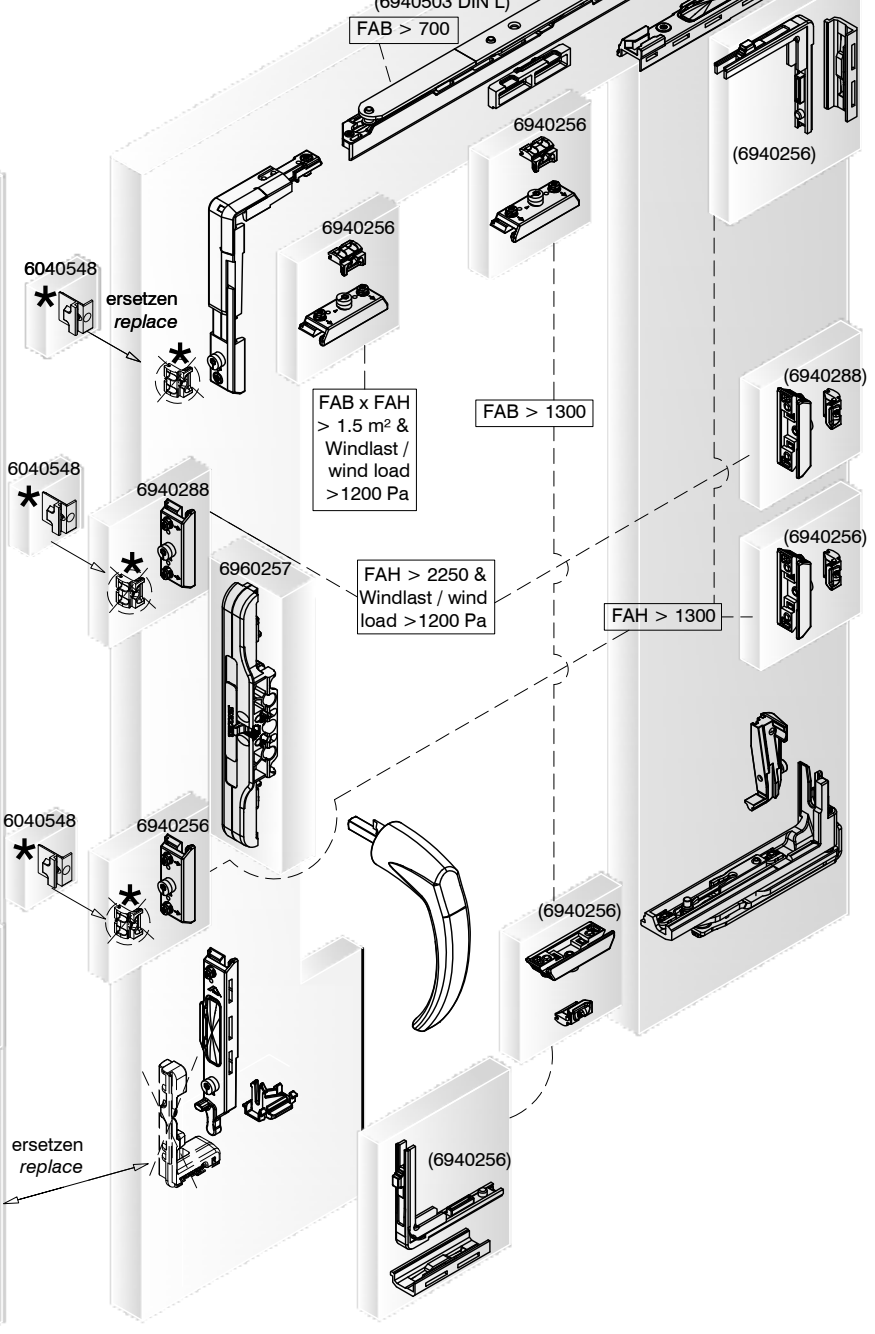

ersetzen
replace

6040548
*

6040548
*

ersetzen
replace

FG > 130 kg
6940337 R
(6940338 L)

FG < 130 kg

FAB > 1400

FAB > 450 - 700
6940500 DIN R
(6940501 DIN L)

6940502 DIN R
(6940503 DIN L)
FAB > 700

FAB > 1300

FAB x FAH
> 1.5 m² &
Windlast /
wind load
> 1200 Pa

FAH > 2250 &
Windlast / wind
load > 1200 Pa

FAH > 1300



Stulp-Beschlag verdeckt 160 kg mit Stulpgetriebe Double casement door fitting concealed 160 kg with double casement gear

Stulpgetriebe Stellungen
Double casement gear
position

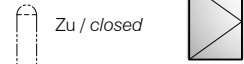

Standflügel DIN L
Inactive sash DIN L

Offen / opened

Griff Stellungen
Handle position



Gehflügel DIN R
Active sash DIN R

Zu / closed

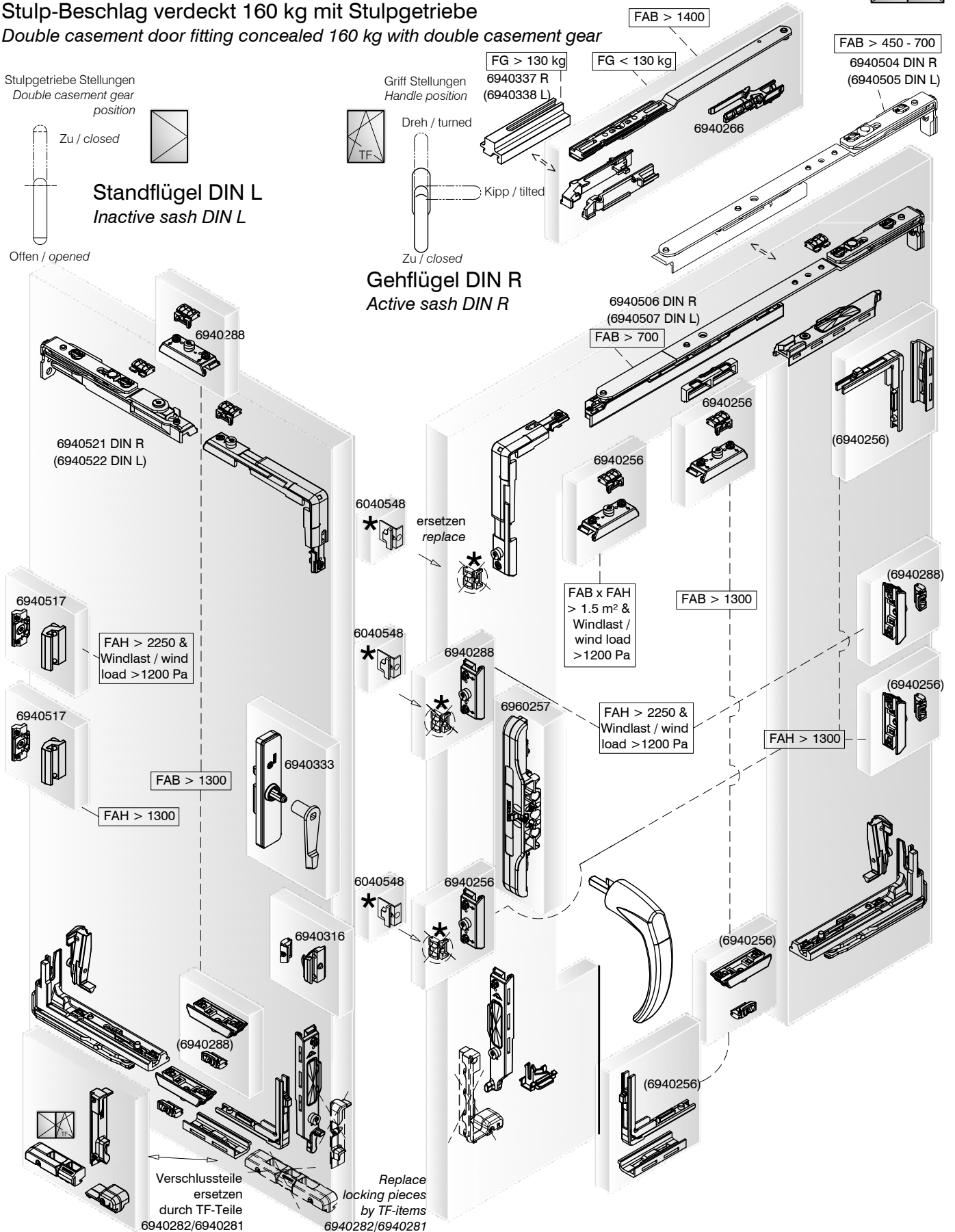
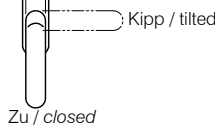

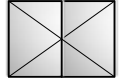

Stulp-Beschlag verdeckt 160 kg mit Stulpgetriebe Double casement door fitting concealed 160 kg with double casement gear

Stulpgetriebe Stellungen
Double casement gear
position



Griff Stellungen
Handle position



Gehflügel DIN R Active sash DIN R

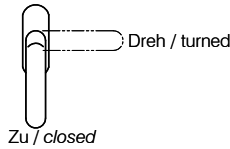

Zu / closed

Standflügel DIN L Inactive sash DIN L

Offen / opened

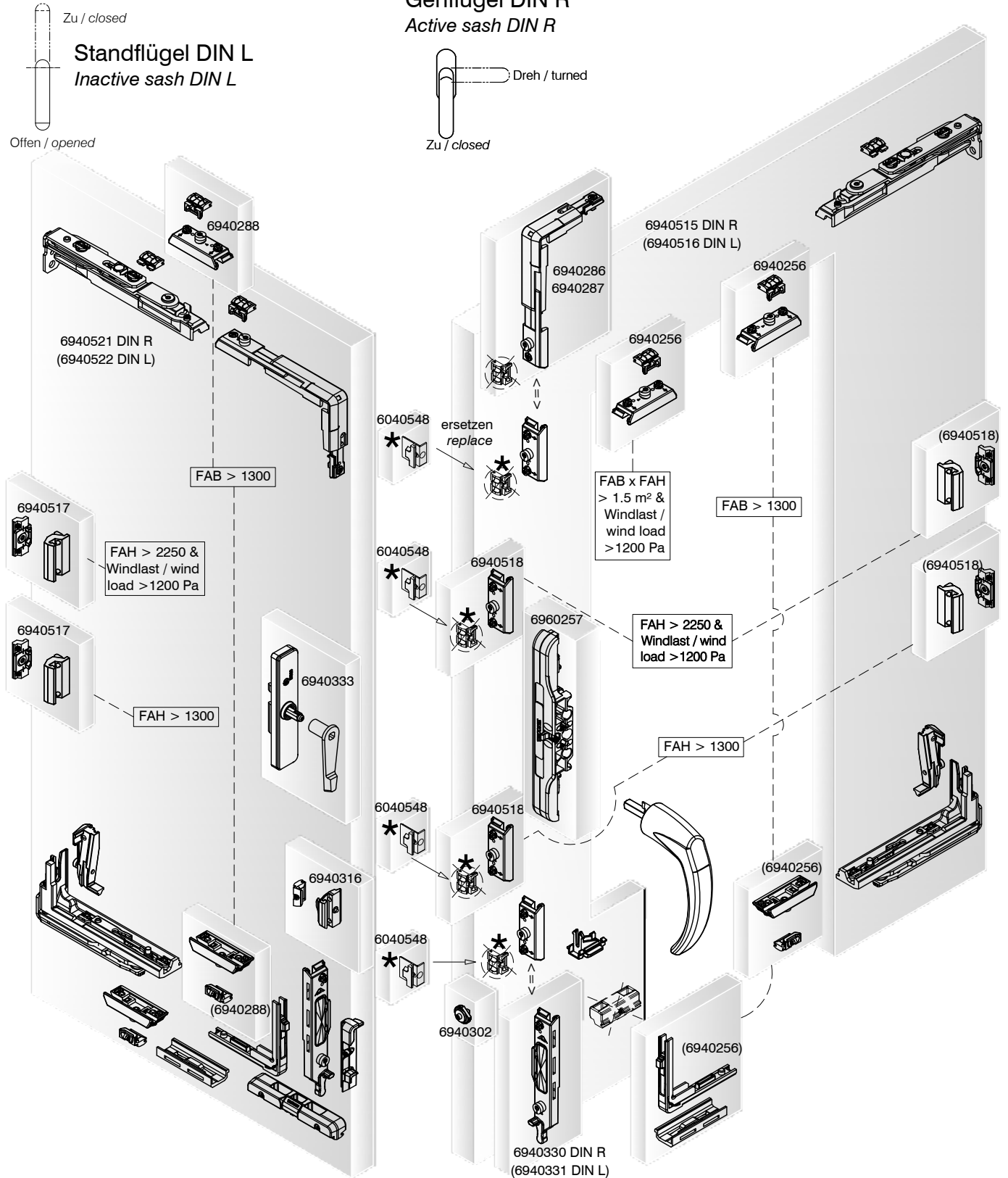

WICLINE 75 TOP

Grundbeschlag
Basic fitting



Beschläge
Fittings



Kipp-Beschlag verdeckt 130 kg Querformat
Tilt fitting concealed 130 kg landscape

Griff Stellungen
Handle position

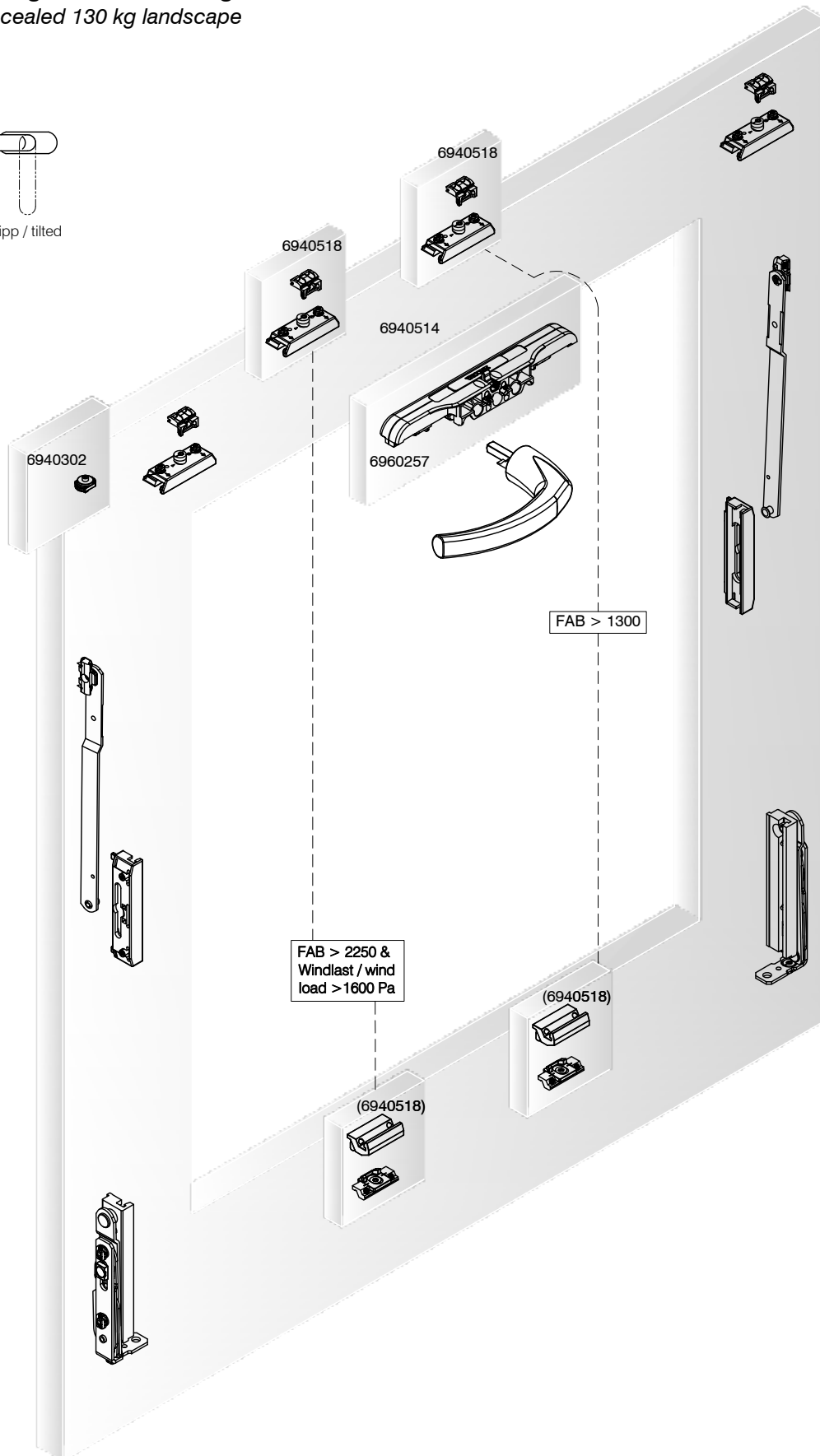
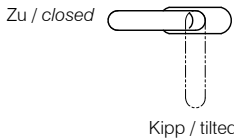

WICLINE 75 TOP

Grundbeschlag
Basic fitting



Beschläge
Fittings



Kipp-Beschlag verdeckt 130 kg Querformat mit vertikalen Mittelverriegelungen
Tilt fitting concealed 130 kg landscape with vertical centre lockings

Griff Stellungen
Handle position

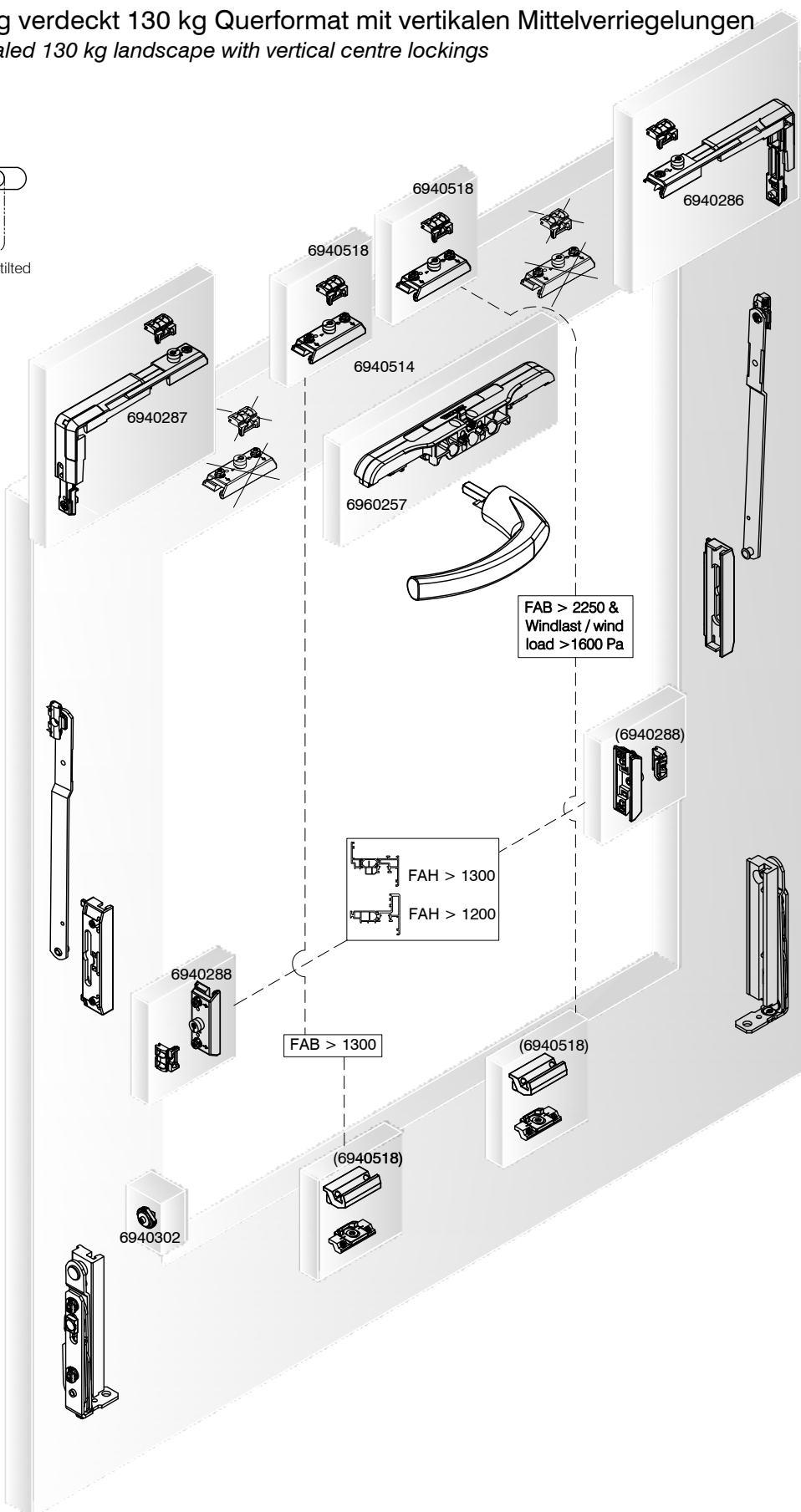
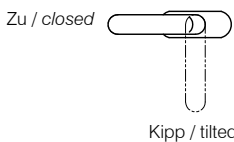

WICLINE 75 TOP

Grundbeschlag
Basic fitting



Beschläge
Fittings



Kipp-Beschlag verdeckt 130 kg Hochformat
Tilt fitting concealed 130 kg portrait

Griff Stellungen
Handle position

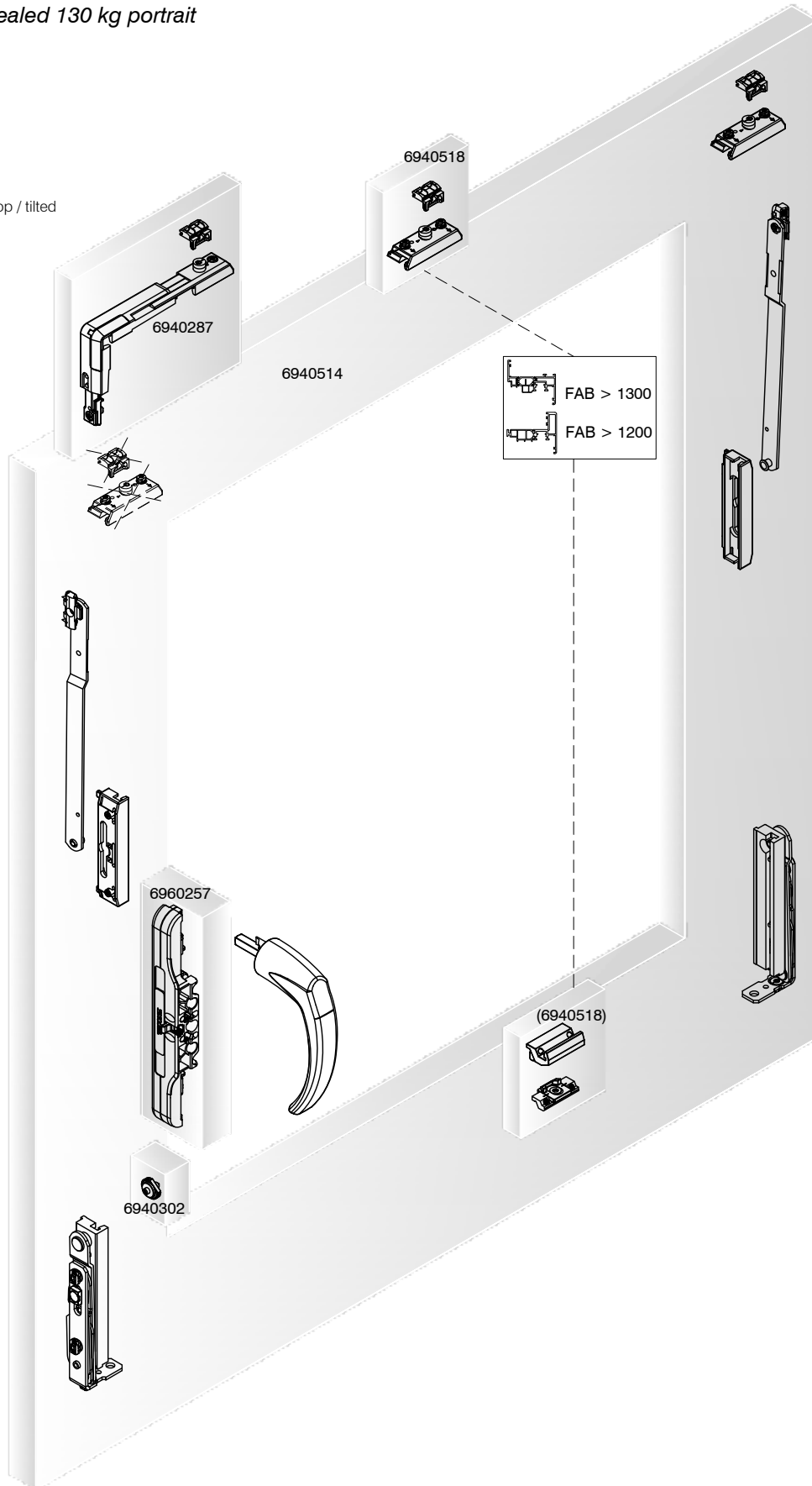
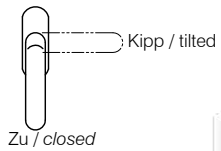

WICLINE 75 TOP

Grundbeschlag
Basic fitting



Beschläge
Fittings



Kipp-Beschlag verdeckt 130 kg Hochformat mit vertikalen Mittelverriegelungen
Tilt fitting concealed 130 kg portrait with vertical centre lockings

Griff Stellungen
Handle position

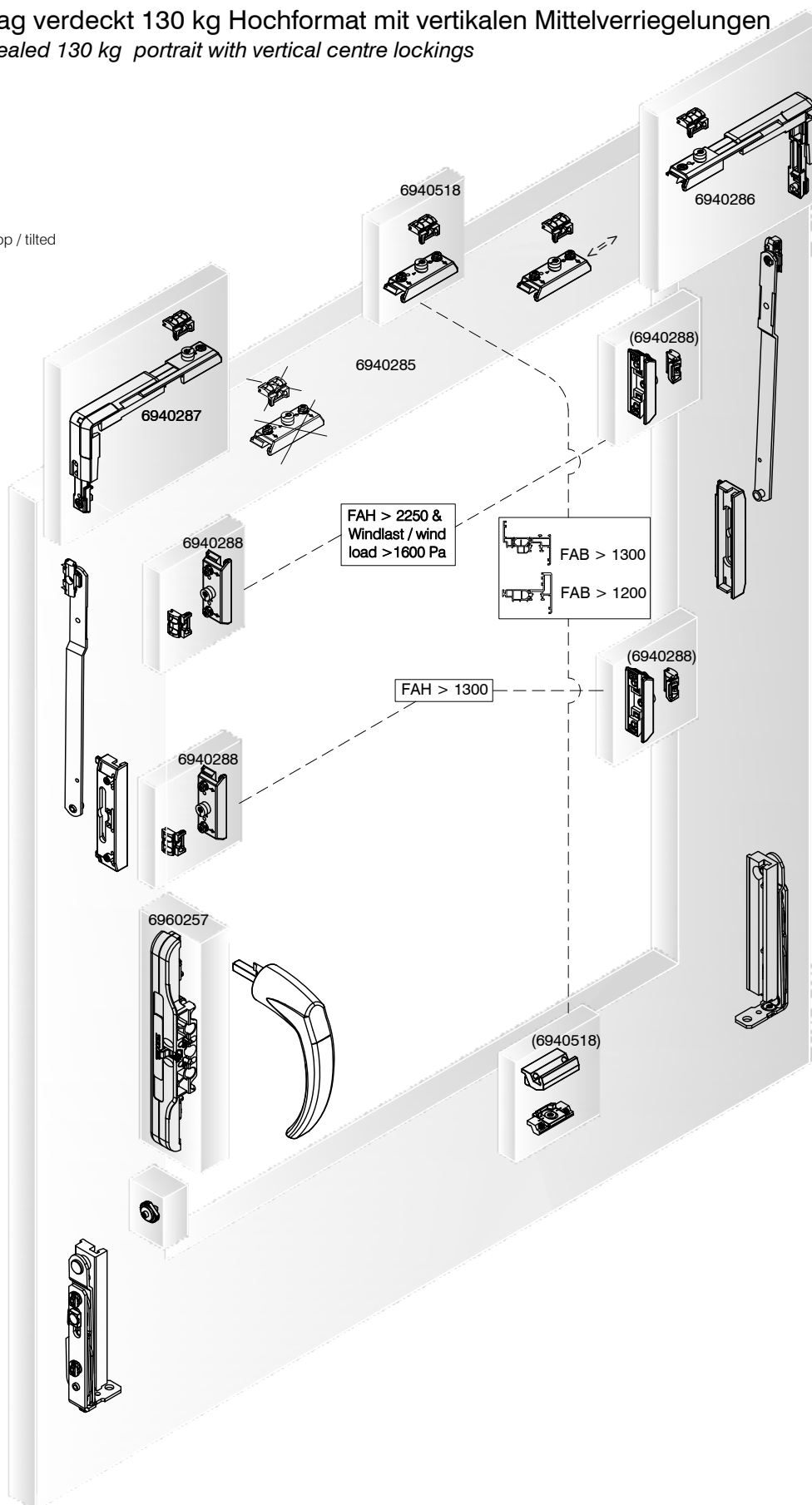
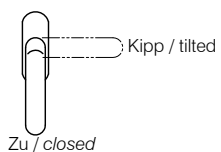



Oberlicht-Beschlag verdeckt
Fanlight fitting concealed

Griff Stellungen
Handle position

Zu / closed

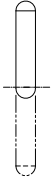

Kipp / tilted

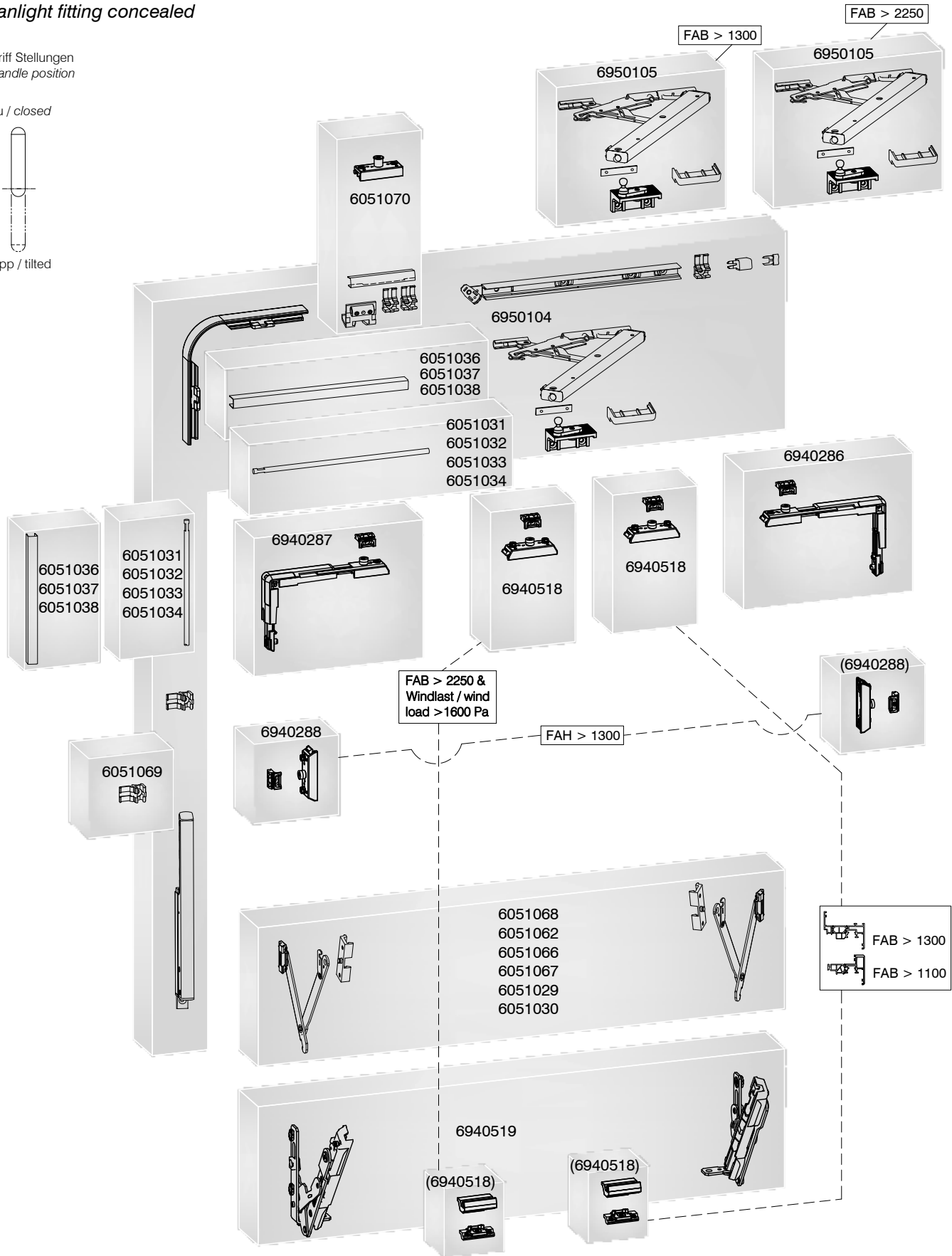



Oberlicht-Beschlag verdeckt, Schrägfenster
Fanlight fitting concealed, sloped window

Griff Stellungen
Handle position

Zu / closed



Kipp / tilted

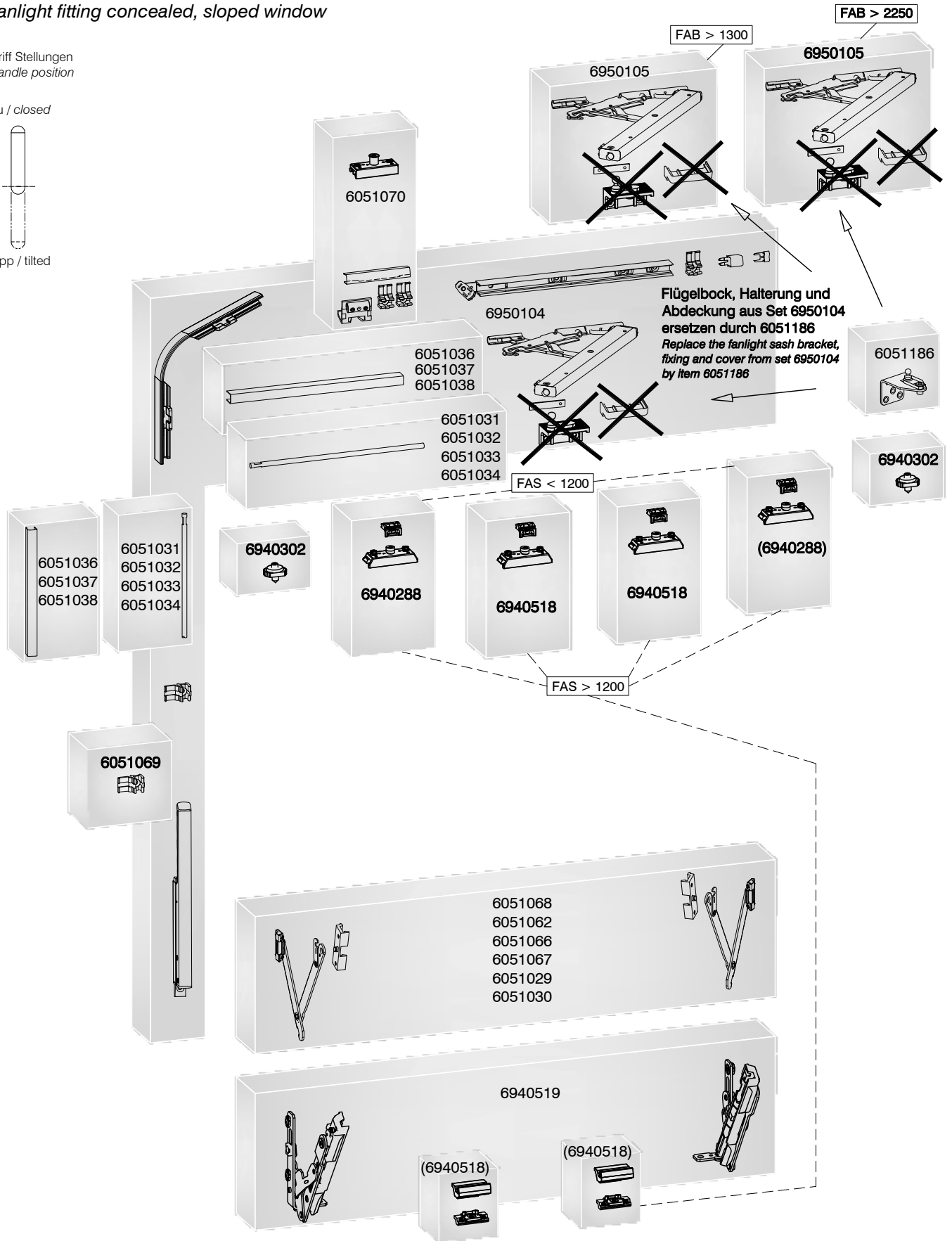

	Seite Page
Aufliegende Beschläge <i>Top mounted fittings</i>	
Zulässige Flügelgrößen, sichtbarer Flügel <i>Admissible sash sizes, visible sash</i>	2/118
Zulässige Flügelgrößen, verdeckter Flügel <i>Admissible sash sizes, concealed sash</i>	2/128
Zulässige Formatgrößen <i>Admissible format sizes</i>	2/135
Beschlagsübersichten <i>Survey of fittings</i>	2/149

WICLINE 75 TOP

Aufliegende Beschläge
Top mounted fittings

Zulässige Flügelgrößen
Admissible sash sizes



Profile Profiles		1017101				1017102				1017103				1017104				1017105				
	(Pa)	800	1200	2000	-	800	1200	2000	2000	800	1200	2000	2000*	800	1200	2000*	-					
	(Pa)	150	300	600	-	150	300	600	600	150	300	600	600	150	300	600	-					
Flügelgröße Sash size	max.	FAB (m)	1.3	1.2	1.1	-	1.6	1.5	1.4	1.0	1.6	1.6	1.5	1.0	1.7	1.7	1.6	-				
		FAH (m)	1.7	1.7	1.7	-	2.0	2.0	2.0	2.25	2.25	2.25	2.25	2.5	2.5	2.5	2.5	-				
	min.	FAB (m)	0.45	0.45	0.45	-	0.45	0.45	0.45	0.45	0.45	0.45	0.45	0.45	0.45	0.45	0.45	-				
		FAH (m)	0.6	0.6	0.6	-	0.6	0.6	0.6	0.6	0.6	0.6	0.6	0.6	0.6	0.6	0.6	-				
MV / MB	FAB (m)	-	-	-	-	-	-	1.3	-	-	-	1.3	-	-	-	1.3	-					
	FAH (m)	1.5	1.5	1.2	-	1.7	1.6	1.5	1.5	1.8	1.7	1.6	1.5*	1.8	1.7	1.6*	-					
	min.	FAB (m)	0.45	0.45	0.45	-	0.45	0.45	0.45	0.45	0.45	0.45	0.45	0.45	0.45	0.45	0.45	-				
		FAH (m)	0.83	0.83	0.83	-	0.83	0.83	0.83	0.83	0.83	0.83	0.83	0.83	0.83	0.83	0.83	-				
	min.	FAB (m)	0.65	0.65	0.65	-	0.65	0.65	0.65	0.65	0.65	0.65	0.65	0.65	0.65	0.65	0.65	-				
		FAH (m)	0.9	0.9	0.9	-	0.9	0.9	0.9	0.9	0.9	0.9	0.9	0.9	0.9	0.9	0.9	-				
	max. (kg)	100 (Klotzabst. 50 mm zur Ecke) (Shim dist. to corner 50 mm)				160				200												

* Windlast > 1600 Pa und FAH > 2.25 m werden zwei vertikale Zusatzverriegelungen benötigt
* Wind load > 1600 Pa and FAH 2.25 m requires two vertical additional locking points

WICLINE 75 TOP

Aufliegende Beschläge
Top mounted fittings

Zulässige Flügelgrößen
Admissible sash sizes



Profile Profiles		1017101				1017102				1017103								
	(Pa)	1600	-	-	-	1600	1600	-	-	1600	1600*	-	-					
	(Pa)	600	-	-	-	600	600	-	-	600	600	-	-					
Flügelgröße Sash size	max.	FAB (m)	1.1	-	-	-	1.3	1.0	-	-	1.3	1.0	-	-				
		FAH (m)	1.7	-	-	-	2.0	2.25	-	-	2.25	2.5	-	-				
	min.	FAB (m)	0.45	-	-	-	0.45	0.45	-	-	0.45	0.45	-	-				
		FAH (m)	0.6**	-	-	-	0.6**	0.6**	-	-	0.6**	0.6**	-	-				
MV / MB	FAB (m)	-	-	-	-	-	-	-	-	-	-	-	-					
	FAH (m)	1.3	-	-	-	1.5	1.5	-	-	1.6	1.5*	-	-					
	min.	FAB (m)	-	-	-	-	-	-	-	-	-	-	-					
		FAH (m)	-	-	-	-	-	-	-	-	-	-	-					
	min.	FAB (m)	-	-	-	-	-	-	-	-	-	-	-					
		FAH (m)	-	-	-	-	-	-	-	-	-	-	-					
	max.(kg)	100				160				160								

* Windlast > 1200 Pa und FAH > 2.25 m werden zwei vertikale Zusatzverriegelungen benötigt
* Wind load > 1200 Pa and FAH > 2.25 m requires two vertical additional locking points

** FAH_{min.} begrenzt über FAH1_{min.} = 0.6 m
** FAH_{min.} limited through FAH1_{min.} = 0.6 m









FAB1_{min.} = 0.3 m

WICLINE 75 TOP

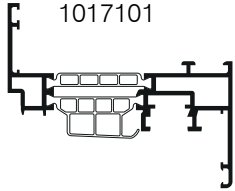
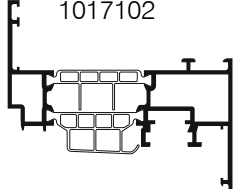
Aufliegende Beschläge
Top mounted fittings

Zulässige Flügelgrößen
Admissible sash sizes



Profile Profiles		 1017101												
		 1017102												
	(Pa)	800	1200	-	-									
	(Pa)	600	600	-	-									
Flügelgröße Sash size	max.	FAB (m)	1.3	1.2	-	-								
		FAH (m)	1.7	1.7	-	-								
	min.	FAB (m)	0.49	0.49	-	-								
		FAH (m)	0.6*	0.6*	-	-								
MV / MB	FAB (m)	-	-	-	-									
	FAH (m)	1.3	1.3	-	-									
	min.	FAB (m)	-	-	-	-								
		FAH (m)	-	-	-	-								
	min.	FAB (m)	-	-	-	-								
		FAH (m)	-	-	-	-								
	max.(kg)	80												

* FAH_{min.} begrenzt über FAH1_{min.} = 0.6 m
*FAH_{min.} limited through FAH1_{min.} = 0.6 m



FAB1_{min.} = 0.3 m

WICLINE 75 TOP

Aufliegende Beschläge
Top mounted fittings

Zulässige Flügelgrößen
Admissible sash sizes



Profile
Profiles

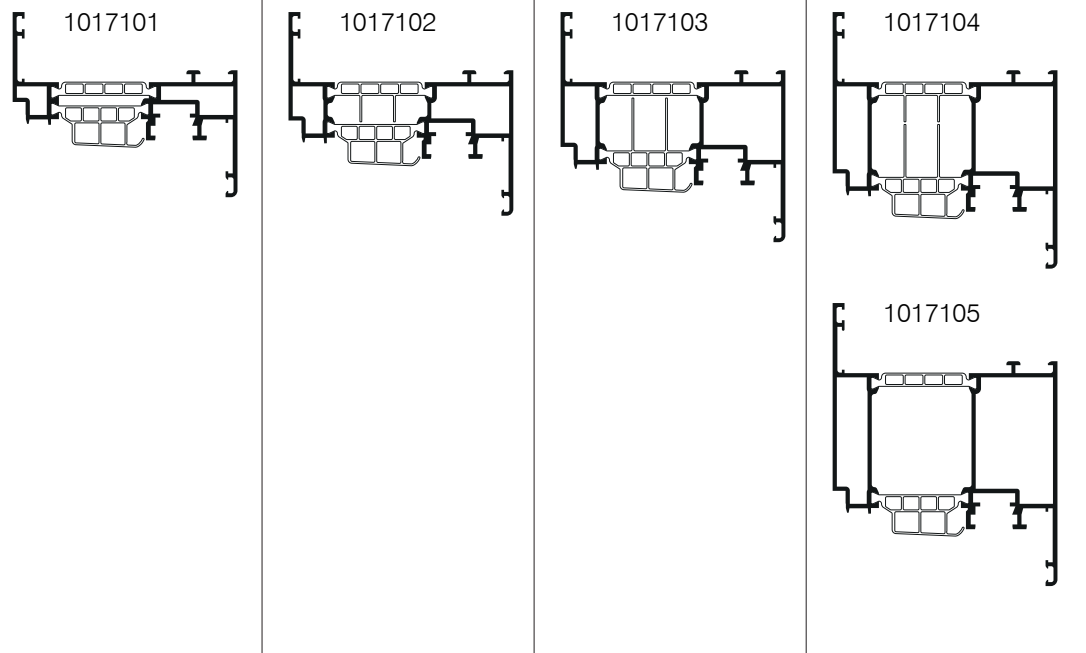

	(Pa) (m ²)**	800	1200	1600 (1.5)**	-	800	1200	1600 (1.7)**	1600 (1.7)**	800	1200	1600 (1.8)**	1600* (1.8)**	800	1200	1600* (2.0)**	-		
	(Pa)	150	300	600	-	150	300	600	600	150	300	600	600	150	300	450	-		
Flügelgröße Sash size	max.	FAB (m)	1.3	1.2	1.1	-	1.6	1.5	1.4	1.0	1.6	1.6	1.5	1.0	1.7	1.7	1.6	-	
		FAH (m)	1.7	1.7	1.7	-	2.0	2.0	2.0	2.25	2.25	2.25	2.25	2.5	2.5	2.5	2.5	-	
	min.	FAB (m)	0.45	0.45	0.45	-	0.45	0.45	0.45	0.45	0.45	0.45	0.45	0.45	0.45	0.45	0.45	0.45	-
		FAH (m)	0.68	0.68	0.68	-	0.68	0.68	0.68	0.68	0.68	0.68	0.68	0.68	0.68	0.68	0.68	0.68	-
MV / MB	FAB (m)	-	-	-	-	-	-	1.3	-	1.3	1.3	1.3	-	1.3	1.3	1.3	-		
	FAH (m)	1.5	1.5	1.3	-	1.7	1.6	1.5	1.5	1.8	1.7	1.6	1.5*	1.8	1.7	1.6*	-		
	min.	FAB (m)	0.65	0.65	0.65	-	0.65	0.65	0.65	0.65	0.65	0.65	0.65	0.65	0.65	0.65	0.65	-	
		FAH (m)	1.05	1.05	1.05	-	1.05	1.05	1.05	1.05	1.05	1.05	1.05	1.05	1.05	1.05	1.05	-	
	min.	FAB (m)	0.65	0.65	0.65	-	0.65	0.65	0.65	0.65	0.65	0.65	0.65	0.65	0.65	0.65	0.65	-	
		FAH (m)	1.12	1.12	1.12	-	1.12	1.12	1.12	1.12	1.12	1.12	1.12	1.12	1.12	1.12	1.12	-	
	max. (kg)	100 (Klotzabst. 50 mm zur Ecke) (Shim dist. to corner 50 mm)				160													

* Windlast > 1200 Pa und FAH > 2.25 m werden zwei vertikale Zusatzverriegelungen benötigt
* Wind load > 1200 Pa and FAH 2.25 m requires two vertical additional locking points

** Flügelgröße > () m² benötigt eine horizontale Zusatzverriegelung
** Sash size > () m² requires a horizontal additional locking point

WICLINE 75 TOP





Aufliegende Beschläge
Top mounted fittings

Zulässige Flügelgrößen
Admissible sash sizes

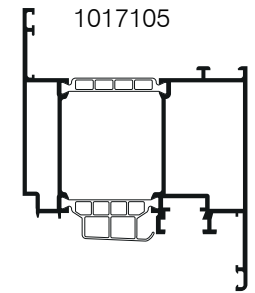
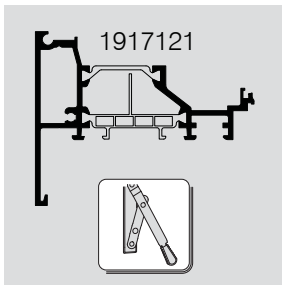
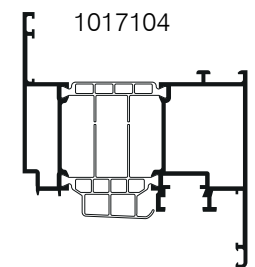
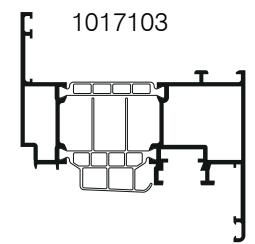
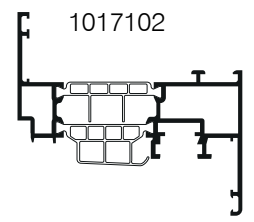
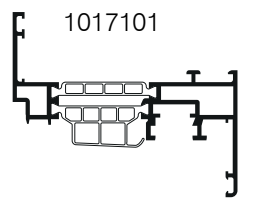

Profile
Profiles



	(Pa) (m ²)**	800	1200	1600 (1.5)**	-	800	1200	1600 (1.7)**	1600 (1.7)**	800	1200	1600 (1.8)**	1600 (1.8)**	800	1200	1600 (2.0)**	-		
	(Pa)	150	300	600	-	150	300	600	600	150	300	600	600	150	300	600	-		
Flügelgröße Sash size	max.	FAB (m)	1.2	1.2	1.2	-	1.3	1.3	1.3	1.0	1.3	1.3	1.3	1.0	1.3	1.3	1.3	-	
		FAH (m)	1.7	1.6	1.5	-	1.9	1.8	1.7	2.25	2.0	1.9	1.7	2.25	2.25	2.25	2.25	-	
	min.	FAB (m)	0.45	0.45	0.45	-	0.45	0.45	0.45	0.45	0.45	0.45	0.45	0.45	0.45	0.45	0.45	0.45	-
		FAH (m)	0.72	0.72	0.72	-	0.72	0.72	0.72	0.72	0.72	0.72	0.72	0.72	0.72	0.72	0.72	0.72	-
MV / MB	FAB (m)	-	-	-	-	-	-	-	-	-	-	-	-	-	-	-	-	-	
	FAH (m)	1.5	1.5	1.3	-	1.7	1.6	1.5	1.5	1.8	1.7	1.6	1.5	1.8	1.7	1.6	1.6	-	
	min.	FAB (m)	-	-	-	-	-	-	-	-	-	-	-	-	-	-	-	-	
		FAH (m)	-	-	-	-	-	-	-	-	-	-	-	-	-	-	-	-	-
	min.	FAB (m)	-	-	-	-	-	-	-	-	-	-	-	-	-	-	-	-	
		FAH (m)	-	-	-	-	-	-	-	-	-	-	-	-	-	-	-	-	-
	max. (kg)	100 (Klotzabst. 50 mm zur Ecke) (Shim dist. to corner 50 mm)				160													

** Flügelgröße > () m² benötigt eine horizontale Zusatzverriegelung am Gehflügel
** Sash size > () m² requires a horizontal additional locking point on the active leaf

WICLINE 75 TOP

Aufliegende Beschläge
Top mounted fittings

Zulässige Flügelgrößen
Admissible sash sizes



Profile
Profiles

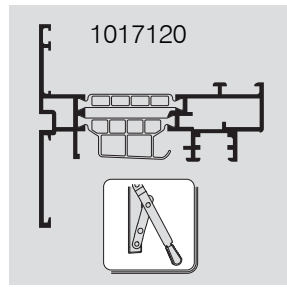
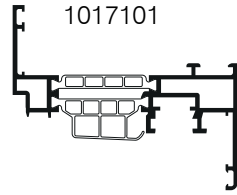

Profile
Profiles

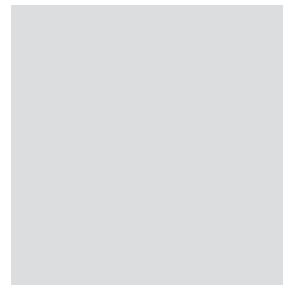

	(Pa)	800	1200	-	-	
	(Pa)	300	600	-	-	
Flügelgröße Sash size	max.	FAB (m)	1.2	1.2	-	-
		FAH (m)	1.6	1.5	-	-
	min.	FAB (m)	0.45	0.45	-	-
		FAH (m)	0.72	0.72	-	-
MV / MB	FAB (m)	-	-	-	-	
	FAH (m)	1.4	1.3	-	-	
 min.	FAB (m)	-	-	-	-	
	FAH (m)	-	-	-	-	
 min.	FAB (m)	-	-	-	-	
	FAH (m)	-	-	-	-	
 max.	max. (kg)	100 (Klotzabst. 50 mm zur Ecke) (Shim dist. to corner 50 mm)				

	(Pa)				
	(Pa)				
Flügelgröße Sash size	max.	FAB (m)			
		FAH (m)			
	min.	FAB (m)			
		FAH (m)			
MV / MB	FAB (m)				
	FAH (m)				
 min.	FAB (m)				
	FAH (m)				
 min.	FAB (m)				
	FAH (m)				
 max.	max. (kg)				

WICLINE 75 TOP

Aufliegende Beschläge
Top mounted fittings

Zulässige Flügelgrößen
Admissible sash sizes



Profile Profiles		1017101				1017102				1017103				1017104 1017105				
	(Pa)	800	1200	2000	-	800	1200	2000	2000	800	1200	2000	2000*	800	1200	2000*	-	
	(Pa)	150	300	600	-	150	300	600	600	150	300	600	600	150	300	600	-	
Flügelgröße Sash size	max.	FAB (m)	1.3	1.2	1.1	-	1.6	1.5	1.4	1.0	1.6	1.6	1.5	1.0	1.7	1.7	1.6	-
		FAH (m)	1.7	1.7	1.7	-	2.0	2.0	2.0	2.25	2.25	2.25	2.25	2.5	2.5	2.5	2.5	-
	min.	FAB (m)	0.425	0.425	0.425	-	0.425	0.425	0.425	0.425	0.425	0.425	0.425	0.425	0.425	0.425	0.425	-
		FAH (m)	0.7	0.7	0.7	-	0.7	0.7	0.7	0.7	0.7	0.7	0.7	0.7	0.7	0.7	0.7	-
MV / MB	FAB (m)	-	-	-	-	-	-	1.3	-	-	-	1.3	-	-	-	1.3	-	
	FAH (m)	1.5	1.5	1.3	-	1.7	1.6	1.5	1.5	1.8	1.7	1.6	1.5*	1.8	1.7	1.6*	-	
	min.	FAB (m)	0.425	0.425	0.425	-	0.425	0.425	0.425	0.425	0.425	0.425	0.425	0.425	0.425	0.425	0.425	-
		FAH (m)	0.7	0.7	0.7	-	0.7	0.7	0.7	0.7	0.7	0.7	0.7	0.7	0.7	0.7	0.7	-
	min.	FAB (m)	0.68	0.68	0.68	-	0.68	0.68	0.68	0.68	0.68	0.68	0.68	0.68	0.68	0.68	0.68	-
		FAH (m)	0.9	0.9	0.9	-	0.9	0.9	0.9	0.9	0.9	0.9	0.9	0.9	0.9	0.9	0.9	-
	max.(kg)	100				130												

* Windlast > 1600 Pa und FAH > 2.25 m werden zwei vertikale Zusatzverriegelungen benötigt
* Wind load > 1600 Pa and FAH 2.25 m requires two vertical additional locking points

WICLINE 75 TOP

Aufliegende Beschläge
Top mounted fittings

Zulässige Flügelgrößen
Admissible sash sizes



Profile Profiles		1017101				1017102				1017103				1017104				1017105				
	(Pa)	800	1200	2000	-	800	1200	2000	2000	800	1200	2000	2000*	800	1200	2000*	-					
	(Pa)	150	300	600	-	150	300	600	600	150	300	600	600	150	300	600	-					
Flügelgröße Sash size	max.	FAB (m)	1.7	1.7	1.7	-	2.0	2.0	2.0	2.25	2.25	2.25	2.25	2.5	2.5	2.5	2.5	-				
		FAH (m)	1.3	1.2	1.1	-	1.6	1.5	1.4	1.0	1.6	1.6	1.5	1.0	1.7	1.7	1.6	-				
	min.	FAB (m)	0.6	0.6	0.6	-	0.6	0.6	0.6	0.6	0.6	0.6	0.6	0.6	0.6	0.6	0.6	-				
		FAH (m)	0.45	0.45	0.45	-	0.45	0.45	0.45	0.45	0.45	0.45	0.45	0.45	0.45	0.45	0.45	-				
MV / MB	FAB (m)	1.5	1.5	1.3	-	1.7	1.6	1.5	1.5	1.8	1.7	1.6	1.5*	1.8	1.7	1.6*	-					
	FAH (m)	-	-	-	-	-	-	1.3	-	-	-	1.3	-	-	-	1.3	-					
	min.	FAB (m)	0.74	0.74	0.74	-	0.74	0.74	0.74	0.74	0.74	0.74	0.74	0.74	0.74	0.74	0.74	-				
		FAH (m)	0.45	0.45	0.45	-	0.45	0.45	0.45	0.45	0.45	0.45	0.45	0.45	0.45	0.45	0.45	-				
	min.	FAB (m)	0.9	0.9	0.9	-	0.9	0.9	0.9	0.9	0.9	0.9	0.9	0.9	0.9	0.9	0.9	-				
		FAH (m)	0.6	0.6	0.6	-	0.6	0.6	0.6	0.6	0.6	0.6	0.6	0.6	0.6	0.6	0.6	-				
	max. (kg)	100 (Klotzabst. 50 mm zur Ecke) (Shim dist. to corner 50 mm)				130																

*** Zusätzliche Verklebung, Angaben in den Verarbeitungsrichtlinien beachten!
*** Additional gluing, pay attention to specifications in the workshop manual!

WICLINE 75 TOP

Aufliegende Beschläge
Top mounted fittings

Zulässige Flügelgrößen
Admissible sash sizes



Profile Profiles		1017101				1017102				1017103				1017104				1017105				
	(Pa)	800	1200	2000	-	800	1200	2000	2000	800	1200	2000	2000*	800	1200	2000*	-					
	(Pa)	150	300	600	-	150	300	600	600	150	300	600	600	150	300	600	-					
Flügelgröße Sash size	max.	FAB (m)	1.7	1.7	1.7	-	2.0	2.0	2.0	2.25	2.25	2.25	2.25	2.5	2.5	2.5	2.5	-				
		FAH (m)	1.3	1.2	1.1	-	1.6	1.5	1.4	1.0	1.6	1.6	1.5	1.0	1.7	1.7	1.6	-				
	min.	FAB (m)	0.55	0.55	0.55	-	0.55	0.55	0.55	0.55	0.55	0.55	0.55	0.55	0.55	0.55	0.55	-				
		FAH (m)	0.45	0.45	0.45	-	0.45	0.45	0.45	0.45	0.45	0.45	0.45	0.45	0.45	0.45	0.45	-				
MV / MB	FAB (m)	1.5	1.5	1.3	-	1.7	1.6	1.5	1.5	1.8	1.7	1.6	1.5*	1.8	1.7	1.6*	-					
	FAH (m)	-	-	-	-	-	-	1.3	-	-	-	1.3	-	-	-	1.3	-					
	min.	FAB (m)	0.88	0.88	0.88	-	0.88	0.88	0.88	0.88	0.88	0.88	0.88	0.88	0.88	0.88	0.88	-				
		FAH (m)	0.45	0.45	0.45	-	0.45	0.45	0.45	0.45	0.45	0.45	0.45	0.45	0.45	0.45	0.45	-				
	min.	FAB (m)	0.88	0.88	0.88	-	0.88	0.88	0.88	0.88	0.88	0.88	0.88	0.88	0.88	0.88	0.88	-				
		FAH (m)	0.6	0.6	0.6	-	0.6	0.6	0.6	0.6	0.6	0.6	0.6	0.6	0.6	0.6	0.6	-				
	max. (kg)	80 (Klotzabst. 50 mm zur Ecke) (Shim dist. to corner 50 mm)				80 / 120																

* Windlast > 1600 Pa und FAB > 2.25 m werden zwei horizontale Zusatzverriegelungen/Mittelbänder benötigt

* Wind load > 1600 Pa and FAB 2.25 m requires two horizontal additional locking points/centre hinges

WICLINE 75 TOP

Aufliegende Beschläge
Top mounted fittings

Zulässige Flügelgrößen
Admissible sash sizes



Profile Profiles		1017101				1017102											
	(Pa)	800	1200	1600	-	800	1200	1600	-								
	(Pa)	150	300	600	-	150	300	600	-								
Flügelgröße Sash size	max.	FAB (m)	1.7	1.7	1.7	-	2.0	2.0	2.0	-							
		FAH (m)	1.3	1.2	1.1	-	1.6	1.5	1.3	-							
	min.	FAB (m)	0.55	0.55	0.55	-	0.55	0.55	0.55	-							
		FAH (m)	0.45	0.45	0.45	-	0.45	0.45	0.45	-							
MV / MB	FAB (m)	1.5	1.5	1.3	-	1.7	1.6	1.5	-								
	FAH (m)	-	-	-	-	-	-	-	-								
	min.	FAB (m)	-	-	-	-	-	-	-	-							
		FAH (m)	-	-	-	-	-	-	-	-							
	min.	FAB (m)	-	-	-	-	-	-	-	-							
		FAH (m)	-	-	-	-	-	-	-	-							
	max. (kg)	80 (Klotzabst. 50 mm zur Ecke) (Shim dist. to corner 50 mm)				80 / 120											

WICLINE 75 TOP

Aufliegende Beschläge
Top mounted fittings

Zulässige Flügelgrößen
Admissible sash sizes



Profile Profiles		1017111				1017113				1017111				1017113				
	(Pa)	800	1200	2000	-	800	1200	2000	-	800	1200	2000	-	800	1200	2000	-	
	(Pa)	150	300	600	-	150	300	600	-	150	300	600	-	150	300	600	-	
Flügelgröße Sash size	max.	FAB (m)	1.4	1.3	1.2	-	1.4	1.4	1.3	-	1.4	1.3	1.2	-	1.4	1.4	1.3	-
		FAH (m)	1.7	1.7	1.7	-	1.8	1.8	1.8	-	1.8	2.0	2.1	-	2.0	2.0	2.25	-
	min.	FAB (m)	0.45	0.45	0.45	-	0.45	0.45	0.45	-	0.45	0.45	0.45	-	0.45	0.45	0.45	-
		FAH (m)	0.6	0.6	0.6	-	0.6	0.6	0.6	-	0.6	0.6	0.6	-	0.6	0.6	0.6	-
MV / MB	FAB (m)	-	-	-	-	-	-	-	-	-	-	-	-	-	-	1.2	-	
	FAH (m)	1.5	1.4	1.3	-	1.5	1.5	1.4	-	1.5	1.4	1.3	-	1.5	1.5	1.4	-	
	min.	FAB (m)	0.45	0.45	0.45	-	0.45	0.45	0.45	-	0.45	0.45	0.45	-	0.45	0.45	0.45	-
		FAH (m)	0.83	0.83	0.83	-	0.83	0.83	0.83	-	0.83	0.83	0.83	-	0.83	0.83	0.83	-
	min.	FAB (m)	0.65	0.65	0.65	-	0.65	0.65	0.65	-	0.65	0.65	0.65	-	0.65	0.65	0.65	-
		FAH (m)	0.9	0.9	0.9	-	0.9	0.9	0.9	-	0.9	0.9	0.9	-	0.9	0.9	0.9	-
	max.(kg)	100								130***								

*** Zusätzliche Verklebung, Angaben in den Verarbeitungsrichtlinien beachten!
*** Additional gluing, pay attention to specifications in the workshop manual!

WICLINE 75 TOP

Aufliegende Beschläge
Top mounted fittings

Zulässige Flügelgrößen
Admissible sash sizes

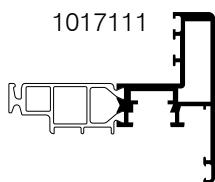

1017111

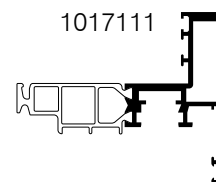

1017111

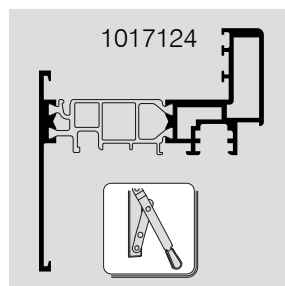

1017124

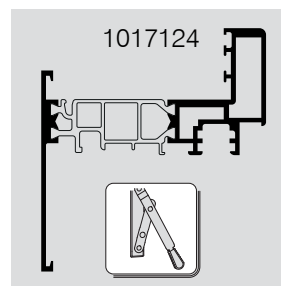

1017124

	(Pa)	400	800	1200	-
	(Pa)	150	300	450	-
max.	FAB (m)	1.4	1.3	1.2	-
	FAH (m)	1.7	1.7	1.6	-
min.	FAB (m)	0.45	0.45	0.45	-
	FAH (m)	0.6	0.6	0.6	-
MV / MB	FAB (m)	1.2	1.2	1.0	-
	FAH (m)	1.4	1.3	1.2	-
	min. FAB (m)	-	-	-	-
	min. FAH (m)	-	-	-	-
	min. FAB (m)	-	-	-	-
	min. FAH (m)	-	-	-	-
	max.(kg)	100			

	(Pa)	400	800	1200	-
	(Pa)	150	300	450	-
max.	FAB (m)	1.4	1.3	1.1	-
	FAH (m)	1.9	1.9	1.9	-
min.	FAB (m)	0.45	0.45	0.45	-
	FAH (m)	0.6	0.6	0.6	-
MV / MB	FAB (m)	1.2	1.2	1.0	-
	FAH (m)	1.4	1.3	1.2	-
	min. FAB (m)	-	-	-	-
	min. FAH (m)	-	-	-	-
	min. FAB (m)	-	-	-	-
	min. FAH (m)	-	-	-	-
	max.(kg)	130***			

*** Zusätzliche Verklebung, Angaben in den Verarbeitungsrichtlinien beachten!
*** Additional gluing, pay attention to specifications in the workshop manual!

WICLINE 75 TOP

Aufliegende Beschläge
Top mounted fittings

Zulässige Flügelgrößen
Admissible sash sizes

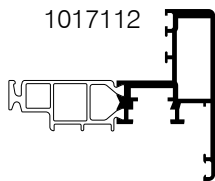

1017112

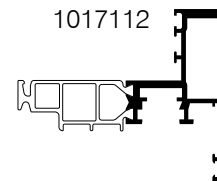

1017112

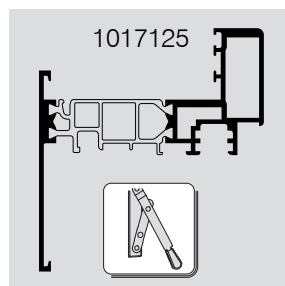

1017125

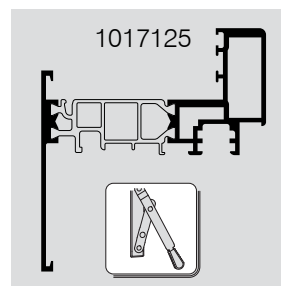

1017125

	(Pa)	400	800	1200	-
	(Pa)	150	300	450	-
max.	FAB (m)	1.4	1.3	1.2	-
	FAH (m)	1.7	1.7	1.6	-
min.	FAB (m)	0.45	0.45	0.45	-
	FAH (m)	0.6	0.6	0.6	-
MV / MB	FAB (m)	1.2	1.2	1.0	-
	FAH (m)	1.4	1.3	1.2	-
	min. FAB (m)	-	-	-	-
	min. FAH (m)	-	-	-	-
	min. FAB (m)	-	-	-	-
	min. FAH (m)	-	-	-	-
	max.(kg)	100			

	(Pa)	400	800	1200	-
	(Pa)	150	300	450	-
max.	FAB (m)	1.4	1.3	1.1	-
	FAH (m)	1.9	1.9	1.9	-
min.	FAB (m)	0.45	0.45	0.45	-
	FAH (m)	0.6	0.6	0.6	-
MV / MB	FAB (m)	1.2	1.2	1.0	-
	FAH (m)	1.4	1.3	1.2	-
	min. FAB (m)	-	-	-	-
	min. FAH (m)	-	-	-	-
	min. FAB (m)	-	-	-	-
	min. FAH (m)	-	-	-	-
	max.(kg)	130***			

*** Zusätzliche Verklebung, Angaben in den Verarbeitungsrichtlinien beachten!
*** Additional gluing, pay attention to specifications in the workshop manual!

WICLINE 75 TOP

Aufliegende Beschläge
Top mounted fittings

Zulässige Flügelgrößen
Admissible sash sizes

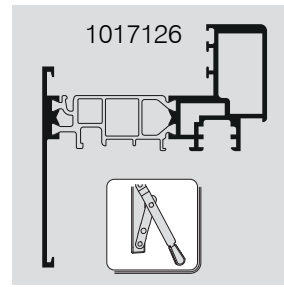
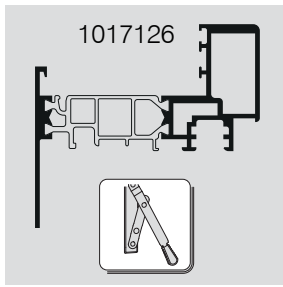
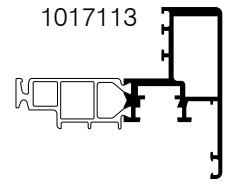
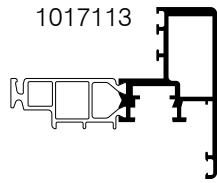

	(Pa)	400	800	1200	-
	(Pa)	150	300	450	-
max.	FAB (m)	1.4	1.3	1.2	-
	FAH (m)	1.7	1.7	1.6	-
min.	FAB (m)	0.45	0.45	0.45	-
	FAH (m)	0.6	0.6	0.6	-
MV / MB	FAB (m)	1.2	1.2	1.0	-
	FAH (m)	1.4	1.3	1.2	-
	min. FAB (m)	-	-	-	-
	min. FAH (m)	-	-	-	-
	min. FAB (m)	-	-	-	-
	min. FAH (m)	-	-	-	-
	max.(kg)	100			

	(Pa)	400	800	1200	-
	(Pa)	150	300	450	-
max.	FAB (m)	1.4	1.2	1.1	-
	FAH (m)	2.0	2.0	2.0	-
min.	FAB (m)	0.45	0.45	0.45	-
	FAH (m)	0.6	0.6	0.6	-
MV / MB	FAB (m)	1.2	-	1.0	-
	FAH (m)	1.4	1.3	1.2	-
	min. FAB (m)	-	-	-	-
	min. FAH (m)	-	-	-	-
	min. FAB (m)	-	-	-	-
	min. FAH (m)	-	-	-	-
	max.(kg)	130***			

*** Zusätzliche Verklebung, Angaben in den Verarbeitungsrichtlinien beachten!
*** Additional gluing, pay attention to specifications in the workshop manual!

WICLINE 75 TOP

Aufliegende Beschläge
Top mounted fittings

Zulässige Flügelgrößen
Admissible sash sizes



Profile Profiles		1017111				1017113				1017111				1017113				
	(Pa)	800	1200	2000	-	800	1200	2000	-	800	1200	2000	-	800	1200	2000	-	
	(Pa)	150	300	600	-	150	300	600	-	150	300	600	-	150	300	600	-	
Flügelgröße Sash size	max.	FAB (m)	1.4	1.3	1.2	-	1.4	1.4	1.3	-	1.4	1.3	1.2	-	1.4	1.4	1.3	-
		FAH (m)	1.7	1.7	1.7	-	1.8	1.8	1.8	-	1.8	2.0	2.1	-	2.0	2.0	2.25	-
	min.	FAB (m)	0.425	0.425	0.425	-	0.425	0.425	0.425	-	0.425	0.425	0.425	-	0.425	0.425	0.425	-
		FAH (m)	0.7	0.7	0.7	-	0.7	0.7	0.7	-	0.7	0.7	0.7	-	0.7	0.7	0.7	-
MV / MB	FAB (m)	-	-	-	-	-	-	-	-	-	-	-	-	-	-	1.2	-	
	FAH (m)	1.5	1.4	1.3	-	1.5	1.5	1.4	-	1.5	1.4	1.3	-	1.5	1.5	1.4	-	
	min.	FAB (m)	0.425	0.425	0.425	-	0.425	0.425	0.425	-	0.425	0.425	0.425	-	0.425	0.425	0.425	-
		FAH (m)	0.7	0.7	0.7	-	0.7	0.7	0.7	-	0.7	0.7	0.7	-	0.7	0.7	0.7	-
	min.	FAB (m)	0.68	0.68	0.68	-	0.68	0.68	0.68	-	0.68	0.68	0.68	-	0.68	0.68	0.68	-
		FAH (m)	0.9	0.9	0.9	-	0.9	0.9	0.9	-	0.9	0.9	0.9	-	0.9	0.9	0.9	-
	max.(kg)	100								130***								

*** Zusätzliche Verklebung, Angaben in den Verarbeitungsrichtlinien beachten!
*** Additional gluing, pay attention to specifications in the workshop manual!

WICLINE 75 TOP

Aufliegende Beschläge
Top mounted fittings

Zulässige Flügelgrößen
Admissible sash sizes



Profile Profiles		1017111				1017113				1017111				1017113				
	(Pa)	800	1200	2000	-	800	1200	2000		800	1200	2000	-	800	1200	2000	-	
	(Pa)	150	300	600	-	150	300	600		150	300	600	-	150	300	600	-	
Flügelgröße Sash size	max.	FAB (m)	1.7	1.7	1.7	-	1.8	1.8	1.8	-	1.8	2.0	2.1	-	2.0	2.0	2.25	-
		FAH (m)	1.4	1.3	1.2	-	1.4	1.4	1.3	-	1.4	1.3	1.2	-	1.4	1.4	1.3	-
	min.	FAB (m)	0.6	0.6	0.6	-	0.6	0.6	0.6	-	0.6	0.6	0.6	-	0.6	0.6	0.6	-
		FAH (m)	0.45	0.45	0.45	-	0.45	0.45	0.45	-	0.45	0.45	0.45	-	0.45	0.45	0.45	-
MV / MB	FAB (m)	1.5	1.4	1.3	-	1.5	1.5	1.4	-	1.5	1.4	1.3	-	1.5	1.5	1.4	-	
	FAH (m)	-	-	-	-	-	-	-	-	-	-	-	-	-	-	1.2	-	
	min.	FAB (m)	0.74	0.74	0.74	-	0.74	0.74	0.74	-	0.74	0.74	0.74	-	0.74	0.74	0.74	-
		FAH (m)	0.45	0.45	0.45	-	0.45	0.45	0.45	-	0.45	0.45	0.45	-	0.45	0.45	0.45	-
	min.	FAB (m)	0.9	0.9	0.9	-	0.9	0.9	0.9	-	0.9	0.9	0.9	-	0.9	0.9	0.9	-
		FAH (m)	0.6	0.6	0.6	-	0.6	0.6	0.6	-	0.6	0.6	0.6	-	0.6	0.6	0.6	-
	max.(kg)	100								130***								

*** Zusätzliche Verklebung, Angaben in den Verarbeitungsrichtlinien beachten!
*** Additional gluing, pay attention to specifications in the workshop manual!

WICLINE 75 TOP

Aufliegende Beschläge
Top mounted fittings

Zulässige Flügelgrößen
Admissible sash sizes



Profile Profiles		1017111				1017113				1017111				1017113				
	(Pa)	800	1200	2000	-	800	1200	2000	-	800	1200	2000	-	800	1200	2000	-	
	(Pa)	150	300	600	-	150	300	600	-	150	300	600	-	150	300	600	-	
Flügelgröße Sash size	max.	FAB (m)	1.7	1.7	1.7	-	1.8	1.8	1.8	-	1.8	2.0	2.1	-	2.0	2.0	2.25	-
		FAH (m)	1.4	1.3	1.2	-	1.4	1.4	1.3	-	1.4	1.3	1.2	-	1.4	1.4	1.3	-
	min.	FAB (m)	0.55	0.55	0.55	-	0.55	0.55	0.55	-	0.55	0.55	0.55	-	0.55	0.55	0.55	-
		FAH (m)	0.45	0.45	0.45	-	0.45	0.45	0.45	-	0.45	0.45	0.45	-	0.45	0.45	0.45	-
MV / MB	FAB (m)	1.5	1.4	1.3	-	1.5	1.5	1.4	-	1.5	1.4	1.3	-	1.5	1.5	1.4	-	
	FAH (m)	-	-	-	-	-	-	-	-	-	-	-	-	-	-	1.2	-	
	min.	FAB (m)	0.88	0.88	0.88	-	0.88	0.88	0.88	-	0.88	0.88	0.88	-	0.88	0.88	0.88	-
		FAH (m)	0.45	0.45	0.45	-	0.45	0.45	0.45	-	0.45	0.45	0.45	-	0.45	0.45	0.45	-
	min.	FAB (m)	0.88	0.88	0.88	-	0.88	0.88	0.88	-	0.88	0.88	0.88	-	0.88	0.88	0.88	-
		FAH (m)	0.6	0.6	0.6	-	0.6	0.6	0.6	-	0.6	0.6	0.6	-	0.6	0.6	0.6	-
	max.(kg)	80								120***								

*** Zusätzliche Verklebung, Angaben in den Verarbeitungsrichtlinien beachten!
*** Additional gluing, pay attention to specifications in the workshop manual!

WICLINE

Beschläge
Fittings

Zulässige Formatgrößen, aufliegende Beschläge
Admissible format sizes, top mounted fittings

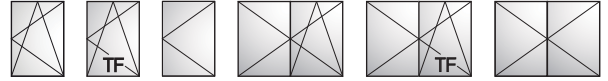

WICSTAR

Flügelgewicht max. 100 kg
Sash weight max. 100 kg

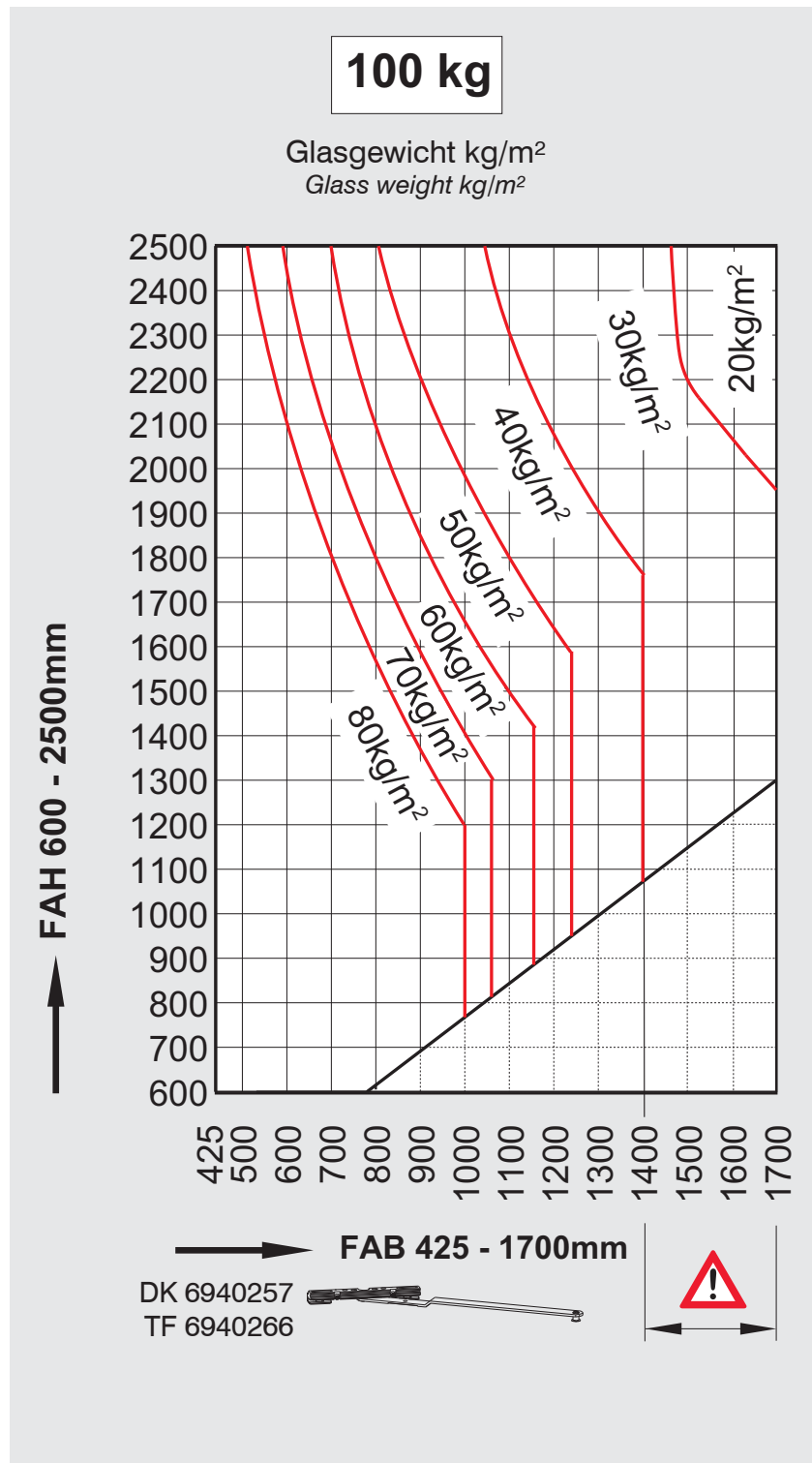

Zulässige Formatgrößen, aufliegende Beschläge
Admissible format sizes, top mounted fittings

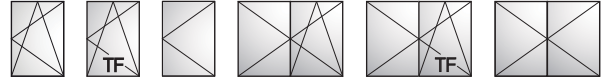

WICSTAR

mit Zusatzschraube Flügelgewicht 100-130 kg
with additional screw sash weight 100-130 kg

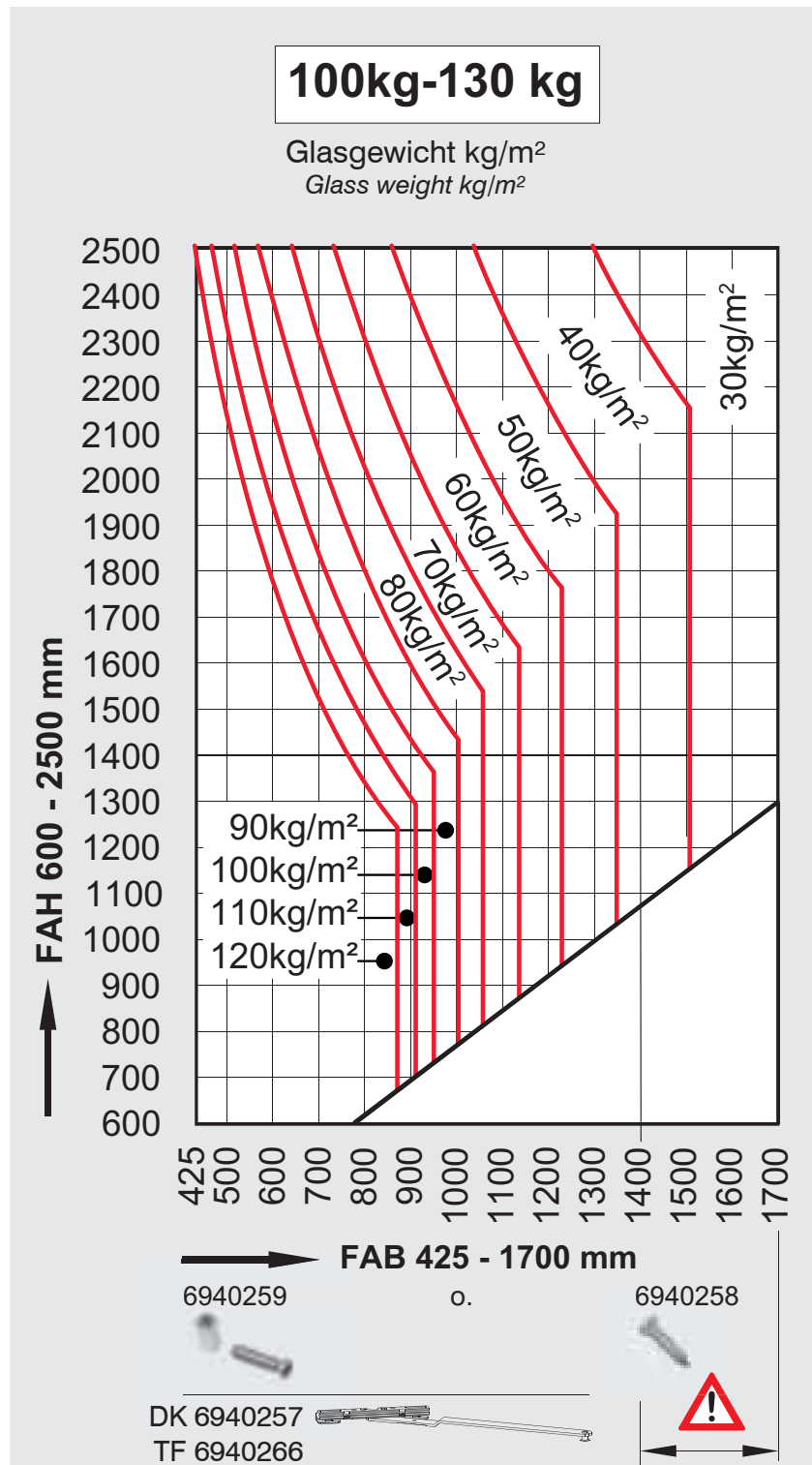

WICLINE 75 TOP

Beschläge
Fittings

Zulässige Formatgrößen, aufliegende Beschläge
Admissible format sizes, top mounted fittings

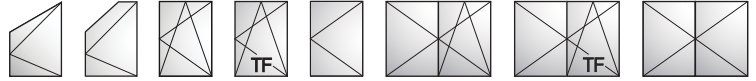

WICSTAR

mit Zusatzschraube Flügelgewicht 130-160 kg
with additional screws sash weight 130-160 kg

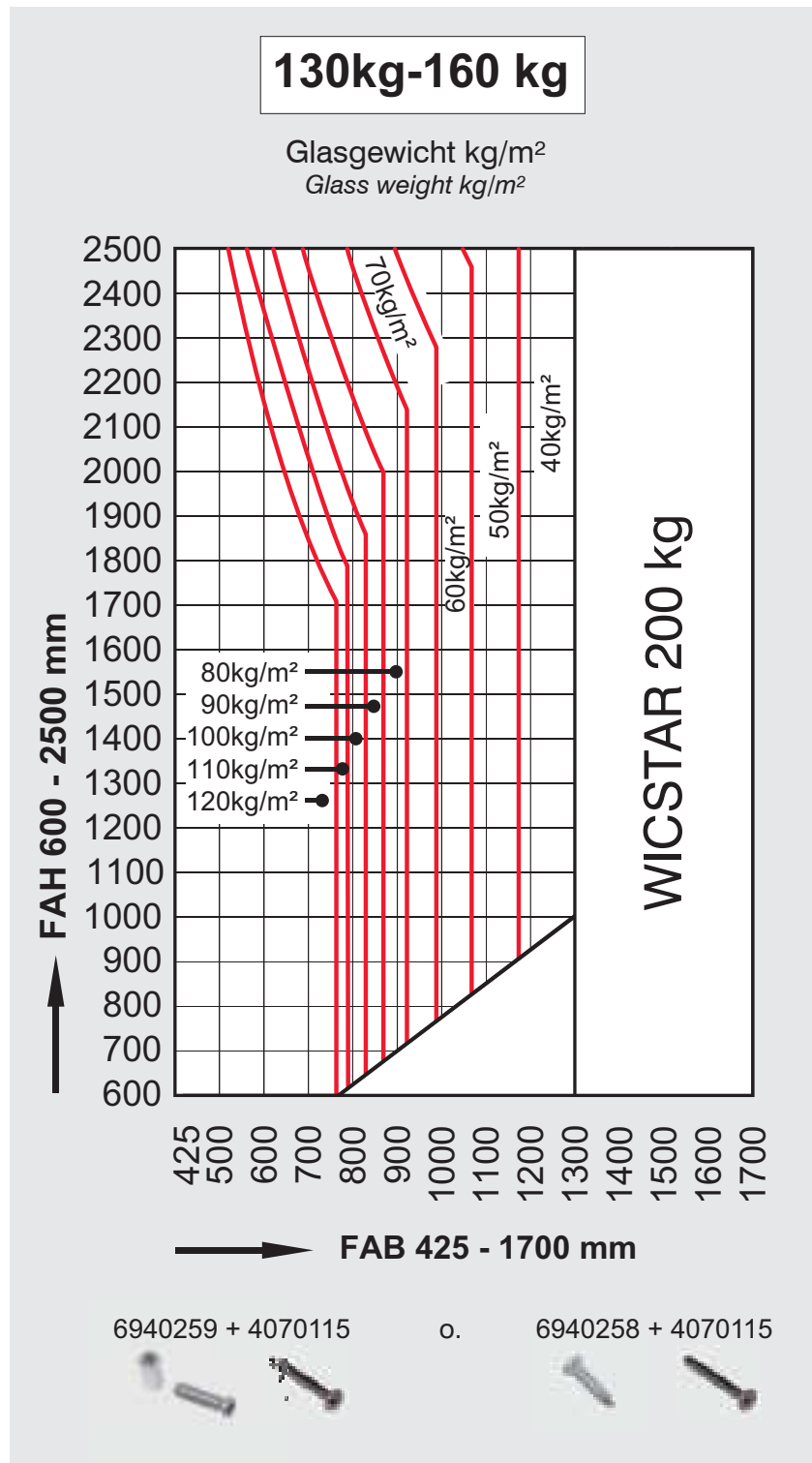

Zulässige Formatgrößen, aufliegende Beschläge
Admissible format sizes, top mounted fittings



WICSTAR

Flügelgewicht max. 200 kg
Sash weight max. 200 kg



Die Befestigung der Blendrahmenbänder erfordert Rahmenprofile mit einer Kammerhöhe ≥ 28 mm (z.B. 1916004)
The fixation of the hinges require frame profiles with a chamber height of 28 mm or higher (e.g. 1916004)

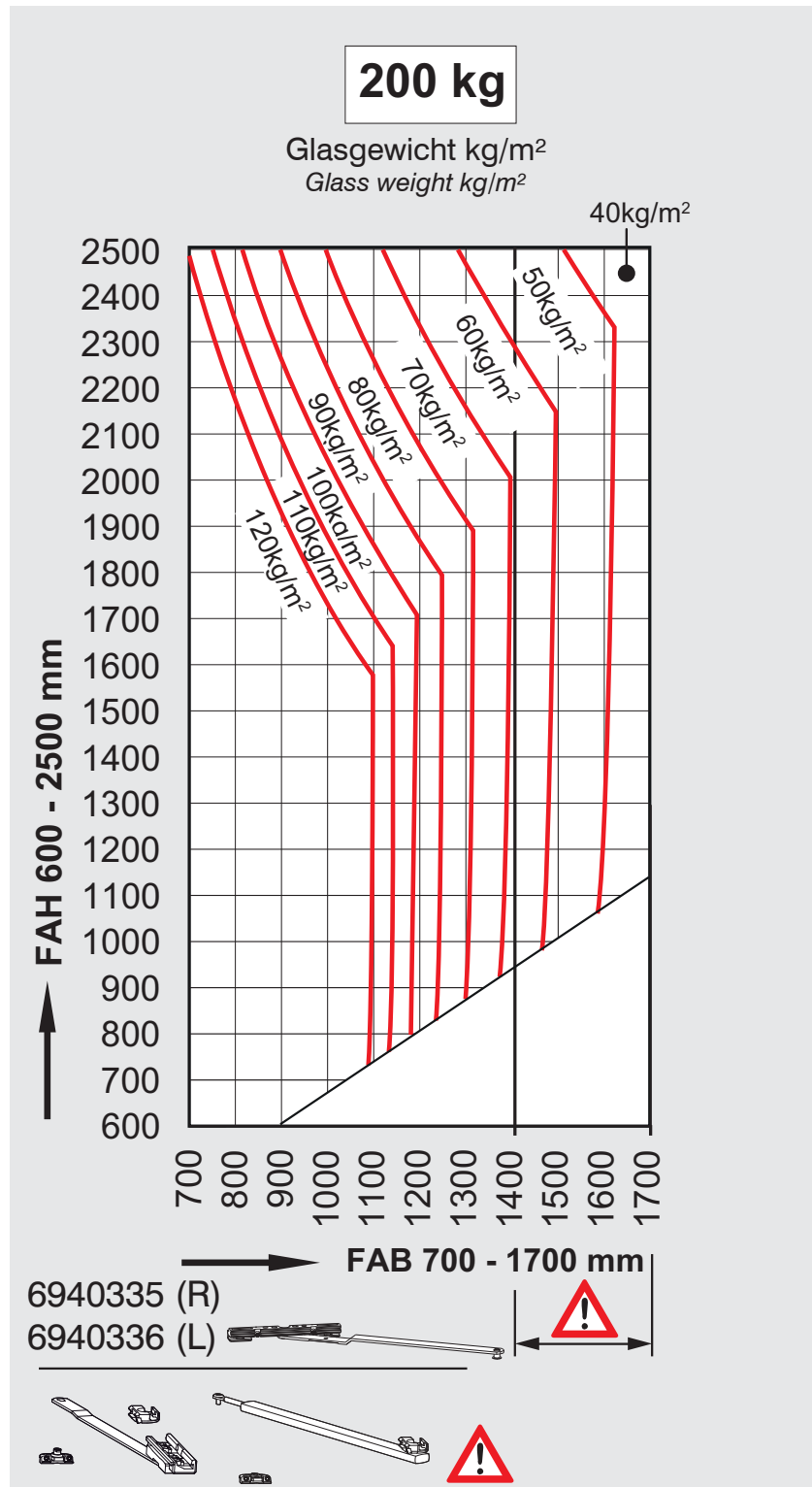

WICLINE

Zulässige Formatgrößen, aufliegende Beschläge
Admissible format sizes, top mounted fittings



WICSTAR

Flügelgewicht max. 80 kg
Sash weight max. 80 kg

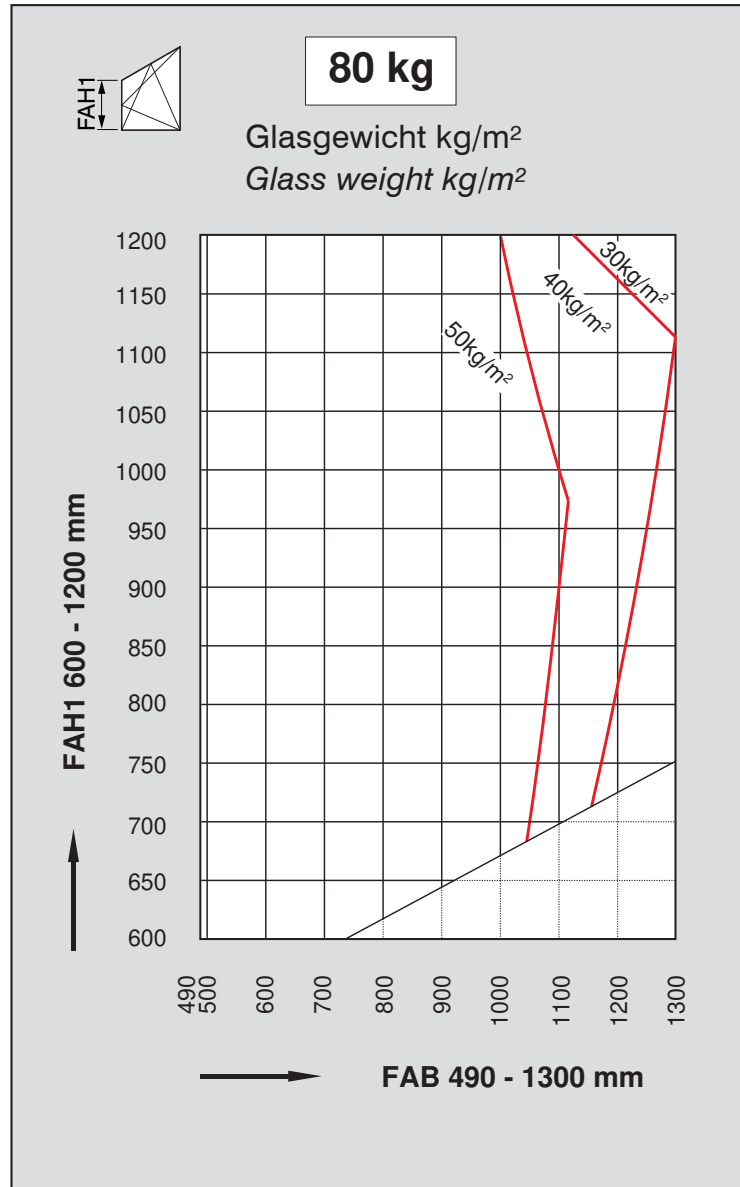

Zulässige Formatgrößen, aufliegende Beschläge
Admissible format sizes, top mounted fittings

WICSTAR

Flügelgewicht max. 200 kg
Sash weight max. 200 kg



Die Befestigung der Blendrahmenbänder erfordert Rahmenprofile mit einer Kammerhöhe ≥ 28 mm (z.B. 1916004)
The fixation of the hinges require frame profiles with a chamber height of 28 mm or higher (e.g. 1916004)

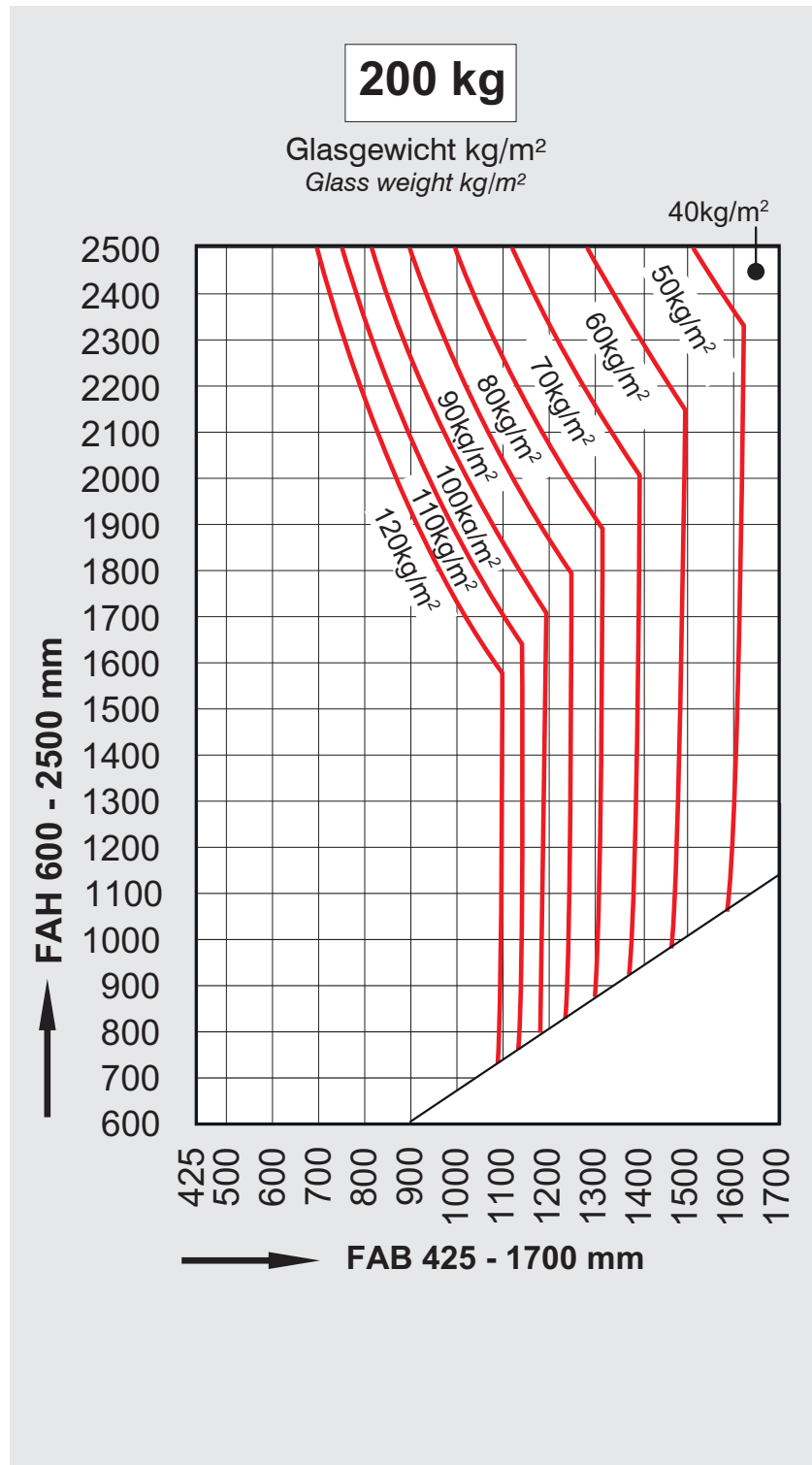

Zulässige Formatgrößen, aufliegende Beschläge
Admissible format sizes, top mounted fittings



WICSTAR

Flügelgewicht max. 130 kg
Sash weight max. 130 kg

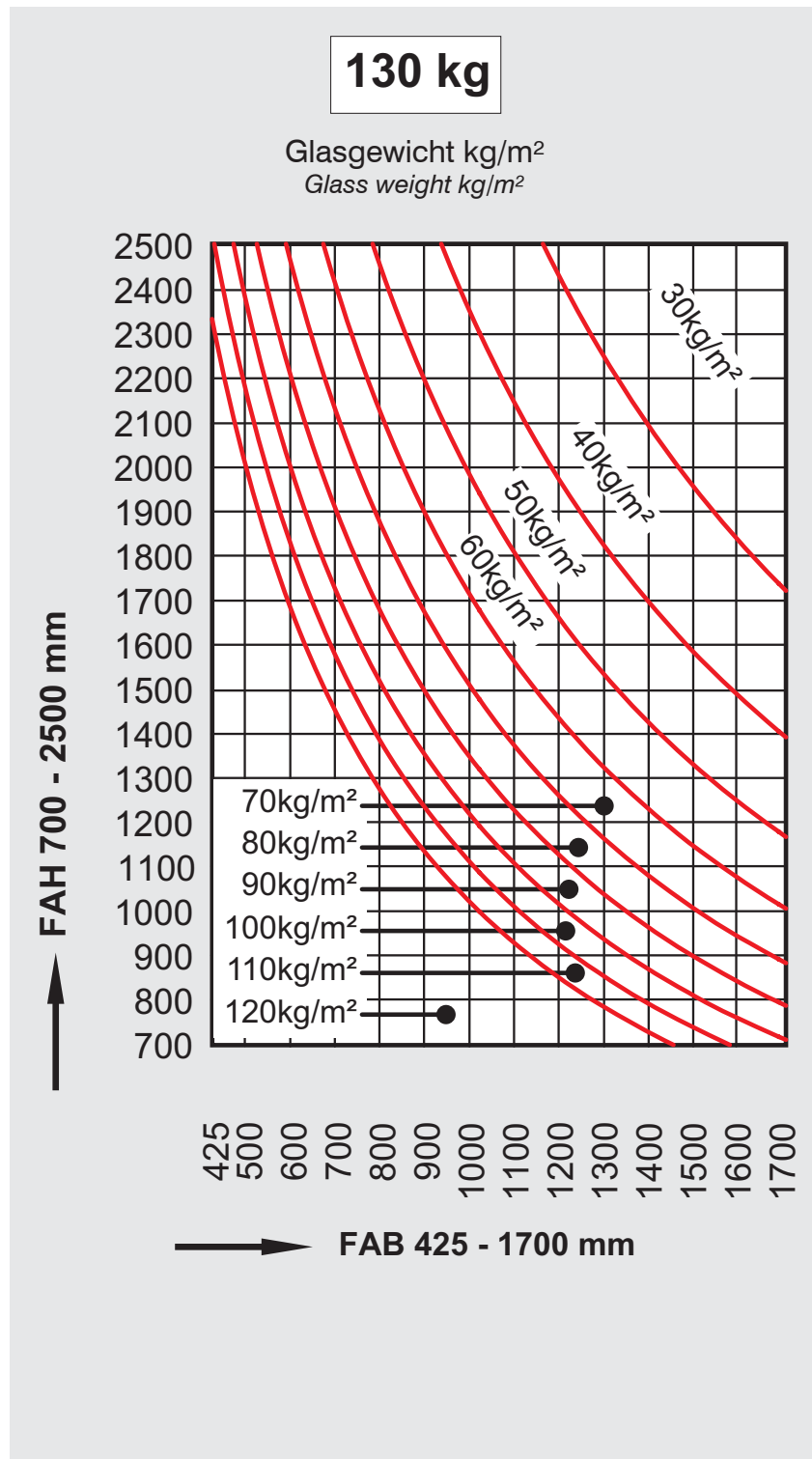

Zulässige Formatgrößen, aufliegende Beschläge
Admissible format sizes, top mounted fittings



WICSTAR

Flügelgewicht max. 130 kg
Sash weight max. 130 kg

130 kg

Glasgewicht kg/m²
Glass weight kg/m²

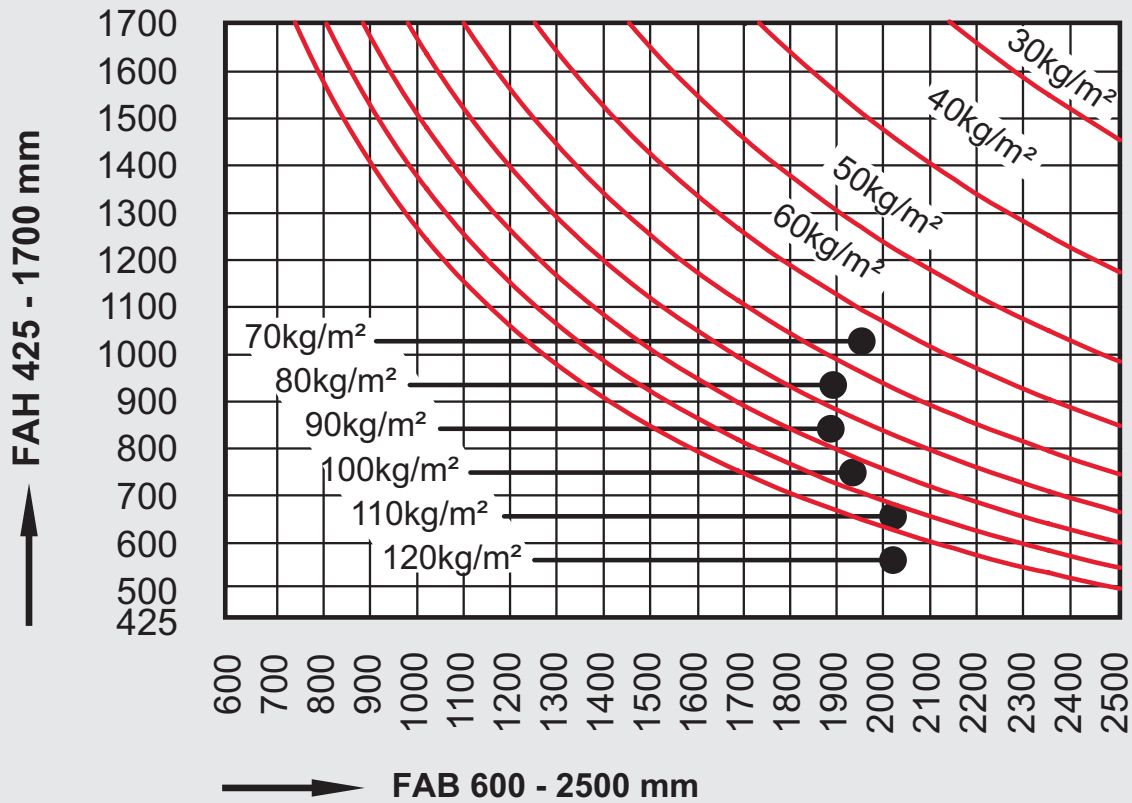

Zulässige Formatgrößen, aufliegende und verdeckte Beschläge
Admissible format sizes, top mounted and concealed fittings



WICSTAR

Flügelgewicht max. 80 kg
Sash weight max. 80 kg

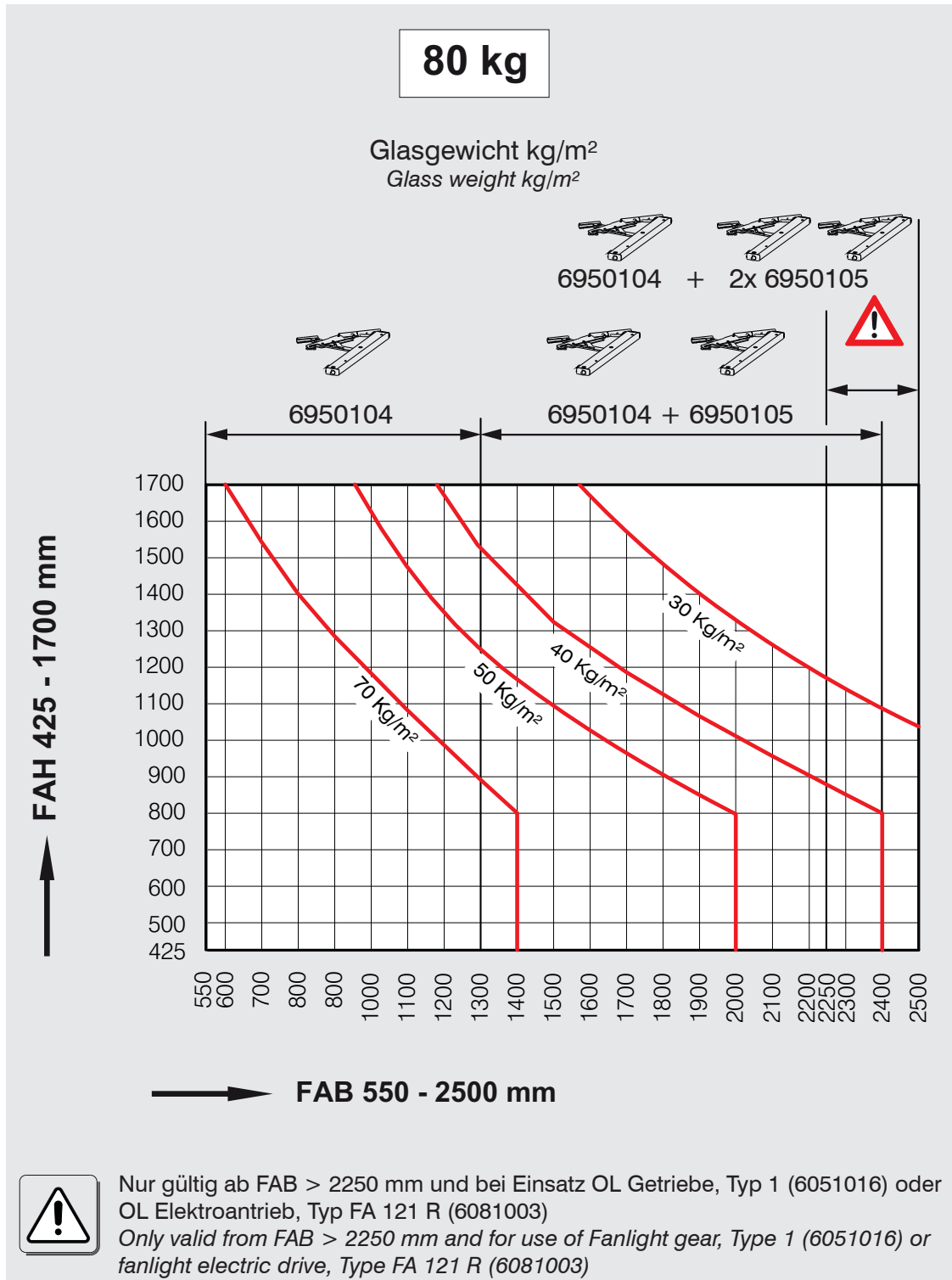

Zulässige Formatgrößen, aufliegende und verdeckte Beschläge
Admissible format sizes, top mounted and concealed fittings



WICSTAR

Flügelgewicht max. 120 kg mit Spindelgetriebe
Sash weight max. 120 kg with spindle gear

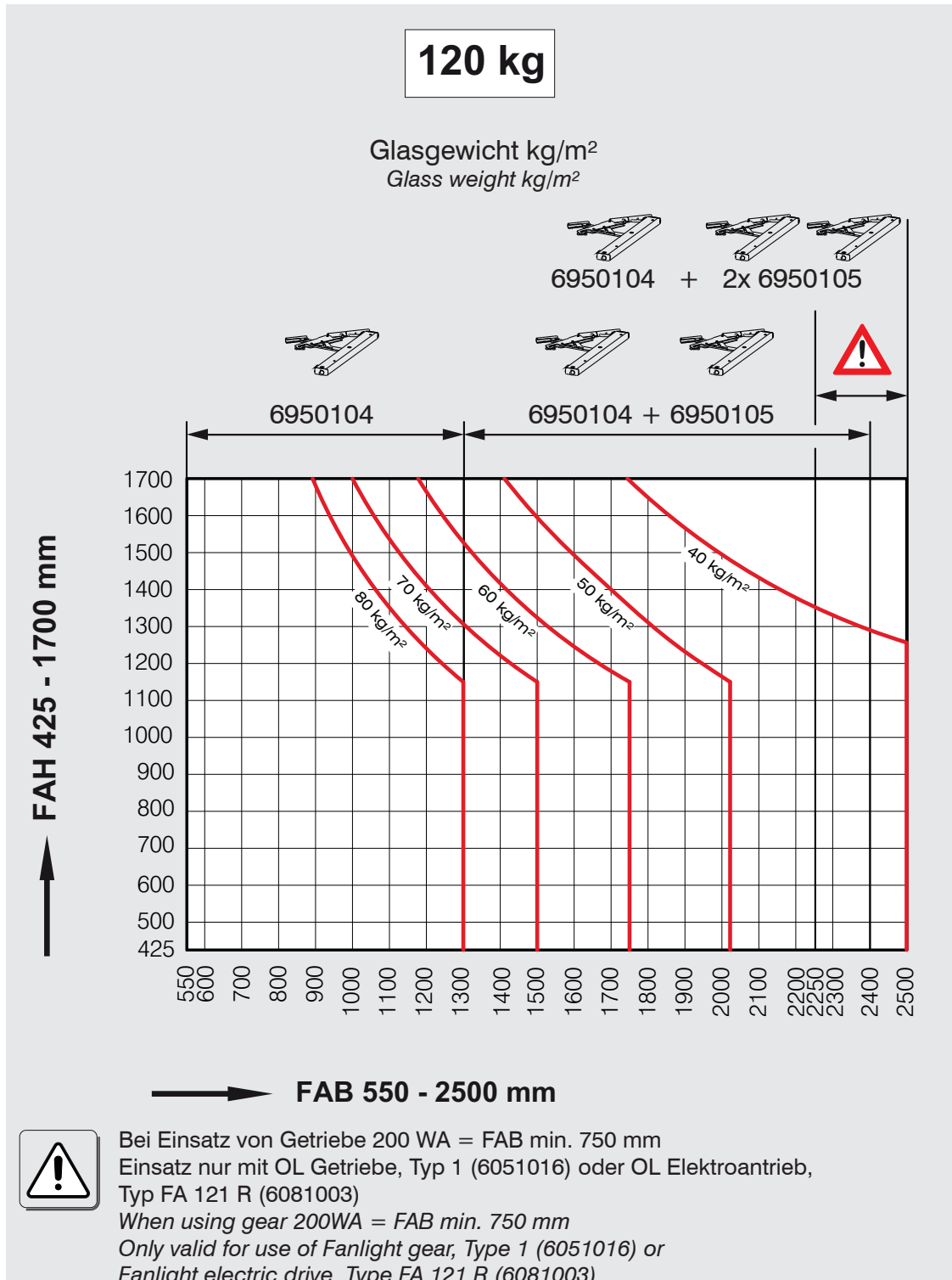

Zulässige Formatgrößen, aufliegende und verdeckte Beschläge
Admissible format sizes, top mounted and concealed fittings



WICSTAR

Flügelgewicht max. 120 kg mit Elektroantrieb
Sash weight max. 120 kg with electric drive

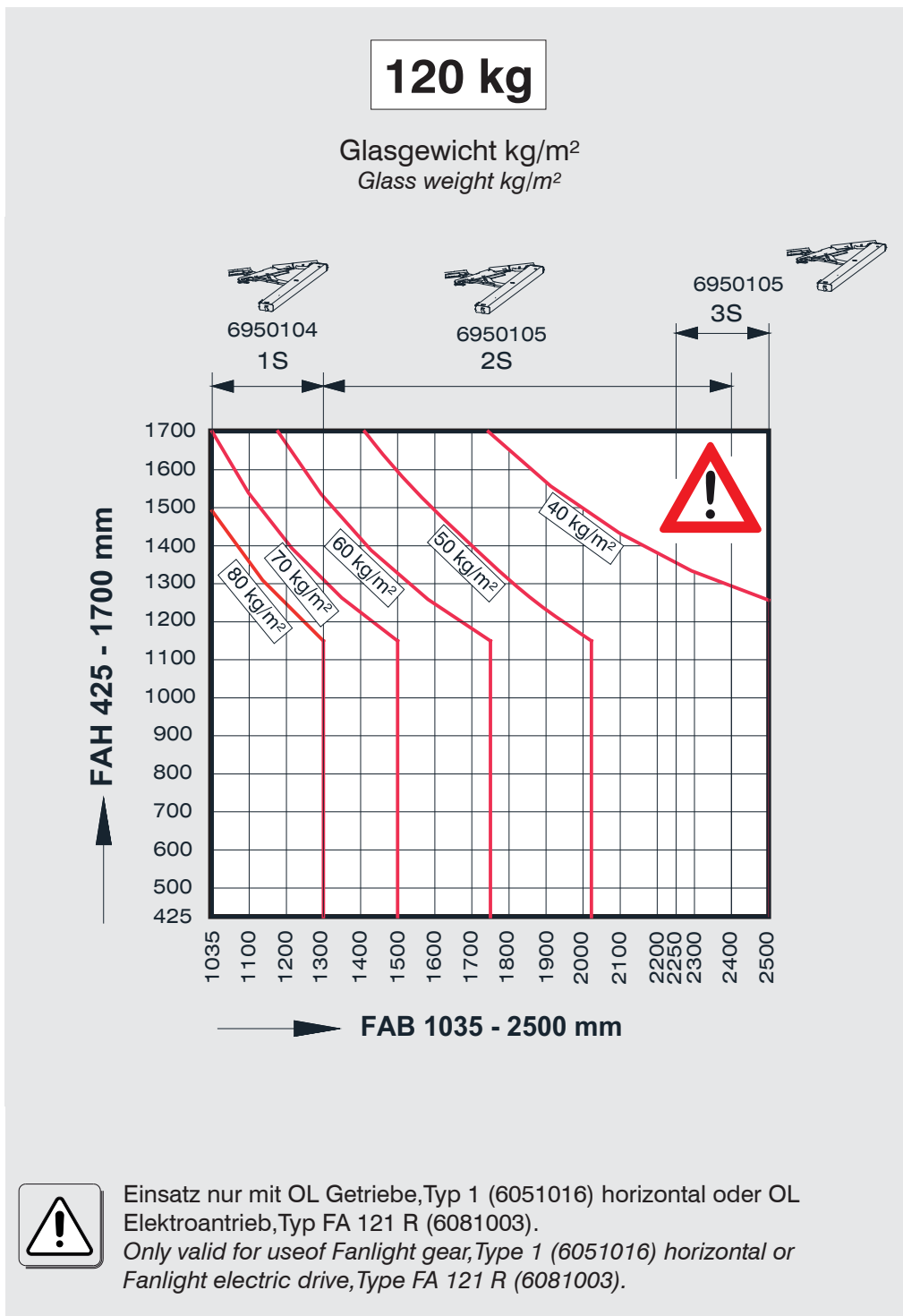

Zulässige Formatgrößen, aufliegende und verdeckte Beschläge
Admissible format sizes, top mounted and concealed fittings



WICSTAR

Flügelgewicht max. 80 kg
Einbruchhemmung RC 1N / RC 2N / RC 2
Sash weight max. 80 kg
Burglar resistance RC 1N / RC 2N / RC 2

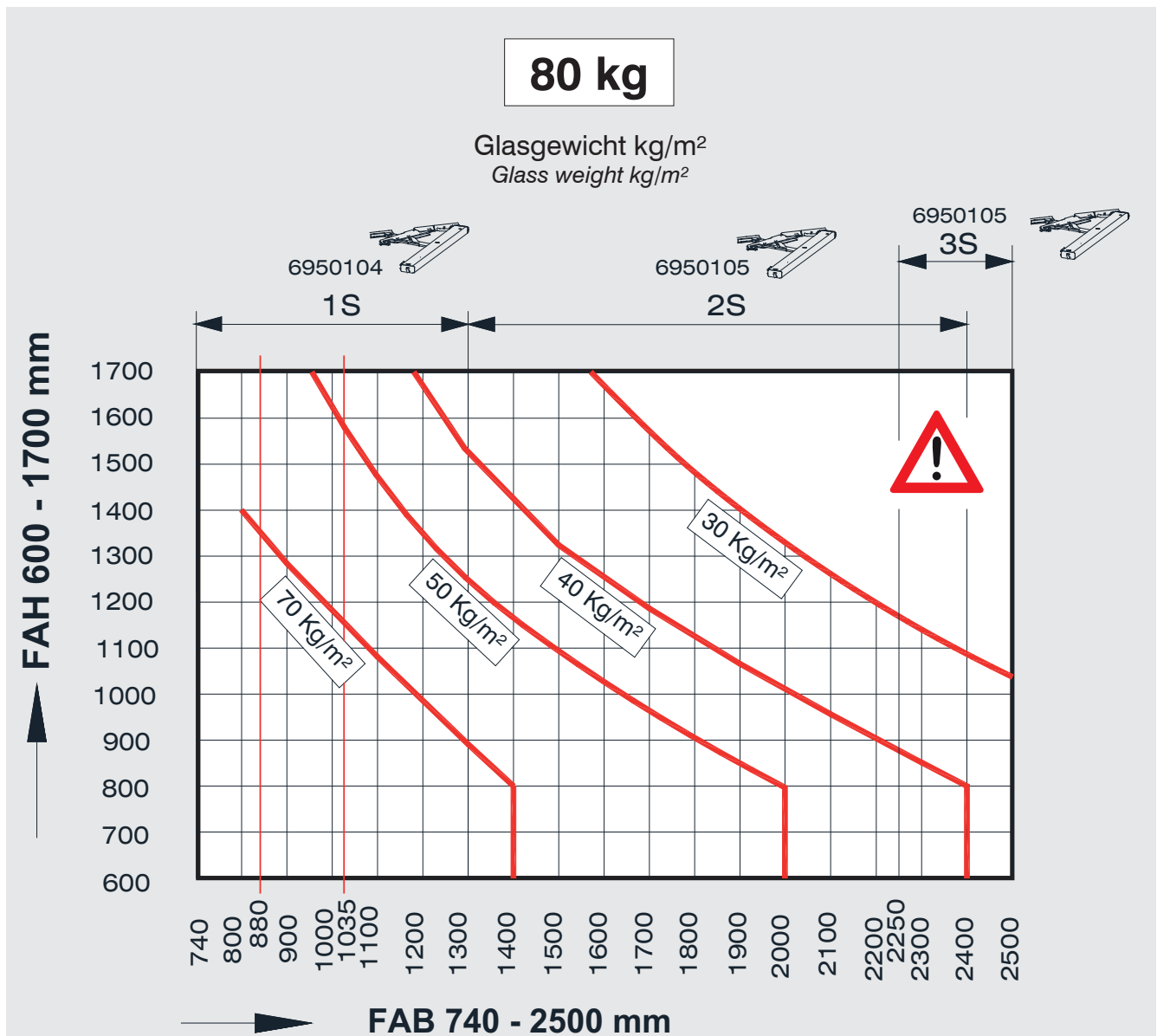

Bei Einsatz von Getriebe 200WA = FAB min. 880 mm; bei Elektroantrieb = FAB min. 1035 mm.
When using gear 200WA = FAB min. 880 mm; with electric drive = FAB min. 1035 mm.

Nur gültig ab FAB > 2250 mm und bei Einsatz OL Getriebe, Typ 1 (6051016) oder OL Elektroantrieb, Typ FA 121 R (6081003).

Flügelgewichte > 80kg nur in Verbindung mit Beschlageinbauplan 45401 (OL Getriebe, Typ 1) und 45601 (OL Elektroantrieb, Typ FA 121 R).

Only valid from FAB > 2250 mm and for use of fanlight gear, Type 1 (6051016) or fanlight electric drive, Type FA 121 R (6081003).

Sash weight > 80kg only in connection with fitting installation plan 45401 (fanlight gear, Type 1) and 45601 (fanlight electric drive, Type FA 121R).

Zulässige Formatgrößen, aufliegende und verdeckte Beschläge
Admissible format sizes, top mounted and concealed fittings



WICSTAR

Flügelgewicht max. 80 kg

Einbruchhemmung RC 3

Sash weight max. 80 kg

Burglar resistance RC 3

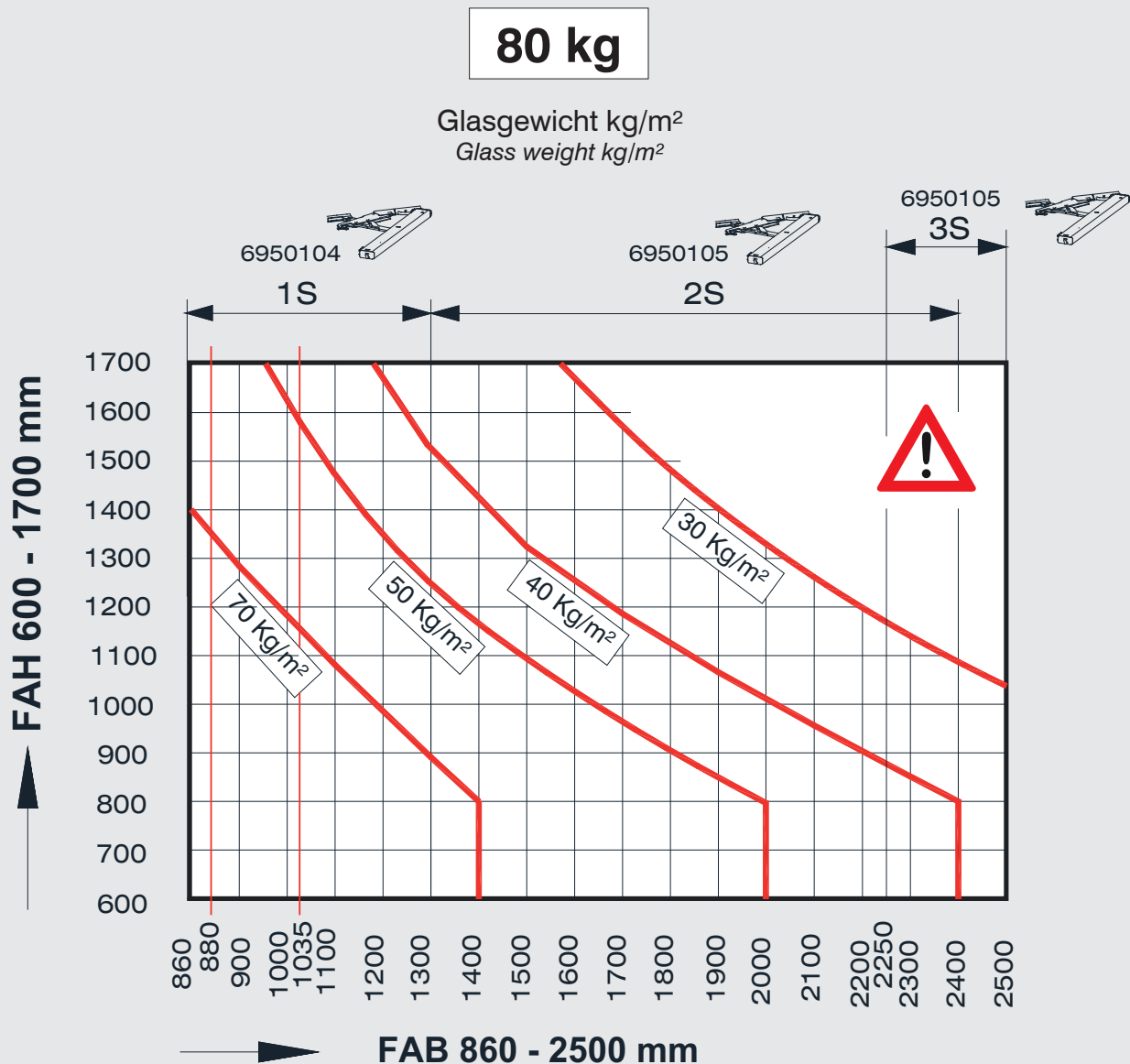

Bei Einsatz von Getriebe 200WA = FAB min. 880 mm; bei Elektroantrieb = FAB min. 1035 mm.
When using gear 200WA = FAB min. 880 mm; with electric drive = FAB min. 1035 mm.

Nur gültig ab FAB > 2250 mm und bei Einsatz OL Getriebe, Typ 1 (6051016) oder OL Elektroantrieb, Typ FA 121 R (6081003).

Flügelgewichte > 80kg nur in Verbindung mit Beschlageinbauplan 45401 (OL Getriebe, Typ 1) und 45601 (OL Elektroantrieb, Typ FA 121 R).

Only valid from FAB > 2250 mm and for use of fanlight gear, Type 1 (6051016) or fanlight electric drive, Type FA 121 R (6081003).

Sash weight > 80kg only in connection with fitting installation plan 45401 (fanlight gear, Type 1) and 45601 (fanlight electric drive, Type FA 121R).

Zulässige Formatgrößen, aufliegende und verdeckte Beschläge
Admissible format sizes, top mounted and concealed fittings



WICSTAR

Flügelgewicht max. 120 kg

Oberlicht-Schrägfenster

Sash weight max. 120 kg

Fanlight sloped window

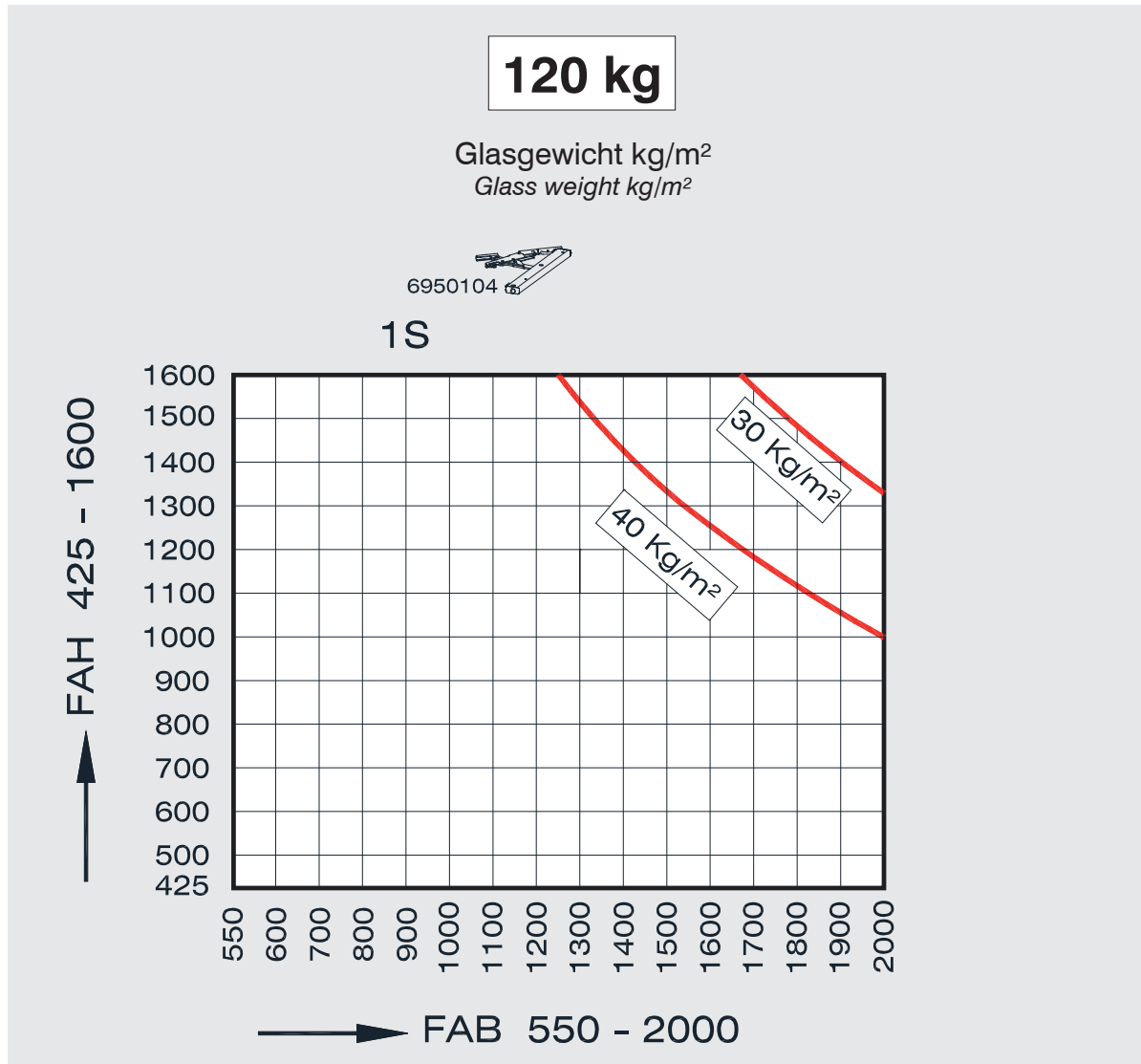

WICLINE 75 TOP

Grundbeschlag
Basic fitting

Beschläge
Fittings



Dreh-Kipp-Beschlag Turn/tilt fitting

Griff Stellungen
Handle position

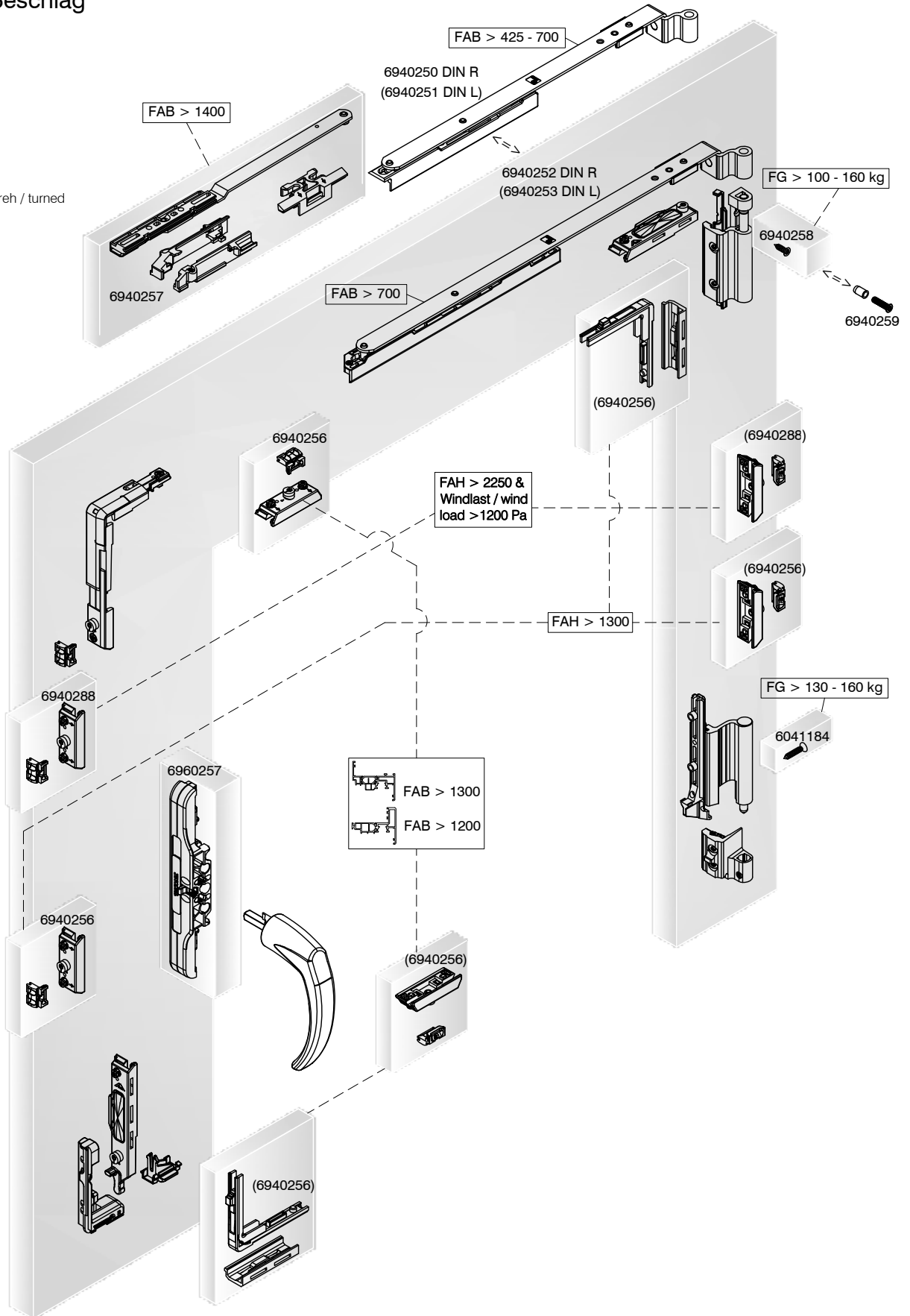
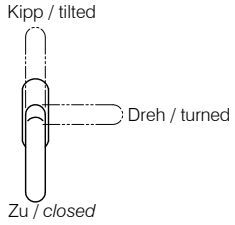



Dreh-Kipp-Beschlag 200 kg Turn/tilt fitting 200 kg

Griff Stellungen
Handle position

Kipp / tilted

Dreh / turned

Zu / closed

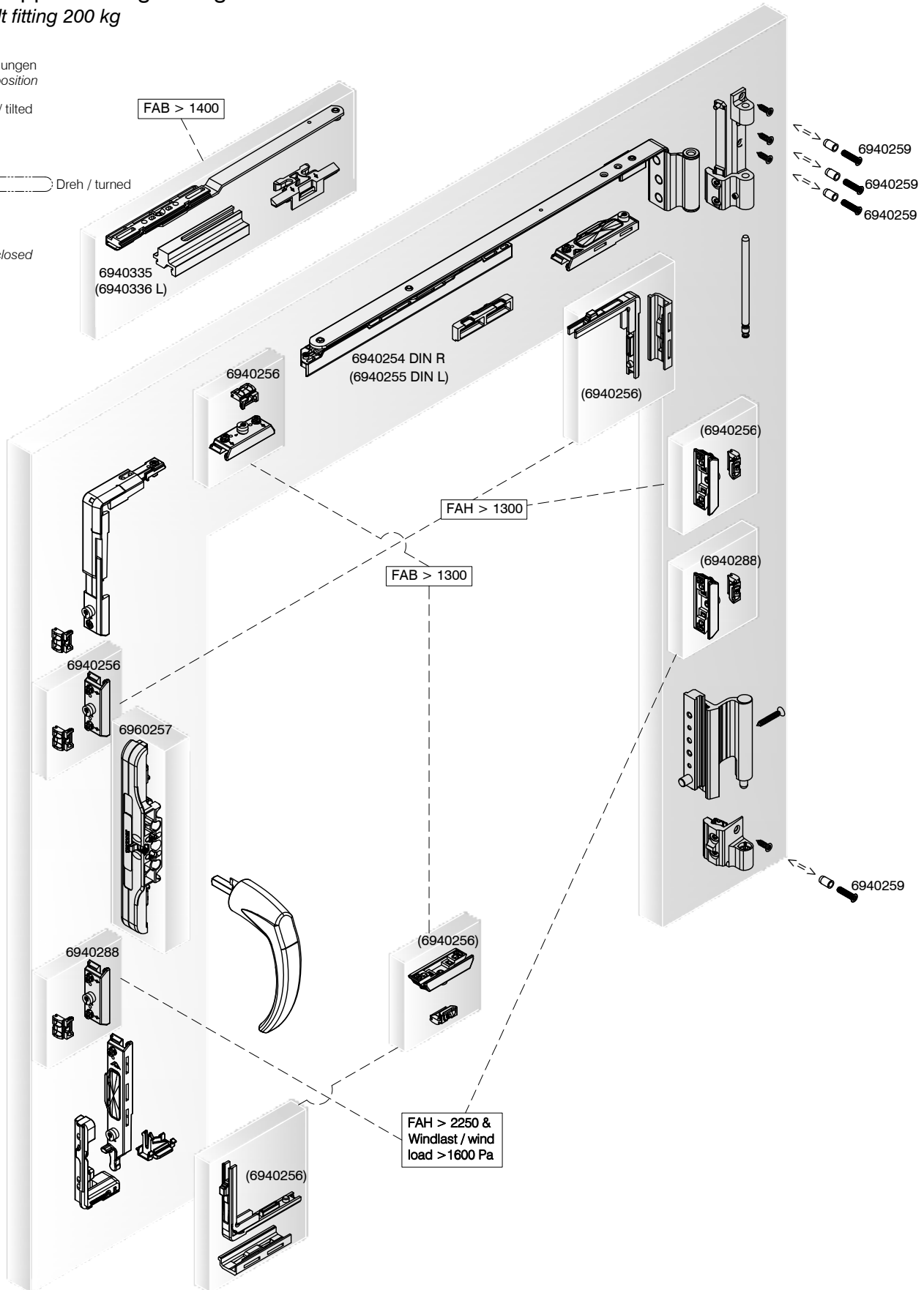

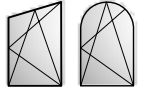

Schräg / Rundbogen-Beschlag Sloped / arched fitting

Griff Stellungen
Handle position

Kipp / tilted



Dreh / turned



Zu / closed

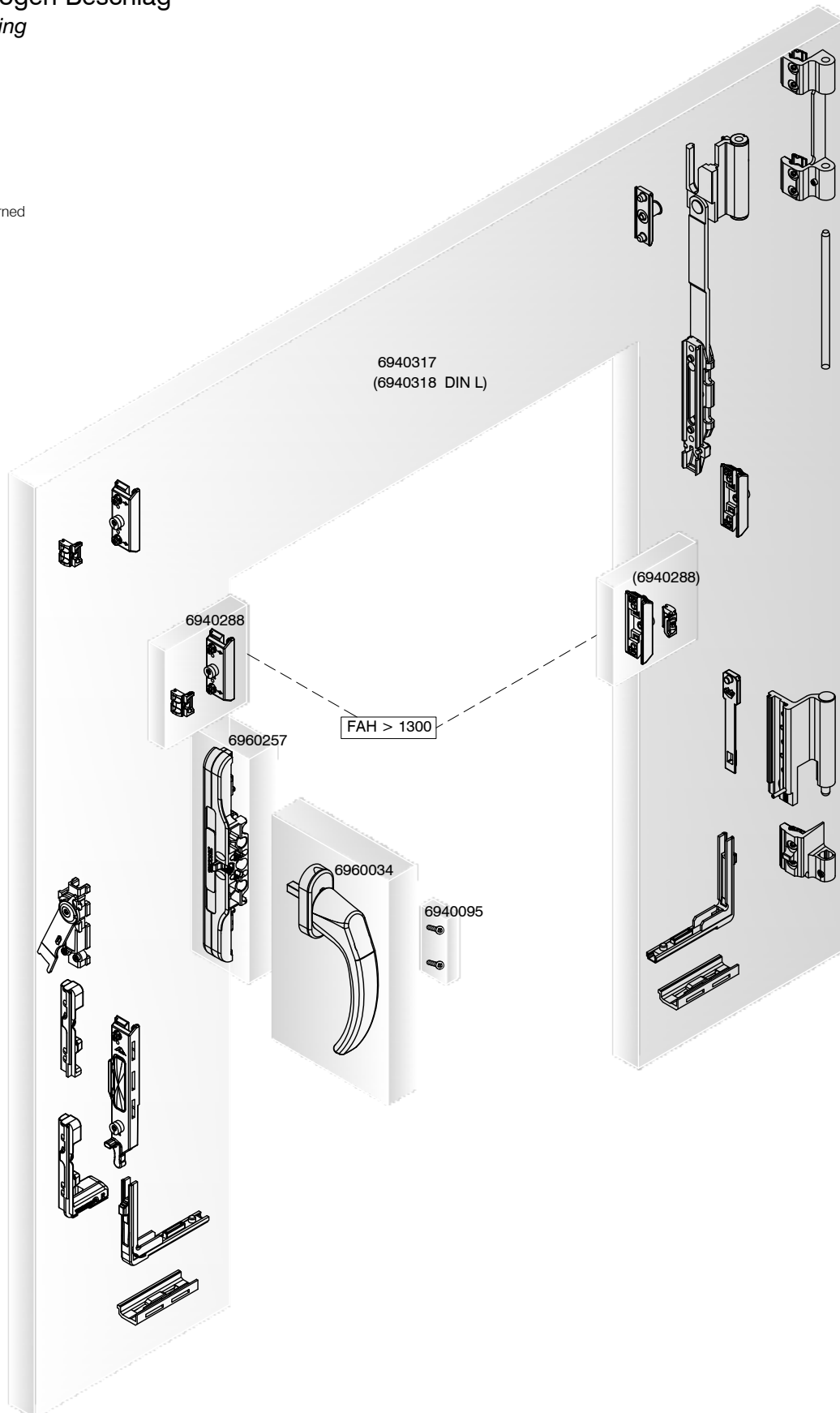

WICLINE 75 TOP

Grundbeschlag
Basic fitting

Beschläge
Fittings



Tilt-First-Beschlag Tilt-first fitting

Griff Stellungen
Handle position

Dreh / turned



Kipp / tilted

Zu / closed

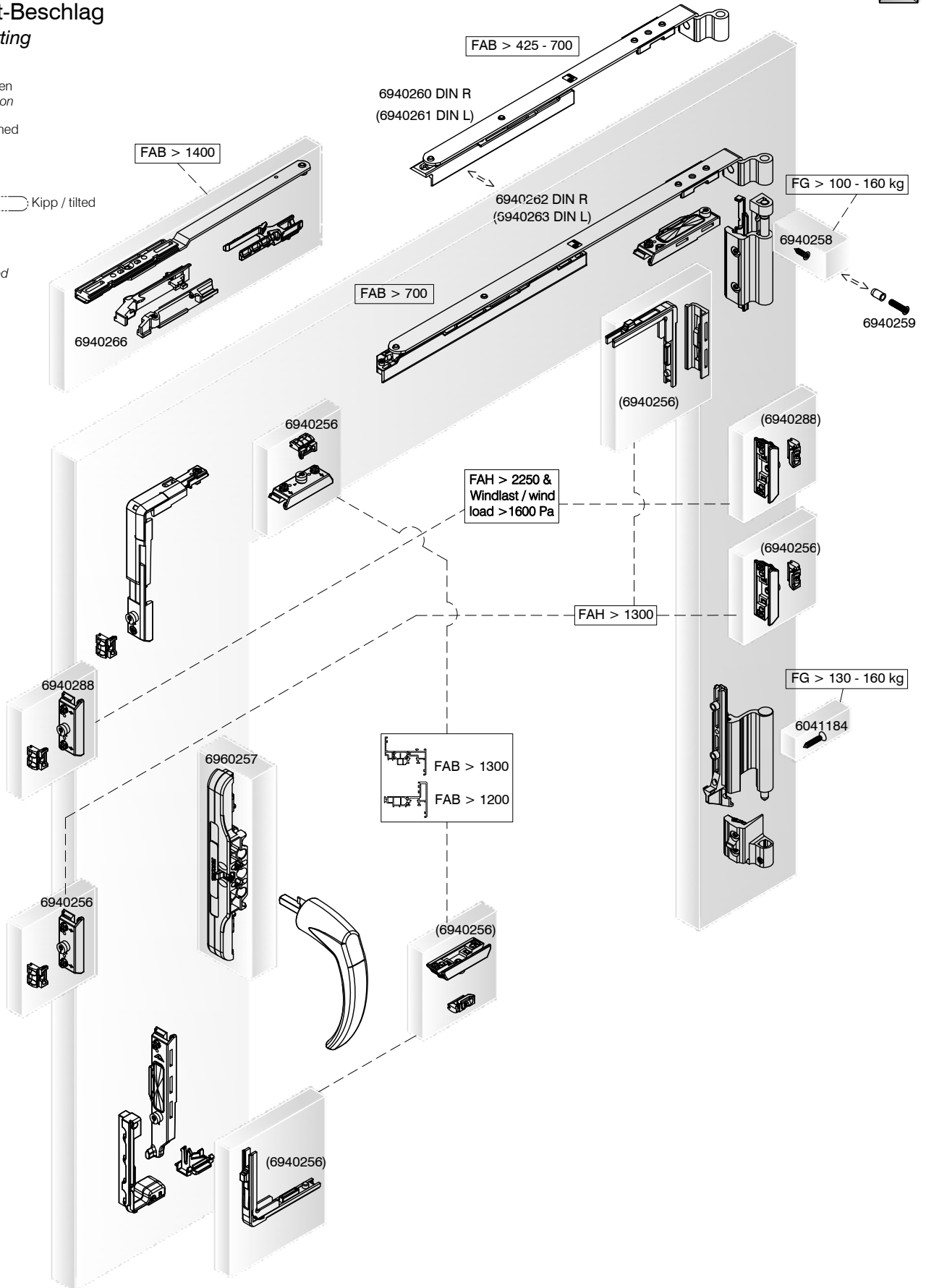

WICLINE 75 TOP

Grundbeschlag
Basic fitting

Beschläge
Fittings



Dreh-Beschlag
Turn fitting

Griff Stellungen
Handle position

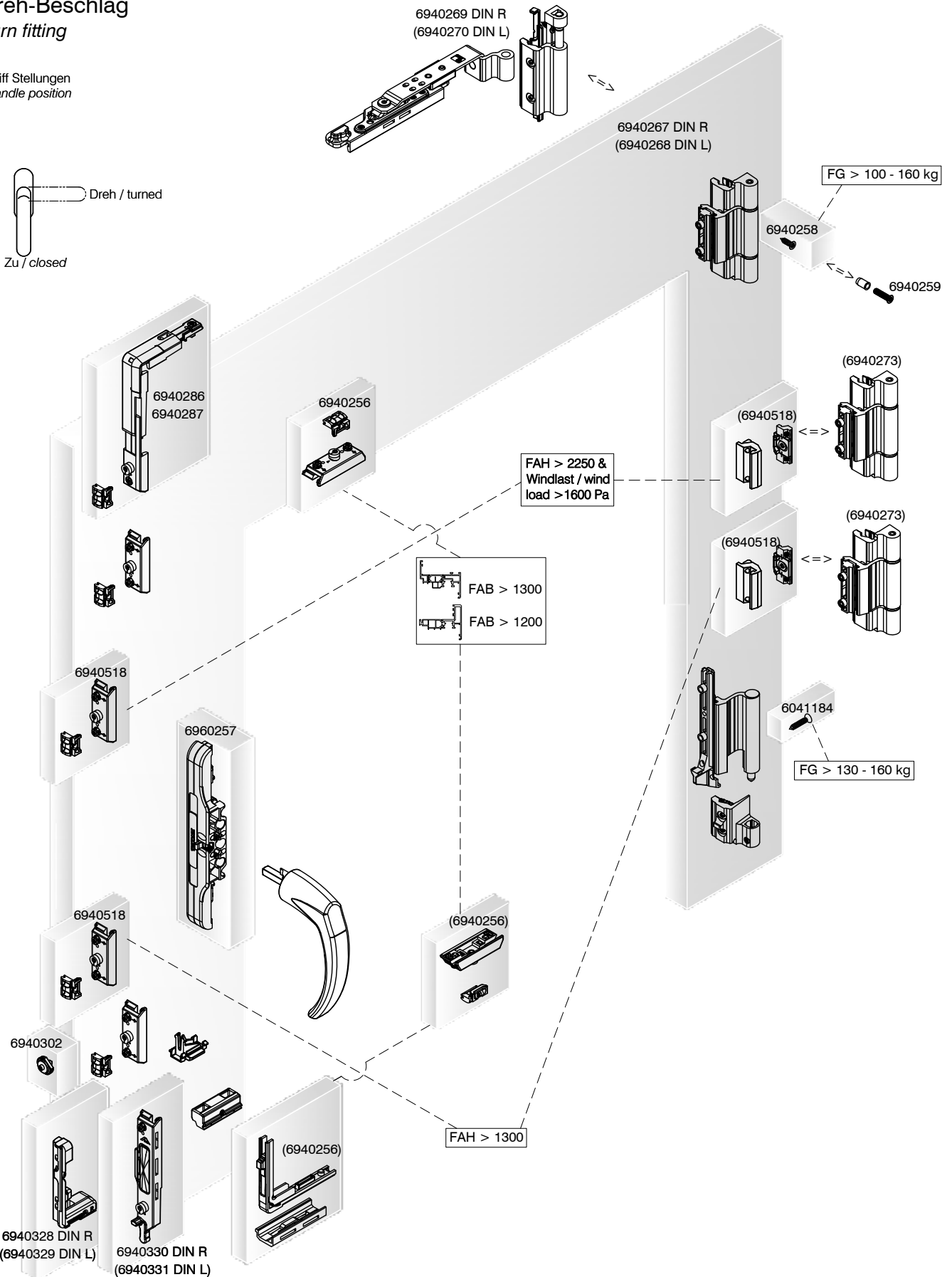
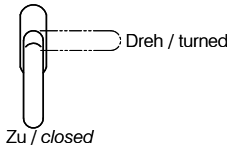

WICLINE

Grundbeschlag
Basic fitting

Beschläge Fittings



Dreh-Beschlag 200 kg
Turn fitting 200 kg

Griff Stellungen
Handle position

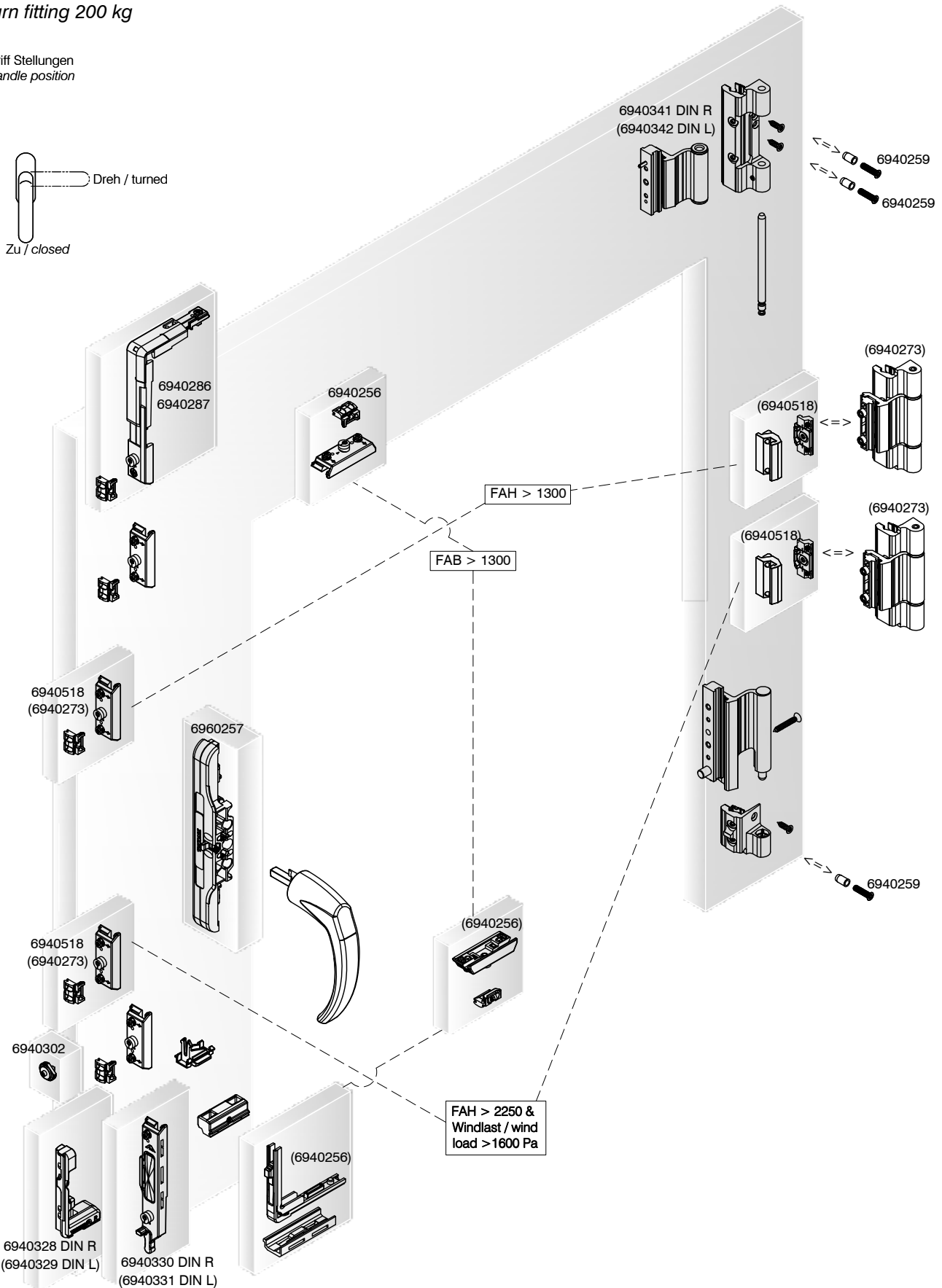
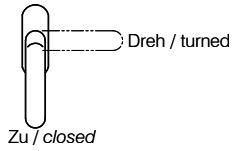

WICLINE 75 TOP

Grundbeschlag
Basic fitting

Beschläge Fittings

Stulp-Beschlag 130 kg mit Kniehebel Double casement door fitting 130 kg with toggle lever

Kniehebel Stellungen
Toggle lever position

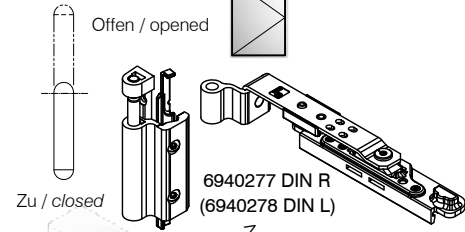

Griff Stellungen
Handle position

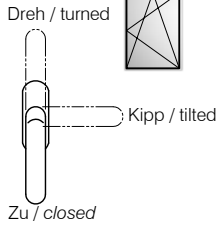

Standflügel DIN L
Inactive sash DIN L

Gehflügel DIN R
Active sash DIN R

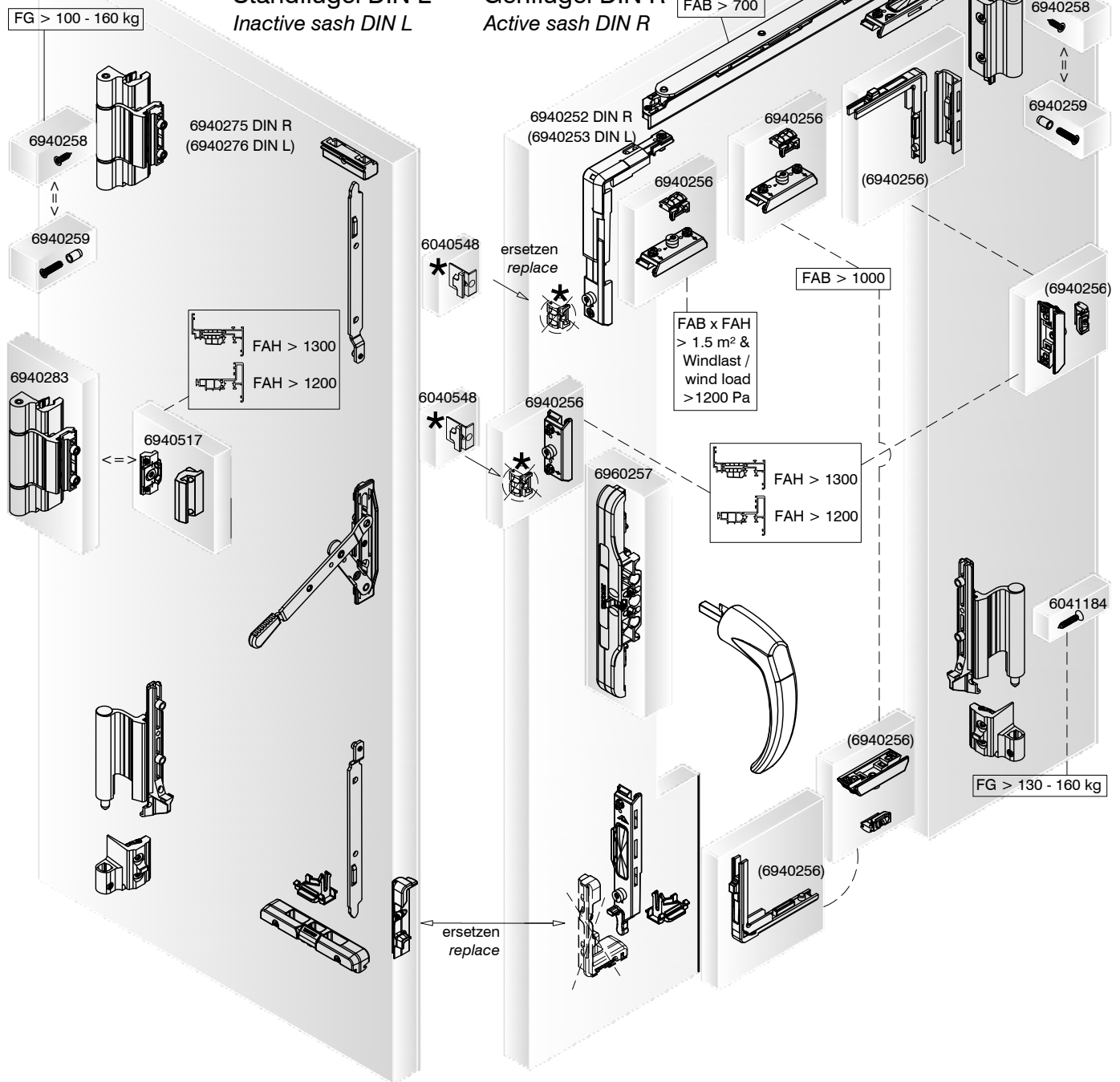

WICLINE 75 TOP

Grundbeschlag
Basic fitting

Beschläge Fittings

Stulp-Beschlag 130 kg mit Kniehebel Double casement door fitting 130 kg with toggle lever

Kniehebel Stellungen
Toggle lever position

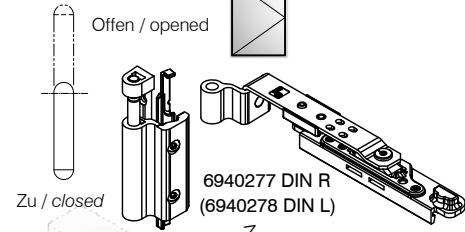

Griff Stellungen
Handle position

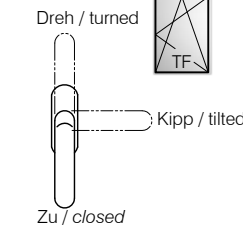

Standflügel DIN L
Inactive sash DIN L

Gehflügel DIN R
Active sash DIN R

FG > 100 - 160 kg

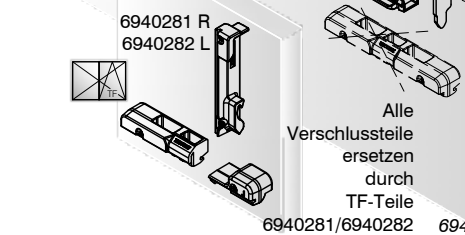
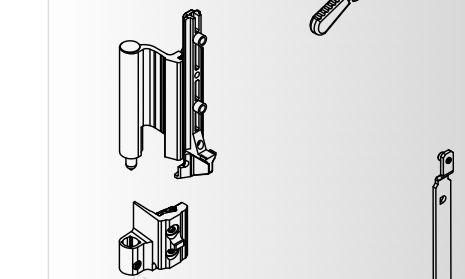
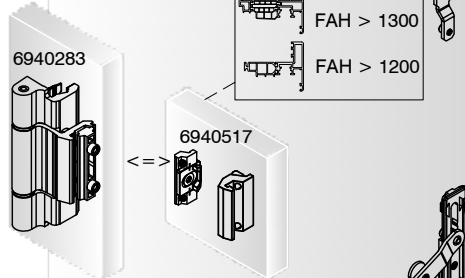
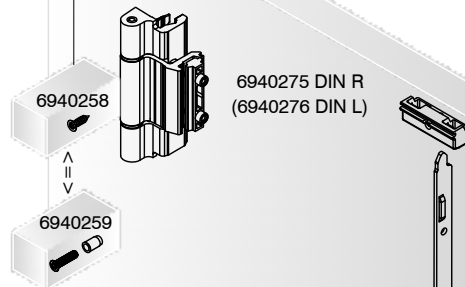

Replace all locking pieces by TF-items 6940281/6940282

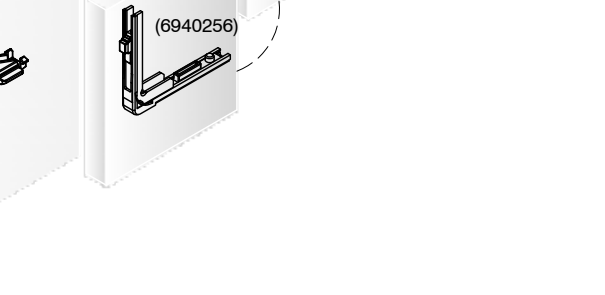
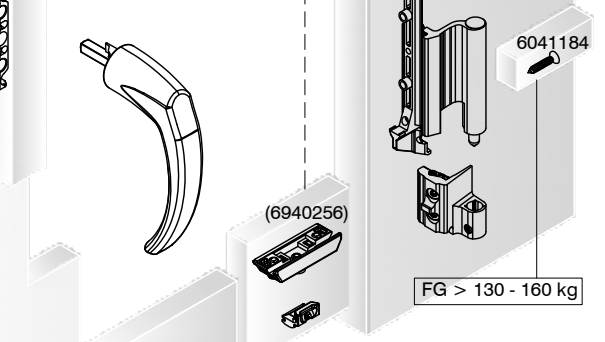
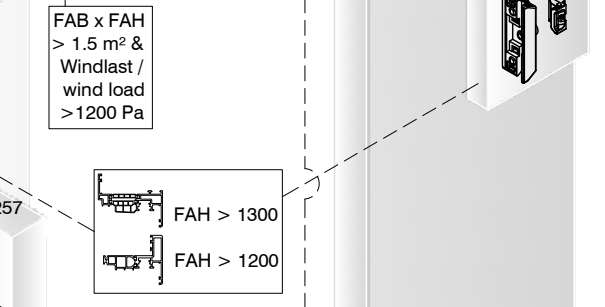
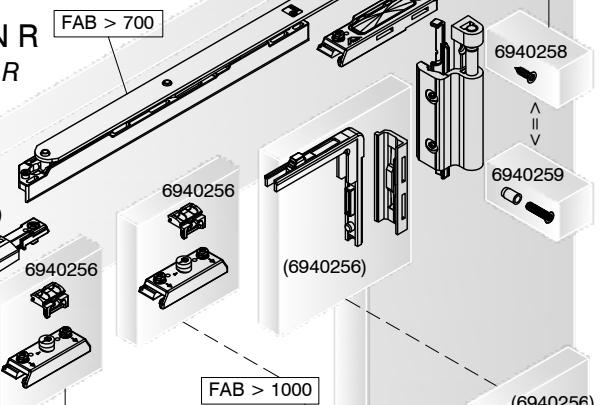
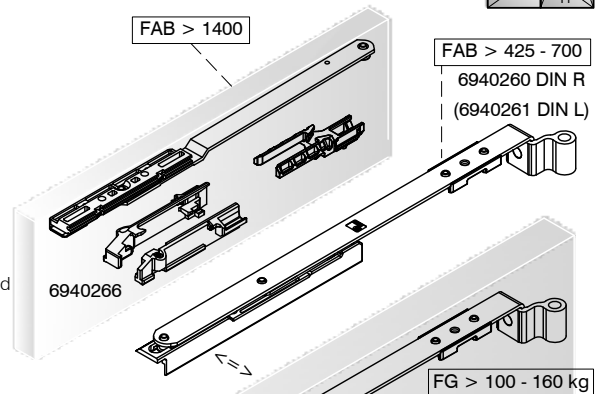

WICLINE 75 TOP

Grundbeschlag
Basic fitting

Beschläge
Fittings

Stulp-Beschlag 130 kg mit Kniehebel Double casement door fitting 130 kg with toggle lever

Kniehebel Stellungen
Toggle lever position

Griff Stellungen
Handle position

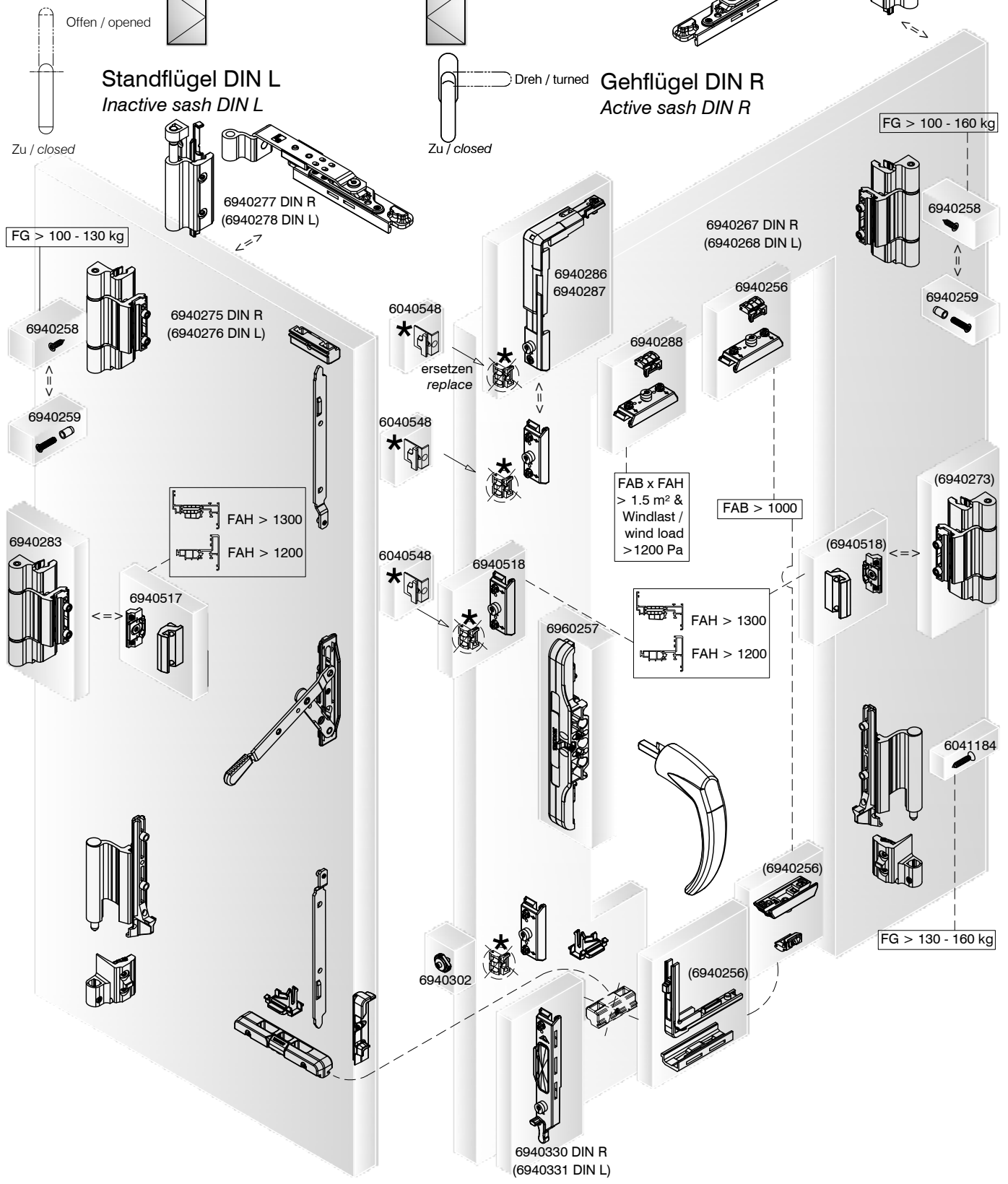
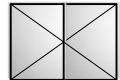

Stulp-Beschlag 160 kg mit Stulpgetriebe Double casement door fitting 160 kg with double casement gear

Kniehebel Stellungen
Toggle lever position

Zu / closed

Offen / opened

Standflügel DIN L
Inactive sash DIN L

Griff Stellungen
Handle position

Dreh / turned

Kipp / tilted

Zu / closed

Gehflügel DIN R
Active sash DIN R

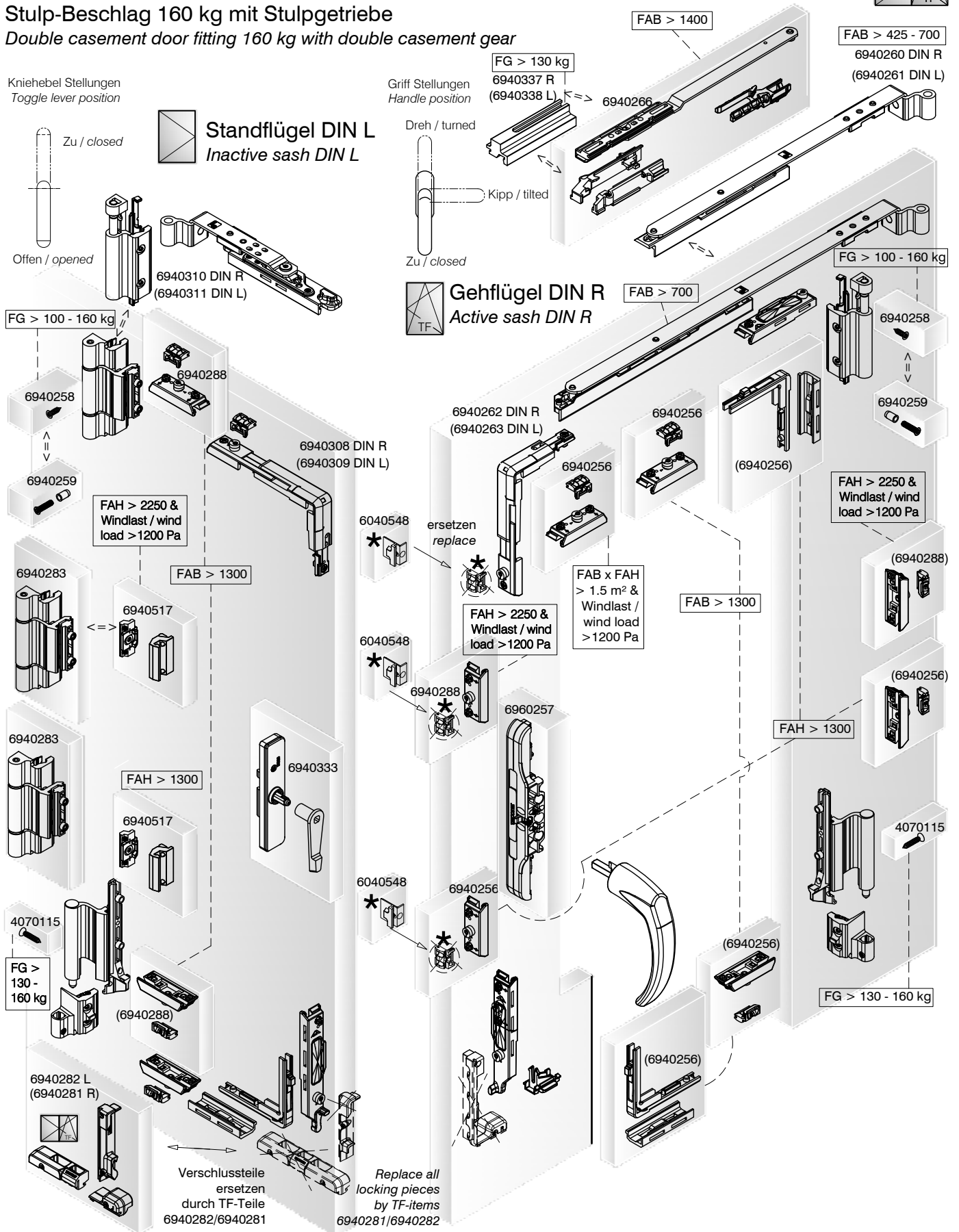

Stulp-Beschlag 160 kg mit Stulpgetriebe Double casement door fitting 160 kg with double casement gear

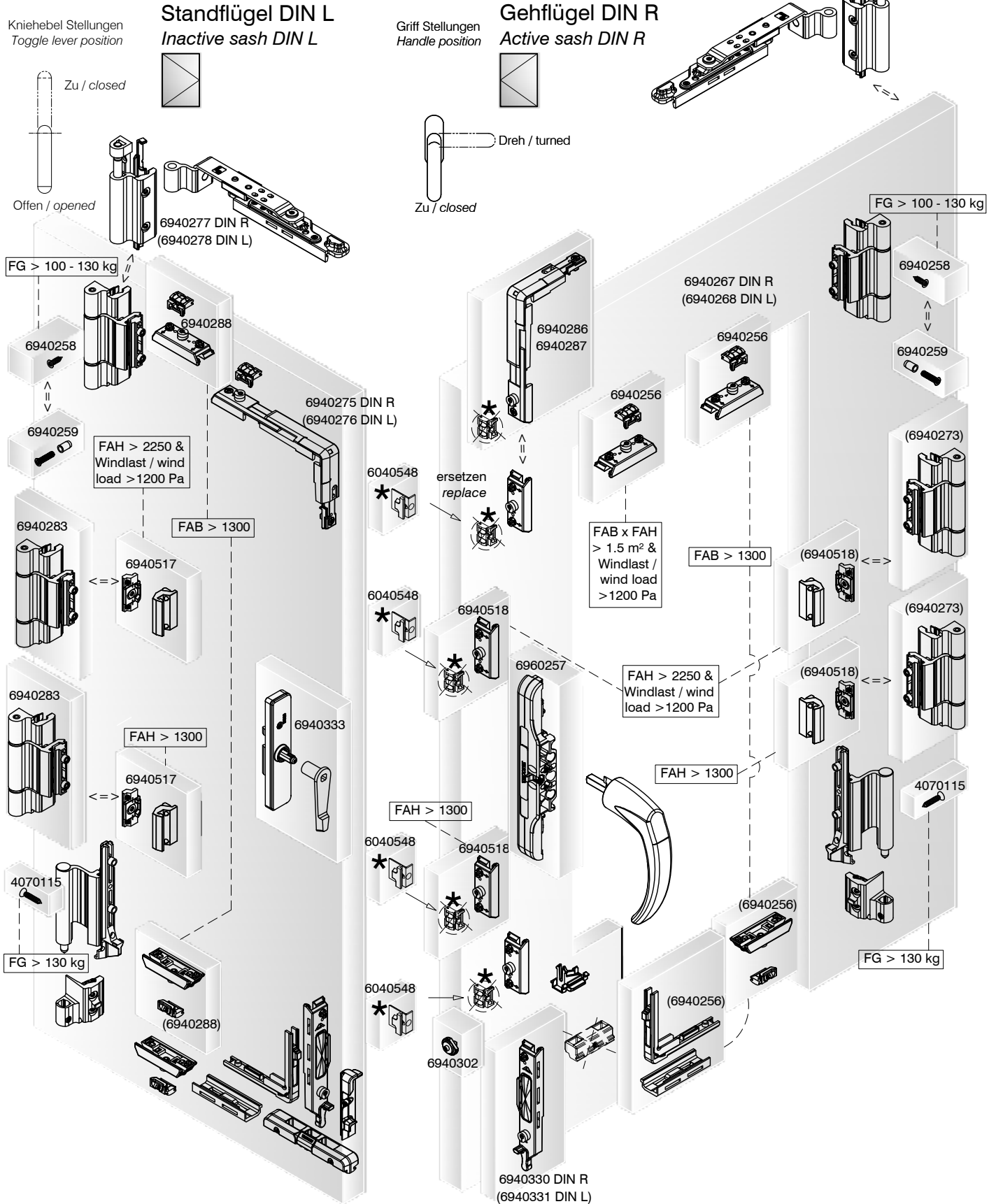

WICLINE 75 TOP

Grundbeschlag
Basic fitting

Beschläge
Fittings



Kipp-Beschlag 130 kg Querformat
Tilt fitting 130 kg landscape

Griff Stellungen
Handle position

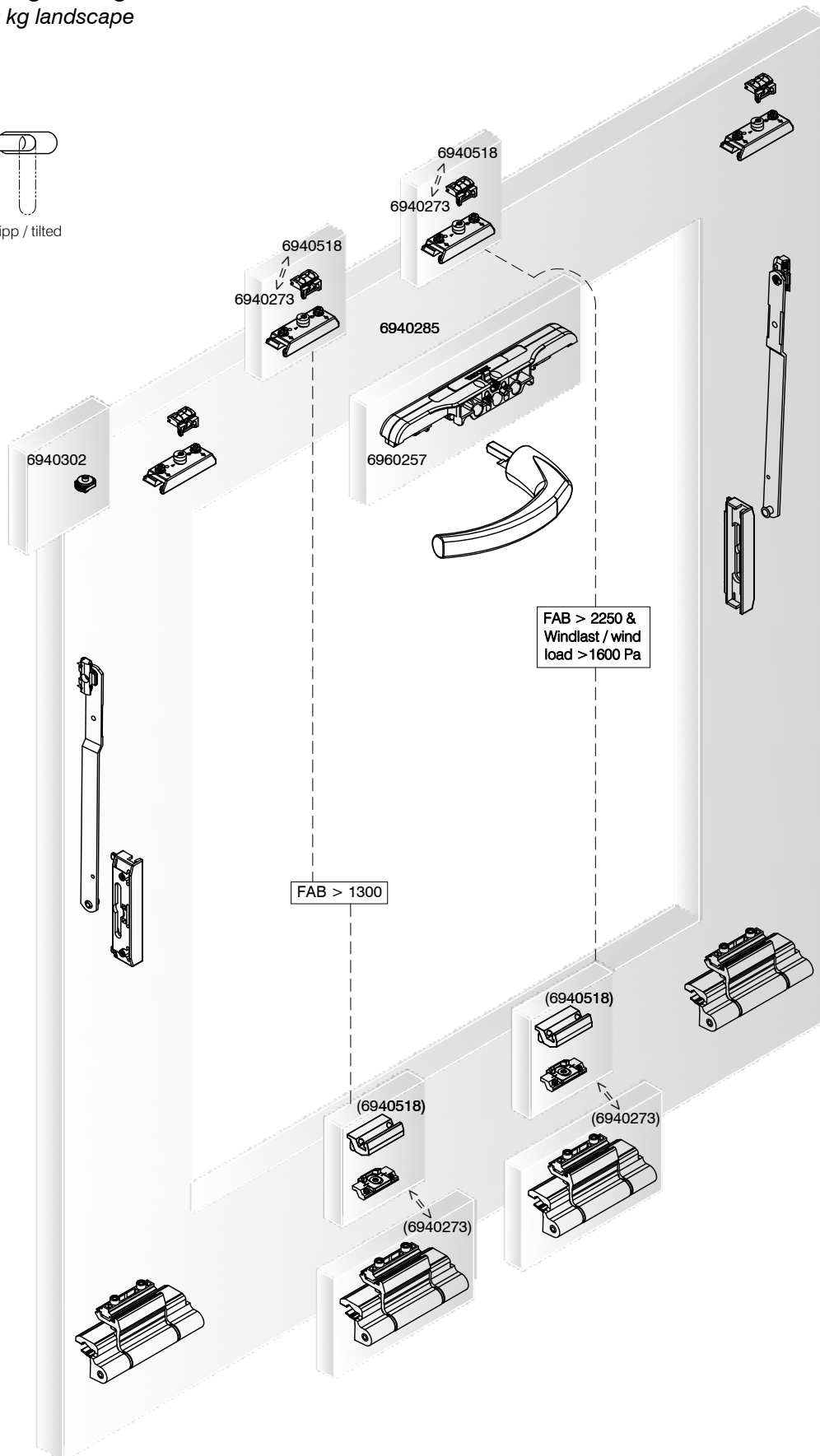
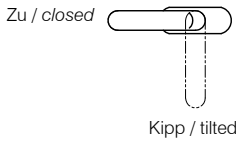

WICLINE 75 TOP

Grundbeschlag
Basic fitting

Beschläge
Fittings



Kipp-Beschlag 130 kg Querformat mit vertikalen Mittelverriegelungen Tilt fitting 130 kg landscape with vertical centre lockings

Griff Stellungen
Handle position

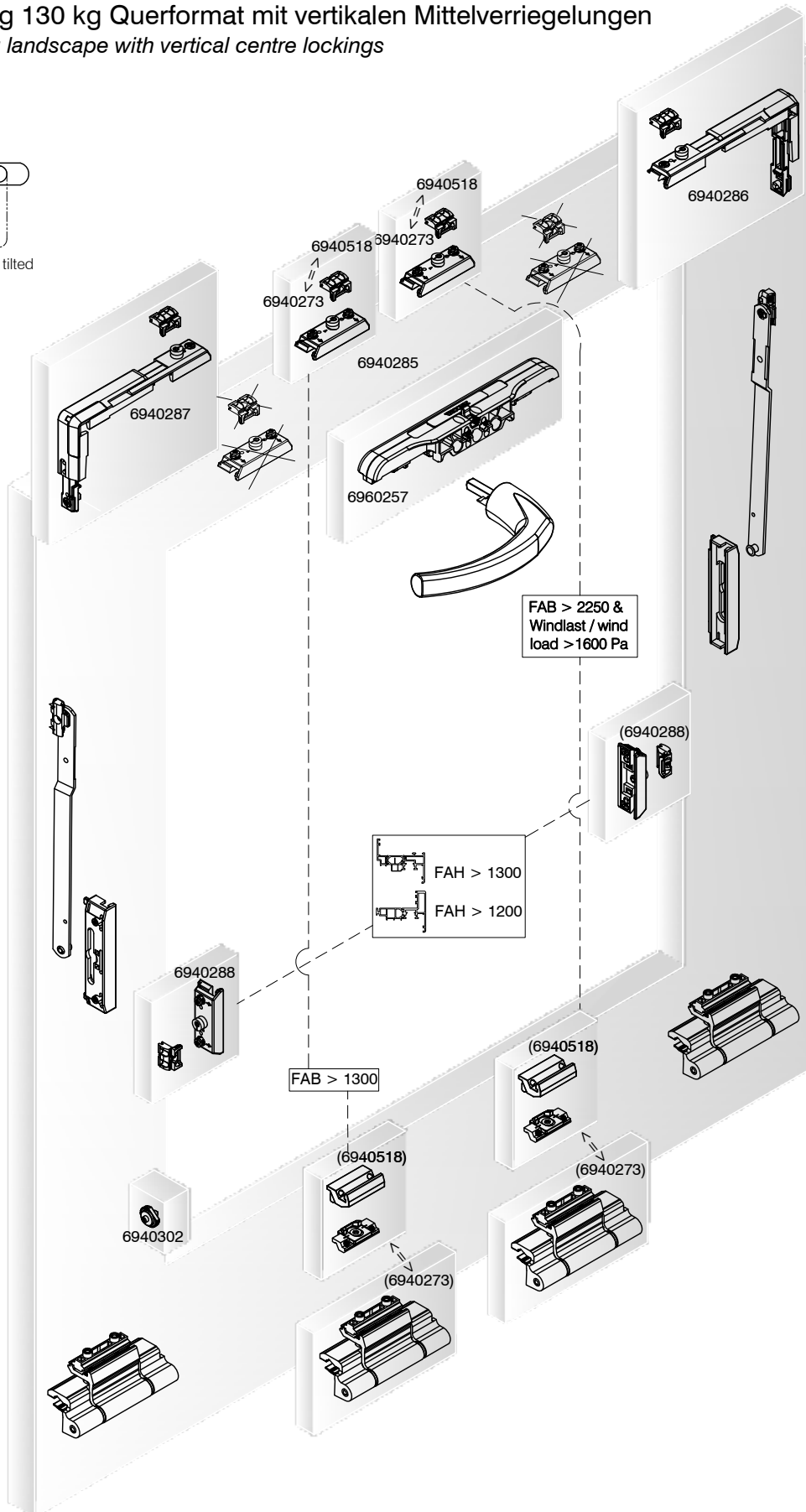
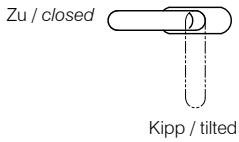

WICLINE 75 TOP

Grundbeschlag
Basic fitting

Beschläge
Fittings



Kipp-Beschlag 130 kg Hochformat
Tilt fitting 130 kg portrait

Griff Stellungen
Handle position

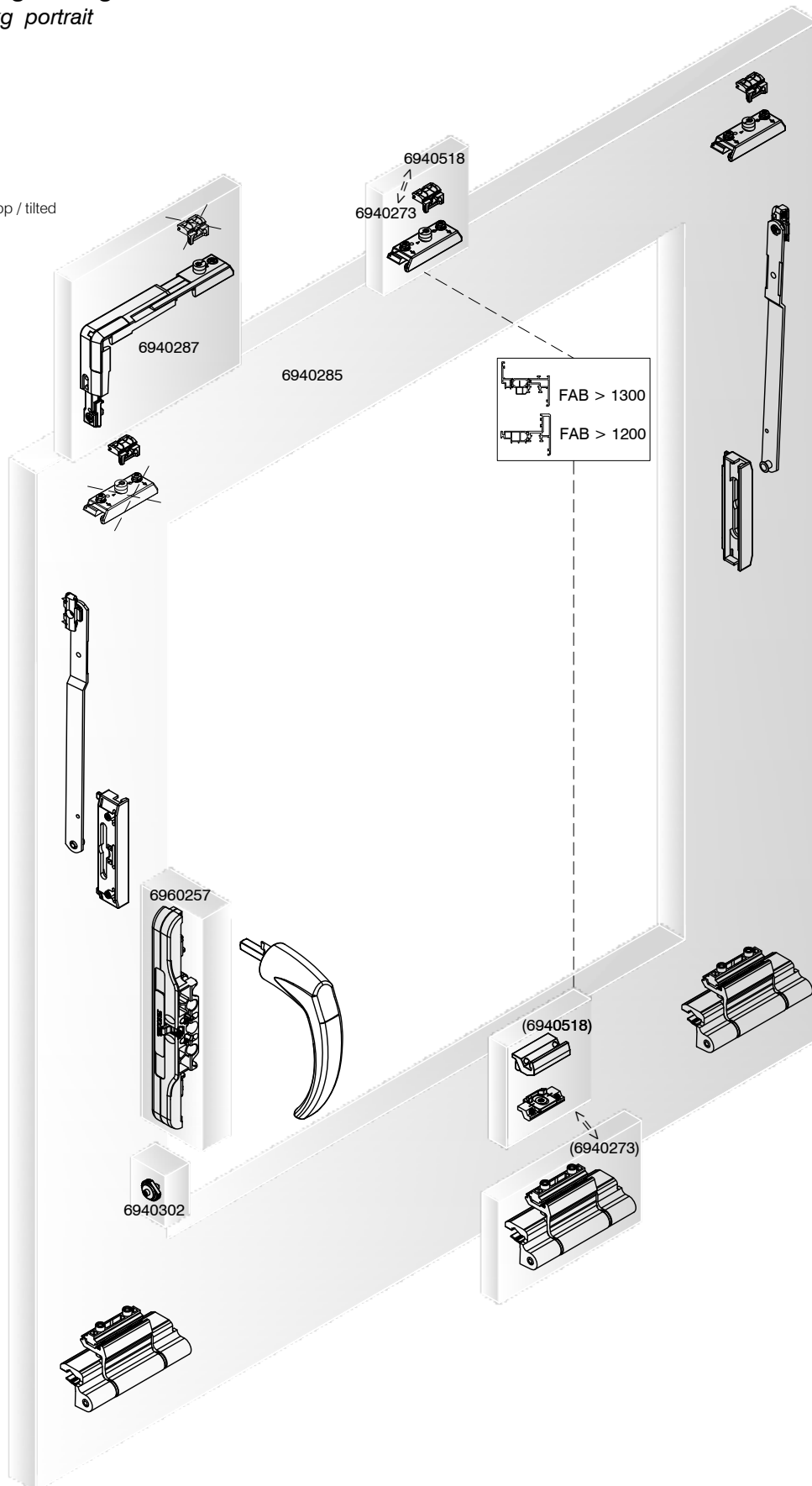
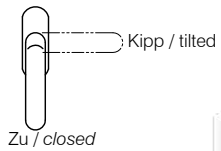

WICLINE 75 TOP

Grundbeschlag
Basic fitting

Beschläge
Fittings



Kipp-Beschlag 130 kg Hochformat mit vertikalen Mittelverriegelungen
Tilt fitting 130 kg portrait with vertical centre lockings

Griff Stellungen
Handle position

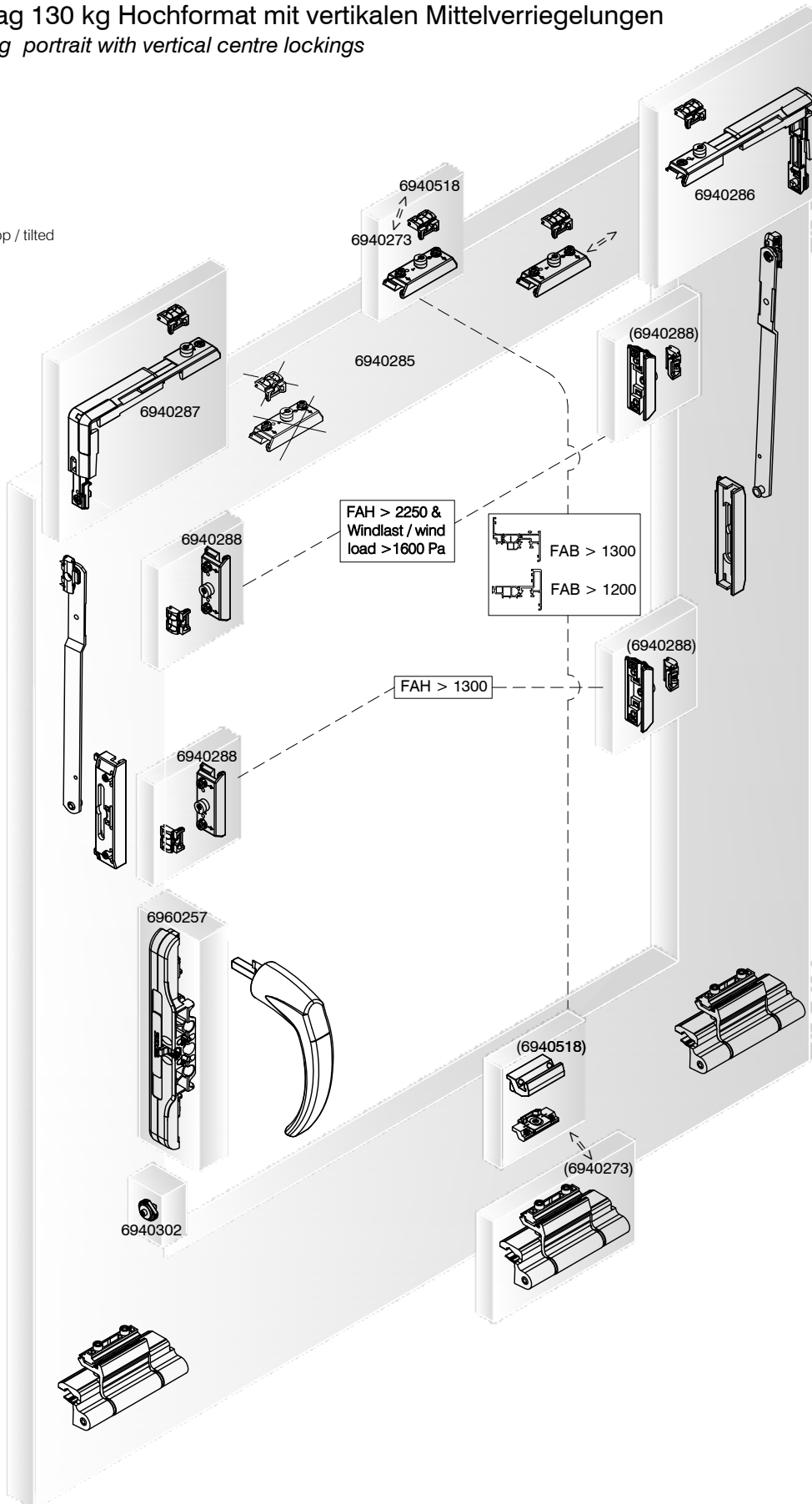
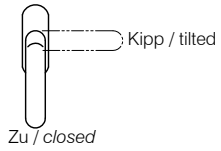

WICLINE 75 TOP

Beschläge
Fittings

Grundbeschlag
Basic fitting



Oberlicht-Beschlag verdeckt
Fanlight fitting concealed

Griff Stellungen
Handle position

Zu / closed



Kipp / tilted

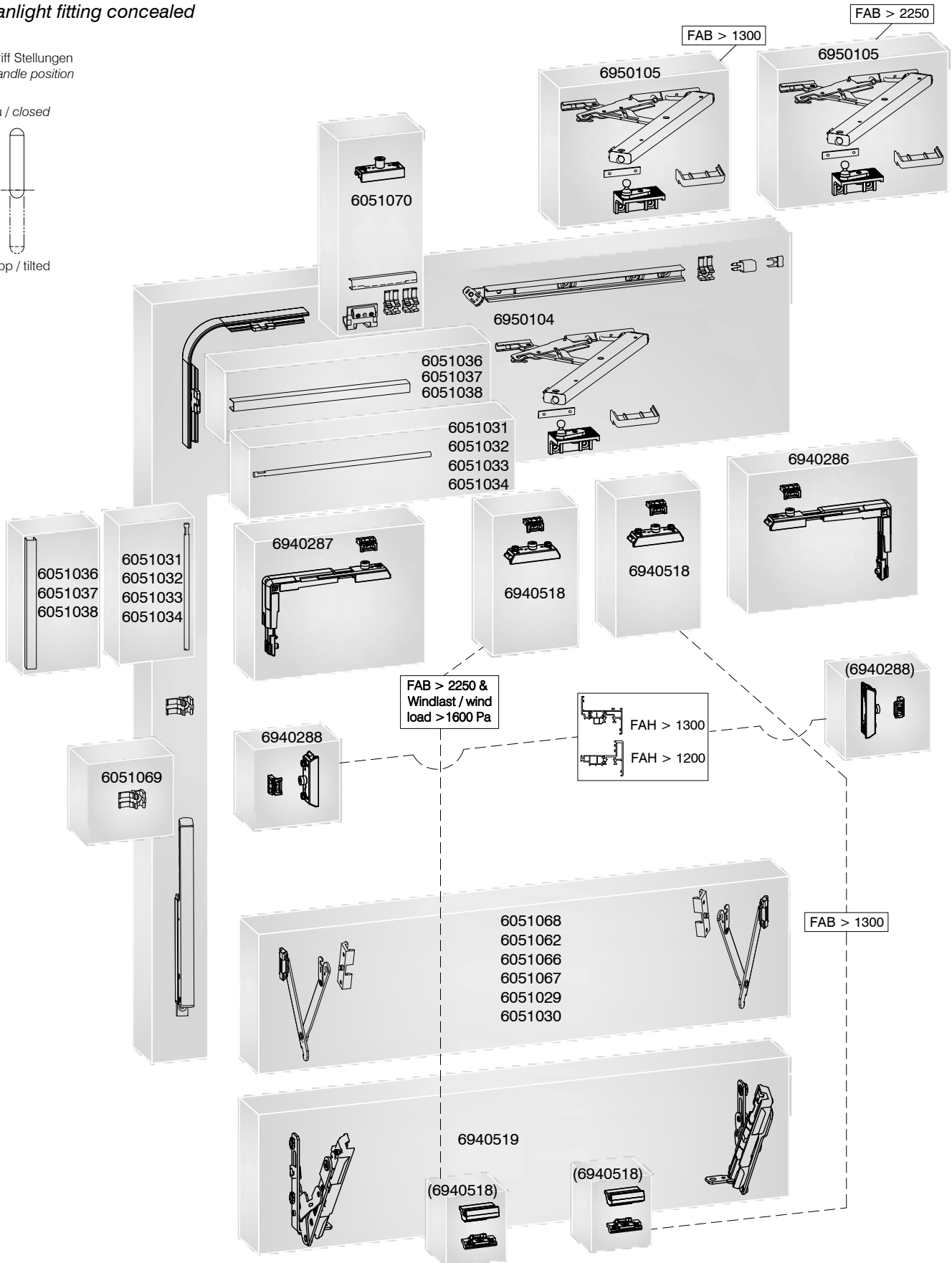

WICLINE 75 TOP

Beschläge
Fittings

Grundbeschlag
Basic fitting

Oberlicht-Beschlag
Fanlight fitting



Griff Stellungen
Handle position

Zu / closed



Kipp / tilted

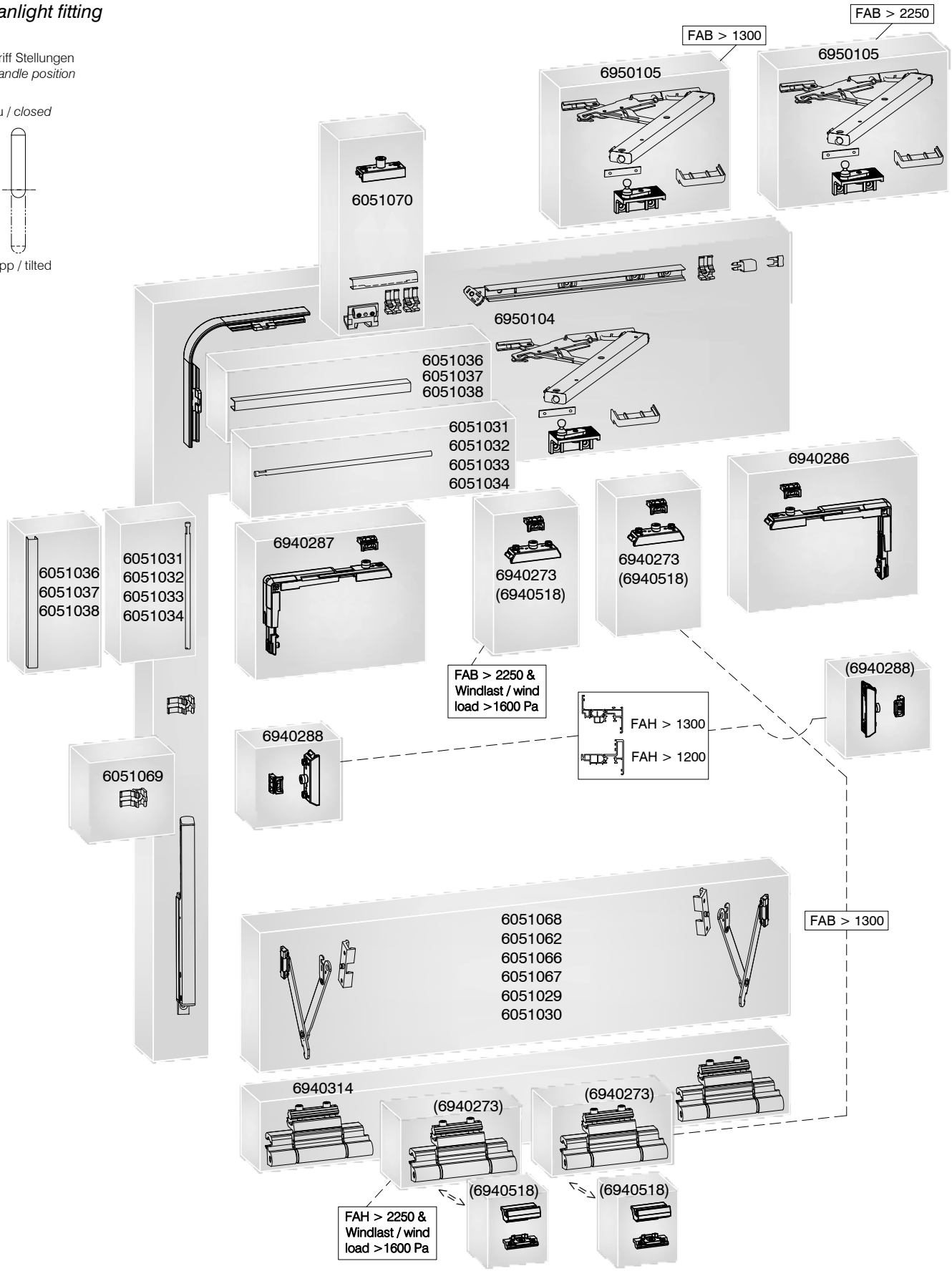



Oberlicht-Beschlag verdeckt, Schrägfenster
Fanlight fitting concealed, sloped window

Griff Stellungen
Handle position

Zu / closed

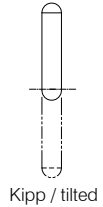

Kipp / tilted

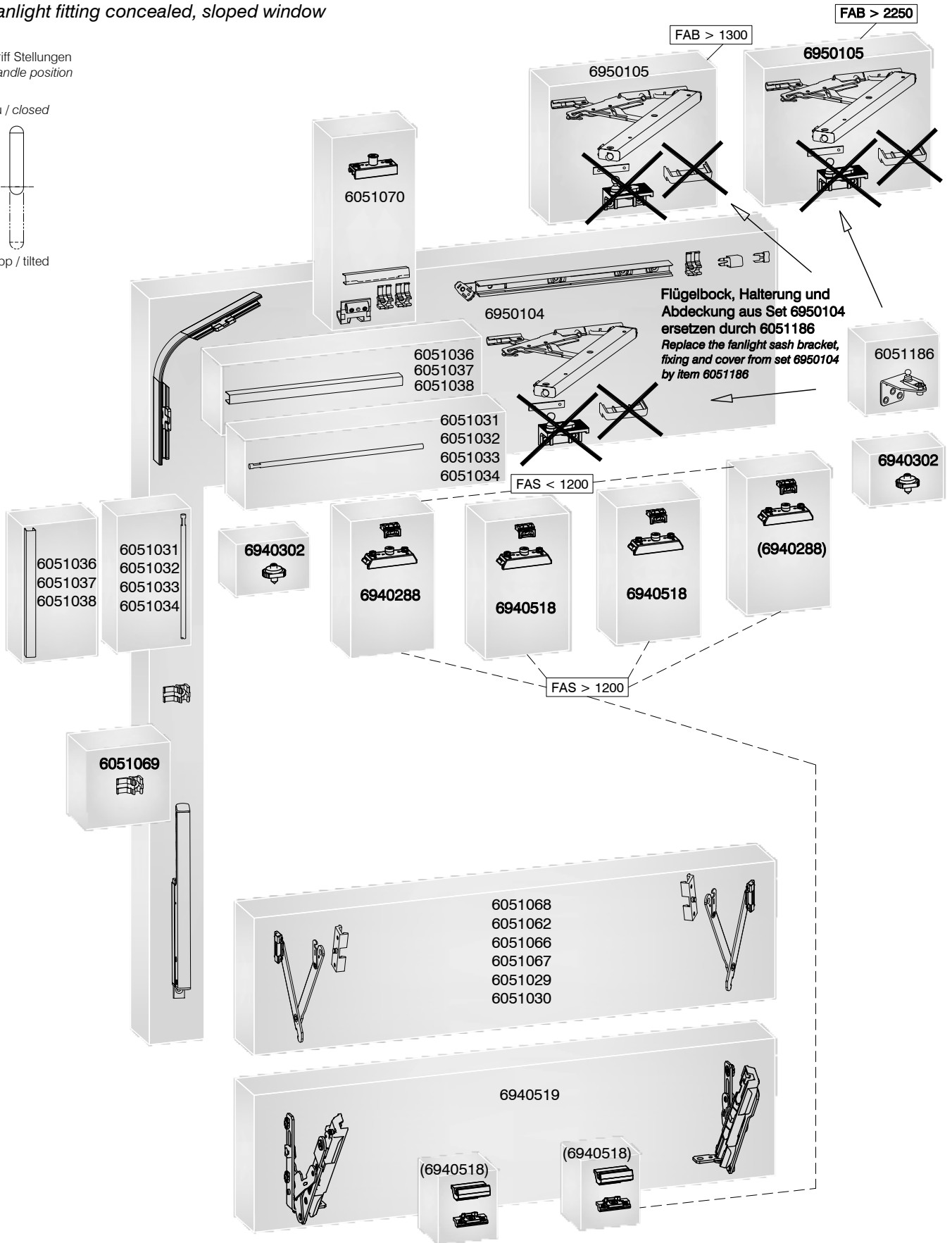

Grundbeschlag
Basic fitting

Oberlicht-Beschlag Schrägfenster
Fanlight fitting sloped window



Griff Stellungen
Handle position

Zu / closed

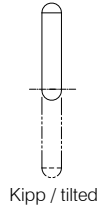

Kipp / tilted

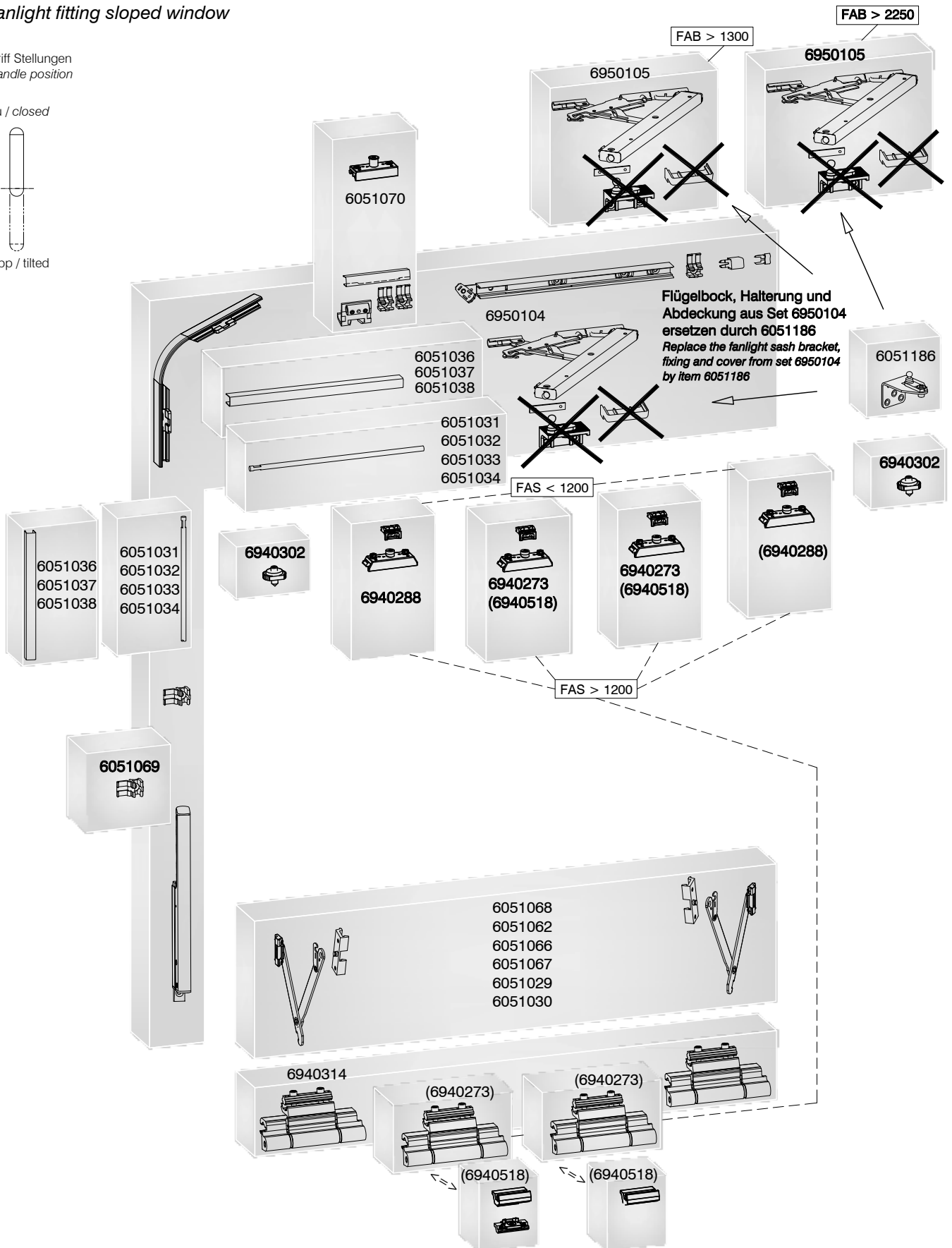

	Seite Page
Serienbeschreibung <i>Description of series</i>	3/3
Profilübersichten <i>Survey of profiles</i>	3/7
Profile sichtbarer Flügel <i>Profiles visible sash</i>	3/25
Blendrahmenprofile <i>Frame profiles</i>	3/26
Flügelprofile <i>Sash profiles</i>	3/50
Kämpfer, Sprossenprofile <i>Transom, glazing bar profiles</i>	3/66
Stulpflügelprofile <i>Double casement sash profiles</i>	3/82
Stützenprofile <i>Mullion profiles</i>	3/86
Schwellenprofile <i>Threshold profiles</i>	3/101
Bauanschlussprofile <i>Profiles for junction to structure</i>	3/102
Aufsatzprofile <i>Supplementary profiles</i>	3/103
Anwendungsbeispiele sichtbarer Flügel <i>Examples of application visible sash</i>	3/107
Profile verdeckter Flügel <i>Profiles concealed sash</i>	3/147
Blendrahmenprofile <i>Frame profiles</i>	3/148
Flügelprofile <i>Sash profiles</i>	3/156
Kämpfer, Sprossenprofile <i>Transom, glazing bar profiles</i>	3/160
Stulpflügelprofile <i>Double casement sash profiles</i>	3/161
Aufsatzprofile <i>Supplementary profiles</i>	3/163
Anwendungsbeispiele verdeckter Flügel <i>Examples of application concealed sash</i>	3/164
Glasleistenprofile - Auswahltabellen <i>Glazing bead profiles - Selection tables</i>	3/171

	Seite Page
Verdeckte Beschläge <i>Concealed fittings</i>	3/189
Zulässige Flügelgrößen <i>Admissible sash sizes</i>	3/190
Zulässige Formatgrößen <i>Admissible format sizes</i>	3/214
Beschlagsübersichten <i>Survey of fittings</i>	3/226
Aufliegende Beschläge <i>Top mounted fittings</i>	3/239
Zulässige Flügelgrößen <i>Admissible sash sizes</i>	3/240
Zulässige Formatgrößen <i>Admissible format sizes</i>	3/276
Beschlagsübersichten <i>Survey of fittings</i>	3/299

Technische Werte:

Beschreibung	Norm	Klasse
Wärmedämmung U_f	EN ISO 10077-2	1,2 - 1,9 W/(m ² K)
Wärmedämmung U_w	EN ISO 10077-1	bis 1,0 W/(m ² K) *
Schalldämmung $R_w (C;C_{tr})$	EN ISO 717-1	bis 47 (-1;-4) dB
Einbruchhemmung	EN 1627	bis RC 3
Durchschusshemmung	EN 1522	bis FB 4NS
Luftdurchlässigkeit	EN 12207	4
Schlagregendichtheit	EN 12208	bis E1050
Windlastwiderstand	EN 12210	bis C5/B5
Mechanische Festigkeit	EN 13115	bis 4
Dauerfunktion	EN 12400	bis 3

* Für Fenster 1230 x 1480 mit Flügel-Rahmenkombinationen (Ansichtsbreit 142 mm) in Verbindung mit 3-fach Verglasung und thermisch optimiertem Randverbund

Technical values:

Description	Technical standard	Class
Thermal insulation U_f	EN ISO 10077-2	1,2 - 1,9 W/(m ² K)
Thermal insulation U_w	EN ISO 10077-1	to 1,0 W/(m ² K) *
Sound insulation $R_w (C;C_{tr})$	EN ISO 717-1	to 47 (-1;-4) dB
Burglar resistance	EN 1627	to RC 3
Bullet resistance	EN 1522	to FB 4NS
Air permeability	EN 12207	4
Water tightness	EN 12208	to E1050
Wind load resistance	EN 12210	to C5/B5
Mechanical strength	EN 13115	to 4
Long term functionality	EN 12400	to 3

* For windows 1230 x 1480 with sash-frame combinations (sight lines 142 mm) with triple glazing and thermally optimized compound edge

Systemprüfung des Fenstersystems mit ift-Produktpass als Basis für CE-Kennzeichnung nach DIN EN 14351-1 und Erfüllung der Mindestanforderungen für das RAL-Gütezeichen RAL-GZ 695

Profiltechnik:

Rahmenbautiefe: 75 mm
Rahmenfalzhöhe: 25 mm
Gesamtbautiefe Profilsystem: 85 mm

Profilansichtsbreiten:

Blendrahmenprofile von 48 mm bis 155 mm
Kämpferprofile von 73 mm bis 290 mm
Flügelprofile von 34 mm bis 71 mm

Öffnungsarten:

- Dreh-, Dreh-Kipp-, Kippfenster, Tilt-First
- Oberlicht
- Stulpfenster
- Parallel-Schiebe-Kipp
- 1 und 2 flg. Fenstertüren einwärts /auswärts öffnend mit barrierefreier Schwelle
- Senk-Klapp, Klapp
- Schwing-Wendefenster
- Lüftungsklappe

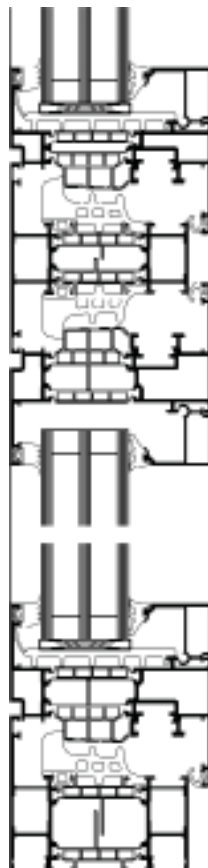

Dreh-, Dreh-Kipp-, Kippfenster mit innerem Überschlag, kombiniert mit Oberlichtflügel
Turn, turn/tilt, tilt window with overlapping sash combined with fanlight sash

System testing of the window system with ift product pass as base for the CE marking to DIN EN 14351-1 and compliance with the minimum requirements for the RAL quality marking RAL-GZ 695

Profile technique:

Frame construction depth: 75 mm
Frame rebate height: 25 mm
Overall construction depth profile system: 85 mm

Profile sight lines:

Frame profiles from 48 mm to 155 mm
Transom profiles from 73 mm to 290 mm
Sash profiles from 34 mm to 71 mm

Opening types:

- Turn, turn/tilt, tilt, tilt-first,
- Fanlight
- Double casement window
- Parallel slide tilt
- 1 and 2 leaves casement doors inwards / outwards, accessible
- Italian style, top hung
- Horizontal-vertical pivot
- Ventilation flap

Sichtbare Flügelprofile

Visible sash profiles

Konstruktionsmerkmale:

Hauptprofile als Mehrkammer-Verbundprofile, Kantenradius $\leq 0,5$ mm

Profilverbundherstellung ausschließlich werkseitig mit Qualitätssicherung und Werksgarantie auch für nachträgliche Oberflächenbehandlungen. (Anodisieren, Nass- und Pulverbeschichtung)

Gerundete Flügelüberschläge mit 10 mm Flächenversatz und 5 mm Rahmenüberschlag. Flügel- und Rahmenaußen-schalen flächenbündig bei sichtbarem Flügelrahmen.

Gehrungsverbindung durch systemeigene hohlkammerfüllende Gusseckwinkel mit Spreiz- und Klebemengen- Kontrollfunktion.

Stumpfe Verbindungen mit systemeigenen, hohlkammerfüllenden Aluminium-Profilverbindern und mengenbegrenzter Klebstoffinjektion.

Gesicherte Entwässerung und Dampfdruckausgleich wahlweise über außen sichtbare Entwässerungsabdeckungen oder verdeckt über Profilaußenschale.

Vierseitig umlaufender Mitteldichtungsrahmen in Eigenfertigung aus EPDM-Schaum koextrudiert, in den Fensterecken unterbrechungsfrei ohne Einschnitte verlegt.

Innere Anschlagdichtung umlaufend, unterbrechungsfrei, ohne Aussparung im Bereich der Bänder

Verglasungsdichtung außen aus EPDM-Schaum koextrudiert.

Füllungsdicken Festverglasung von 6 – 60 mm
Füllungsdicken Flügel von 16 – 70 mm

Konstruktionsvarianten

- Verdeckter Flügel
- Alternative Ausführung Mitteldichtung
- Optimierte Verbundzone
- Einbruchhemmung RC 1N-RC3
- Durchschusshemmung FB4
- Klassik-Design
- Schräg-Rundbogen-Fenster
- Einspannblendrahmen für Fassade

WICSTAR DPS Systembeschläge:

Hochwertige vollständig verdeckte Systembeschläge mit Direkt- Positioning- System (DPS). Bauteilmontage in beliebiger Reihenfolge. Zulässige Flügelgewichte für verdeckte Bänder 160 kg, für aufliegend Bänder 200 kg

Systemkombinationen:

WICLINE 75 TOP Fenster sind kombinierbar mit WICLINE 75 evo Fenstern und WICSTYLE 75 evo Türen und über Einspannblendrahmen mit den aktuellen WICTEC-Fassaden-Programme kombinierbar.

Design characteristics:

Main profiles as multi cavities compound profiles, edge radii $\leq 0,5$ mm

Profile compound production exclusively factory-made with quality assurance and factory warranty also for subsequent surface treatments. (anodizing, wet and powder coating)

Rounded sash overlaps with 10 mm offset and 5 mm frame profile overlap. Sash and frame outer shells flush for visible sashes.

Mitre corner connection by system specific cavity filling cast aluminium expanding corner angles and quantity controlled glue injection.

Butt joint connections by system specific, cavity filling aluminium connectors and quantity controlled glue injection.

Safe drainage and pressure equalization either through externally visible weephole covers or concealed through profile outer shells.

Perimetric, self-made centre gasket frame made of coextruded EPDM foam, running around window corners without interruptions and incisions.

Perimetric, continuous inner overlap gasket, without cutout in hinge areas.

Outer glazing gasket made of coextruded EPDM foam.

*Infill thicknesses for fixed glazing from 6 - 60 mm
Infill thicknesses for sash from 16 - 70 mm*

Design variants

- Concealed sash
- Alternative version of central gasket
- Optimized thermal break zone
- Burglary resistance RC 1N-RC3
- Bullet resistance FB4
- Classic Design
- Inclined/semi-circular arch window
- Insertion frame for façade

WICSTAR DPS system fittings:

High quality completely concealed system hardware with Direct Positioning System (DPS). Component installation possible in any order. Admissible sash weights for concealed hinges 160 kg, for visible hinges 200 kg.

System combinations:

WICLINE 75 TOP windows can be combined with WICLINE 75 evo windows and WICSTYLE 75 evo doors and by means of insertion frames with the present WICTEC façade range.

Technische Werte:

Beschreibung	Norm	Klasse
Wärmedämmung U_f	EN ISO 10077-2	1,2 - 1,8 W/(m ² K)
Wärmedämmung U_w	EN ISO 10077-1	bis 0,88 W/(m ² K)*
Schalldämmung $R_w (C;C_{tr})$	EN ISO 717-1	bis 46 (-1;-4) dB
Einbruchhemmung	EN 1627	bis RC 3
Luftdurchlässigkeit	EN 12207	4
Schlagregendichtheit	EN 12208	bis E1050
Windlastwiderstand	EN 12210	bis C5/B5
Mechanische Festigkeit	EN 13115	bis 4
Dauerfunktion	EN 12400	bis 3

* Für Fenster 1230 x 1480 mit Flügel-Rahmenkombinationen (Ansichtsbreite 74 mm) in Verbindung mit 3-fach Verglasung und thermisch optimiertem Randverbund

Technical values:

Description	Technical standard	Class
Thermal insulation U_f	EN ISO 10077-2	1,2 - 1,8 W/(m ² K)
Thermal insulation U_w	EN ISO 10077-1	to 0,88 W/(m ² K) *
Sound insulation $R_w (C;C_{tr})$	EN ISO 717-1	to 46 (-1;-4) dB
Burglar resistance	EN 1627	to RC 3
Air permeability	EN 12207	4
Water tightness	EN 12208	to E1050
Wind load resistance	EN 12210	to C5/B5
Mechanical strength	EN 13115	to 4
Long term functionality	EN 12400	to 3

* For windows 1230 x 1480 with sash-frame combinations (sight lines 74 mm) with triple glazing and thermally optimized compound edge

Systemprüfung des Fenstersystems mit ift-Produktpass als Basis für CE-Kennzeichnung nach DIN EN 14351-1 und Erfüllung der Mindestanforderungen für das RAL-Gütezeichen RAL-GZ 695

System testing of the window system with ift product pass as base for the CE marking to DIN EN 14351-1 and compliance with the minimum requirements for the RAL quality marking RAL-GZ 695

Profiltechnik:

Rahmenbautiefe: 75 mm
Rahmenfalzhöhe: 25 mm
Gesamtbautiefe Profilsystem: 85 mm

Profile technique:

Frame construction depth: 75 mm
Frame rebate height: 25 mm
Overall construction depth profile system: 85 mm

Profilansichtsbreiten:

Blendrahmenprofile 74 mm und 84 mm
Kämpferprofile 90 mm und 118 mm
Flügelprofile 55 mm und 65 mm (innere Ansichtsbreite)

Profile sight lines:

Frame profiles 74 mm and 84 mm
Transom profiles 90 mm and 118 mm
Sash profiles 55 mm and 65 mm (inner sight line)

Öffnungsarten:

- Dreh-, Dreh-Kipp-, Kippfenster, Tilt-First
- Oberlicht
- Stulpfenster

Opening types:

- Turn, turn/tilt, tilt, tilt-first
- Fanlight
- Double casement window



Dreh-, Dreh-Kipp-, Kippfenster mit verdeckt liegendem Flügel, Verglasung von außen.
Turn, turn/tilt, tilt window with concealed sash, glazing from outside.

Verdeckte Flügelprofile

Concealed sash profiles

Konstruktionsmerkmale:

Hauptprofile als Mehrkammer-Verbundprofile,
Kantenradius $\leq 0,5$ mm

Profilverbundherstellung ausschließlich werkseitig mit
Qualitätssicherung und Werksgarantie auch für nachträgliche
Oberflächenbehandlungen.
(Anodisieren, Nass- und Pulverbeschichtung)

Gerundete Flügelüberschläge mit 10 mm Flächenversatz
und 5 mm Rahmenüberschlag.

Gehrungsverbindung durch systemeigene hohlkammerfüllende
Gusseckwinkel mit Spreiz- und Klebmengen- Kontrollfunktion.

Stumpfe Verbindungen mit systemeigenen, hohlkammerfüllenden
Aluminium-Profilverbindern und mengenbegrenzter Klebstoffinjektion.

Gesicherte Entwässerung und Dampfdruckausgleich wahlweise
über außen sichtbare Entwässerungsabdeckungen oder verdeckt
über Profilaußenschale.

Vierseitig umlaufender Mitteldichtungsrahmen in Eigenfertigung
aus EPDM-Schaum koextrudiert, in den Fensterecken unterbrechungsfrei
ohne Einschnitte verlegt.

Innere Anschlagdichtung umlaufend, unterbrechungsfrei,
ohne Aussparung im Bereich der Bänder

Verglasungsdichtung außen aus EPDM-Schaum koextrudiert.

Füllungsdicken Festverglasung von 6 – 60 mm
Füllungsdicken Flügel von 24 – 42 mm

Konstruktionsvarianten

- Alternative Ausführung Mitteldichtung
- Einbruchhemmung RC 1N-RC3
- Einspannblendrahmen für Fassade

WICSTAR DPS Systembeschläge:

Hochwertige vollständig verdeckte Systembeschläge mit
Direkt- Positioning- System (DPS). Bauteilmontage in beliebiger
Reihenfolge. Zulässige Flügelgewichte für verdeckte Bänder 130 kg,
für aufliegend Bänder 130 kg

Systemkombinationen:

WICLINE 75 evo Fenster mit verdeckten Flügelprofilen sind
kombinierbar mit WICLINE 75 TOP Fenstern und über Einspannblendrahmen
mit dem aktuellen WICTEC-Fassaden-Programm.

Design characteristics:

*Main profiles as multi cavities compound profiles,
edge radii $\leq 0,5$ mm*

*Profile compound production exclusively factory-made with
quality assurance and factory warranty also for subsequent
surface treatments.
(anodizing, wet and powder coating)*

*Rounded sash overlaps with 10 mm offset
and 5 mm frame profile overlap.*

*Mitre corner connection by system specific cavity filling cast
aluminium expanding corner angles and quantity controlled
glue injection.*

*Butt joint connections by system specific, cavity filling aluminium
connectors and quantity controlled glue injection.*

*Safe drainage and pressure equalization either through externally
visible weephole covers or concealed through profile outer shells.*

*Perimetric, self-made centre gasket frame made of coextruded
EPDM foam, running around window corners without interruptions
and incisions.*

*Perimetric, continuous inner overlap gasket, without cutout in
hinge areas.*

Outer glazing gasket made of coextruded EPDM foam.

*Infill thicknesses for fixed glazing from 6 - 60 mm
Infill thicknesses for sash from 24 - 42 mm*

Design variants

- Alternative version of central gasket
- Burglary resistance RC 1N-RC3
- Insertion frame for façade

WICSTAR DPS system fittings:

*High quality completely concealed system hardware with Direct
Positioning System (DPS). Component installation possible in any
order. Admissible sash weights for concealed hinges 130 kg,
for visible hinges 130 kg.*

System combinations:

*WICLINE 75 evo windows with concealed sash profiles can be
combined with WICLINE 75 TOP windows and by means of insertion
frames with the present WICTEC façade range.*

Profilübersicht
Survey of profiles

Blendrahmenprofile
Frame profiles

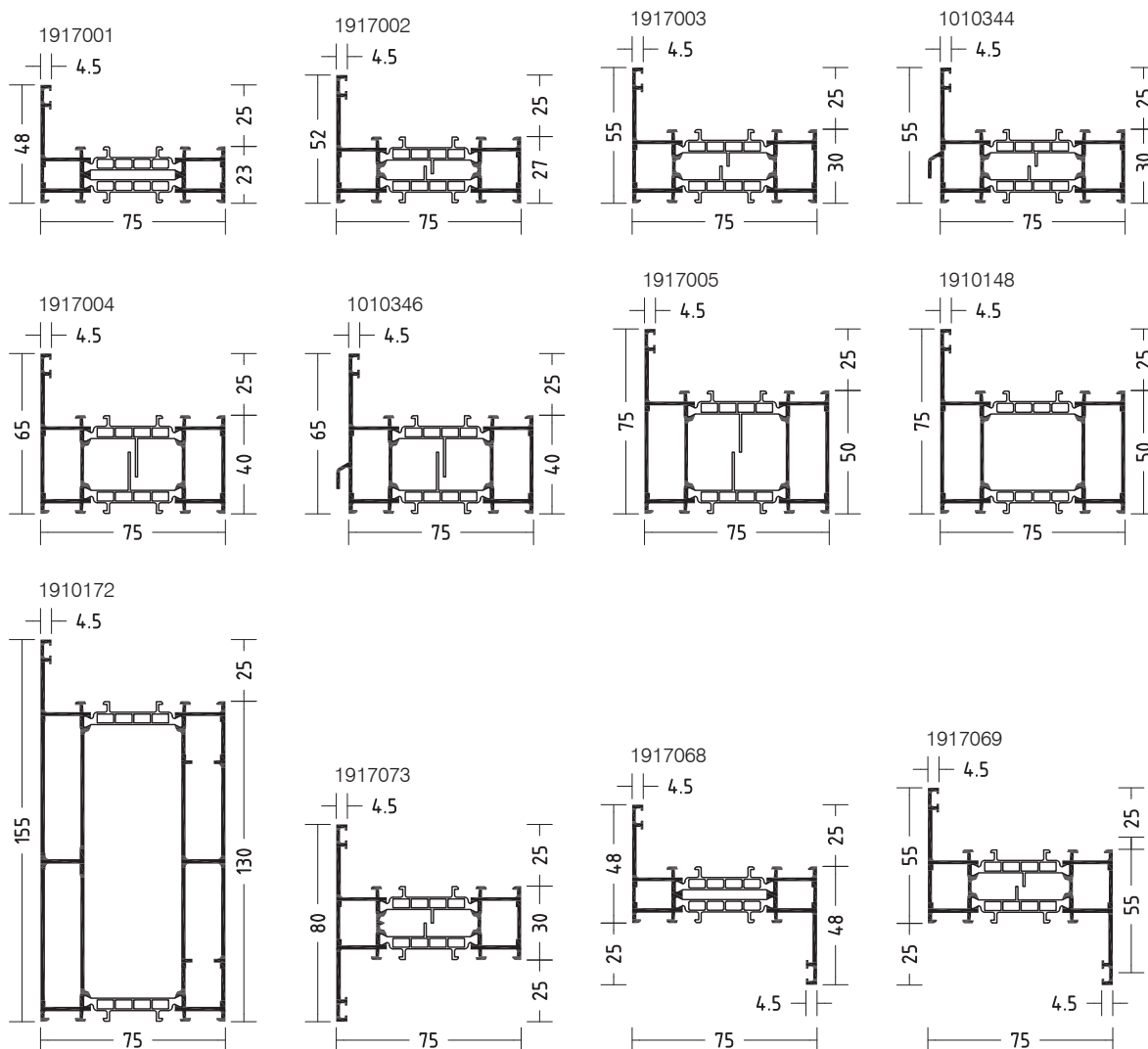

Einspann-Blendrahmenprofile
Clamping frame profiles

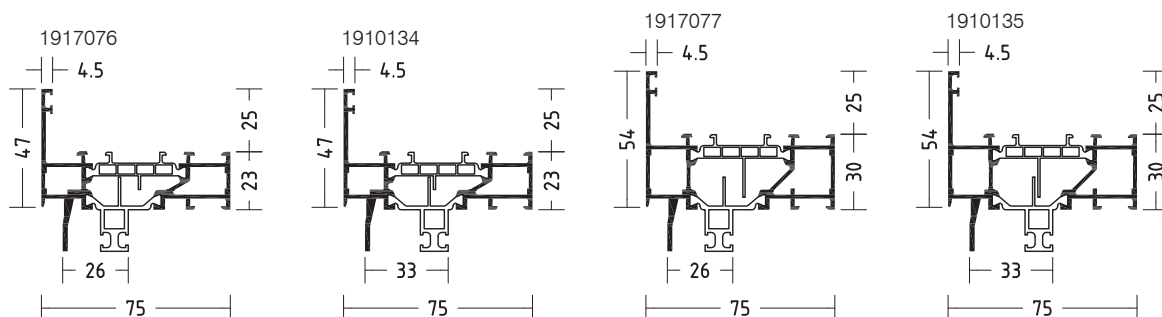

WICLINE 75

Profilübersicht - Verdeckte Entwässerung Survey of profiles - Concealed drainage

Blendrahmenprofile Frame profiles

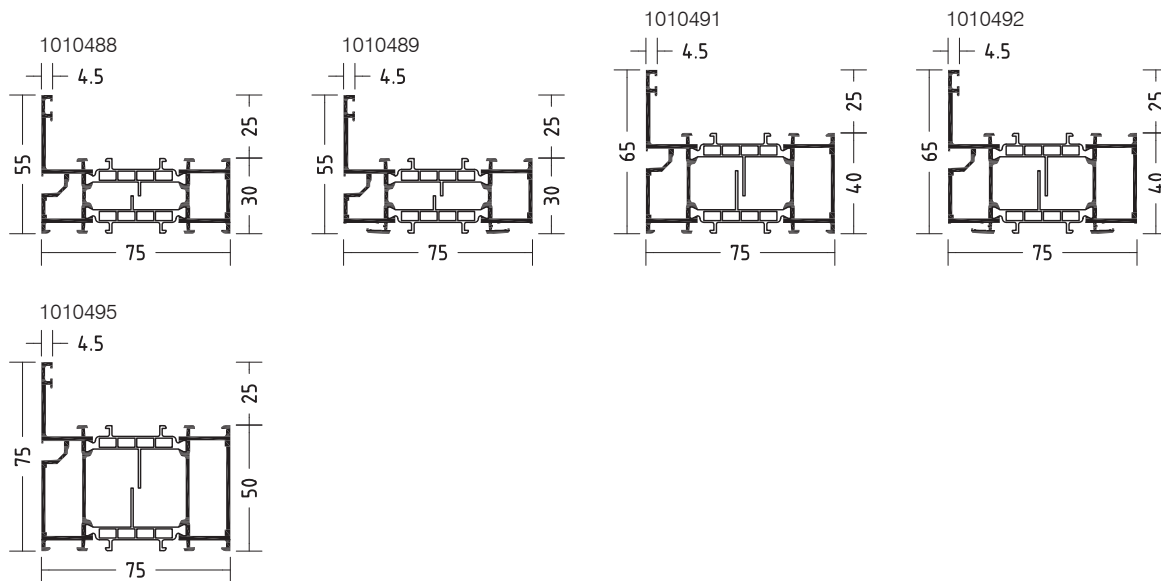

Einspann-Blendrahmenprofile Clamping frame profiles

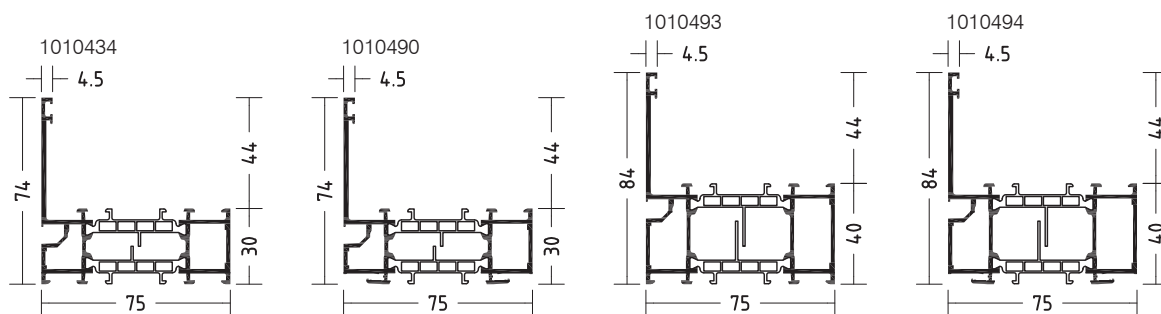

Profilübersicht
Survey of profiles

Blendrahmenprofil für MINERGIE®
Frame profile for MINERGIE®

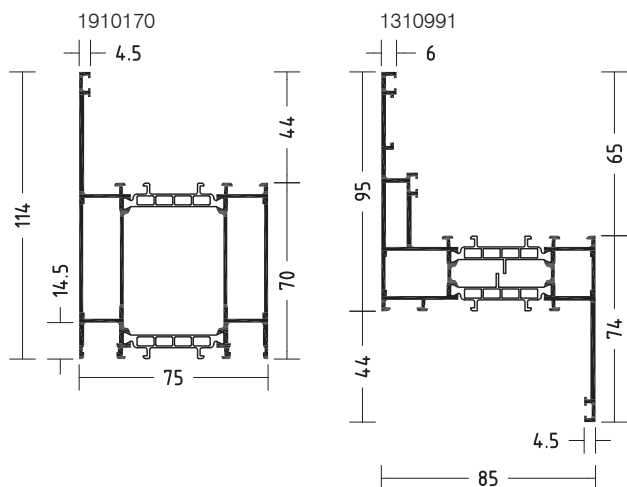

Dehnstoßprofile
Expansion joint profiles

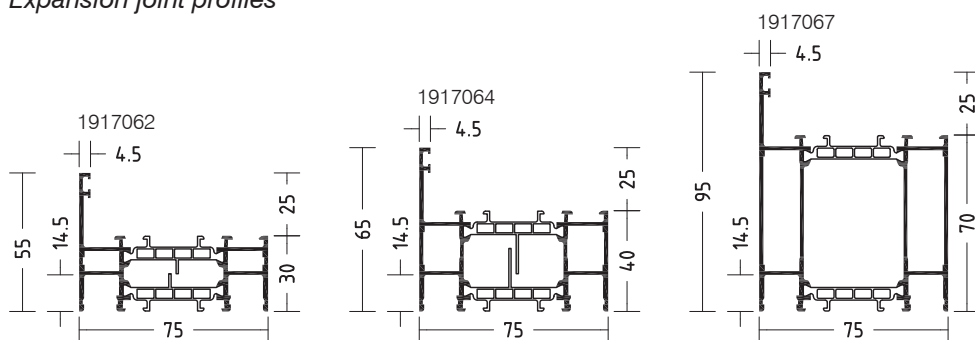

Stützenprofile geteilt nach außen verstärkt
Externally reinforced split mullion profiles

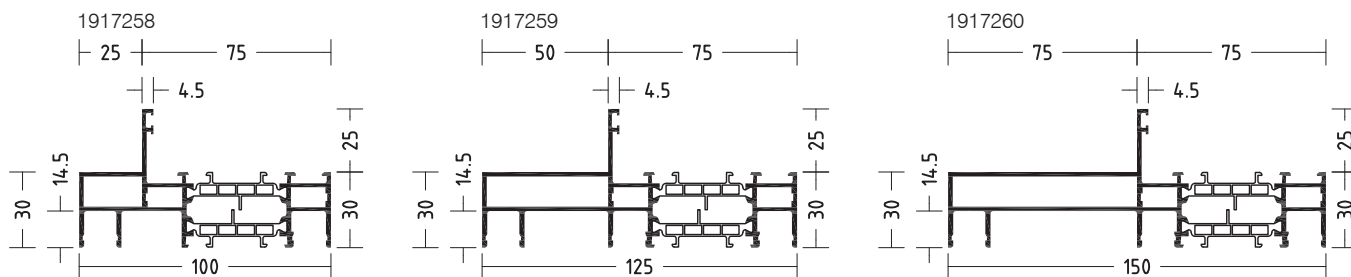

Stützenprofil geteilt nach innen verstärkt
Internally reinforced split mullion profile

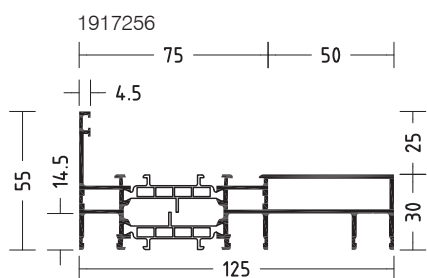

Profilübersicht
Survey of profiles

Flügelprofile nach Innen öffnend
Sash profiles inwards

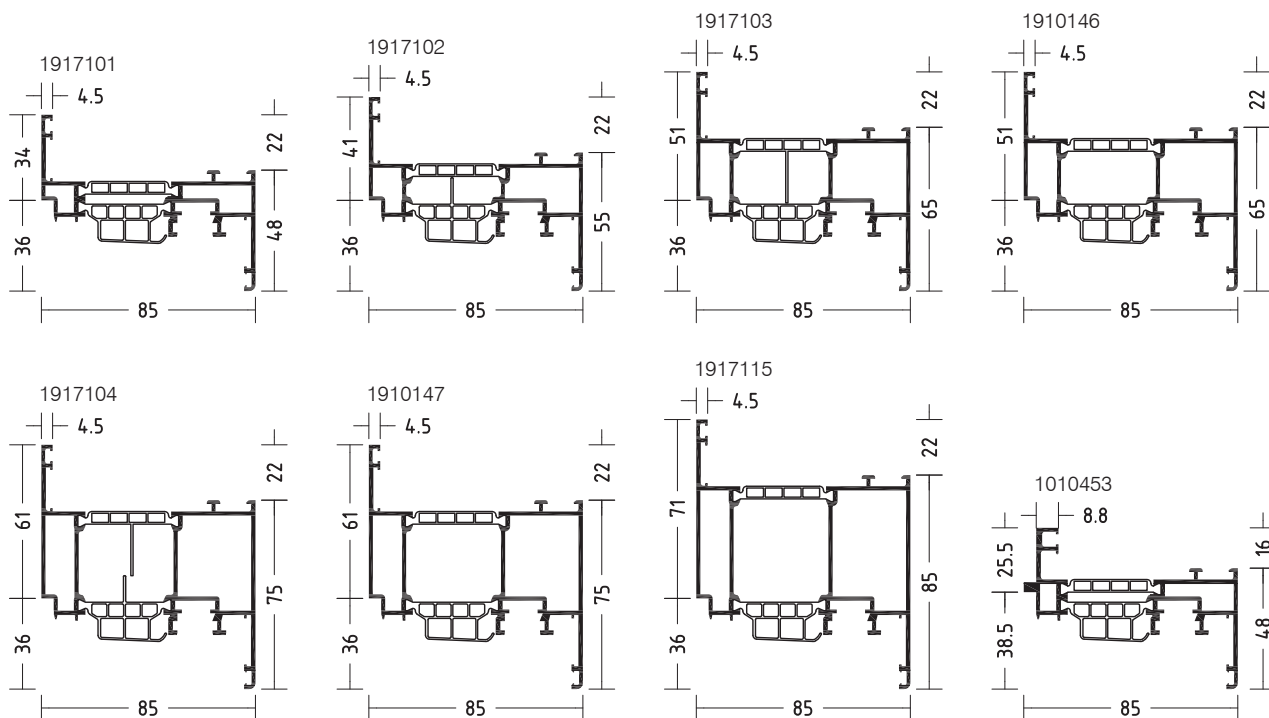

Flügelprofil nach Außen öffnend
Sash profile outwards

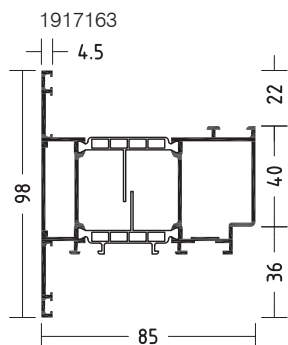

Stulpflügelprofile
Double casement sash profiles

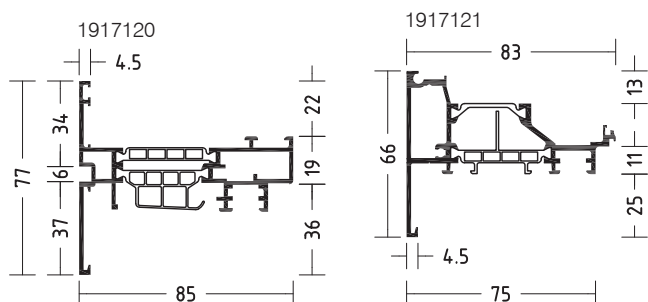

Profilübersicht
Survey of profiles

Kämpferprofile
Transom profiles

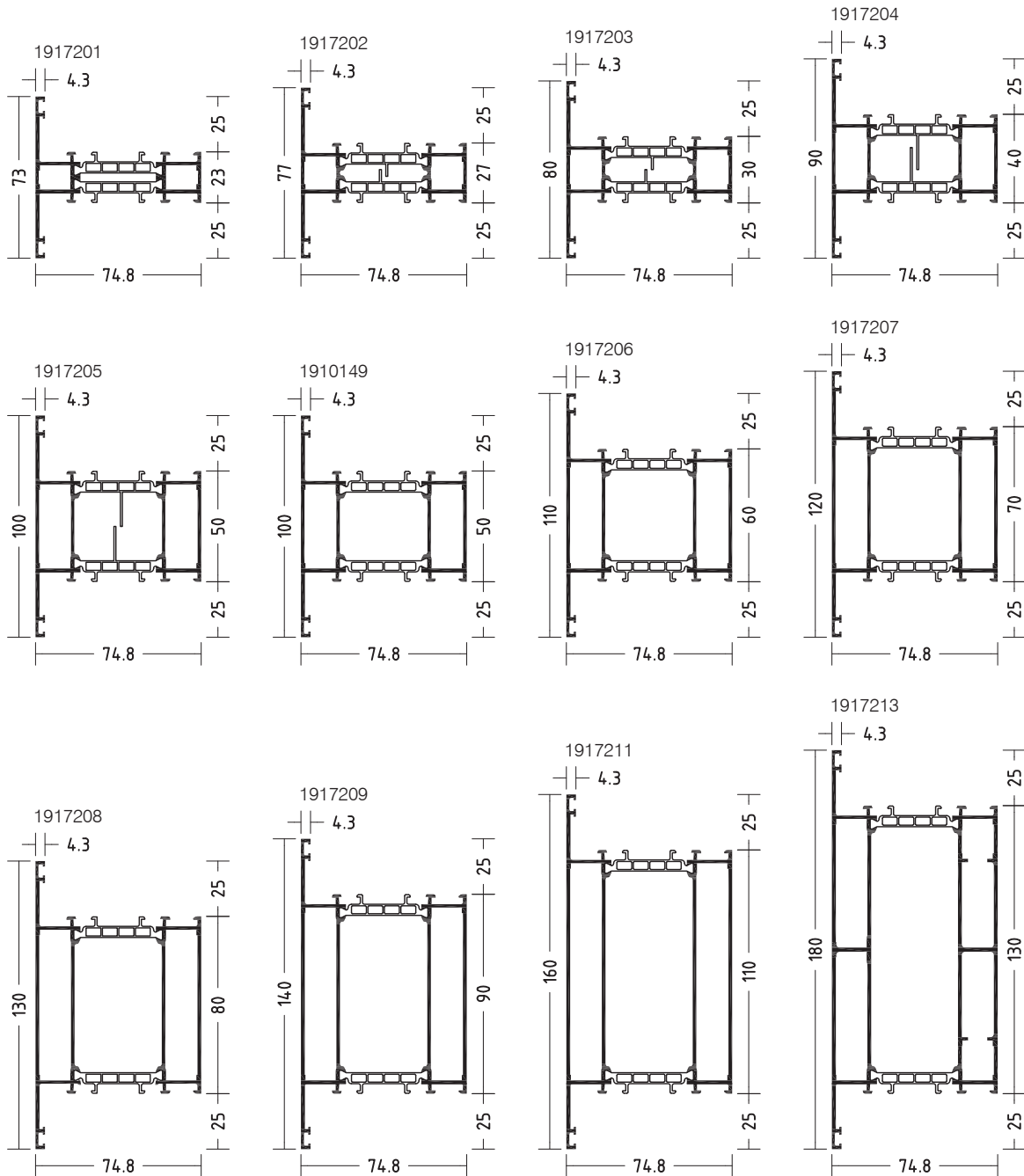

WICLINE 75

Profilübersicht
Survey of profiles

Kämpferprofile
Transom profiles

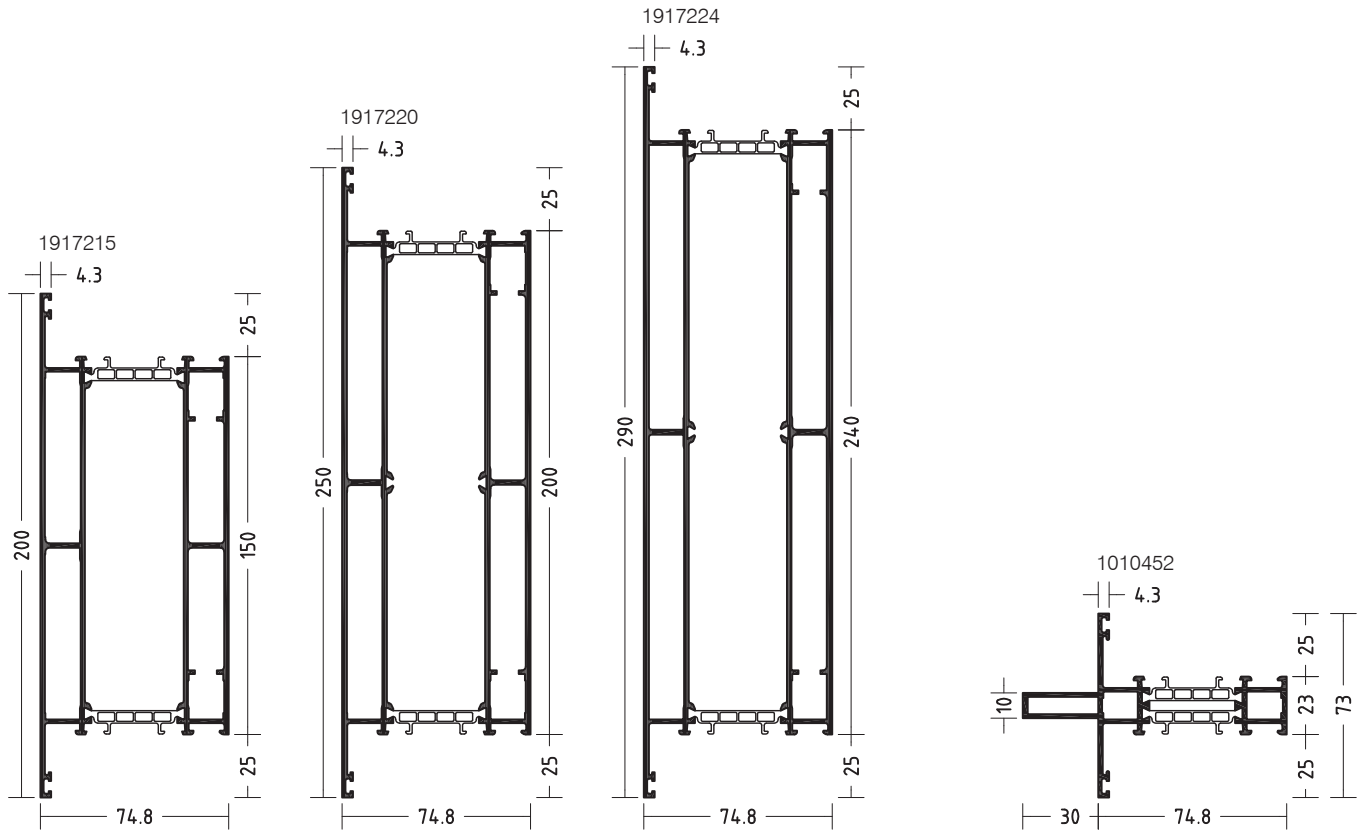

Stützenprofile nach außen verstärkt
Externally reinforced mullion profiles

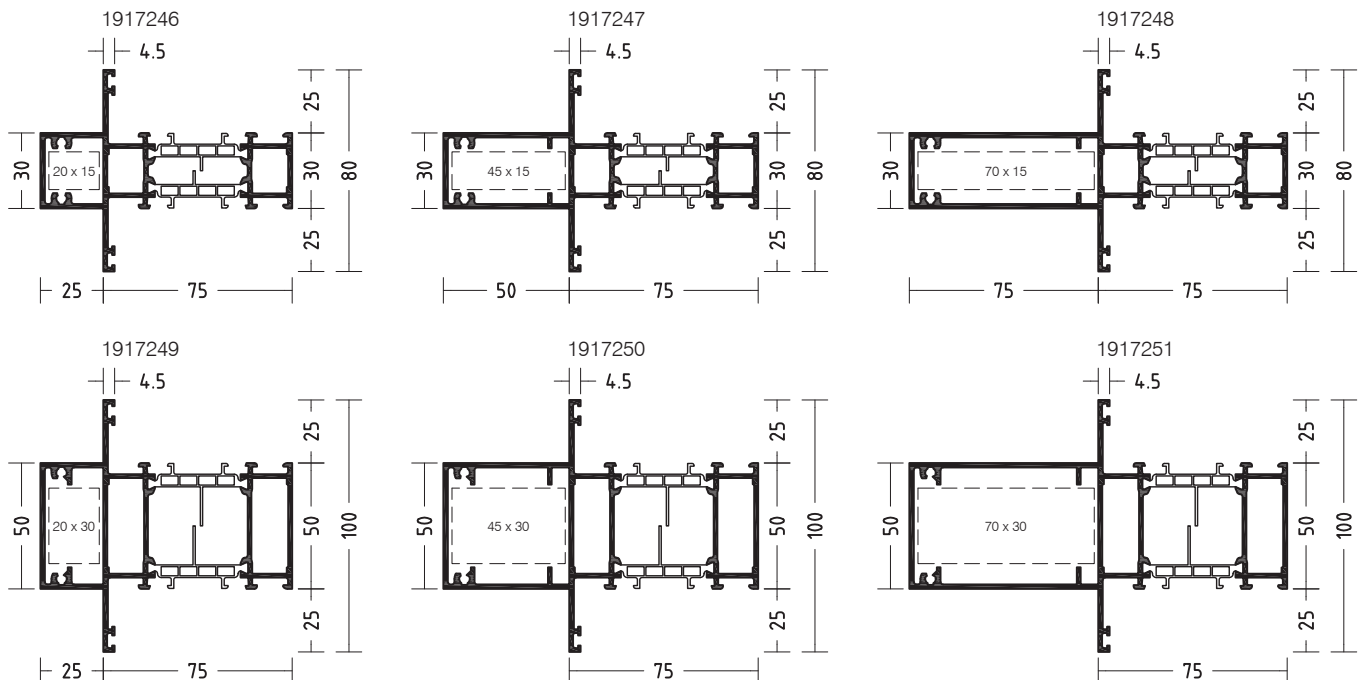

Profilübersicht
Survey of profiles

Stützenprofile nach innen verstärkt
Internally reinforced mullion profiles

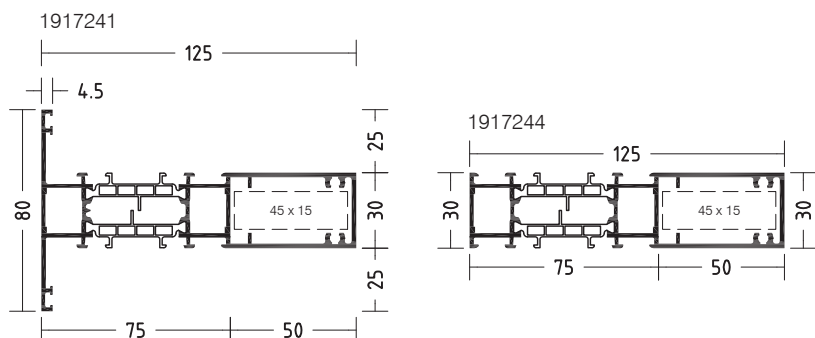

Stützenprofile
Mullion profiles

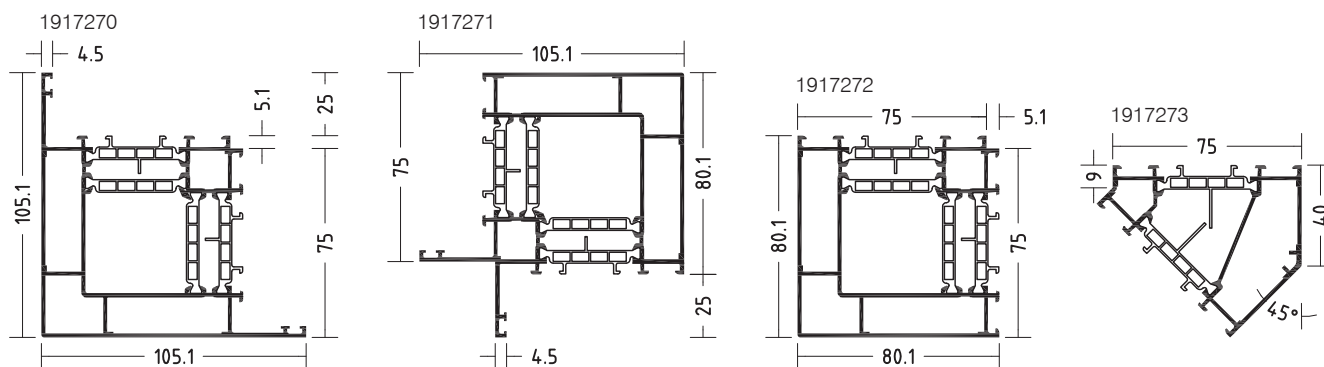

Sprossenprofile
Glazing bar profiles

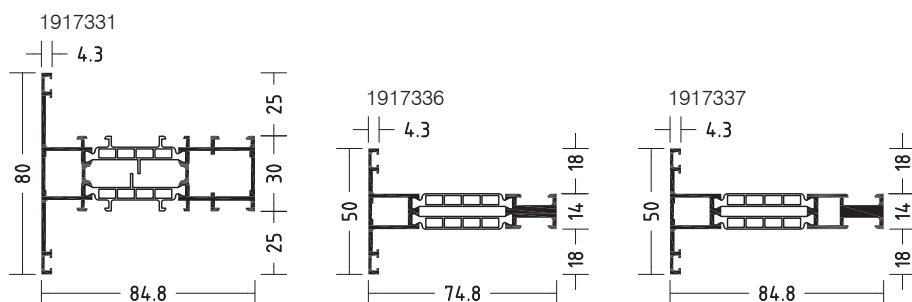

Zusatzprofil
Additional profile

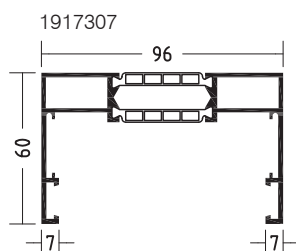

WICLINE 75

Profilübersicht Survey of profiles

Schwellenprofile Threshold profiles

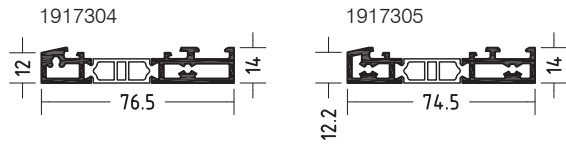

Aufsatzprofile Supplementary profiles

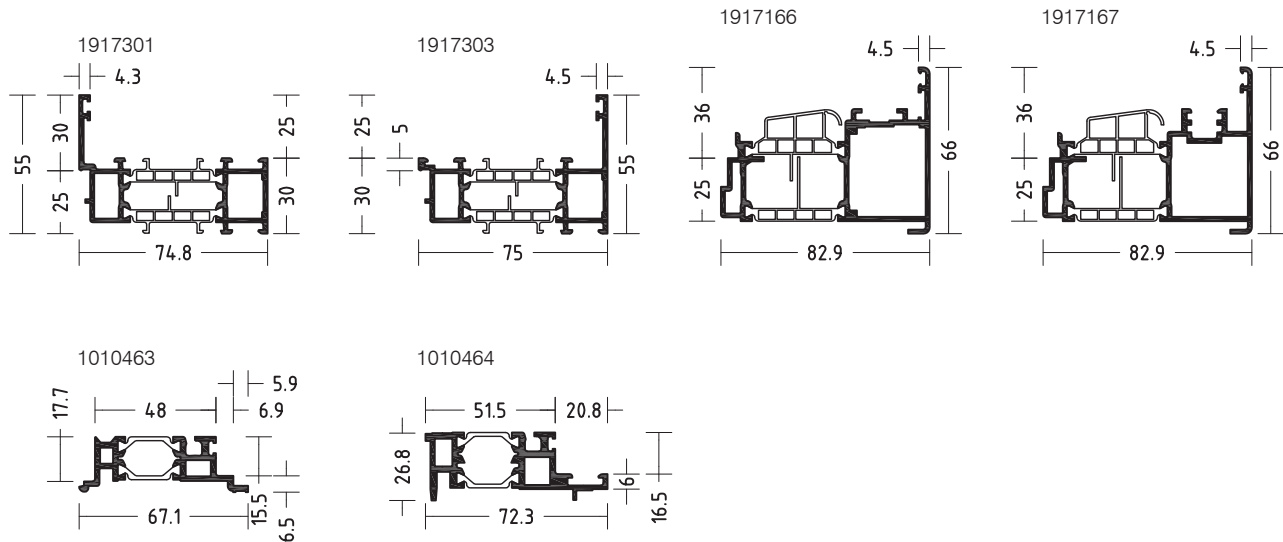

Profilübersicht Survey of profiles

Blendrahmenprofile verdeckter Flügel

Frame profiles for concealed sash

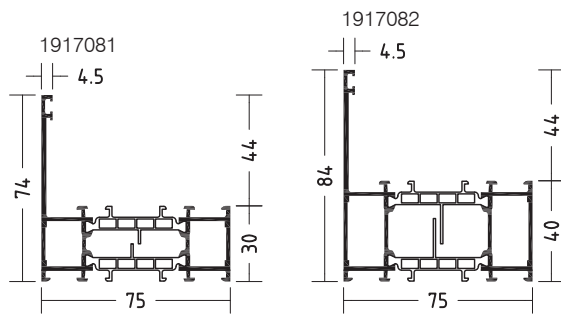

Einspann-Blendrahmenprofil verdeckter Flügel

Clamping frame profile for concealed sash

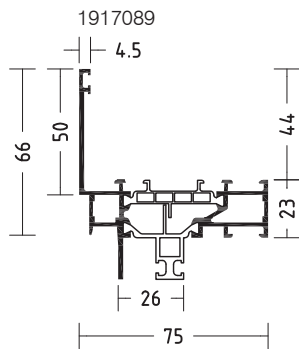

Dehnstoßprofil verdeckter Flügel

Expansion joint profile for concealed sash

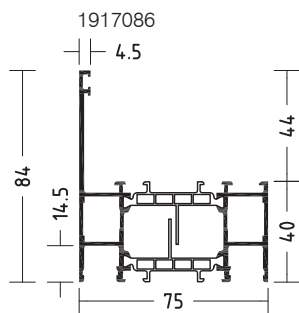

Profilübersicht
Survey of profiles

Verdecktliegende Flügelprofile
Concealed sash profiles

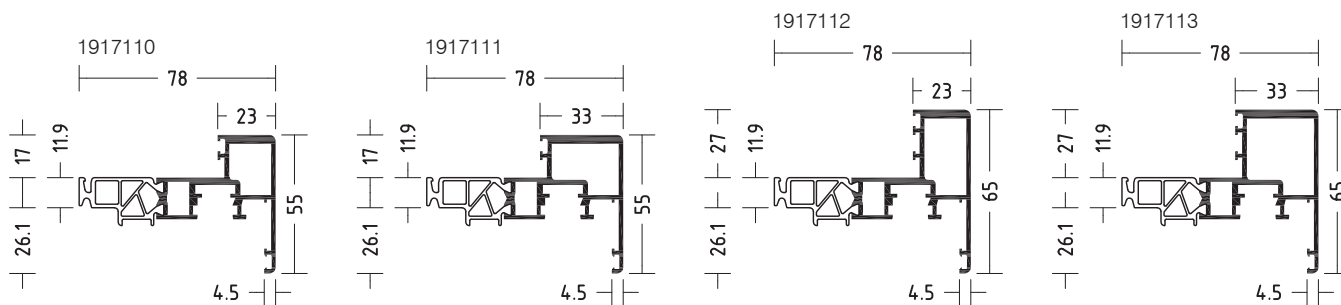

Verdecktliegende Stulpflügelprofile
Concealed double casement sash profiles

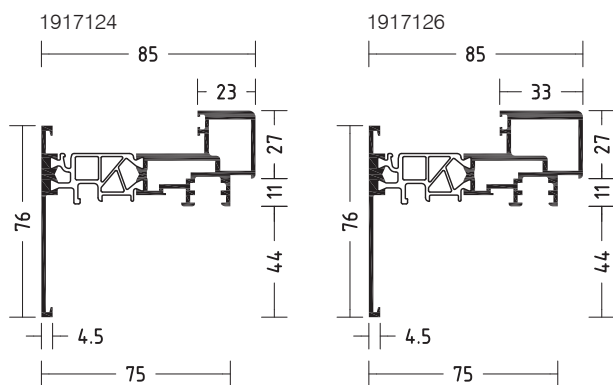

Kämpferprofile verdeckter Flügel
Transom profiles for concealed sash

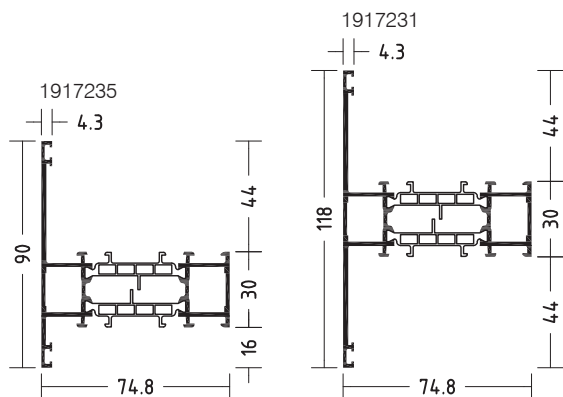

Profilübersicht
Survey of profiles

Neutralprofile
Neutral profiles

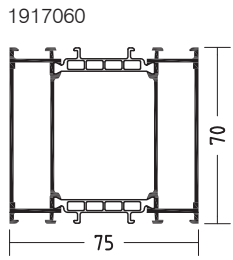
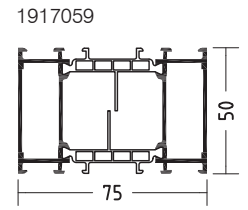
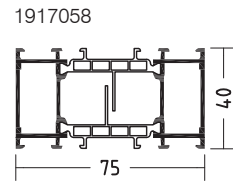
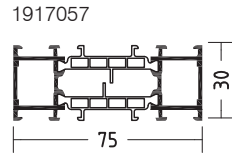
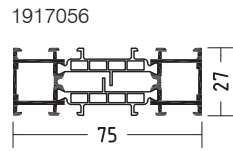
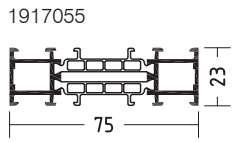

Profilübersicht
Survey of profiles

Blendrahmenprofil Klassik-Design

Classic design frame profile

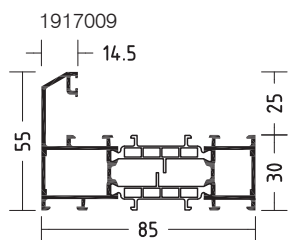

Kämpferprofil Klassik-Design

Classic design transom profile

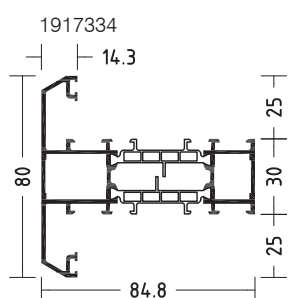

Flügelprofil Klassik-Design

Classic design sash profile

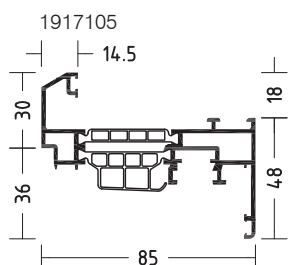

Stulpflügelprofil Klassik-Design

Classic design double casement profile

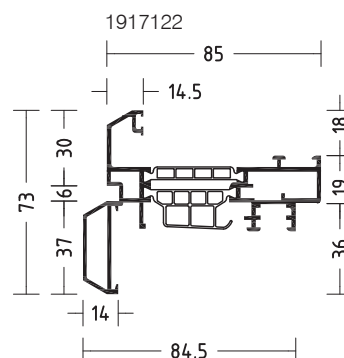

Sprossenprofile für Blendrahmen- und Flügelprofile Klassik-Design

Classic design glazing bars for frame and sash profiles

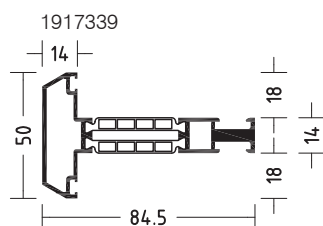
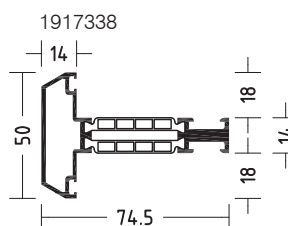

Profilübersicht - Senk-Klappfenster
Survey of profiles - Italian style window

Blendrahmenprofil

Frame profile

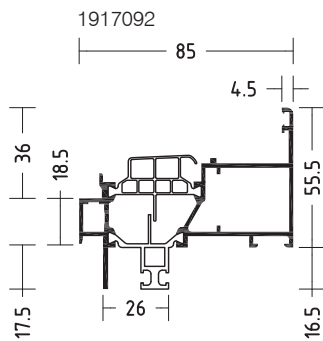

Flügelprofile nach Außen öffnend

Sash profiles outwards

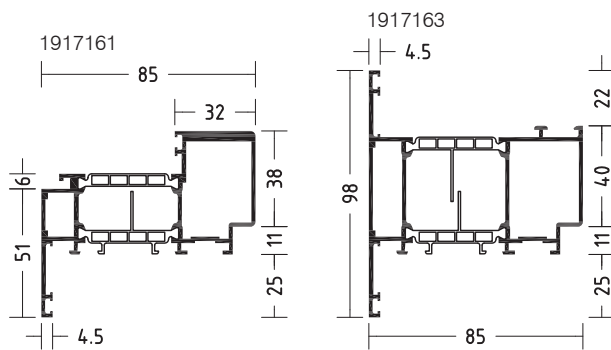

Aufsatzprofil

Supplementary profile

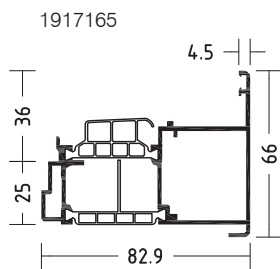

WICLINE 75

Profilübersicht - Klappfenster
Survey of profiles - Top-hung window

Blendrahmenprofil

Frame profile

1917093

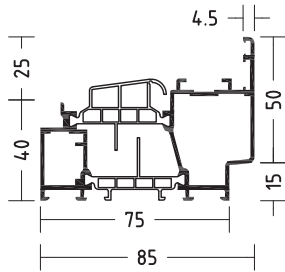

Flügelprofile nach Außen öffnend

Sash profiles outwards

1917161

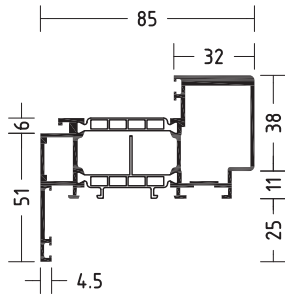

1917163

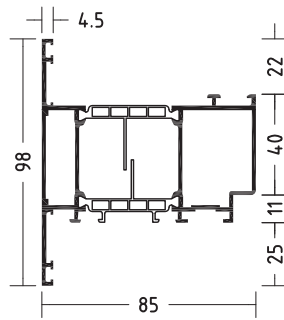

Aufsatzprofil

Supplementary profile

1917166

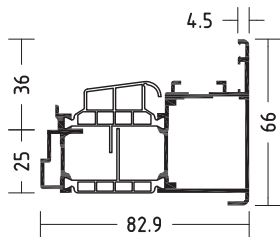

WICLINE 75

Profilübersicht - Schwing-Wende-Fenster
Survey of profiles - horizontal/vertical pivot window

Flügelprofile Sash profiles

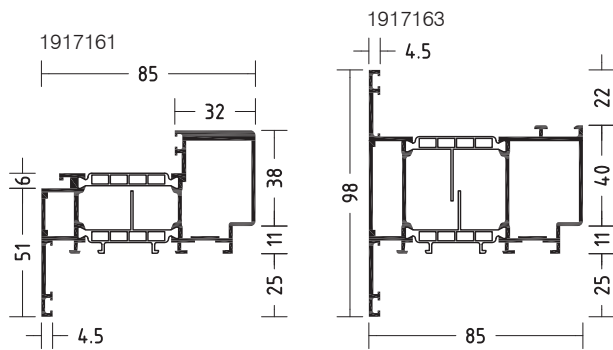

Aufsatzprofil Supplementary profile

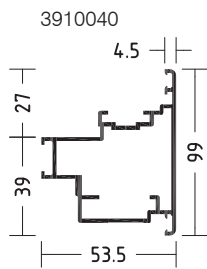

WICLINE 75

Profilübersicht - Parallel-Schiebe-Kipp-Fenster
Survey of profiles - parallel sliding tilt window

Blendrahmenprofile Frame profiles

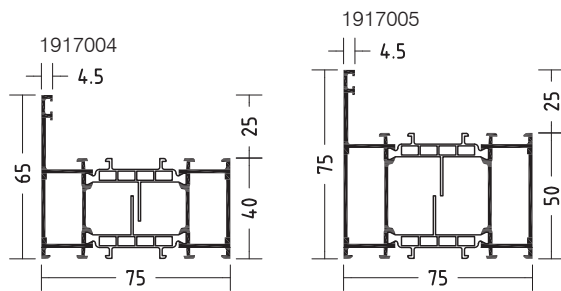

Flügelprofile Sash profiles

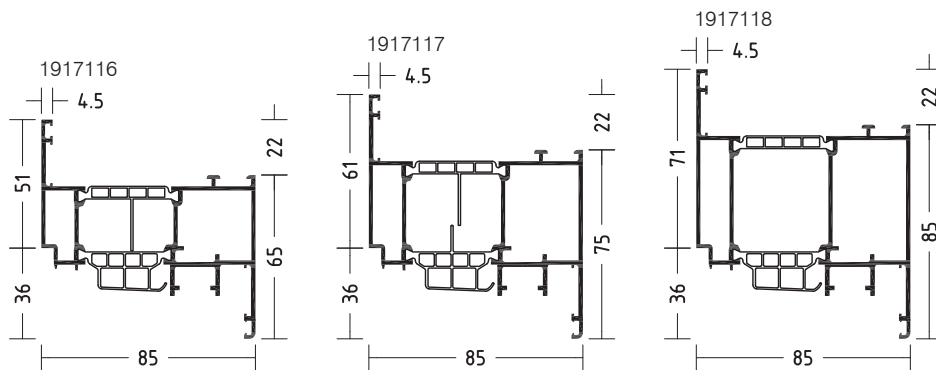

WICLINE 75

Profilübersicht - Lüftungsklappe Survey of profiles - Ventilation flap

Flügelprofile Sash profiles

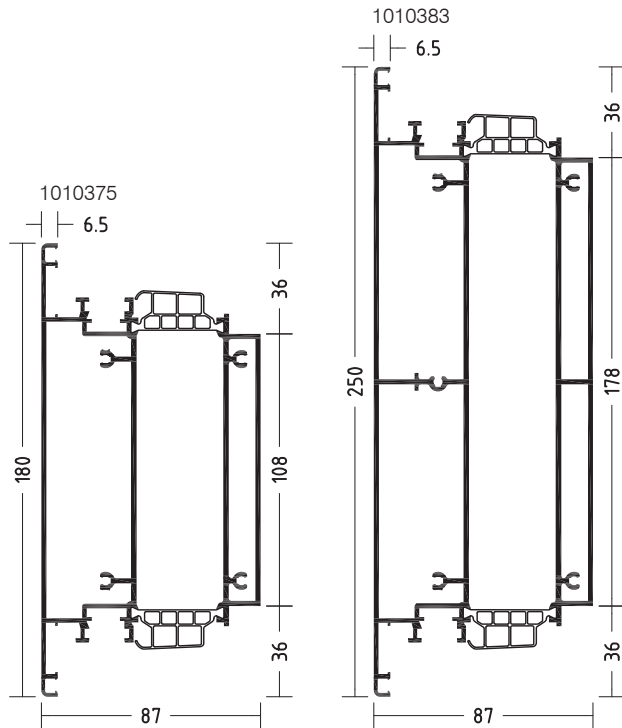

Aufsatzprofile Supplementary profiles

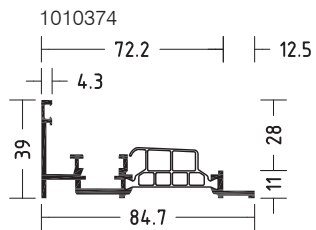

Profilübersicht
Survey of profiles

Glasleistenprofile 18 mm

Glazing bead profiles 18 mm

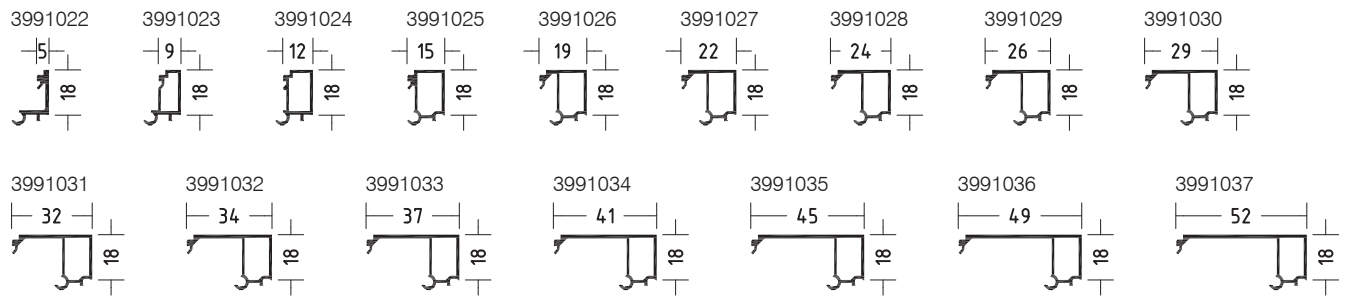

Glasleistenprofile 22 mm

Glazing bead profiles 22 mm

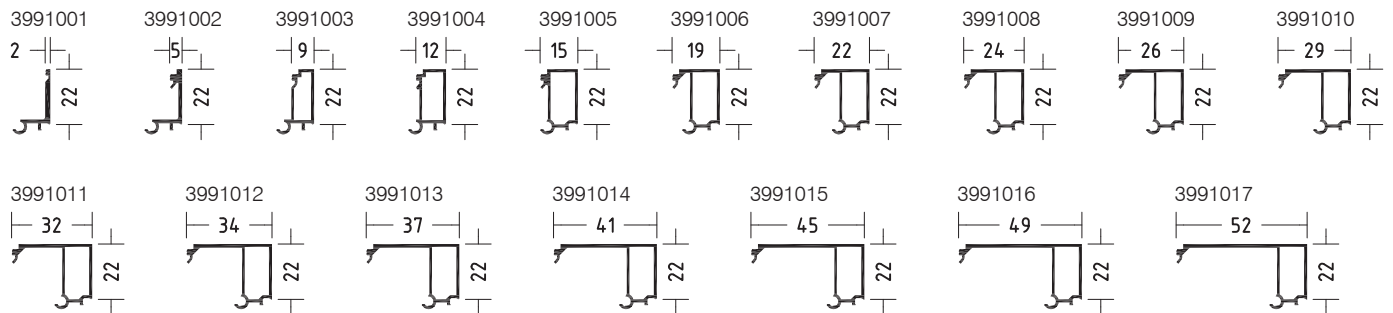

Glasleistenprofil für Senk-Klappfenster

Glazing bead profile for italian style window



Glasleistenprofile Trockenverglasung / Nassverglasung

Glazing bead profiles dry glazing / wet glazing

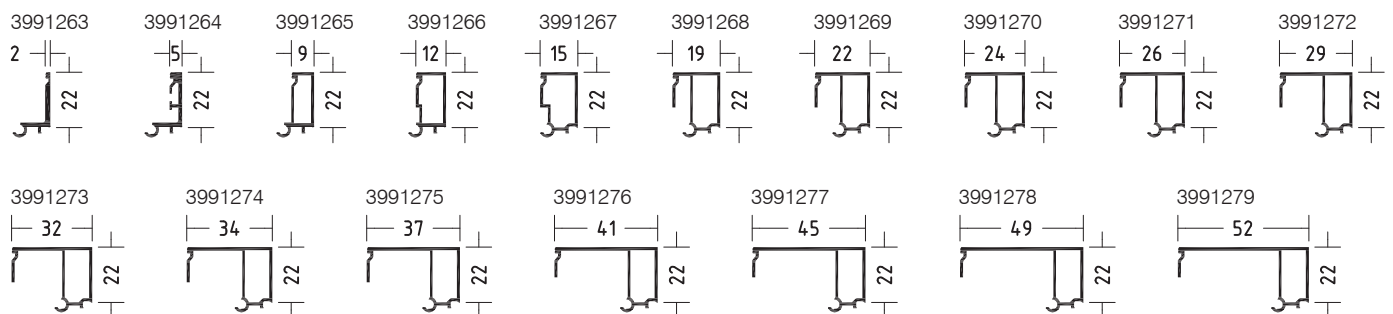

Glasleistenprofile Industrie-Design

Glazing bead profiles Industrial design

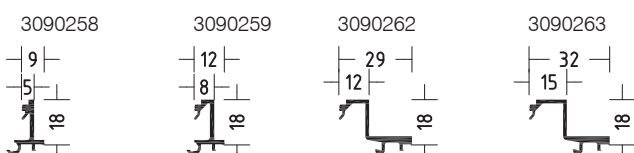

Sichtbarer Flügel

Visible sash

Profile

















Profiles

3/26

Anwendungsbeispiele

Examples of application

3/107

														
	m	mm	mm											
 1917001	6,5	285	71	4950006	2x4070000	1x4960002	1x4070000	-	5910006	5940101	5940001	5930003		
				4950006	2x4070000	1x4960002	1x4070000	-	5910006	5940101	5940001	5930003		
1917002	6,5	293	79	4950007	2x4070000	1x4960003	1x4070000	1x4070030	5910006	5940101	5940001	5930003		
				4950007	2x4070000	1x4960003	1x4070000	1x4070030	5910006	5940101	5940001	5930003		

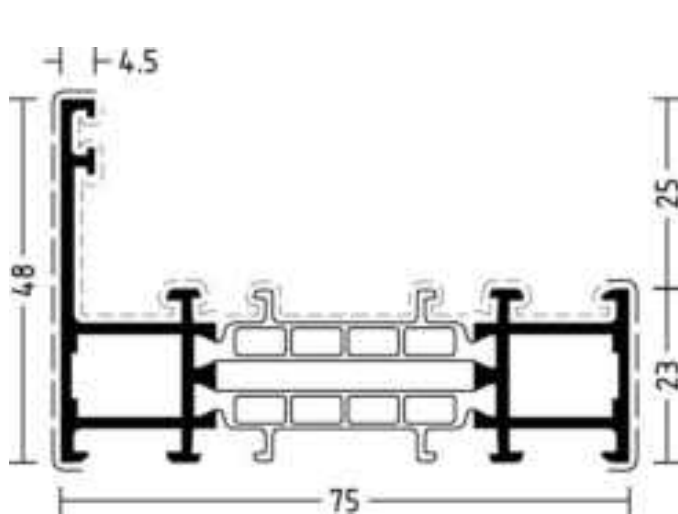





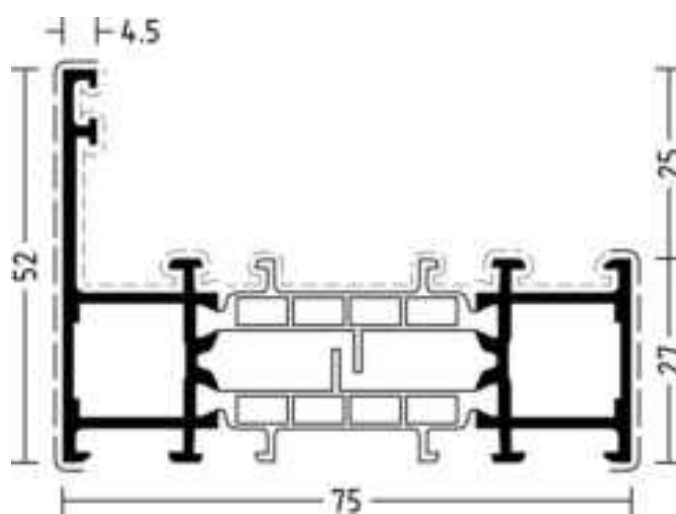









1917001

Gelenckwinkler und Gelenkverbinder siehe Zusatzartikel.
See additional articles for hinged corner angles and hinged connectors.



1917002

Gelenckwinkler und Gelenkverbinder siehe Zusatzartikel.
See additional articles for hinged corner angles and hinged connectors.

												
	m	mm	mm									
 1917003	6,5	299	170	4950008	2x4070000	1x4960004	1x4070000	1x4070030	5910006	5940101	5940001	5930003
				4950008	2x4070000	1x4960004	1x4070000	1x4070030	5910006	5940101	5940001	5930003
1010488	6,5	316	78	4050571	2x4070000	-	-	-	5910006	-	5940001	5930003
				4950008	2x4070000	-	-	-	5910006	5940101	5940001	5930003

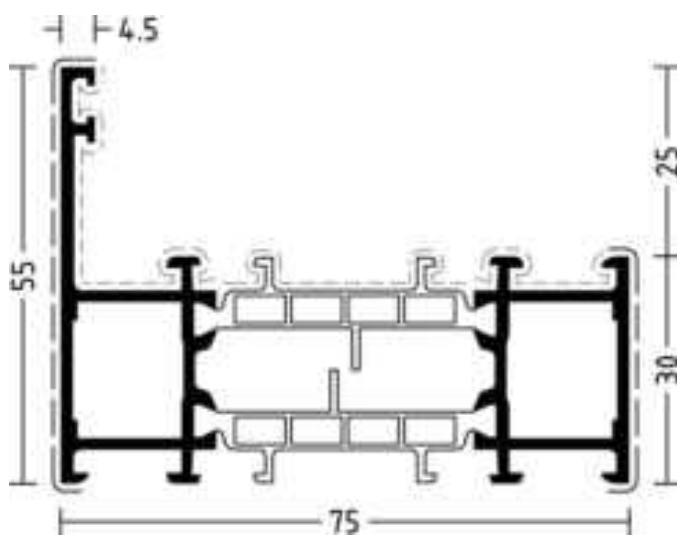





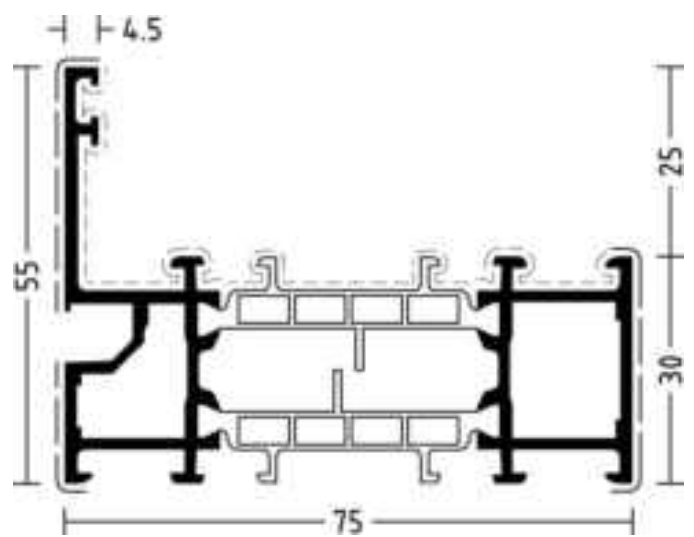













1917003

Gelenkeckwinkel und Gelenkverbinder siehe Zusatzartikel.
See additional articles for hinged corner angles and hinged connectors.



1010488

Stoßverbinder für Kämpferprofile siehe Seiten „Kämpferstoßverbindung“.
See pages „Transom butt-joint connection“ for butt-joint connectors for transom profiles.

																
	m	mm	mm													
 1010489	6,5	319	70	4050571	2x4070000	-	-	-	5010632	-	5940001	-				
				4950008	2x4070000	-	-	-	5010632	-	5940001	-				
1917004	6,5	319	105	4950009	2x4070000	1x4960005	1x4070000	1x4070030	5910006	5940101	5940001	5930003				
				4950009	2x4070000	1x4960005	1x4070000	1x4070030	5910006	5940101	5940001	5930003				

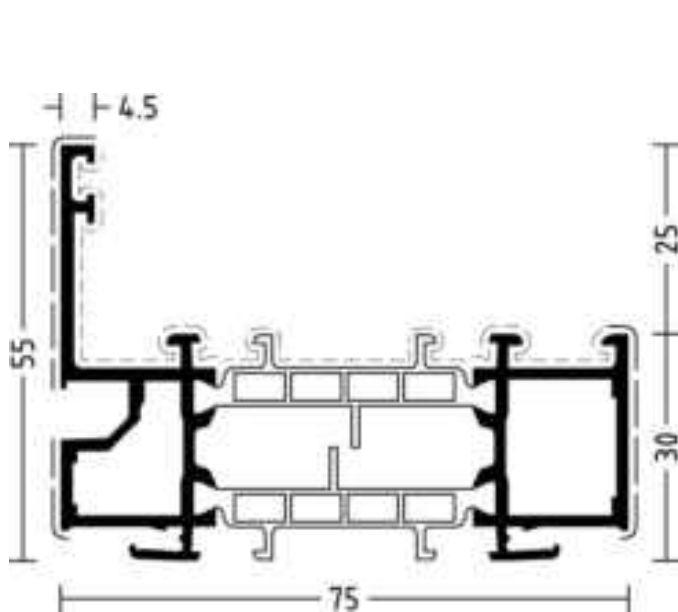



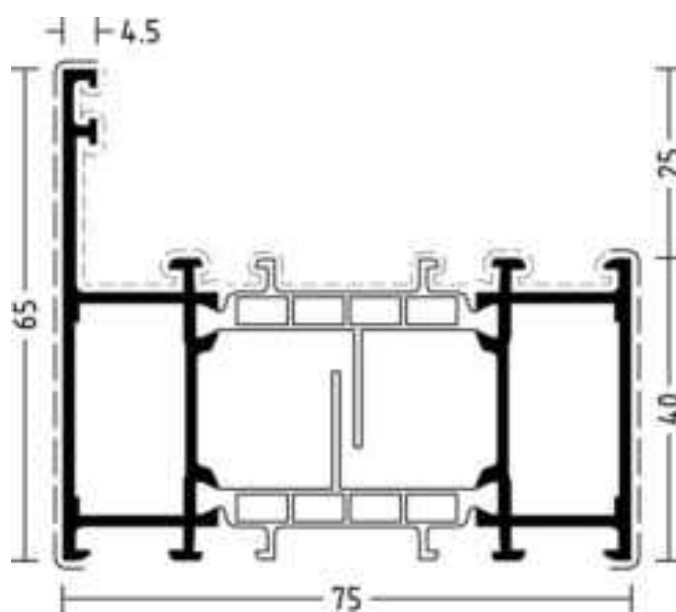

1010489

Stoßverbinder für Kämpferprofile siehe Seiten „Kämpferstoßverbindung“.
See pages „Transom butt-joint connection“ for butt-joint connectors for transom profiles.

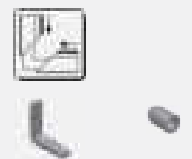

1917004

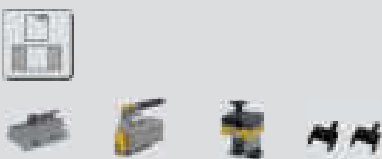
Gelenkeckwinkel und Gelenkverbinder siehe Zusatzartikel.
See additional articles for hinged corner angles and hinged connectors.

												
	m	mm	mm									
 1010491	6,5	336	98	4050574	2x4070000	-	-	-	5910006	5940101	5940001	5930003
				4950009	2x4070000	-	-	-	5910006	5940101	5940001	5930003
 1010492	6,5	338	94	4050574	2x4070000	-	-	-	5010632	-	5940001	-
				4950009	2x4070000	-	-	-	5010632	-	5940001	-

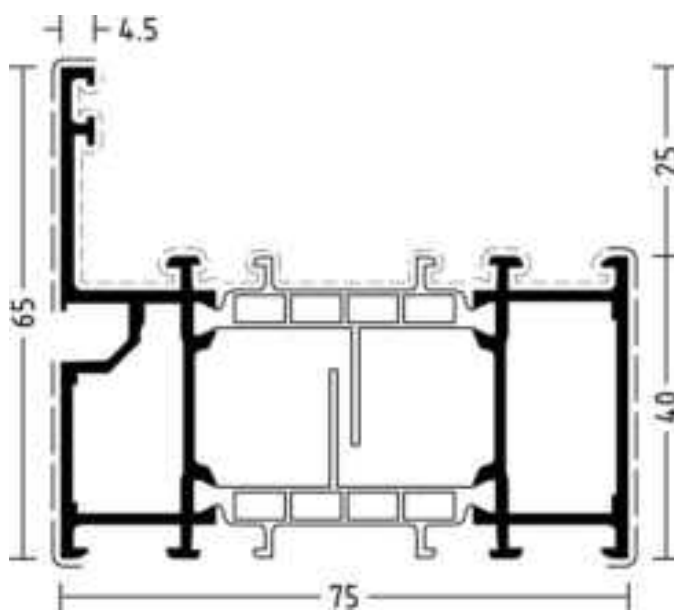





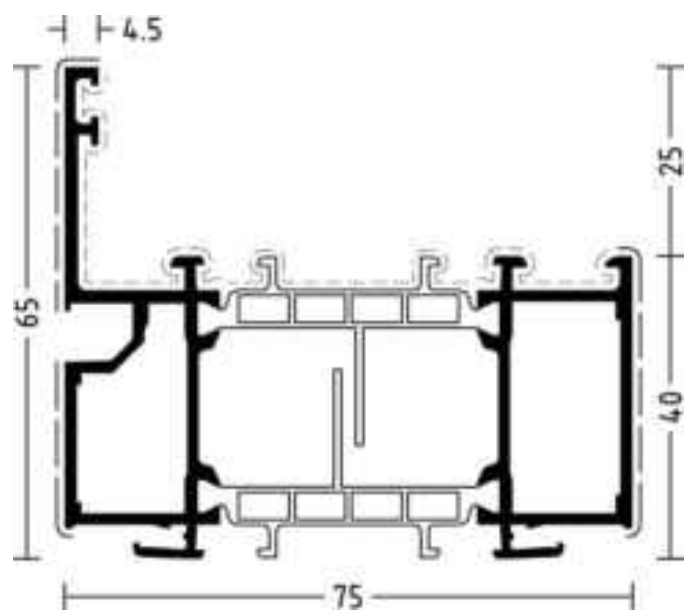









1010491

Stoßverbinder für Kämpferprofile siehe Seiten „Kämpferstoßverbinding“.
See pages „Transom butt-joint connection“ for butt-joint connectors for transom profiles.



1010492

Stoßverbinder für Kämpferprofile siehe Seiten „Kämpferstoßverbinding“.
See pages „Transom butt-joint connection“ for butt-joint connectors for transom profiles.



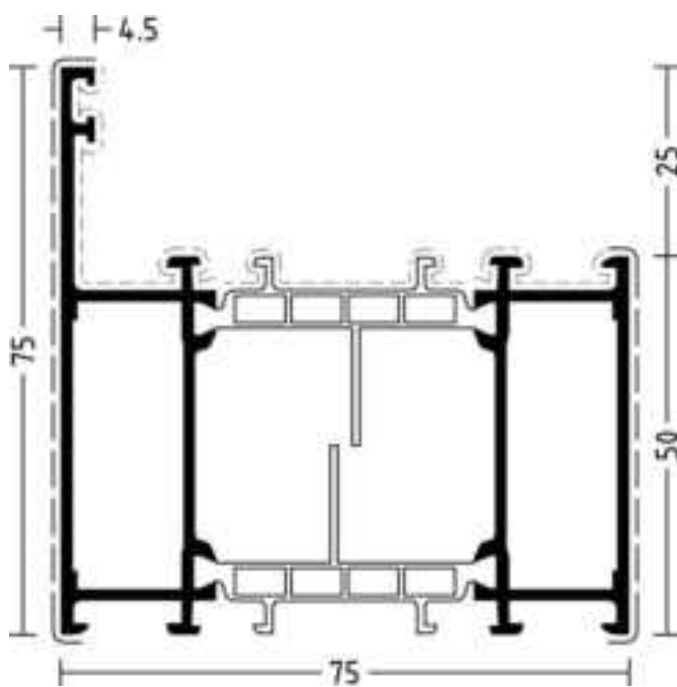











												
	m	mm	mm									
 1917005	6,5	339	125	4950010	2x4070000	1x4960006	1x4070000	1x4070030	5910006	5940101	5940001	5930003
				4950010	2x4070000	1x4960006	1x4070000	1x4070030	5910006	5940101	5940001	5930003



1917005







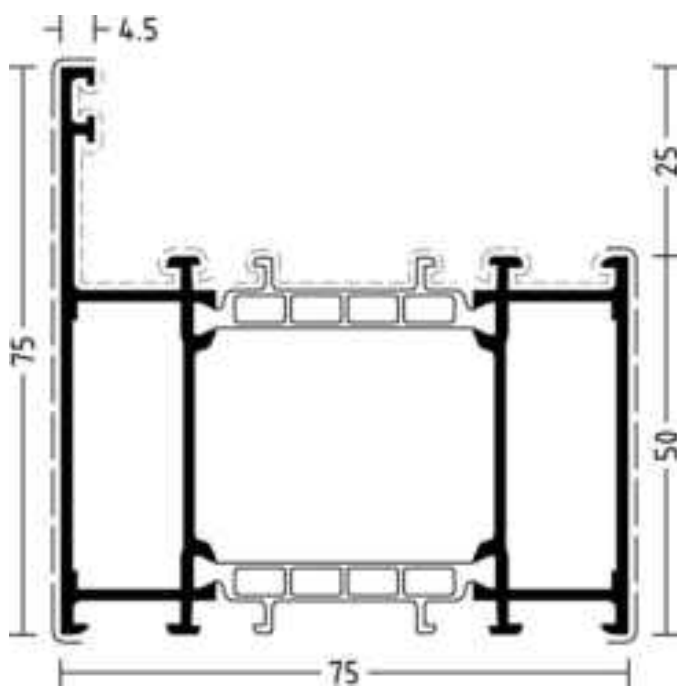







WICLINE 75

Blendrahmenprofile Frame profiles

	 m	 mm	 mm									
 1910148	6,5	339	125	4950010	2x4070000	1x4960006	1x4070000	1x4070030	5910006	5940101	5940001	5930003
				4950010	2x4070000	1x4960006	1x4070000	1x4070030	5910006	5940101	5940001	5930003



1910148



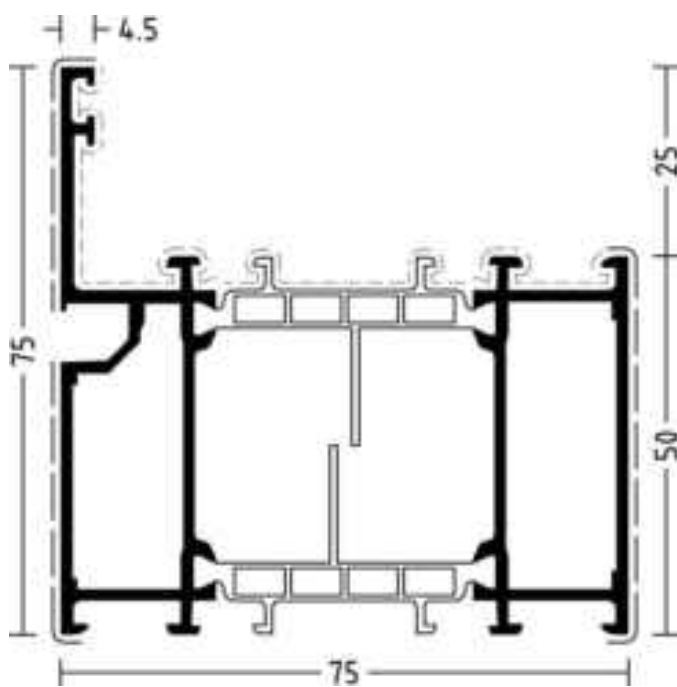











												
	m	mm	mm									
 1010495	6,5	356	118	4050577	2x4070000	-	-	-	5910006	5940101	5940001	5930003
				4950010	2x4070000	-	-	-	5910006	5940101	5940001	5930003



1010495

Stoßverbinder für Kämpferprofile siehe Seiten „Kämpferstoßverbindung“.

See pages „Transom butt-joint connection“ for butt-joint connectors for transom profiles.

	 m	 mm	 mm										
 1917009	6,5	356	91	4950012	2x4070000	1x4960004	1x4070000	1x4070030	5910013	5940101	-	5930005	
				4950008	2x4070000	1x4960004	1x4070000	1x4070030	5910013	5940101	-	5930005	
1917055	6,5	222	46	4950006	2x4070000	1x4960002	1x4070000	-	5910006	5940101	5940001	5930003	
				4950006	2x4070000	1x4960002	1x4070000	-	5910006	5940101	5940001	5930003	
1917056	6,5	230	54	4950007	2x4070000	1x4960003	1x4070000	1x4070030	5910006	5940101	5940001	5930003	
				4950007	2x4070000	1x4960003	1x4070000	1x4070030	5910006	5940101	5940001	5930003	

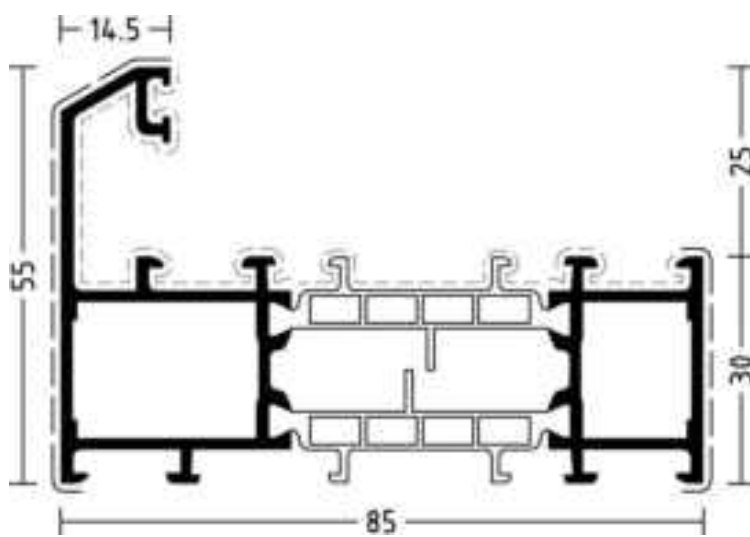

1917009



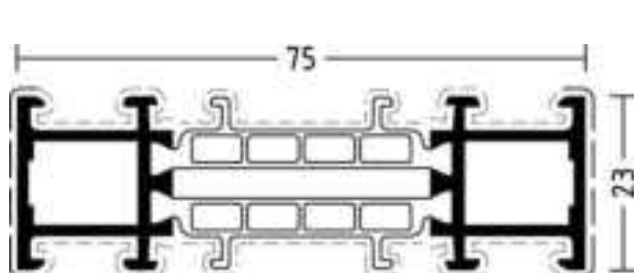



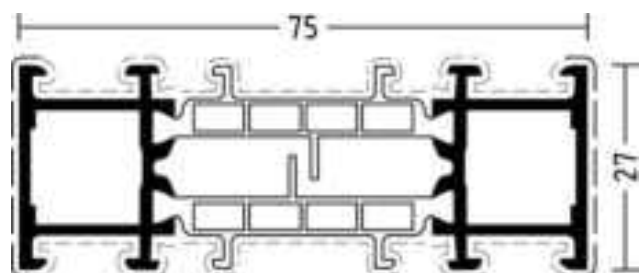







Blendrahmen Klassik-Design
Frame Classic design



1917055



1917056

	 m	 mm	 mm									
 1917057	6,5	236	60	4950008	2x4070000	1x4960004	1x4070000	1x4070030	5910006	5940101	5940001	5930003
				4950008	2x4070000	1x4960004	1x4070000	1x4070030	5910006	5940101	5940001	5930003
1917058	6,5	256	80	4950009	2x4070000	1x4960005	1x4070000	1x4070030	5910006	5940101	5940001	5930003
				4950009	2x4070000	1x4960005	1x4070000	1x4070030	5910006	5940101	5940001	5930003
1917059	6,5	276	100	4950010	2x4070000	1x4960006	1x4070000	1x4070030	5910006	5940101	5940001	5930003
				4950010	2x4070000	1x4960006	1x4070000	1x4070030	5910006	5940101	5940001	5930003

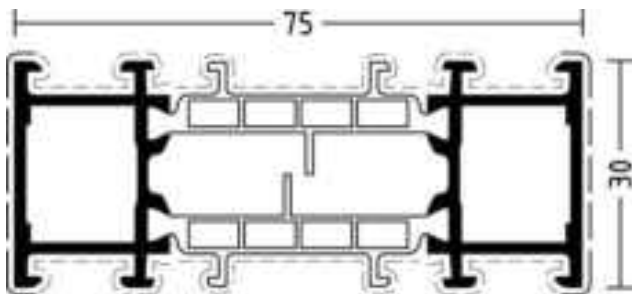

1917057

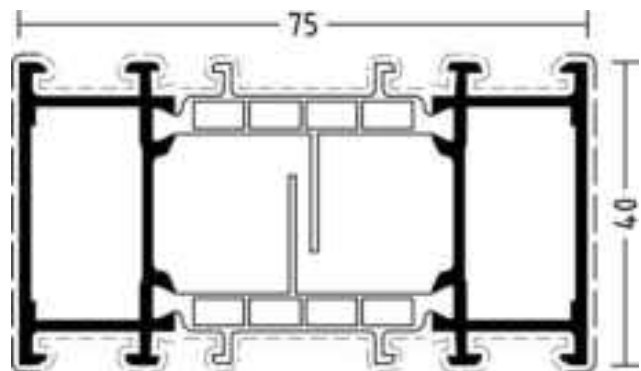

1917058

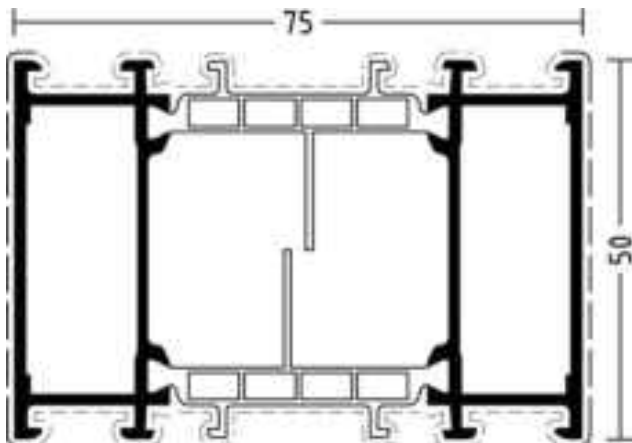

1917059

Icon	m	mm	mm	Icon		Icon			Icon				
				Icon	Icon	Icon	Icon	Icon	Icon	Icon	Icon	Icon	Icon
☒	1917060	6,5	316	140	-	-	1x4960008	2x4070000	2x4070030	5910006	5940101	5940001	5930003
☒					-	-	1x4960008	2x4070000	2x4070030	5910006	5940101	5940001	5930003

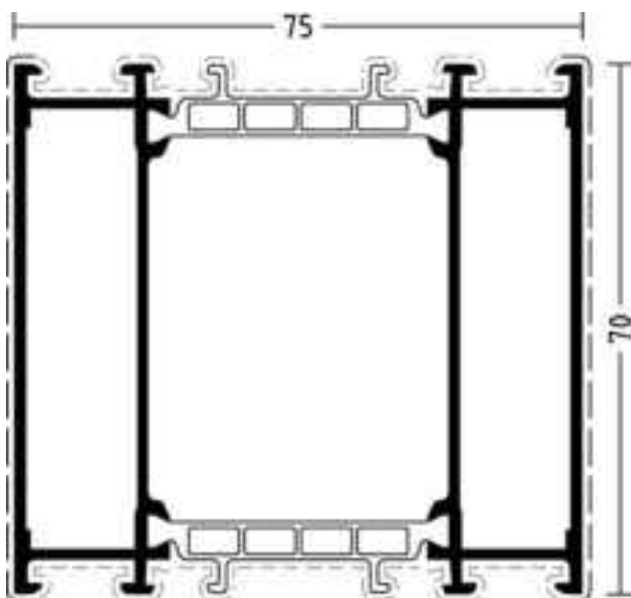

1917060

Eckverbindung außen:

Zuschnitt aus 3900040 oder 3900053 (13.20) + 2x 4070000

Eckverbindung innen:



Zuschnitt aus 3900040 oder 3900053 (13.20) + 2x 4070000

Corner connection outside:

Cutting with 3900040 or 3900053 (13.20) + 2x 4070000

Corner connection inside:

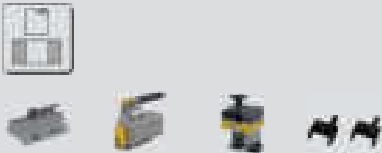

Cutting with 3900040 or 3900053 (13.20) + 2x 4070000

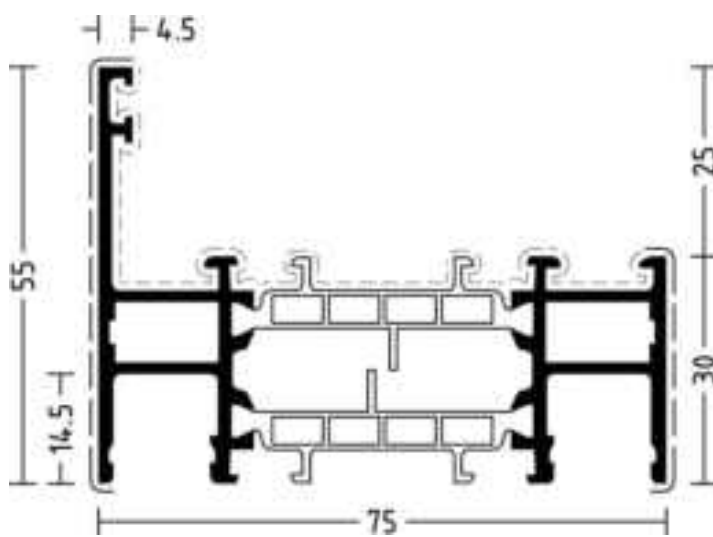
□ 1917062	 m mm mm											
	6,5	330	85	4950005	2x4070009	-	-	-	5910006	-	-	5930003
□				4950005	2x4070009	-	-	-	5910006	-	-	5930003

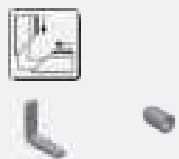

1917062

Gelenckwinkel und Gelenkverbinder siehe Zusatzartikel.
See additional articles for hinged corner angles and hinged connectors.

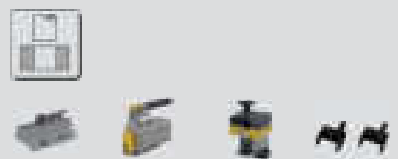
□ 1917064	 m mm mm											
	□	6,5	350	105	4950008	2x4070000	1x4960004	1x4070000	1x4070030	5910006	5940101	5940001
□				4950008	2x4070000	1x4960004	1x4070000	1x4070030	5910006	5940101	5940001	5930003

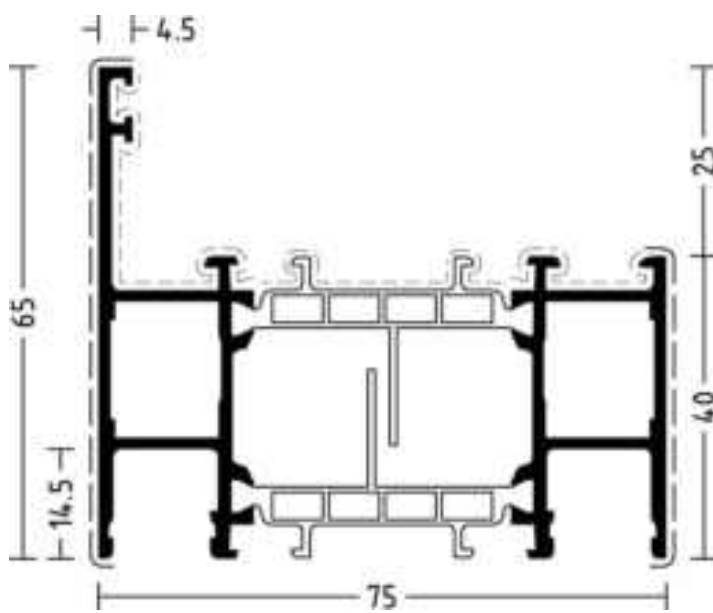

















1917064

Gelenkeckwinkel und Gelenkverbinder siehe Zusatzartikel.
See additional articles for hinged corner angles and hinged connectors.

WICLINE 75

Blendrahmenprofile Frame profiles

	 m	 mm	 mm	 		 			 			
 1917067	6,5	410	165	4950011	2x4070000	1x4960007	2x4070000	2x4070030	5910006	5940101	5940001	5930003
				4950011	2x4070000	1x4960007	2x4070000	2x4070030	5910006	5940101	5940001	5930003

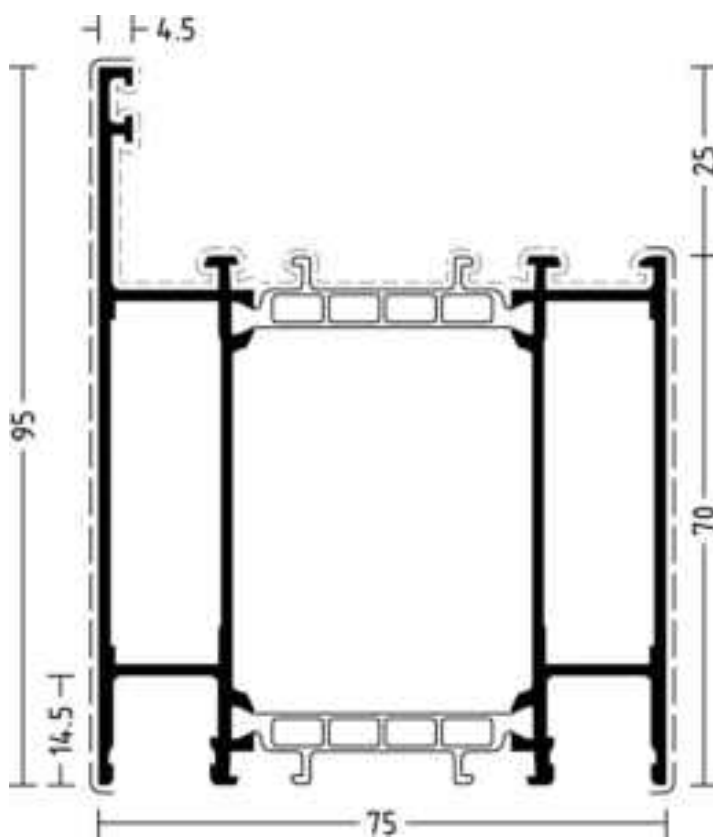





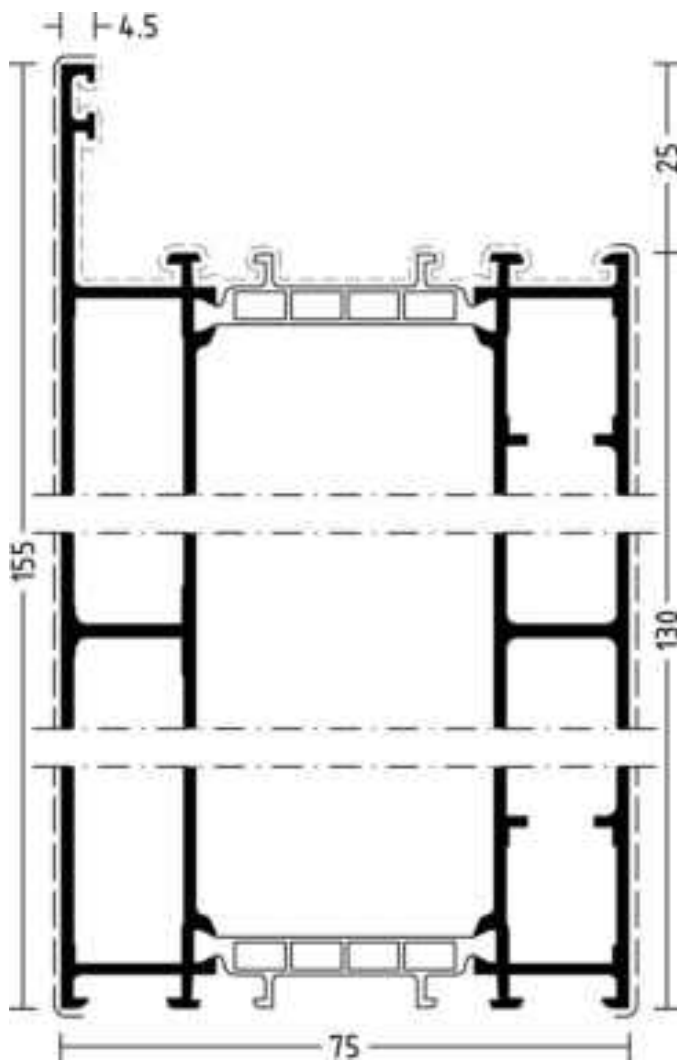





1917067

Icon	m	mm	mm	Icon		Icon			Icon				
				Icon	Icon	Icon	Icon	Icon	Icon	Icon	Icon	Icon	
☒	1910172	6,5	498	285	-	-	2x4960008	2x4070000	2x4070030	5910006	5940101	5940001	-
☒		-	-	-	-	-	2x4960004	2x4070000	2x4070030	5910006	5940101	5940001	-



1910172

□ □	1917068	 m mm mm			 		  			   			
		6,5	347	96	4950006	2x4070000	1x4960002	1x4070000	-	5910006	5940101	5940001	5930003
□ □				4950006	2x4070000	1x4960002	1x4070000	-	5910006	5940101	5940001	5930003	

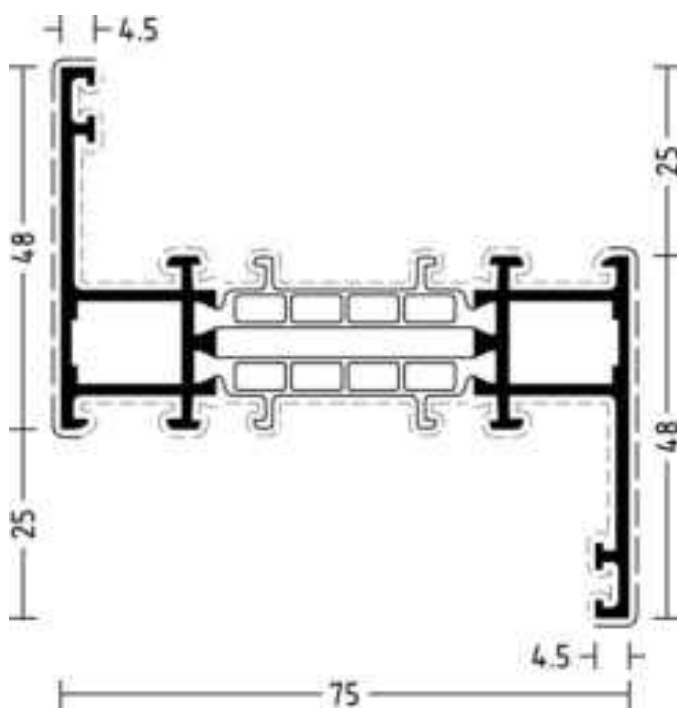

1917068





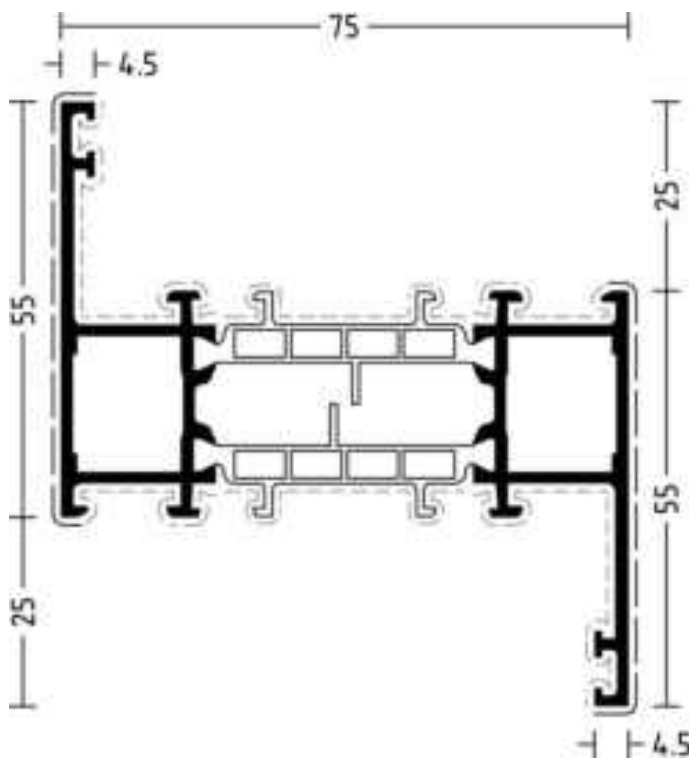









Gelenkeckwinkel und Gelenkverbinder siehe Zusatzartikel.
See additional articles for hinged corner angles and hinged connectors.

Icon	1917069	Dimensions			Accessories 1		Accessories 2			Accessories 3			
		m	mm	mm	Part No.	Qty	Part No.	Qty	Part No.	Qty	Part No.	Qty	Part No.
☒	1917069	6,5	361	110	4950008	2x4070000	1x4960004	1x4070000	1x4070030	5910006	5940101	5940001	5930003
☒					4950008	2x4070000	1x4960004	1x4070000	1x4070030	5910006	5940101	5940001	5930003



1917069

Gelenkeckwinkel und Gelenkverbinder siehe Zusatzartikel.
See additional articles for hinged corner angles and hinged connectors.

													
	m	mm	mm										
 1917073	6,5	361	110	4950008	2x4070000	1x4960004	1x4070000	1x4070030	5910006	5940101	5940001	5930003	
				4950008	2x4070000	1x4960004	1x4070000	1x4070030	5910006	5940101	5940001	5930003	
1917076	6,5	322	70	4950013	2x4070008	-	-	-	5910016	5940107	5940010	5930010	
				4950006	2x4070008	-	-	-	5910016	5940101	5940010	5930010	

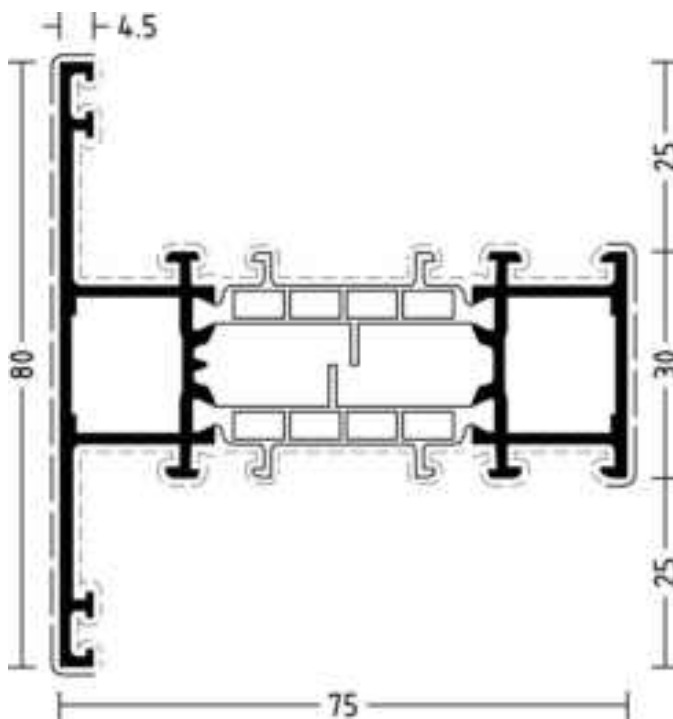





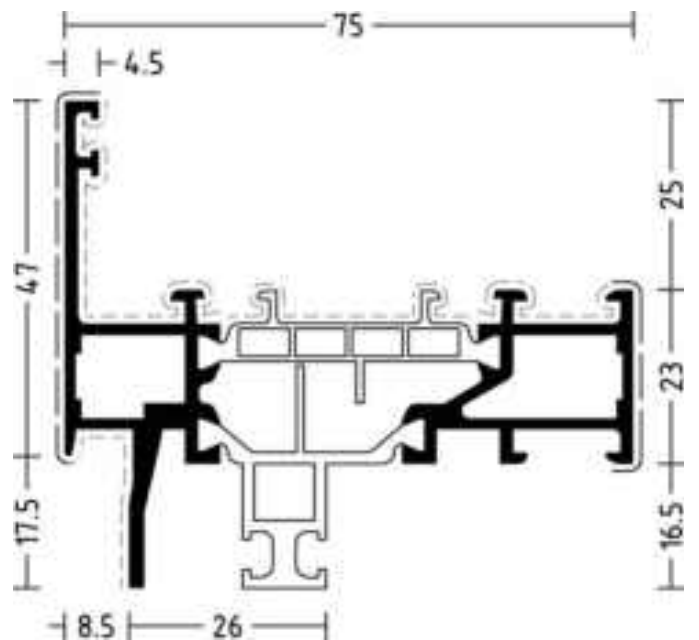









1917073

Gelenkeckwinkel und Gelenkverbinder siehe Zusatzartikel.
See additional articles for hinged corner angles and hinged connectors.



1917076

Einspannblendrahmen
Clamping Frame

	 m	 mm	 mm									
 1917077	6,5	336	84	4950014	2x4070008	-	-	-	5910016	5940107	5940010	5930010
				4950008	2x4070008	-	-	-	5910016	5940101	5940010	5930010
1910134	6,5	322	70	4950013	2x4070008	-	-	-	5910016	5940107	5940010	5930010
				4950006	2x4070008	-	-	-	5910016	5940101	5940010	5930010

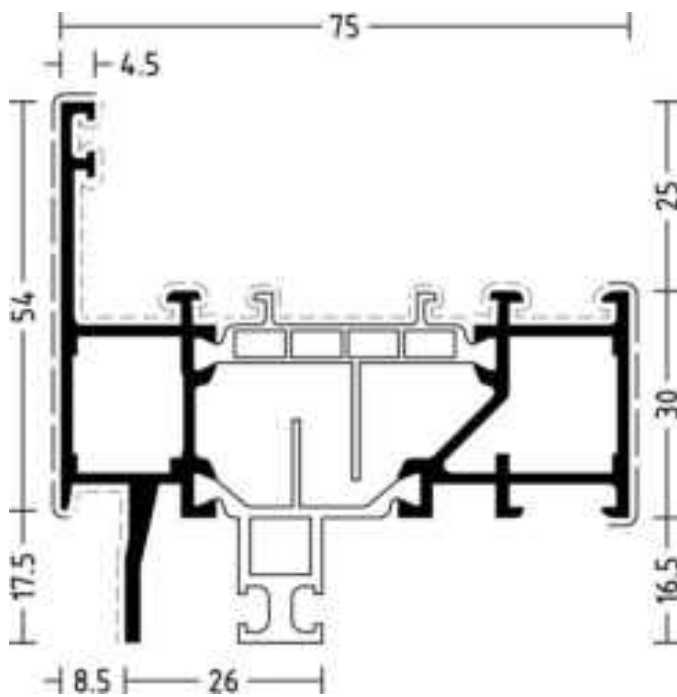

1917077



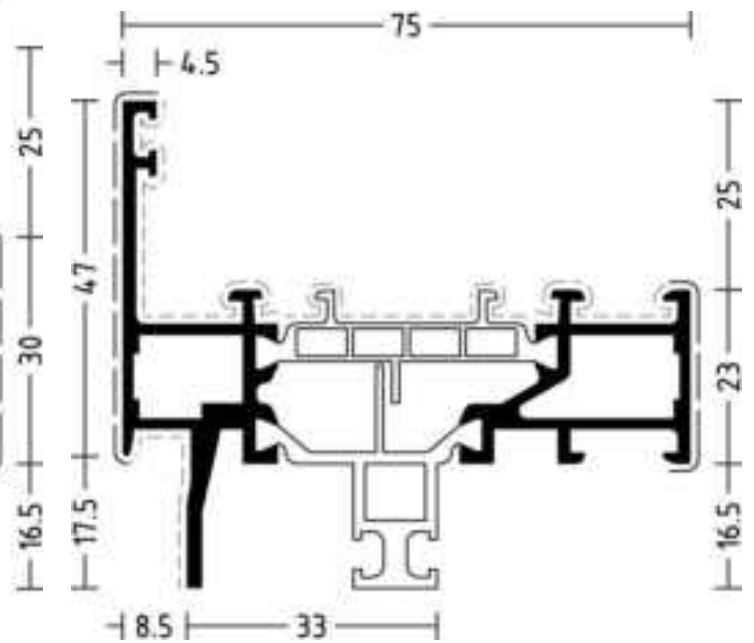











Einspannblendrahmen
Clamping frame



1910134







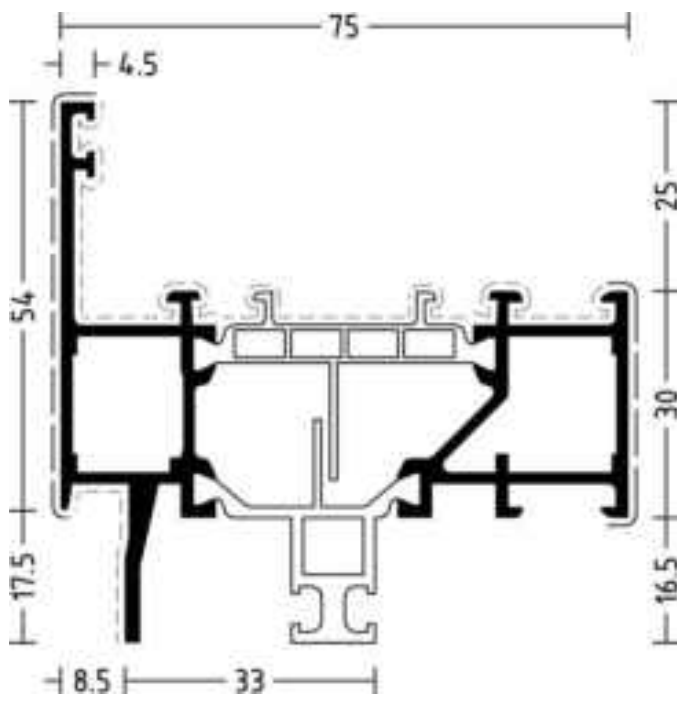







WICLINE 75

Blendrahmenprofile Frame profiles

	 m	 mm	 mm									
 1910135	6,5	336	84	4950014	2x4070008	-	-	-	5910016	5940107	5940010	5930010
				4950008	2x4070008	-	-	-	5910016	5940101	5940010	5930010







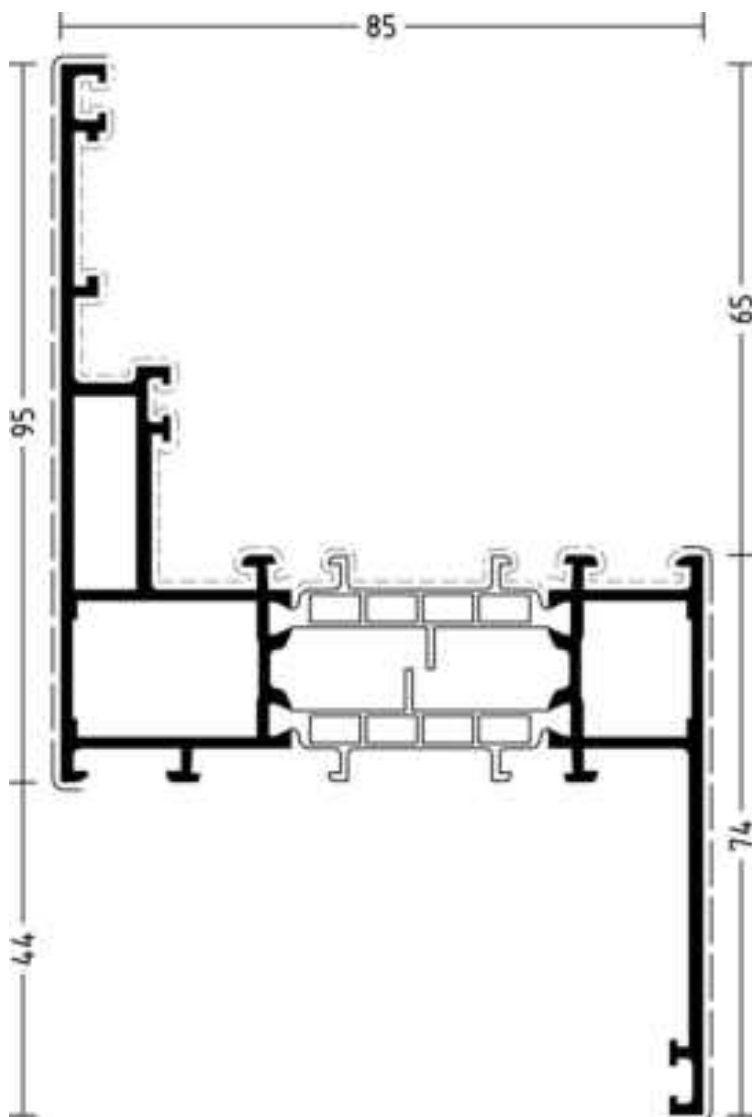









1910135

	 m	 mm	 mm									
 1310991	6,5	532	169	4950012	2x4070000	1x4960004	1x4070000	1x4070030	5910021	5940101	-	-
				4950008	2x4070000	1x4960004	1x4070000	1x4070030	5910021	5940101	-	-



1310991





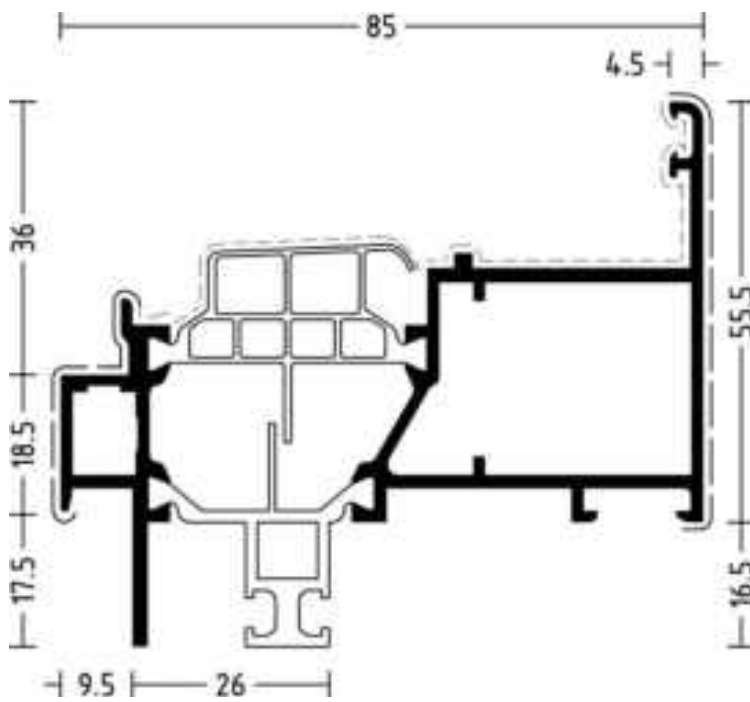









Zusätzlicher Eckwinkel Außenschale: 4950349 (verkleben)
Additional corner angle outer shell: 4950349 (to glue)

	 m	 mm	 mm									
 1917092	6,5	323	74	4950055	2x4070000	-	-	-	5910037	5940107	-	5930026
				4950024	2x4070000	-	-	-	5910037	5940107	-	5930026



1917092





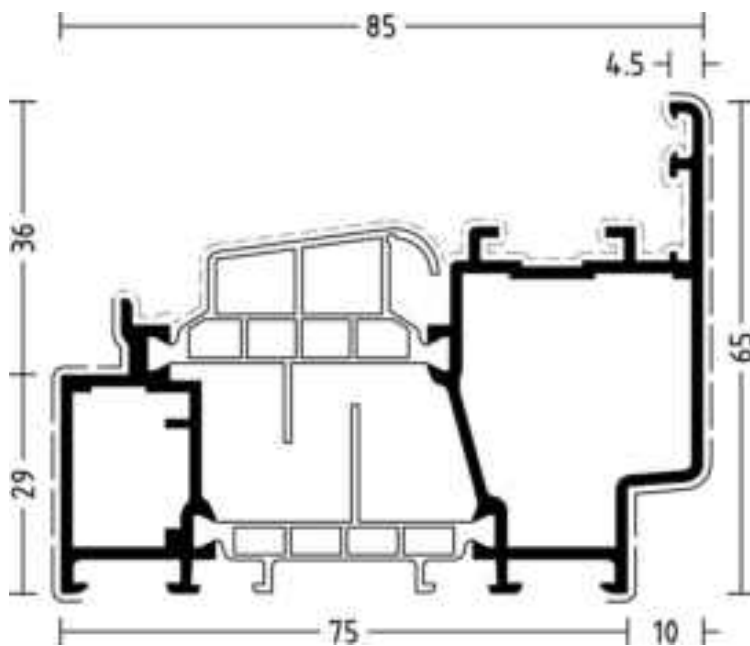













Einspannblendrahmen, Senk- Klappfenster
Clamping frame, Italian style window

	 m	 mm	 mm									
 1917093	6,5	334	106	4950047	2x4070000	-	-	-	5910038	-	-	5930027
				4950056	2x4070000	-	-	-	5910038	-	-	5930027



1917093

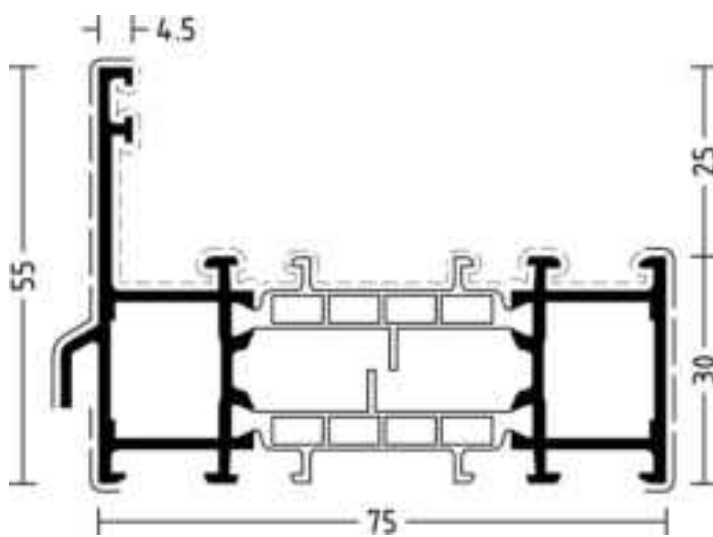

Klappfenster, Drehfenster auswärts
Top hung window, Turn window outwards

 1010344	 m	 mm	 mm										
													
	6,5	323	88	4950008	2x4070000	1x4960004	1x4070000	1x4070030	5910006	5940101	5940001	5930003	
				4950008	2x4070000	1x4960004	1x4070000	1x4070030	5910006	5940101	5940001	5930003	

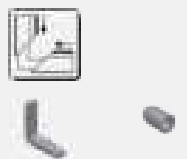

1010344

Gelenkeckwinkel und Gelenkverbinder siehe Zusatzartikel
 See additional articles for hinged corner angles and hinged connectors.

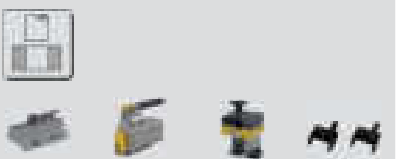
□	1010346	 m mm mm											
		□	1010346	6,5	343	108	4950009	2x4070000	1x4960005	1x4070000	1x4070030	5910006	5940101
□					4950009	2x4070000	1x4960005	1x4070000	1x4070030	5910006	5940101	5940001	5930003

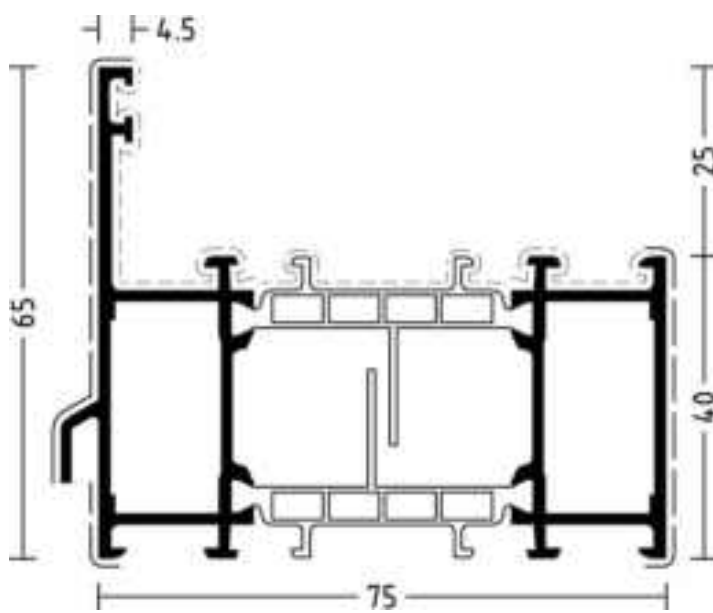

1010346





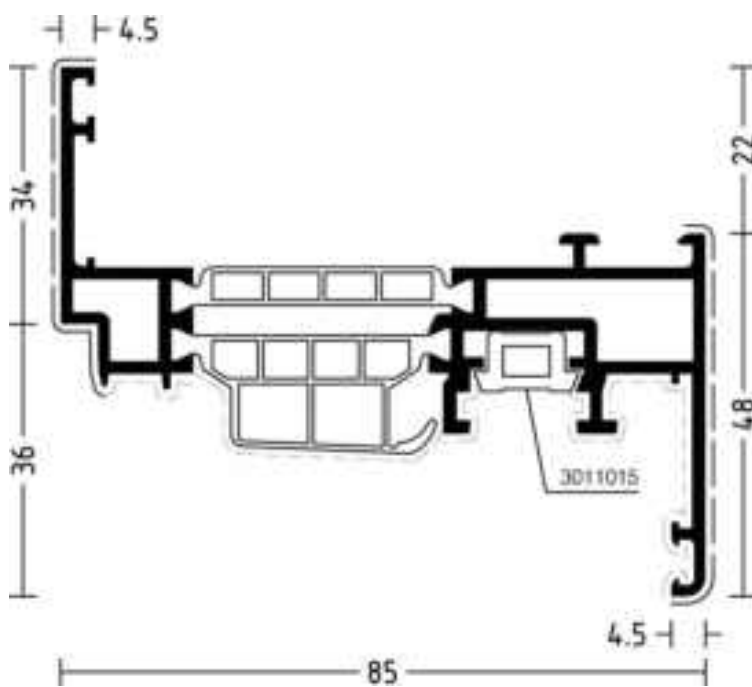









Gelenkeckwinkel und Gelenkverbinder siehe Zusatzartikel
See additional articles for hinged corner angles and hinged connectors.

Icon	1917101	Dimensions			Hardware			Accessories					
		m	mm	mm	Part	Part	Part	Part	Part	Part	Part		
☒	1917101	6,5	387	82	4950018	2x4070000	-	-	-	5910061	5940118	5940022	5930019
☒					4950028	2x4070000	-	-	-	5910061	5940118	5940022	5930019



1917101





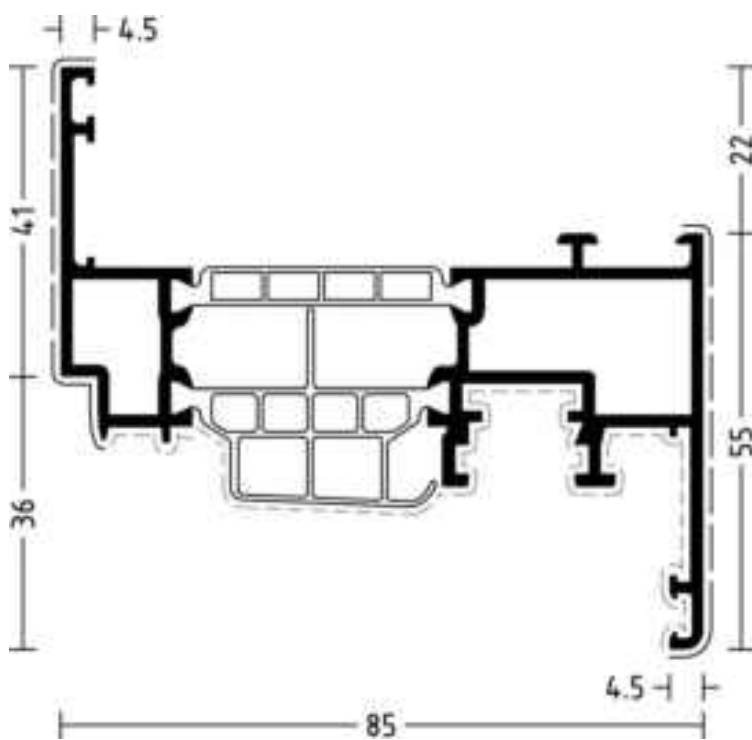









Gelenckwinkel und Gelenkverbinder siehe Zusatzartikel.
See additional articles for hinged corner angles and hinged connectors.

	 m	 mm	 mm									
 1917102	6,5	401	96	4950019	2x4070000	-	-	-	5910061	5940116	5940022	5930019
				4950029	2x4070000	-	-	-	5910061	5940116	5940022	5930019



1917102





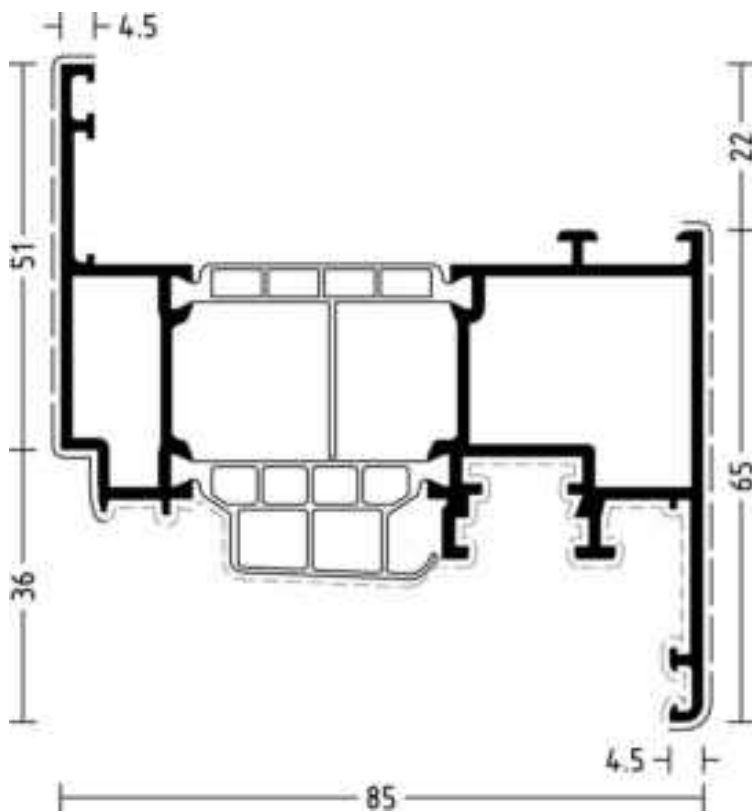

















Gelenckwinkel und Gelenkverbinder siehe Zusatzartikel.
See additional articles for hinged corner angles and hinged connectors.

	 m	 mm	 mm									
 1917103	6,5	421	116	4950020	2x4070000	-	-	-	5910061	5940116	5940022	5930019
				4950030	2x4070000	-	-	-	5910061	5940116	5940022	5930019









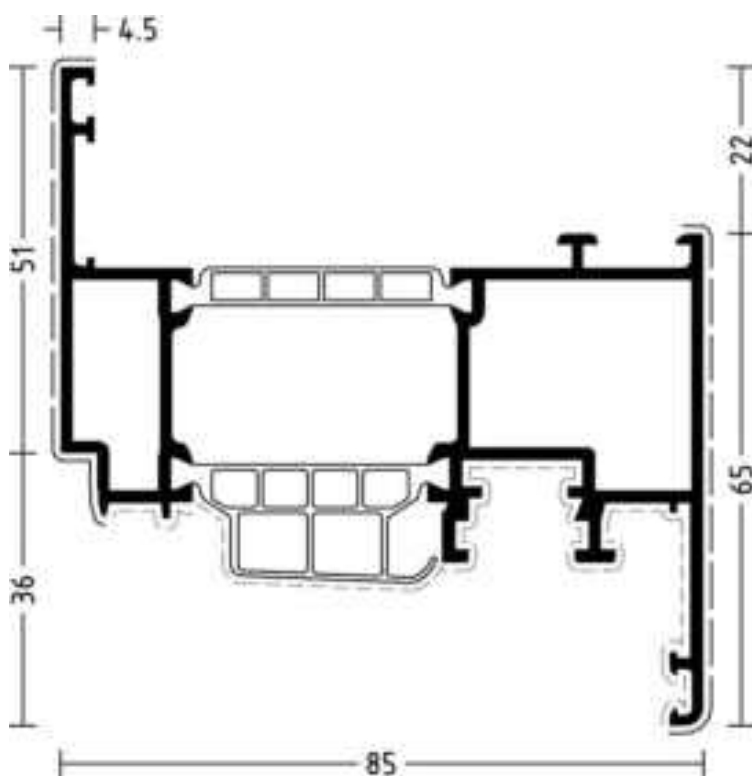







1917103

Gelenkeckwinkel und Gelenkverbinder siehe Zusatzartikel.
See additional articles for hinged corner angles and hinged connectors.

	 m	 mm	 mm	 	 	 	 		 	 	 	 
 1910146	6,5	421	116	4950020	2x4070000	-	-	-	5910061	5940116	5940022	5930019
				4950030	2x4070000	-	-	-	5910061	5940116	5940022	5930019







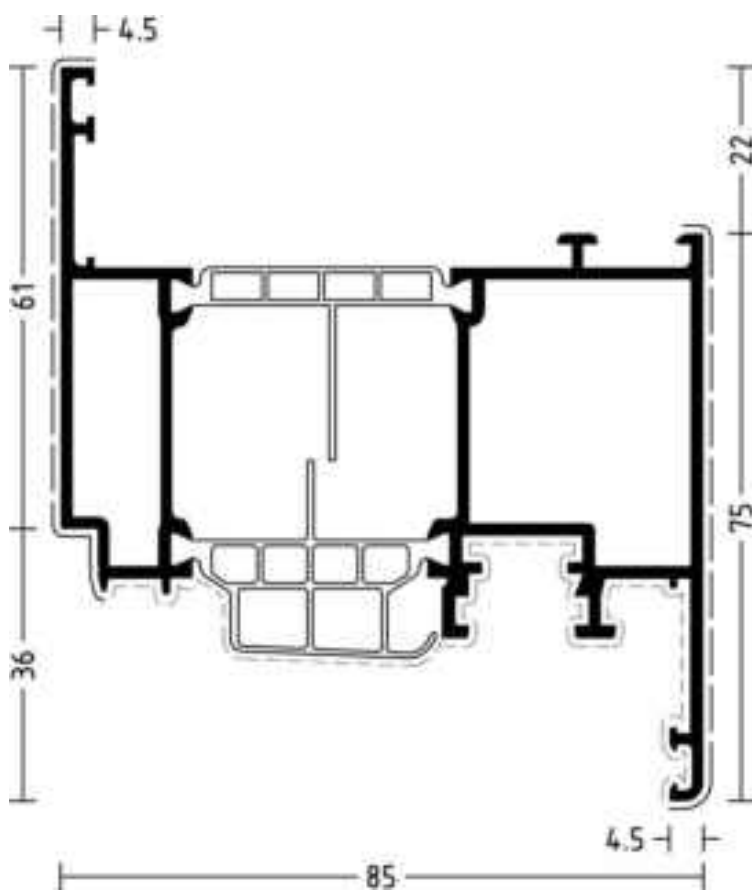











1910146

	 m	 mm	 mm									
 1917104	6,5	441	136	4950021	2x4070000	-	-	-	5910061	5940116	5940022	5930019
				4950031	2x4070000	-	-	-	5910061	5940116	5940022	5930019









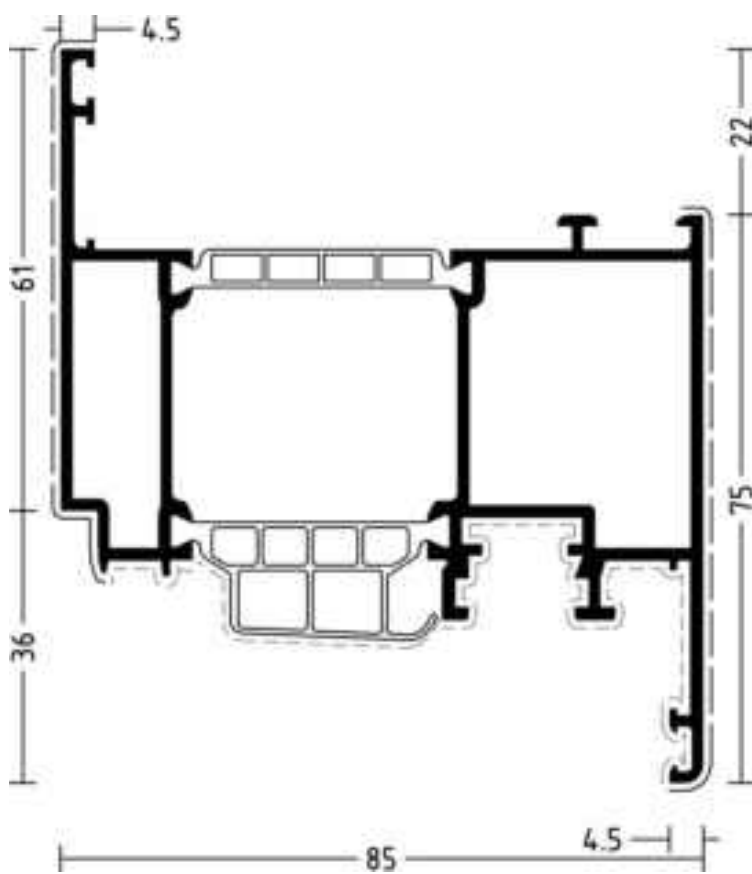















1917104

Fenstertüre einwärts.
French window inwards.

	 m	 mm	 mm	 		 			 			
 1910147	6,5	441	136	4950021	2x4070000	-	-	-	5910061	5940116	5940022	5930019
				4950031	2x4070000	-	-	-	5910061	5940116	5940022	5930019







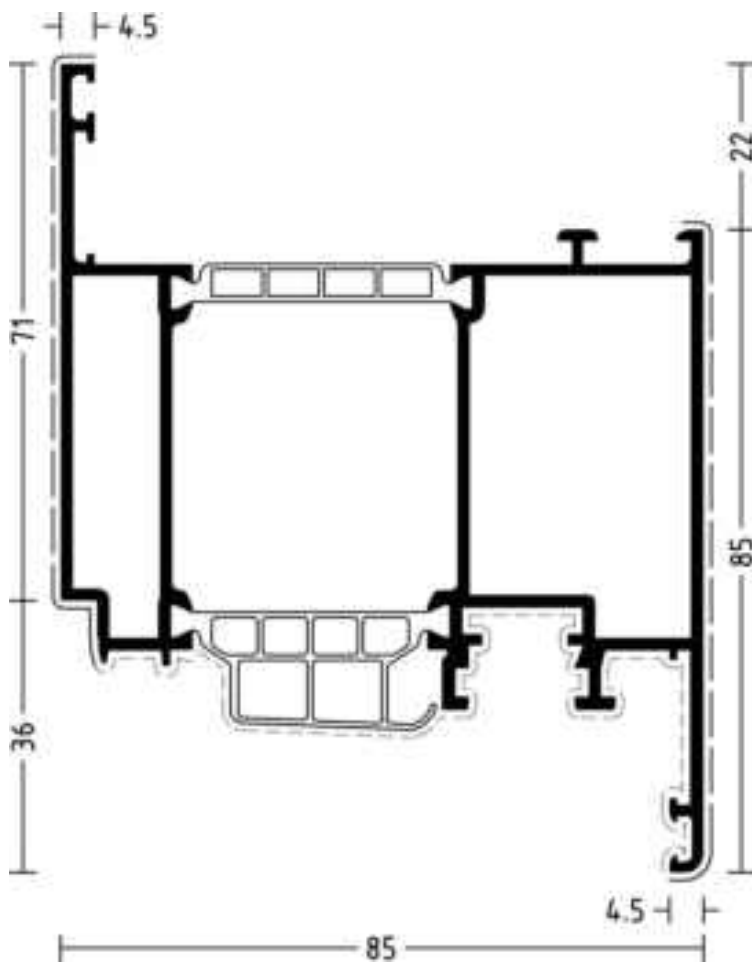









1910147

	 m	 mm	 mm	 	 	 	 		 	 	 	 
 1917115	6,5	461	156	4950022	2x4070000	-	-	-	5910061	5940116	5940022	5930019
				4950032	2x4070000	-	-	-	5910061	5940116	5940022	5930019



1917115





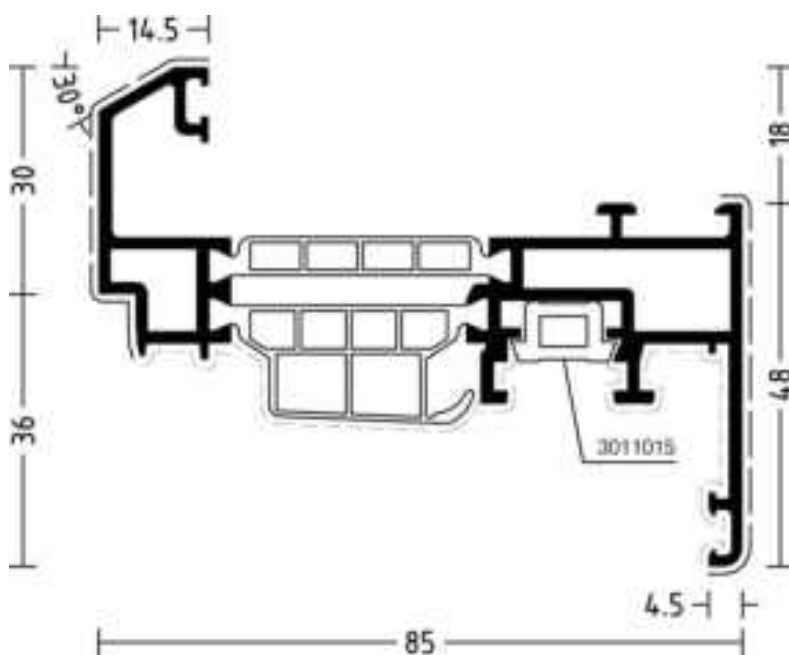









Fenstertüre einwärts.
French window inwards.

	 m	 mm	 mm										
 1917105	6,5	402	88	4950018	2x4070000	-	-	-	5910061	5940118	5940022	5930019	
				4950028	2x4070000	-	-	-	5910061	5940118	5940022	5930019	



1917105





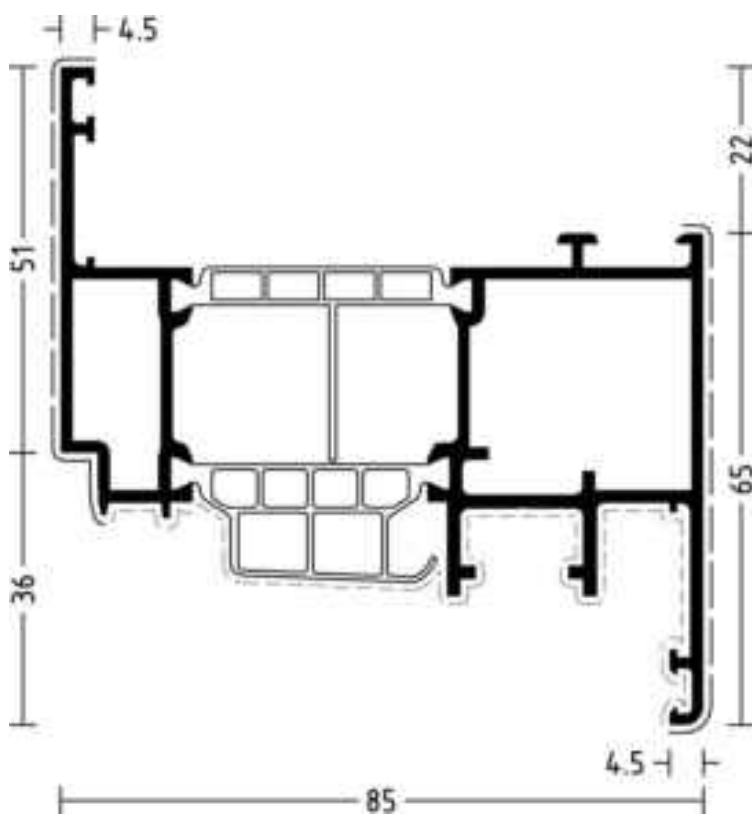









Gelenckwinkel und Gelenkverbinder siehe Zusatzartikel.
See additional articles for hinged corner angles and hinged connectors.

												
	m	mm	mm									
 1917116	6,5	412	116	4950020	2x4070000	-	-	-	5910054	5940116	5940022	5930019
				4950030	2x4070000	-	-	-	5910054	5940116	5940022	5930019



1917116

Achtung:
Flügelprofil nur für Parallel-Schiebe-Kippfenster
Attention:
Sash profile only suitable
for parallel-sliding-tilt window



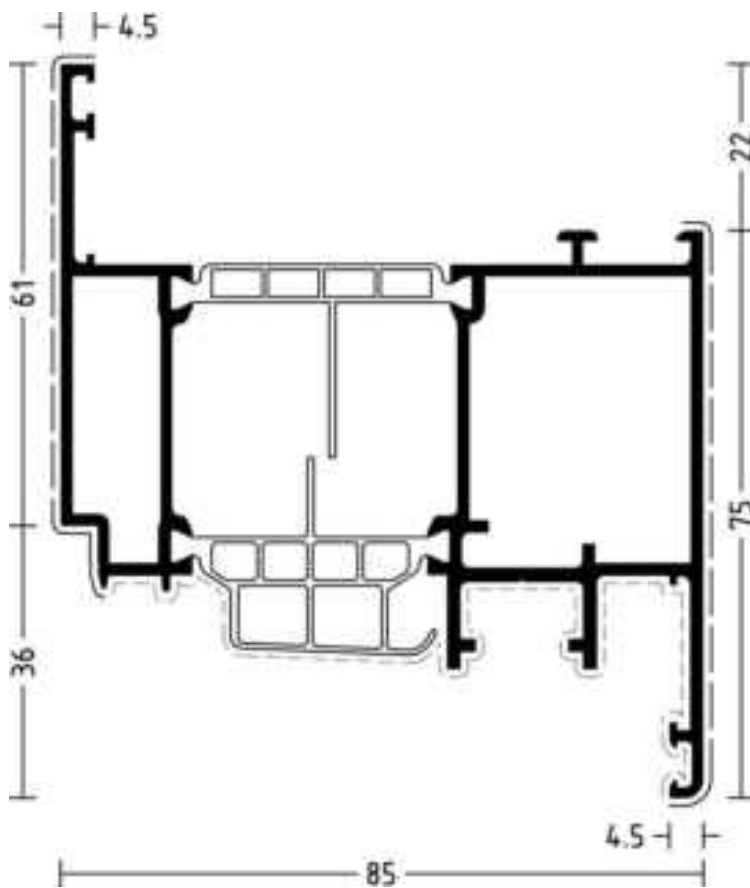











	 m	 mm	 mm									
 1917117	6,5	432	136	4950021	2x4070000	-	-	-	5910054	5940116	5940022	5930019
				4950031	2x4070000	-	-	-	5910054	5940116	5940022	5930019



1917117

Achtung:
Flügelprofil nur für Parallel-Schiebe-Kippfenster





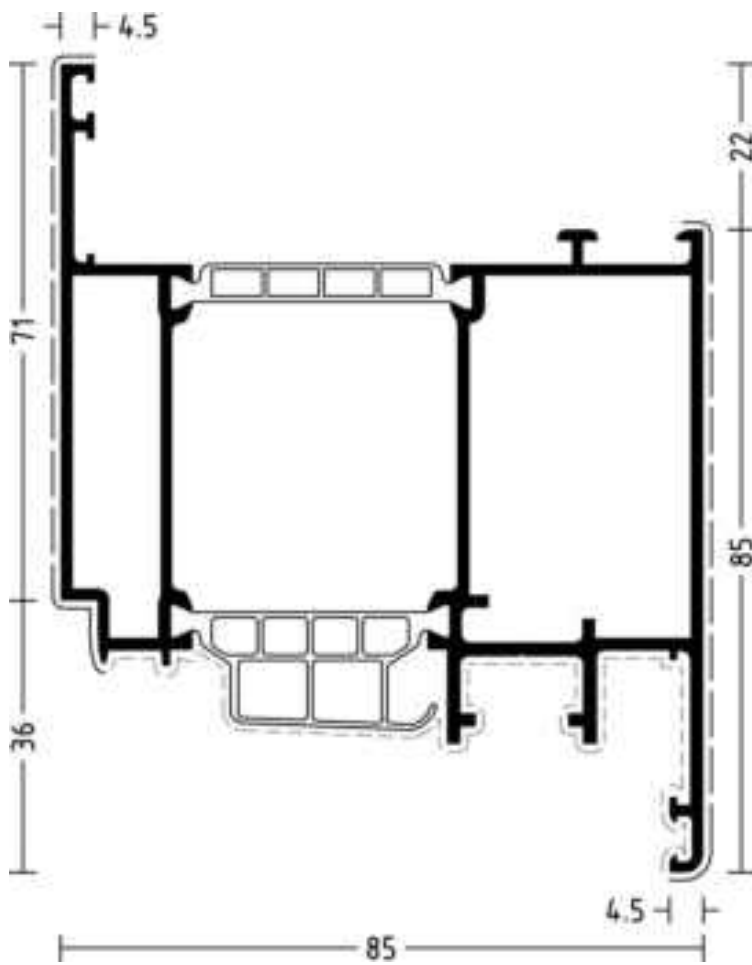









Attention:
Sash profile only suitable
for parallel-sliding-tilt window

	 m	 mm	 mm									
 1917118	6,5	452	156	4950022	2x4070000	-	-	-	5910054	5940116	5940022	5930019
				4950032	2x4070000	-	-	-	5910054	5940116	5940022	5930019



1917118





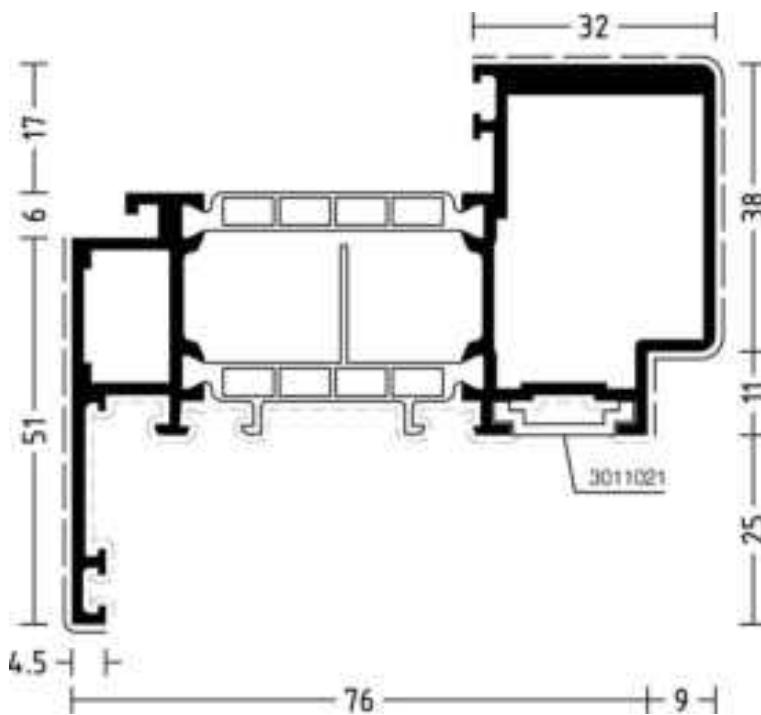









Achtung:
Flügelprofil nur für Parallel-Schiebe-Kippfenster
Attention:
Sash profile only suitable
for parallel-sliding-tilt window

	 m	 mm	 mm									
 1917161	6,5	351	120	4950037	2x4070000	-	-	-	5910044	5940118	-	5930028
				4950034	2x4070000	-	-	-	5910044	5940104	-	5930028



1917161





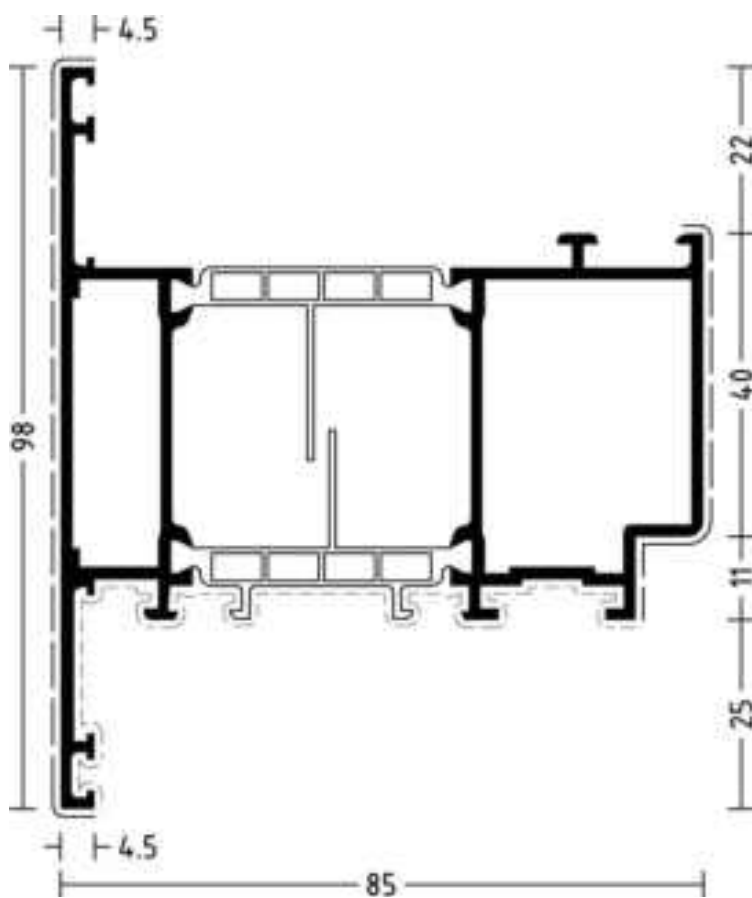





Senk-Klappfenster, Schwing-Wendefenster, Klappfenster, Fenstertüre
auswärts, Drehfenster auswärts
Italian style window, Pivot window, Top Hung window, Turn outwards

	 m	 mm	 mm									
 1917163	6,5	417	138	4950033	2x4070000	-	-	-	5910044	5940116	-	5930028
				4950034	2x4070000	-	-	-	5910044	5940104	-	5930028



1917163



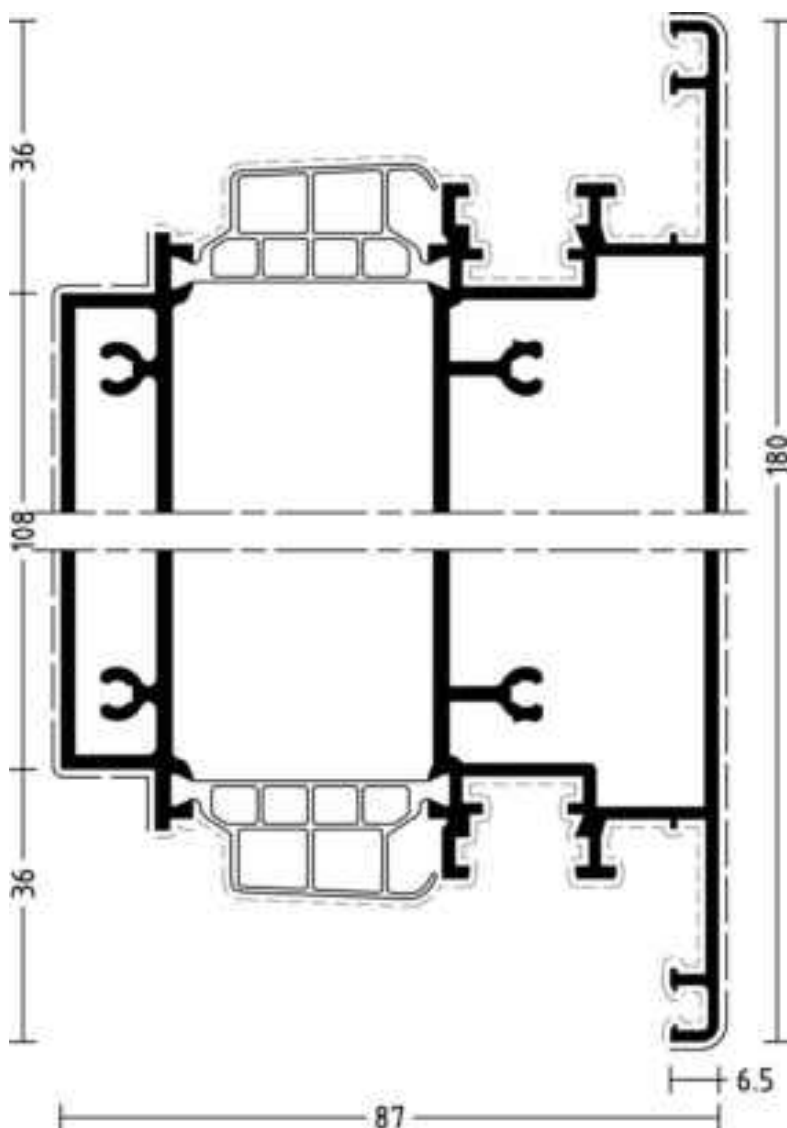

Senk-Klappfenster, Schwing-Wendefenster, Klappfenster, Fenstertüre
auswärts, Drehfenster auswärts
*Italian style window, Pivot window, Top hung window, French window
outwards, Turn outwards*

												
	m	mm	mm									
 1010375	6,5	662	328	-	-	-	-	-	-	-	-	-
	-	-	-	-	-	-	-	-	-	-	-	-



1010375





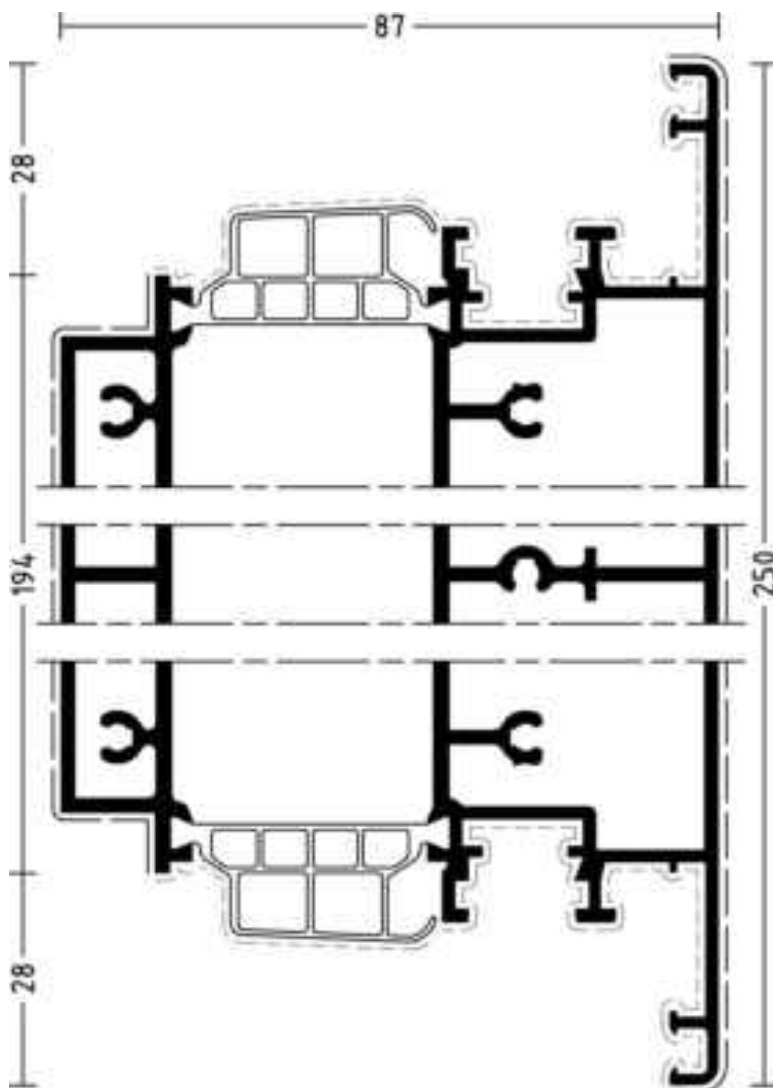









Flügel für Lüftungsklappe 180 mm
Sash for Ventilation flap 180 mm

													
	m	mm	mm										
 1010383	6,5	802	479	-	-	-	-	-	-	-	-	-	-
	-	-	-	-	-	-	-	-	-	-	-	-	-









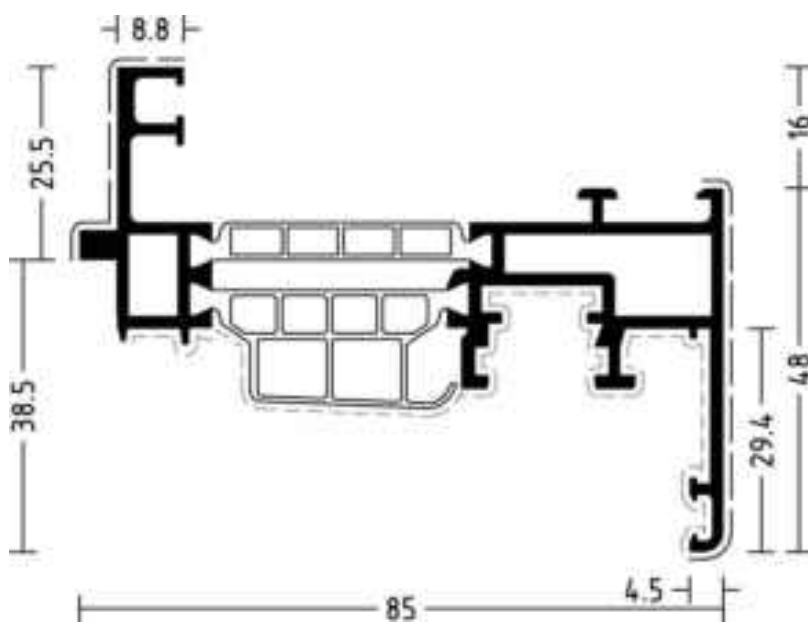







1010383

Flügel für Lüftungsklappe 250 mm
Sash for Ventilation flap 250 mm

	 m	 mm	 mm	 		 			 			
 1010453		388	87	4050567	2x4070004	-	-	-	5010628	5040124	-	5930019
				4950028	2x4070000	-	-	-	5010628	5940118	-	5930019



1010453

												
	m	mm	mm									
 1917201	6,5	345	96	4950006	2x4070000	1x4960002	1x4070000	-	5910006	5940101	5940001	5930003
				4950006	2x4070000	1x4960002	1x4070000	-	5910006	5940101	5940001	5930003
1917202	6,5	353	104	4950007	2x4070000	1x4960003	1x4070000	1x4070030	5910006	5940101	5940001	5930003
				4950007	2x4070000	1x4960003	1x4070000	1x4070030	5910006	5940101	5940001	5930003

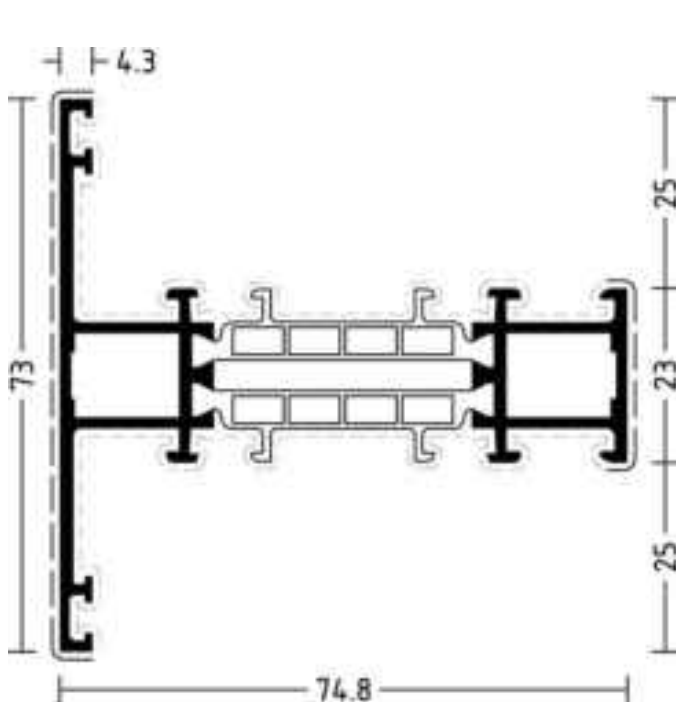





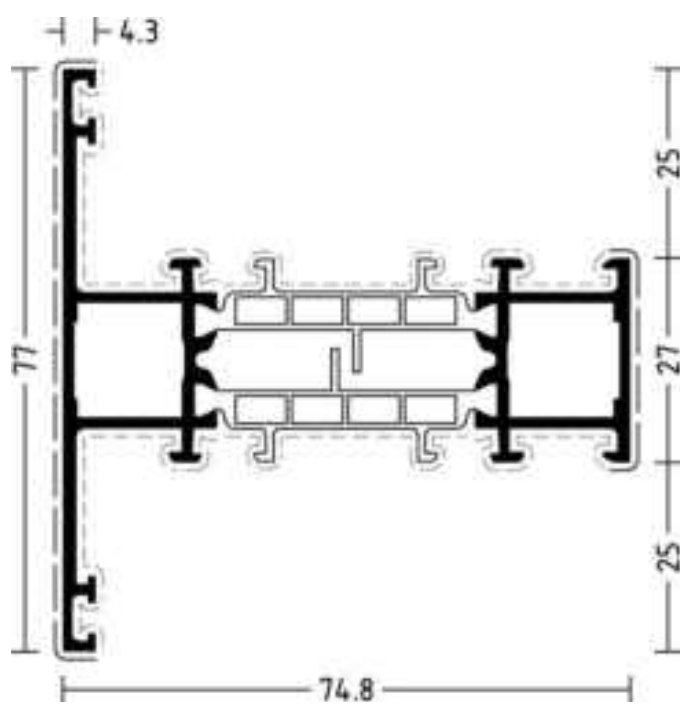









1917201

Gelenckeckwinkel und Gelenkverbinder siehe Zusatzartikel.
Stoßverbindungen mit Tür-Flügelprofilen WICSTYLE 75 Verbinder 4960052 (außen).
See additional articles for hinged corner angles and hinged connectors.
Butt joint connections with WICSTYLE 75 door leaf profiles connector 4960052 (outwards).



1917202

Gelenckeckwinkel und Gelenkverbinder siehe Zusatzartikel.
Stoßverbindungen mit Tür-Flügelprofilen WICSTYLE 75 Verbinder 4960053 (außen).
See additional articles for hinged corner angles and hinged connectors.
Butt joint connections with WICSTYLE 75 door leaf profiles connector 4960053 (outwards).

												
	m	mm	mm									
 1917203	6,5	359	110	4950008	2x4070000	1x4960004	1x4070000	1x4070030	5910006	5940101	5940001	5930003
				4950008	2x4070000	1x4960004	1x4070000	1x4070030	5910006	5940101	5940001	5930003
1917204	6,5	379	130	4950009	2x4070000	1x4960005	1x4070000	1x4070030	5910006	5940101	5940001	5930003
				4950009	2x4070000	1x4960005	1x4070000	1x4070030	5910006	5940101	5940001	5930003

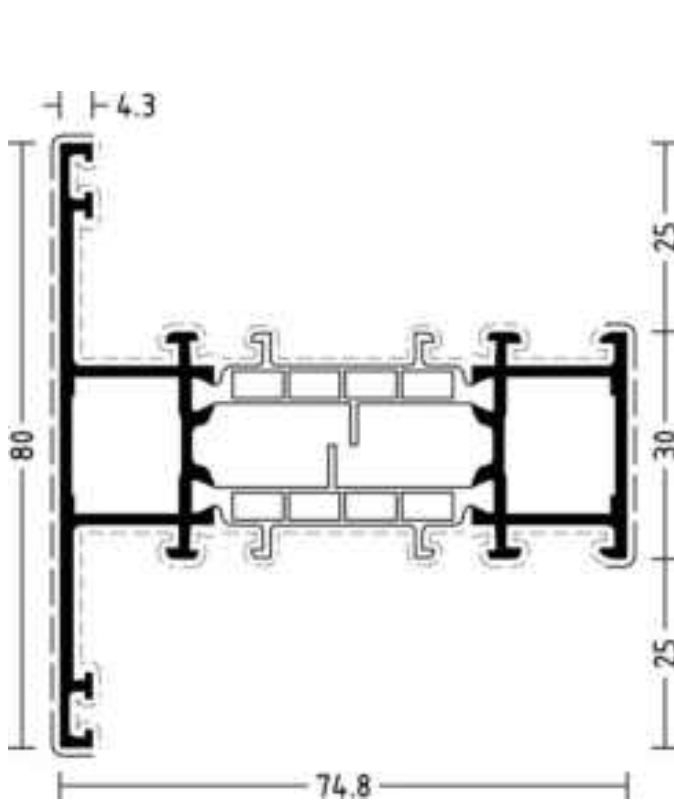

1917203

Gelenckwinkel und Gelenkverbinder siehe Zusatzartikel.
Stoßverbindungen mit Tür-Flügelprofilen WICSTYLE 75 Verbinder 4960054 (außen).
See additional articles for hinged corner angles and hinged connectors.
Butt joint connections with WICSTYLE 75 door leaf profiles connector 4960054 (outwards).

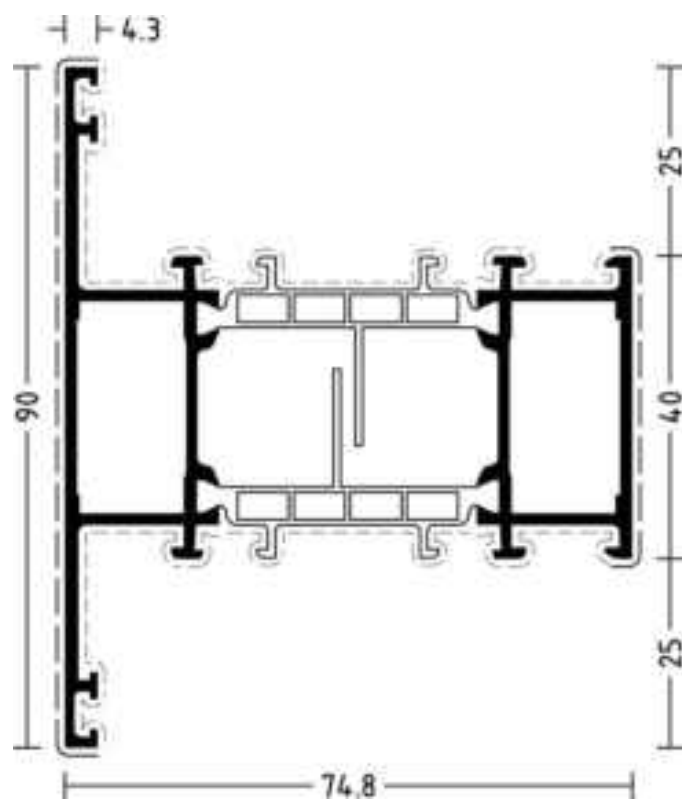















1917204

Gelenckwinkel und Gelenkverbinder siehe Zusatzartikel.
Stoßverbindungen mit Tür-Flügelprofilen WICSTYLE 75 Verbinder 4960055 (außen).
See additional articles for hinged corner angles and hinged connectors.
Butt joint connections with WICSTYLE 75 door leaf profiles connector 4960055 (outwards).

WICLINE 75

Kämpfer, Sprossenprofile
Transom, glazing bar profiles

												
	m	mm	mm									
 1917205	6,5	399	150	4950010	2x4070000	1x4960006	1x4070000	1x4070030	5910006	5940101	5940001	5930003
				4950010	2x4070000	1x4960006	1x4070000	1x4070030	5910006	5940101	5940001	5930003
1910149	6,5	399	150	4950010	2x4070000	1x4960006	1x4070000	1x4070030	5910006	5940101	5940001	5930003
				4950010	2x4070000	1x4960006	1x4070000	1x4070030	5910006	5940101	5940001	5930003

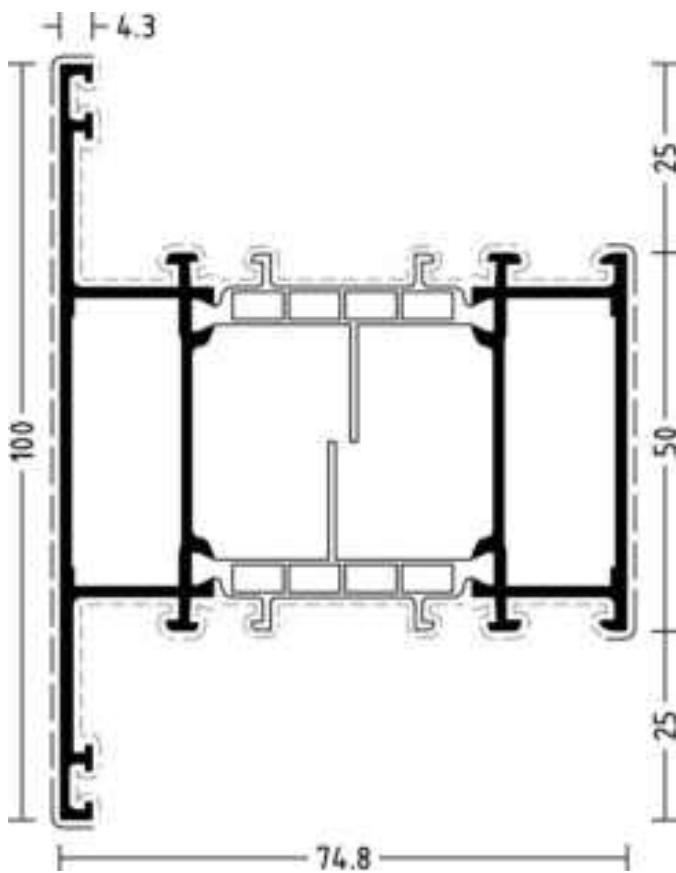





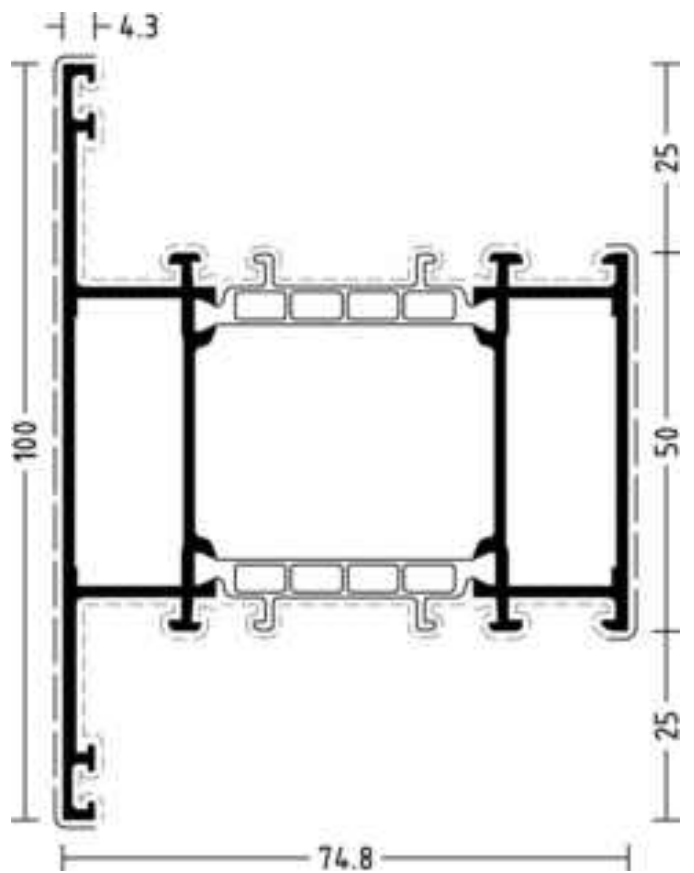









1917205

Stoßverbindungen mit Tür-Flügelprofilen WICSTYLE 75 Verbinder 4960056 (außen).
Butt joint connections with WICSTYLE 75 door leaf profiles connector 4960056 (outwards).



1910149

	 m	 mm	 mm										
 1917206	6,5	419	170	4950011	2x4070000	1x4960007	2x4070000	2x4070030	5910006	5940101	5940001	5930003	
 1917207	6,5	439	190	4950011	2x4070000	1x4960007	2x4070000	2x4070030	5910006	5940101	5940001	5930003	
				-	-	1x4960008	2x4070000	2x4070030	5910006	5940101	5940001	5930003	
				-	-	1x4960008	2x4070000	2x4070030	5910006	5940101	5940001	5930003	

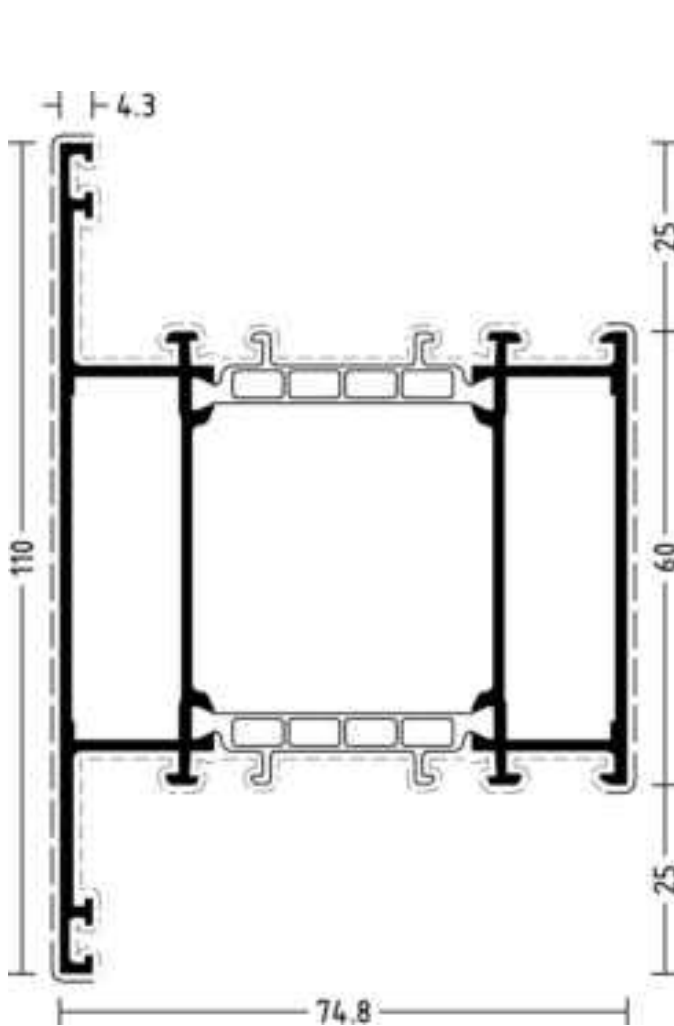

1917206

Stoßverbindungen mit Tür-Flügelprofilen WICSTYLE 75 Verbinder 4960057 (außen).
Butt joint connections with WICSTYLE 75 door leaf profiles connector 4960057 (outwards).

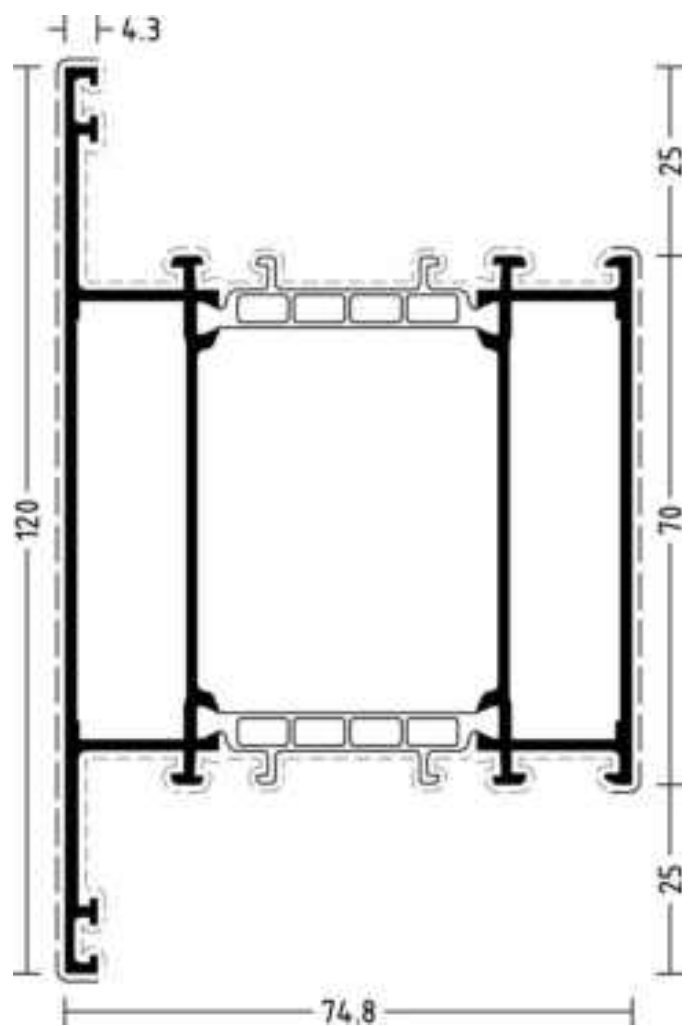

1917207

Eckverbindung außen/innen:
Zuschnitt aus 3900040 oder 3900053 (13.20) + 2x 4070000
Stoßverbindungen mit Tür-Flügelprofilen WICSTYLE 75 Verbinder 4960058 (außen).
Corner connection outside/inside:
Cutting with 3900040 or 3900053 (13.20) + 2x 4070000
Butt joint connections with WICSTYLE 75 door leaf profiles connector 4960058 (outside).

WICLINE 75

Kämpfer, Sprossenprofile
Transom, glazing bar profiles



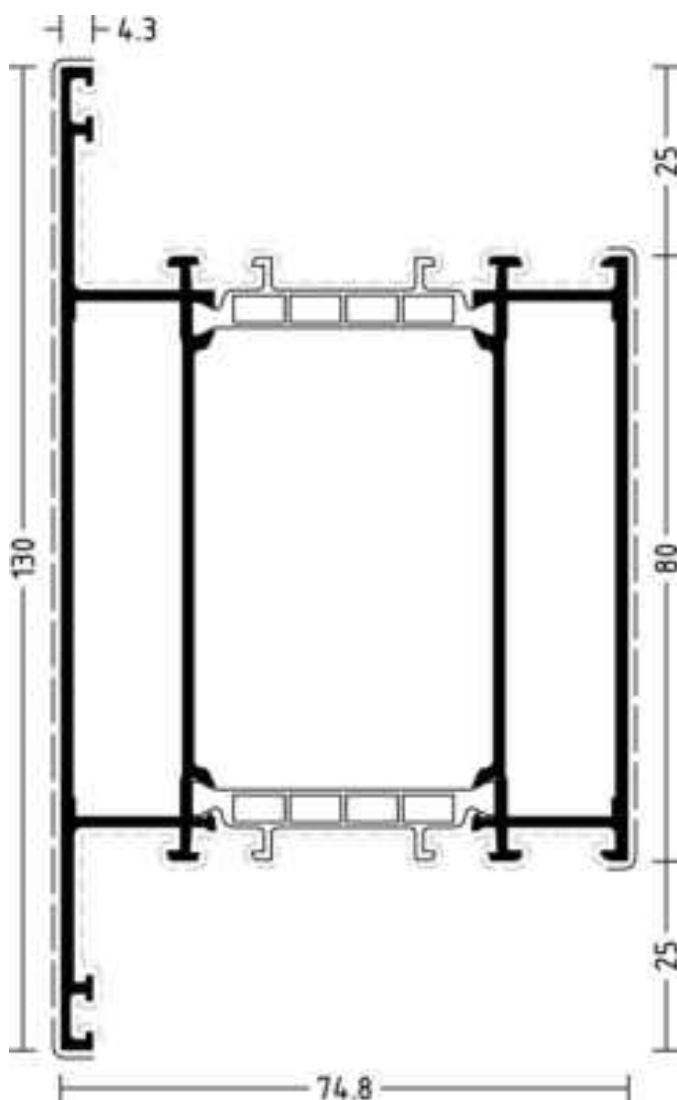











Icon	m	mm	mm	Icon		Icon			Icon				
				1	2	3	4	5	6	7	8		
☒	1917208	6,5	460	210	-	-	1x4960009	2x4070000	2x4070030	5910006	5940101	5940001	-
☒					-	-	1x4960009	2x4070000	2x4070030	5910006	5940101	5940001	-



1917208

Stoßverbindungen mit Tür-Flügelprofilen WICSTYLE 75 Verbinder 4960059 (außen).

Butt joint connections with WICSTYLE 75 door leaf profiles connector 4960059 (outwards).

	 m	 mm	 mm									
 1917209	6,5	479	230	-	-	1x4960010	2x4070000	2x4070030	5910006	5940101	5940001	-
				-	-	1x4960010	2x4070000	2x4070030	5910006	5940101	5940001	-
1917211	6,5	519	270	-	-	1x4960012	2x4070000	2x4070030	5910006	5940101	5940001	-
				-	-	1x4960012	2x4070000	2x4070030	5910006	5940101	5940001	-

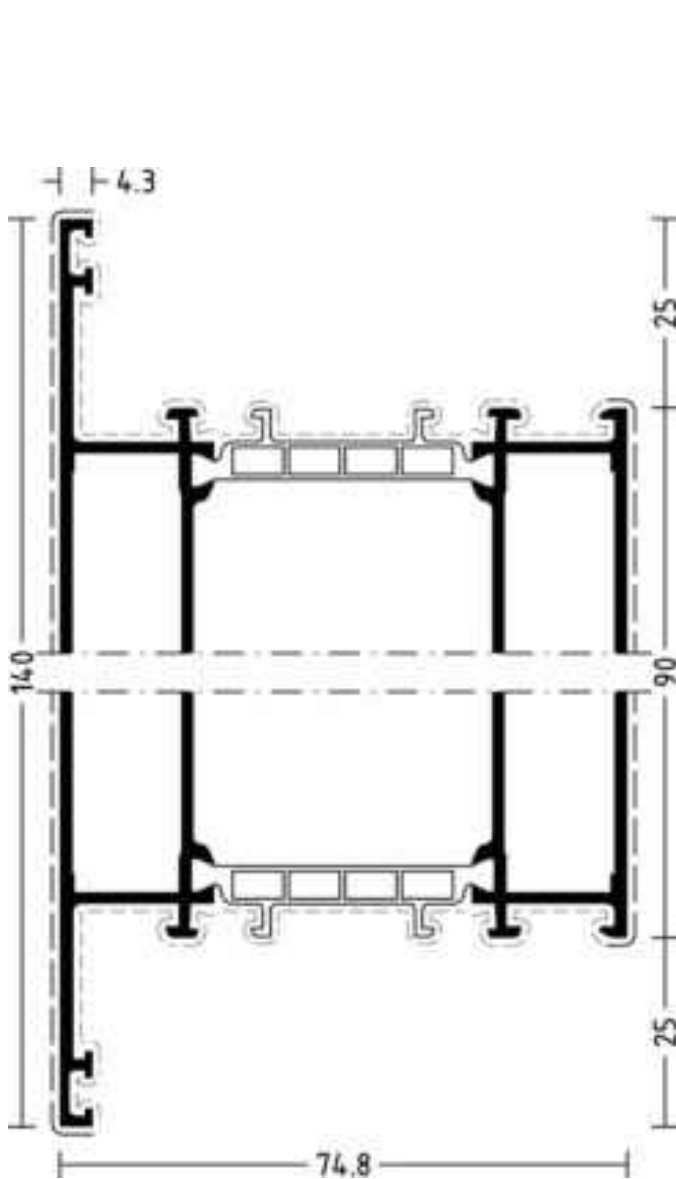

1917209

Stoßverbindungen mit Tür-Flügelprofilen WICSTYLE 75 Verbinder 4960060 (außen).
Butt joint connections with WICSTYLE 75 door leaf profiles connector 4960060 (outwards).

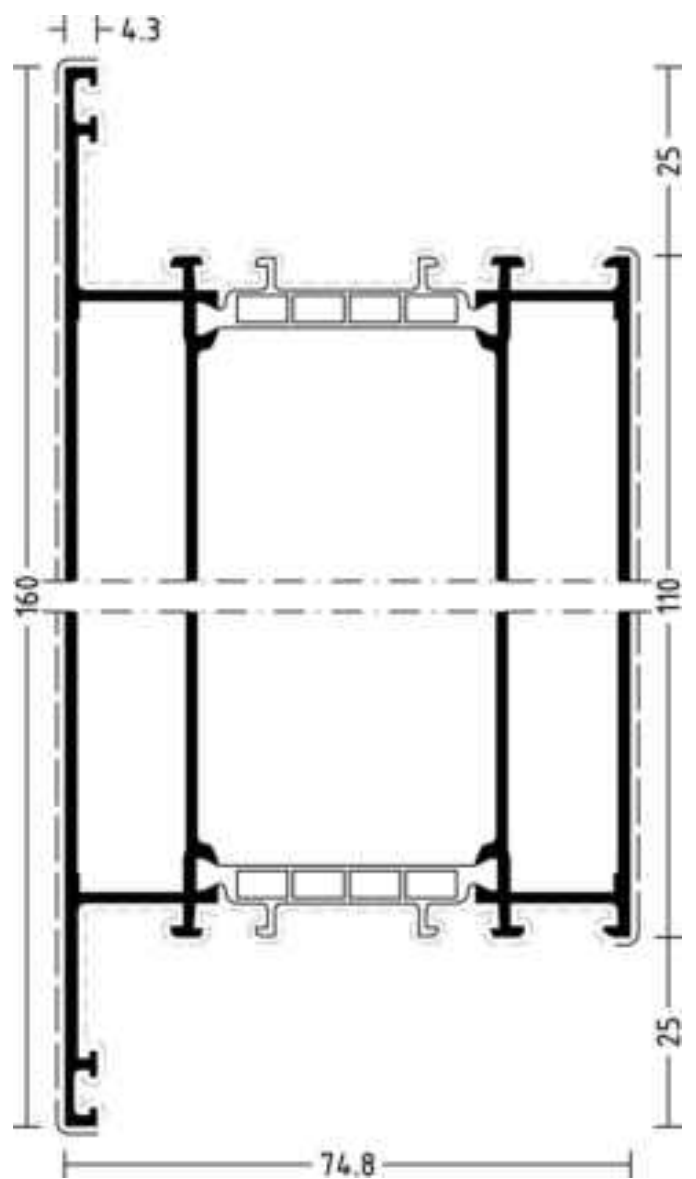

















1917211

Stoßverbindungen mit Tür-Flügelprofilen WICSTYLE 75 Verbinder 4960062 (außen).
Butt joint connections with WICSTYLE 75 door leaf profiles connector 4960062 (outwards).

WICLINE 75

Kämpfer, Sprossenprofile Transom, glazing bar profiles

	 m	 mm	 mm									
 1917213	6,5	559	310	-	-	2x4960008	2x4070000	2x4070030	5910006	5940101	5940001	-
 1917215	6,5	599	350	-	-	2x4960004	2x4070000	2x4070030	5910006	5940101	5940001	-
 1917215	6,5	599	350	-	-	2x4960009	2x4070000	2x4070030	5910006	5940101	5940001	-
 1917215	6,5	599	350	-	-	2x4960004	2x4070000	2x4070030	5910006	5940101	5940001	-

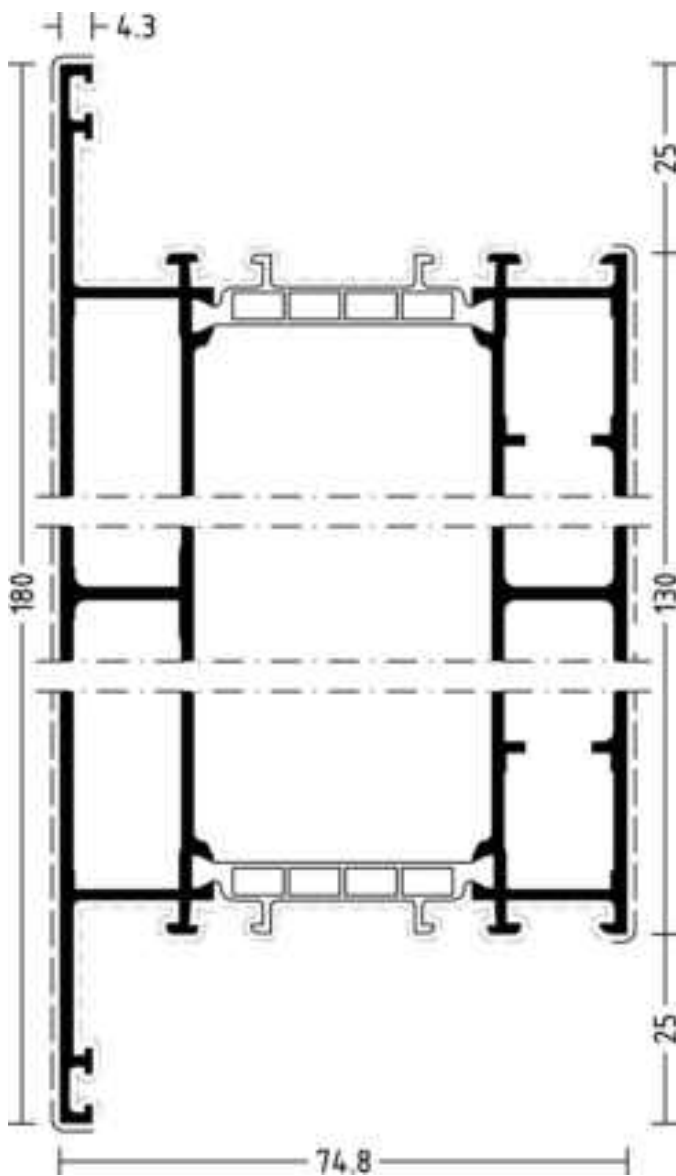

1917213

Stoßverbindungen mit Tür-Flügelprofilen WICSTYLE 75 Verbinder 4960058 (außen).
Butt joint connections with WICSTYLE 75 door leaf profiles connector 4960058 (outwards).

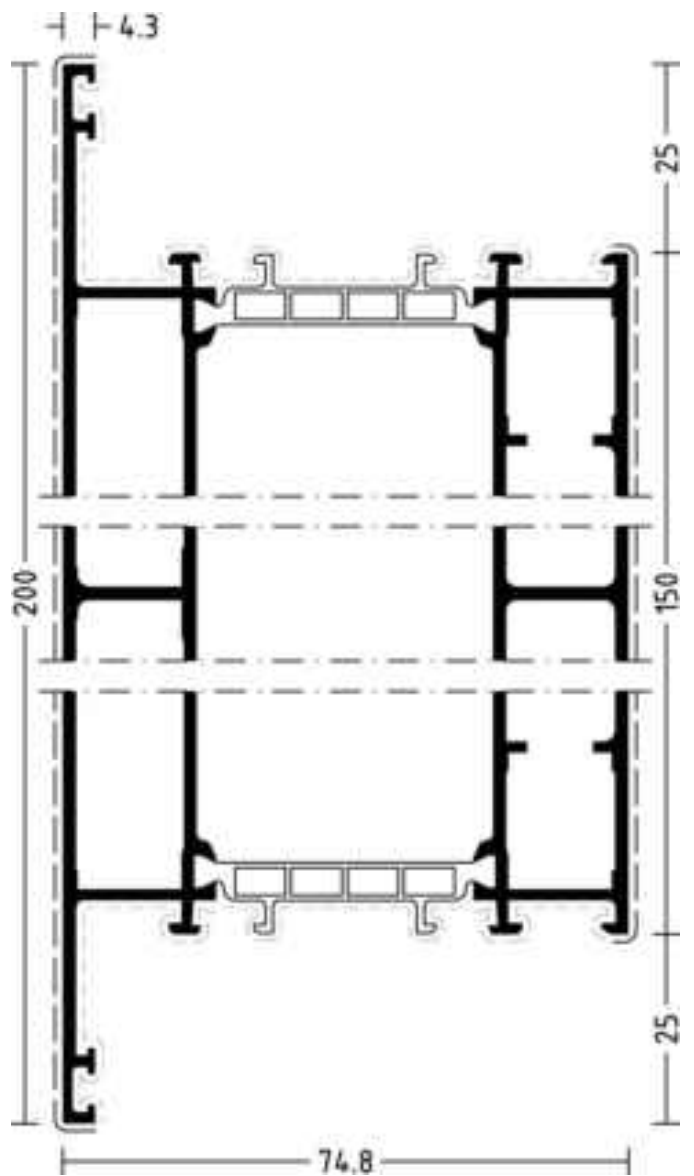

1917215

Stoßverbindungen mit Tür-Flügelprofilen WICSTYLE 75 Verbinder 4960059 (außen).
Butt joint connections with WICSTYLE 75 door leaf profiles connector 4960059 (outwards).

WICLINE 75

Kämpfer, Sprossenprofile
Transom, glazing bar profiles

□ □	1917220	m	6,5	mm	699	mm	□ □	□ □		□ □			□ □		
								□ □	□ □	□ □	□ □	□ □		□ □	
□ □	1917220	6,5	6,5	699	699	450	-	-	2x4960011	2x4070000	2x4070030	5910006	5940101	5940001	-
□ □							-	-	2x4960004	2x4070000	2x4070030	5910006	5940101	5940001	-

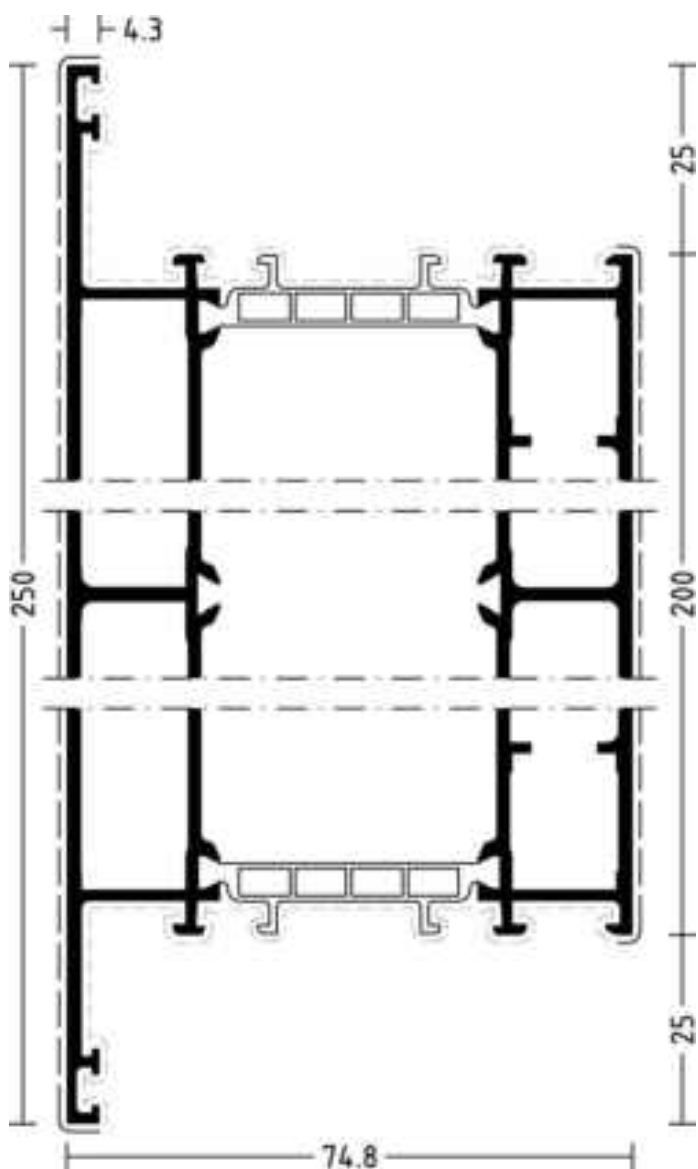

















1917220

Stoßverbindungen mit Tür-Flügelprofilen WICSTYLE 75 Verbinder 4960061 (außen).
Butt joint connections with WICSTYLE 75 door leaf profiles connector 4960061 (outwards).

WICLINE 75





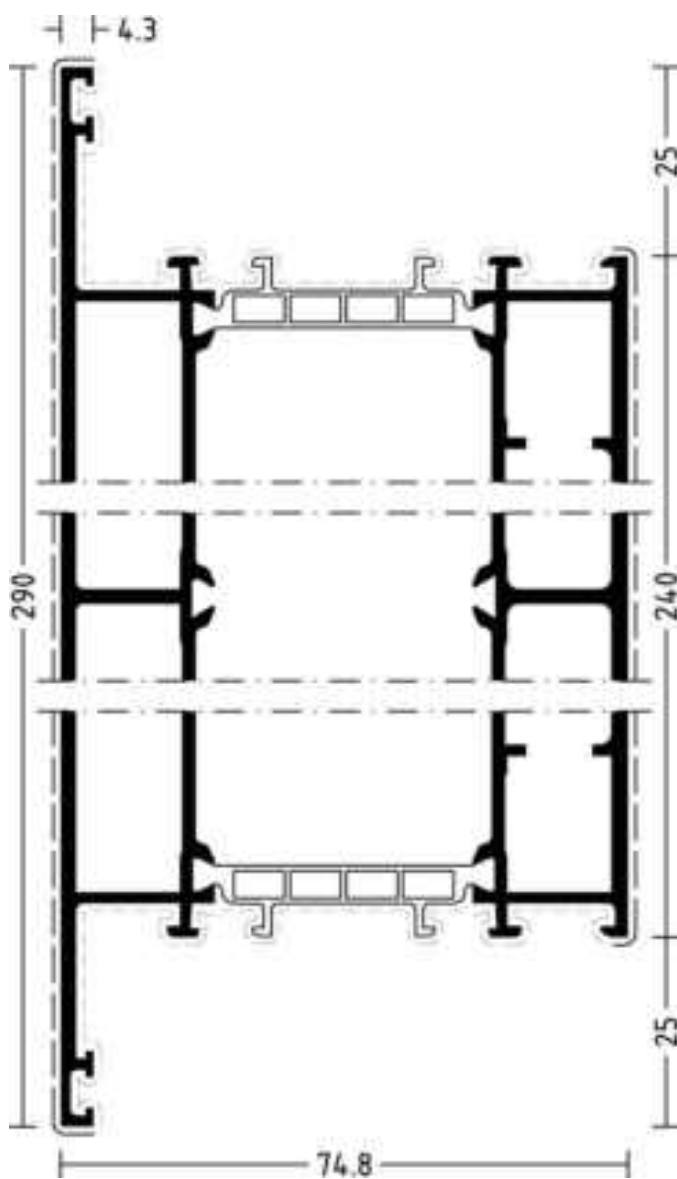





Kämpfer, Sprossenprofile
Transom, glazing bar profiles

 m	 mm	 mm										
												
 1917224	6,5	779	530	-	-	2x4960013	2x4070000	2x4070030	5910006	5940101	5940001	-
				-	-	2x4960004	2x4070000	2x4070030	5910006	5940101	5940001	-



1917224

Stoßverbindungen mit Tür-Flügelprofilen WICSTYLE 75 Verbinder 4960063 (außen).
Butt joint connections with WICSTYLE 75 door leaf profiles connector 4960063 (outwards).

□ □ 1917334	 m mm mm			 		  			   			
	□ □	6,5	455	121	4950012	2x4070000	1x4960004	1x4070000	1x4070030	5910006	5940101	5940001
□ □				4950008	2x4070000	1x4960004	1x4070000	1x4070030	5910006	5940101	5940001	5930003

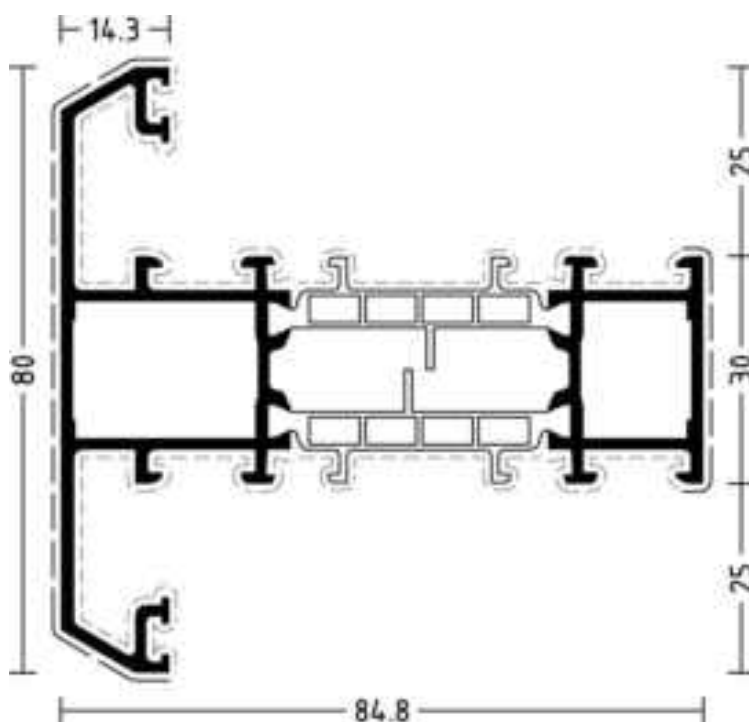















1917334

Stoßverbinder für alle Profilkombinationen siehe Seiten „Sprossenstoß-
verbindung“.

Gelenckeckwinkel und Gelenkverbinder siehe Zusatzartikel.

*Butt-joint connectors for all profile combinations see pages „Glazing
bar butt-joint connection“. See additional articles for hinged corner
angles and hinged connectors.*



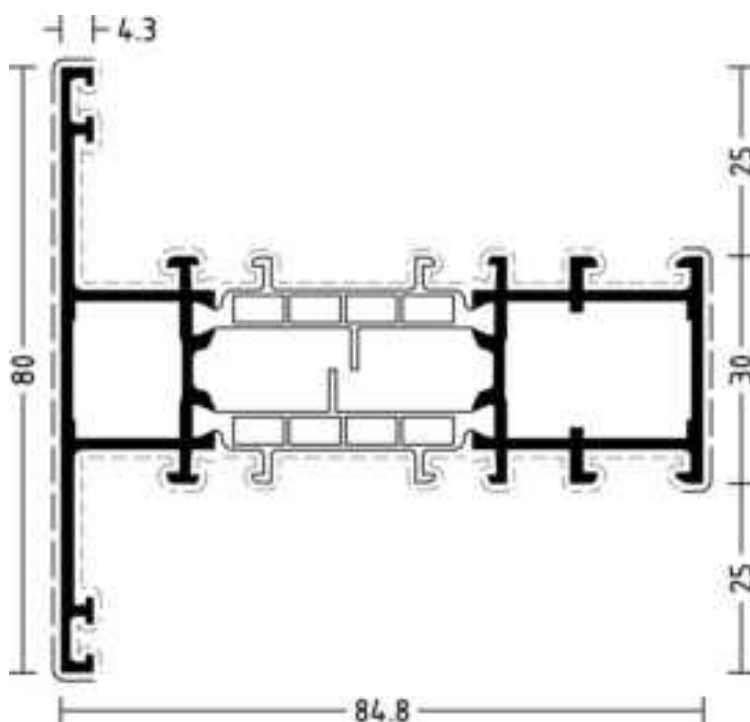

	 m	 mm	 mm										
 1917331	6,5	396	110	4950008	2x4070000	1x4960004	1x4070000	1x4070030	5910021	5940101	-	5930005	
				4950008	2x4070000	1x4960004	1x4070000	1x4070030	5910021	5940101	-	5930005	



1917331

Stoßverbinder für alle Profilkombinationen
siehe Seiten „Sprossenstoßverbindung“





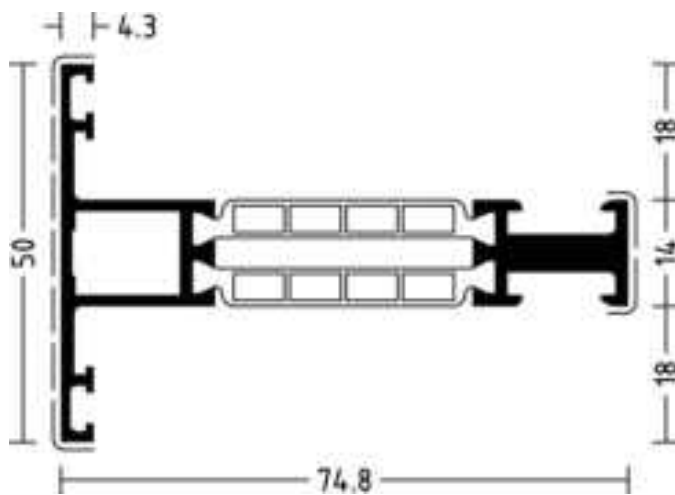



Butt-joint connectors for all profile combinations see pages „Glazing bar
butt-joint connection“

	 m	 mm	 mm										
 1917336	6,5	253	64	-	-	-	-	-	-	-	-	-	-
	-	-	-	-	-	-	-	-	-	-	-	-	-



1917336

Stoßverbinder für alle Profilkombinationen
siehe Seiten „Sprossenstoßverbindung“
See pages „butt joint connection of glazing bars“ for butt joint connector of all profile combinations

	 m	 mm	 mm									
 1917337	6,5	273	64	-	-	-	-	-	-	-	-	-
	-	-	-	-	-	-	-	-	-	-	-	-

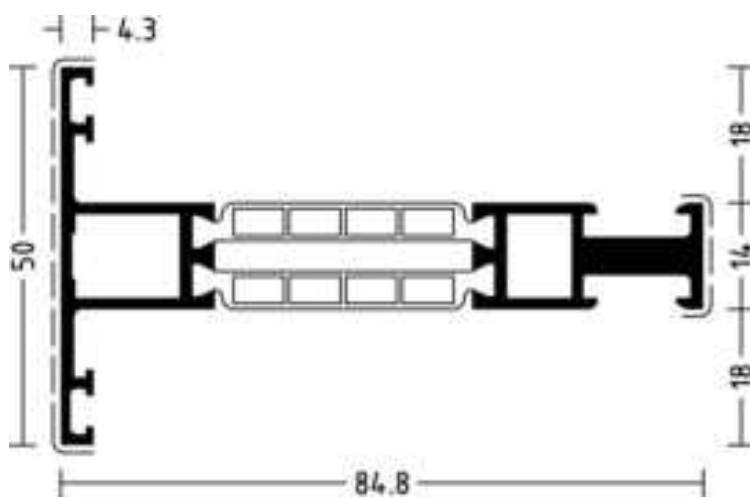





1917337

Stoßverbinder für alle Profilkombinationen
siehe Seiten „Sprossenstoßverbindung“
*Butt-joint connectors for all profile combinations see pages „Glazing bar
butt-joint connection“*

WICLINE 75

Kämpfer, Sprossenprofile
Transom, glazing bar profiles

	 m	 mm	 mm										
 1917338	6,5	230	75	-	-	-	-	-	-	-	-	-	-
	-	-	-	-	-	-	-	-	-	-	-	-	-

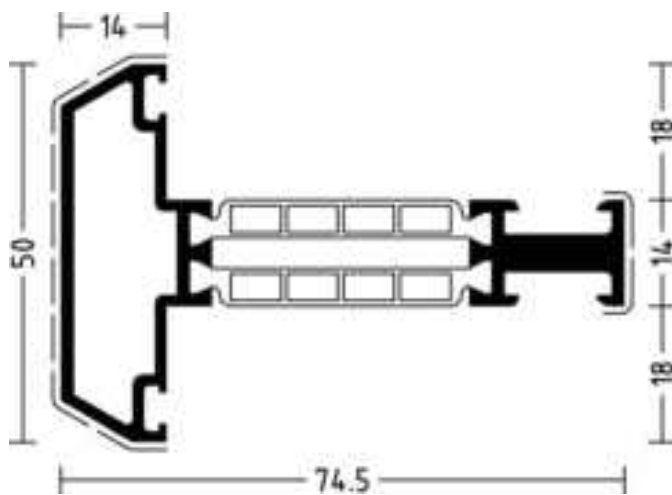



1917338

Stoßverbinder für alle Profilkombinationen
siehe Seiten „Sprossenstoßverbindung“
See pages „butt joint connection of glazing bars“ for butt joint connector of all profile combinations

WICLINE 75





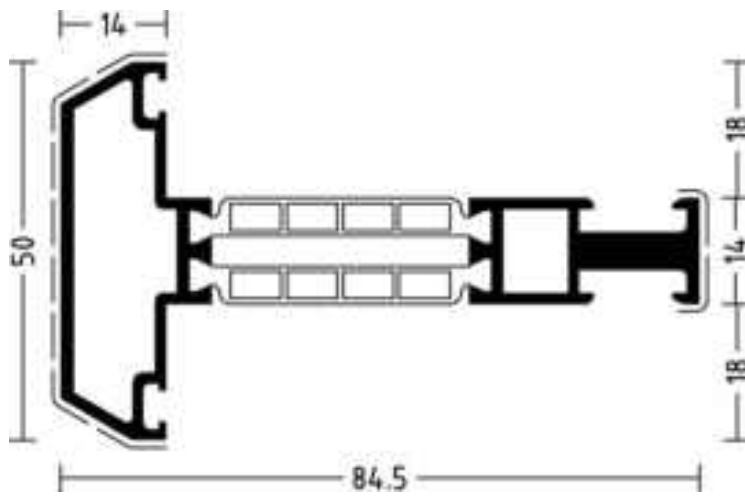









Kämpfer, Sprossenprofile
Transom, glazing bar profiles

	 m	 mm	 mm									
 1917339	6,5	250	75	-	-	-	-	-	-	-	-	-
	-	-	-	-	-	-	-	-	-	-	-	-



1917339





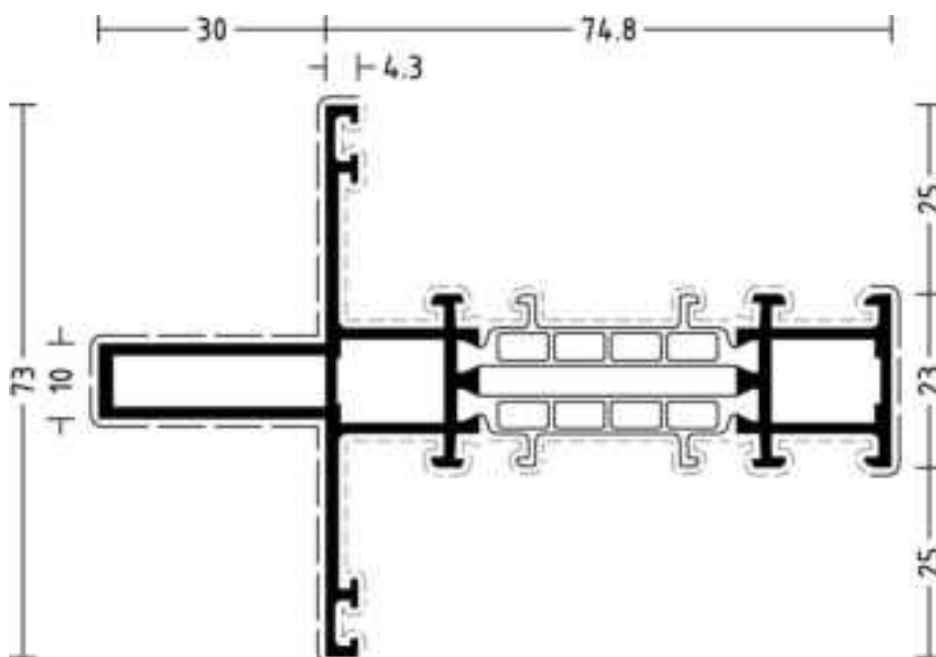







Stoßverbinder für alle Profilkombinationen
siehe Seiten „Sprossenstoßverbindung“
*Butt-joint connectors for all profile combinations see pages „Glazing bar
butt-joint connection“*

	 m	 mm	 mm									
 1010452	6,5	405	155	4950006	2x4070000	1x4960002	1x4070000	-	5910006	5940101	5940001	5930003
				4950006	2x4070000	1x4960002	1x4070000	-	5910006	5940101	5940001	5930003



1010452

Gelenckeckwinkel und Gelenkverbinder siehe Zusatzartikel.
 Stoßverbindungen mit Tür-Flügelprofilen WICSTYLE 75 Verbinder
 4960052 (außen).
 See additional articles for hinged corner angles and hinged connectors.
 Butt joint connections with WICSTYLE 75 door leaf profiles connector
 4960052 (outwards).

												
	m	mm	mm									
 1917120	6,5	422	90	4950018	2x4070000	-	-	-	5910027	5940118	-	5930020
				4950028	1x4070004	-	-	-	5910027	5940117	-	5930020

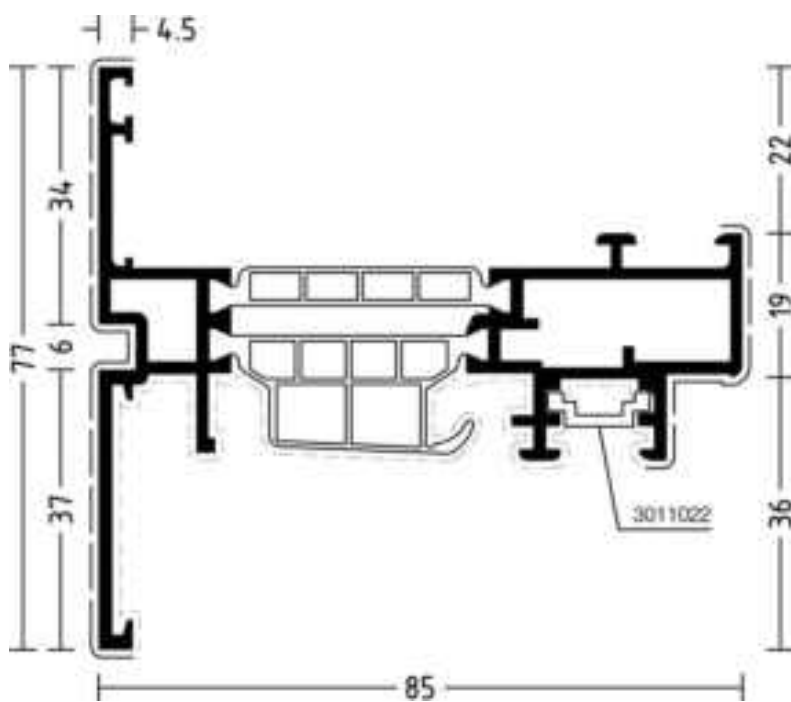











1917120

Verbindungselemente für Eckverbindung innen:
1x 4070004 (Stulpflügelprofil) und 1x 4070000 (Flügelprofil)
Connecting elements for corner connection inside:
1x 4070004 (double casement sash profile) and 1x 4070000 (sash profile)







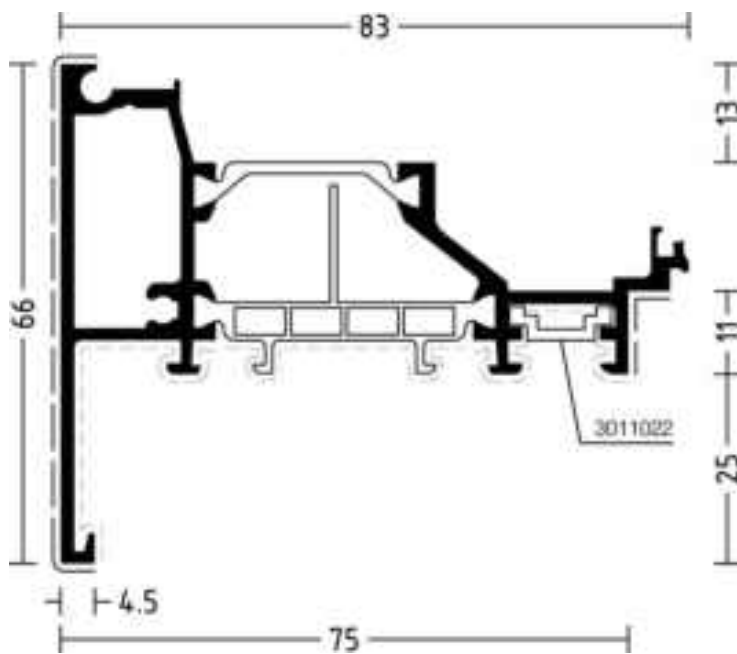







WICLINE 75

Stulpflügelprofile Double casement sash profiles

	 m	 mm	 mm									
 1917121	6,5	334	76	-	-	-	-	-	-	-	-	-
	-	-	-	-	-	-	-	-	-	-	-	-



1917121

	 m	 mm	 mm									
 1917122	6,5	448	103	4950018	2x4070000	-	-	-	5910027	5940118	-	5930020
				4950028	1x4070004	-	-	-	5910027	5940117	-	5930020

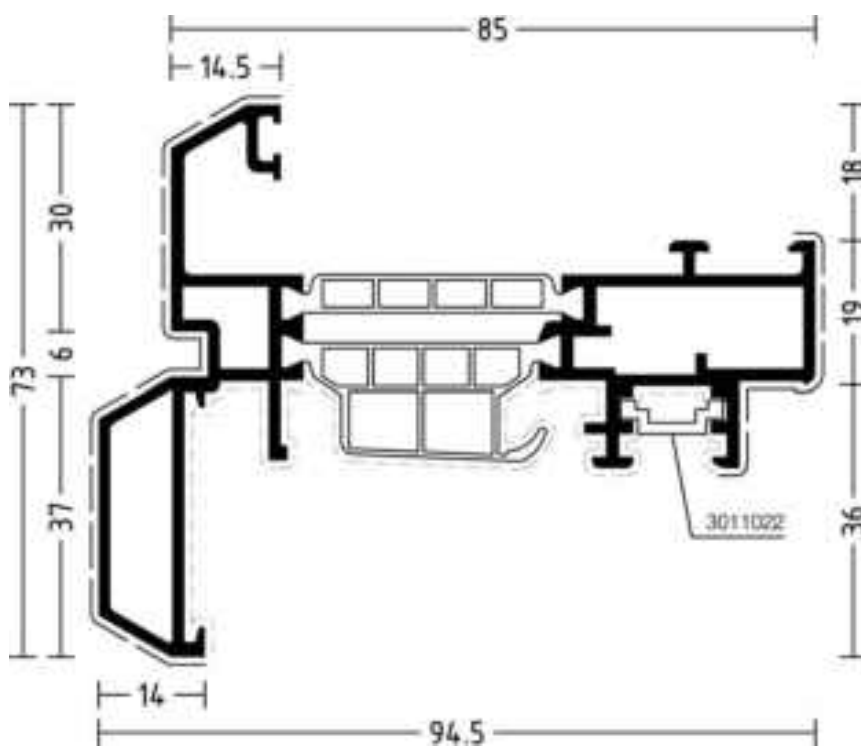





1917122

Verbindungselemente für Eckverbindung innen:
1x 4070004 (Stulpflügelprofil) und 1x 4070000 (Flügelprofil)
Connecting elements for corner connection inside:
1x 4070004 (double casement sash profile) and 1x 4070000 (sash profile)

WICLINE 75





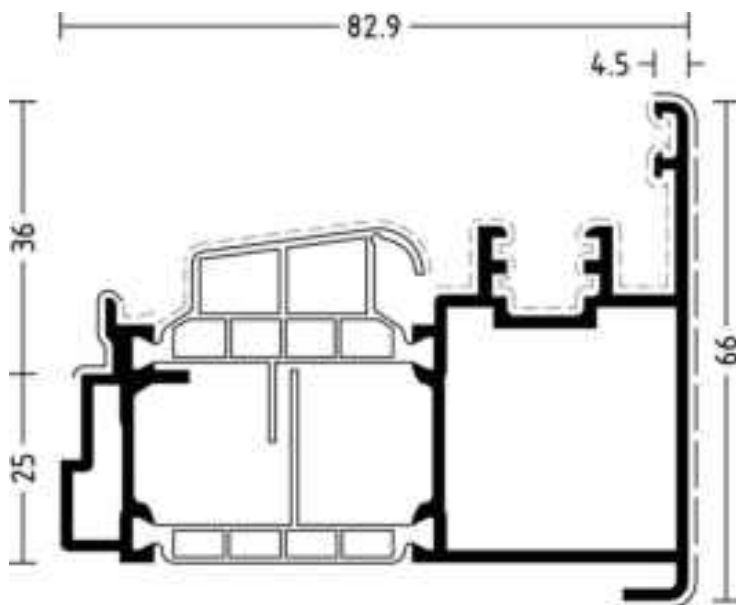









Stulpflügelprofile Double casement sash profiles

	 m	 mm	 mm									
 1917167	6,5	326	66	-	-	-	-	-	-	-	-	-
	-	-	-	-	-	-	-	-	-	-	-	-



1917167





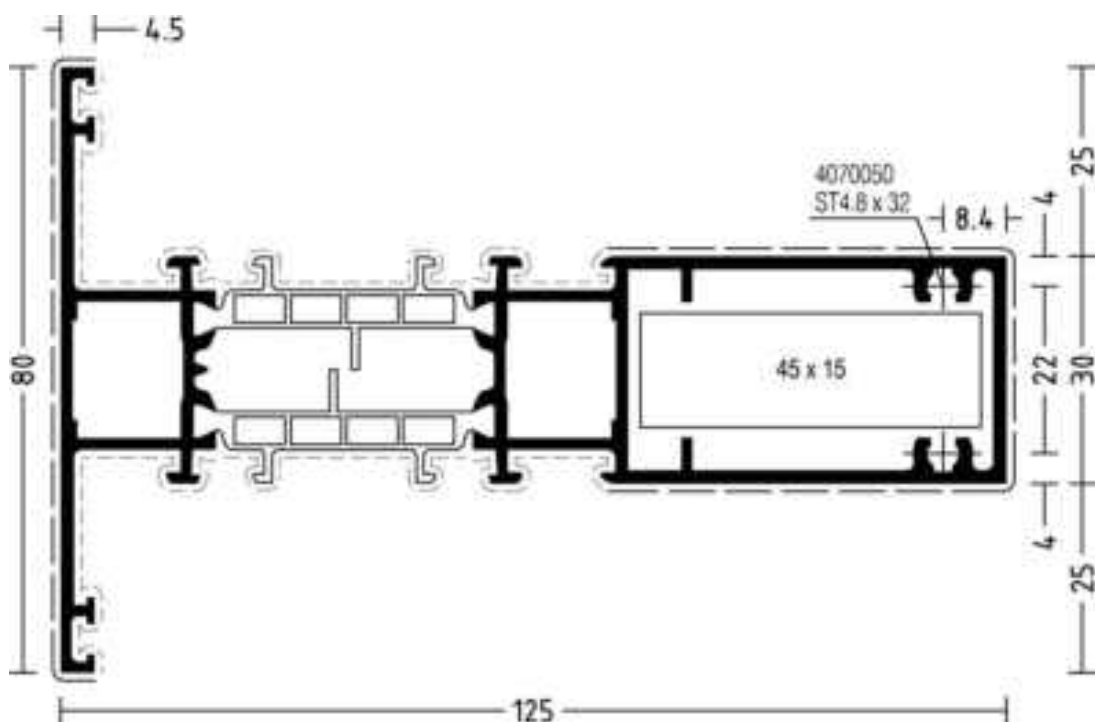



























Stulpaufsatzprofil Fenstertüre auswärts
Double casement supplementary profile French window outwards

	 m	 mm	 mm										
 1917241	6,5	461	215	4950008	2x4070000	1x4960004	1x4070000	1x4070030	5910006	5940101	5940001	5930003	
				4950008	2x4070000	1x4960004	1x4070000	1x4070030	5910006	5940101	5940001	5930003	



1917241





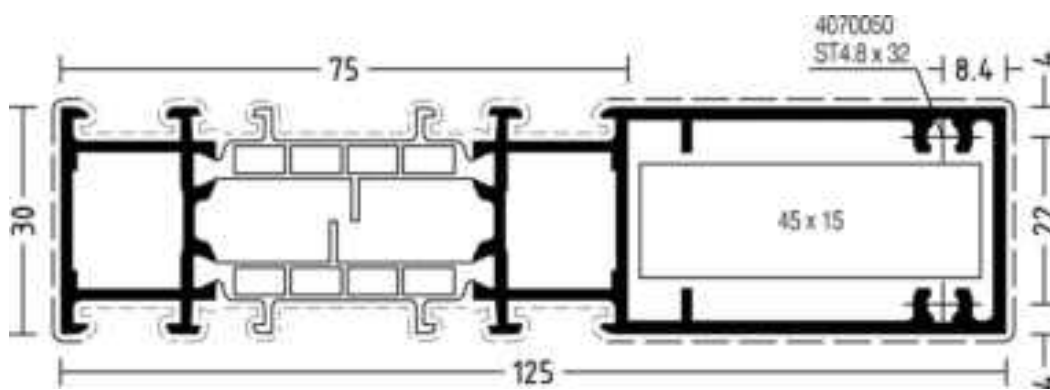









Gelenkeckwinkel und Gelenkverbinder siehe Zusatzartikel.
See additional articles for hinged corner angles and hinged connectors.

													
	m	mm	mm										
 1917244	6,5	336	165	 4950008	 2x4070000	 1x4960004	 1x4070000	 1x4070030	 5910006	 5940101	 5940001	 5930003	
				 4950008	 2x4070000	 1x4960004	 1x4070000	 1x4070030	 5910006	 5940101	 5940001	 5930003	



1917244





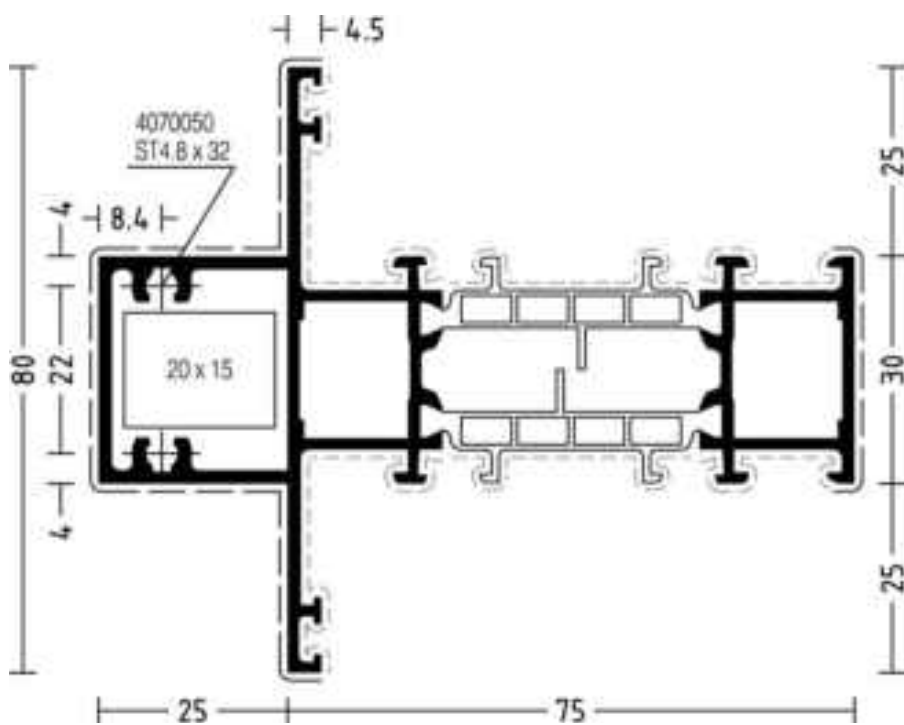









Gelenkeckwinkel und Gelenkverbinder siehe Zusatzartikel.
See additional articles for hinged corner angles and hinged connectors.

	 m	 mm	 mm										
 1917246	6,5	411	160	4950008	2x4070000	1x4960004	1x4070000	1x4070030	5910006	5940101	5940001	5930003	
				4950008	2x4070000	1x4960004	1x4070000	1x4070030	5910006	5940101	5940001	5930003	



1917246





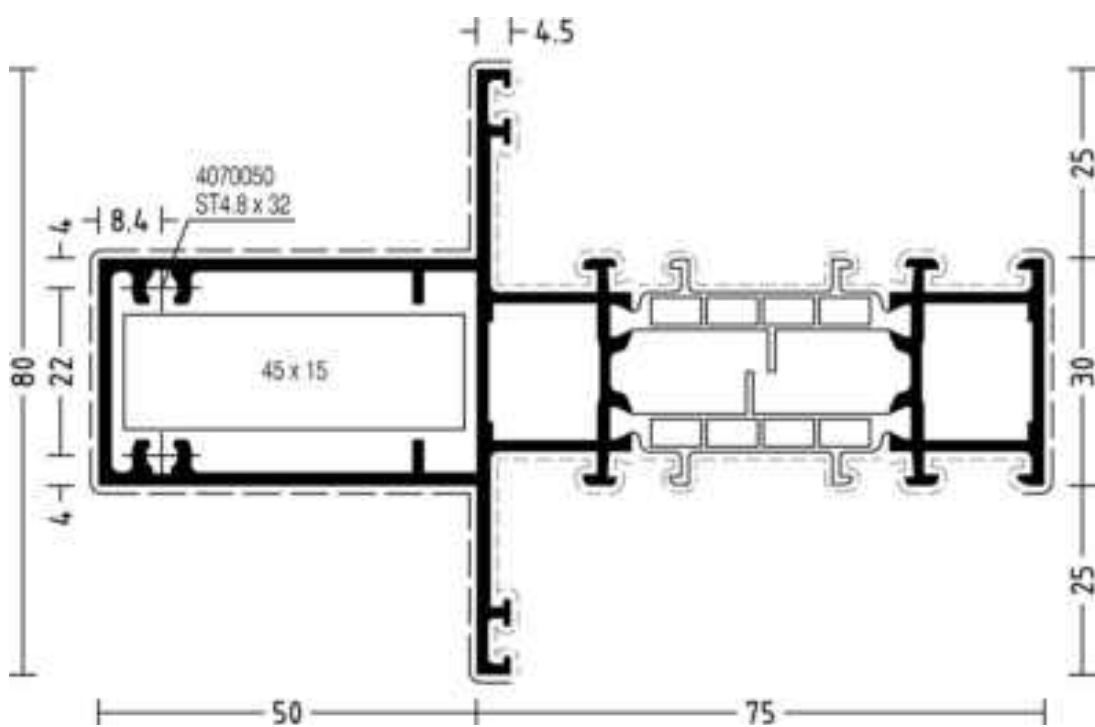









Gelenkeckwinkel und Gelenkverbinder siehe Zusatzartikel.
See additional articles for hinged corner angles and hinged connectors.

												
	m	mm	mm									
 1917247	6,5	461	210	4950008	2x4070000	1x4960004	1x4070000	1x4070030	5910006	5940101	5940001	5930003
				4950008	2x4070000	1x4960004	1x4070000	1x4070030	5910006	5940101	5940001	5930003



1917247

Gelenkeckwinkel und Gelenkverbinder siehe Zusatzartikel.
See additional articles for hinged corner angles and hinged connectors.

	 m	 mm	 mm									
 1917248	6,5	511	260	4950008	2x4070000	1x4960004	1x4070000	1x4070030	5910006	5940101	5940001	5930003
				4950008	2x4070000	1x4960004	1x4070000	1x4070030	5910006	5940101	5940001	5930003

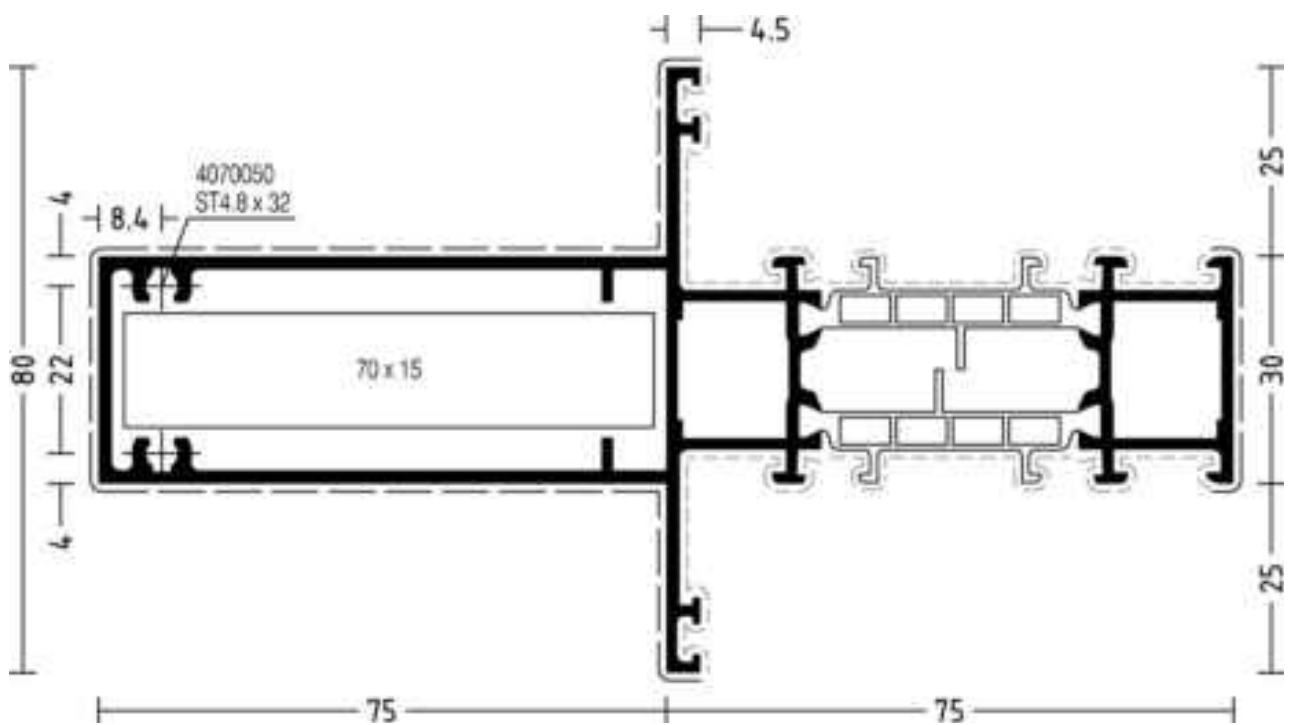















1917248

Gelenkeckwinkel und Gelenkverbinder siehe Zusatzartikel.
See additional articles for hinged corner angles and hinged connectors.

WICLINE 75

Stützenprofile Mullion profiles for windows



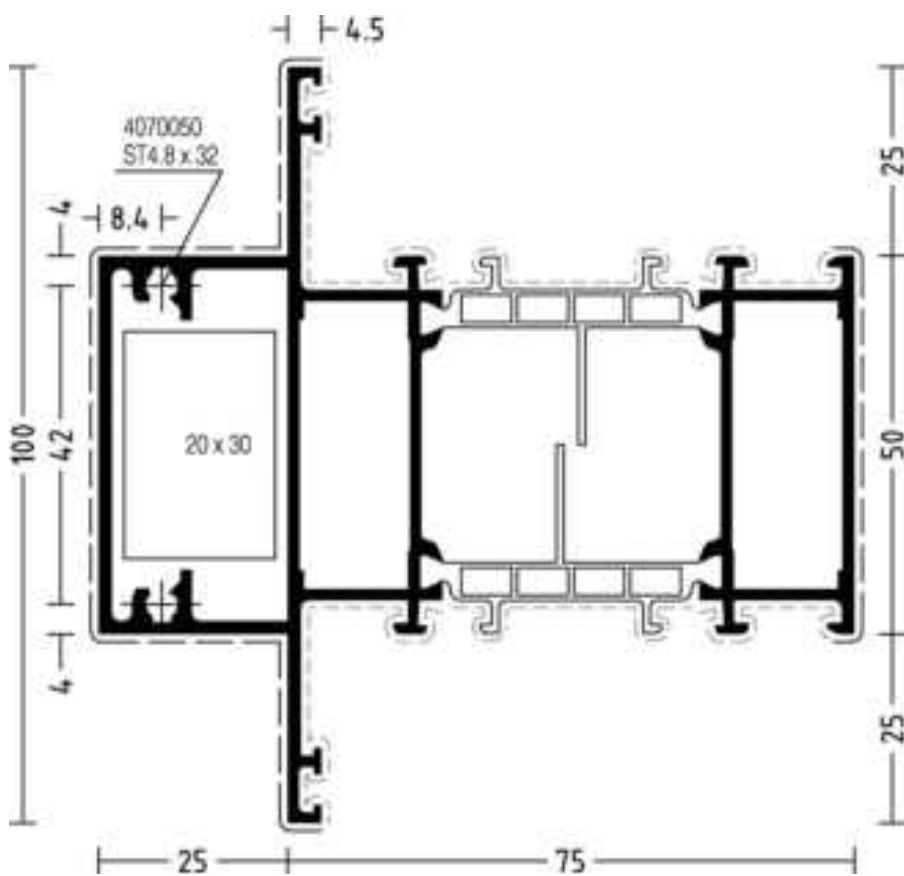











	 m	 mm	 mm										
 1917249	6,5	451	200	4950010	2x4070000	1x4960006	1x4070000	1x4070030	5910006	5940101	5940001	5930003	5930003
				4950010	2x4070000	1x4960006	1x4070000	1x4070030	5910006	5940101	5940001	5930003	5930003



1917249

WICLINE 75

Stützenprofile Mullion profiles for windows



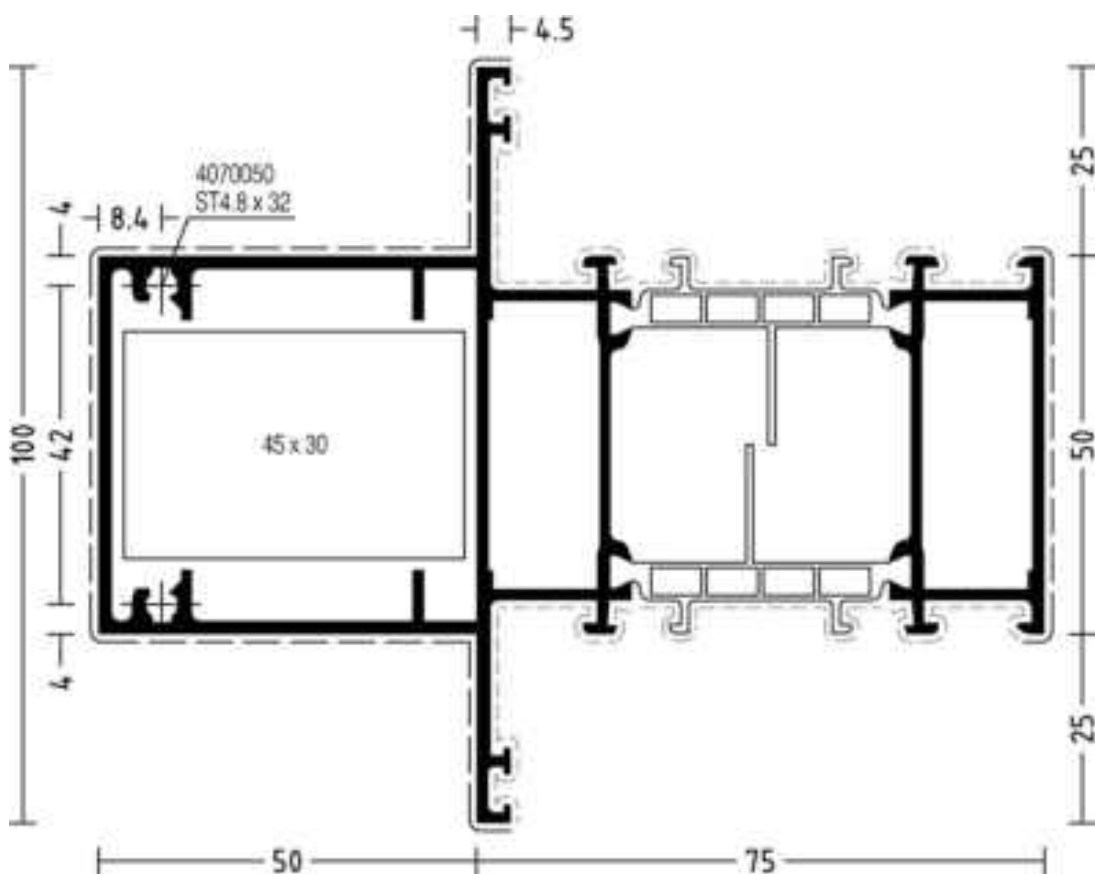











	 m	 mm	 mm									
 1917250	6,5	501	250	4950010	2x4070000	1x4960006	1x4070000	1x4070030	5910006	5940101	5940001	5930003
				4950010	2x4070000	1x4960006	1x4070000	1x4070030	5910006	5940101	5940001	5930003



1917250







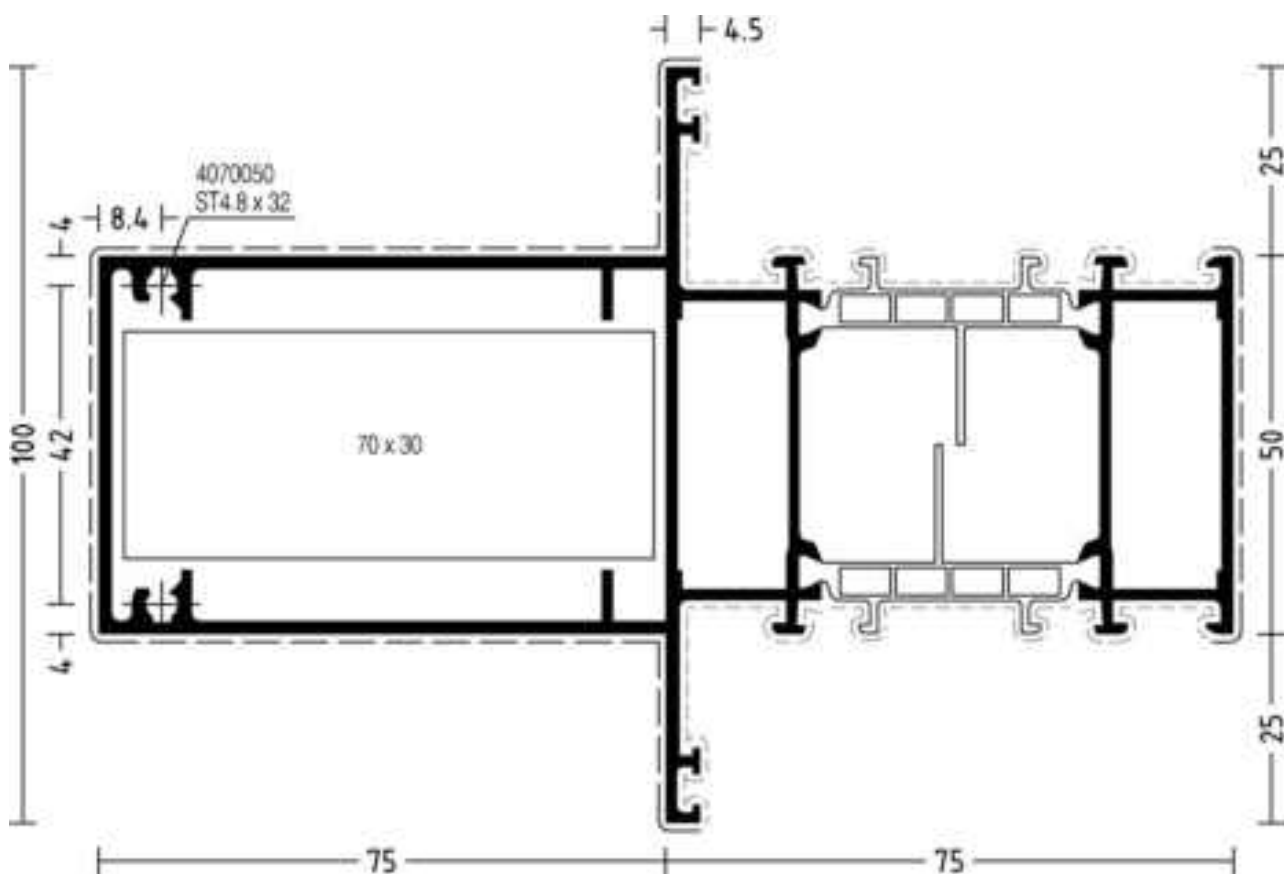







WICLINE 75

Stützenprofile Mullion profiles for windows

	 m	 mm	 mm									
 1917251	6,5	551	300	4950010	2x4070000	1x4960006	1x4070000	1x4070030	5910006	5940101	5940001	5930003
				4950010	2x4070000	1x4960006	1x4070000	1x4070030	5910006	5940101	5940001	5930003







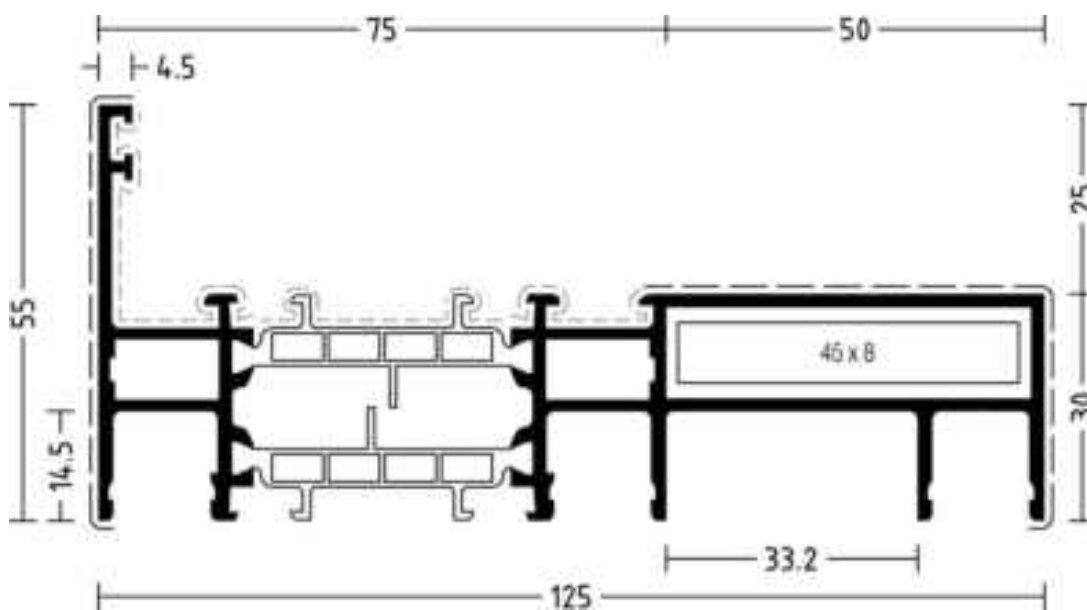









1917251

	 m	 mm	 mm									
 1917256	6,5	486	138	4950005	2x4070009	-	-	-	5910006	-	-	5930003
				4950005	2x4070009	-	-	-	5910006	-	-	5930003



1917256





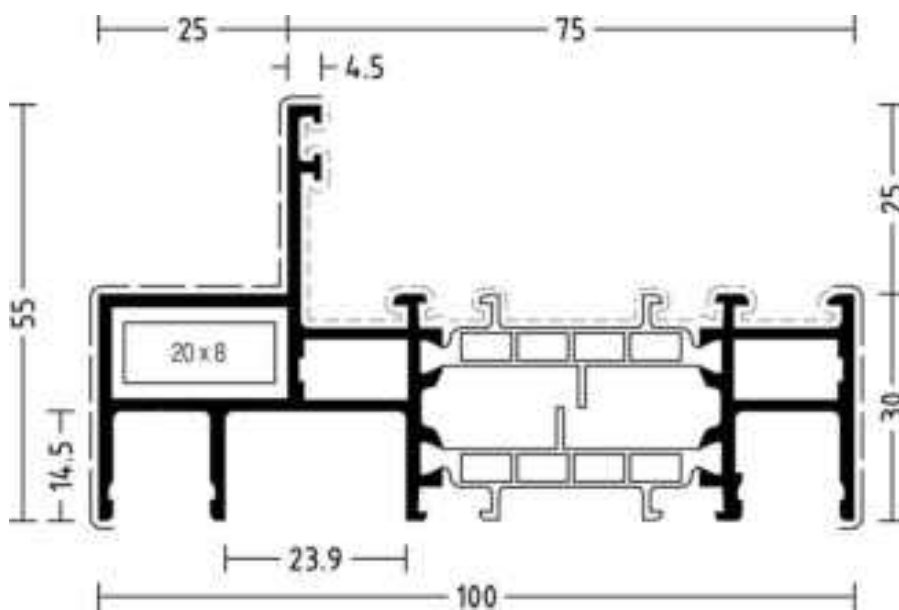









Gelenkeckwinkel und Gelenkverbinder siehe Zusatzartikel.
See additional articles for hinged corner angles and hinged connectors.

	 m	 mm	 mm										
 1917258	6,5	405	110	4950005	2x4070009	-	-	-	5910006	-	-	5930003	
				4950005	2x4070009	-	-	-	5910006	-	-	5930003	



1917258





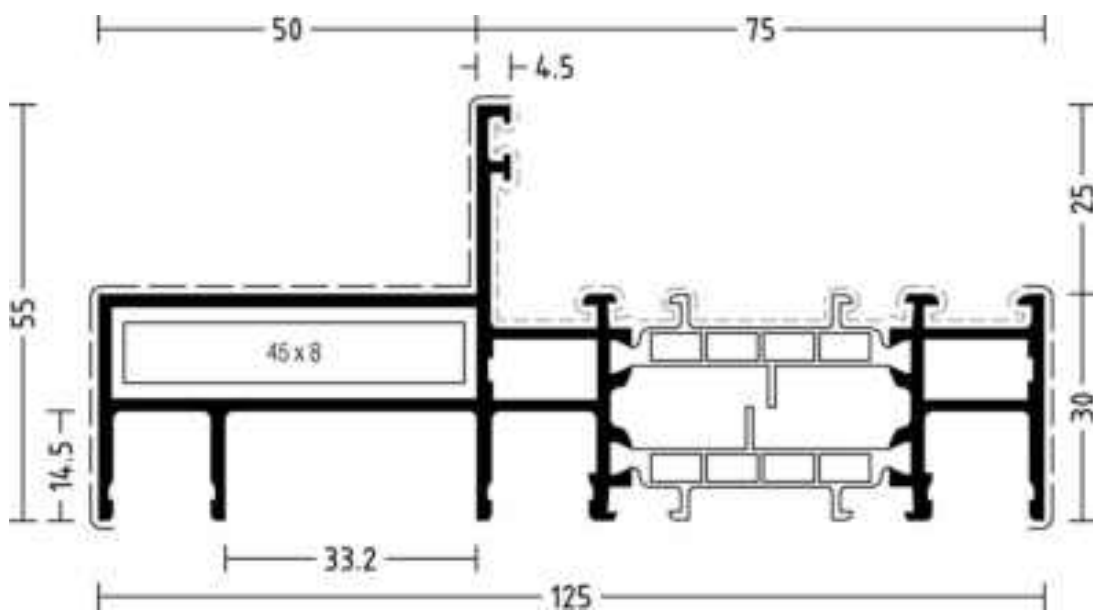









Gelenkeckwinkel und Gelenkverbinder siehe Zusatzartikel.
See additional articles for hinged corner angles and hinged connectors.

	 m	 mm	 mm										
 1917259	6,5	486	135	4950005	2x4070009	-	-	-	5910006	-	-	5930003	
				4950005	2x4070009	-	-	-	5910006	-	-	5930003	



1917259

Gelenkeckwinkel und Gelenkverbinder siehe Zusatzartikel.
See additional articles for hinged corner angles and hinged connectors.

	 m	 mm	 mm										
 1917260	6,5	536	160	4950005	2x4070009	-	-	-	5910006	-	-	5930003	
				4950005	2x4070009	-	-	-	5910006	-	-	5930003	

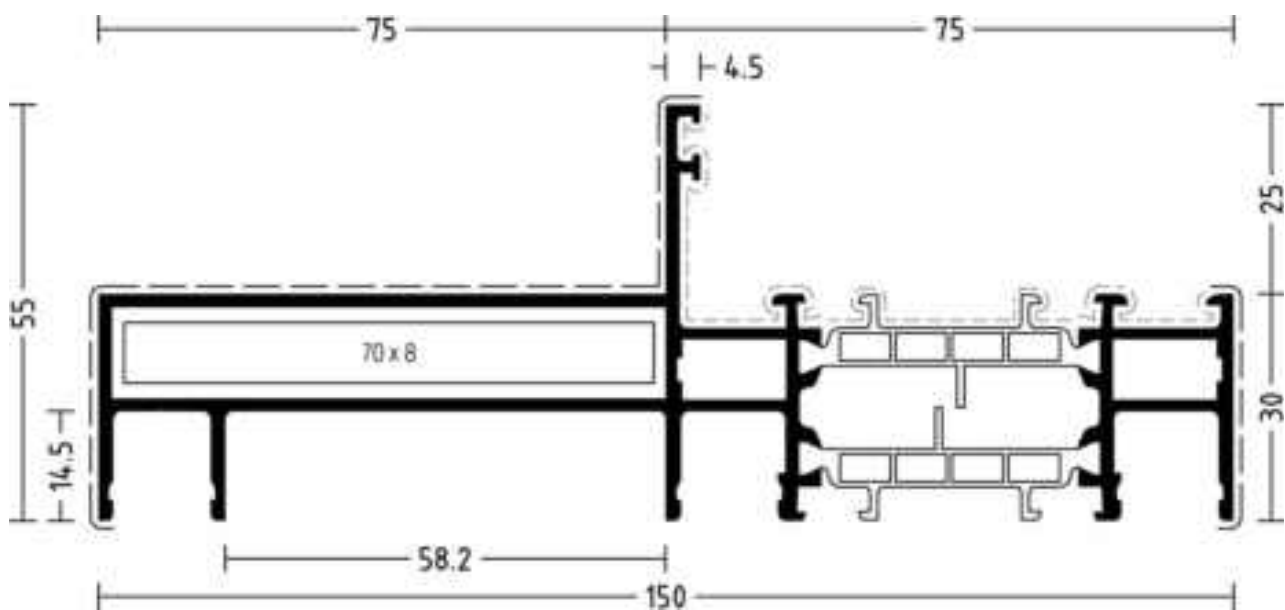















1917260

Gelenkeckwinkel und Gelenkverbinder siehe Zusatzartikel.
See additional articles for hinged corner angles and hinged connectors.

WICLINE 75

Stützenprofile Mullion profiles for windows



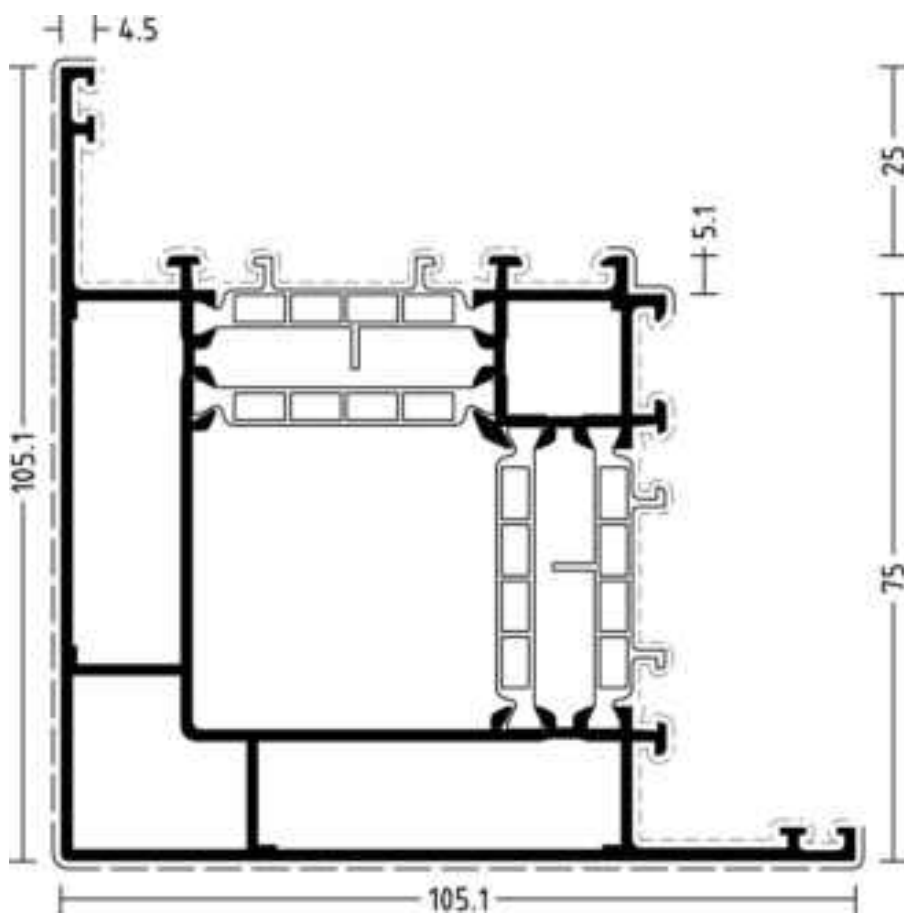











												
	m	mm	mm									
 1917270	6,5	471	220	-	-	2x4960007	2x4070000	2x4070030	5910006	5940101	5940001	-
	-	-	-	-	-	-	-	-	5910006	5940101	5940001	-



1917270

WICLINE 75

Stützenprofile
Mullion profiles for windows



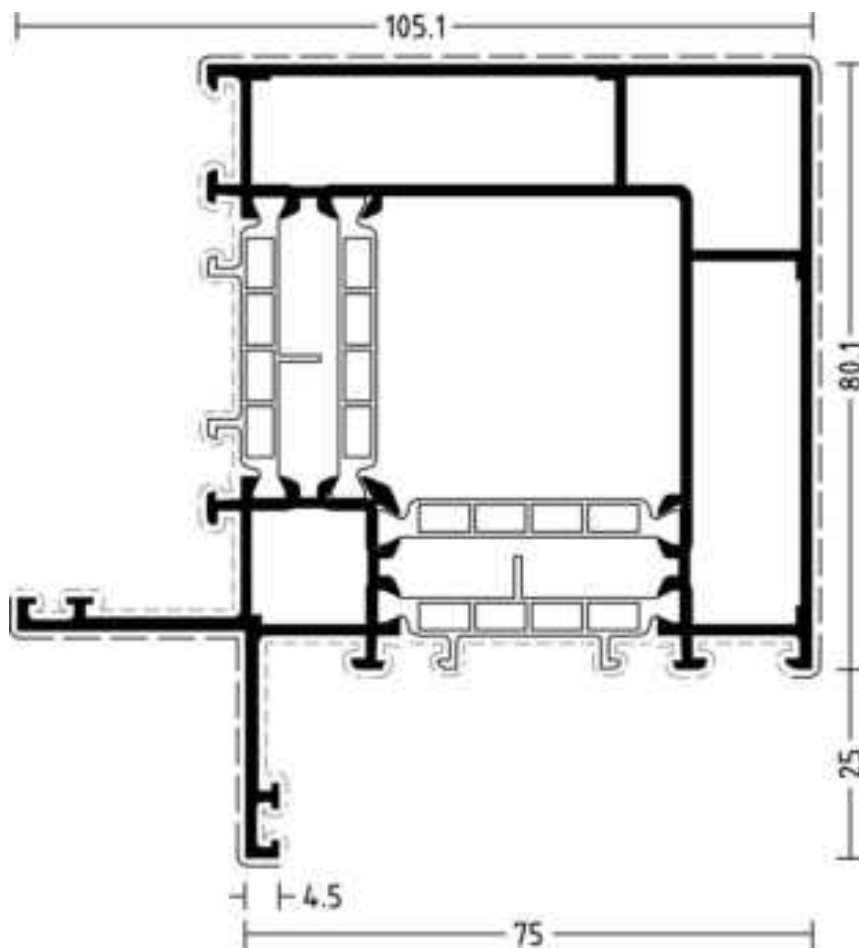











	 m	 mm	 mm									
 1917271	6,5	471	220	-	-	-	-	-	5910006	5940101	5940001	-
	-	-	-	-	-	2x4960007	2x4070000	2x4070030	5910006	5940101	5940001	-



1917271

WICLINE 75

Stützenprofile Mullion profiles for windows

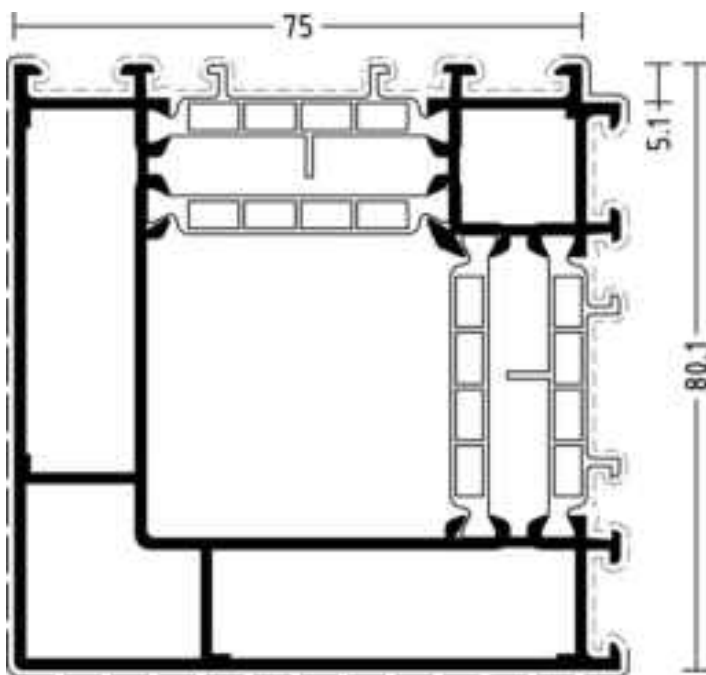

	 m	 mm	 mm										
 1917272	6,5	346	170	-	-	2x4960007	2x4070000	2x4070030	5910006	5940101	5940001	-	-
	-	-	-	-	-	-	-	-	5910006	5940101	5940001	-	-
1917273	6,5	274	98	-	-	1x4960005	2x4070000	2x4070030	5910006	5940101	5940001	-	-
	-	-	-	-	-	1x4960050	2x4070009	-	5910006	5940101	5940001	-	-

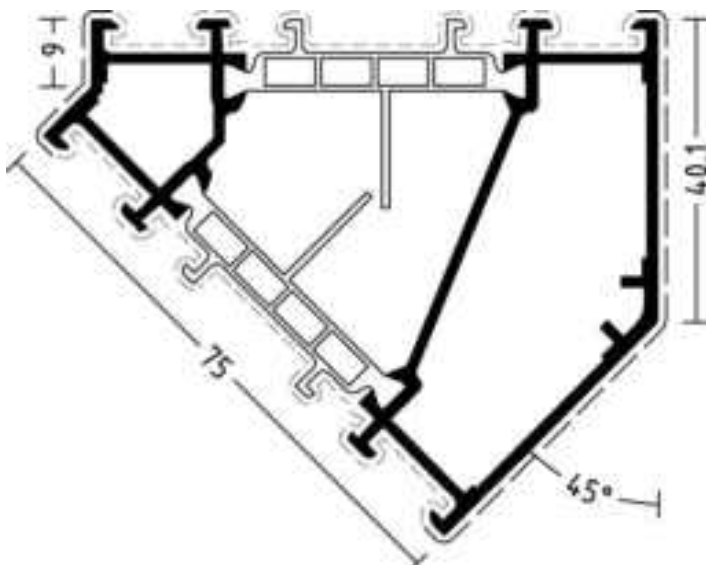

1917272



1917273

	 m	 mm	 mm
1917304	6,5	184	35
1917305	6,5	178	35

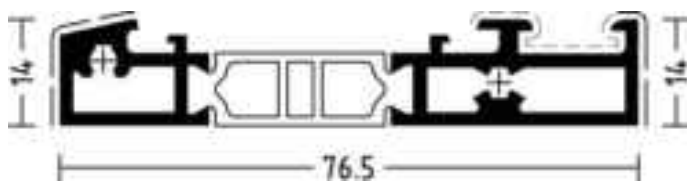

1917304

Fenstertüre auswärts
French window outwards

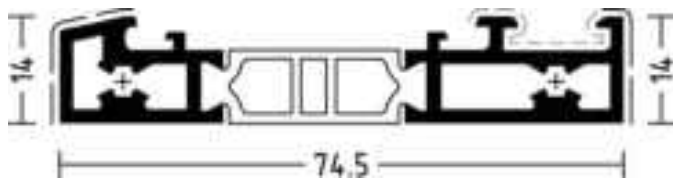



1917305

Fenstertüre einwärts
Casement door inwards







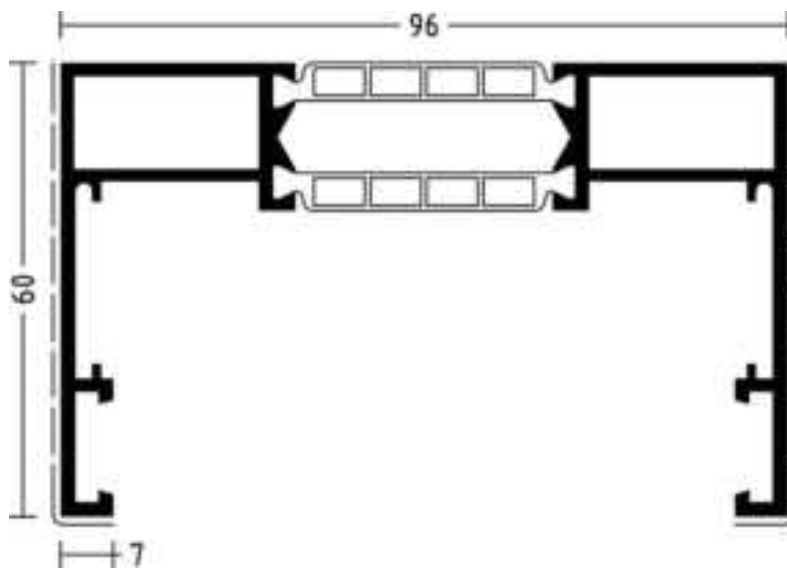







WICLINE 75

Bauanschlussprofile
Profiles for junction to structure

			
	m	mm	mm
1917307	6,5	417	120



1917307

	 m	 mm	 mm									
 1010463	6,5	196	1	-	-	-	-	-	-	-	-	-
 1010464	6,5	233	6	-	-	-	-	-	-	-	-	-
1917301	6,5	193	60	4950057	-	-	-	-	-	-	-	5930003
				4950008	2x4070000	-	-	-	-	5940101	-	5930003

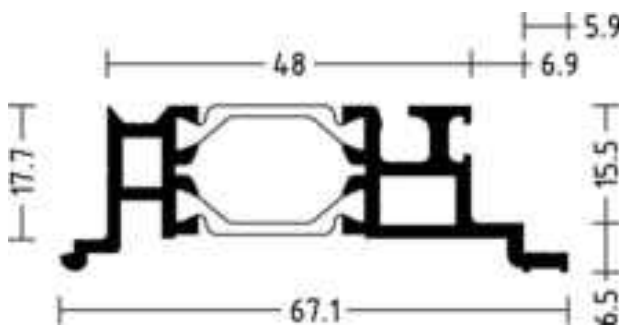

1010463

Verwendung:
Aufsatzprofil für Blendrahmenprofile zur Einspannung in WICTEC Serie
Application:
Supplementary profile of frame profiles for clamping

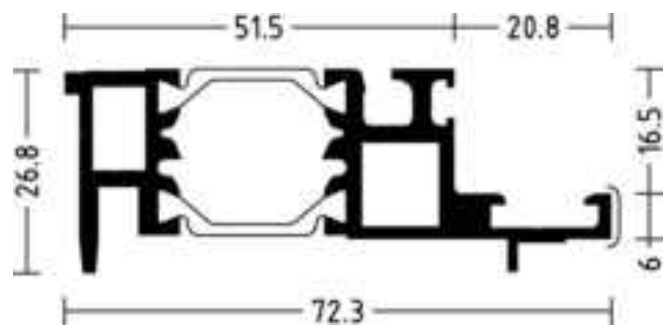





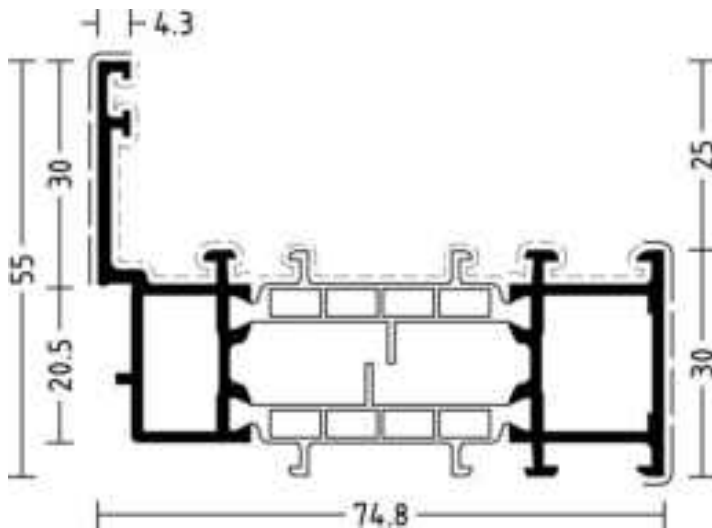









1010464

Verwendung:
Aufsatzprofil für Blendrahmenprofile zur Einspannung in WICTEC Serie
Application:
Supplementary profile of frame profiles for clamping



1917301

Falzverbreiterungsprofil
Eckverbindung außen:
Selbstzuschnitt oder Al-Eckwinkel konfektioniert 4950057.
Rebate widening profile
Corner connection outer shell:
Self-cut or prefabricated corner angle 4950057.

	 m	 mm	 mm									
 1917303	6,5	277	60	4950057	-	-	-	-	-	-	-	5930003
				4950008	2x4070000	-	-	-	-	5940101	-	5930003

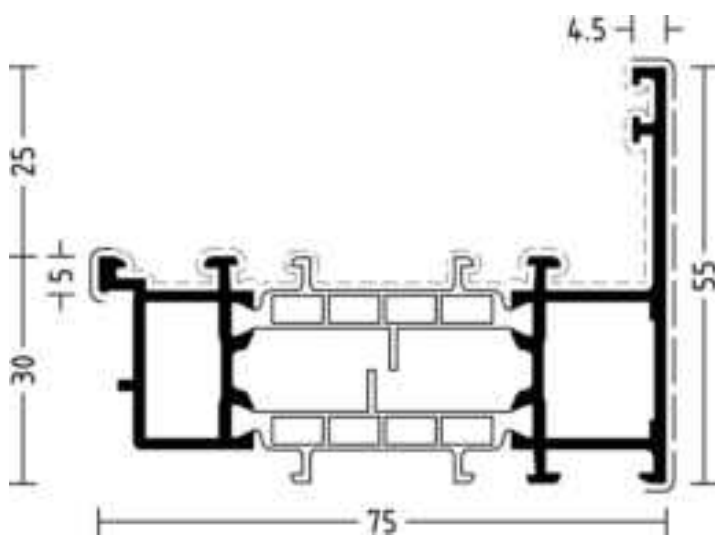

1917303

Wechselprofil von außen verglast!

Eckverbindung außen:

Selbstzuschchnitt oder Al-Eckwinkel konfektioniert 4950057.

Stoßverbindung nicht möglich.

Profil nicht für Beschlagseinbau geeignet!

Rebate reversion profile, glazing from outside!

Corner connection outer shell:















Self-cut or prefabricated corner angle 4950057.

Butt-joint connection not possible.

Profile not suitable for fitting installation!

WICLINE 75





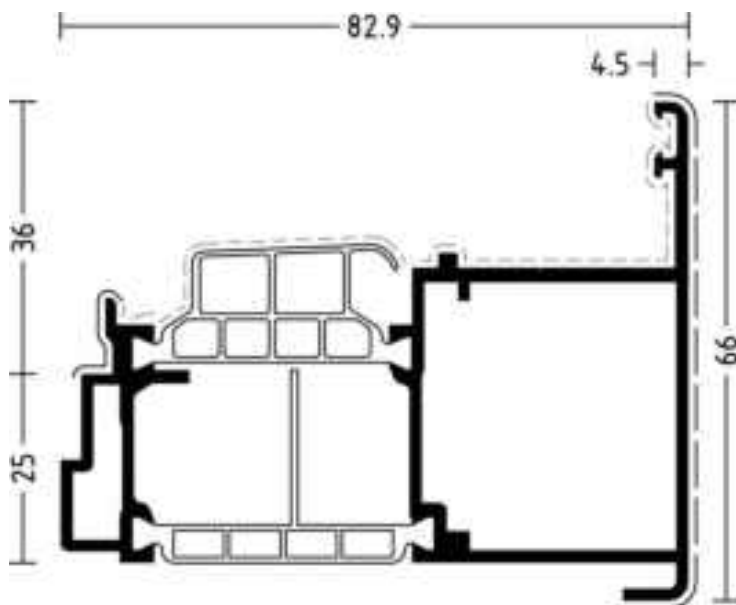









Aufsatzprofile Supplementary profiles

	 m	 mm	 mm										
 1917165	6,5	281	66	4950035	2x4070000	-	-	-	5910040	-	-	5930029	
				4950025	2x4070000	-	-	-	5910040	-	-	5930029	



1917165

Wechselprofil Senk-Klappfenster
Reversible profile Italian style window

												
	m	mm	mm									
 1917166	6,5	303	66	4950035	2x4070000	-	-	-	5910040	-	-	5930029
				4950025	2x4070000	-	-	-	5910040	-	-	5930029
3910040	6,5	302	66	-	-	-	-	-	5910042	-	-	5930025
				4950036	2x4070000	-	-	-	5910042	-	-	5930025

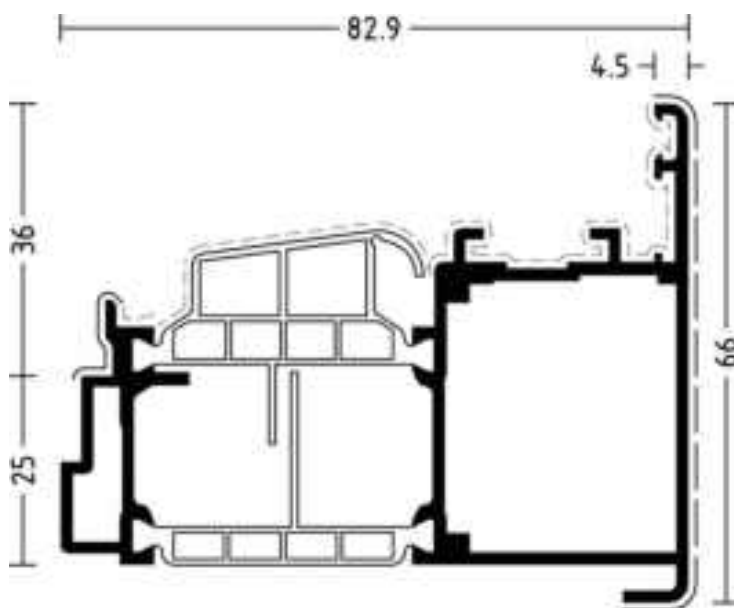

1917166

Wechselprofil Klappfenster, Fenstertüre auswärts
Reversible profile Top hung window, French window outwards

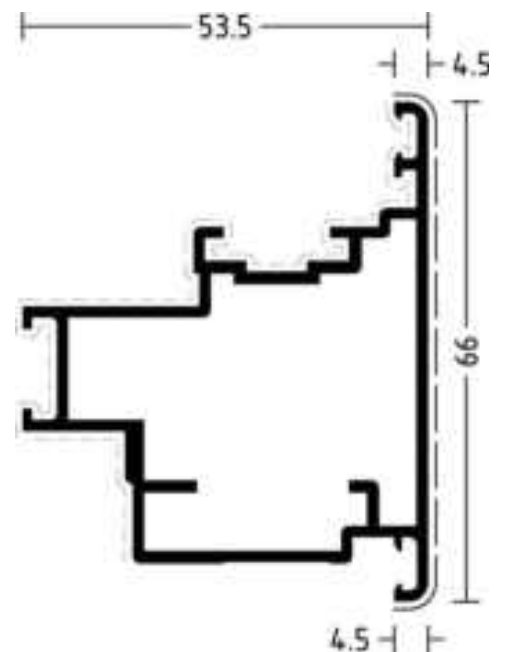

3910040

Wechselprofil, Schwing-Wendefenster
Reversible profile, Pivot window

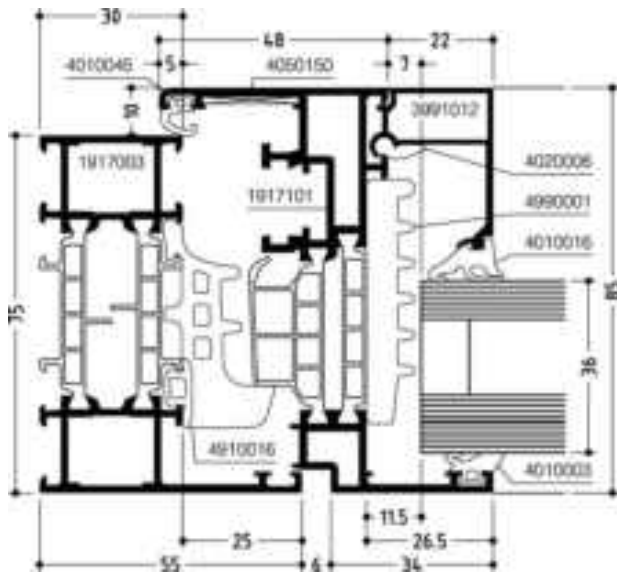

DOC-0000694350

Flügelprofil im
Blendrahmen mit
Spezial-Dämmprofil
*Sash profile in
frame with special
insulation profile*

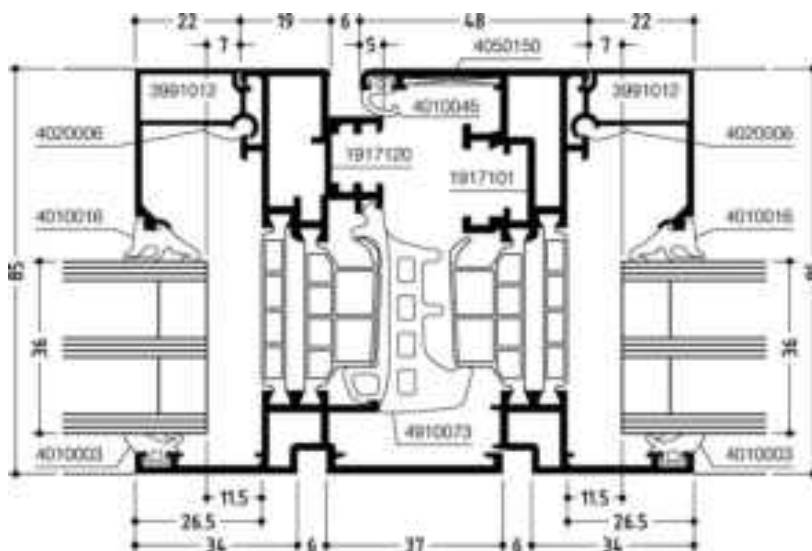

DOC-0000694379

Stulpfenster -
Mittelstoß
*Double casement
window - Meeting
stiles*

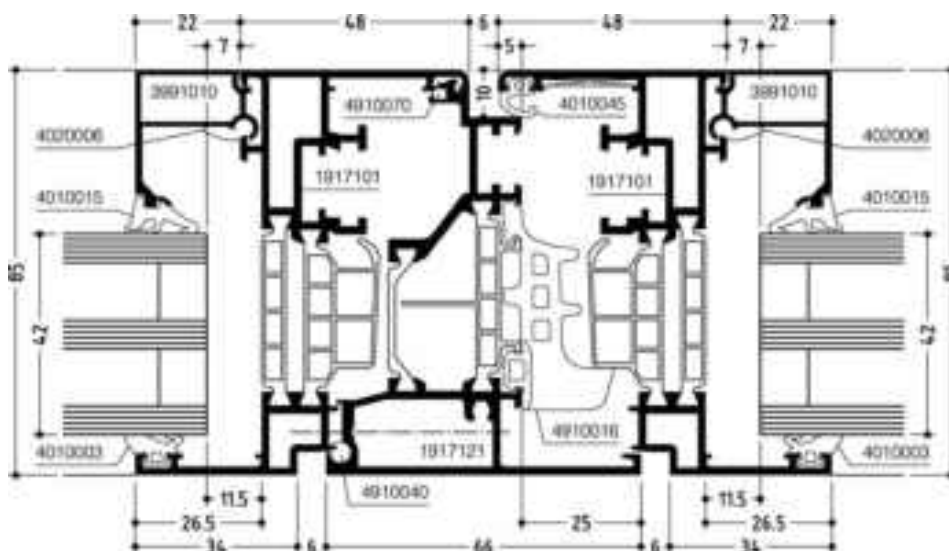

DOC-0000694464

Stulpfenster mit
Aufsatzprofil -
Mittelstoß
*Double casement
window with
supplem. profile -
Meeting stiles*

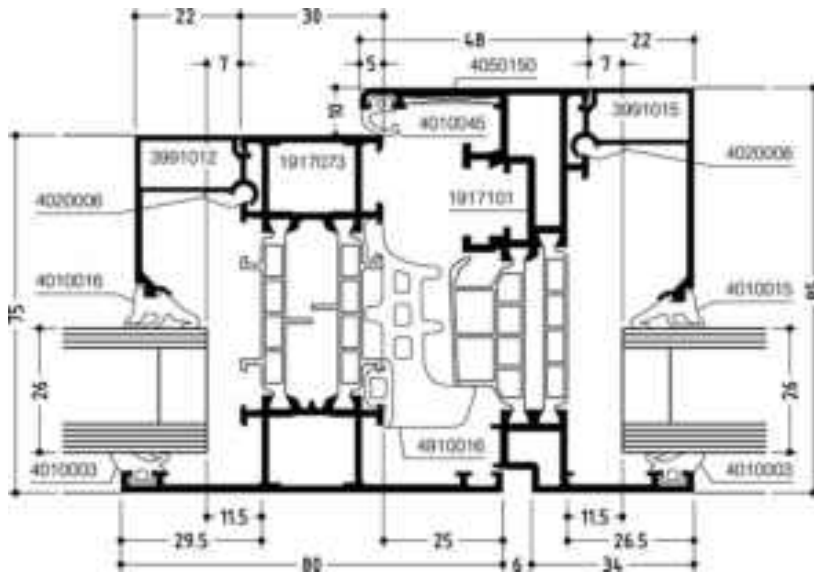

DOC-0000694477

Flügelprofil im
Blendrahmen mit
Kämpfer
*Sash profile in
frame with transom*

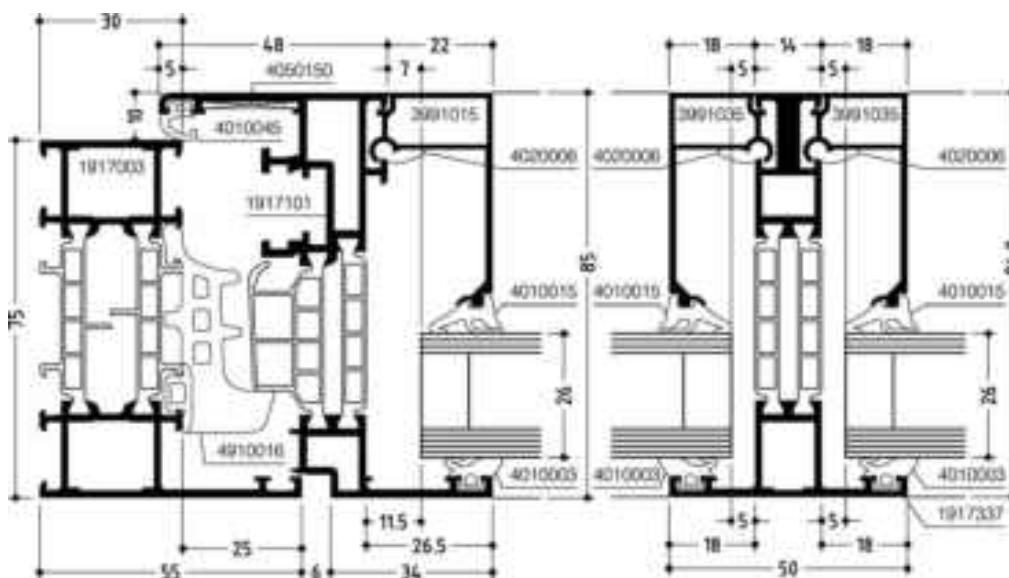

DOC-0000694538

Flügelprofil im
Blendrahmen mit
Sprossenprofil
*Sash profile in
frame with glazing
bar profile*

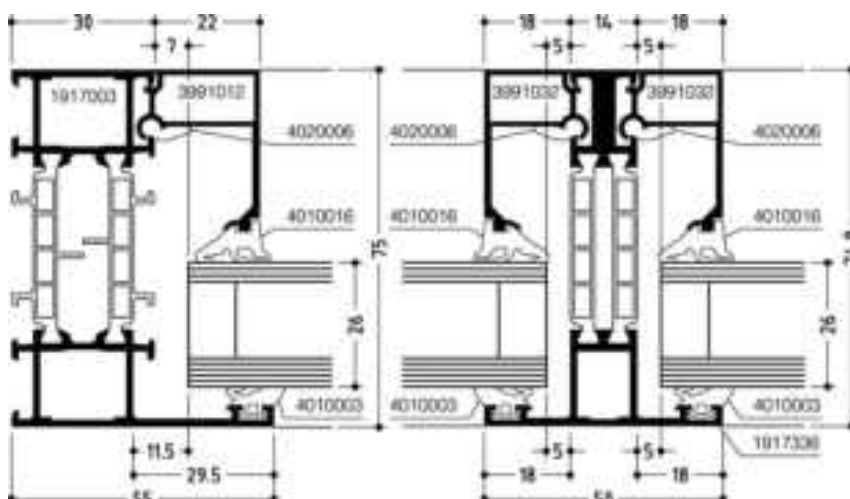

DOC-0000687278

Festverglasung mit
Sprossenprofil
*Fixed glazing with
glazing bar profile*

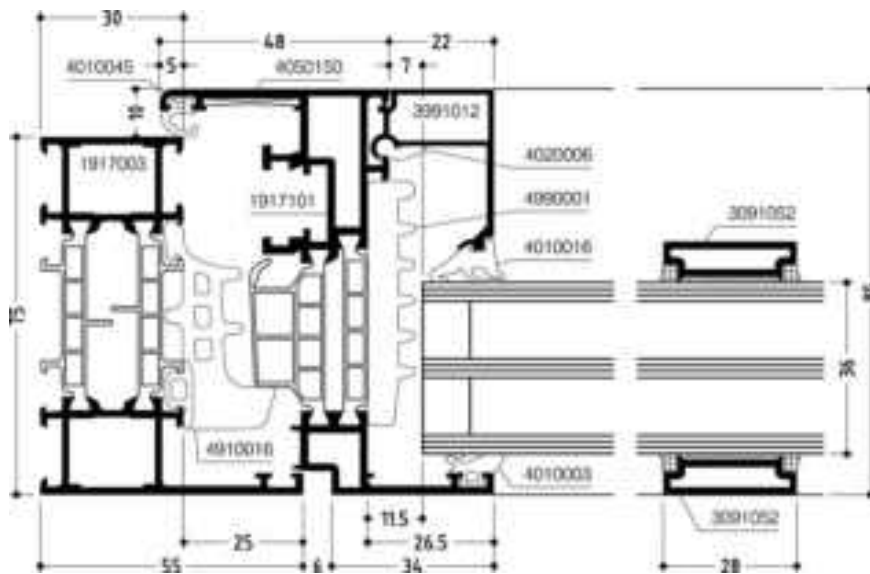

DOC-0000703537

Flügelprofil im
Blendrahmen mit
Ziersprossenprofil
*Sash profile in
frame with glazing
bar profile*

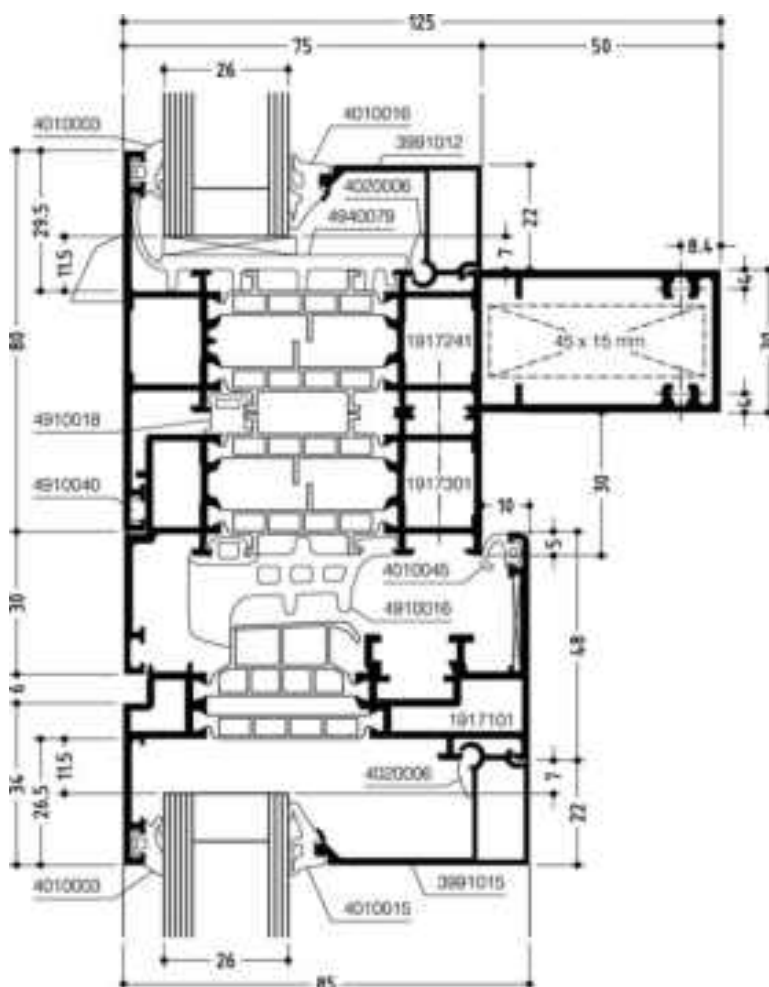

DOC-0000694696

Kämpferprofil nach
innen verstärkt mit
Falzverbreiterung
*Internally reinforced
transom profile with
rebate widening*

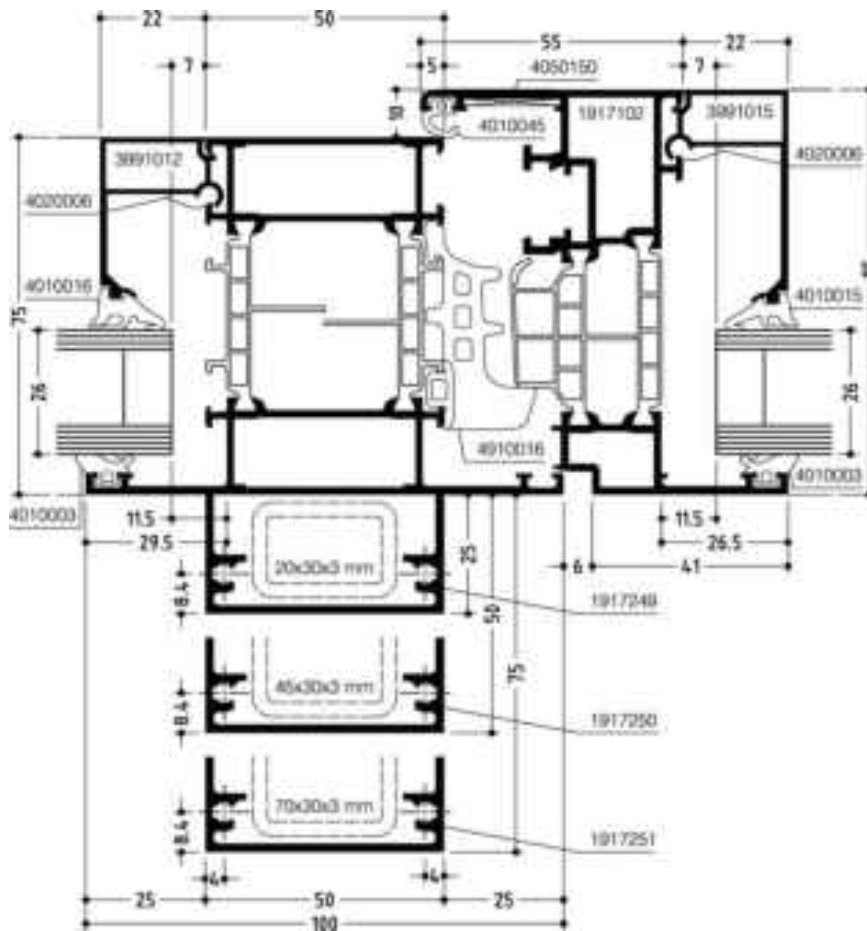

DOC-0000694742

Stützenprofile nach
außen verstärkt
*Externally
reinforced mullion
profiles*

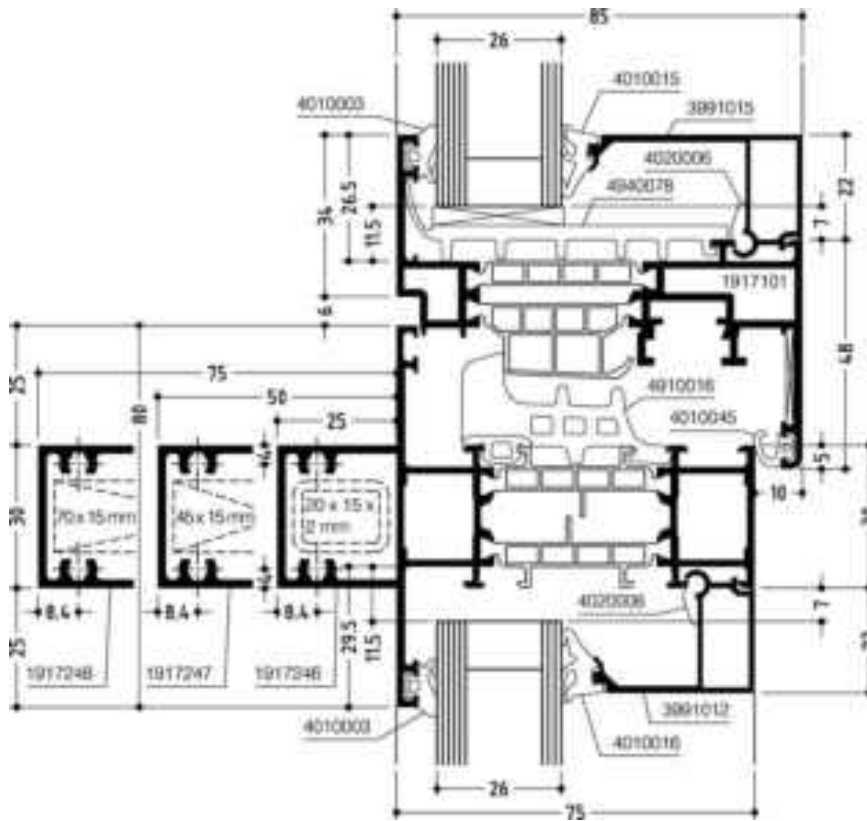

DOC-0000696312

Kämpferprofile nach außen
verstärkt
*Externally
reinforced transom
profiles*

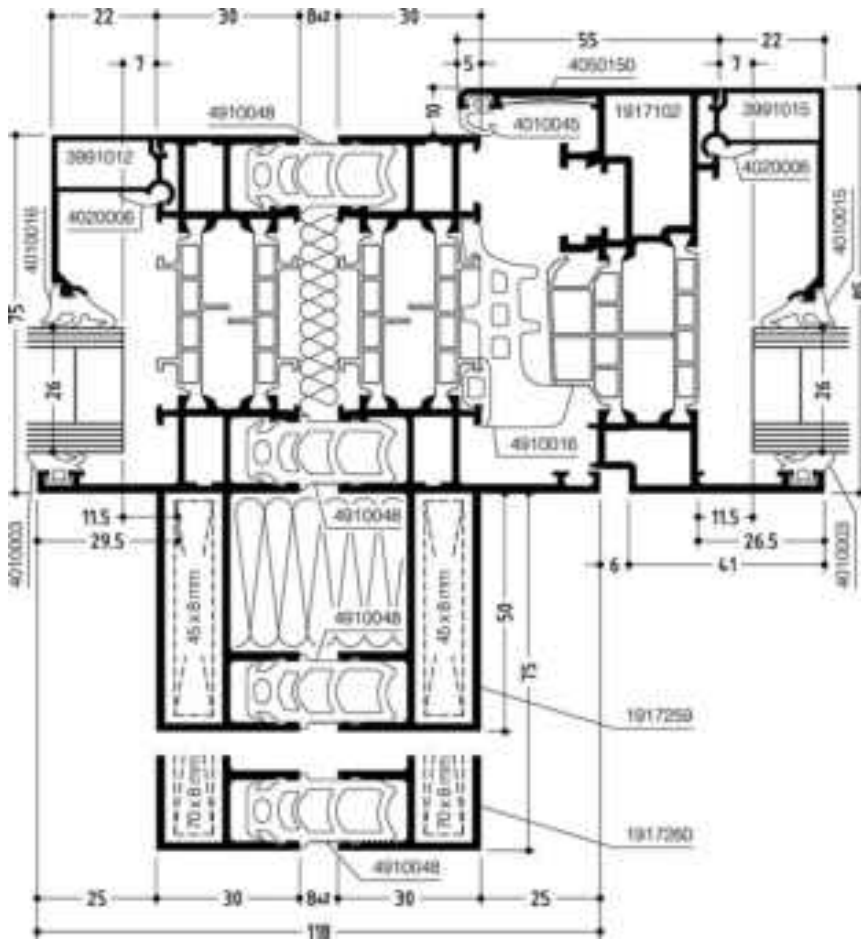

DOC-0000696410

Stützenprofile
geteilt, nach außen
verstärkt

*Externally
reinforced split
mullion profiles*

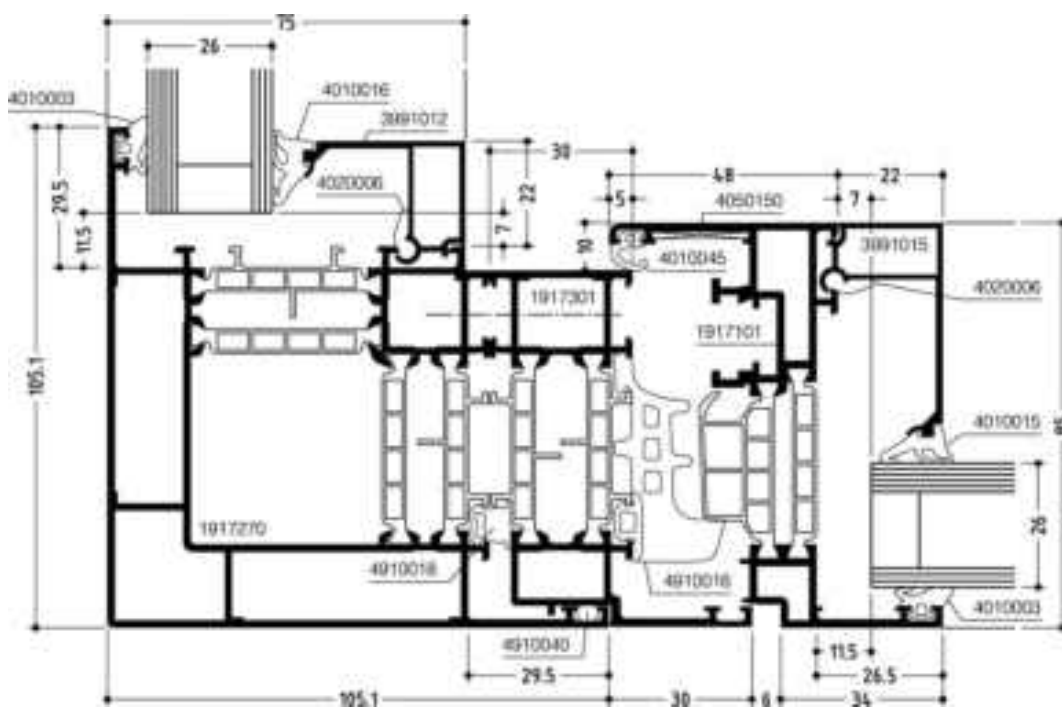

DOC-0000696467

Eckstützenprofil -
Außenecke 90°

*Corner mullion
profile of 90° outer
corner*

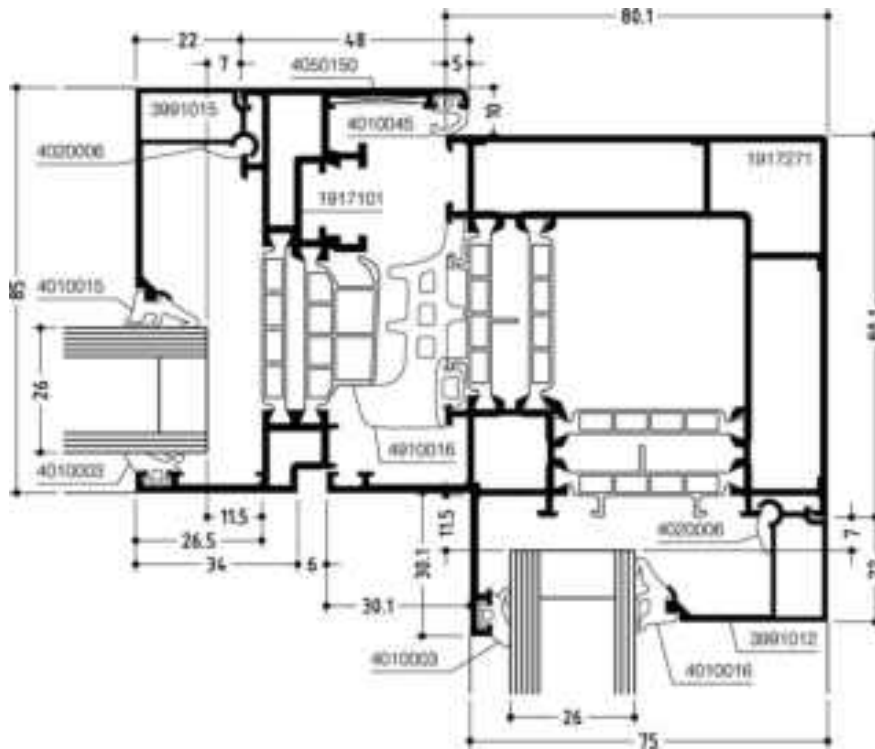

DOC-0000697290

Eckstützenprofil -
Innenecke 90°
*Corner mullion
profile of 90° inner
corner*

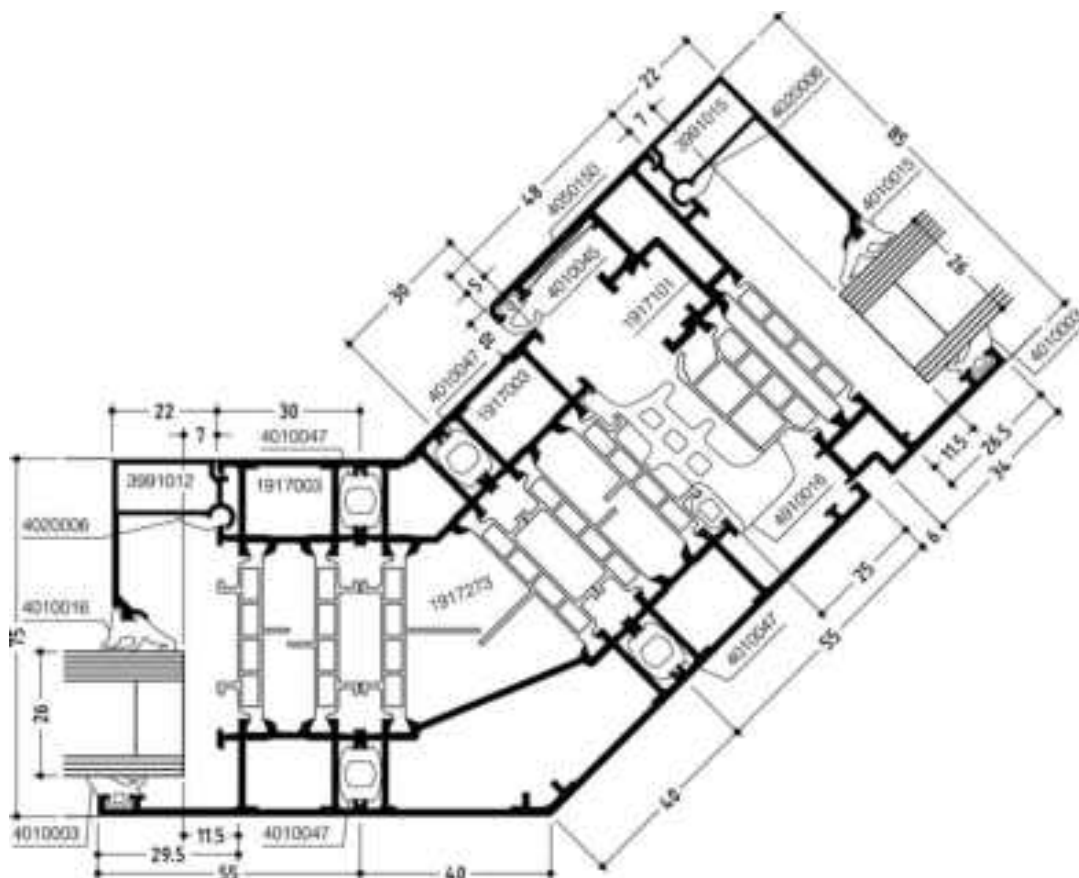

DOC-0000699370

Eckstützenprofil -
Außenecke 135°
*Corner mullion
profile of 135° outer
corner*

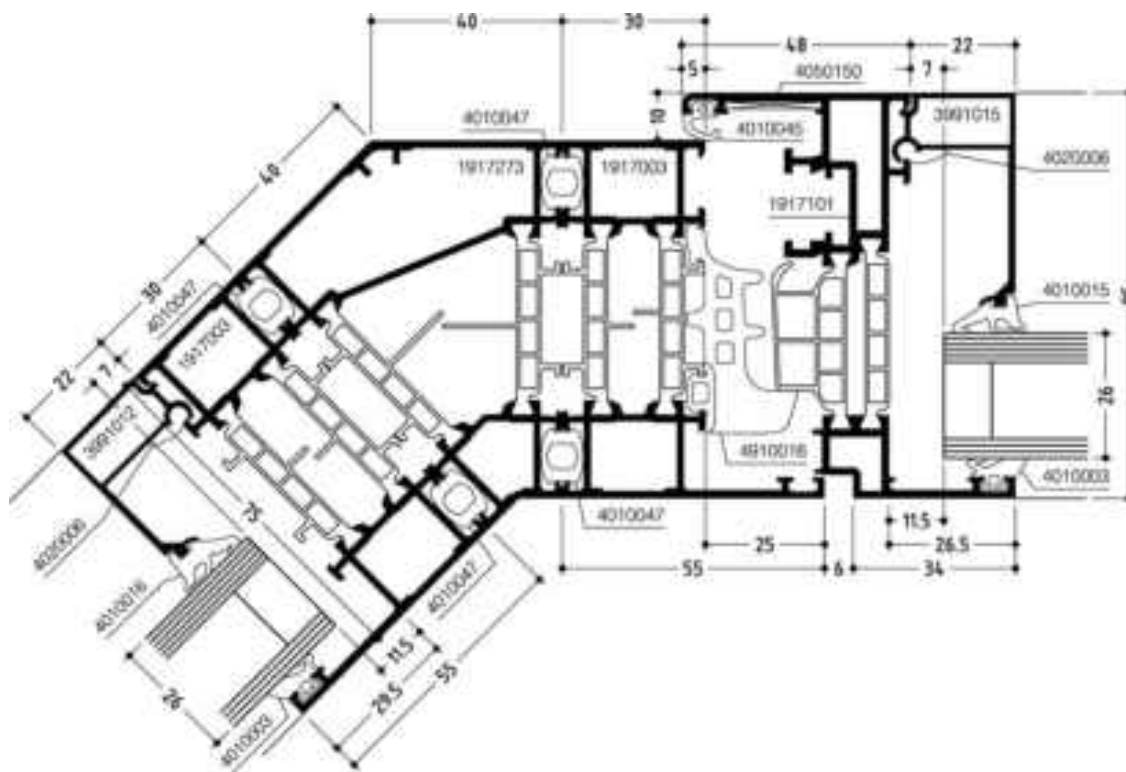

DOC-0000699568

Eckstützenprofil -
Innenecke 135°
Corner mullion
profile of 135° inner
corner

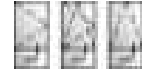
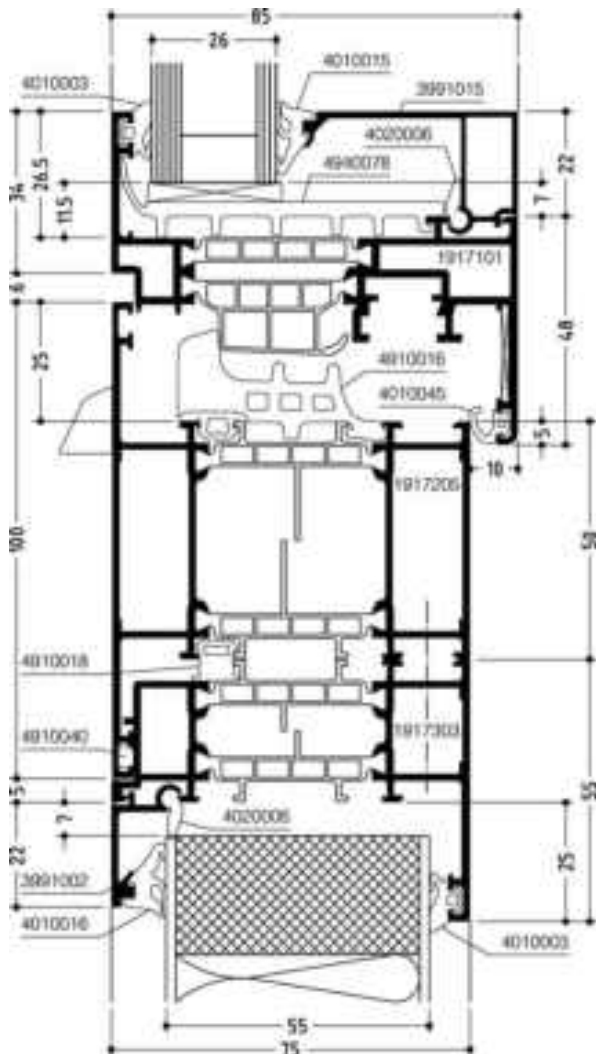

DOC-0000696474

Kämpferprofil mit
Plattenmontage
von außen

*Transom profile
with panel
assembly from
outside*

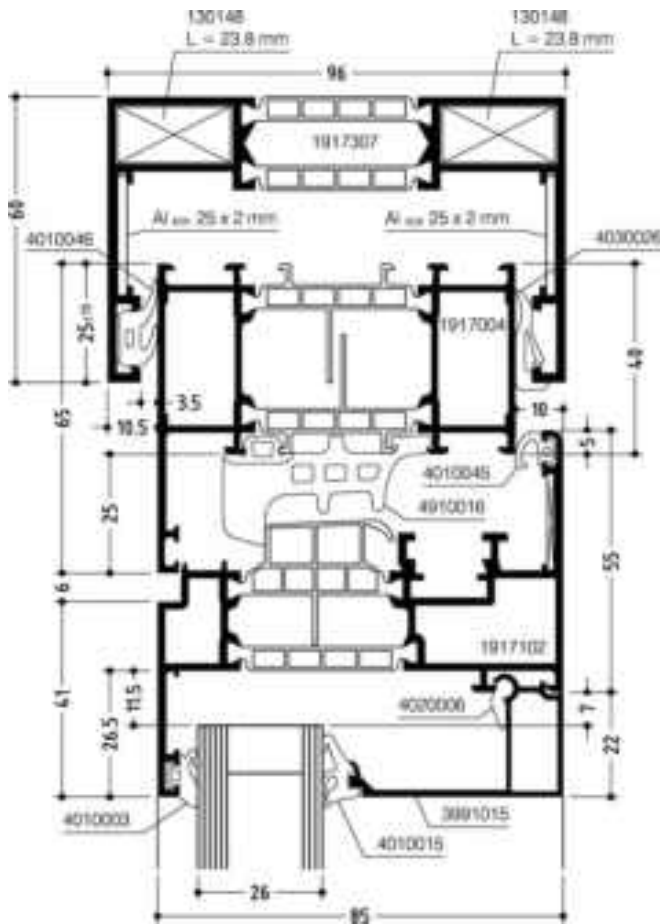

DOC-0000696477

Flügelprofil im
Blendrahmen mit
Baanschlussprofil
1917307

Sash profile in
frame with profile
1917307 for
junction to structure

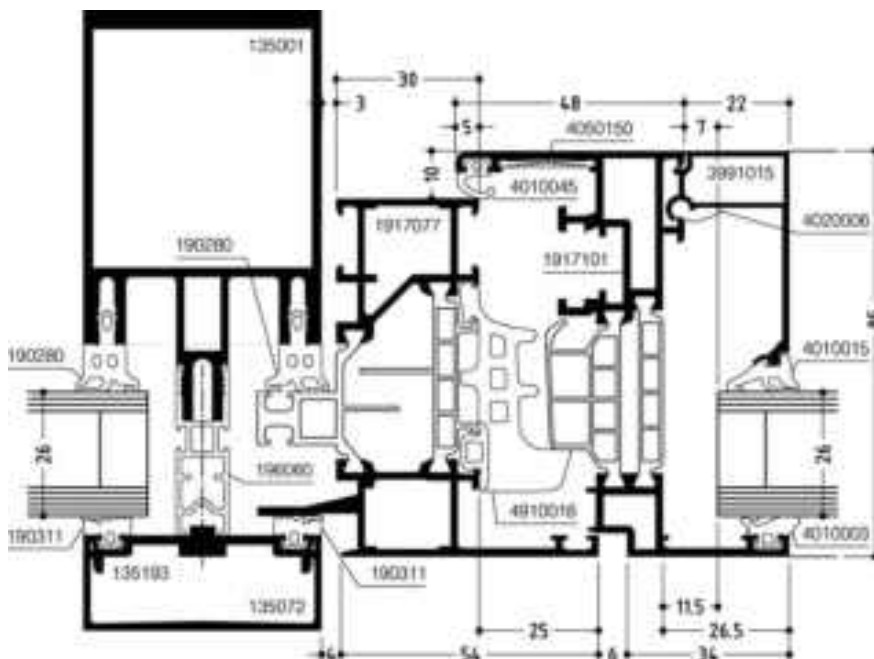

DOC-0000699621

Flügelprofil im
Einspannblendrah-
men

Sash profile in
clamping frame

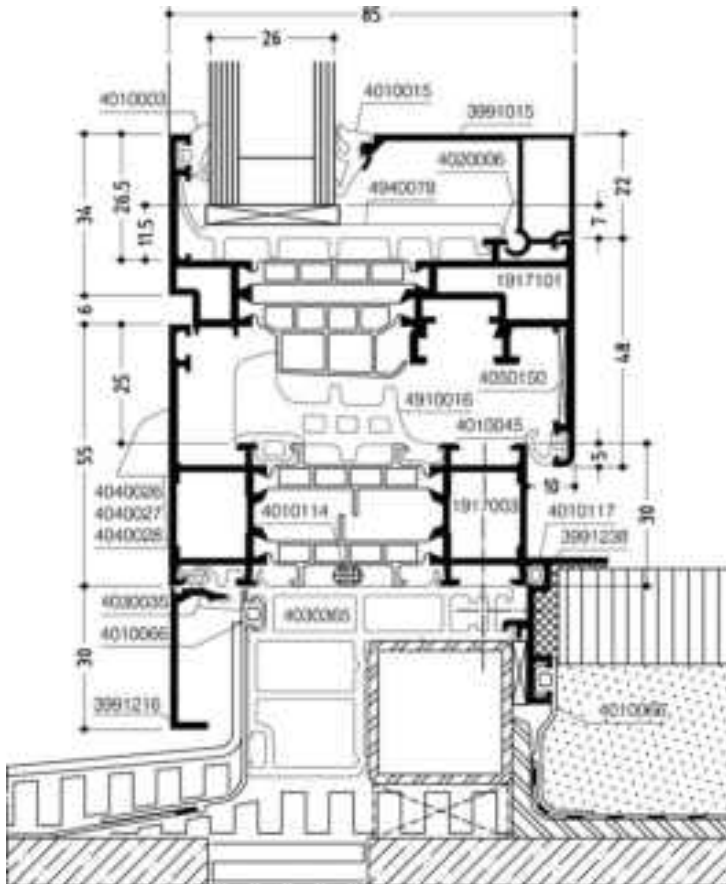

DOC-0000700295

Bauanschluss
unten mit Dämm-
auflage 4030365
*Bottom junction
to structure with
insulation support
4030365*

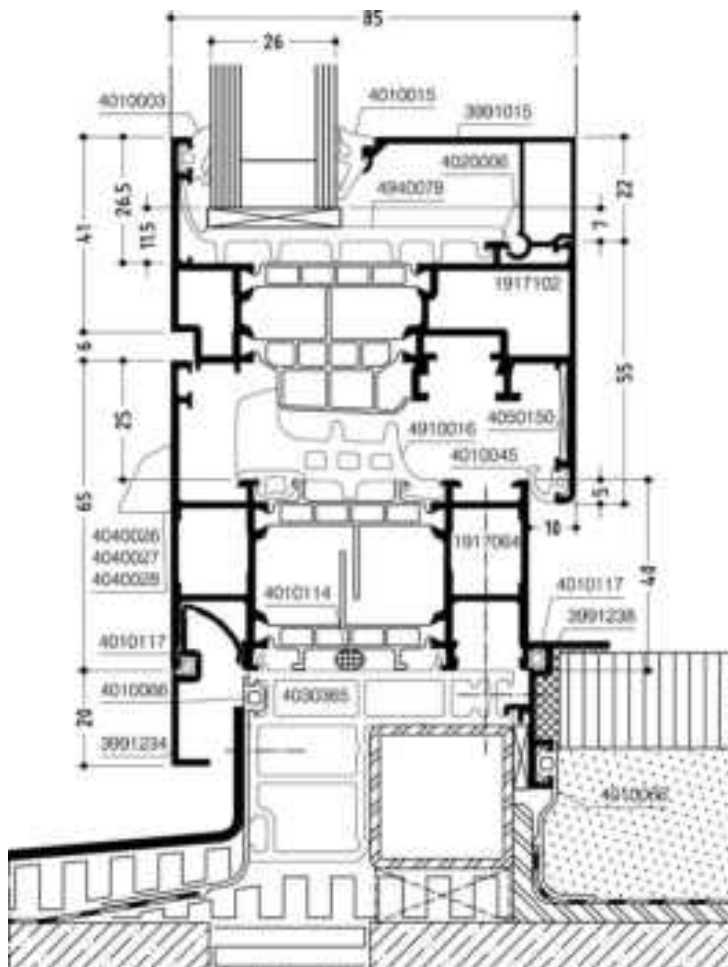

DOC-0000700195

Bauanschluss
unten mit Dämm-
auflage 4030365
*Bottom junction
to structure with
insulation support
4030365*

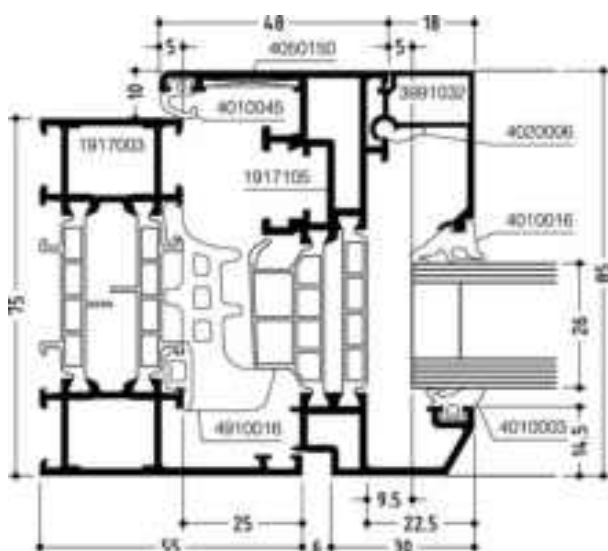

DOC-0000696481

Flügelprofil im
Blendrahmen,
Klassik-Design
*Sash profile in
frame, Classic
design*

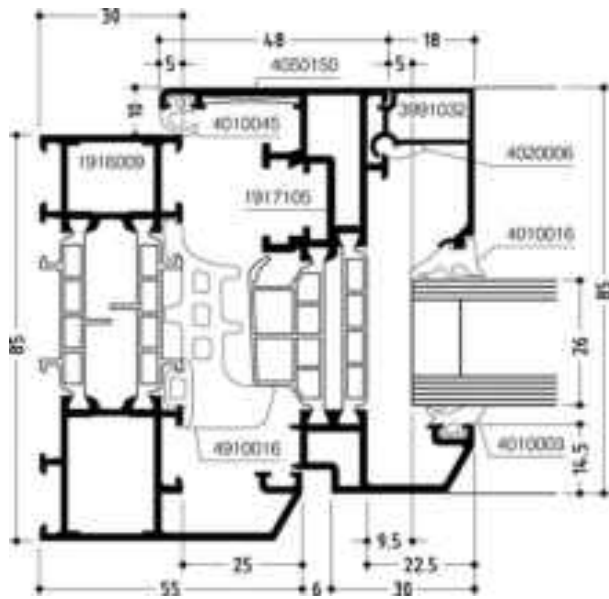

DOC-0000696595

Flügelprofil im
Blendrahmen,
Klassik-Design
*Sash profile in
frame, Classic
design*

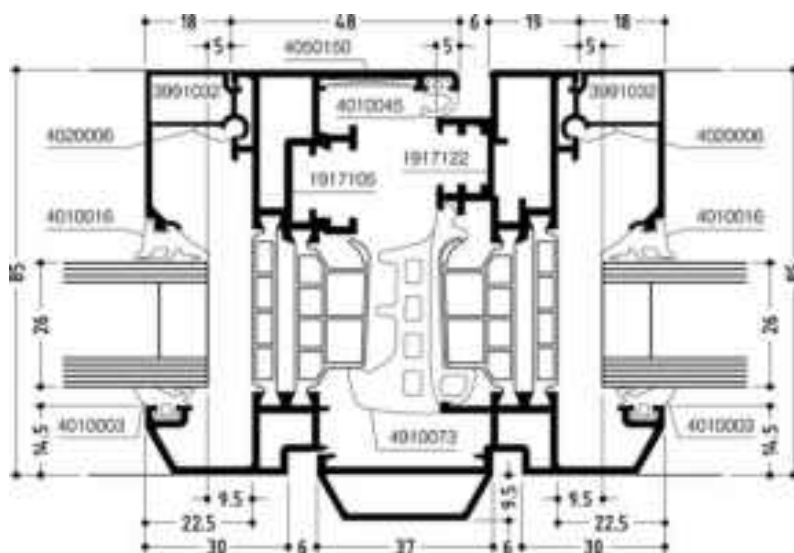

DOC-0000696690

Stulpfenster -
Mittelstoß, Klassik-
Design
*Double casement
window - Meeting
stiles, Classic
design*

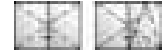
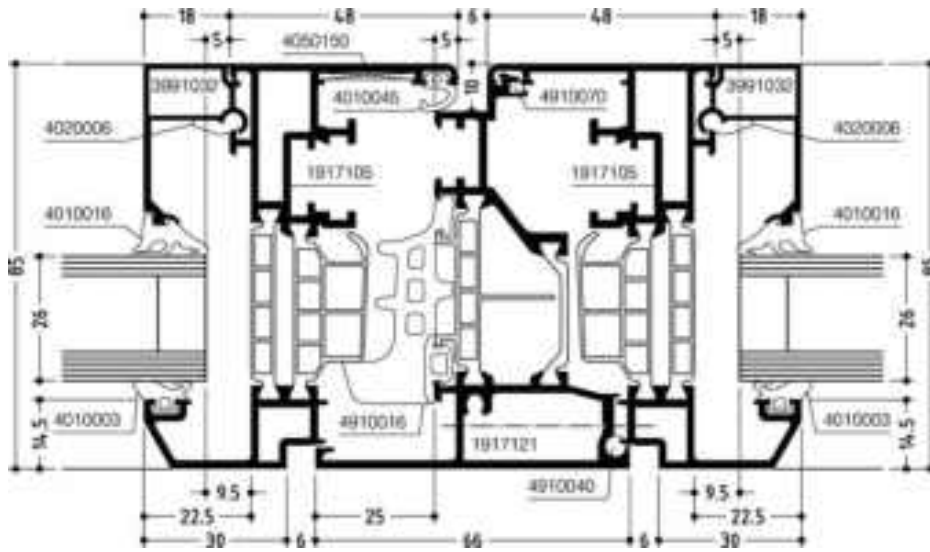

DOC-0000700360

Stulpfenster mit
Aufsatzprofil -
Mittelstoß, Klassik-
Design

*Double casement
window with
supplem. profile
- Meeting stiles,
Classic design*

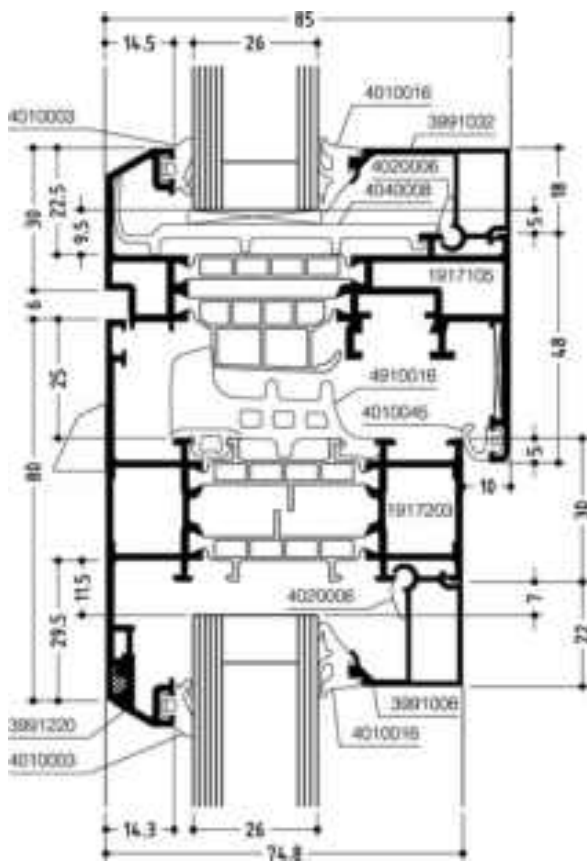

DOC-0000696818

Flügelprofil im
Blendrahmen mit
Kämpfer, Klassik-
Design

*Sash profile in
frame with transom,
Classic design*

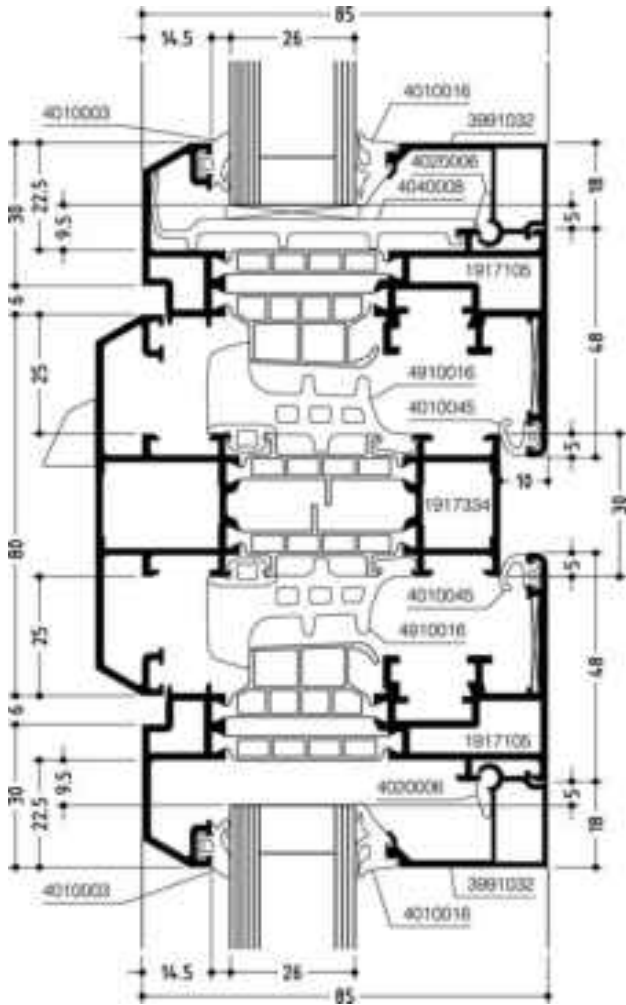

DOC-0000696946

Flügelprofil im
Blendrahmen mit
Kämpfer, Klassik-
Design

*Sash profile in
frame with transom,
Classic design*

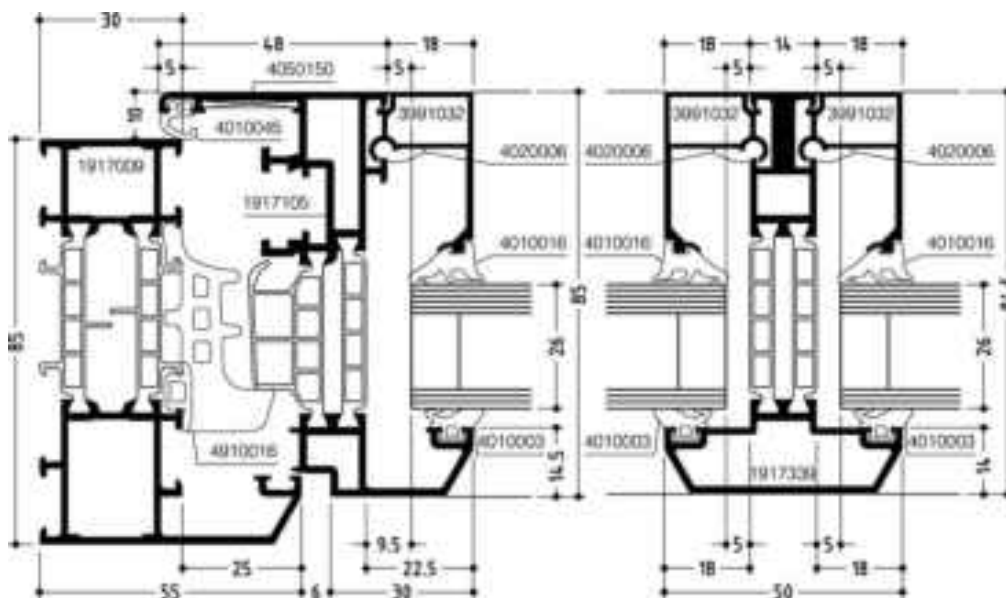

DOC-0000700441

Flügelprofil im
Blendrahmen mit
Sprossenprofil,
Klassik-Design

*Sash profile in
frame with glazing
bar profile, Classic
design*

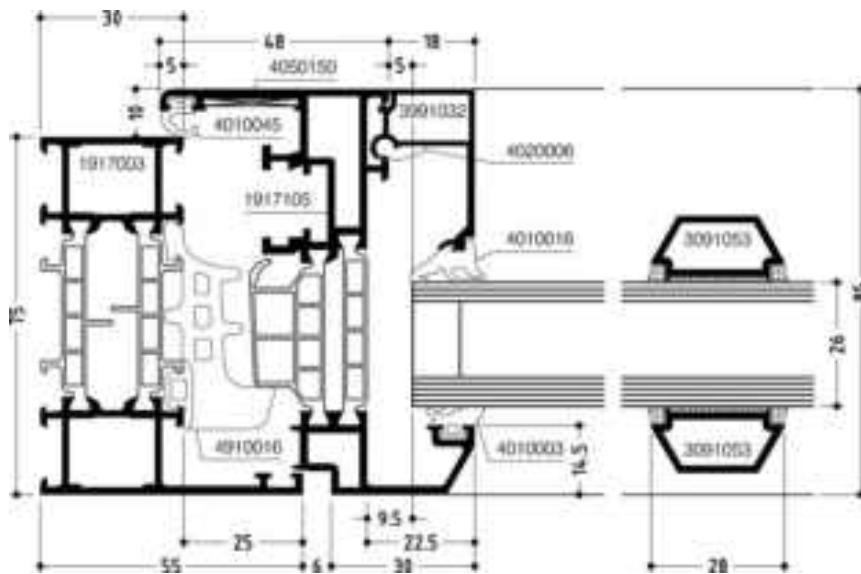

DOC-0000701480

Flügelprofil im
Blendrahmen mit
Ziersprossenprofil,
Klassik-Design

*Sash profile in
frame with glazing
bar profile, Classic
design*

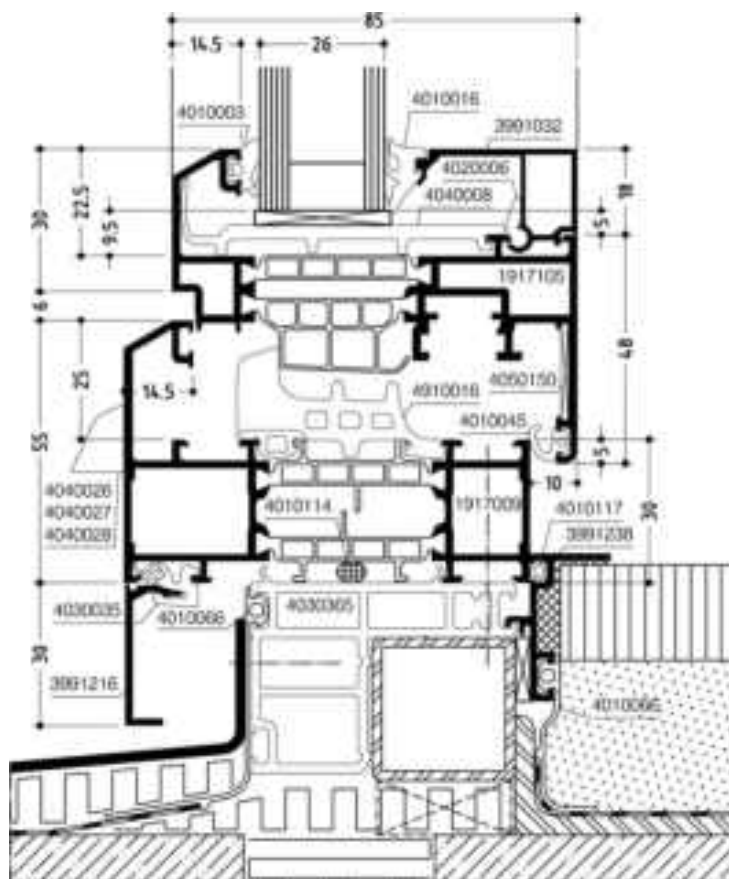

DOC-0000701564

Bauanschluss
unten mit Dämm-
auflage 4030365,
Klassik-Design

*Bottom junction
to structure with
insulation support
4030365, Classic
design*

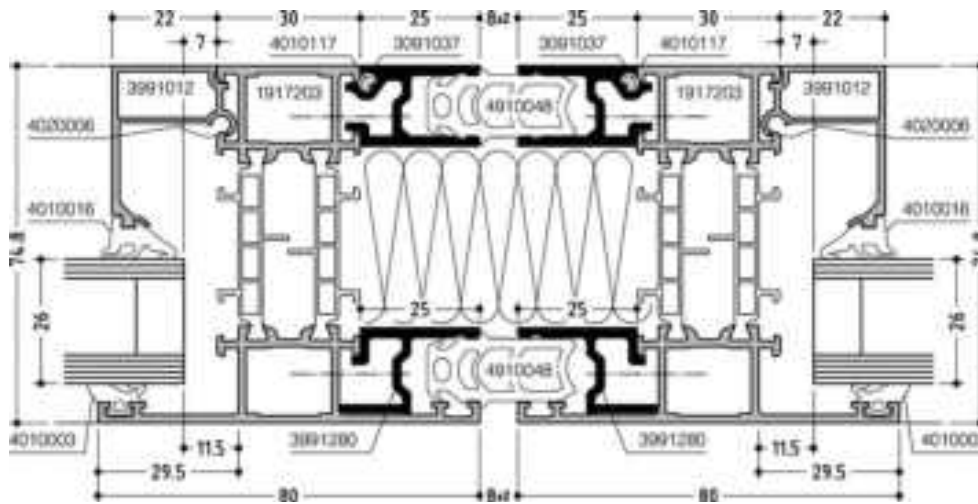

DOC-0000742608

Zusatzprofil
3091037 und
3991280

*Additional profile
3091037 and
3991280*

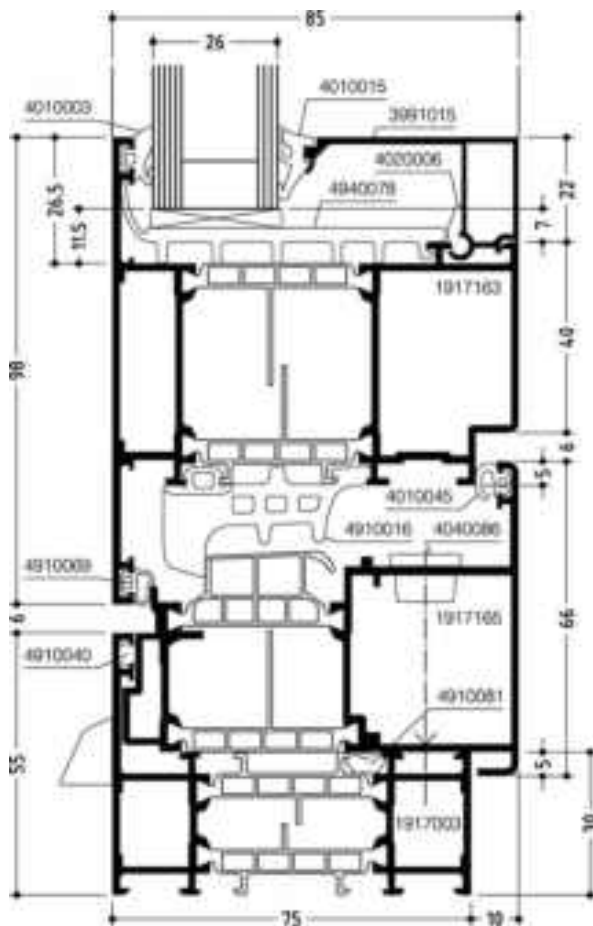

DOC-0000763110

Senk-Klappfenster
Italian style window

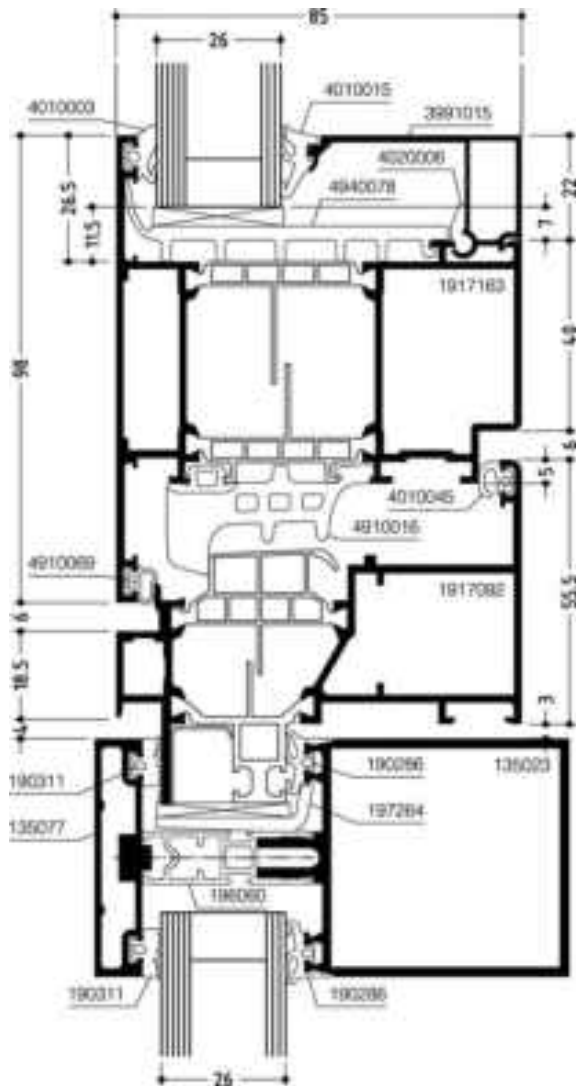

DOC-0000763261

Senk-Klappfenster
Italian style window

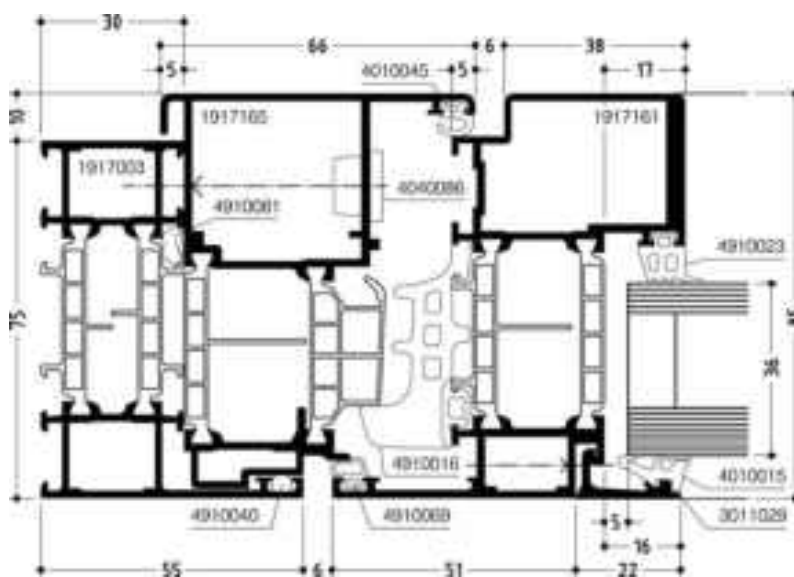

DOC-0000763301

Senk-Klappfenster
Italian style window

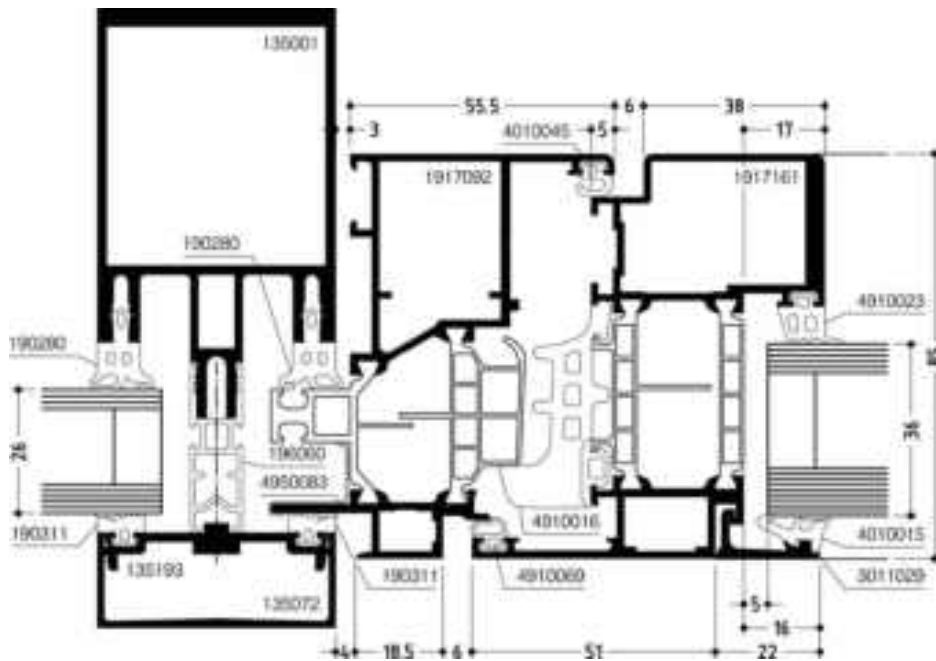

DOC-0000763325

Senk-Klappfenster
Italian style window

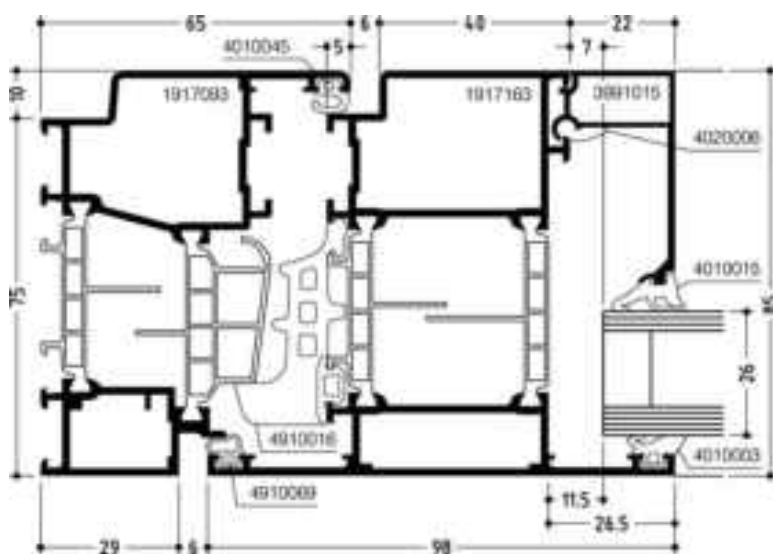

DOC-0000772062

Klappfenster
Top-hung window

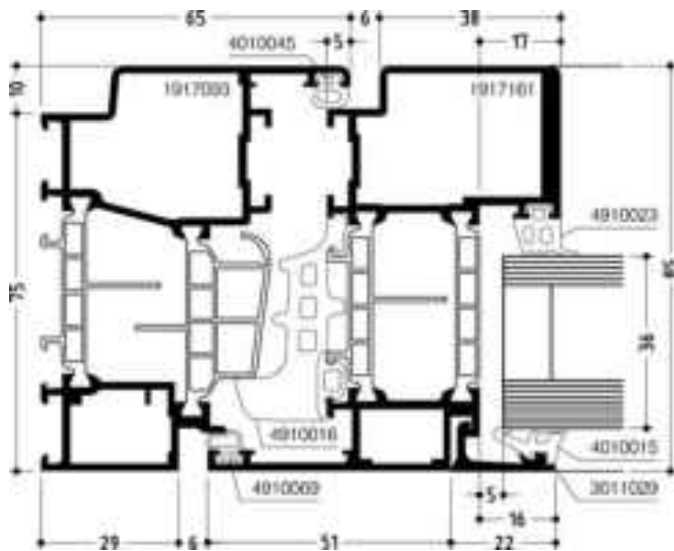

DOC-0000772181

Klappfenster
Top-hung window

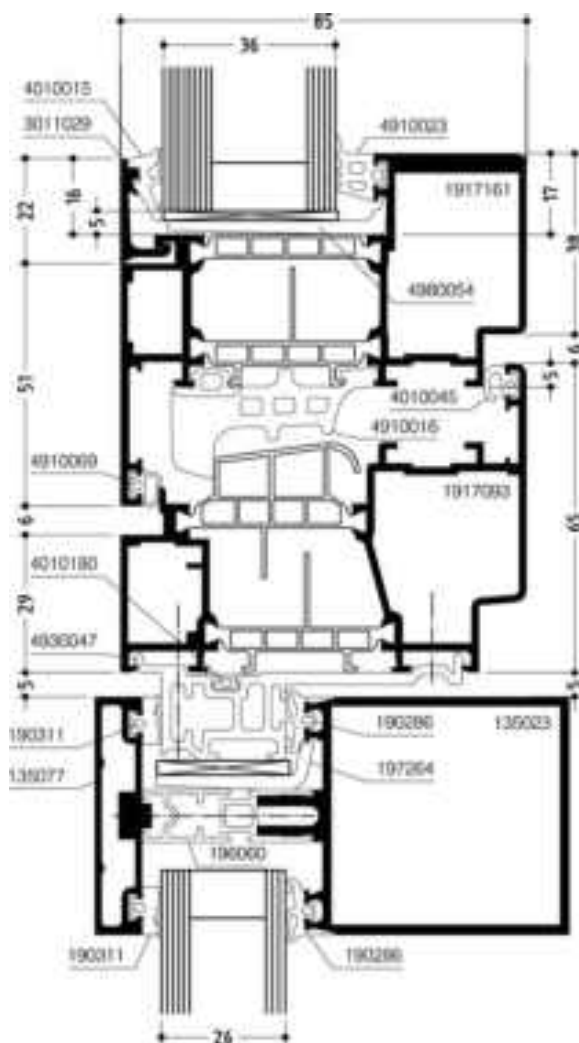

DOC-0000772204

Klappfenster
Top-hung window

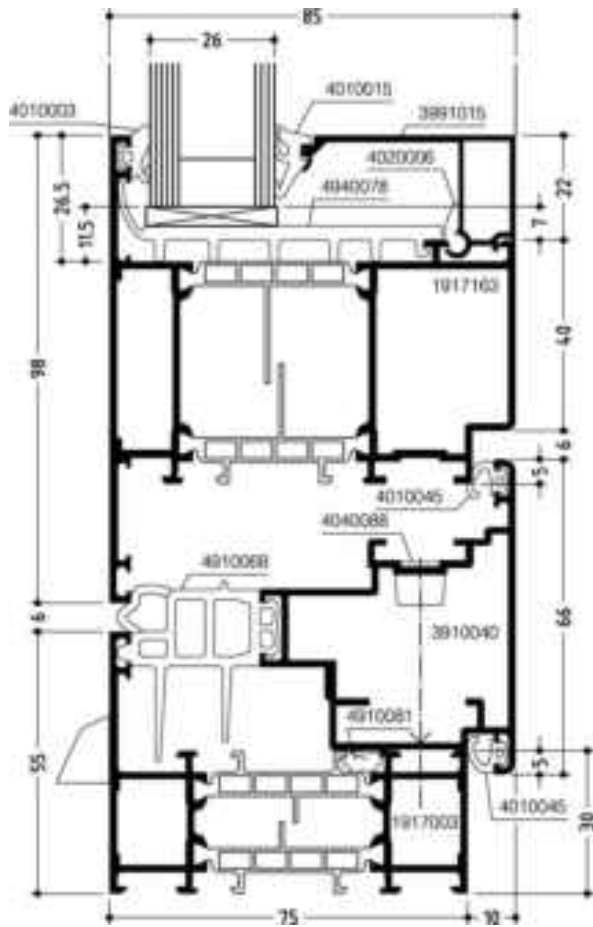

DOC-0000775087

Schwing-Wende-
Fenster
*Horizontal/vertical
pivot window*

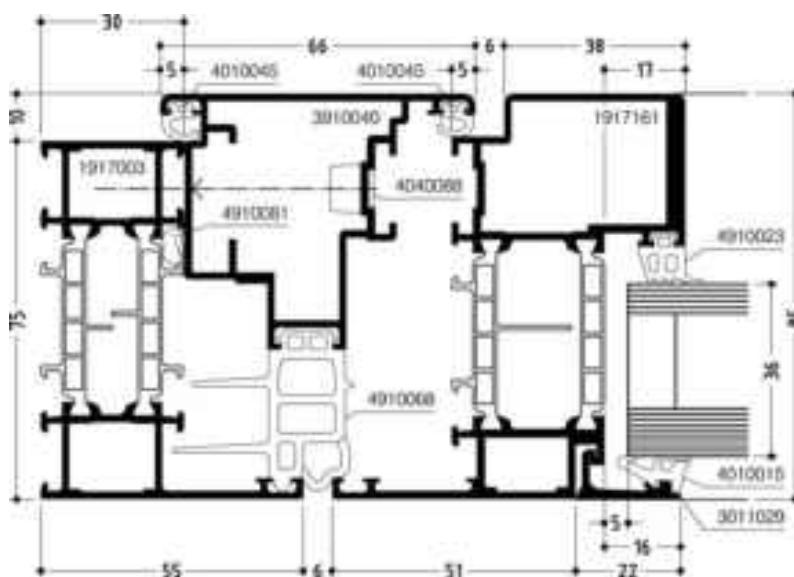

DOC-0000774972

Schwing-Wende-
Fenster
*Horizontal/vertical
pivot window*

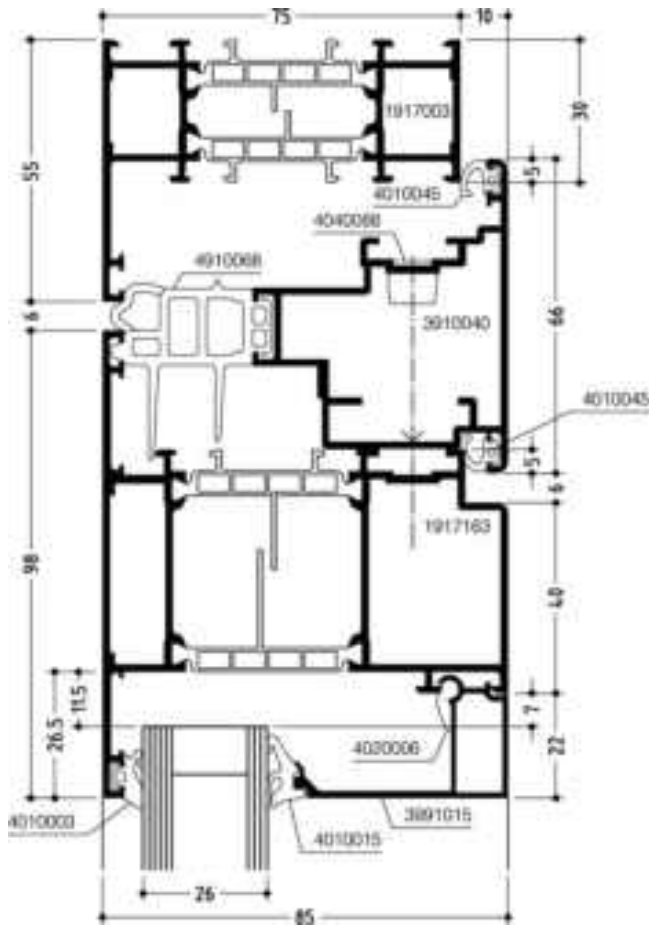

DOC-0000773587

Schwing-Wende-
Fenster
*Horizontal/vertical
pivot window*

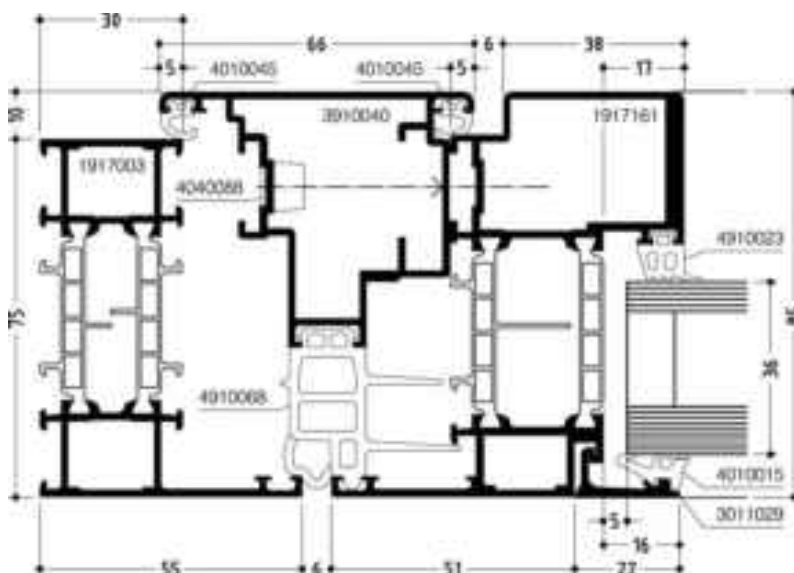

DOC-0000774975

Schwing-Wende-
Fenster
*Horizontal/vertical
pivot window*

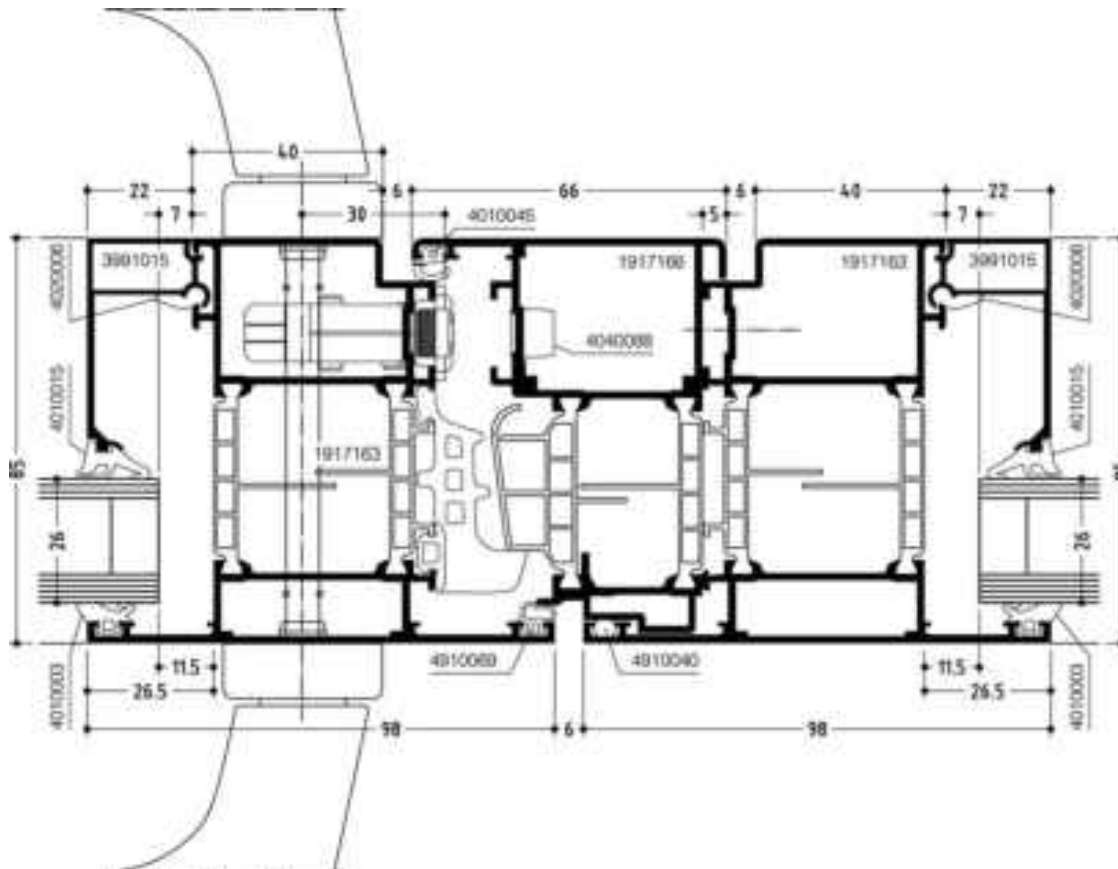

DOC-0000798600

Fenstertür mit
Aufsatzprofil,
auswärts - Mittel-
stoß

*Casement door
with supplementary
profile, outwards -
Meeting stiles*

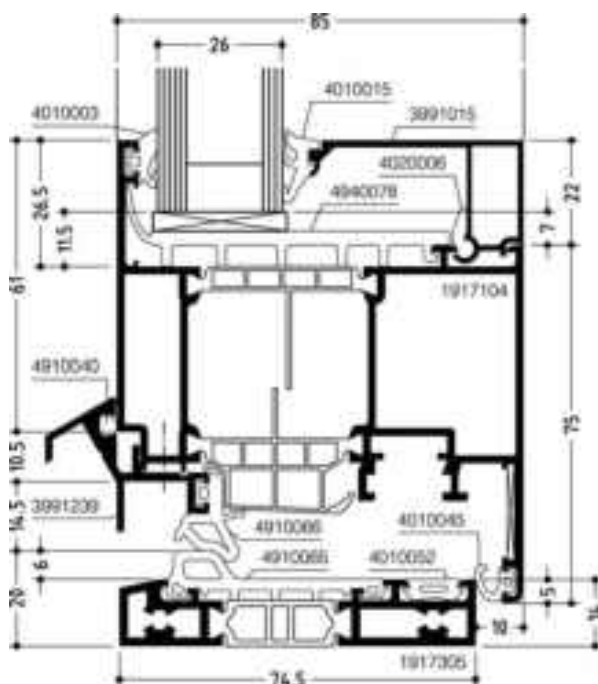

DOC-0000745858

Fenstertür mit
Schwellenprofil,
einwärts

*Casement door
with threshold
profile, inwards*

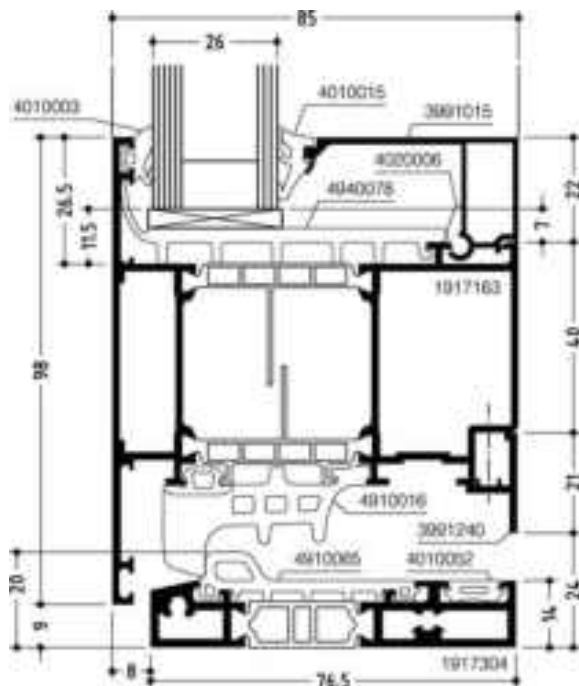

DOC-0000746259

Fenstertür mit
Schwellenprofil,
auswärts
*Casement door
with threshold
profile, outwards*

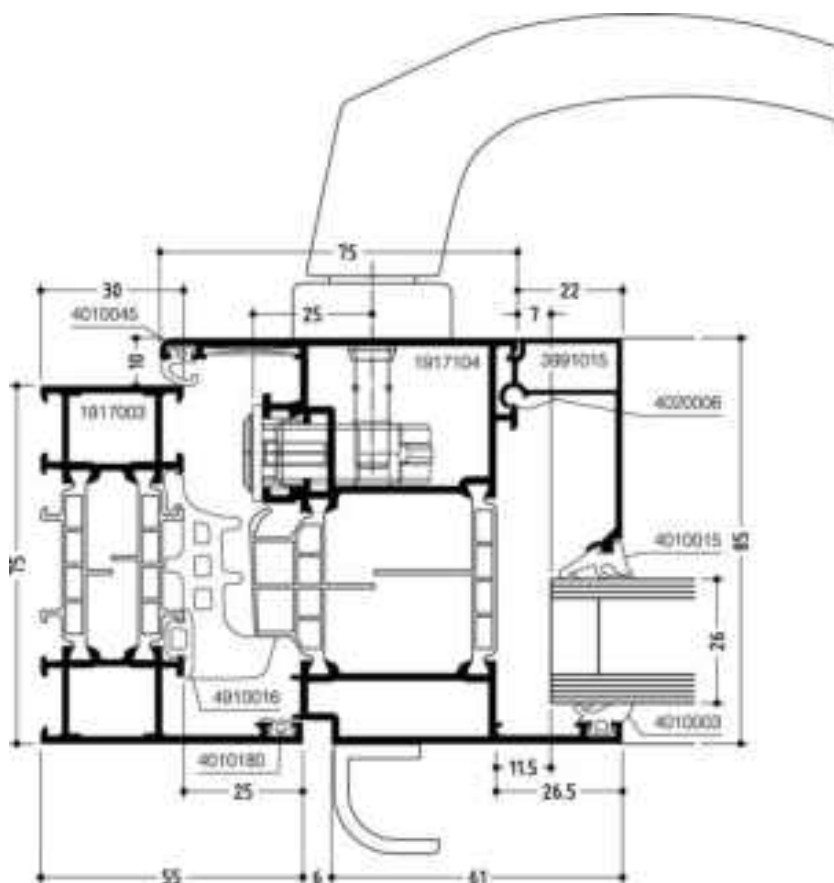

DOC-0000771923

Fenstertür, einwärts
*Casement door,
inwards*

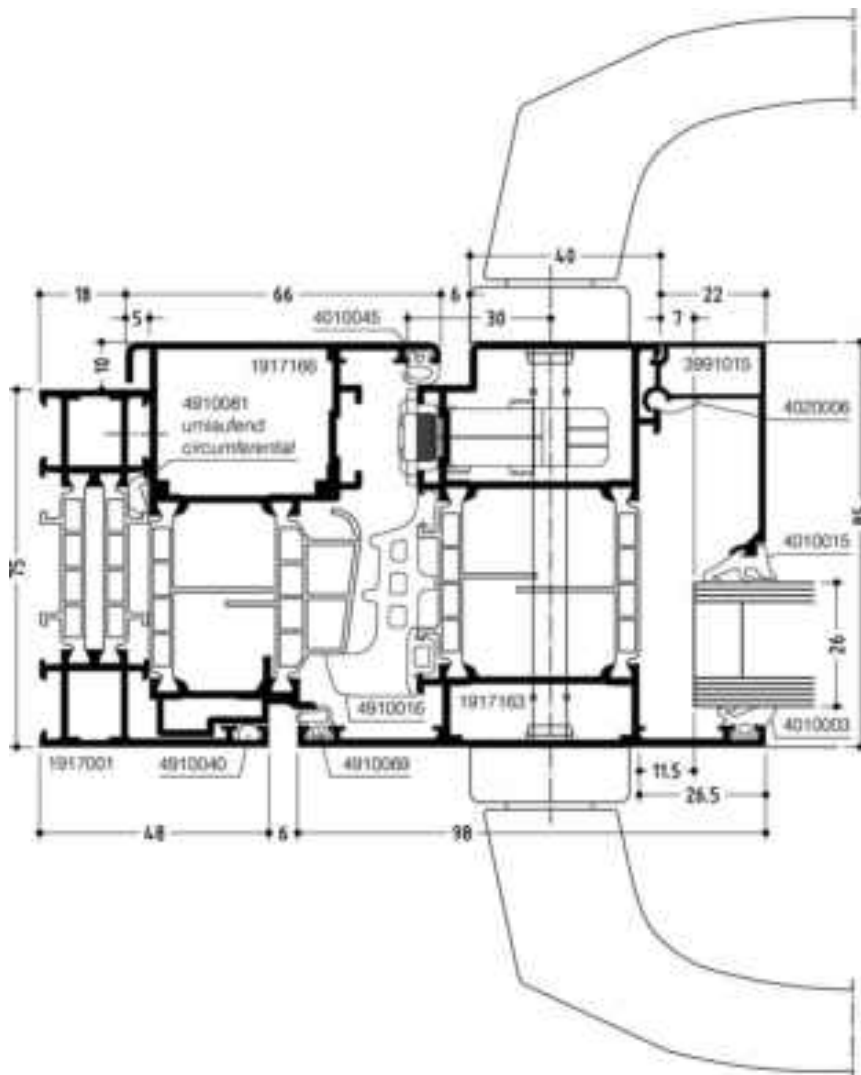

DOC-0000772015

Fenstertür mit
Aufsatzprofil,
auswärts
*Casement door
with supplementary
profile, outwards*

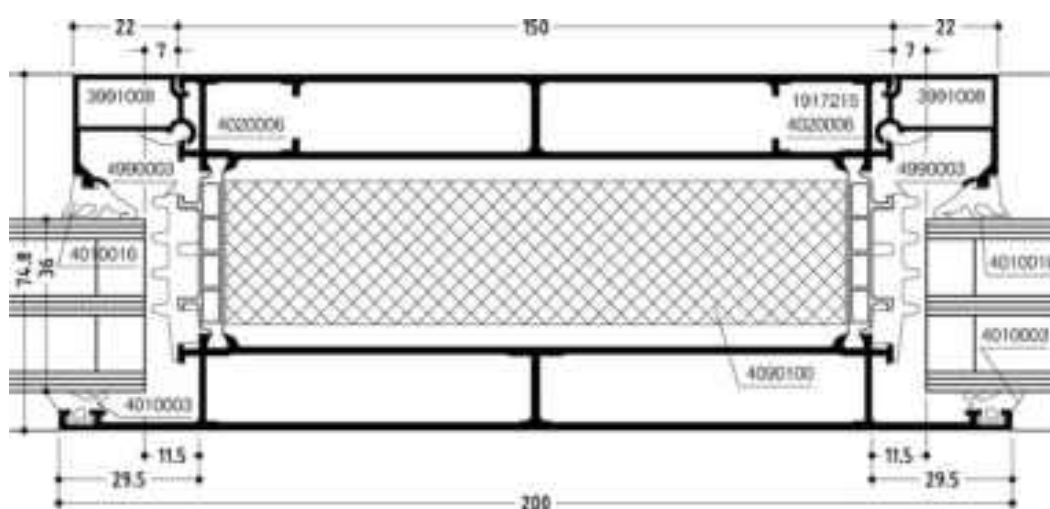

DOC-0000785934

Hochwärmedäm-
mend Kämpfer-
profil mit Fest-
verglasung und
Spezial-Dämmprofil
*High insulated
Transom profile
with fixed glazing
and special
insulation profile*

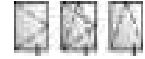
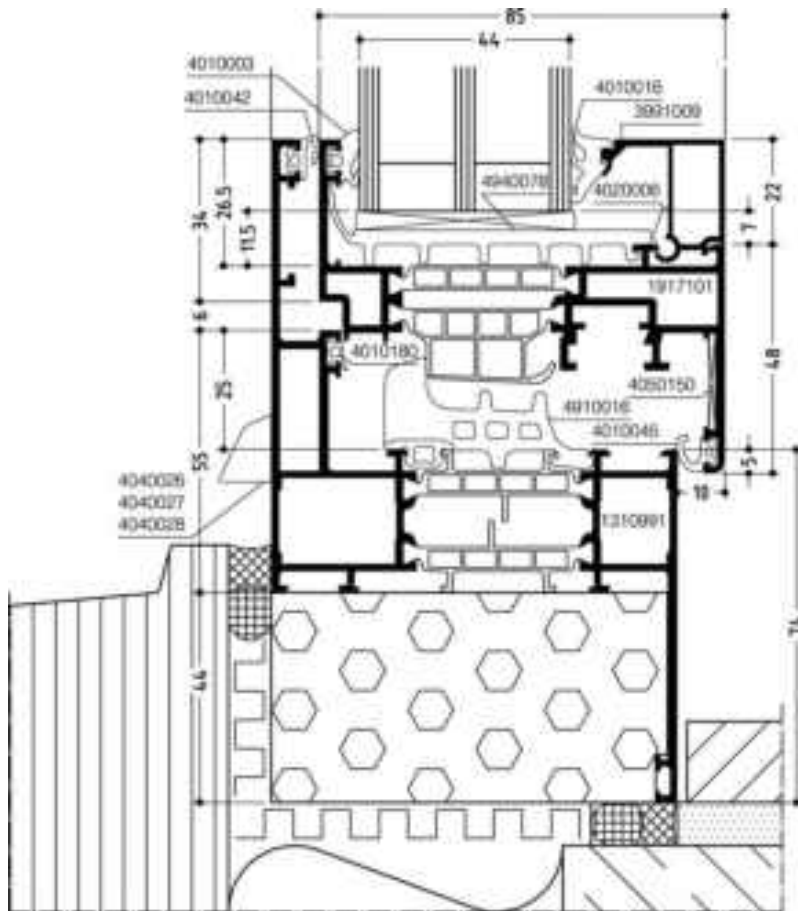

DOC-0000806452

MINERGIE-P®
Flügelprofil im
Spezialblendrah-
men

MINERGIE-P®
Sash profile in
special frame
profile

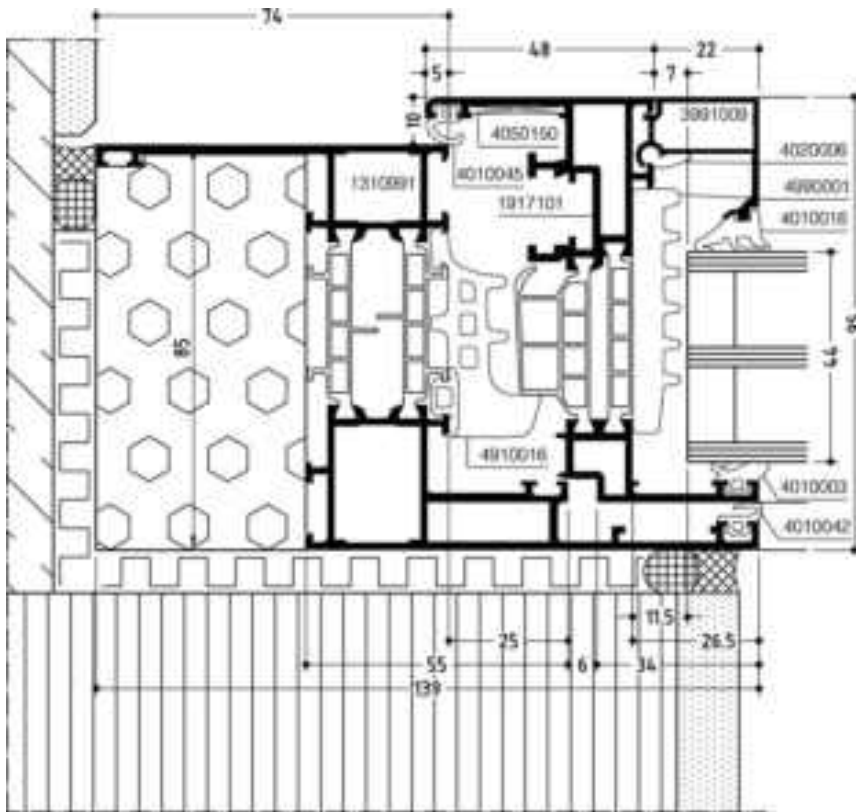

DOC-0000808441

MINERGIE-P®
Flügelprofil im
Spezialblendrah-
men
*MINERGIE-P® sash
profile in special
frame profile*

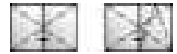
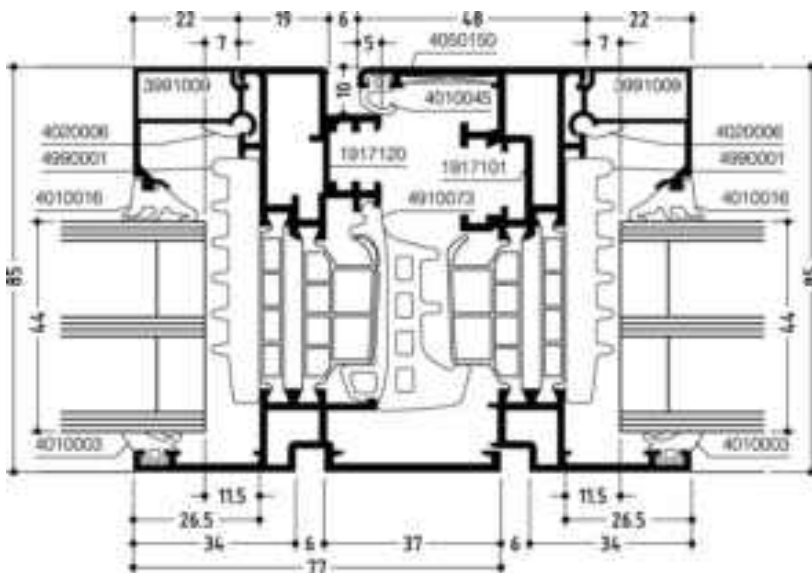

DOC-0000802492

MINERGIE-P®
Stulpfenster -
Mittelstoß
*MINERGIE-P®
Double casement
window - Meeting
stiles*

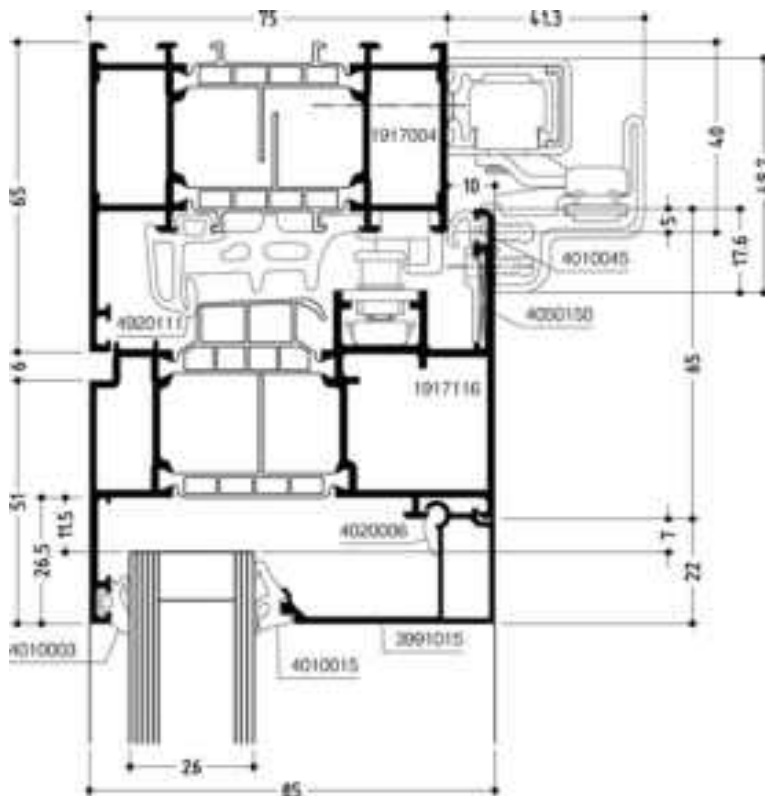

DOC-0000823992

Parallel-Schiebe-
Kipp-Fenster (ohne
Zwangssteuerung)

*Parallel sliding tilt
window (without
force operation)*

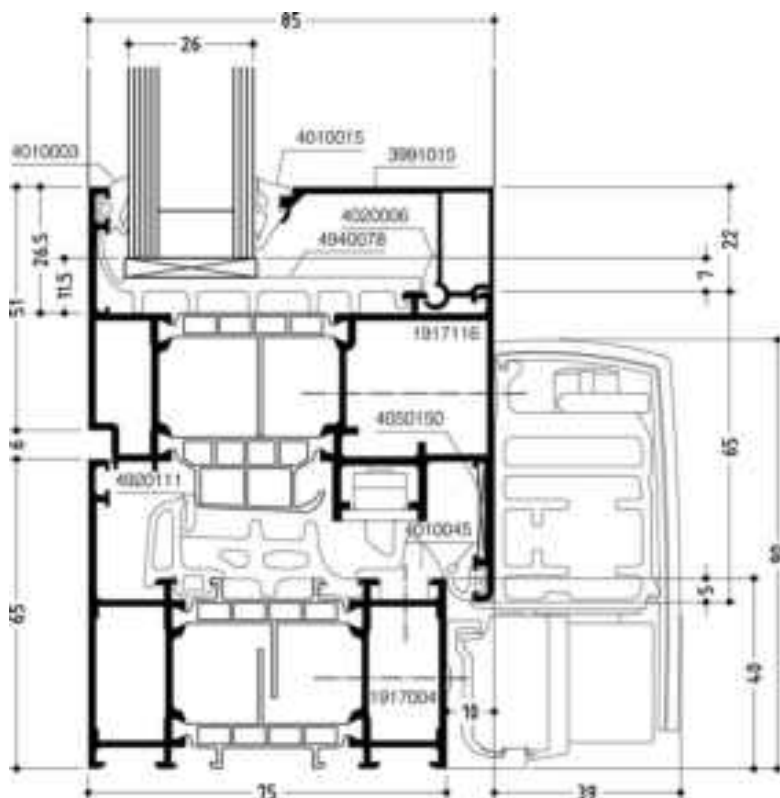

DOC-0000824010

Parallel-Schiebe-
Kipp-Fenster (ohne
Zwangssteuerung)

*Parallel sliding tilt
window (without
force operation)*

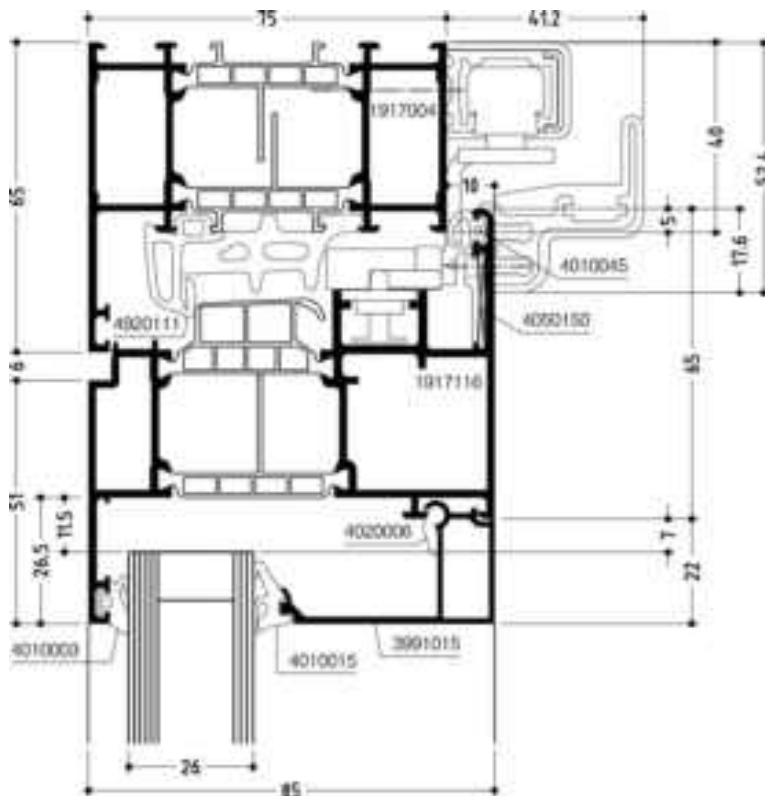

DOC-0000824114

Parallel-Schiebe-
Kipp-Fenster (mit
Zwangssteuerung)
*Parallel sliding tilt
window (with force
operation)*

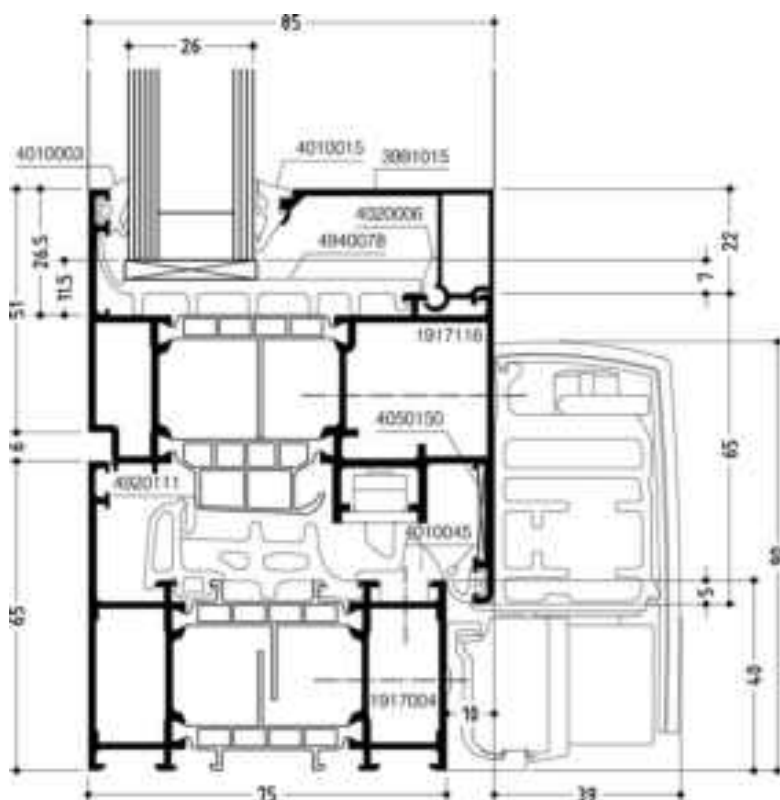

DOC-0000824135

Parallel-Schiebe-
Kipp-Fenster (mit
Zwangssteuerung)
*Parallel sliding tilt
window (with force
operation)*

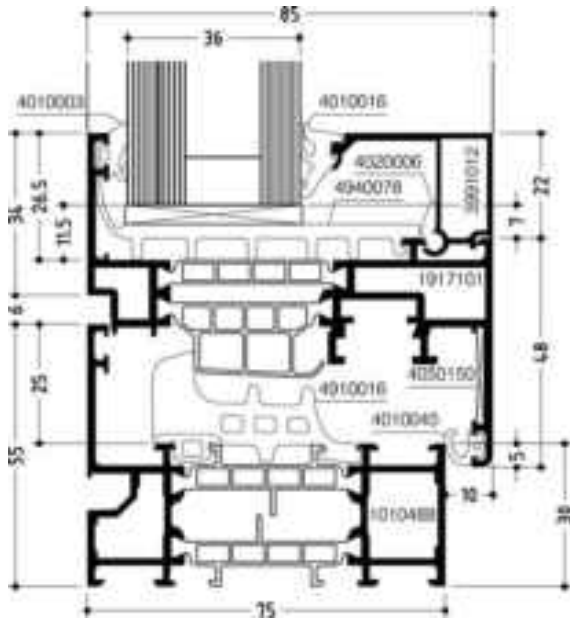

DOC-0001015373

Verdeckte Entwässerung mit Spezial-Dämmprofil
Concealed drainage with special insulation profile

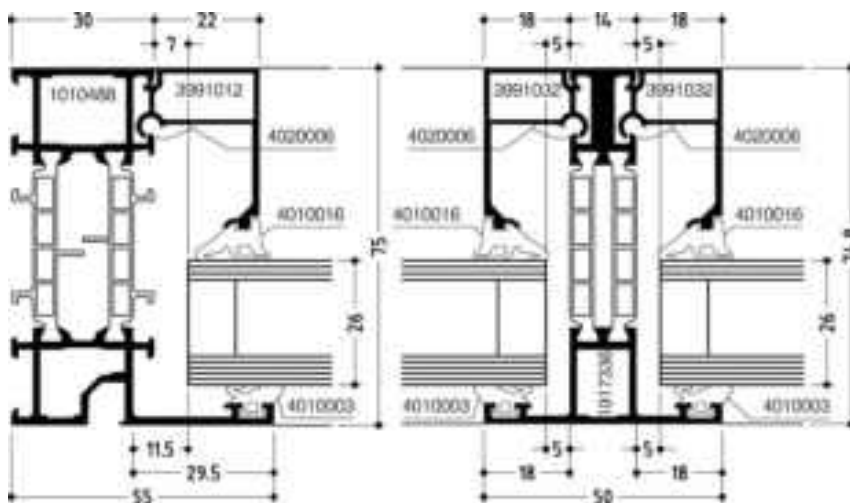

DOC-0001010671

Verdeckte Entwässerung, Festverglasung mit Sprossenprofil
Concealed drainage, fixed glazing with glazing bar profile

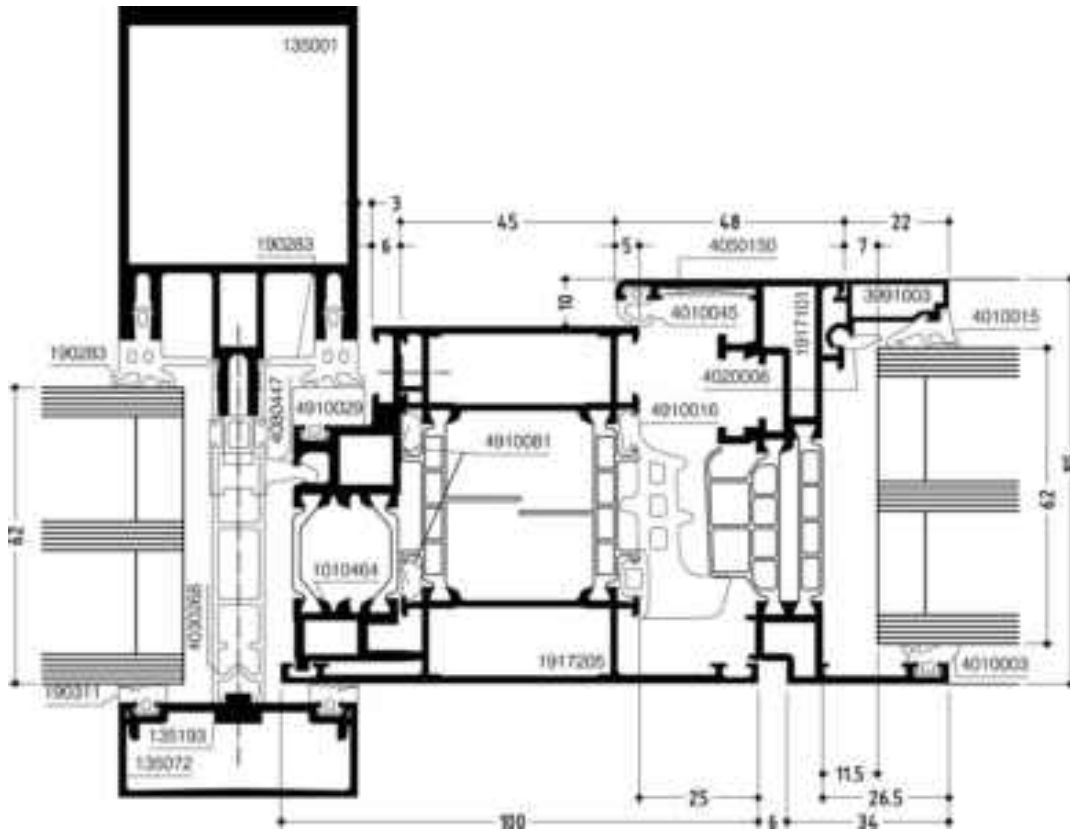

DOC-0001010290

Kämpfer mit
Einspannaufsatz
und Befestigungs-
teil

*Transom with
supplementary
clamping profile
and fixing part*

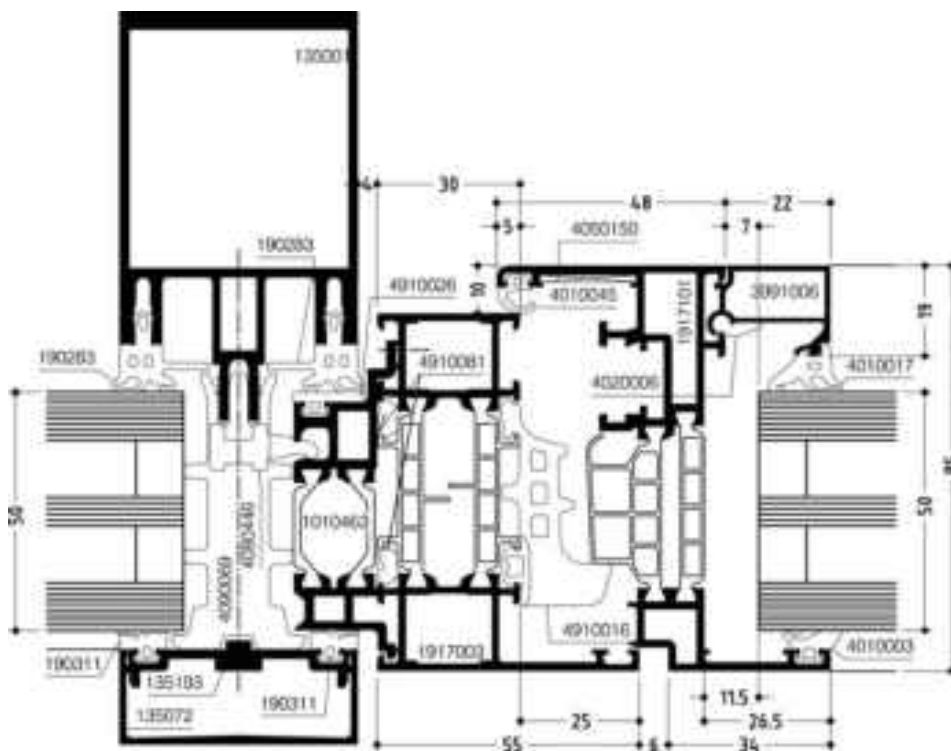

DOC-0001011337

Blendrahmen mit
Einspannaufsatz
und Befestigungs-
teil

*Frame with
supplementary
clamping profile
and fixing part*

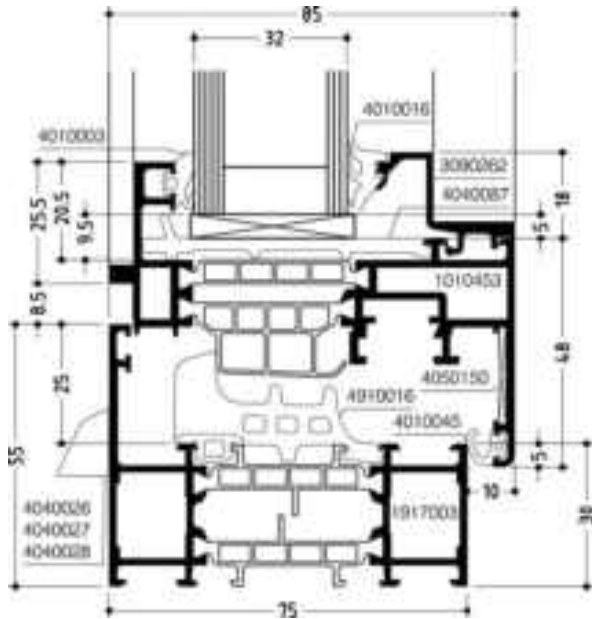

DOC-0001010960

Flügelprofil im
Blendrahmen
*Sash profile in
frame*

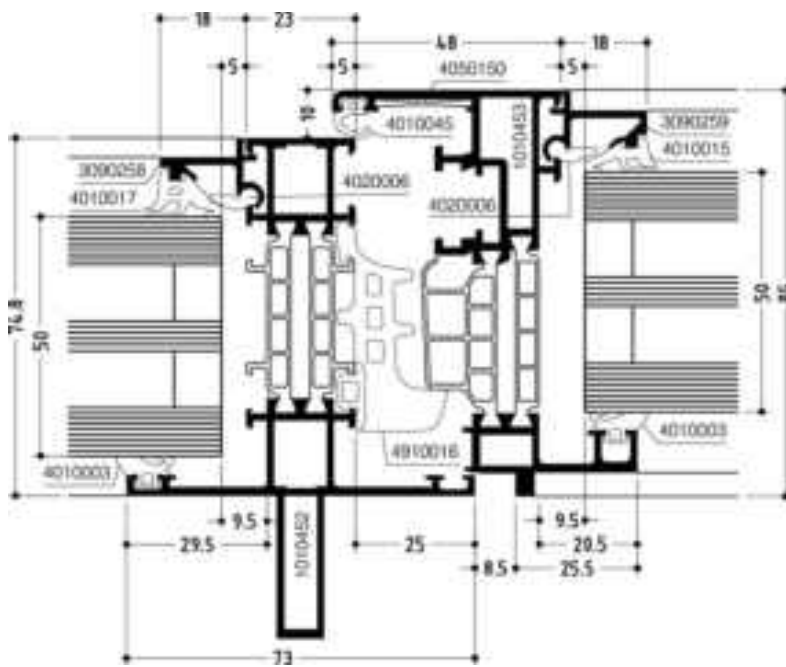

DOC-0001010972

Flügelprofil im
Blendrahmen mit
Kämpfer
*Sash profile in
frame with transom*

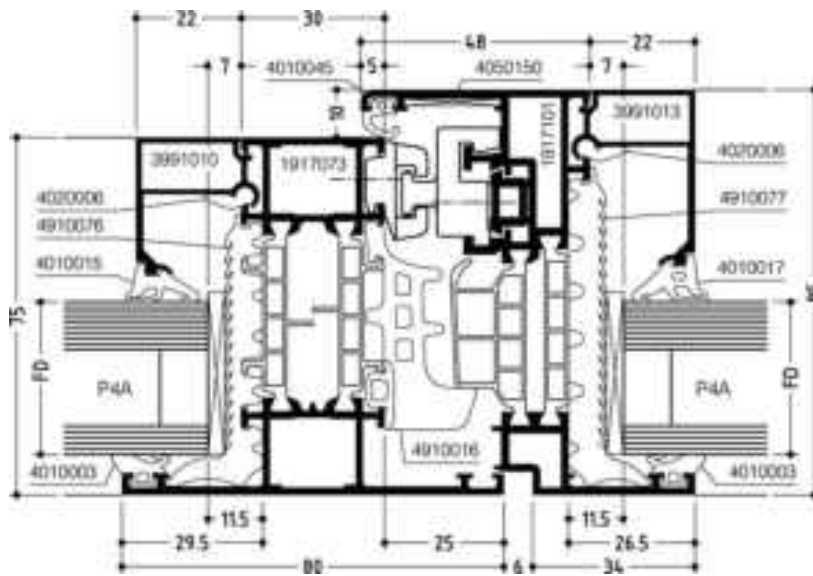

DOC-0000779978

Flügelprofil im
Blendrahmen mit
Kämpfer, EH-Verriegelung / Füllungs-
sicherung

*Sash profile in
frame with transom,
burglar resistant
locking / Infill
safeguard*

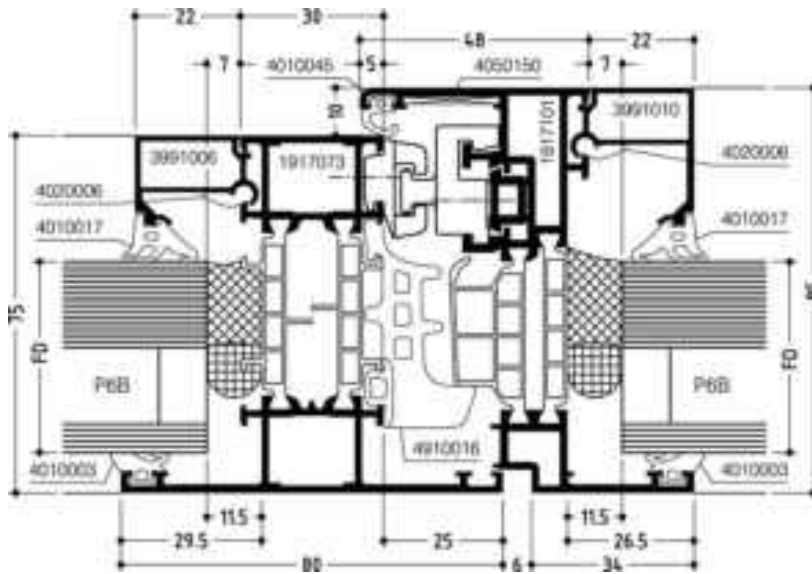

DOC-0000780007

Flügelprofil in
Blendrahmen mit
Kämpfer, EH-Verriegelung / Füllungs-
sicherung

*Sash profile in
frame with transom,
burglar resistant
locking / Infill
safeguard*

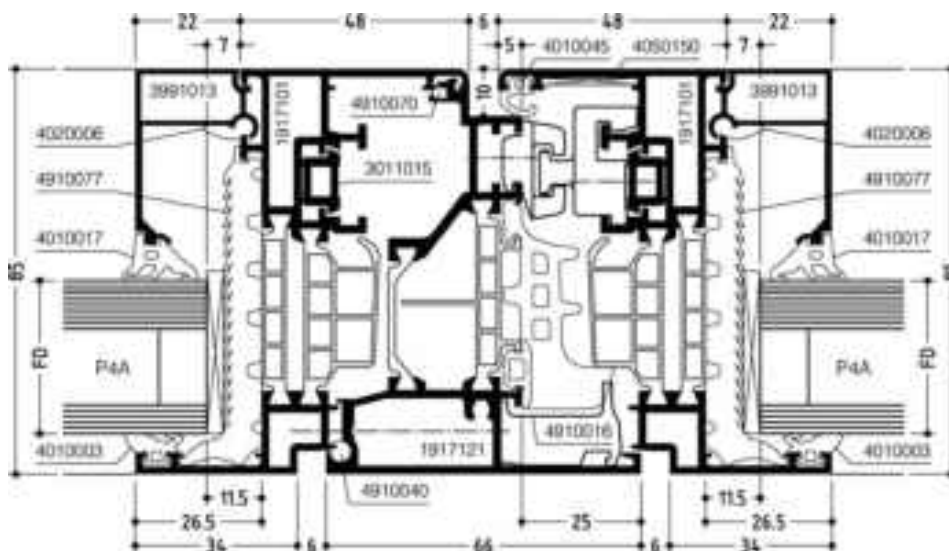

DOC-0000780019

Stulpfenster
mit Aufsatzpro-
fil - Mittelstoß,
EH-Verriegelung /
Infill safeguard

*Double casement
window with
supplem. profile
- Meeting stiles,
burglar resistant /
Infill safeguard*

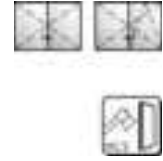
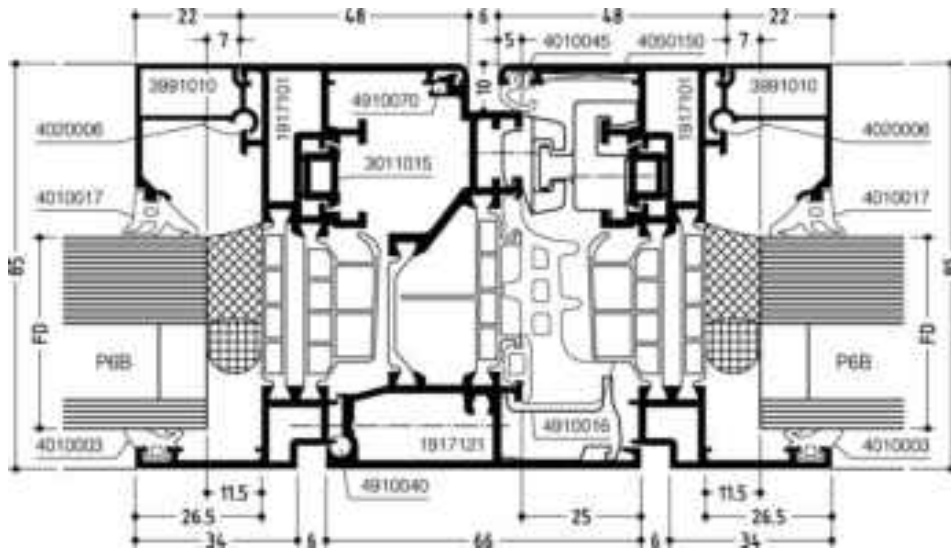

DOC-0000780038

Stulpfenster
mit Aufsatzprofil - Mittelstoß,
EH-Verriegelung /
Füllungssicherung

*Double casement
window with
supplem. profile
- Meeting stiles,
burglar resistant
locking / Infill
safeguard*

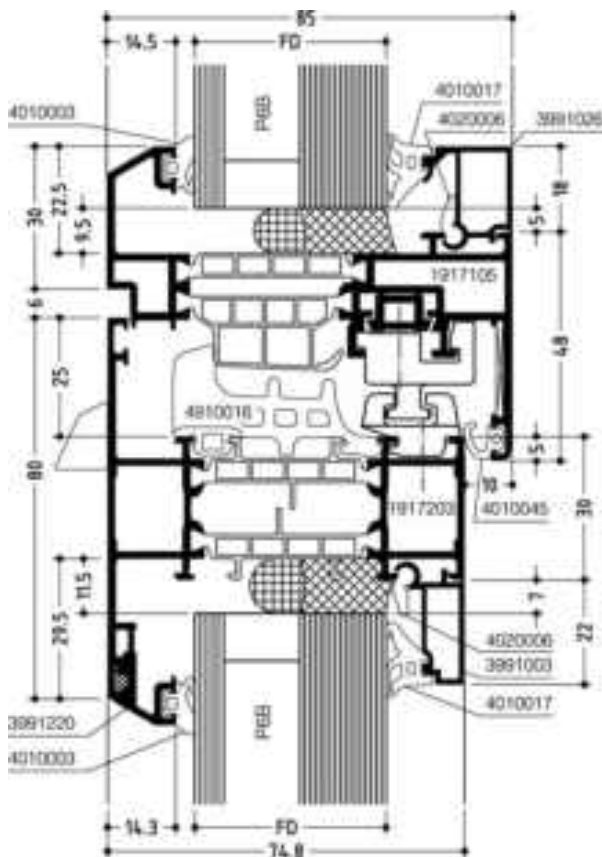

DOC-0000780062

Flügelprofil im
Blendrahmen mit
Kämpfer, Klassik-
Design, EH-Verriegelung /
Füllungssicherung

*Sash profile in
frame with transom,
Classic design,
burglar resistant
locking / Infill
safeguard*

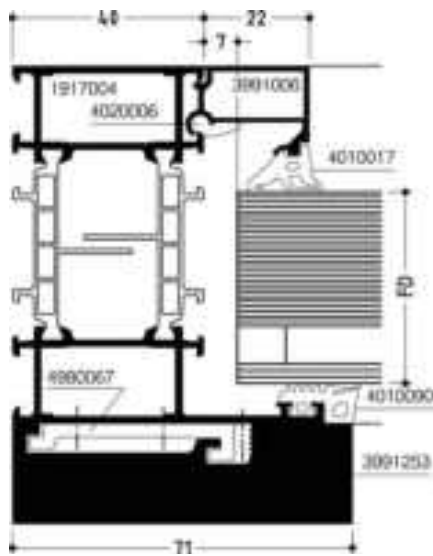

DOC-0000780252

Blendrahmen, Fest-
verglasung
*Frame profile, Fixed
glazing*

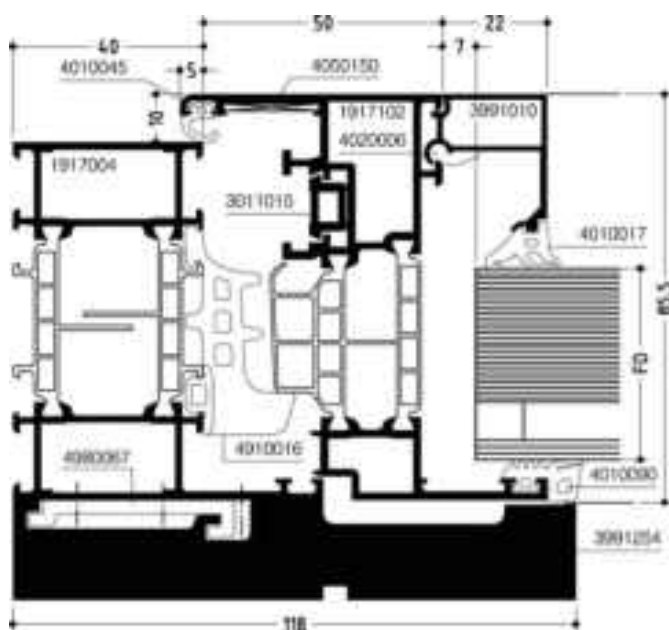

DOC-0000780257

Blendrahmen,
Fensterflügel
*Frame, Window
sash*

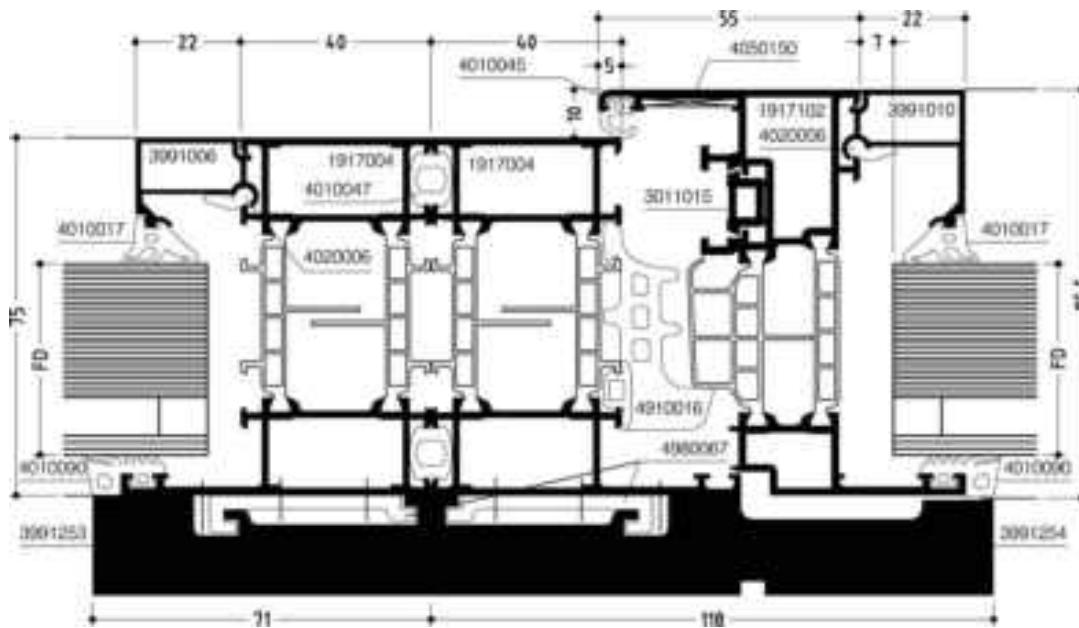

DOC-0000780279

Flügelprofil im
Blendrahmen,
Fensterflügel /
Elementkopplung
*Sash profile in
frame, Window
sash / unit coupling*

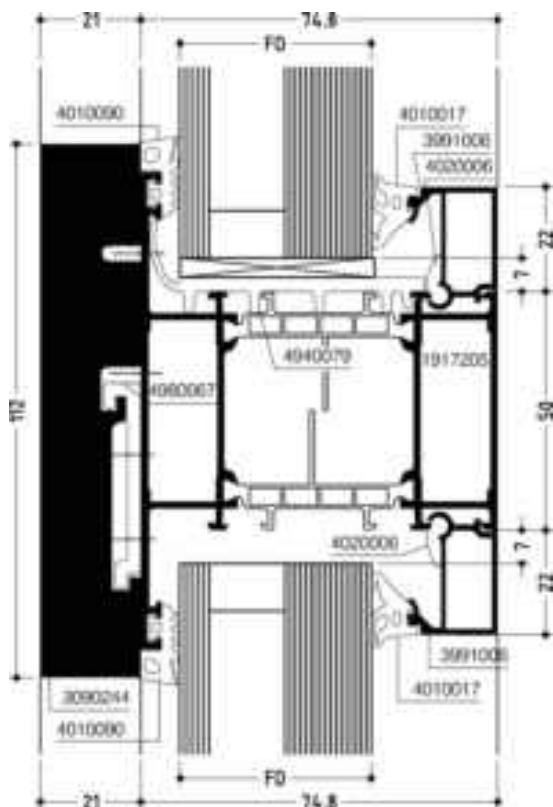

DOC-0000798034

Kämpferprofil, Fest-
verglasung
*Transom profile,
Fixed glazing*

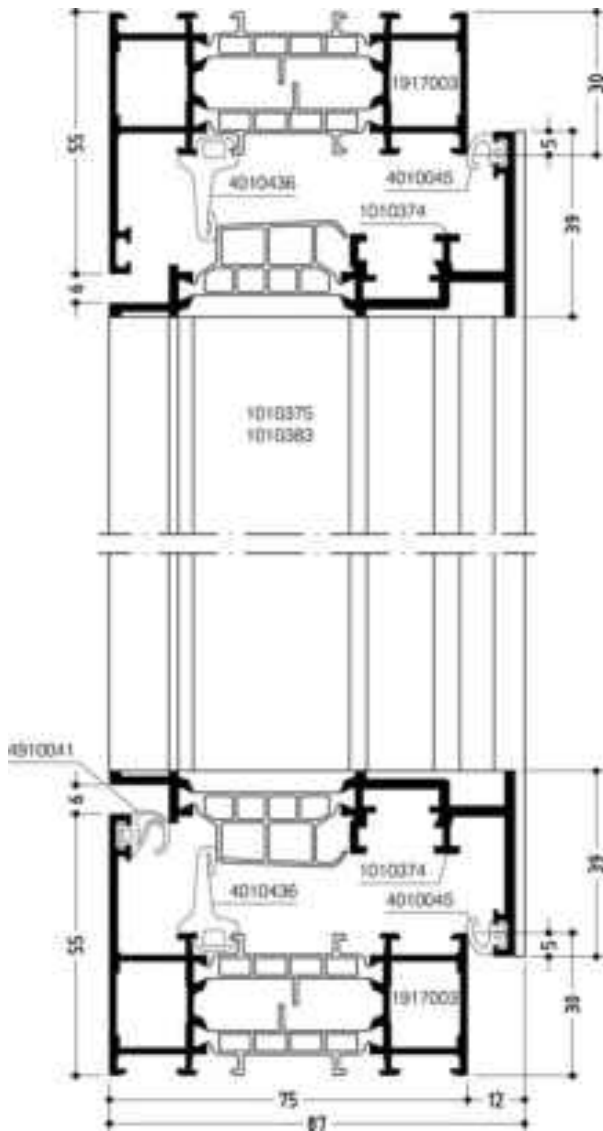

DOC-0000906681

Lüftungsklappe im
Blendrahmen
*Ventilation flap in
frame*

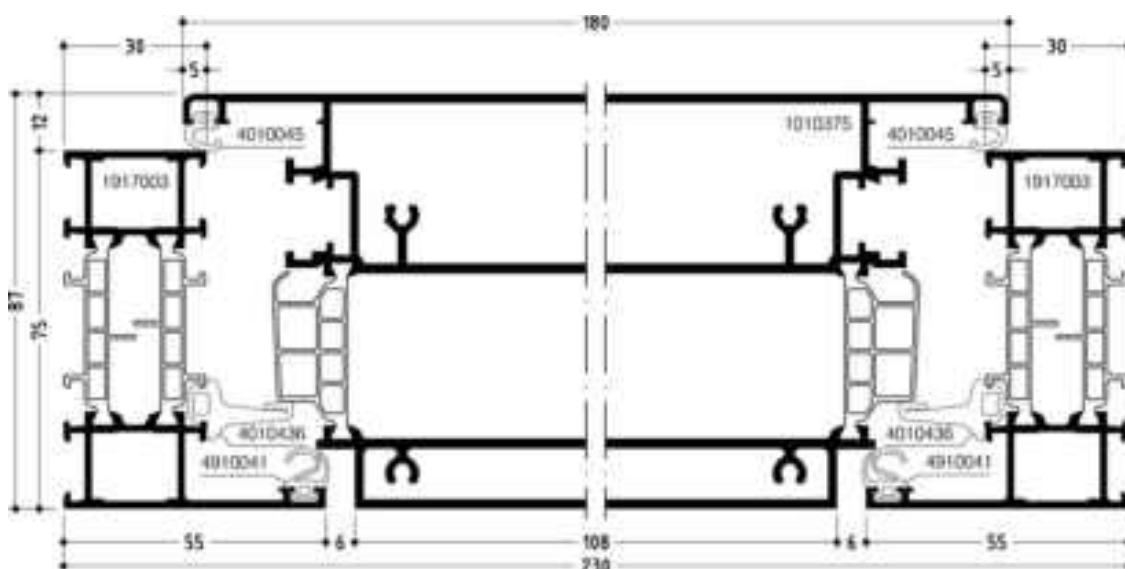

DOC-0000906854

Lüftungsklappe
im Blendrahmen,
Flügel 180 mm
*Ventilation flap in
frame, sash 180
mm*

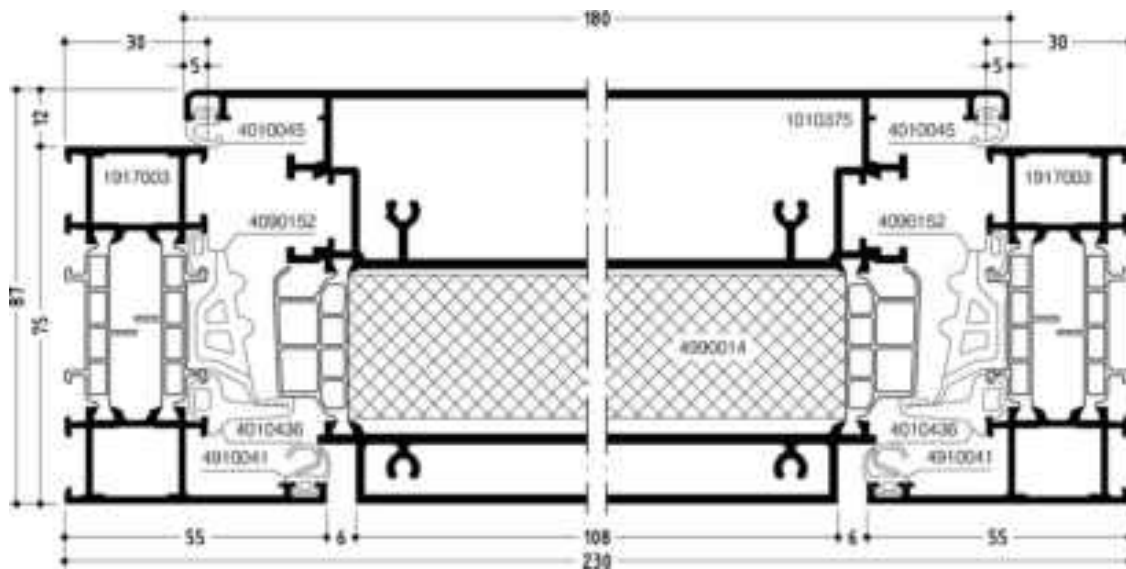

DOC-0000906869

Lüftungsklappe
hochwärmedäm-
mend, Flügel 180
mm

*Ventilation flap high
insulated, sash 180
mm*

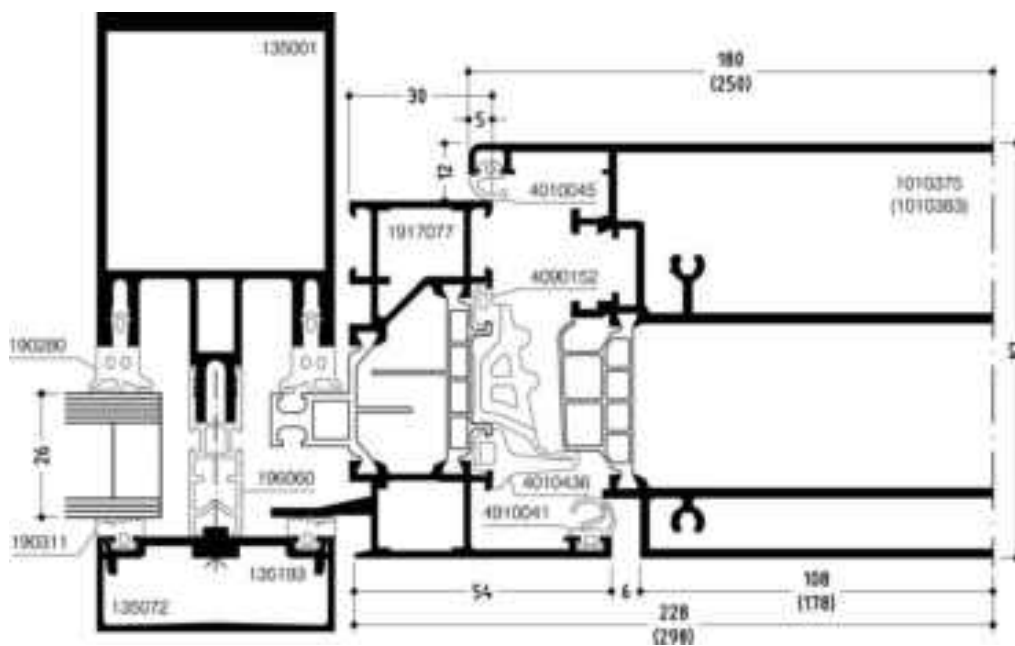

DOC-0000906874

Lüftungsklappe
WICLINE 75, 180
mm / 250 mm im
Einspannblendrah-
men

*Ventilation flap
WICLINE 75, 180
mm / 250 mm in
clamping frame*

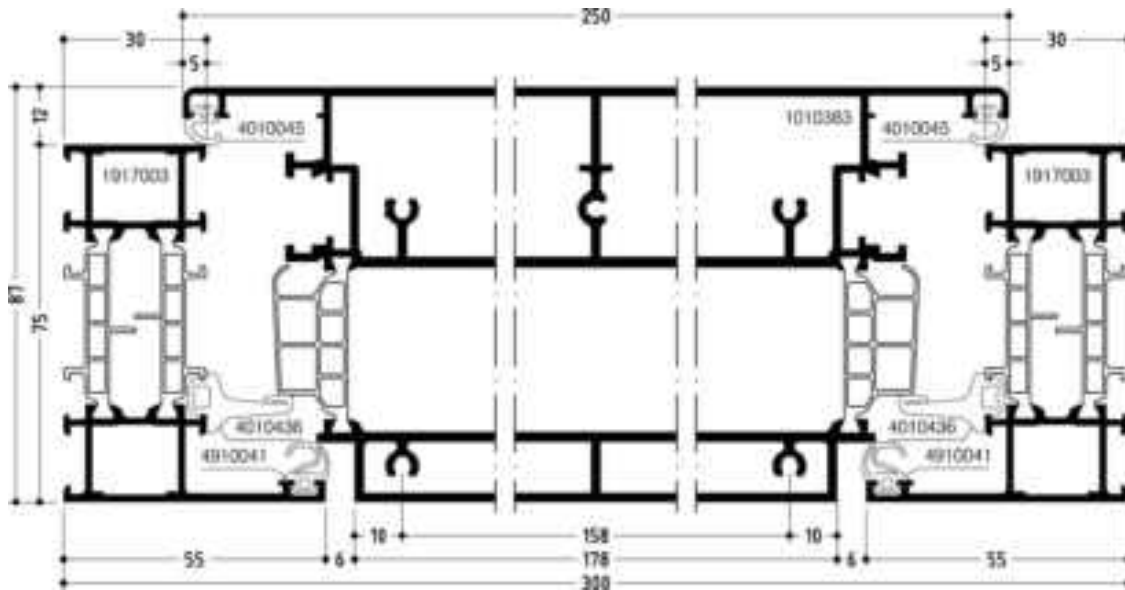

DOC-0000906909

Lüftungsklappe
im Blendrahmen,
Flügel 250 mm
*Ventilation flap in
frame, sash 250
mm*

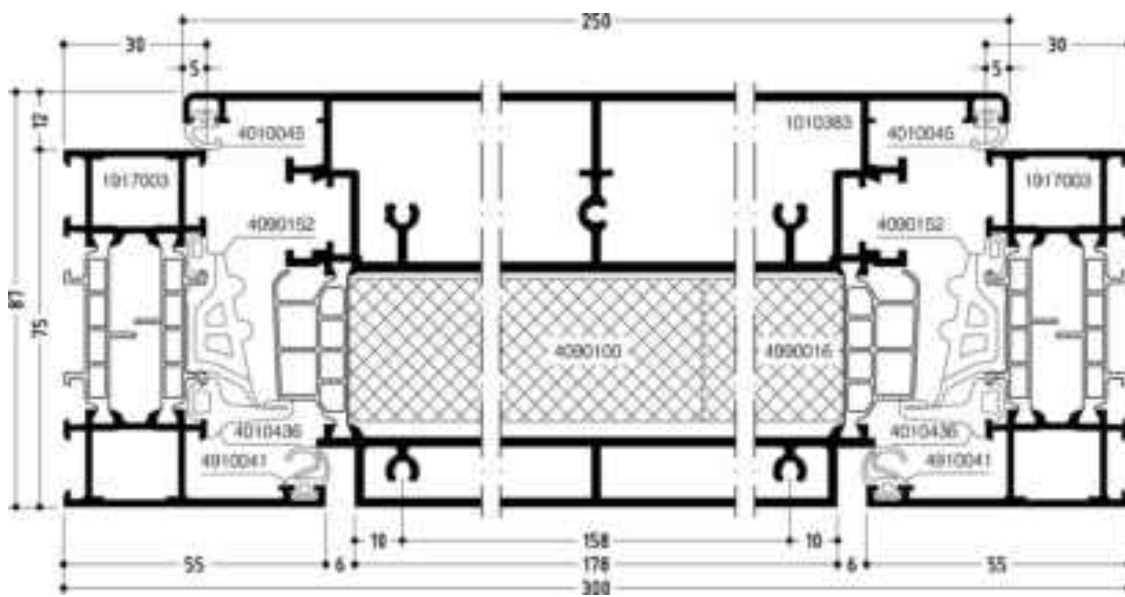

DOC-0000906962

Lüftungsklappe
hochwärmedäm-
mend, Flügel 250
mm
*Ventilation flap high
insulated, sash 250
mm*

Verdeckter Flügel

Concealed sash

Profile















Profiles

3/148

Anwendungsbeispiele

Examples of application

3/164

	 m	 mm	 mm										
 1917081	6,5	336	104	4950008	2x4070000	1x4960020	1x4070000	1x4070030	5910006	5940101	5940001	5930003	
 1010434	6,5	354	97	4950008	2x4070000	1x4960020	1x4070000	1x4070030	5910006	5940101	5940001	5930003	
				4050571	2x4070000	-	-	-	5910006	-	5940001	5930003	
				4950008	2x4070000	-	-	-	5910006	5940101	5940001	5930003	

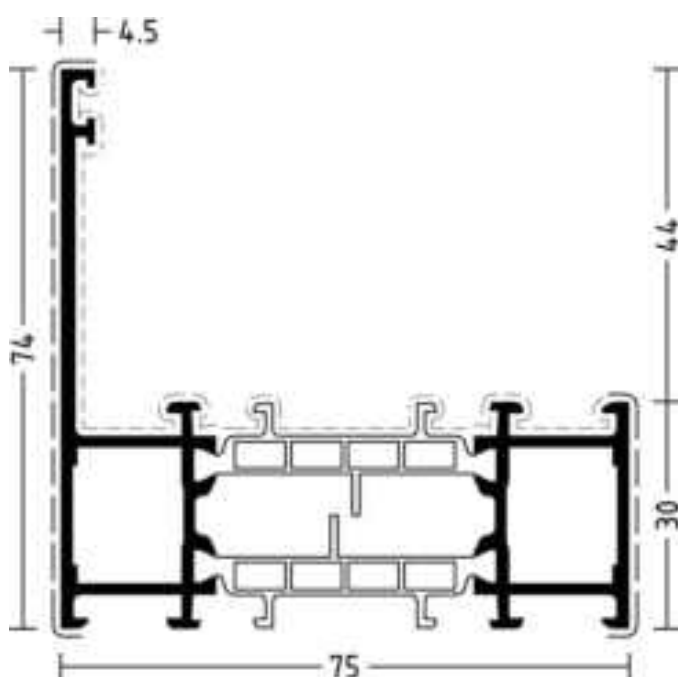





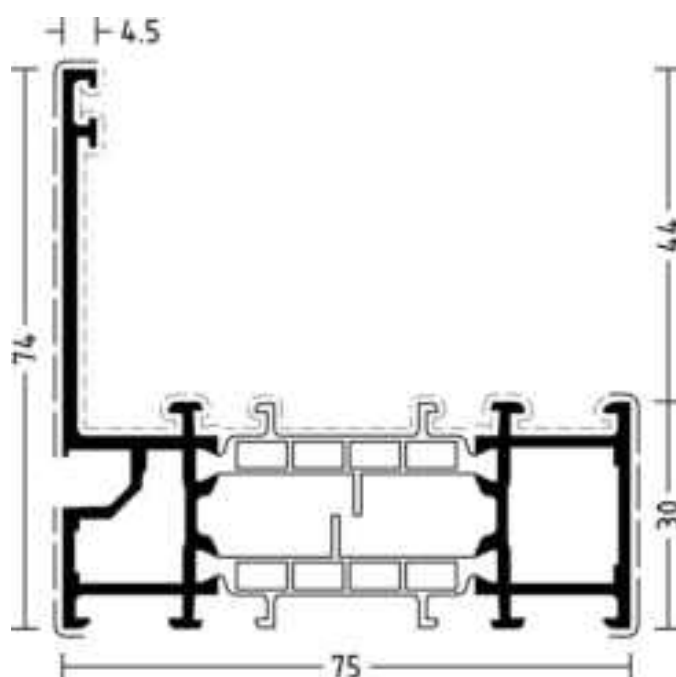









1917081

Gelenkeckwinkel und Gelenkverbinder siehe Zusatzartikel.
 Stoßverbindungen mit Blendrahmenprofilen mit verdeckter Entwässerung Verbinder 4960229 (außen).
 See additional articles for hinged corner angles and hinged connectors.
 Butt joint connections with frame profiles with concealed drainage connector 4960229 (outwards).



1010434

Stoßverbinder für Kämpferprofile siehe Seiten „Kämpferstoßverbindung“.
 See pages „Transom butt-joint connection“ for butt-joint connectors for transom profiles.



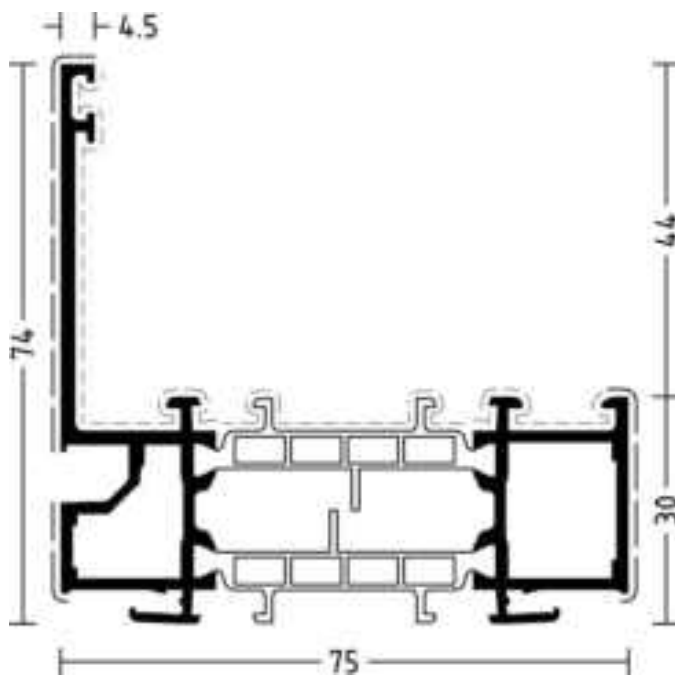











	 m	 mm	 mm									
 1010490	6,5	357	89	4050571	2x4070000	-	-	-	5010632	-	5940001	-
				4950008	2x4070000	-	-	-	5010632	-	5940001	-



1010490

Stoßverbinder für Kämpferprofile siehe Seiten „Kämpferstoßverbinding“.

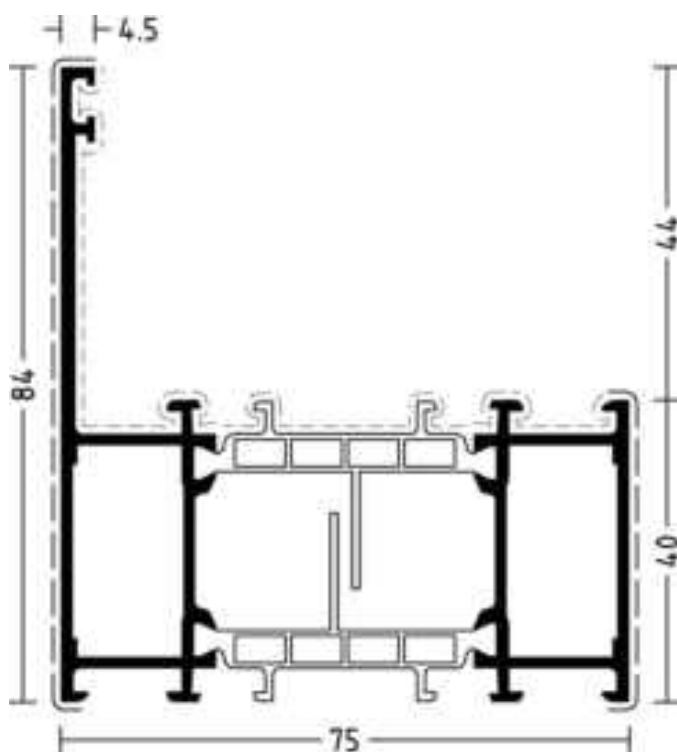

See pages „Transom butt-joint connection“ for butt-joint connectors for transom profiles.

	 m	 mm	 mm									
 1917082	6,5	356	124	4950009	2x4070000	1x4960021	1x4070000	1x4070030	5910006	5940101	5940001	5930003
				4950009	2x4070000	1x4960021	1x4070000	1x4070030	5910006	5940101	5940001	5930003



1917082



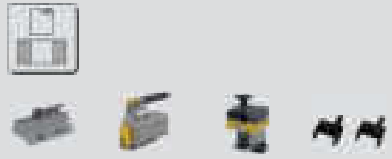

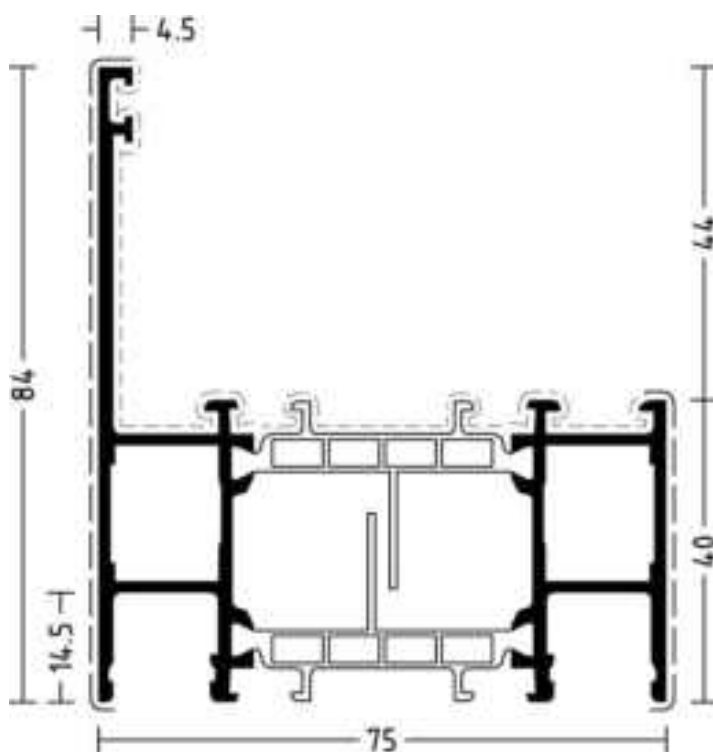









Gelenkeckwinkel und Gelenkverbinder siehe Zusatzartikel.
 Stoßverbindungen mit Blendrahmenprofilen mit verdeckter Entwässerung Verbinder 4960230 (außen).
See additional articles for hinged corner angles and hinged connectors.
Butt joint connections with frame profiles with concealed drainage connector 4960230 (outwards).

□ 1917086	6,5	387	124	 m mm mm		 			 			
				4950008	2x4070000	1x4960020	1x4070000	1x4070030	5910006	5940101	5940001	5930003
□				4950008	2x4070000	1x4960020	1x4070000	1x4070030	5910006	5940101	5940001	5930003



1917086

Gelenckwinkel und Gelenkverbinder siehe Zusatzartikel.
See additional articles for hinged corner angles and hinged connectors.



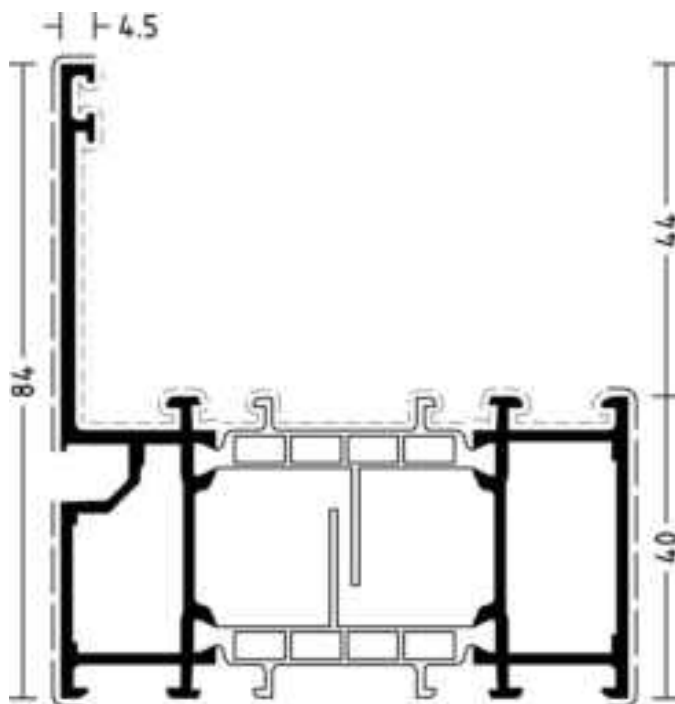











	 m	 mm	 mm									
 1010493	6,5	374	117	4050574	2x4070000	-	-	-	5910006	5940101	5940001	5930003
				4950009	2x4070000	-	-	-	5910006	5940101	5940001	5930003



1010493

Stoßverbinder für Kämpferprofile siehe Seiten „Kämpferstoßverbindung“.

See pages „Transom butt-joint connection“ for butt-joint connectors for transom profiles.

	 m	 mm	 mm										
 1010494	6,5	378	109	4050574	2x4070000	-	-	-	5010632	-	5940001	-	-
				4950009	2x4070000	-	-	-	5010632	-	5940001	-	-

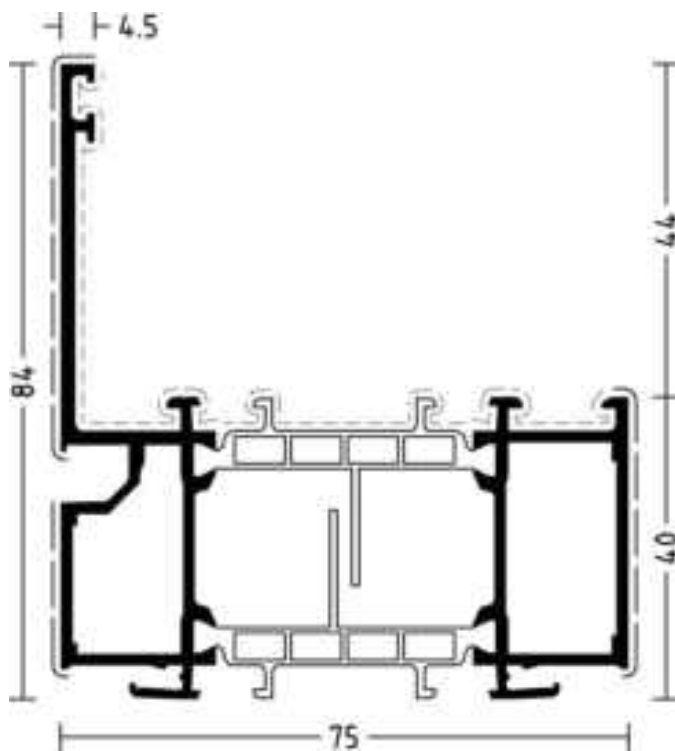















1010494

Stoßverbinder für Kämpferprofile siehe Seiten „Kämpferstoßverbindung“.

See pages „Transom butt-joint connection“ for butt-joint connectors for transom profiles.







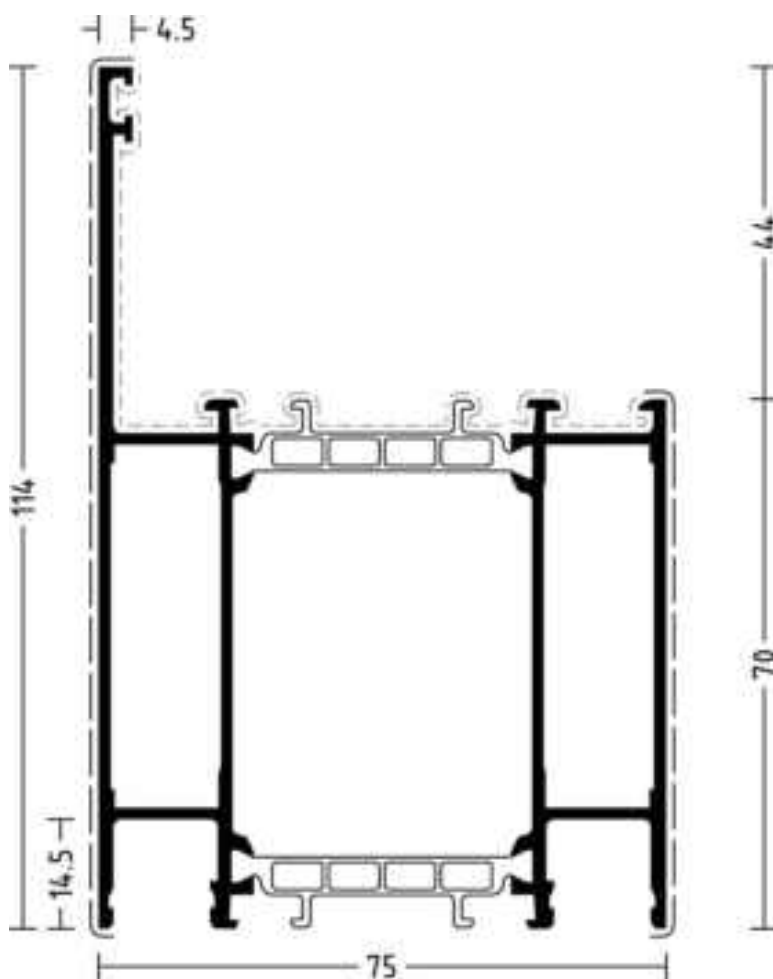







WICLINE 75

Blendrahmenprofile Frame profiles

	 m	 mm	 mm										
 1910170	6,5	448	184	4950011	2x4070000	4960023	2x4070000	2x4070030	5910006	5940101	5940001	5930003	
				4950011	2x4070000	4960023	2x4070000	2x4070030	5910006	5940101	5940001	5930003	



1910170

	 m	 mm	 mm									
 1917089	6,5	351	92	4950013	2x4070008	-	-	-	5910016	5940107	5940010	5930009
				4950006	2x4070008	-	-	-	5910016	5940101	5940010	5930009

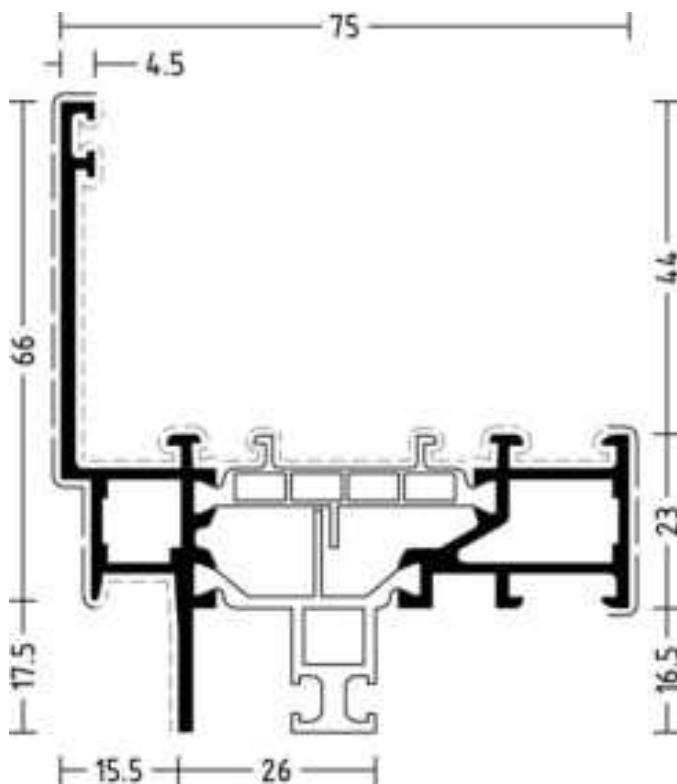

1917089

Einspannblendrahmen, verdeckter Flügel
Clamping frame, concealed sash

Icon	1917110	Dimensions			Accessories		Accessories			Accessories			
		m	mm	mm	Part	Part	Part	Part	Part	Part	Part	Part	Part
☒	1917110	6,5	287	77	4950038	2x4070000	-	-	-	5910071	5940110	5940023	-
☒					4950051	2x4070000	-	-	-	5910071	5940116	5940023	-

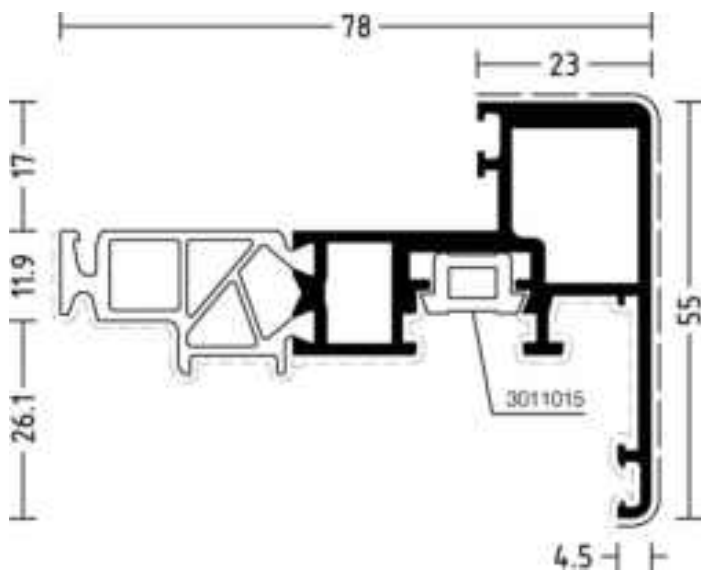

1917110

Die Eckverbindung muss unmittelbar nach dem Zuschnitt der Profile erfolgen.

The corner connection has to be done immediately after the sawing.



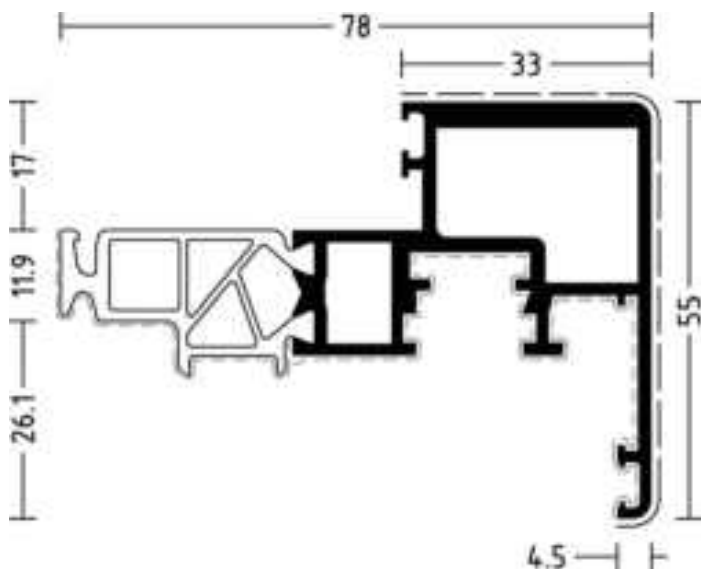











Icon	1917111	Dimensions			Accessories		Accessories			Accessories			
		m	mm	mm	Icon	Code	Icon	Code	Icon	Code	Icon	Code	Icon
☒	1917111	6,5	287	87	4950038	2x4070000	-	-	-	5910071	5940110	5940023	-
☒					4950052	2x4070000	-	-	-	5910071	5940116	5940023	-



1917111

Die Eckverbindung muss unmittelbar nach dem Zuschnitt der Profile erfolgen.

The corner connection has to be done immediately after the sawing.



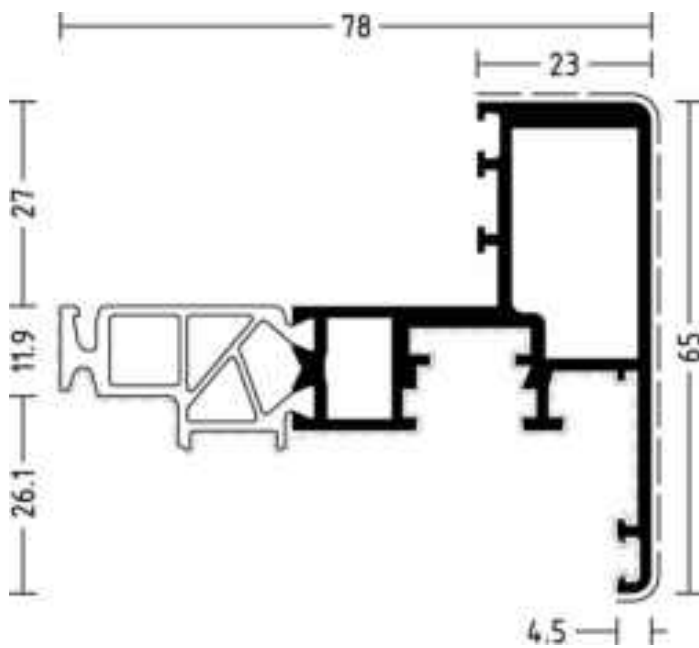











	 m	 mm	 mm									
 1917112	6,5	346	87	4950038	2x4070000	-	-	-	5910071	5940110	5940023	-
				4950053	2x4070000	-	-	-	5910071	5940116	5940023	-



1917112

Die Eckverbindung muss unmittelbar nach dem Zuschnitt der Profile erfolgen.

The corner connection has to be done immediately after the sawing.



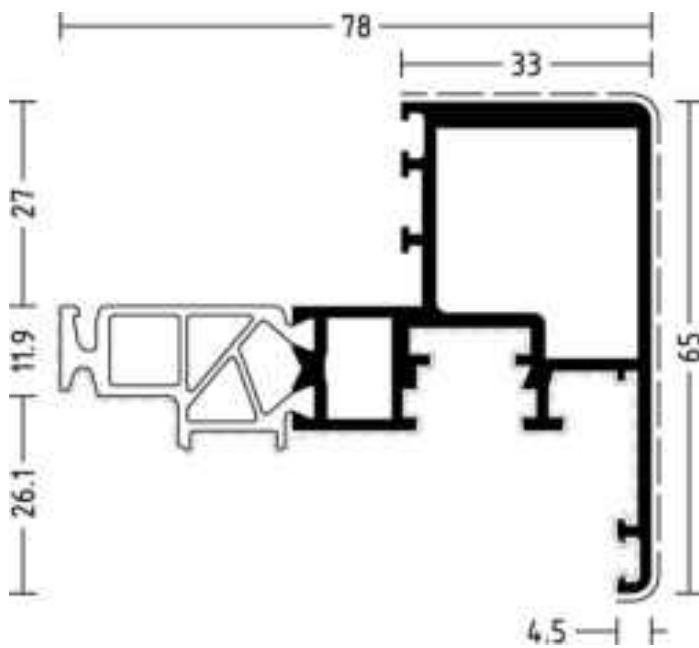











	 m	 mm	 mm									
 1917113	6,5	318	97	4950038	2x4070000	-	-	-	5910071	5940110	5940023	-
				4950054	2x4070000	-	-	-	5910071	5940116	5940023	-



1917113

Die Eckverbindung muss unmittelbar nach dem Zuschnitt der Profile erfolgen.

The corner connection has to be done immediately after the sawing.

	 m	 mm	 mm									
 1917231	6,5	435	148	4950008	2x4070000	1x4960020	1x4070000	1x4070030	5910006	5940101	5940001	5930003
 1917235	6,5	379	120	4950008	2x4070000	1x4960020	1x4070000	1x4070030	5910006	5940101	5940001	5930003

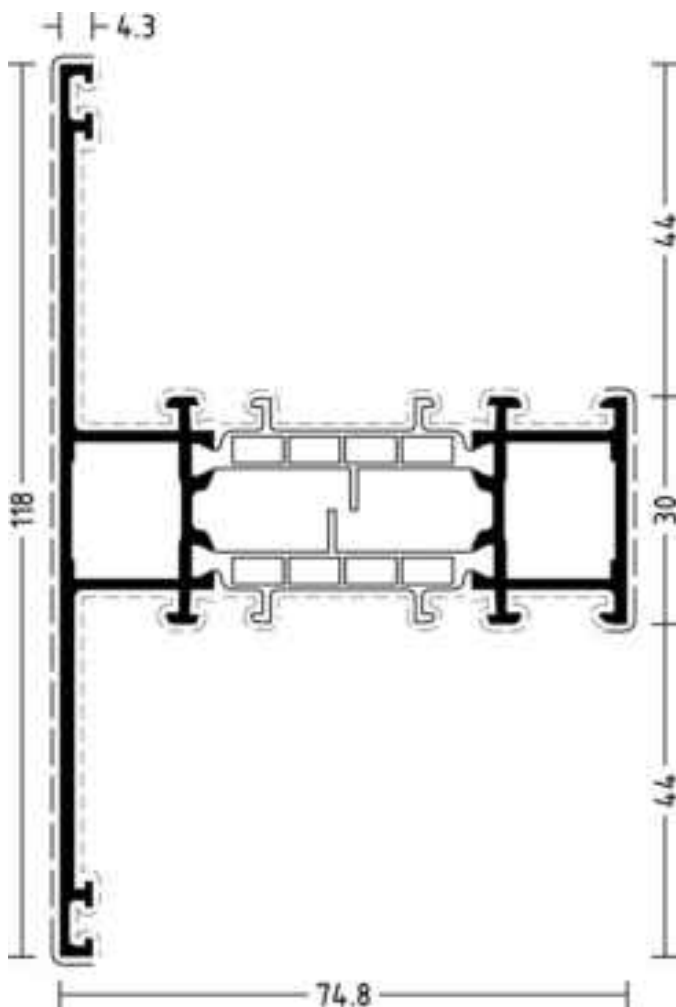

1917231

Gelenckwinkel und Gelenkverbinder siehe Zusatzartikel.
 Stoßverbindungen mit Blendrahmenprofilen mit verdeckter Entwässerung Verbinder 4960229 (außen).
 See additional articles for hinged corner angles and hinged connectors.
 Butt joint connections with frame profiles with concealed drainage connector 4960229 (outwards).

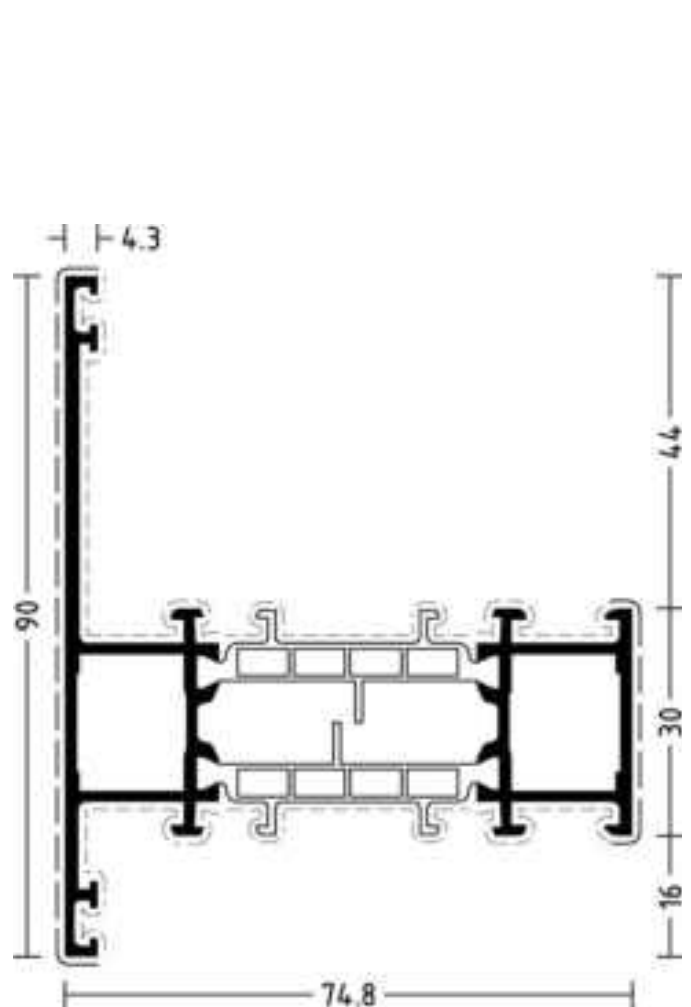















1917235

Gelenckwinkel und Gelenkverbinder siehe Zusatzartikel.
 Stoßverbindungen mit Blendrahmenprofilen mit verdeckter Entwässerung Verbinder 4960229 (außen).
 See additional articles for hinged corner angles and hinged connectors.
 Butt joint connections with frame profiles with concealed drainage connector 4960229 (outwards).

WICLINE 75

Stulpflügelprofile Double casement sash profiles

	 m	 mm	 mm									
 1917124	6,5	395	125	4950038	2x4070000	-	-	-	5910027	5940110	-	-
				4950051	1x4070004	-	-	-	5910027	5940117	-	-

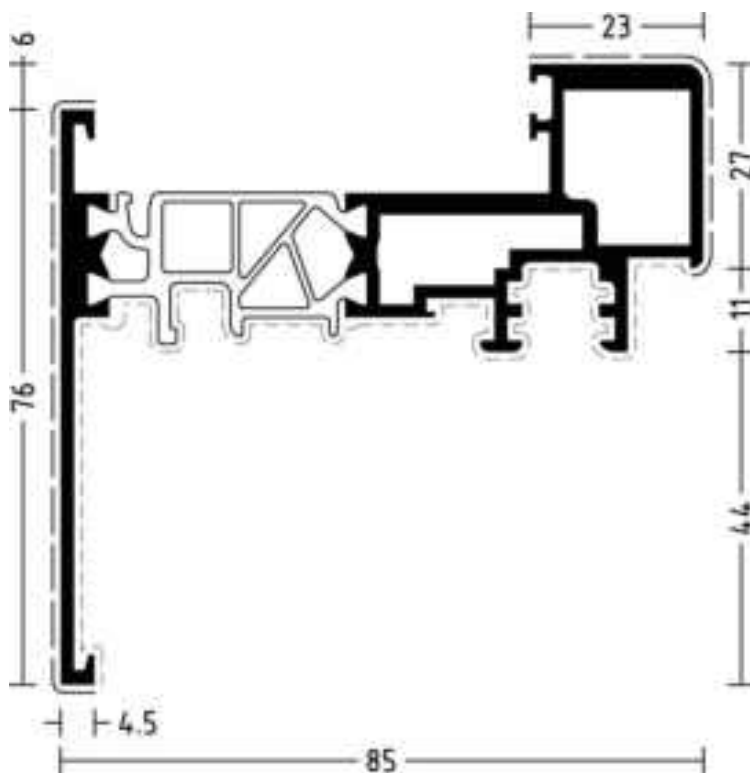















1917124

Verbindungselemente für Eckverbindung innen:
 1x 4070004 (Stulpflügelprofil) und 1x 4070000 (Flügelprofil)
 Connecting elements for corner connection inside:
 1x 4070004 (double casement sash profile) and 1x 4070000 (sash profile)

WICLINE 75





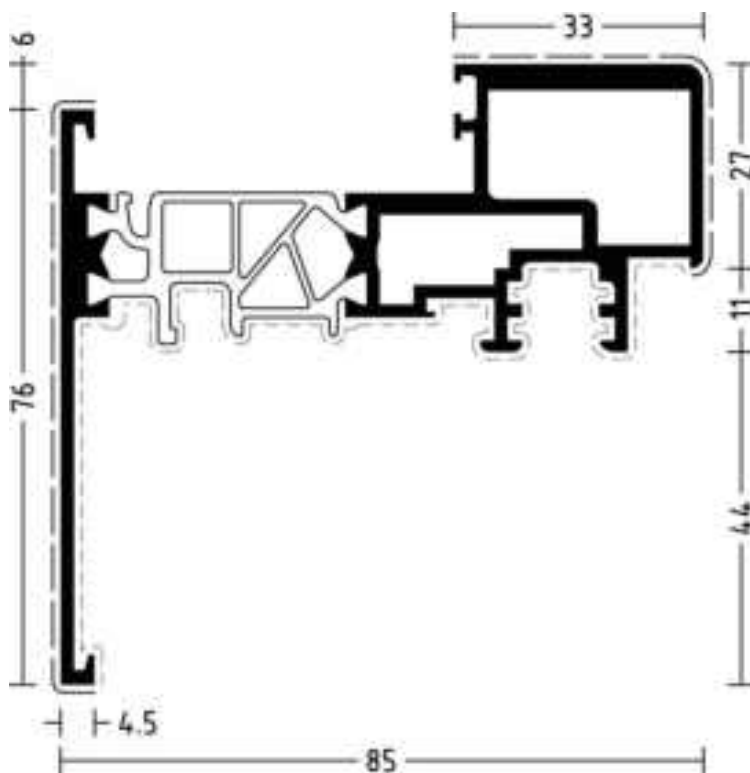









Stulpflügelprofile Double casement sash profiles

	 m	 mm	 mm										
 1917126	6,5	395	135	4950038	2x4070000	-	-	-	5910027	5940110	-	-	
				4950052	1x4070004	-	-	-	5910027	5940117	-	-	



1917126

Verbindungselemente für Eckverbindung innen:
 1x 4070004 (Stulpflügelprofil) und 1x 4070000 (Flügelprofil)
 Connecting elements for corner connection inside:
 1x 4070004 (double casement sash profile) and 1x 4070000 (sash profile)

	 m	 mm	 mm									
 1010463	6,5	196	1	-	-	-	-	-	-	-	-	-
				-	-	-	-	-	-	-	-	-
1010464	6,5	233	6	-	-	-	-	-	-	-	-	-
				-	-	-	-	-	-	-	-	-

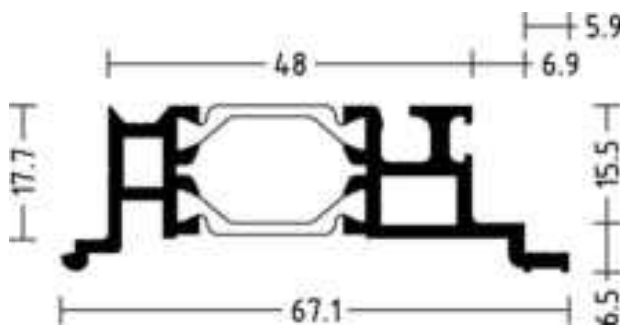

1010463

Verwendung:
Aufsatzprofil für Blendrahmenprofile zur Einspannung in WICTEC Serie
Application:
Supplementary profile of frame profiles for clamping

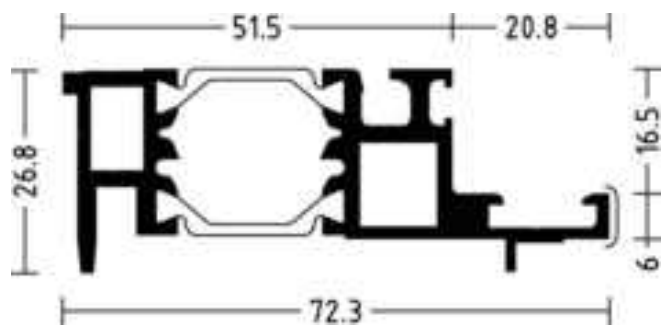

1010464

Verwendung:
Aufsatzprofil für Blendrahmenprofile zur Einspannung in WICTEC Serie
Application:
Supplementary profile of frame profiles for clamping

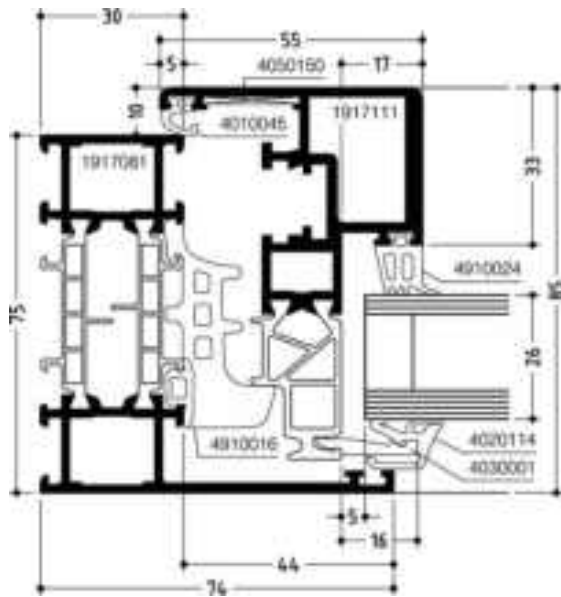

DOC-0000702321

Flügelprofil im
Blendrahmen,
verdeckter Flügel
*Concealed sash in
frame*

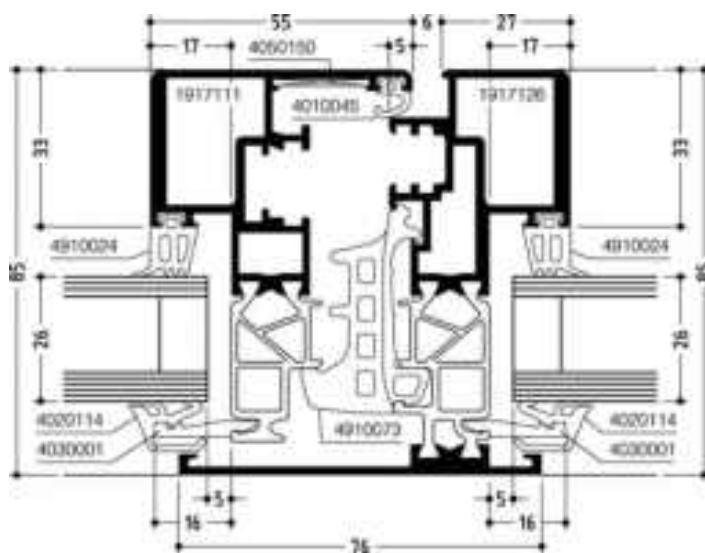

DOC-0000702604

Stulpfenster -
Mittelstoß, verdeck-
ter Flügel
*Double casement
window with
concealed sash -
Meeting stiles*

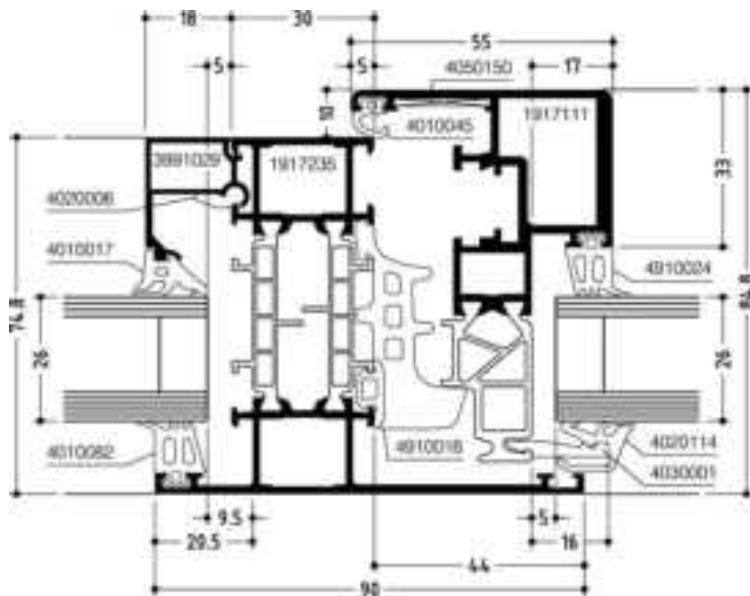

DOC-0000702852

Flügelprofil im
Blendrahmen mit
Kämpfer, verdeck-
ter Flügel
*Concealed sash in
frame with transom*

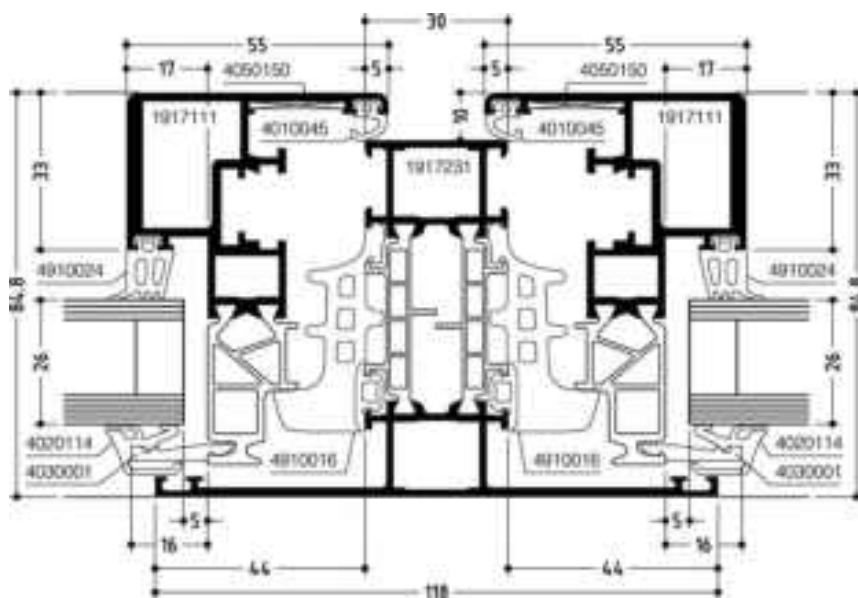

DOC-0000703007

Flügelprofil im
Blendrahmen mit
Kämpfer, verdeck-
ter Flügel
*Concealed sash in
frame with transom*

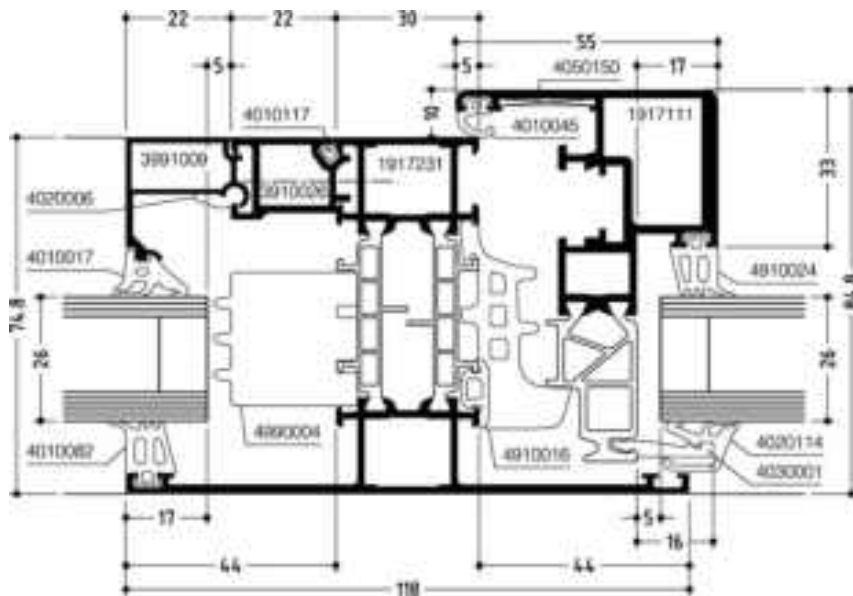

DOC-0000703017

Flügelprofil im
Blendrahmen mit
Kämpfer, verdeck-
ter Flügel

*Concealed sash in
frame with transom*

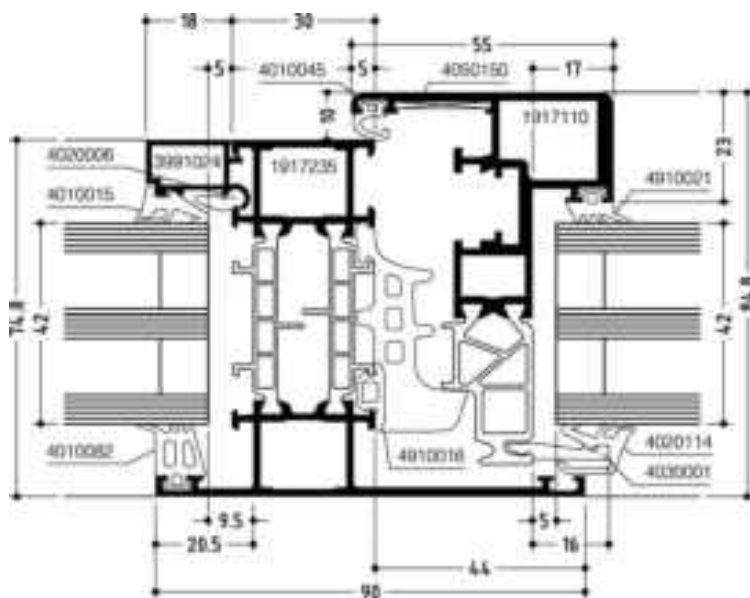

DOC-0000703045

Flügelprofil im
Blendrahmen mit
Kämpfer, verdeck-
ter Flügel

*Concealed sash in
frame with transom*

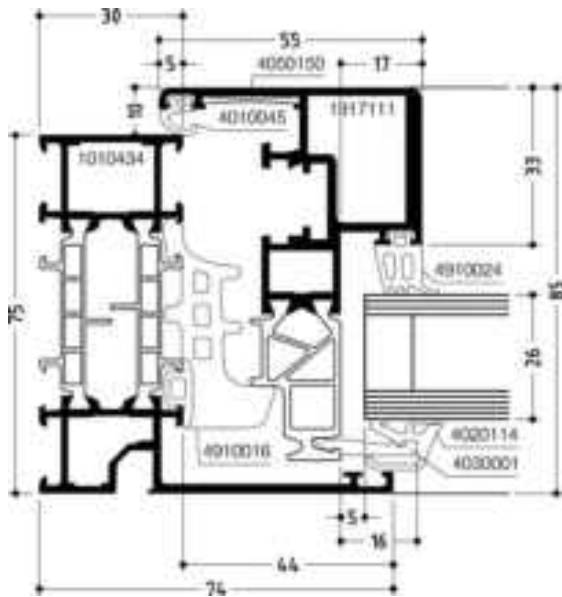

DOC-0001010696

Verdeckte Entwässerung, verdeckter Flügel
Concealed drainage, concealed sash in frame

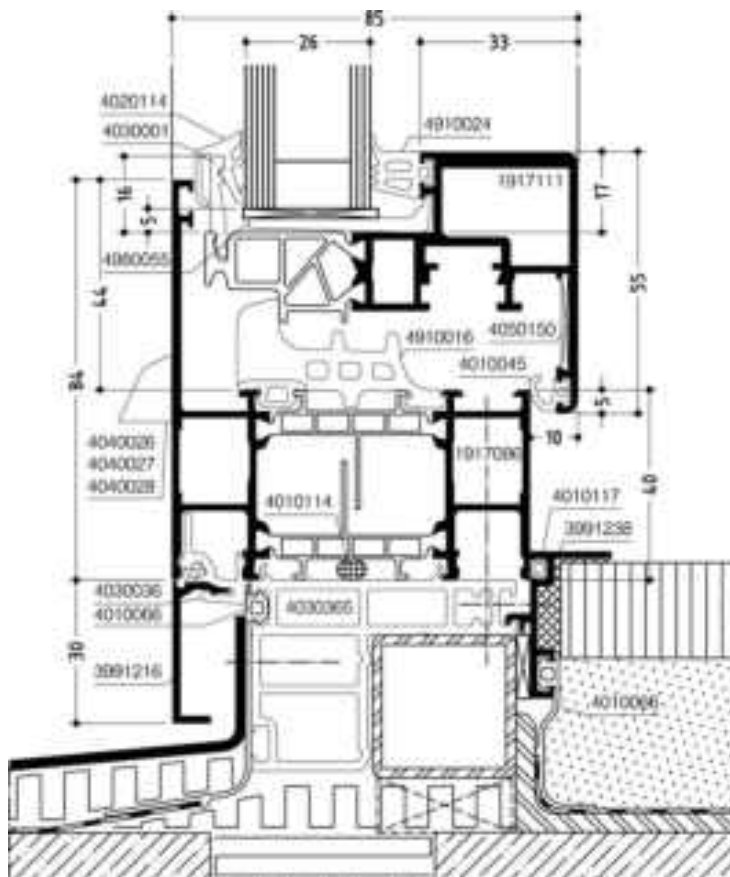

DOC-0000703242

Bauanschluss unten mit Dämm-
auflage 4030365, verdeckter Flügel
*Bottom junction to structure with
insulation support
4030365 and
concealed sash*

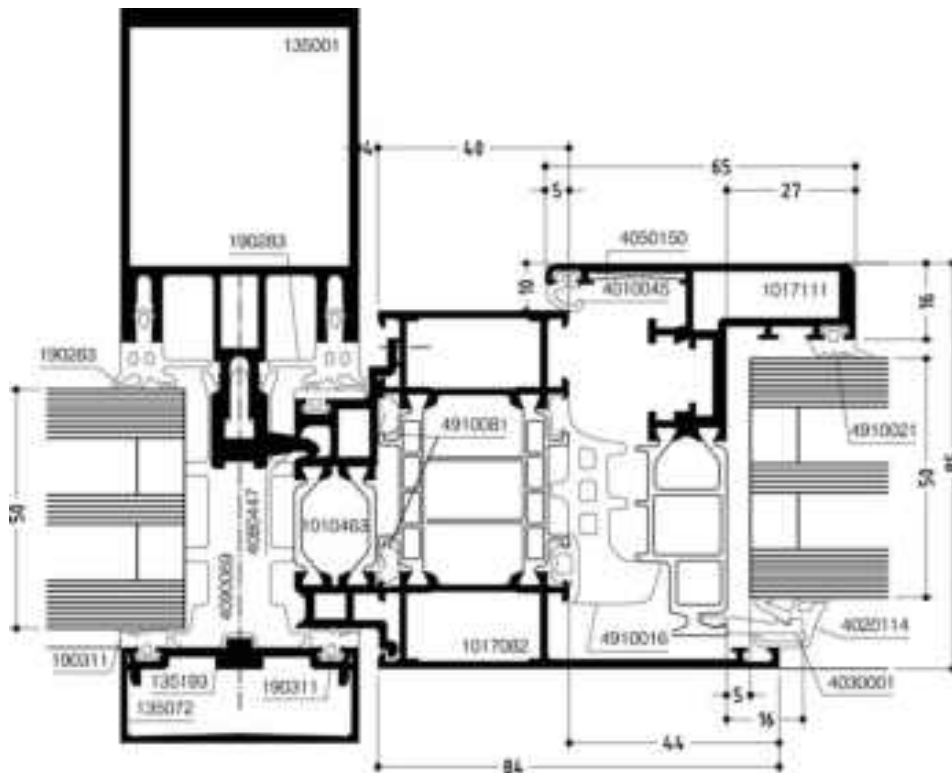

DOC-0001010926

Blendrahmen mit
Einspannaufsatz
und Befestigungs-
teil, verdeckter
Flügel

*Frame with
supplementary
clamping profile
and fixing part,
concealed sash*

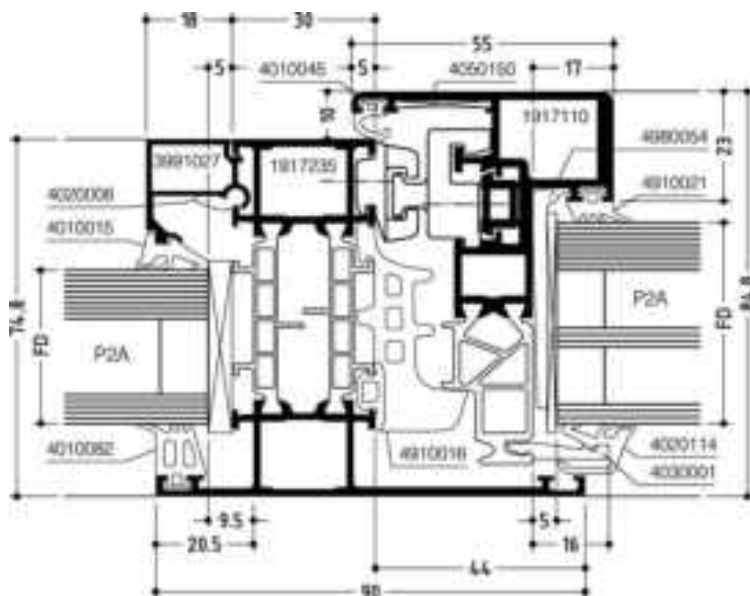

DOC-0000780184

Flügelprofil im
Blendrahmen
mit Kämpfer,
verdeckter Flügel,
EH-Verriegelung /
Füllungssicherung

*Concealed sash in
frame with transom,
burglar resistant
locking / Infill
safeguard*

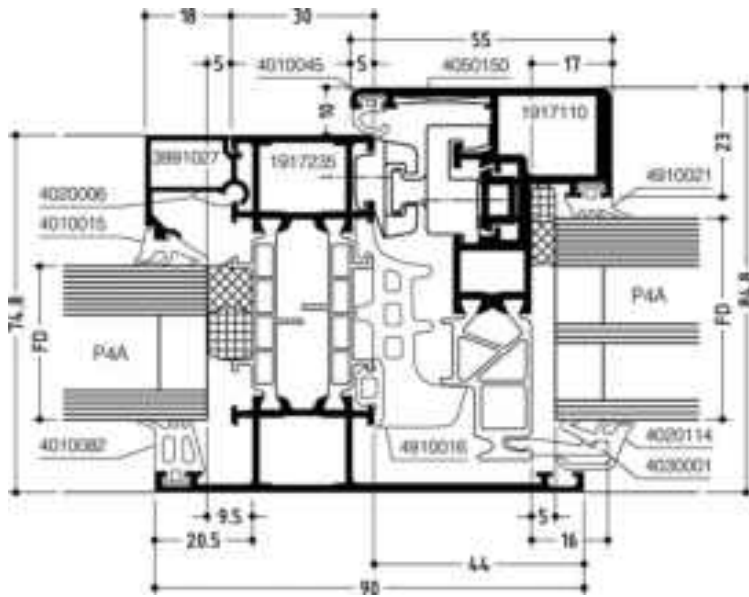

DOC-0000780240

Flügelprofil im
Blendrahmen
mit Kämpfer,
verdeckter Flügel,
EH-Verriegelung /
Füllungssicherung

*Concealed sash in
frame with transom,
burglar resistant
locking / Infill
safeguard*

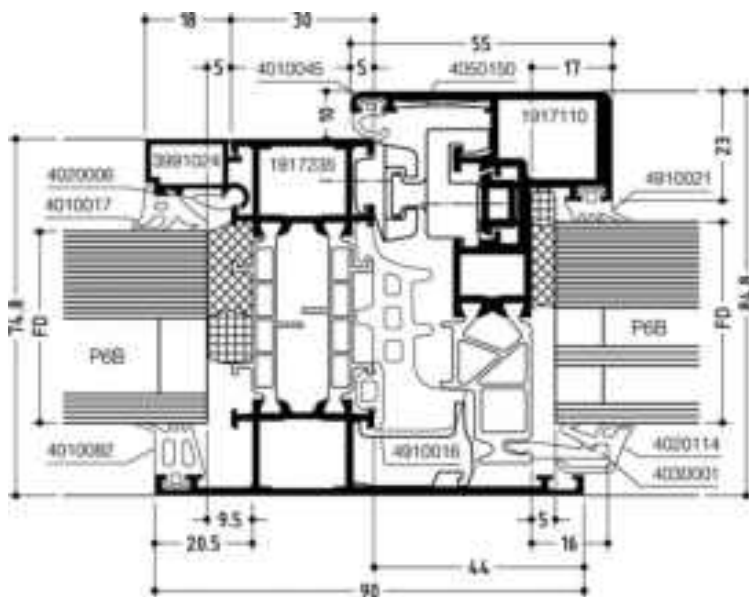

DOC-0000780248

Flügelprofil im
Blendrahmen
mit Kämpfer,
verdeckter Flügel,
EH-Verriegelung /
Füllungssicherung

*Concealed sash in
frame with transom,
burglar resistant
locking / Infill
safeguard*

Glasleistenprofile, Auswahltabellen Glazing bead profiles, selection tables

Die Auswahltable zeigt die verschiedenen Glasleistenprofile und die zulässigen Füllungsdicken mit Toleranzen.

Die Auswahltable ist für Trockenverglasung mittels EPDM-Dichtungsprofilen ausgelegt.

Bei der Verglasung sind die Vorschriften der Glashersteller und der einschlägigen Fachverbände zu beachten, insbesondere die Forderung nach einem funktionssicheren Dampfdruckausgleich und Entwässerung der Hohlräume im Glasfalzraum zwischen Isolierglas-Scheibenkante und Falzgrund.

Die Auswahltabellen ermöglichen eine theoretische Vorplanung. Die Glastoleranzen sind zu berücksichtigen. Um extreme Toleranzen der Profile und Füllungsdicken ausgleichen zu können, ist es vorteilhaft, bei der Planung die Füllungsdicken aus den punktschraffierten Feldern der Auswahltable zu entnehmen.

Bei der Montage sind die Vorgaben praktisch zu prüfen und gegebenenfalls durch Variationen der Einrolldichtungen, dargestellt durch die schraffierten Felder, die notwendige Vorspannung aufzubringen.

In der Tabelle sind die Artikelnummern der schwarzen Dichtungen angegeben. Weitere Farben (z. B. grau), siehe Programm / Zubehör.

The selection table shows the different glazing bead profiles and the admissible infill thicknesses with tolerances.

The selection table is designed for dry glazing with EPDM glazing gaskets.

Please follow the glazing instructions of glass manufacturers and relevant professional associations, especially the demand for a functionally secure air pressure equalization and drainage of cavities in glazing rebate area between insulation glass pane edge and rebate base.

The selection tables enable a preliminary theoretical planning. The glass tolerances have to be considered while planning. It is recommended to select infill thicknesses from the dotted columns areas of the selection table in order to compensate for extreme tolerances of profiles and infill thicknesses.

Check the specifications practically and, if required, apply the correct gasket pressure by choosing the suitable roll-in gaskets listed in the hatched columns.

The gasket article numbers specified in the table are for black gaskets. For further colours (e. g. grey), please consult our Product range / Accessories.

empfohlen
recommended

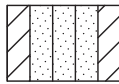

(XX) 402006
Anwendung bei beschichteten Profilen
Use on coated profiles



4020049
Anwendung bei eloxierten Profilen
Use on anodized profiles



Beispiel / Example



Glasleistenprofile Glazing bead profiles			(a) Füllungsdicke ± 1 mm mit Einrolldichtung Nr.: Infill thickness ± 1 mm with rolled gasket no.:				
Nr. / No. 18 mm	Nr. / No. 22 mm	(b) mm	4910004	4010015 blau / blue	4010016 rot / red	4010017 grün / green	4010018
3991022	3991001	2	60	59	58	57	56
3991023	3991002	5	57	56	55	54	53
3991024	3991003	9	53	52	51	50	49
3991025	3991004	12	50	49	48	47	46
3991026	3991005	15	47	46	45	44	43
3991027	3991006	19	43	42	41	40	39
3991028	3991007	22	40	39	38	37	36
3991029	3991008	24	38	37	36	35	34
3991030	3991009	26	36	35	34	33	32
3991031	3991010	29	33	32	31	30	29
3991032	3991011	32	30	29	28	27	26
3991033	3991012	34	28	27	26	25	24
3991034	3991013	37	25	24	23	22	21
3991035	3991014	41	21	20	19	18	17
3991036	3991015	45	17	16	15	14	13
3991037	3991016	49	13	12	11	10	9
	3991017	52	10	9	8	7	6

- ① Bautiefe auswählen
Select construction depth
- ② Füllungsdicke auswählen
Select infill thickness
- ③ Entsprechende Glasleiste
Appropriate glazing bead
- ④ Entsprechende innere Verglasungsdichtung
Appropriate inner glazing gasket

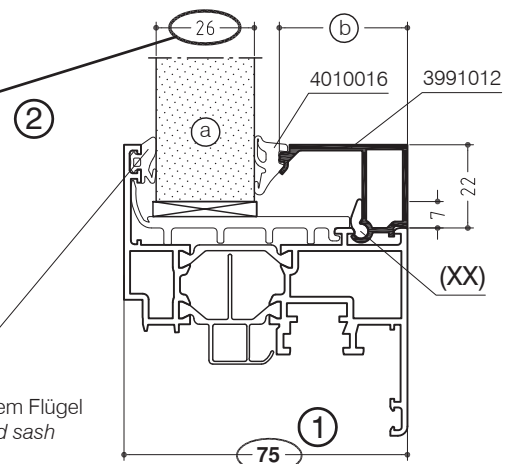

4010003
4020114
bei verdecktem Flügel
for concealed sash

Glasleistenprofile, Auswahltabellen
Glazing bead profiles, selection tables



Glasleistenprofile Glazing bead profiles			(a) Füllungsdicke ±1 mm mit Einrolldichtung Nr.: Infill thickness ±1 mm with rolled gasket no.:				
Nr. / No. 18 mm	Nr. / No. 22 mm	(b) mm	4910004	4010015 blau / blue	4010016 rot / red	4010017 grün / green	4010018
	3991001	2	60	59	58	57	56
3991022	3991002	5	57	56	55	54	53
3991023	3991003	9	53	52	51	50	49
3991024	3991004	12	50	49	48	47	46
3991025	3991005	15	47	46	45	44	43
3991026	3991006	19	43	42	41	40	39
3991027	3991007	22	40	39	38	37	36
3991028	3991008	24	38	37	36	35	34
3991029	3991009	26	36	35	34	33	32
3991030	3991010	29	33	32	31	30	29
3991031	3991011	32	30	29	28	27	26
3991032	3991012	34	28	27	26	25	24
3991033	3991013	37	25	24	23	22	21
3991034	3991014	41	21	20	19	18	17
3991035	3991015	45	17	16	15	14	13
3991036	3991016	49	13	12	11	10	9
3991037	3991017	52	10	9	8	7	6

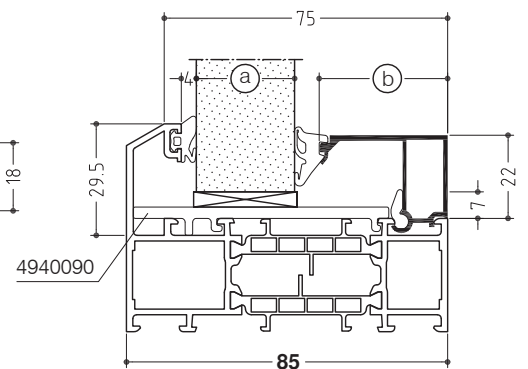
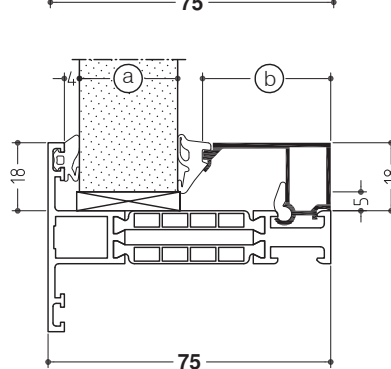
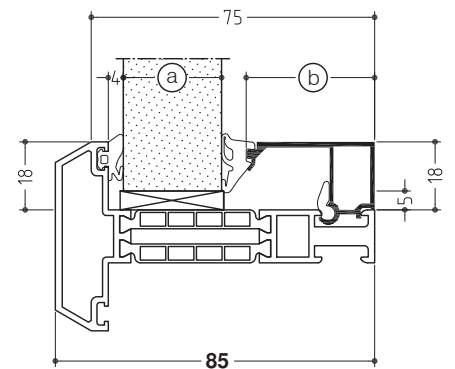
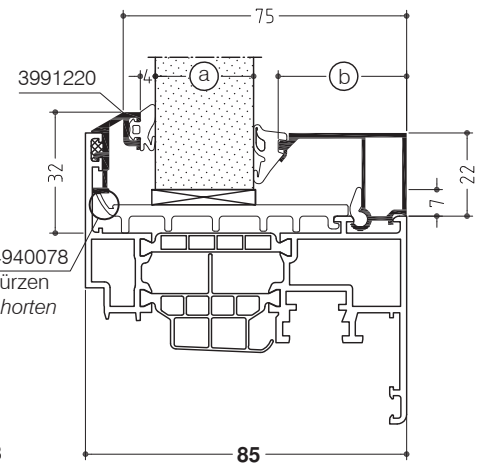
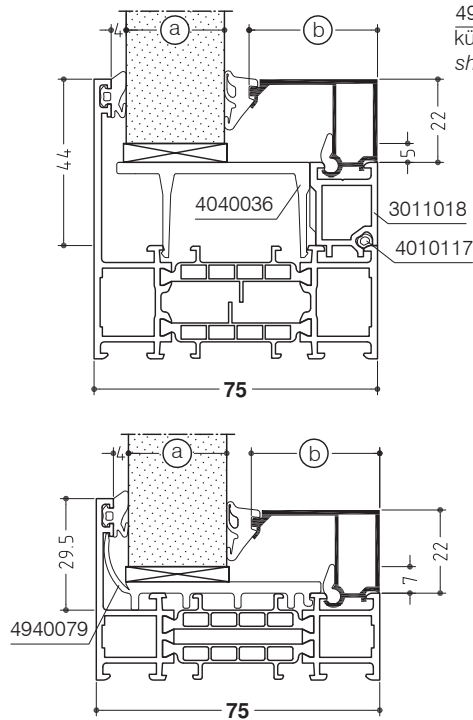
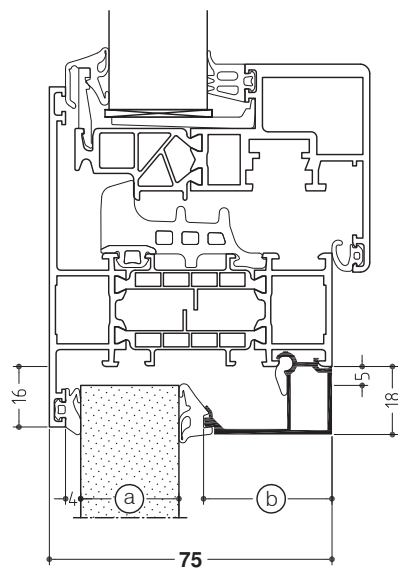

Glasleistenprofile, Auswahltabellen
Glazing bead profiles, selection tables



Glasleistenprofile Glazing bead profiles			a) Füllungsdicke ±1 mm mit Einrolldichtung Nr.: Infill thickness ±1 mm with rolled gasket no.:				
Nr. / No. 18 mm	Nr. / No. 22 mm	b) mm	4910004	4010015 blau / blue	4010016 rot / red	4010017 grün / green	4010018
	3991001	2	70	69	68	67	66
3991022	3991002	5	67	66	65	64	63
3991023	3991003	9	63	62	61	60	59
3991024	3991004	12	60	59	58	57	56
3991025	3991005	15	57	56	55	54	53
3991026	3991006	19	53	52	51	50	49
3991027	3991007	22	50	49	48	47	46
3991028	3991008	24	48	47	46	45	44
3991029	3991009	26	46	45	44	43	42
3991030	3991010	29	43	42	41	40	39
3991031	3991011	32	40	39	38	37	36
3991032	3991012	34	38	37	36	35	34
3991033	3991013	37	35	34	33	32	31
3991034	3991014	41	31	30	29	28	27
3991035	3991015	45	27	26	25	24	23
3991036	3991016	49	23	22	21	20	19
3991037	3991017	52	20	19	18	17	16

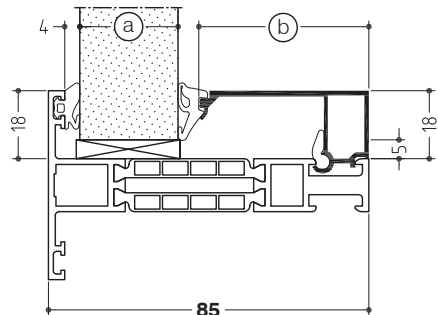
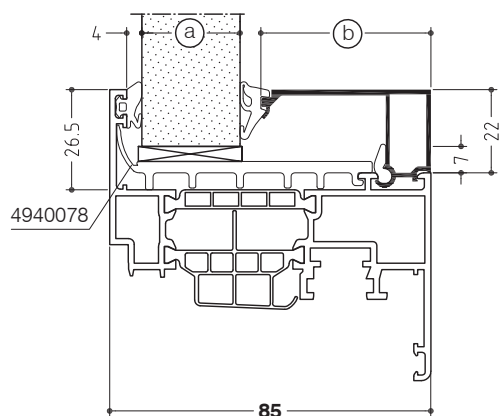

Glasleistenprofile, Auswahltabellen
Glazing bead profiles, selection tables



Glasscheibe außen bündig mit verdecktem Flügel

Outer glass pane flush with concealed sash

Glasleistenprofile Glazing bead profiles		(a) Füllungsdicke ± 1 mm mit Einrolldichtung Nr.: Infill thickness ± 1 mm with rolled gasket no.:				
Nr. / No. 18 mm	(b) mm	4910004	4010015 blau / blue	4010016 rot / red	4010017 grün / green	4010018
3991022	5	50	49	48	47	46
3991023	9	46	45	44	43	42
3991024	12	43	42	41	40	39
3991025	15	40	39	38	37	36
3991026	19	36	35	34	33	32
3991027	22	33	32	31	30	29
3991028	24	31	30	29	28	27
3991029	26	29	28	27	26	25
3991030	29	33	32	31	30	29
3991031	32	23	22	21	20	19
3991032	34	21	20	19	18	17
3991033	37	18	17	16	15	14
3991034	41	14	13	12	11	10
3991035	45	10	9	8	7	6
3991036	49	6	5	4		

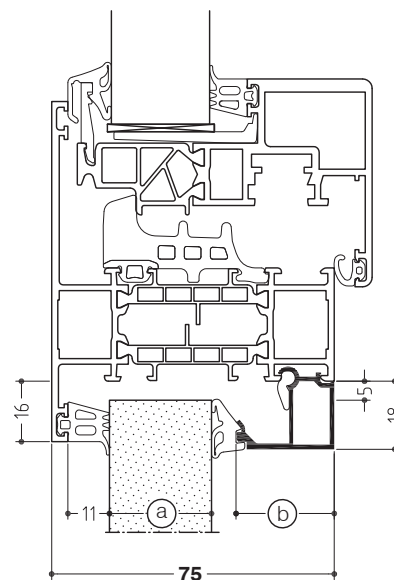

Glasleistenprofile, Auswahltabellen
Glazing bead profiles, selection tables



Flügelprofile / Sash profiles 1917110, 1917112

innere Dichtung <i>inner gasket</i>		(a) Füllungsdicke ±1 mm <i>Infill thickness ±1 mm</i>
Nr. / No.	(c) Spaltmaß <i>Gap dimension</i> mm	
4910021	4	
4910022	6	
4910023	8	
4910024	10	
4910025	12	

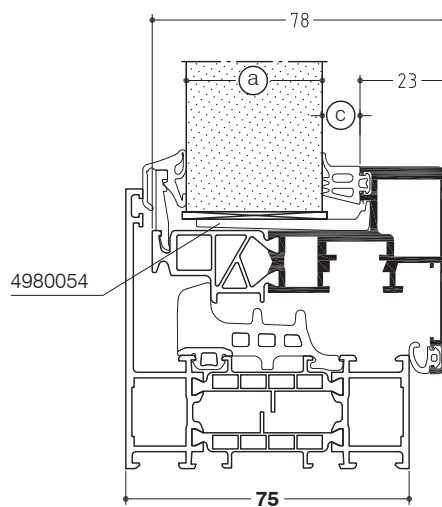

Flügelprofile / Sash profiles 1917111, 1917113

innere Dichtung <i>inner gasket</i>		(a) Füllungsdicke ±1 mm <i>Infill thickness ±1 mm</i>
Nr. / No.	(c) Spaltmaß <i>Gap dimension</i> mm	
4910021	4	
4910022	6	
4910023	8	
4910024	10	
4910025	12	

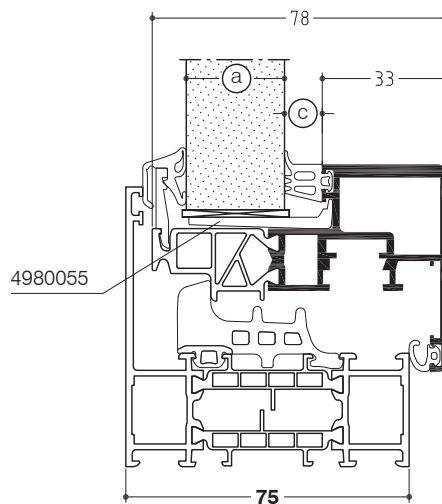

Glasleistenprofile, Auswahltabellen
Glazing bead profiles, selection tables



Glasleistenprofile Glazing bead profiles			a) Füllungsdicke ±1 mm mit Einrolldichtung Nr.: Infill thickness ±1 mm with rolled gasket no.:				
Nr. / No. 18 mm	Nr. / No. 22 mm	b) mm	4910004	4010015 blau / blue	4010016 rot / red	4010017 grün / green	4010018
	3991001	2	60	59	58	57	56
3991022	3991002	5	57	56	55	54	53
3991023	3991003	9	53	52	51	50	49
3991024	3991004	12	50	49	48	47	46
3991025	3991005	15	47	46	45	44	43
3991026	3991006	19	43	42	41	40	39
3991027	3991007	22	40	39	38	37	36
3991028	3991008	24	38	37	36	35	34
3991029	3991009	26	36	35	34	33	32
3991030	3991010	29	33	32	31	30	29
3991031	3991011	32	30	29	28	27	26
3991032	3991012	34	28	27	26	25	24
3991033	3991013	37	25	24	23	22	21
3991034	3991014	41	21	20	19	18	17
3991035	3991015	45	17	16	15	14	13
3991036	3991016	49	13	12	11	10	9
3991037	3991017	52	10	9	8	7	6

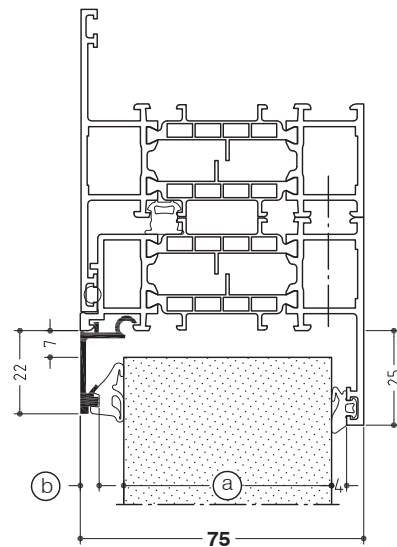

Glasleistenprofile, Auswahltabellen
Glazing bead profiles, selection tables

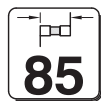

Glasleistenprofile Glazing bead profiles			a) Füllungsdicke ±1 mm mit Einrolldichtung Nr.: Infill thickness ±1 mm with rolled gasket no.:				
Nr. / No. 18 mm	Nr. / No. 22 mm	b) mm	4910004	4010015 blau / blue	4010016 rot / red	4010017 grün / green	4010018
	3991001	2	70	69	68	67	66
3991022	3991002	5	67	66	65	64	63
3991023	3991003	9	63	62	61	60	59
3991024	3991004	12	60	59	58	57	56
3991025	3991005	15	57	56	55	54	53
3991026	3991006	19	53	52	51	50	49
3991027	3991007	22	50	49	48	47	46
3991028	3991008	24	48	47	46	45	44
3991029	3991009	26	46	45	44	43	42
3991030	3991010	29	43	42	41	40	39
3991031	3991011	32	40	39	38	37	36
3991032	3991012	34	38	37	36	35	34
3991033	3991013	37	35	34	33	32	31
3991034	3991014	41	31	30	29	28	27
3991035	3991015	45	27	26	25	24	23
3991036	3991016	49	23	22	21	20	19
3991037	3991017	52	20	19	18	17	16

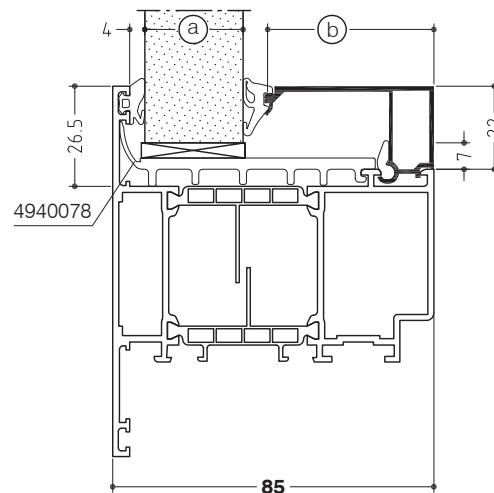



innere Dichtung <i>inner gasket</i>		(a) Füllungsdicke ± 1 mm <i>Infill thickness ± 1 mm</i>
Nr. / No.	(c) Spaltmaß <i>Gap dimension</i> mm	
4910021	4.5	40
4910022	6.5	38
4910023	8.5	36
4910024	10.5	34
4910025	12.5	32

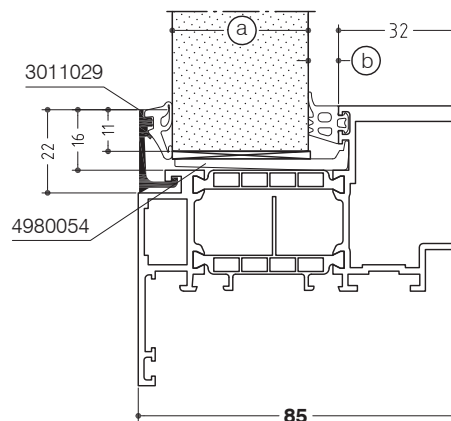

WICLINE 75

Glasleistenprofile, Auswahltabellen
Glazing bead profiles, selection tables



Glasleistenprofile Glazing bead profiles			a) Füllungsdicke ±1 mm mit Einrolldichtung Nr.: Infill thickness ±1 mm with rolled gasket no.:				
Nr. / No. 18 mm	Nr. / No. 18 mm	b) mm	4910004	4010015 blau / blue	4010016 rot / red	4010017 grün / green	4010018
2-fach Glas Double glazing							
3090262	3991030	29	34	33	32	31	30
3090263	3991031	32	31	30	29	28	27
3-fach Glas Triple glazing							
3090258	3991023	9	54	53	52	51	50
3090259	3991024	12	51	50	49	48	47

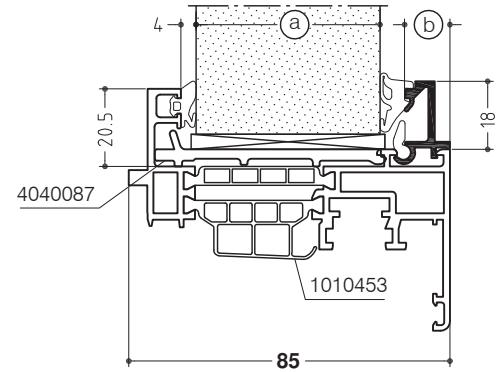
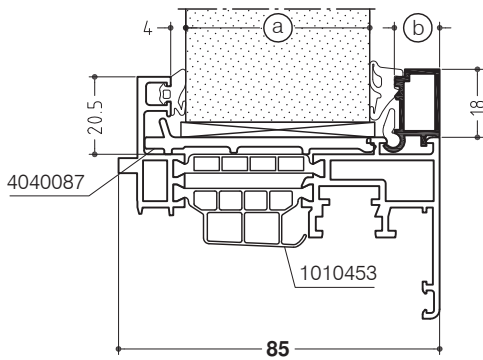
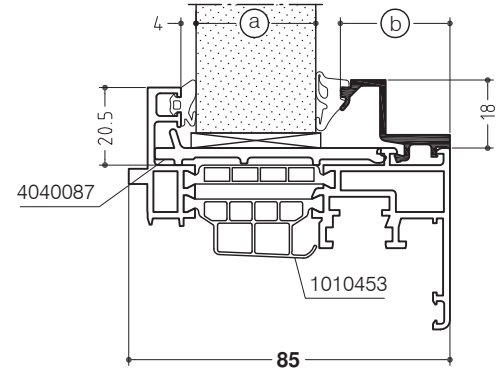

Glasleistenprofile Glazing bead profiles			a) Füllungsdicke ±1 mm mit Einrolldichtung Nr.: Infill thickness ±1 mm with rolled gasket no.:				
Nr. / No. 18 mm	Nr. / No. 18 mm	b) mm	4910004	4010015 blau / blue	4010016 rot / red	4010017 grün / green	4010018
2-fach Glas Double glazing							
3090262	3991030	29	33	32	31	30	29
3090263	3991031	32	30	29	28	27	26
3-fach Glas Triple glazing							
3090258	3991023	9	53	52	51	50	49
3090259	3991024	12	50	49	48	47	46

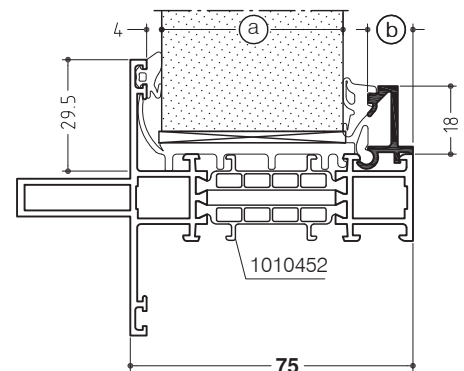
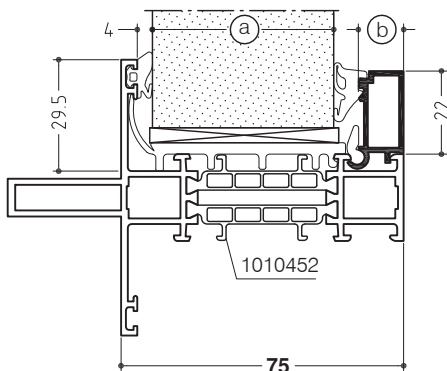
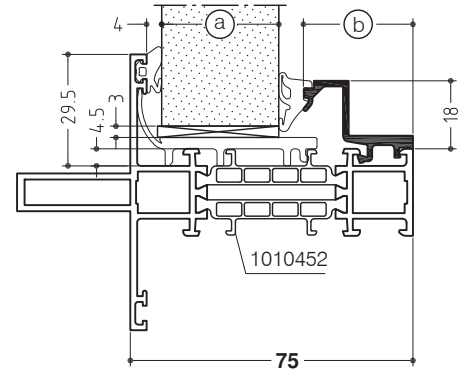

Glasleistenprofile, Auswahltabellen für Trockenverglasung Glazing bead profiles, selection tables for dry glazing

Die Auswahltable zeigt die verschiedenen Glasleistenprofile und die zulässigen Füllungsdicken mit Toleranzen.

The selection table shows the different glazing bead profiles and the admissible infill thicknesses with tolerances.

Die Auswahltable ist für Trockenverglasung mittels EPDM-Dichtungsprofilen ausgelegt.

The selection table is designed for dry glazing with EPDM glazing gaskets.

Bei der Verglasung sind die Vorschriften der Glashersteller und der einschlägigen Fachverbände zu beachten, insbesondere die Forderung nach einem funktionssicheren Dampfdruckausgleich und Entwässerung der Hohlräume im Glasfalzraum zwischen Isolierglas-Scheibenkante und Falzgrund.

Please follow the glazing instructions of glass manufacturers and relevant professional associations, especially the demand for a functionally secure air pressure equalization and drainage of cavities in glazing rebate area between insulation glass pane edge and rebate base.

Die Auswahltable ermöglichen eine theoretische Vorplanung. Die Glastoleranzen sind zu berücksichtigen. Um extreme Toleranzen der Profile und Füllungsdicken ausgleichen zu können, ist es vorteilhaft, bei der Planung die Füllungsdicken aus den punktschraffierten Feldern der Auswahltable zu entnehmen.

The selection tables enable a preliminary theoretical planning. The glass tolerances have to be considered while planning. It is recommended to select infill thicknesses from the dotted columns areas of the selection table in order to compensate for extreme tolerances of profiles and infill thicknesses.

Bei der Montage sind die Vorgaben praktisch zu prüfen und gegebenenfalls durch Variationen der Einrolldichtungen, dargestellt durch die schraffierten Felder, die notwendige Vorspannung aufzubringen.

Check the specifications practically and, if required, apply the correct gasket pressure by choosing the suitable roll-in gaskets listed in the hatched columns.

In der Tabelle sind die Artikelnummern der schwarzen Dichtungen angegeben. Weitere Farben (z. B. grau), siehe Programm / Zubehör.

The gasket article numbers specified in the table are for black gaskets. For further colours (e. g. grey), please consult our Product range / Accessories.

empfohlen
recommended

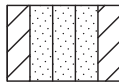

(XX) 402006
Anwendung bei beschichteten Profilen
Use on coated profiles



4020049
Anwendung bei eloxierten Profilen
Use on anodized profiles



Beispiel / Example

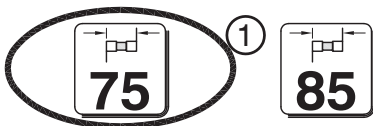

Glasleistenprofile Glazing bead profiles			(a) Füllungsdicke ± 1 mm mit Einrolldichtung Nr.: Infill thickness ± 1 mm with rolled gasket no.:				
Nr. / No. 18 mm	Nr. / No. 22 mm	(b) mm	4910004	4010015 blau / blue	4010016 rot / red	4010017 grün / green	4010018
3991022	3991001	2	60	59	58	57	56
3991023	3991002	5	57	56	55	54	53
3991024	3991003	9	53	52	51	50	49
3991025	3991004	12	50	49	48	47	46
3991026	3991005	15	47	46	45	44	43
3991027	3991006	19	43	42	41	40	39
3991028	3991007	22	40	39	38	37	36
3991029	3991008	24	38	37	36	35	34
3991030	3991009	26	36	35	34	33	32
3991031	3991010	29	33	32	31	30	29
3991032	3991011	32	30	29	28	27	26
3991033	3991012	34	28	27	26	25	24
3991034	3991013	37	25	24	23	22	21
3991035	3991014	41	21	20	19	18	17
3991036	3991015	45	17	16	15	14	13
3991037	3991016	49	13	12	11	10	9
3991037	3991017	52	10	9	8	7	6

- ① Bautiefe auswählen
Select construction depth
- ② Füllungsdicke auswählen
Select infill thickness
- ③ Entsprechende Glasleiste
Appropriate glazing bead
- ④ Entsprechende innere Verglasungsdichtung
Appropriate inner glazing gasket

4010003
4020114
bei verdecktem Flügel
for concealed sash

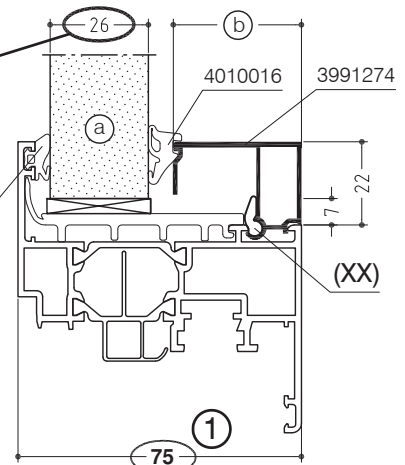

Glasleistenprofile, Auswahltabellen für Trockenverglasung
Glazing bead profiles, selection tables for dry glazing



Glasleistenprofile Glazing bead profiles		(a) Füllungsdicke ± 1 mm mit Einrolldichtung Nr.: Infill thickness ± 1 mm with rolled gasket no.:				
Nr. / No.	(b) mm	4910004	4010015 blau / blue	4010016 rot / red	4010017 grün / green	4010018
3991001	2	60	59	58	57	56
3991264	5	57	56	55	54	53
3991265	9	53	52	51	50	49
3991266	12	50	49	48	47	46
3991267	15	47	46	45	44	43
3991268	19	43	42	41	40	39
3991269	22	40	39	38	37	36
3991270	24	38	37	36	35	34
3991271	26	36	35	34	33	32
3991272	29	33	32	31	30	29
3991273	32	30	29	28	27	26
3991274	34	28	27	26	25	24
3991275	37	25	24	23	22	21
3991276	41	21	20	19	18	17
3991277	45	17	16	15	14	13
3991278	49	13	12	11	10	9
3991279	52	10	9	8	7	6

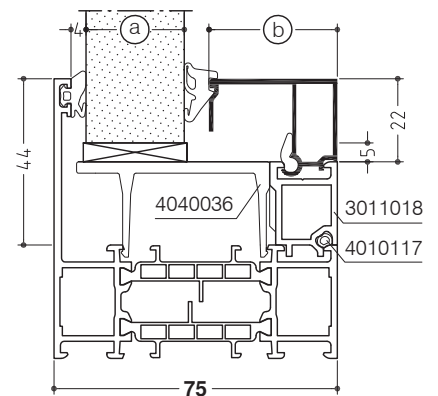
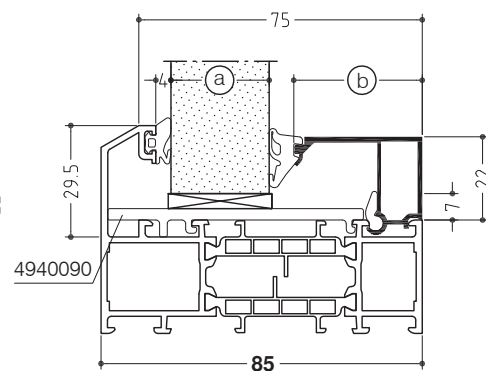
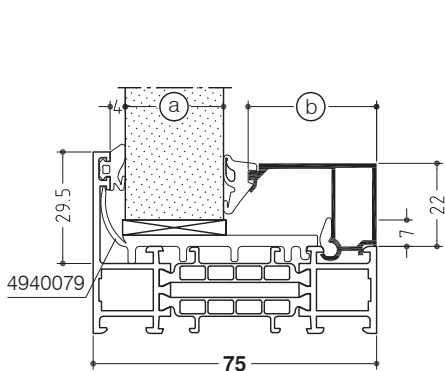
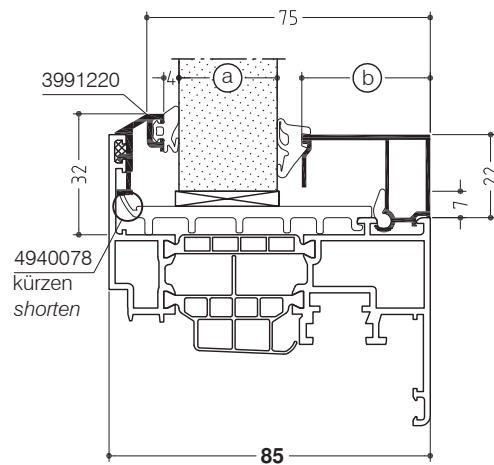

Glasleistenprofile, Auswahltabellen für Trockenverglasung
Glazing bead profiles, selection tables for dry glazing



Nr. / No. 22 mm	(b) mm	(a) Füllungsdicke ±1 mm mit Einrolldichtung Nr.: Infill thickness ±1 mm with rolled gasket no.:				
		4910004	4010015 blau / blue	4010016 rot / red	4010017 grün / green	4010018
3991001	2	70	69	68	67	66
3991264	5	67	66	65	64	63
3991265	9	63	62	61	60	59
3991266	12	60	59	58	57	56
3991267	15	57	56	55	54	53
3991268	19	53	52	51	50	49
3991269	22	50	49	48	47	46
3991270	24	48	47	46	45	44
3991271	26	46	45	44	43	42
3991272	29	43	42	41	40	39
3991273	32	40	39	38	37	36
3991274	34	38	37	36	35	34
3991275	37	35	34	33	32	31
3991276	41	31	30	29	28	27
3991277	45	27	26	25	24	23
3991278	49	23	22	21	20	19
3991279	52	20	19	18	17	16

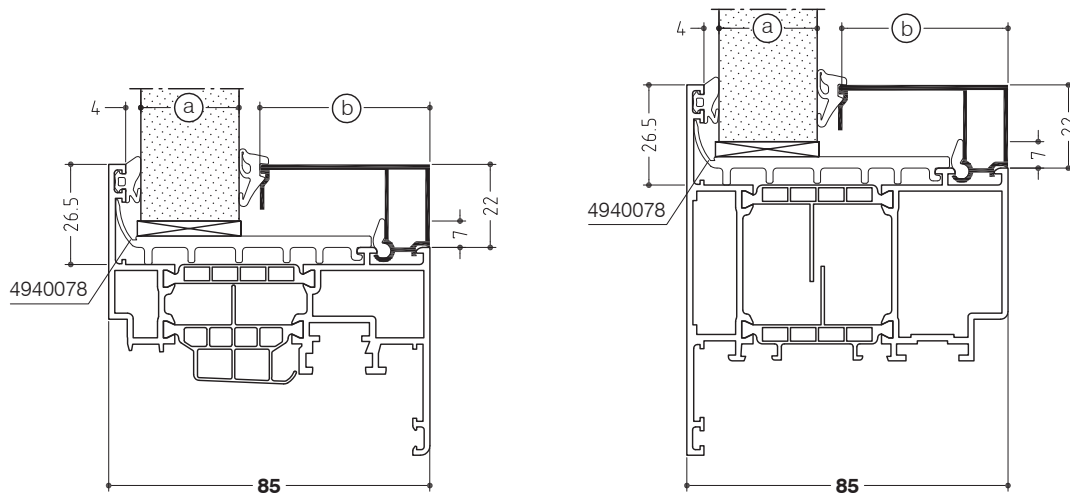

Glasleistenprofile, Auswahltabellen für Trockenverglasung
Glazing bead profiles, selection tables for dry glazing



Glasleistenprofile Glazing bead profiles		(a) Füllungsdicke ±1 mm mit Einrolldichtung Nr.: Infill thickness ±1 mm with rolled gasket no.:				
Nr. / No. 22 mm	(b) mm	4910004	4010015 blau / blue	4010016 rot / red	4010017 grün / green	4010018
3991001	2	50	49	48	47	46
3991264	5	47	46	45	44	43
3991265	9	43	42	41	40	39
3991266	12	40	39	38	37	36
3991267	15	37	36	35	34	33
3991268	19	33	32	31	30	29
3991269	22	30	29	28	27	26
3991270	24	28	27	26	25	24
3991271	26	26	25	24	23	22
3991272	29	23	22	21	20	19
3991273	32	20	19	18	17	16
3991274	34	18	17	16	15	14
3991275	37	15	14	13	12	11
3991276	41	11	10	9	8	7
3991277	45	7	6	5	4	3

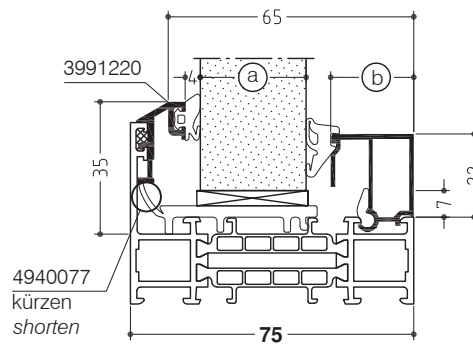
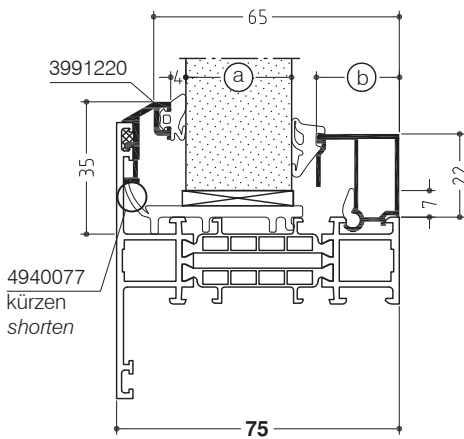

Glasleistenprofile, Auswahltabellen für Nassverglasung Glazing bead profiles, selection tables for wet glazing

Die Auswahltable zeigt die verschiedenen Glasleistenprofile und die zulässigen Füllungsdicken mit Toleranzen.

Die Auswahltable ist für Nassverglasung ausgelegt.

Bei der Verglasung sind die Vorschriften der Glashersteller und der einschlägigen Fachverbände zu beachten, insbesondere die Forderung nach einem funktions sicheren Dampfdruckausgleich und Entwässerung der Hohlräume im Glasfalzraum zwischen Isolierglas-Scheibenkante und Falzgrund.

Die Auswahltable ermöglichen eine theoretische Vorplanung. Die Glastoleranzen sind zu berücksichtigen. Bei der Montage sind die Vorgaben praktisch zu prüfen.

The selection table shows the different glazing bead profiles and the admissible infill thicknesses with tolerances.

The selection table is designed for wet glazing.

Please follow the glazing instructions of glass manufacturers and relevant professional associations, especially the demand for a functionally secure air pressure equalization and drainage of cavities in glazing rebate area between insulation glass pane edge and rebate base.

The selection tables enable a preliminary theoretical planning. The glass tolerances have to be considered while planning. Check the specifications practically.

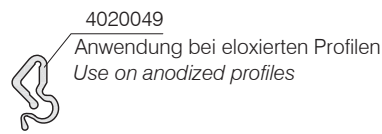
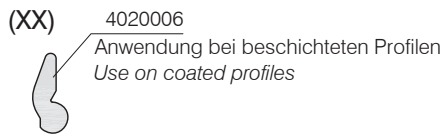

Beispiel / Example



Glasleistenprofile Glazing bead profiles		a) Füllungsdicke ±1 mm Infill thickness ±1 mm			
Nr. / No.	b) mm	Spalt / Gap 4.5 mm	Spalt / Gap 5.5 mm	Spalt / Gap 6.5 mm	Spalt / Gap 7.5 mm
3991001	2	60	59	58	57
3991264	5	57	56	55	54
3991265	9	53	52	51	50
3991266	12	50	49	48	47
3991267	15	47	46	45	44
3991268	19	43	42	41	40
3991269	22	40	39	38	37
3991270	24	38	37	36	35
3991271	26	36	35	34	33
3991272	29	33	32	31	30
3991273	32	30	29	28	27
3991274	34	28	27	26	25
3991275	37	25	24	23	22
3991276	41	21	20	19	18
3991277	45	17	16	15	14
3991278	49	13	12	11	10
3991279	52	10	9	8	7

- ① Bautiefe auswählen
Select construction depth
- ② Füllungsdicke auswählen
Select infill thickness
- ③ Entsprechende Glasleiste
Appropriate glazing bead
- ④ Entsprechendes Spaltmaß
Appropriate gap dimension

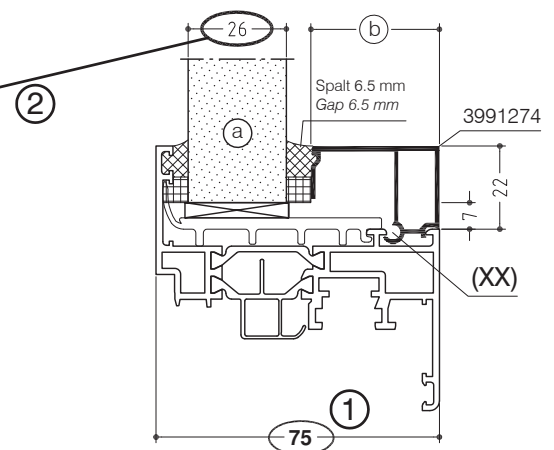

Glasleistenprofile, Auswahltabellen für Nassverglasung
Glazing bead profiles, selection tables for wet glazing



Glasleistenprofile Glazing bead profiles		(a) Füllungsdicke ±1 mm Infill thickness ±1 mm			
Nr. / No.	(b) 22 mm mm	Spalt / Gap 4.5 mm	Spalt / Gap 5.5 mm	Spalt / Gap 6.5 mm	Spalt / Gap 7.5 mm
3991001	2	60	59	58	57
3991264	5	57	56	55	54
3991265	9	53	52	51	50
3991266	12	50	49	48	47
3991267	15	47	46	45	44
3991268	19	43	42	41	40
3991269	22	40	39	38	37
3991270	24	38	37	36	35
3991271	26	36	35	34	33
3991272	29	33	32	31	30
3991273	32	30	29	28	27
3991274	34	28	27	26	25
3991275	37	25	24	23	22
3991276	41	21	20	19	18
3991277	45	17	16	15	14
3991278	49	13	12	11	10
3991279	52	10	9	8	7

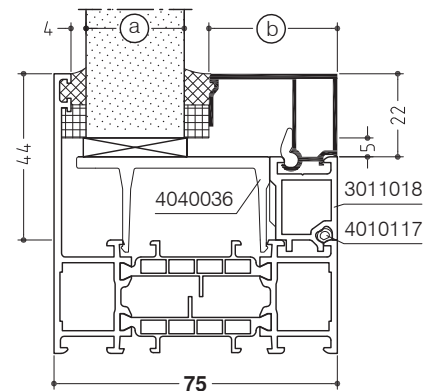
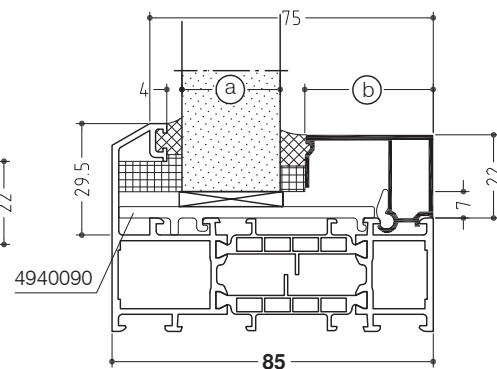
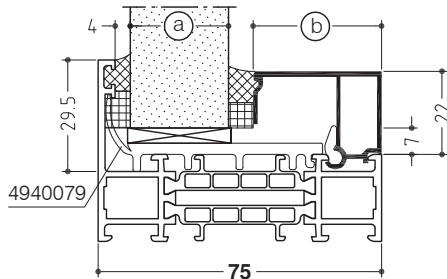
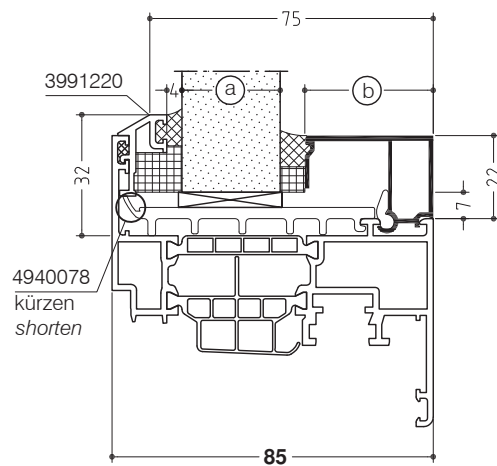

Glasleistenprofile, Auswahltabellen für Nassverglasung
Glazing bead profiles, selection tables for wet glazing



Glasleistenprofile Glazing bead profiles		(a) Füllungsdicke ±1 mm Infill thickness ±1 mm			
Nr. / No.	(b) mm	Spalt / Gap 4.5 mm	Spalt / Gap 5.5 mm	Spalt / Gap 6.5 mm	Spalt / Gap 7.5 mm
3991001	2	70	69	68	67
3991264	5	67	66	65	64
3991265	9	63	62	61	60
3991266	12	60	59	58	57
3991267	15	57	56	55	54
3991268	19	53	52	51	50
3991269	22	50	49	48	47
3991270	24	48	47	46	45
3991271	26	46	45	44	43
3991272	29	43	42	41	40
3991273	32	40	39	38	37
3991274	34	38	37	36	35
3991275	37	35	34	33	32
3991276	41	31	30	29	28
3991277	45	27	26	25	24
3991278	49	23	22	21	20
3991279	52	20	19	18	17

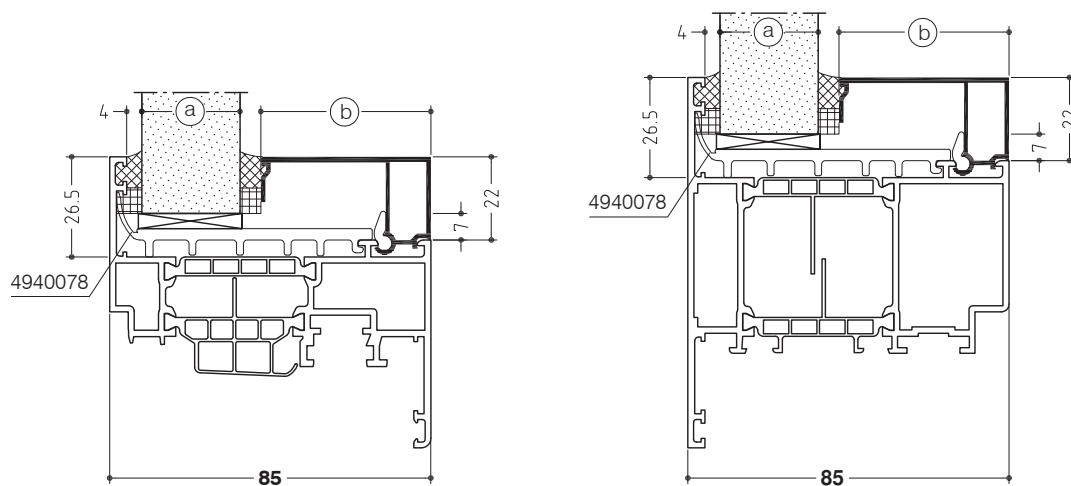

Glasleistenprofile, Auswahltabellen für Nassverglasung
Glazing bead profiles, selection tables for wet glazing



Glasleistenprofile <i>Glazing bead profiles</i>		(a) Füllungsdicke ±1 mm <i>Infill thickness ±1 mm</i>			
Nr. / No. 22 mm	(b) mm	Spalt / Gap 4.5 mm	Spalt / Gap 5.5 mm	Spalt / Gap 6.5 mm	Spalt / Gap 7.5 mm
3991001	2	50	49	48	47
3991264	5	47	46	45	44
3991265	9	43	42	41	40
3991266	12	40	39	38	37
3991267	15	37	36	35	34
3991268	19	33	32	31	30
3991269	22	30	29	28	27
3991270	24	28	27	26	25
3991271	26	26	25	24	23
3991272	29	23	22	21	20
3991273	32	20	19	18	17
3991274	34	18	17	16	15
3991275	37	15	14	13	12
3991276	41	11	10	9	8
3991277	45	7	6	5	4

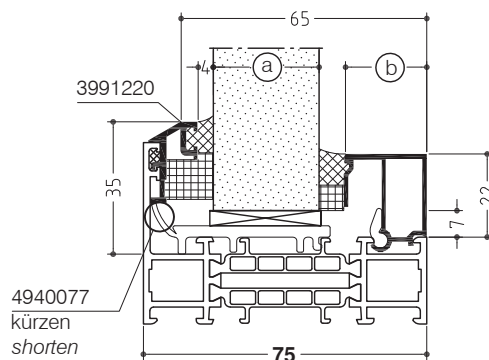
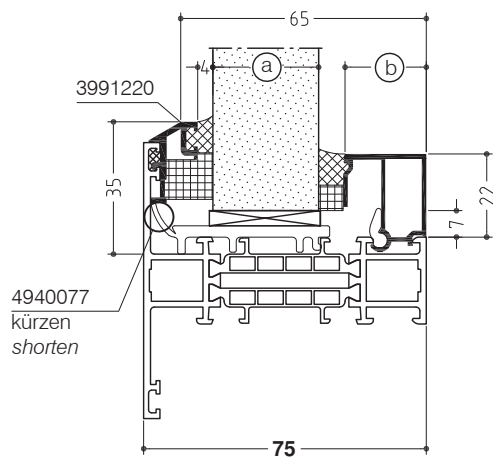

Glasleistenprofile, Auswahltabellen für Nassverglasung
Glazing bead profiles, selection tables for wet glazing



Glasleistenprofile Glazing bead profiles		a) Füllungsdicke ± 1 mm Infill thickness ± 1 mm			
Nr. / No. 22 mm	b) mm	Spalt / Gap 4.5 mm	Spalt / Gap 5.5 mm	Spalt / Gap 6.5 mm	Spalt / Gap 7.5 mm
3991001	2	60	59	58	57
3991264	5	57	56	55	54
3991265	9	53	52	51	50
3991266	12	50	49	48	47
3991267	15	47	46	45	44
3991268	19	43	42	41	40
3991269	22	40	39	38	37
3991270	24	38	37	36	35
3991271	26	36	35	34	33
3991272	29	33	32	31	30
3991273	32	30	29	28	27
3991274	34	28	27	26	25
3991275	37	25	24	23	22
3991276	41	21	20	19	18
3991277	45	17	16	15	14
3991278	49	13	12	11	10
3991279	52	10	9	8	7

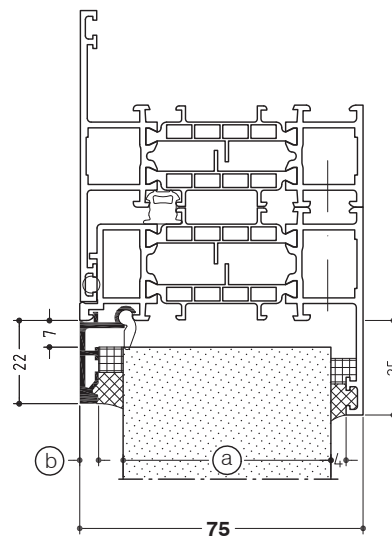

	Seite Page
Verdeckte Beschläge <i>Concealed fittings</i>	
Zulässige Flügelgrößen, sichtbarer Flügel <i>Admissible sash sizes, visible sash</i>	3/190
Zulässige Flügelgrößen, verdeckter Flügel <i>Admissible sash sizes, concealed sash</i>	3/205
Zulässige Formatgrößen <i>Admissible format sizes</i>	3/214
Beschlagsübersichten <i>Survey of fittings</i>	3/226

WICLINE 75

Verdeckte Beschläge
Concealed fittings



Zulässige Flügelgrößen
Admissible sash sizes



		1917101				1917102				1917103 (1910146)				1917104 (1910147)				
	(Pa)	800	1200	2000	-	800	1200	2000	2000	800	1200	2000	2000*	800	1200	2000*	-	
	(Pa)	150	300	600	-	150	300	600	600	150	300	600	600	150	300	600	-	
max.	FAB (m)	1.3	1.2	1.1	-	1.6	1.5	1.4	1.0	1.6	1.6	1.5	1.0	1.7	1.7	1.6	-	
	FAH (m)	1.7	1.7	1.7	-	2.0	2.0	2.0	2.25	2.25	2.25	2.25	2.5	2.5	2.5	2.5	-	
min.	FAB (m)	0.45	0.45	0.45	-	0.45	0.45	0.45	0.45	0.45	0.45	0.45	0.45	0.45	0.45	0.45	-	
	FAH (m)	0.6	0.6	0.6	-	0.6	0.6	0.6	0.6	0.6	0.6	0.6	0.6	0.6	0.6	0.6	-	
MV / MB	FAB (m)	-	-	-	-	-	-	1.3	-	-	-	1.3	-	-	-	1.3	-	
	FAH (m)	1.5	1.5	1.3	-	1.7	1.6	1.5	1.5	1.8	1.7	1.6	1.5*	1.8	1.7	1.6*	-	
	min.	FAB (m)	0.45	0.45	0.45	-	0.45	0.45	0.45	0.45	0.45	0.45	0.45	0.45	0.45	0.45	0.45	-
	FAH (m)	0.83	0.83	0.83	-	0.83	0.83	0.83	0.83	0.83	0.83	0.83	0.83	0.83	0.83	0.83	-	
	min.	FAB (m)	0.65	0.65	0.65	-	0.65	0.65	0.65	0.65	0.65	0.65	0.65	0.65	0.65	0.65	0.65	-
	FAH (m)	0.9	0.9	0.9	-	0.9	0.9	0.9	0.9	0.9	0.9	0.9	0.9	0.9	0.9	0.9	-	
	max.(kg)									160								

* Windlast > 1600 Pa und FAH > 2.25 m werden zwei vertikale Zusatzverriegelungen benötigt

* Wind load > 1600 Pa and FAH 2.25 m requires two vertical additional locking pinpoints

WICLINE 75

Verdeckte Beschläge
Concealed fittings



Zulässige Flügelgrößen
Admissible sash sizes

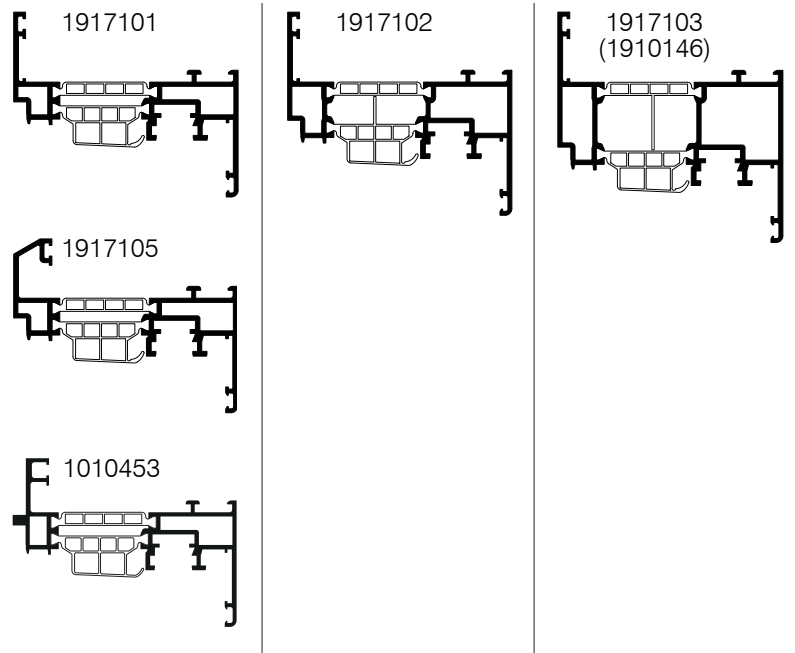

	(Pa)	1600	-	-	-	1600	1600	-	-	1600	1600	-	-					
	(Pa)	600	-	-	-	600	600	-	-	600	600	-	-					
	max.	FAB (m)	1.1	-	-	-	1.3	1.0	-	-	1.3	1.0	-	-				
		FAH (m)	1.7	-	-	-	2.0	2.25	-	-	2.25	2.5	-	-				
	min.	FAB (m)	0.45	-	-	-	0.45	0.45	-	-	0.45	0.45	-	-				
		FAH (m)	0.6*	-	-	-	0.6*	0.6*	-	-	0.6*	0.6*	-	-				
MV / MB		FAB (m)	-	-	-	-	-	-	-	-	-	-	-					
		FAH (m)	1.3	-	-	-	1.5	1.5	-	-	1.6	1.5	-	-				
	min.	FAB (m)	-	-	-	-	-	-	-	-	-	-	-					
		FAH (m)	-	-	-	-	-	-	-	-	-	-	-	-				
	min.	FAB (m)	-	-	-	-	-	-	-	-	-	-	-					
		FAH (m)	-	-	-	-	-	-	-	-	-	-	-	-				
	max.(kg)		100				160				160							

* FAH_{min.} begrenzt über FAH1_{min.} = 0.6 m
*FAH_{min.} limited through FAH1_{min.} = 0.6 m



FAB1_{min.} = 0.3 m

WICLINE 75

Verdeckte Beschläge
Concealed fittings



Zulässige Flügelgrößen
Admissible sash sizes



		1917101				1917102				1917103 (1910146)				1917104 (1910147)				
	(Pa) (m ²)**	800	1200	1600 (1.5)**	-	800	1200	1600 (1.7)**	1600 (1.7)**	800	1200	1600 (1.8)**	1600* (1.8)**	800	1200	1600* (2.0)**	-	
	(Pa)	150	300	600	-	150	300	600	600	150	300	600	600	150	300	450	-	
max.	FAB (m)	1.3	1.2	1.1	-	1.6	1.5	1.4	1.0	1.6	1.6	1.5	1.0	1.7	1.7	1.6	-	
	FAH (m)	1.7	1.7	1.7	-	2.0	2.0	2.0	2.25	2.25	2.25	2.25	2.5	2.5	2.5	2.5	-	
min.	FAB (m)	0.45	0.45	0.45	-	0.45	0.45	0.45	0.45	0.45	0.45	0.45	0.45	0.45	0.45	0.45	-	
	FAH (m)	0.68	0.68	0.68	-	0.68	0.68	0.68	0.68	0.68	0.68	0.68	0.68	0.68	0.68	0.68	-	
MV / MB	FAB (m)	-	-	-	-	-	-	1.3	-	1.3	1.3	1.3	-	1.3	1.3	1.3	-	
	FAH (m)	1.5	1.5	1.3	-	1.7	1.6	1.5	1.5	1.8	1.7	1.6	1.5*	1.8	1.7	1.6*	-	
	min.	FAB (m)	0.65	0.65	0.65	-	0.65	0.65	0.65	0.65	0.65	0.65	0.65	0.65	0.65	0.65	0.65	-
	FAH (m)	1.05	1.05	1.05	-	1.05	1.05	1.05	1.05	1.05	1.05	1.05	1.05	1.05	1.05	1.05	-	
	min.	FAB (m)	0.65	0.65	0.65	-	0.65	0.65	0.65	0.65	0.65	0.65	0.65	0.65	0.65	0.65	0.65	-
	FAH (m)	1.12	1.12	1.12	-	1.12	1.12	1.12	1.12	1.12	1.12	1.12	1.12	1.12	1.12	1.12	-	
	max. (kg)									160								

* Windlast > 1200 Pa und FAH > 2.25 m werden zwei vertikale Zusatzverriegelungen benötigt

* Wind load > 1200 Pa and FAH 2.25 m requires two vertical additional locking points

** Flügelgröße > () m² benötigt eine horizontale Zusatzverriegelung

** Sash size > () m² requires a horizontal additional locking point

WICLINE 75

Verdeckte Beschläge
Concealed fittings



Zulässige Flügelgrößen
Admissible sash sizes



		1917101				1917102				1917103 (1910146)				1917104 (1910147)			
	(Pa)	800	1200	1600 (1.5)**	-	800	1200	1600 (1.7)**	1600 (1.7)**	800	1200	1600 (1.8)**	1600 (1.8)**	800	1200	1600 (2.0)**	-
	(Pa)	150	300	600	-	150	300	600	600	150	300	600	600	150	300	600	-
max.	FAB (m)	1.2	1.2	1.2	-	1.3	1.3	1.3	1.0	1.3	1.3	1.3	1.0	1.3	1.3	1.3	-
	FAH (m)	1.7	1.6	1.5	-	1.9	1.8	1.7	2.25	2.0	1.9	1.7	2.25	2.25	2.25	2.25	-
min.	FAB (m)	0.45	0.45	0.45	-	0.45	0.45	0.45	0.45	0.45	0.45	0.45	0.45	0.45	0.45	0.45	-
	FAH (m)	0.72	0.72	0.72	-	0.72	0.72	0.72	0.72	0.72	0.72	0.72	0.72	0.72	0.72	0.72	-
MV / MB	FAB (m)	-	-	-	-	-	-	-	-	-	-	-	-	-	-	-	-
	FAH (m)	1.5	1.5	1.3	-	1.7	1.6	1.5	1.5	1.8	1.7	1.6	1.5	1.8	1.7	1.6	-
	min.	FAB (m)	-	-	-	-	-	-	-	-	-	-	-	-	-	-	-
	FAH (m)	-	-	-	-	-	-	-	-	-	-	-	-	-	-	-	-
	min.	FAB (m)	-	-	-	-	-	-	-	-	-	-	-	-	-	-	-
	FAH (m)	-	-	-	-	-	-	-	-	-	-	-	-	-	-	-	-
	max. (kg)					100				160							

** Flügelgröße > () m² benötigt eine horizontale Zusatzverriegelung am Gehflügel
** Sash size > () m² requires a horizontal additional locking point in active leaf

WICLINE 75

Verdeckte Beschläge
Concealed fittings



Zulässige Flügelgrößen Admissible sash sizes



		1917101			
1917120					
	(Pa)	800	1200	-	-
	(Pa)	300	600	-	-
max.	FAB (m)	1.2	1.2	-	-
	FAH (m)	1.6	1.5	-	-
min.	FAB (m)	0.45	0.45	-	-
	FAH (m)	0.72	0.72	-	-
MV / MB	FAB (m)	-	-	-	-
	FAH (m)	1.4	1.3	-	-
	min.	FAB (m)	-	-	-
		FAH (m)	-	-	-
	min.	FAB (m)	-	-	-
		FAH (m)	-	-	-
	max.(kg)			100	

		1917105			
1917122					
	(Pa)	800	1200	-	-
	(Pa)	300	600	-	-
max.	FAB (m)	1.2	1.2	-	-
	FAH (m)	1.6	1.5	-	-
min.	FAB (m)	0.45	0.45	-	-
	FAH (m)	0.72	0.72	-	-
MV / MB	FAB (m)	-	-	-	-
	FAH (m)	1.4	1.3	-	-
	min.	FAB (m)	-	-	-
		FAH (m)	-	-	-
	min.	FAB (m)	-	-	-
		FAH (m)	-	-	-
	max.(kg)			100	

WICLINE 75

Verdeckte Beschläge
Concealed fittings



Zulässige Flügelgrößen
Admissible sash sizes

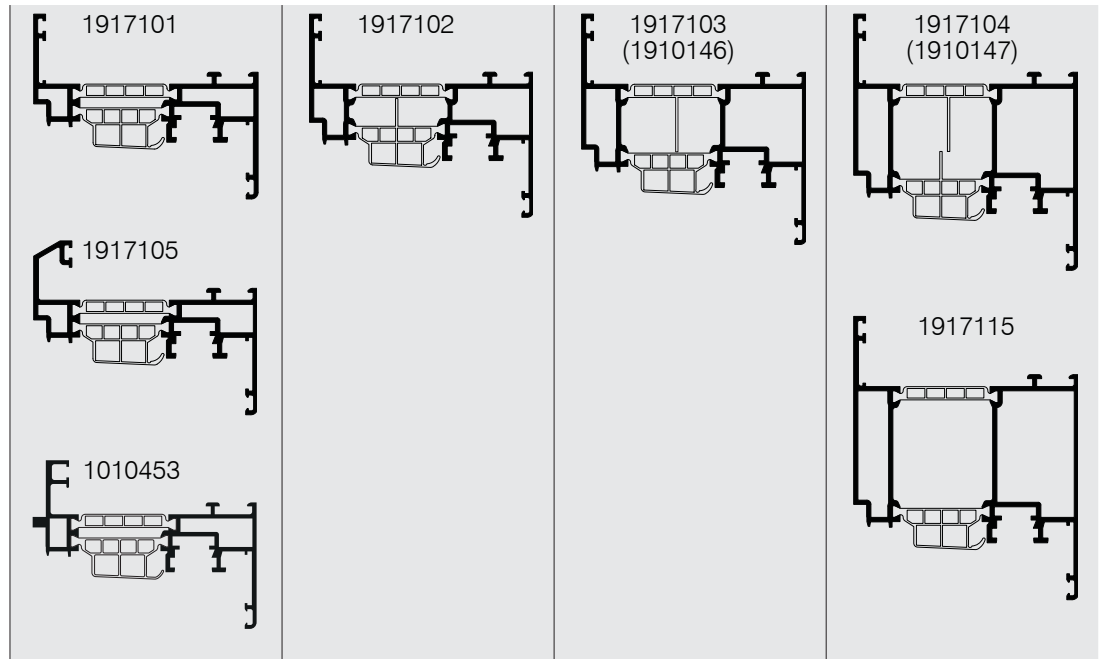

	(Pa)	800	1200	2000	-	800	1200	2000	2000	800	1200	2000	2000*	800	1200	2000*	-	
	(Pa)	150	300	600	-	150	300	600	600	150	300	600	600	150	300	600	-	
	max.	FAB (m)	1.3	1.2	1.1	-	1.6	1.5	1.4	1.0	1.6	1.6	1.5	1.0	1.7	1.7	1.6	-
		FAH (m)	1.7	1.7	1.7	-	2.0	2.0	2.0	2.25	2.25	2.25	2.5	2.5	2.5	2.5	2.5	-
	min.	FAB (m)	0.425	0.425	0.425	-	0.425	0.425	0.425	0.425	0.425	0.425	0.425	0.425	0.425	0.425	0.425	-
		FAH (m)	0.7	0.7	0.7	-	0.7	0.7	0.7	0.7	0.7	0.7	0.7	0.7	0.7	0.7	0.7	-
MV / MB		FAB (m)	-	-	-	-	-	-	1.3	-	-	-	1.3	-	-	-	1.3	-
		FAH (m)	1.5	1.5	1.3	-	1.7	1.6	1.5	1.5	1.8	1.7	1.6	1.5*	1.8	1.7	1.6*	-
	min.	FAB (m)	0.425	0.425	0.425	-	0.425	0.425	0.425	0.425	0.425	0.425	0.425	0.425	0.425	0.425	0.425	-
		FAH (m)	0.7	0.7	0.7	-	0.7	0.7	0.7	0.7	0.7	0.7	0.7	0.7	0.7	0.7	0.7	-
	min.	FAB (m)	0.68	0.68	0.68	-	0.68	0.68	0.68	0.68	0.68	0.68	0.68	0.68	0.68	0.68	0.68	-
		FAH (m)	0.9	0.9	0.9	-	0.9	0.9	0.9	0.9	0.9	0.9	0.9	0.9	0.9	0.9	0.9	-
	max. (kg)		100			130				130				130				

* Windlast > 1600 Pa und FAH > 2.25 m werden zwei vertikale Zusatzverriegelungen benötigt

* Wind load > 1600 Pa and FAH 2.25 m requires two vertical additional locking points

WICLINE 75

Verdeckte Beschläge
Concealed fittings



Zulässige Flügelgrößen
Admissible sash sizes



		1917101				1917102				1917103 (1910146)				1917104 (1910147)				
	(Pa)	800	1200	2000	-	800	1200	2000	2000	800	1200	2000	2000*	800	1200	2000*	-	
	(Pa)	150	300	600	-	150	300	600	600	150	300	600	600	150	300	600	-	
	max.	FAB (m)	1.7	1.7	1.7	-	2.0	2.0	2.0	2.25	2.25	2.25	2.25	2.5	2.5	2.5	2.5	-
		FAH (m)	1.3	1.2	1.1	-	1.6	1.5	1.4	1.0	1.6	1.6	1.5	1.0	1.7	1.7	1.6	-
	min.	FAB (m)	0.6	0.6	0.6	-	0.6	0.6	0.6	0.6	0.6	0.6	0.6	0.6	0.6	0.6	0.6	-
		FAH (m)	0.45	0.45	0.45	-	0.45	0.45	0.45	0.45	0.45	0.45	0.45	0.45	0.45	0.45	0.45	-
MV / MB		FAB (m)	1.5	1.5	1.3	-	1.7	1.6	1.5	1.5	1.8	1.7	1.6	1.5*	1.8	1.7	1.6*	-
		FAH (m)	-	-	-	-			1.3	-	-	-	1.3	-	-	-	1.3	-
	min.	FAB (m)	0.74	0.74	0.74	-	0.74	0.74	0.74	0.74	0.74	0.74	0.74	0.74	0.74	0.74	0.74	-
		FAH (m)	0.45	0.45	0.45	-	0.45	0.45	0.45	0.45	0.45	0.45	0.45	0.45	0.45	0.45	0.45	-
	min.	FAB (m)	0.9	0.9	0.9	-	0.9	0.9	0.9	0.9	0.9	0.9	0.9	0.9	0.9	0.9	0.9	-
		FAH (m)	0.6	0.6	0.6	-	0.6	0.6	0.6	0.6	0.6	0.6	0.6	0.6	0.6	0.6	0.6	-
	max.(kg)		100			130				130				130				

* Windlast > 1600 Pa und FAB > 2.25 m werden zwei horizontale Zusatzverriegelungen benötigt

* Wind load > 1600 Pa and FAB 2.25 m requires two horizontal additional locking points

WICLINE 75

Verdeckte Beschläge
Concealed fittings



Zulässige Flügelgrößen
Admissible sash sizes



		1917101				1917102				1917103 (1910146)								
	(Pa)	800	1200	1600	-	800	1200	1600	-	800	1200	1600	-					
	(Pa)	150	300	600	-	150	300	600	-	150	300	600	-					
	max.	FAB (m)	1.7	1.7	1.7	-	2.0	2.0	2.0	-	2.0	2.0	2.0	-				
		FAH (m)	1.3	1.2	1.1	-	1.6	1.5	1.3	-	1.6	1.6	1.3	-				
	min.	FAB (m)	0.55	0.55	0.55	-	0.55	0.55	0.55	-	0.55	0.55	0.55	-				
		FAH (m)	0.51	0.51	0.51	-	0.51	0.51	0.51	-	0.51	0.51	0.51	-				
MV / MB		FAB (m)	1.5	1.5	1.3	-	1.7	1.6	1.5	-	1.8	1.7	1.6	-				
		FAH (m)	-	-	-	-	-	-	-	-	-	-	-	-				
	min.	FAB (m)	-	-	-	-	-	-	-	-	-	-	-	-				
		FAH (m)	-	-	-	-	-	-	-	-	-	-	-	-				
	min.	FAB (m)	-	-	-	-	-	-	-	-	-	-	-	-				
		FAH (m)	-	-	-	-	-	-	-	-	-	-	-	-				
	max.(kg)		80			80 / 120												

WICLINE 75

Verdeckte Beschläge
Concealed fittings



Zulässige Flügelgrößen
Admissible sash sizes



		1917101				1917102				1917103 (1910146)				1917104 (1910147)				
	(Pa)	800	1200	2000	-	800	1200	2000	2000	800	1200	2000	2000*	800	1200	2000*	-	
	(Pa)	150	300	600	-	150	300	600	600	150	300	600	600	150	300	600	-	
	max.	FAB (m)	1.7	1.7	1.7	-	2.0	2.0	2.0	2.25	2.25	2.25	2.25	2.5	2.5	2.5	2.5	-
		FAH (m)	1.3	1.2	1.1	-	1.6	1.5	1.4	1.0	1.6	1.6	1.5	1.0	1.7	1.7	1.6	-
	min.	FAB (m)	0.55	0.55	0.55	-	0.55	0.55	0.55	0.55	0.55	0.55	0.55	0.55	0.55	0.55	0.55	-
		FAH (m)	0.51	0.51	0.51	-	0.51	0.51	0.51	0.51	0.51	0.51	0.51	0.51	0.51	0.51	0.51	-
MV / MB		FAB (m)	1.5	1.5	1.3	-	1.7	1.6	1.5	1.5	1.8	1.7	1.6	1.5*	1.8	1.7	1.6*	-
		FAH (m)	-	-	-	-			1.3	-	-	-	1.3	-	-	-	1.3	-
	min.	FAB (m)	-	-	-	-	-	-	-	-	-	-	-	-	-	-	-	-
		FAH (m)	-	-	-	-	-	-	-	-	-	-	-	-	-	-	-	-
	min.	FAB (m)	-	-	-	-	-	-	-	-	-	-	-	-	-	-	-	-
		FAH (m)	-	-	-	-	-	-	-	-	-	-	-	-	-	-	-	-
	max.(kg)		80			80 / 120												

* Windlast > 1600 Pa und FAB > 2.25 m werden zwei horizontale Zusatzverriegelungen benötigt

* Wind load > 1600 Pa and FAB 2.25 m requires two horizontal additional locking points

WICLINE 75

Verdeckte Beschläge
Concealed fittings



Zulässige Flügelgrößen
Admissible sash sizes

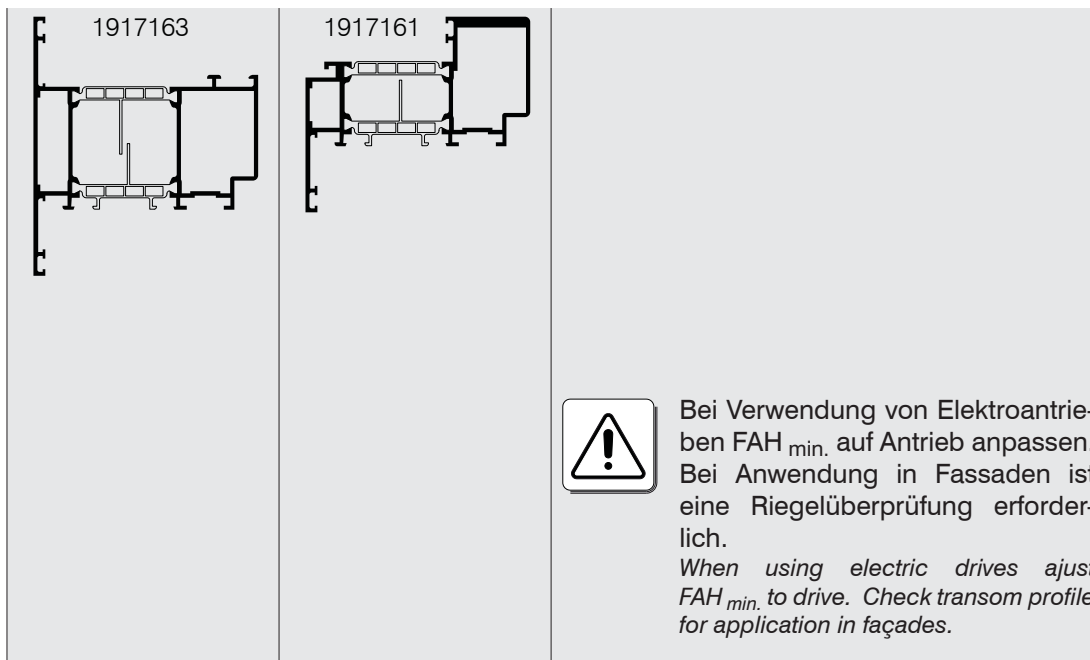

Bei Verwendung von Elektroantrieben FAH_{min.} auf Antrieb anpassen. Bei Anwendung in Fassaden ist eine Riegelüberprüfung erforderlich.

When using electric drives adjust FAH_{min.} to drive. Check transom profile for application in façades.

	(Pa)	-	-	2000	2000	-	2000	2000	2000											
	(Pa)	-	-	600	600	-	600	600	600											
max.	FAB (m)	-	-	2.2	2.0	-	1.4	1.8	1.4											
	FAH (m)	-	-	2.0	2.2	-	1.4	1.4	1.8											
min.	FAB (m)	-	-	0.6	0.6	-	0.6	0.6	0.6											
	FAH (m)	-	-	0.5**	0.5**	-	0.5**	0.5**	0.5**											
MV / MB	FAB (m)	-	-	1.5*	1.5*	-	-	1.4	-											
	FAH (m)	-	-	1.5	1.5	-	-	-	1,4											
	min.	FAB (m)	-	-	-	-	-	-	-											
	FAH (m)	-	-	-	-	-	-	-	-											
	min.	FAB (m)	-	-	-	-	-	-	-											
	FAH (m)	-	-	-	-	-	-	-	-											
	max. (kg)			150***			120		100											

* FAB > 1.8 m werden oben zwei horizontale Zusatzverriegelungen benötigt
* FAB > 1.8 m requires two horizontal additional top locking points

** FAH_{min.} > 0.65 m Rastschere möglich!

** FAH_{min.} > 0.65 m opening limiter with catch possible!

*** Zusätzliche Verklebung > 120 kg
*** Additional gluing > 120 kg



FAH ≤ 2.5 x FAB

WICLINE 75

Verdeckte Beschläge
Concealed fittings



Zulässige Flügelgrößen
Admissible sash sizes

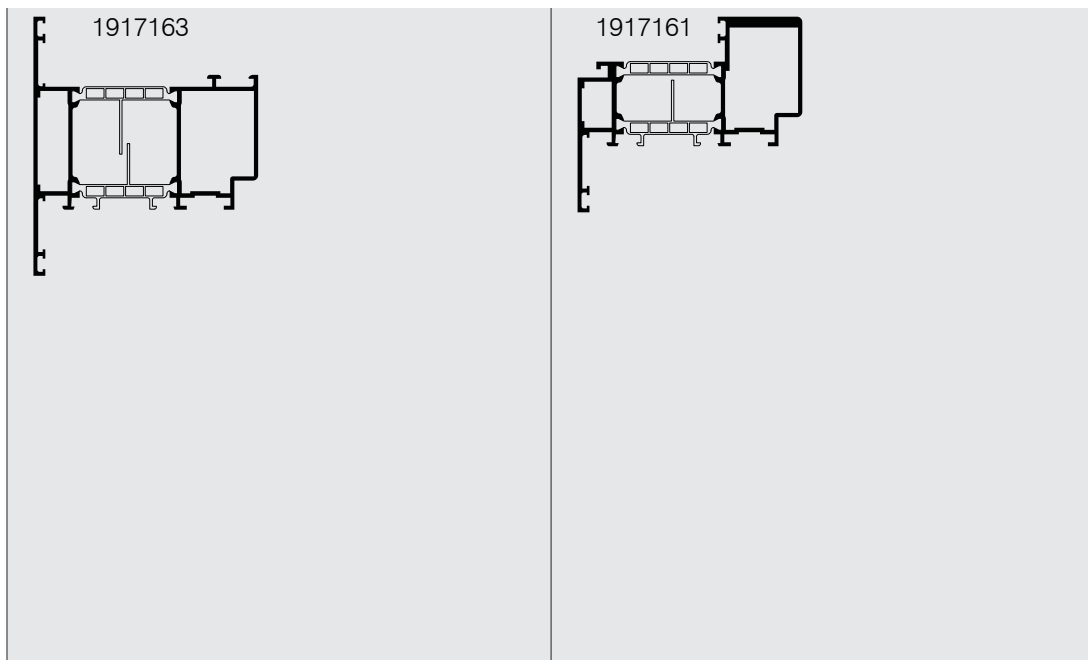

	(Pa)	-	2000	2000	2000	-	-	2000	2000	-	2000	2000	2000	-	2000	2000	2000	
	(Pa)	-	600	600	600	-	-	600	600	-	600	600	600	-	600	600	600	
	max.	FAB (m)	-	2.5	2.4	2.3	-	-	2.0	2.0	-	2.3	2.2	2.1	-	2.0	1.9	1.8
		FAH (m)	-	1.4	1.6	1.8	-	-	2.2	2.2	-	1.0	1.1	1.2	-	1.4	1.6	1.8
	min.	FAB (m)	-	0.7	0.7	0.7	-	-	0.7	0.7	-	0.7	0.7	0.7	-	0.7	0.7	0.7
		FAH (m)	-	0.7	0.7	0.7	-	-	0.7	0.7	-	0.7	0.7	0.7	-	0.7	0.7	0.7
MV / MB		FAB (m)	-	1.5	1.5	1.5	-	-	1.5	1.5	-	1.4	1.4	1.4	-	1.4	1.4	1.4
		FAH (m)	-	-	-	-	-	-	-	-	-	-	-	-	-	-	-	-
	min.	FAB (m)	-	-	-	-	-	-	-	-	-	-	-	-	-	-	-	-
		FAH (m)	-	-	-	-	-	-	-	-	-	-	-	-	-	-	-	-
	min.	FAB (m)	-	-	-	-	-	-	-	-	-	-	-	-	-	-	-	-
		FAH (m)	-	-	-	-	-	-	-	-	-	-	-	-	-	-	-	-
	max.(kg)		120			150			80			100						

WICLINE 75

Verdeckte Beschläge
Concealed fittings



Zulässige Flügelgrößen
Admissible sash sizes



		1917163				1917161												
		(Pa)	800	800	-	-	800	800	-	-								
		(Pa)	150	150	-	-	150	150	-	-								
	max.	FAB (m)	2.0	1.8	-	-	1.8	1.6	-	-								
		FAH (m)	2.0	2.2	-	-	1.8	1.9	-	-								
	min.	FAB (m)	0.7	0.7	-	-	0.7	0.7	-	-								
		FAH (m)	0.7	0.7	-	-	0.7	0.7	-	-								
MV / MB		FAB (m)	-	-	-	-	-	-	-	-								
		FAH (m)	1.5	1.5	-	-	1.4	1.4	-	-								
	min.	FAB (m)	-	-	-	-	-	-	-	-								
		FAH (m)	-	-	-	-	-	-	-	-								
	min.	FAB (m)	-	-	-	-	-	-	-	-								
		FAH (m)	-	-	-	-	-	-	-	-								
	max.	max.(kg)	120				100											

WICLINE 75

Verdeckte Beschläge,
Fenstertür einwärts
*Concealed fittings,
casement door inwards*



Zulässige Flügelgrößen
Admissible sash sizes



		 1917104 (1910147)															
		 1917115															
	(Pa)	800	1200	1600	2000*												
	(Pa)	150	300	600	600												
max.	FAB (m)	1.7	1.7	1.6	1.6												
	FAH (m)	2.5	2.5	2.5	2.5												
min.	FAB (m)	0.45	0.45	0.45	0.45												
	FAH (m)	0.95	0.95	0.95	0.95												
MV / MB	FAB (m)	-	-	-	1.3												
	FAH (m)	1.8	1.7	1.6	1.6*												
	min.	FAB (m)	-	-	-	-											
		FAH (m)	-	-	-	-											
	min.	FAB (m)	-	-	-	-											
		FAH (m)	-	-	-	-											
	max.(kg)	160															

* Windlast > 1200 Pa und FAH > 2.25 m werden zwei vertikale Zusatzverriegelung benötigt

* Wind load > 1200 Pa and FAH > 2.25 m requires two vertical additional locking points

WICLINE 75

Verdeckte Beschläge,
Fenstertür einwärts
*Concealed fittings,
casement door inwards*



Zulässige Flügelgrößen
Admissible sash sizes

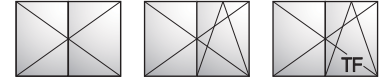

	(Pa)	800	1200	1600* (2.0)**	-									
	(Pa)	150	300	600	-									
max.	FAB (m)	1.7	1.7	1.6	-									
	FAH (m)	2.5	2.5	2.5	-									
min.	FAB (m)	0.45	0.45	0.45	-									
	FAH (m)	0.95	0.95	0.95	-									
MV / MB	FAB (m)	1.3	1.3	1.3	-									
	FAH (m)	1.8	1.7	1.6*	-									
	min.	FAB (m)	-	-	-									
	FAH (m)	-	-	-	-									
	min.	FAB (m)	-	-	-									
	FAH (m)	-	-	-	-									
	max. (kg)	160												

* Windlast > 1200 Pa und FAH > 2.25 m werden zwei vertikale Zusatzverriegelung benötigt
 * Wind load > 1200 Pa and FAH > 2.25 m requires two vertical additional locking points

** Flügelgröße > () m² benötigt eine horizontale Zusatzverriegelung am Gehflügel und Standflügel
 ** Sash size > () m² requires a horizontal additional locking points in active leaf and inactive leaf

WICLINE 75

Verdeckte Beschläge,
Fenstertür einwärts
*Concealed fittings,
casement door inwards*



Zulässige Flügelgrößen
Admissible sash sizes

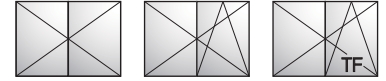

	(Pa)	800	1200	1600 (2.0)**	-														
	(Pa)	150	300	600	-														
max.	FAB (m)	1.3	1.3	1.3	-														
	FAH (m)	2.25	2.25	2.25	-														
min.	FAB (m)	0.45	0.45	0.45	-														
	FAH (m)	0.95	0.95	0.95	-														
MV / MB	FAB (m)	1.3	1.3	1.3	-														
	FAH (m)	1.8	1.7	1.6	-														
	min.	FAB (m)	-	-	-	-													
		FAH (m)	-	-	-	-													
	min.	FAB (m)	-	-	-	-													
		FAH (m)	-	-	-	-													
	max.(kg)	160																	

** Flügelgröße > ()m² benötigt eine horizontale Zusatzverriegelung am Gehflügel
 ** Sash size > ()m² requires a horizontal additional locking points in active leaf

WICLINE 75

Verdeckte Beschläge
Concealed fittings



Zulässige Flügelgrößen
Admissible sash sizes



		1917110				1917111				1917112				1917113				
	(Pa)	800	1200	2000	-	800	1200	2000	-	800	1200	2000	-	800	1200	2000	-	
	(Pa)	150	300	600	-	150	300	600	-	150	300	600	-	150	300	600	-	
	max.	FAB (m)	1.2	1.1	1.0	-	1.3	1.2	1.1	-	1.4	1.3	1.2	-	1.4	1.4	1.3	-
		FAH (m)	1.4	1.4	1.4	-	1.6	1.6	1.6	-	1.7	1.7	1.7	-	1.8	1.8	1.8	-
	min.	FAB (m)	0.45	0.45	0.45	-	0.45	0.45	0.45	-	0.45	0.45	0.45	-	0.45	0.45	0.45	-
		FAH (m)	0.6	0.6	0.6	-	0.6	0.6	0.6	-	0.6	0.6	0.6	-	0.6	0.6	0.6	-
MV / MB		FAB (m)	-	-	-	-	-	-	-	-	-	-	-	-	-	-	-	-
		FAH (m)	1.3	1.2	1.1	-	1.4	1.3	1.2	-	1.5	1.4	1.3	-	1.5	1.5	1.4	-
	min.	FAB (m)	0.45	0.45	0.45	-	0.45	0.45	0.45	-	0.45	0.45	0.45	-	0.45	0.45	0.45	-
		FAH (m)	0.83	0.83	0.83	-	0.83	0.83	0.83	-	0.83	0.83	0.83	-	0.83	0.83	0.83	-
	min.	FAB (m)	0.65	0.65	0.65	-	0.65	0.65	0.65	-	0.65	0.65	0.65	-	0.65	0.65	0.65	-
		FAH (m)	0.9	0.9	0.9	-	0.9	0.9	0.9	-	0.9	0.9	0.9	-	0.9	0.9	0.9	-
	max.(kg)	80				100				100				100				

WICLINE 75

Verdeckte Beschläge
Concealed fittings



Zulässige Flügelgrößen
Admissible sash sizes



		1917112				1917113												
	(Pa)	800	1200	2000	-	800	1200	2000	-									
	(Pa)	150	300	600	-	150	300	600	-									
	max.	FAB (m)	1.4	1.3	1.2	-	1.4	1.4	1.3	-								
		FAH (m)	1.8	2.0	2.1	-	2.0	2.0	2.25	-								
	min.	FAB (m)	0.45	0.45	0.45	-	0.45	0.45	0.45	-								
		FAH (m)	0.6	0.6	0.6	-	0.6	0.6	0.6	-								
MV / MB		FAB (m)	-	-	-	-	-	-	-	-								
		FAH (m)	1.5	1.4	1.3	-	1.5	1.5	1.4	-								
	min.	FAB (m)	0.45	0.45	0.45	-	0.45	0.45	0.45	-								
		FAH (m)	0.83	0.83	0.83	-	0.83	0.83	0.83	-								
	min.	FAB (m)	0.65	0.65	0.65	-	0.65	0.65	0.65	-								
		FAH (m)	0.9	0.9	0.9	-	0.9	0.9	0.9	-								
	max. (kg)	130***				130***												

*** Zusätzliche Verklebung, Angaben in den Verarbeitungsrichtlinien beachten!
*** Additional gluing, pay attention to specifications in the workshop manual!

WICLINE 75

Verdeckte Beschläge
Concealed fittings



Zulässige Flügelgrößen Admissible sash sizes



		1917110				
		1917124				
	(Pa)	400	800	1200	-	
	(Pa)	150	300	600	-	
max.	FAB (m)	1.2	1.1	1.0	-	
	FAH (m)	1.4	1.4	1.3	-	
min.	FAB (m)	0.45	0.45	0.45	-	
	FAH (m)	0.72	0.72	0.72	-	
MV / MB	FAB (m)	-	-	-	-	
	FAH (m)	1.3	1.2	1.1	-	
	min.	FAB (m)	-	-	-	-
		FAH (m)	-	-	-	-
	min.	FAB (m)	-	-	-	-
		FAH (m)	-	-	-	-
	max.(kg)	80				

		1917111				
		1917126				
	(Pa)	400	800	1200	-	
	(Pa)	150	300	600	-	
max.	FAB (m)	1.3	1.2	1.1	-	
	FAH (m)	1.6	1.6	1.5	-	
min.	FAB (m)	0.45	0.45	0.45	-	
	FAH (m)	0.72	0.72	0.72	-	
MV / MB	FAB (m)	-	-	-	-	
	FAH (m)	1.4	1.3	1.2	-	
	min.	FAB (m)	-	-	-	-
		FAH (m)	-	-	-	-
	min.	FAB (m)	-	-	-	-
		FAH (m)	-	-	-	-
	max.(kg)	100				

WICLINE 75

Verdeckte Beschläge
Concealed fittings



Zulässige Flügelgrößen
Admissible sash sizes



		1917110				1917111				1917112				1917113				
	(Pa)	800	1200	2000	-	800	1200	2000	-	800	1200	2000	-	800	1200	2000	-	
	(Pa)	150	300	600	-	150	300	600	-	150	300	600	-	150	300	600	-	
	max.	FAB (m)	1.2	1.1	1.0	-	1.3	1.2	1.1	-	1.4	1.3	1.2	-	1.4	1.4	1.3	-
		FAH (m)	1.4	1.4	1.4	-	1.6	1.6	1.6	-	1.7	1.7	1.7	-	1.8	1.8	1.8	-
	min.	FAB (m)	0.425	0.425	0.425	-	0.425	0.425	0.425	-	0.425	0.425	0.425	-	0.425	0.425	0.425	-
		FAH (m)	0.7	0.7	0.7	-	0.7	0.7	0.7	-	0.7	0.7	0.7	-	0.7	0.7	0.7	-
MV / MB		FAB (m)	-	-	-	-	-	-	-	-	-	-	-	-	-	-	-	-
		FAH (m)	1.3	1.2	1.1	-	1.4	1.3	1.2	-	1.5	1.4	1.3	-	1.5	1.5	1.4	-
	min.	FAB (m)	0.425	0.425	0.425	-	0.425	0.425	0.425	-	0.425	0.425	0.425	-	0.425	0.425	0.425	-
		FAH (m)	0.7	0.7	0.7	-	0.7	0.7	0.7	-	0.7	0.7	0.7	-	0.7	0.7	0.7	-
	min.	FAB (m)	0.68	0.68	0.68	-	0.68	0.68	0.68	-	0.68	0.68	0.68	-	0.68	0.68	0.68	-
		FAH (m)	0.9	0.9	0.9	-	0.9	0.9	0.9	-	0.9	0.9	0.9	-	0.9	0.9	0.9	-
	max.(kg)	80				100				100				100				

WICLINE 75

Verdeckte Beschläge
Concealed fittings



Zulässige Flügelgrößen
Admissible sash sizes



		1917112				1917113												
	(Pa)	800	1200	2000	-	800	1200	2000	-									
	(Pa)	150	300	600	-	150	300	600	-									
max.	FAB (m)	1.4	1.3	1.2	-	1.4	1.4	1.3	-									
	FAH (m)	1.8	2.0	2.1	-	2.0	2.0	2.25	-									
min.	FAB (m)	0.425	0.425	0.425	-	0.425	0.425	0.425	-									
	FAH (m)	0.7	0.7	0.7	-	0.7	0.7	0.7	-									
MV / MB	FAB (m)	-	-	-	-	-	-	-	-									
	FAH (m)	1.5	1.4	1.3	-	1.5	1.5	1.4	-									
	min. FAB (m)	0.425	0.425	0.425	-	0.425	0.425	0.425	-									
	min. FAH (m)	0.7	0.7	0.7	-	0.7	0.7	0.7	-									
	min. FAB (m)	0.68	0.68	0.68	-	0.68	0.68	0.68	-									
	min. FAH (m)	0.9	0.9	0.9	-	0.9	0.9	0.9	-									
	max.(kg)	130***				130***												

*** Zusätzliche Verklebung, Angaben in den Verarbeitungsrichtlinien beachten!
*** Additional gluing, pay attention to specifications in the workshop manual!









WICLINE 75

Verdeckte Beschläge
Concealed fittings

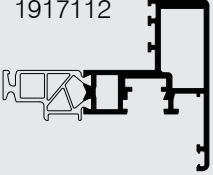
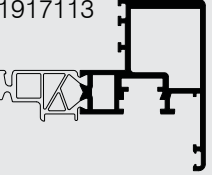

Zulässige Flügelgrößen
Admissible sash sizes



		1917110 				1917111 				1917112 				1917113 			
	(Pa)	800	1200	2000	-	800	1200	2000	-	800	1200	2000	-	800	1200	2000	-
	(Pa)	150	300	600	-	150	300	600	-	150	300	600	-	150	300	600	-
max.	FAB (m)	1.4	1.4	1.4	-	1.6	1.6	1.6	-	1.7	1.7	1.7	-	1.8	1.8	1.8	-
	FAH (m)	1.2	1.1	1.0	-	1.3	1.2	1.1	-	1.4	1.3	1.2	-	1.4	1.4	1.3	-
min.	FAB (m)	0.6	0.6	0.6	-	0.6	0.6	0.6	-	0.6	0.6	0.6	-	0.6	0.6	0.6	-
	FAH (m)	0.45	0.45	0.45	-	0.45	0.45	0.45	-	0.45	0.45	0.45	-	0.45	0.45	0.45	-
MV / MB	FAB (m)	1.3	1.2	1.1	-	1.4	1.3	1.2	-	1.5	1.4	1.3	-	1.5	1.5	1.4	-
	FAH (m)	-	-	-	-	-	-	-	-	-	-	-	-	-	-	-	-
	min. FAB (m)	0.74	0.74	0.74	-	0.74	0.74	0.74	-	0.74	0.74	0.74	-	0.74	0.74	0.74	-
	min. FAH (m)	0.45	0.45	0.45	-	0.45	0.45	0.45	-	0.45	0.45	0.45	-	0.45	0.45	0.45	-
	min. FAB (m)	0.9	0.9	0.9	-	0.9	0.9	0.9	-	0.9	0.9	0.9	-	0.9	0.9	0.9	-
	min. FAH (m)	0.6	0.6	0.6	-	0.6	0.6	0.6	-	0.6	0.6	0.6	-	0.6	0.6	0.6	-
	max.(kg)	80				100				100				100			

WICLINE 75

Verdeckte Beschläge
Concealed fittings



Zulässige Flügelgrößen
Admissible sash sizes



		1917112				1917113												
	(Pa)	800	1200	2000	-	800	1200	2000	-									
	(Pa)	150	300	600	-	150	300	600	-									
	max.	FAB (m)	1.8	2.0	2.1	-	2.0	2.0	2.25	-								
		FAH (m)	1.4	1.3	1.2	-	1.4	1.4	1.3	-								
	min.	FAB (m)	0.6	0.6	0.6	-	0.6	0.6	0.6	-								
		FAH (m)	0.45	0.45	0.45	-	0.45	0.45	0.45	-								
MV / MB		FAB (m)	1.5	1.4	1.3	-	1.5	1.5	1.4	-								
		FAH (m)	-	-	-	-	-	-	-	-								
	min.	FAB (m)	0.74	0.74	0.74	-	0.74	0.74	0.74	-								
		FAH (m)	0.45	0.45	0.45	-	0.45	0.45	0.45	-								
	min.	FAB (m)	0.9	0.9	0.9	-	0.9	0.9	0.9	-								
		FAH (m)	0.6	0.6	0.6	-	0.6	0.6	0.6	-								
	max.(kg)	130***				130***												

*** Zusätzliche Verklebung, Angaben in den Verarbeitungsrichtlinien beachten!
*** Additional gluing, pay attention to specifications in the workshop manual!

WICLINE 75

Verdeckte Beschläge
Concealed fittings



Zulässige Flügelgrößen
Admissible sash sizes



		1917110				1917111				1917112				1917113			
	(Pa)	800	1200	2000	-	800	1200	2000	-	800	1200	2000	-	800	1200	2000	-
	(Pa)	150	300	600	-	150	300	600	-	150	300	600	-	150	300	600	-
max.	FAB (m)	1.4	1.4	1.4	-	1.6	1.6	1.6	-	1.7	1.7	1.7	-	1.8	1.8	1.8	-
	FAH (m)	1.2	1.1	1.0	-	1.3	1.2	1.1	-	1.4	1.3	1.2	-	1.4	1.4	1.3	-
min.	FAB (m)	0.55	0.55	0.55	-	0.55	0.55	0.55	-	0.55	0.55	0.55	-	0.55	0.55	0.55	-
	FAH (m)	0.51	0.51	0.51	-	0.51	0.51	0.51	-	0.51	0.51	0.51	-	0.51	0.51	0.51	-
MV / MB	FAB (m)	1.3	1.2	1.1	-	1.4	1.3	1.2	-	1.5	1.4	1.3	-	1.5	1.5	1.4	-
	FAH (m)	-	-	-	-	-	-	-	-	-	-	-	-	-	-	-	-
	min. FAB (m)	-	-	-	-	-	-	-	-	-	-	-	-	-	-	-	-
	min. FAH (m)	-	-	-	-	-	-	-	-	-	-	-	-	-	-	-	-
	min. FAB (m)	-	-	-	-	-	-	-	-	-	-	-	-	-	-	-	-
	min. FAH (m)	-	-	-	-	-	-	-	-	-	-	-	-	-	-	-	-
	max.(kg)	80				80				80				80			

WICLINE 75

Verdeckte Beschläge
Concealed fittings



Zulässige Flügelgrößen
Admissible sash sizes



		1917112				1917113												
	(Pa)	800	1200	2000	-	800	1200	2000	-									
	(Pa)	150	300	600	-	150	300	600	-									
max.	FAB (m)	1.8	2.0	2.1	-	2.0	2.0	2.25	-									
	FAH (m)	1.4	1.3	1.2	-	1.4	1.4	1.3	-									
min.	FAB (m)	0.55	0.55	0.55	-	0.55	0.55	0.55	-									
	FAH (m)	0.51	0.51	0.51	-	0.51	0.51	0.51	-									
MV / MB	FAB (m)	1.5	1.4	1.3	-	1.5	1.5	1.4	-									
	FAH (m)	-	-	-	-	-	-	-	-									
	min. FAB (m)	-	-	-	-	-	-	-	-									
	min. FAH (m)	-	-	-	-	-	-	-	-									
	min. FAB (m)	-	-	-	-	-	-	-	-									
	min. FAH (m)	-	-	-	-	-	-	-	-									
	max.(kg)	80 / 120***				80 / 120***												

*** Zusätzliche Verklebung, Angaben in den Verarbeitungsrichtlinien beachten!
*** Additional gluing, pay attention to specifications in the workshop manual!

WICLINE

Beschläge
Fittings

Zulässige Formatgrößen, verdeckte Beschläge
Admissible format sizes, concealed fittings

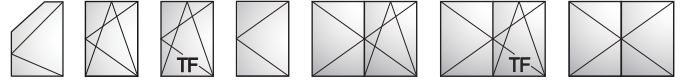

WICSTAR

Flügelgewicht max. 160 kg
Sash weight max. 160 kg

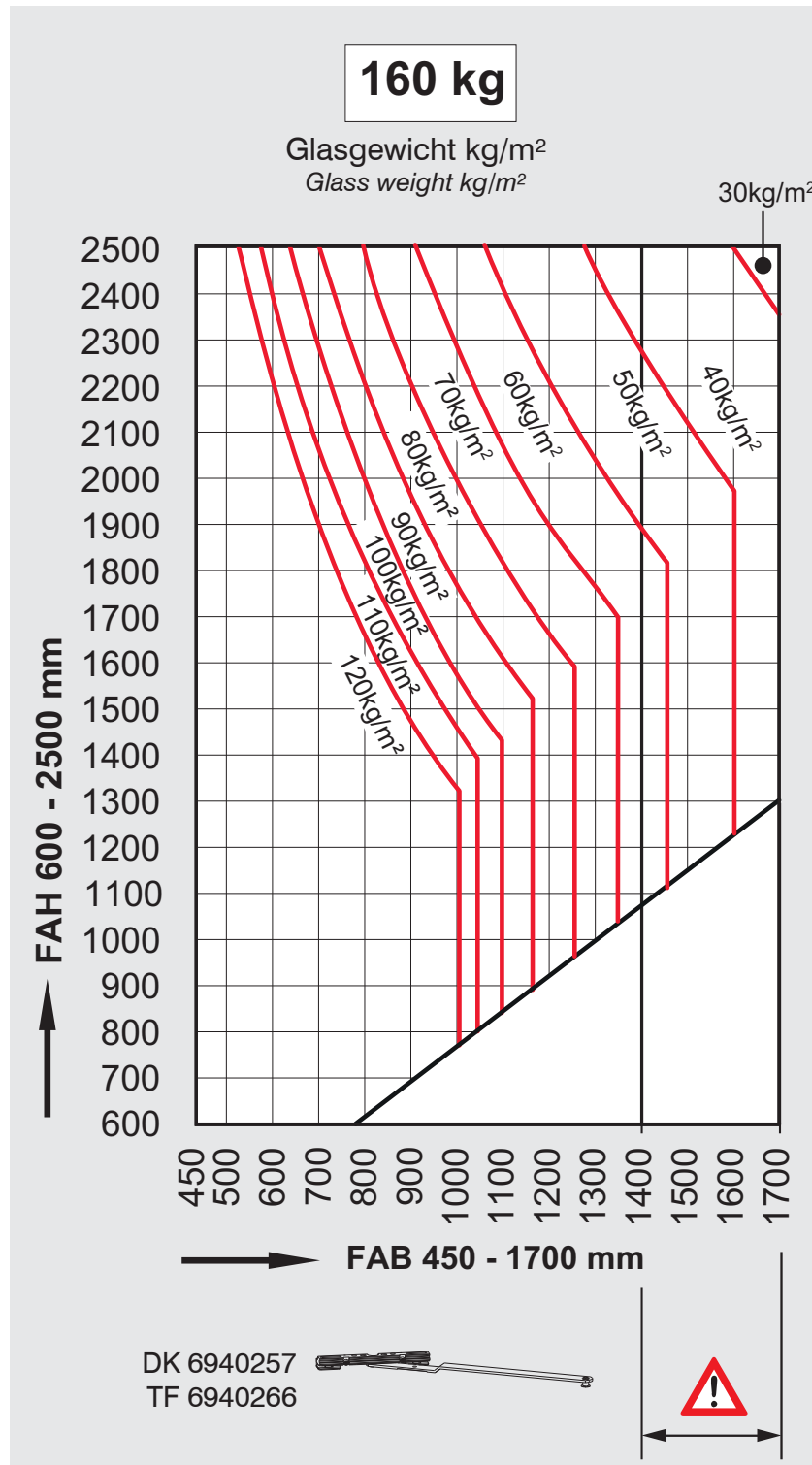

WICLINE

Zulässige Formatgrößen, verdeckte Beschläge
Admissible format sizes, concealed fittings

WICSTAR

Flügelgewicht max. 130 kg
Sash weight max. 130 kg

Beschläge
Fittings

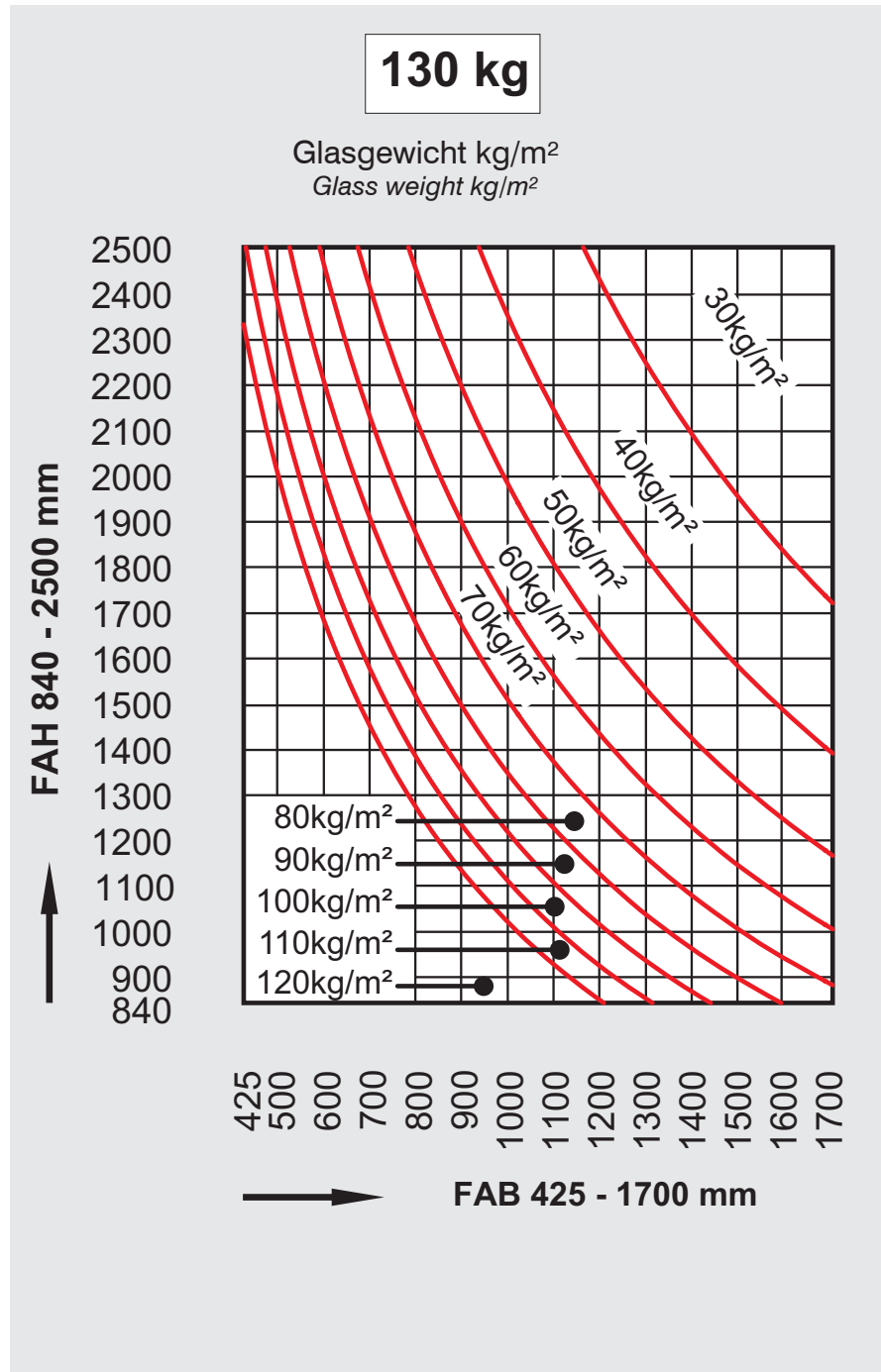

Zulässige Formatgrößen, verdeckte Beschläge
Admissible format sizes, concealed fittings



WICSTAR

Flügelgewicht max. 130 kg
Sash weight max. 130 kg



130 kg

Glasgewicht kg/m²
Glass weight kg/m²

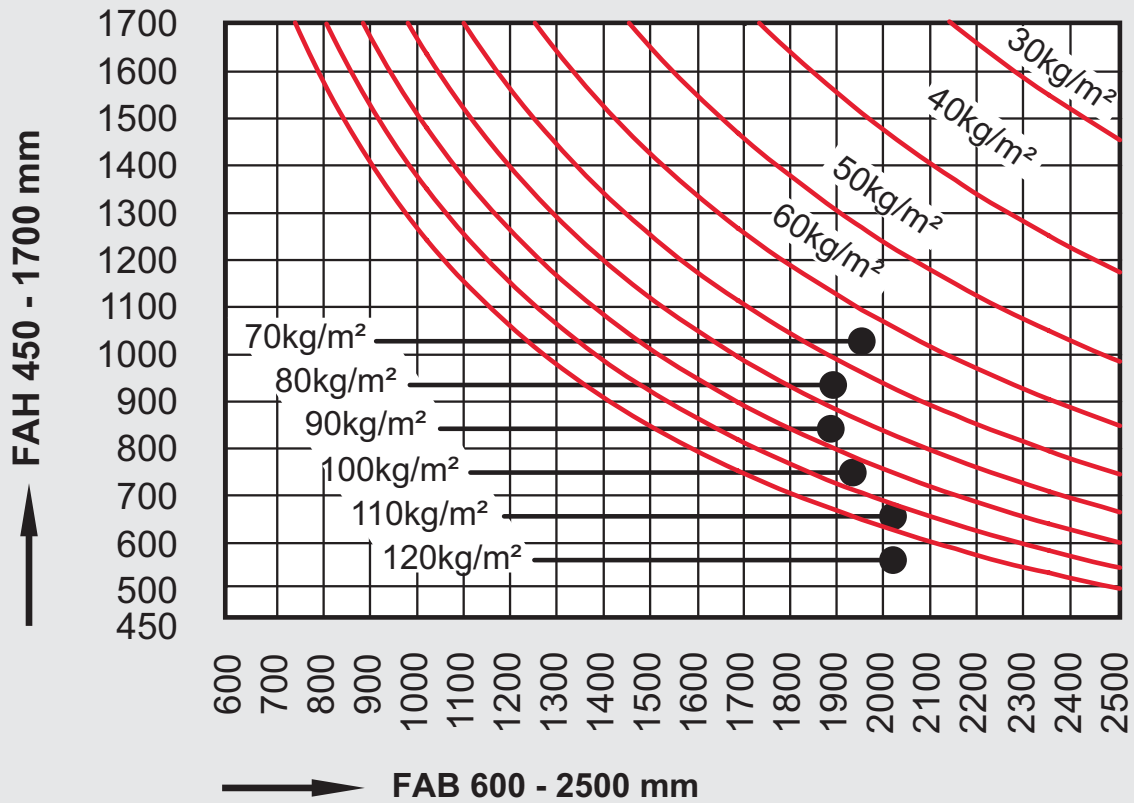

Zulässige Formatgrößen, aufliegende und verdeckte Beschläge
Admissible format sizes, top mounted and concealed fittings



WICSTAR

Flügelgewicht max. 80 kg
Sash weight max. 80 kg

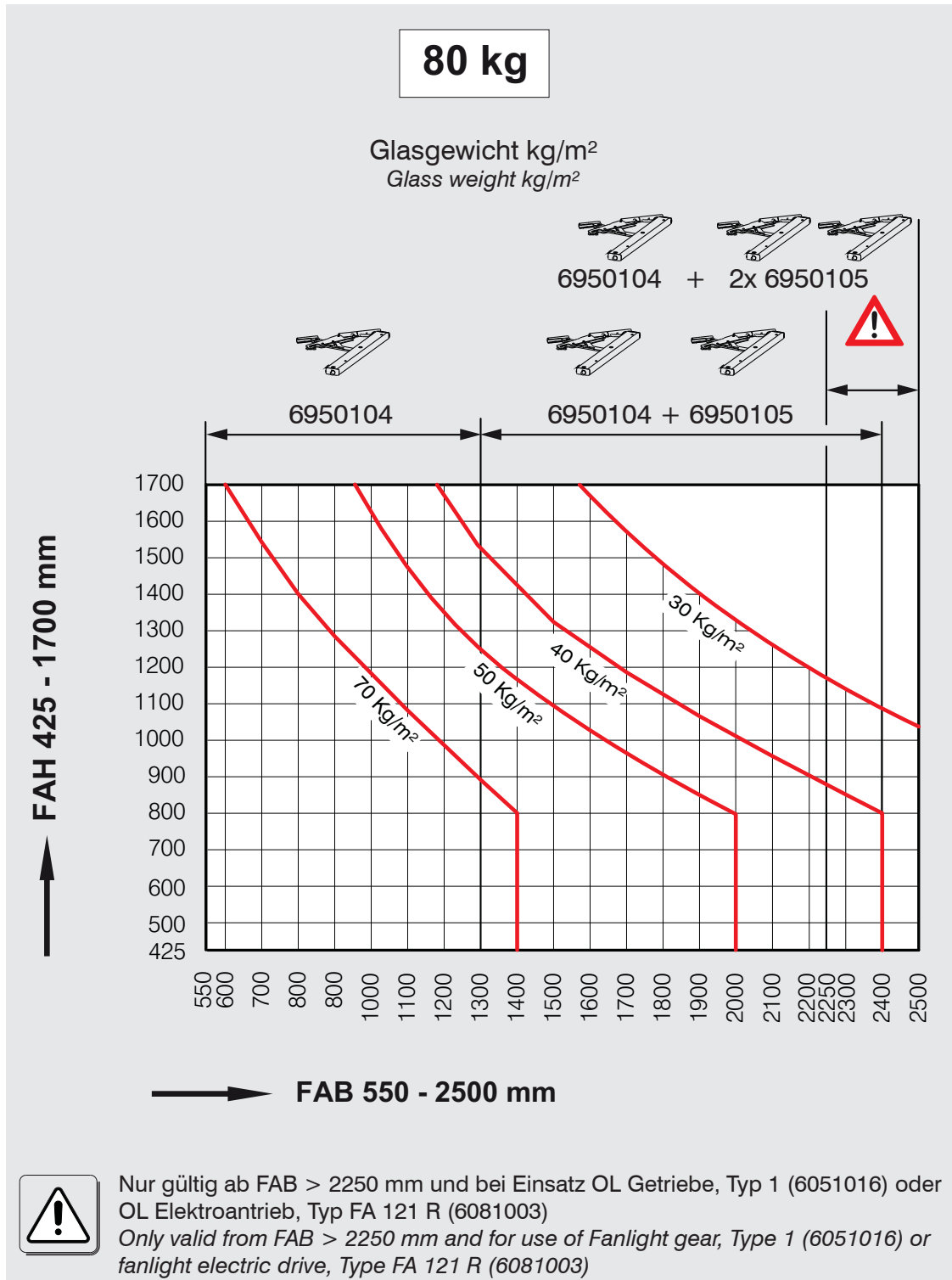

Zulässige Formatgrößen, aufliegende und verdeckte Beschläge
Admissible format sizes, top mounted and concealed fittings



WICSTAR

Flügelgewicht max. 120 kg mit Spindelgetriebe
Sash weight max. 120 kg with spindle gear

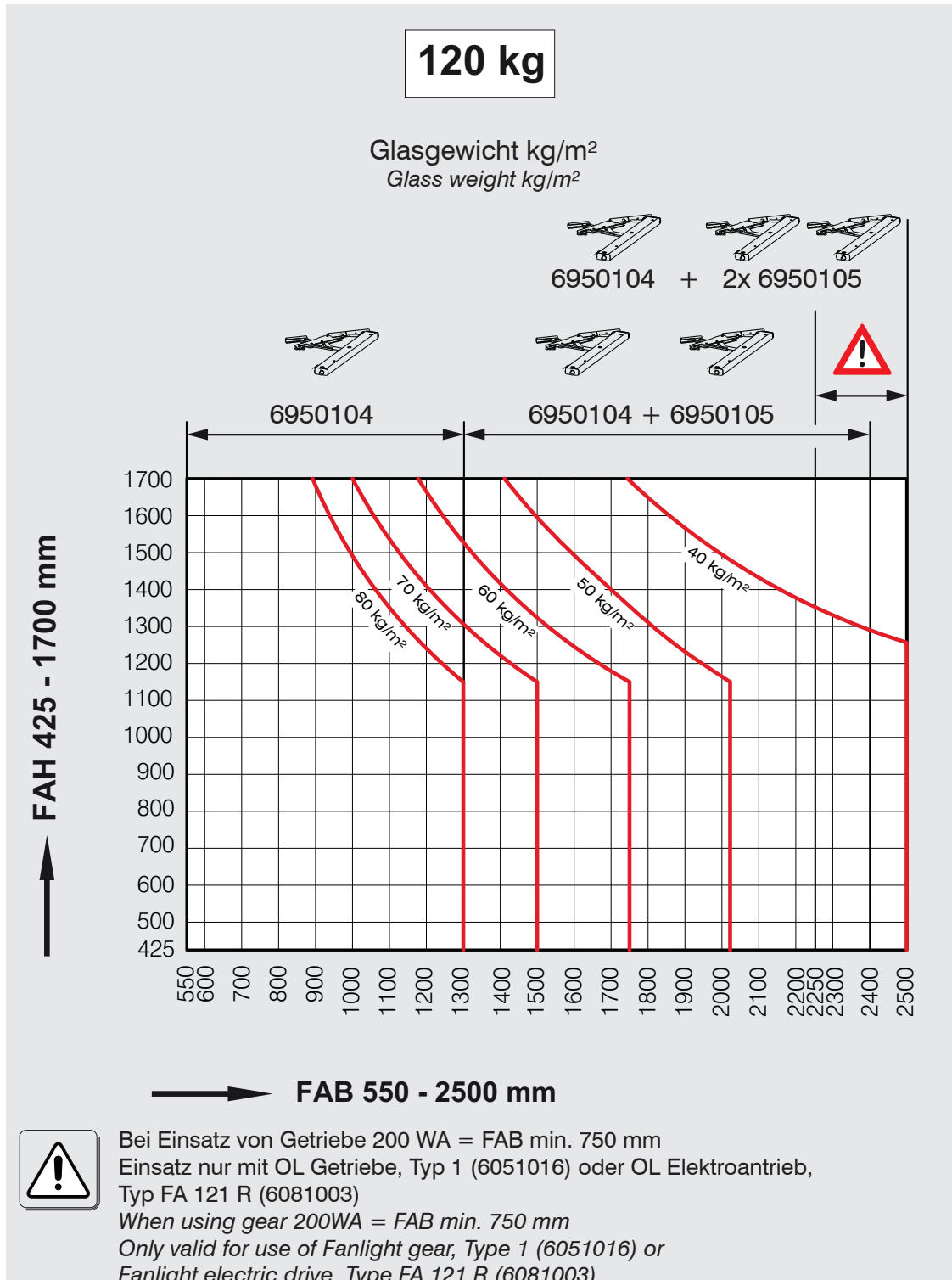

Zulässige Formatgrößen, aufliegende und verdeckte Beschläge
Admissible format sizes, top mounted and concealed fittings



WICSTAR

Flügelgewicht max. 120 kg mit Elektroantrieb
Sash weight max. 120 kg with electric drive

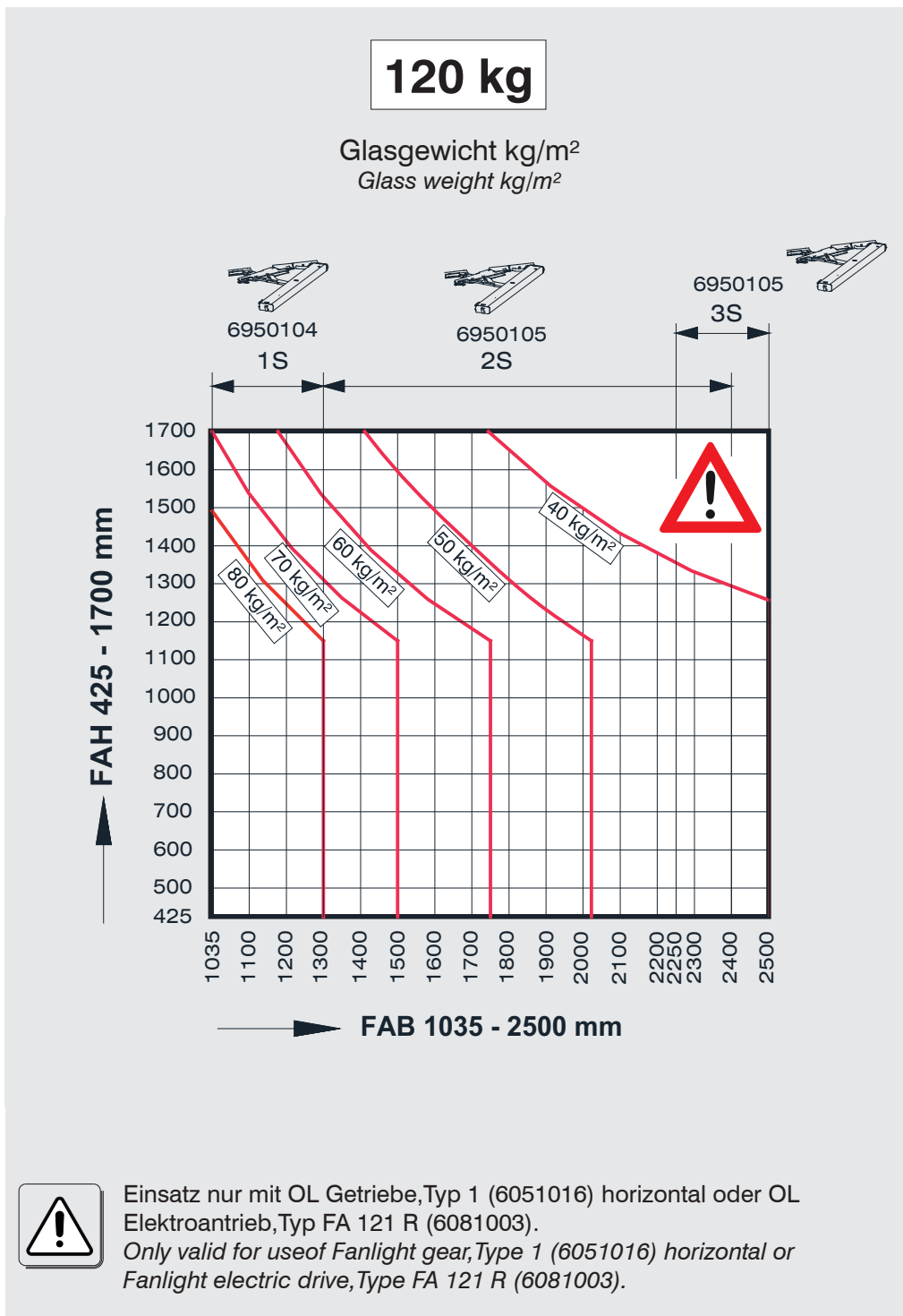

Zulässige Formatgrößen, aufliegende und verdeckte Beschläge
Admissible format sizes, top mounted and concealed fittings



WICSTAR

Flügelgewicht max. 80 kg
Einbruchhemmung RC 1N / RC 2N / RC 2
Sash weight max. 80 kg
Burglar resistance RC 1N / RC 2N / RC 2

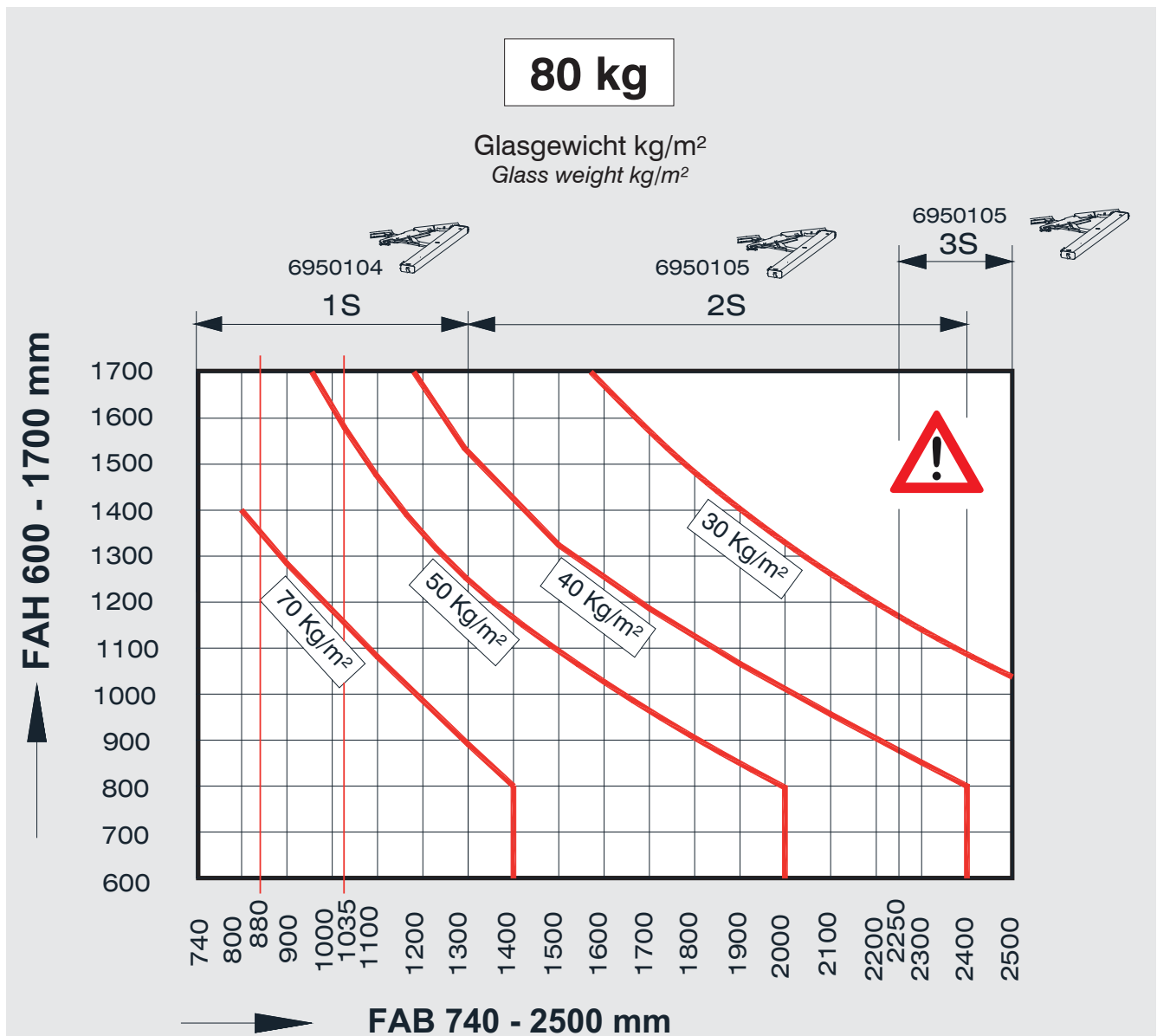

Bei Einsatz von Getriebe 200WA = FAB min. 880 mm; bei Elektroantrieb = FAB min. 1035 mm.
When using gear 200WA = FAB min. 880 mm; with electric drive = FAB min. 1035 mm.

Nur gültig ab FAB > 2250 mm und bei Einsatz OL Getriebe, Typ 1 (6051016) oder OL Elektroantrieb, Typ FA 121 R (6081003).

Flügelgewichte > 80kg nur in Verbindung mit Beschlageinbauplan 45401 (OL Getriebe, Typ 1) und 45601 (OL Elektroantrieb, Typ FA 121 R).

Only valid from FAB > 2250 mm and for use of fanlight gear, Type 1 (6051016) or fanlight electric drive, Type FA 121 R (6081003).

Sash weight > 80kg only in connection with fitting installation plan 45401 (fanlight gear, Type 1) and 45601 (fanlight electric drive, Type FA 121R).

Zulässige Formatgrößen, aufliegende und verdeckte Beschläge
Admissible format sizes, top mounted and concealed fittings



WICSTAR

Flügelgewicht max. 80 kg
Einbruchhemmung RC 3
Sash weight max. 80 kg
Burglar resistance RC 3

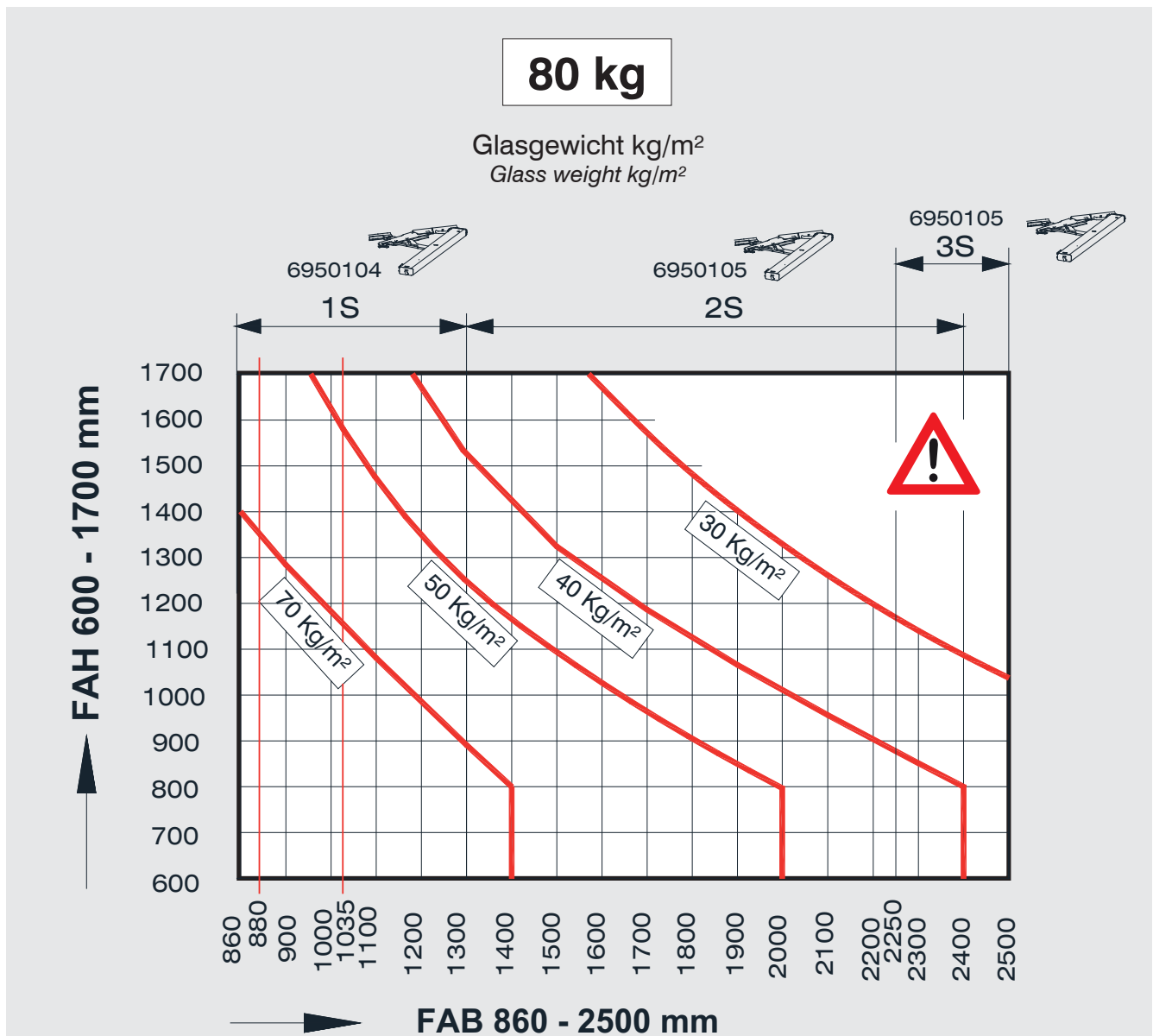

Bei Einsatz von Getriebe 200WA = FAB min. 880 mm; bei Elektroantrieb = FAB min. 1035 mm.
When using gear 200WA = FAB min. 880 mm; with electric drive = FAB min. 1035 mm.

Nur gültig ab FAB > 2250 mm und bei Einsatz OL Getriebe, Typ 1 (6051016) oder OL Elektroantrieb, Typ FA 121 R (6081003).

Flügelgewichte > 80kg nur in Verbindung mit Beschlageinbauplan 45401 (OL Getriebe, Typ 1) und 45601 (OL Elektroantrieb, Typ FA 121 R).

Only valid from FAB > 2250 mm and for use of fanlight gear, Type 1 (6051016) or fanlight electric drive, Type FA 121 R (6081003).

Sash weight > 80kg only in connection with fitting installation plan 45401 (fanlight gear, Type 1) and 45601 (fanlight electric drive, Type FA 121R).

Zulässige Formatgrößen, aufliegende und verdeckte Beschläge
Admissible format sizes, top mounted and concealed fittings



WICSTAR

Flügelgewicht max. 120 kg

Oberlicht-Schrägfenster

Sash weight max. 120 kg

Fanlight sloped window

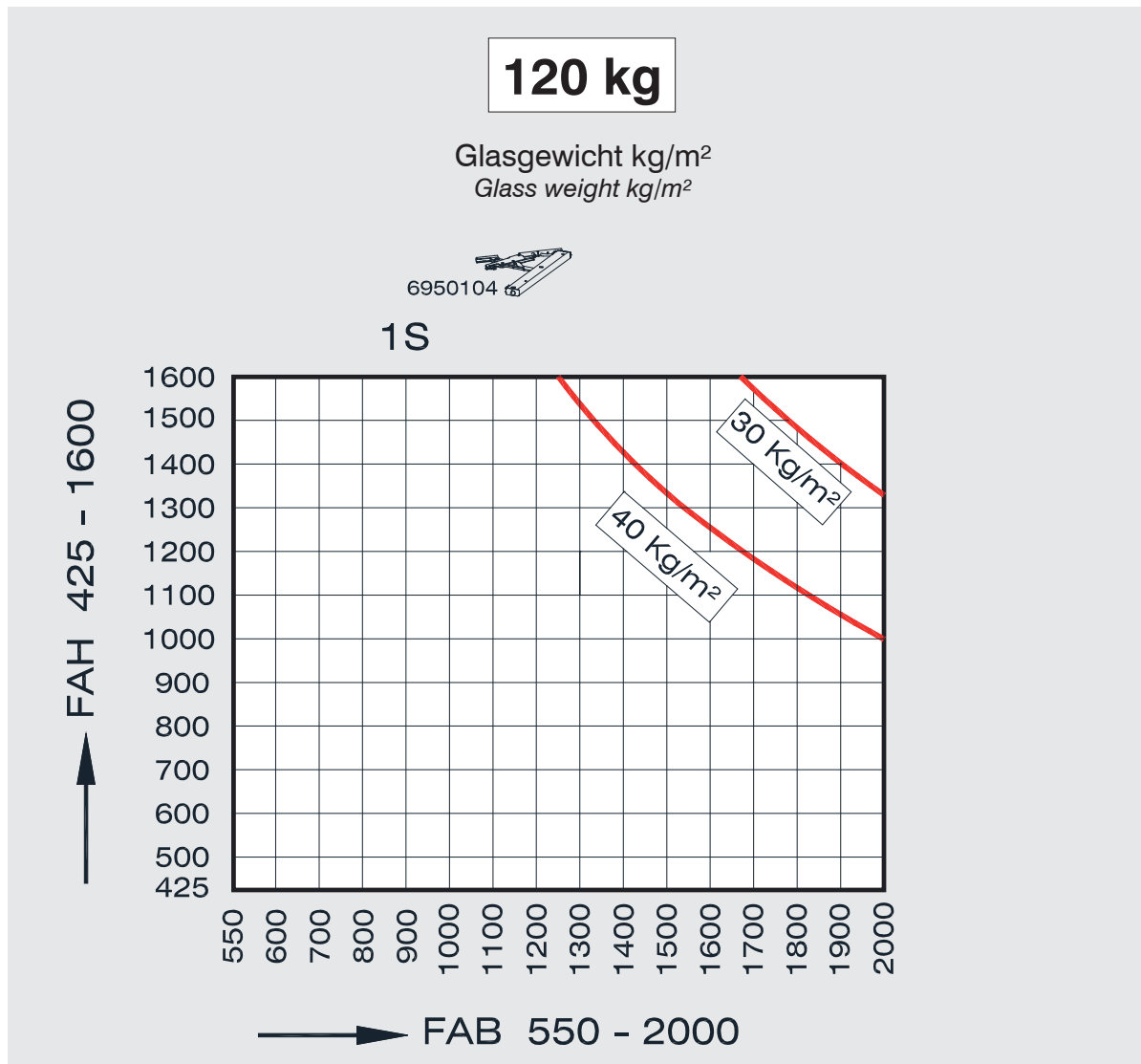

Zulässige Formatgrößen, verdeckte Beschläge
Admissible format sizes, concealed fittings



WICSTAR

Flügelgewicht max. 150 kg

Senk-Klapp-Beschlag

Sash weight max. 150 kg

Italian Style fitting

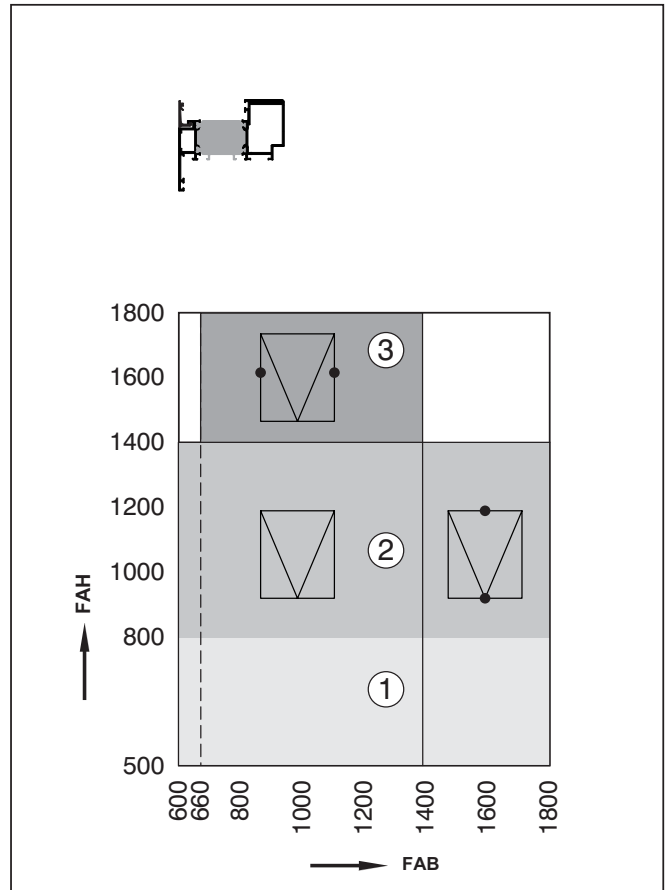
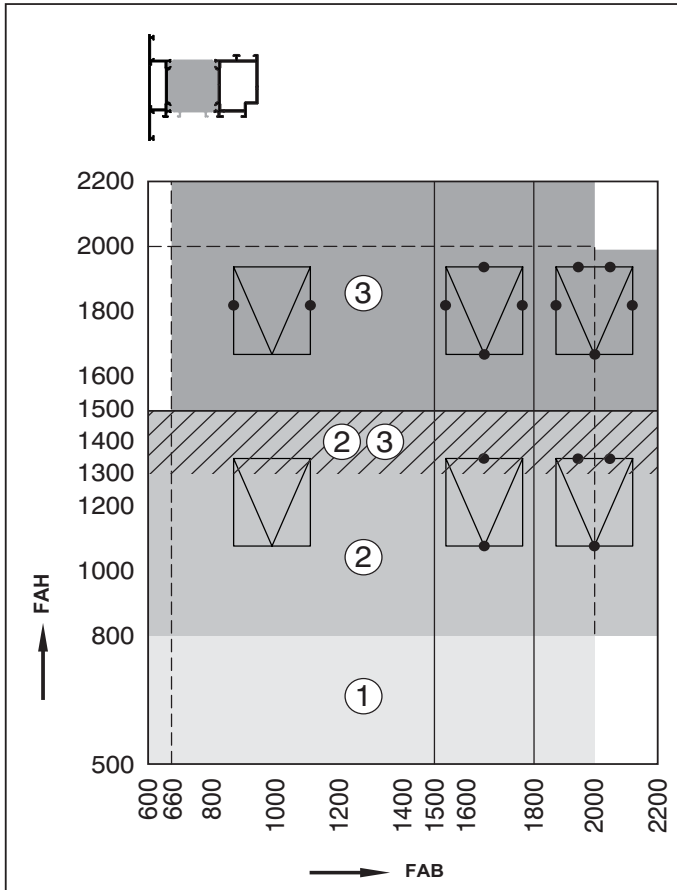

③	Senk-Klapp-Schere Friction Stay Größe 3 / Size 3	$FG_{max} = 150 \text{ kg}$
② ③	Senk-Klapp-Schere Friction Stay Größe 2 und 3 / Size 2 and 3	$FG_{max} = 100 / 150 \text{ kg}$
②	Senk-Klapp-Schere Friction Stay Größe 2 / Size 2	$FG_{max} = 100 \text{ kg}$
①	Senk-Klapp-Schere Friction Stay Größe 1 / Size 1	$FG_{max} = 100 \text{ kg}$
• Zusatzverriegelung / Additional locking point		

③	Senk-Klapp-Schere Friction Stay Größe 3 / Size 3	$FG_{max} = 150 \text{ kg}$
②	Senk-Klapp-Schere Friction Stay Größe 2 / Size 2	$FG_{max} = 100 \text{ kg}$
①	Senk-Klapp-Schere Friction Stay Größe 1 / Size 1	$FG_{max} = 100 \text{ kg}$
• Zusatzverriegelung / Additional locking point		

Für $FG \geq 120 \text{ kg}$ sind Flügel und Füllung gemäß VAR zu verkleben.
Manuelle Bedienung bis max. 120 kg empfohlen.
Füllgewichte bis 80 kg/m^2

Die Profilauswahltabellen sind zu berücksichtigen.
Der kleinere Wert ist zu wählen.

For sash weight $\geq 120 \text{ kg}$ the sash and the infill must be bonded as described in the workshop manual.
Manual operation up to max. 120 kg recommended.
Infill weight up to 80 kg/m^2

The profile selection tables must be followed.
The smaller values should be taken.

Zulässige Formatgrößen, verdeckte Beschläge
Admissible format sizes, concealed fittings



WICSTAR

Flügelgewicht max. 150 kg
Schwing-Wende-Beschlag
Sash weight max. 150 kg
Horizontal / Vertical pivot window fitting

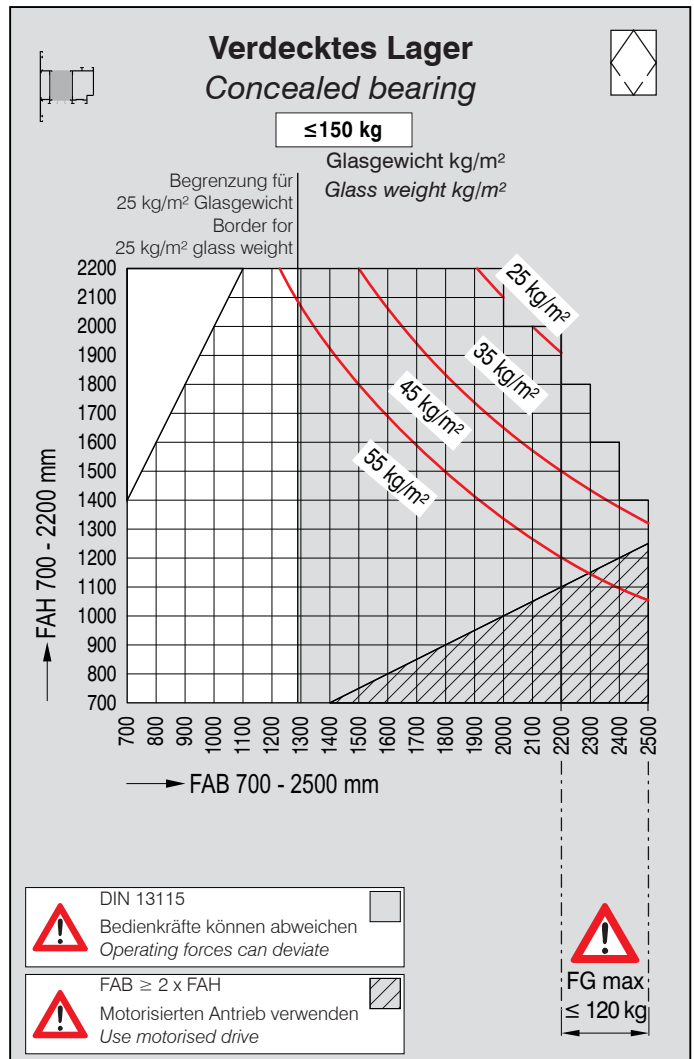
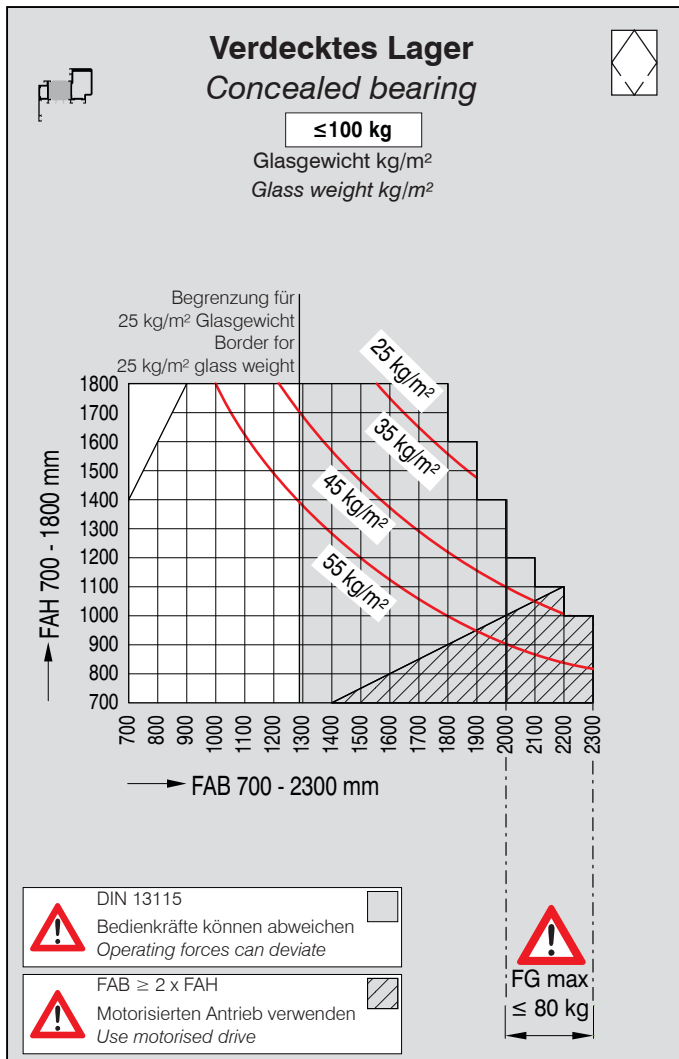

Zulässige Formatgrößen, verdeckte Beschläge
Admissible format sizes, concealed fittings

WICSTAR

Flügelgewicht max. 150 kg

Schwing-Wende-Beschlag

Sash weight max. 150 kg

Horizontal / Vertical pivot window fitting

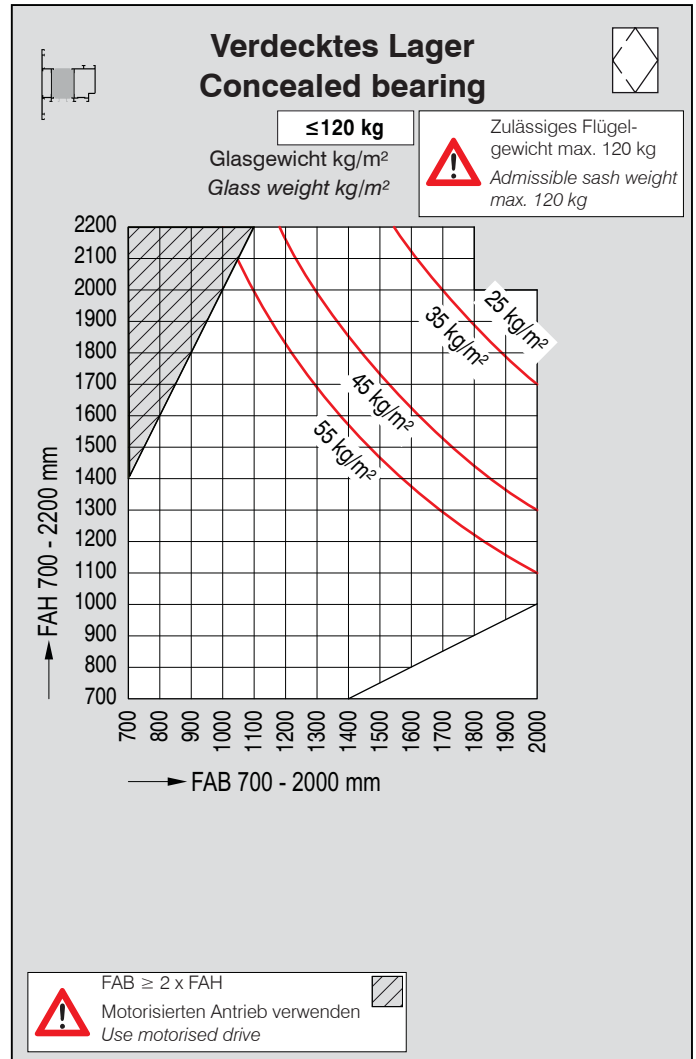
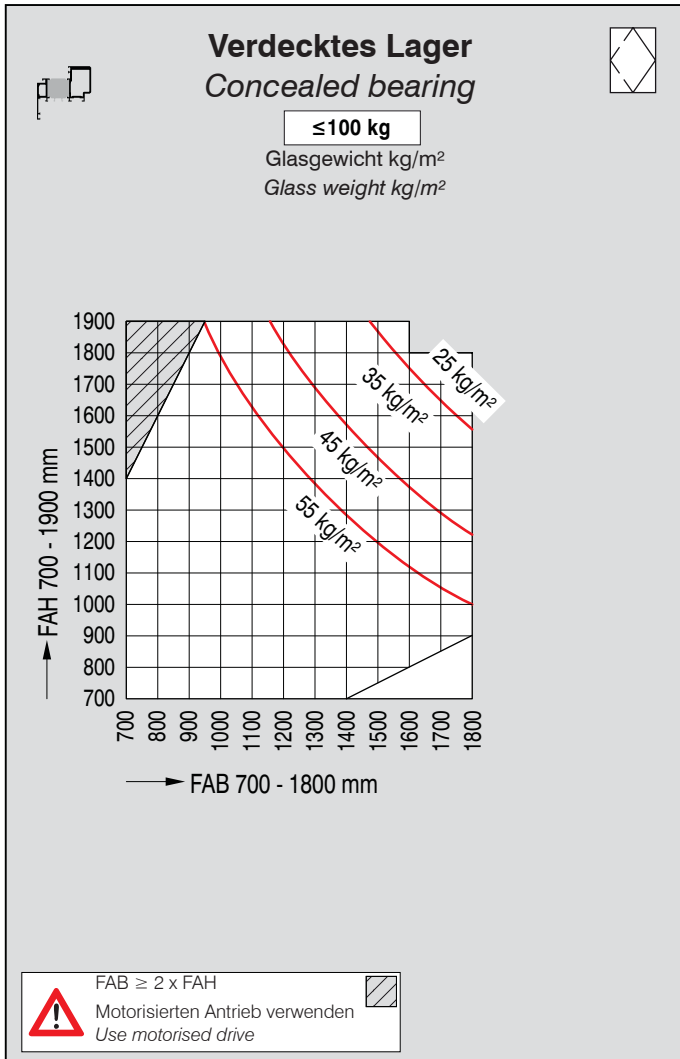



Dreh-Kipp-Beschlag verdeckt Turn/tilt fitting concealed

Griff Stellungen
Handle position

Kipp / tilted

Dreh / turned

Zu / closed

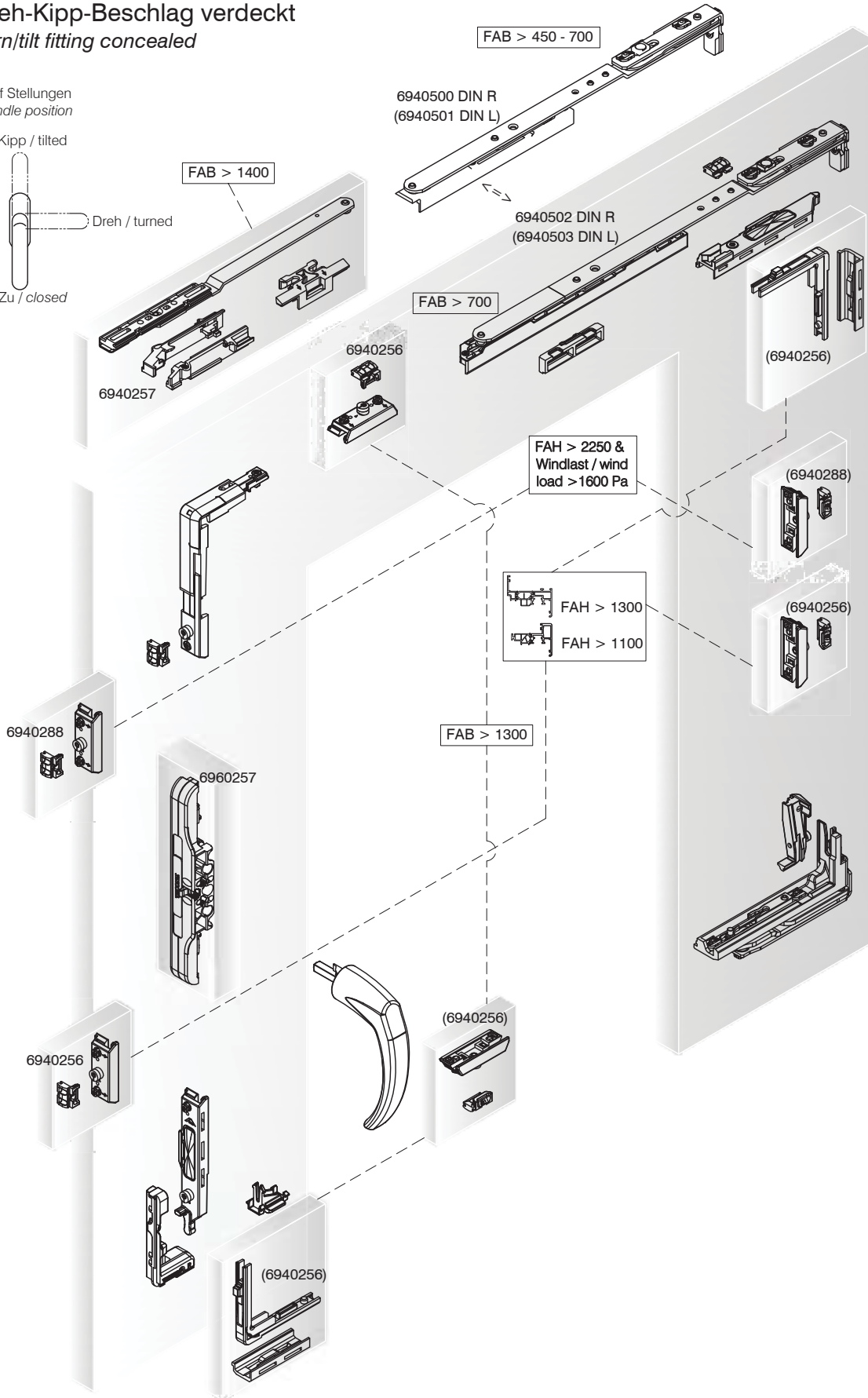



Tilt-First-Beschlag verdeckt Tilt-first fitting concealed

Griff Stellungen
Handle position

Dreh / turned



Zu / closed

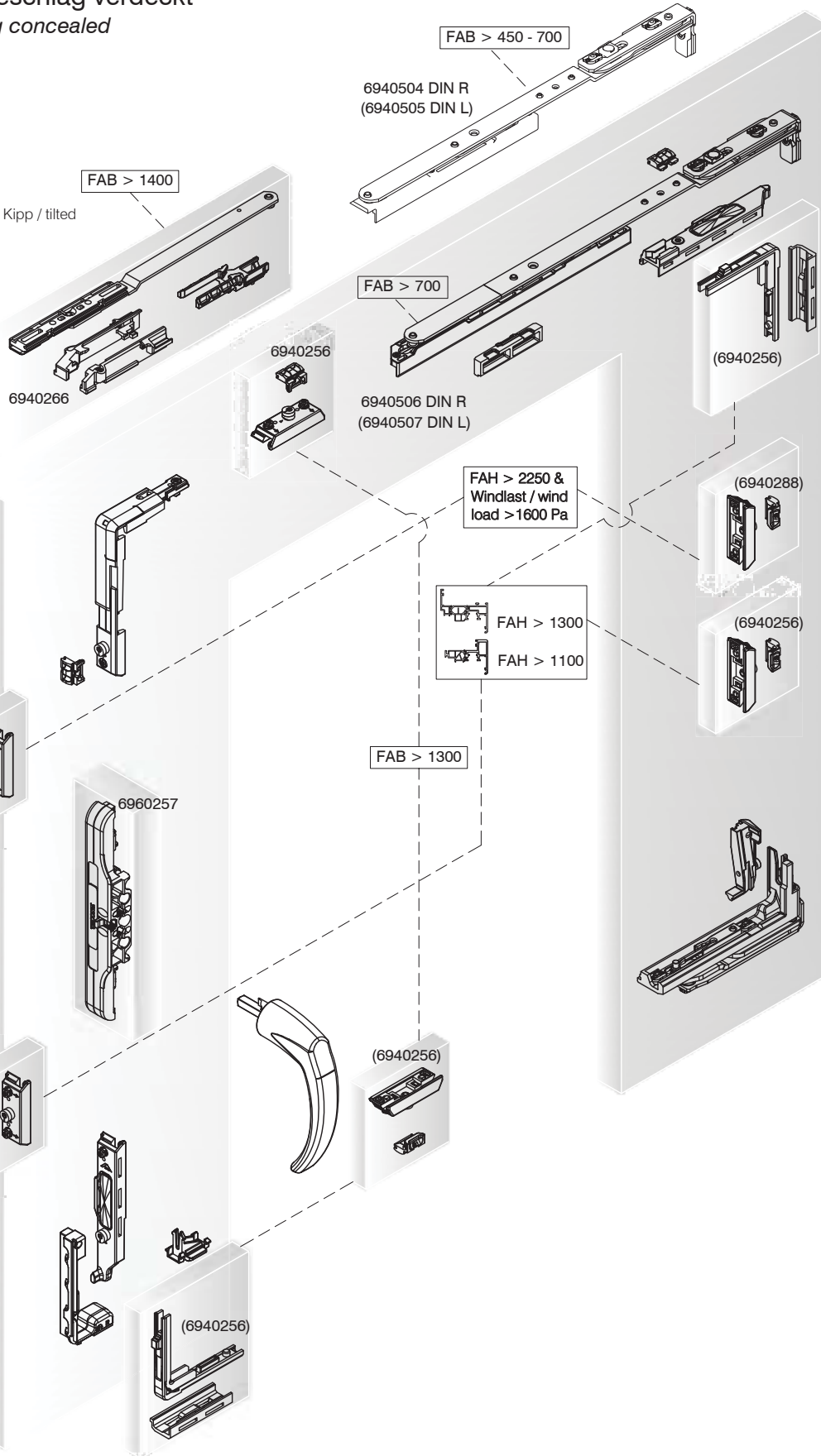



Dreh-Beschlag verdeckt Turn fitting concealed

Griff Stellungen
Handle position

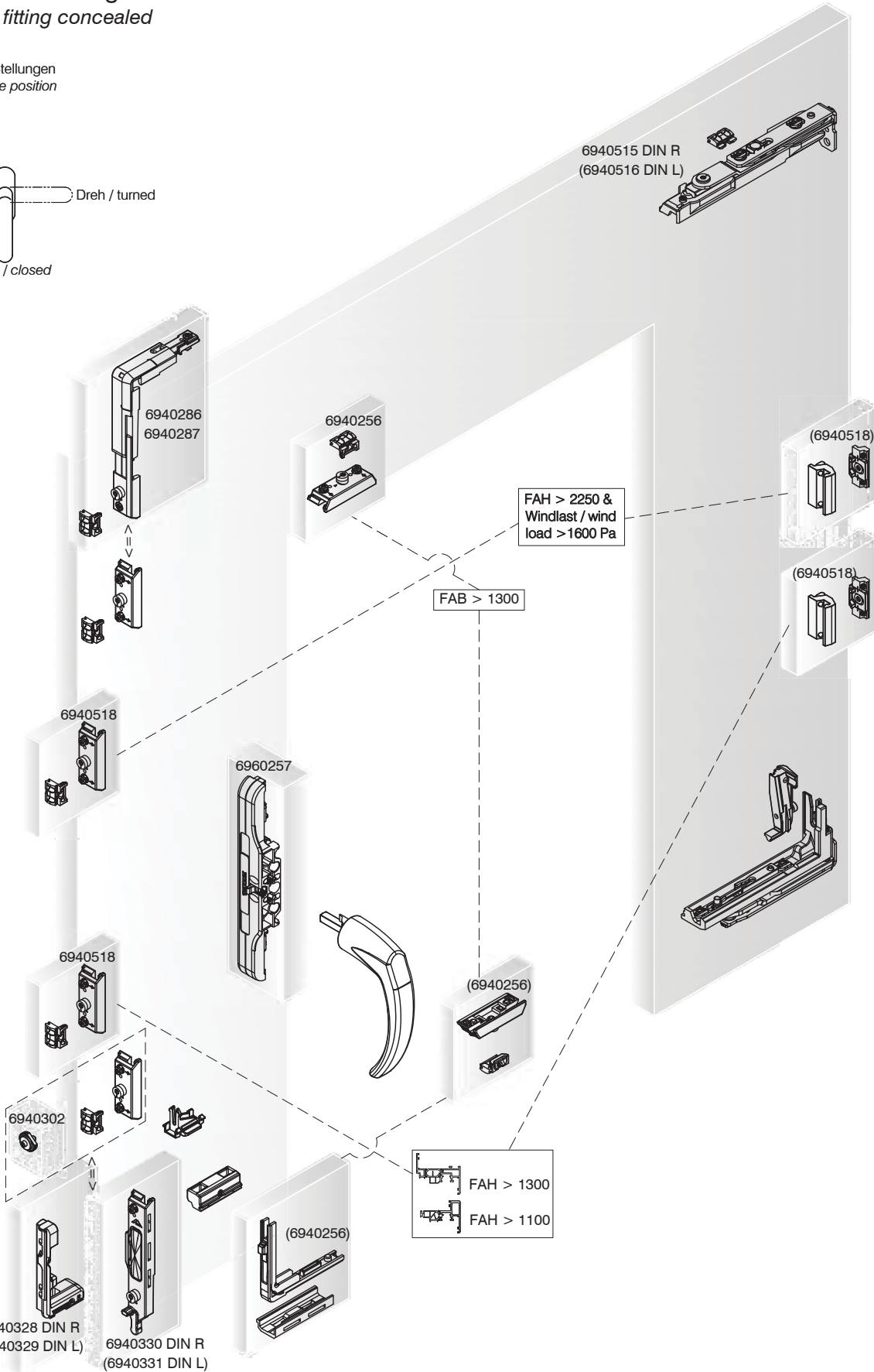
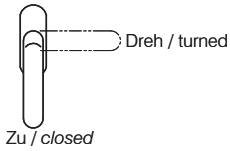



Stulp-Beschlag verdeckt 130 kg mit Kniehebel
Double casement door fitting concealed 130 kg with toggle lever

Kniehebel Stellungen
Toggle lever position



Offen / opened



Zu / closed

Standflügel DIN R
Inactive sash DIN R

Griff Stellungen
Handle position



Dreh / turned



Kipp / tilted

Zu / closed

Gehflügel DIN R
Active sash DIN R

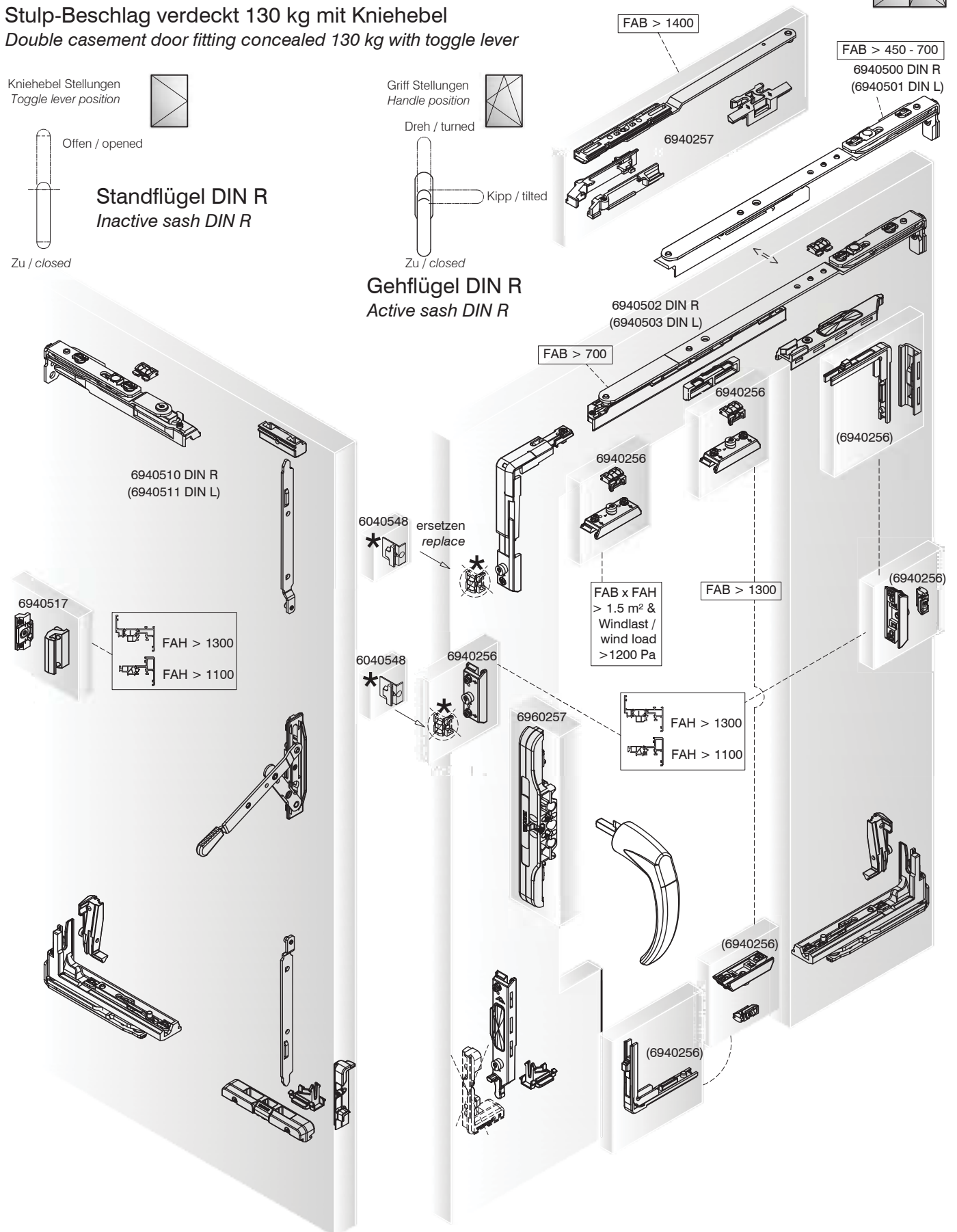



Stulp-Beschlag verdeckt 130 kg mit Kniehebel Double casement door fitting concealed 130 kg with toggle lever

Kniehebel Stellungen
Toggle lever position



Offen / opened



Zu / closed

Standflügel DIN L
Inactive sash DIN L

Griff Stellungen
Handle position



Dreh / turned



Kipp / tilted

Zu / closed

Gehflügel DIN R
Active sash DIN R

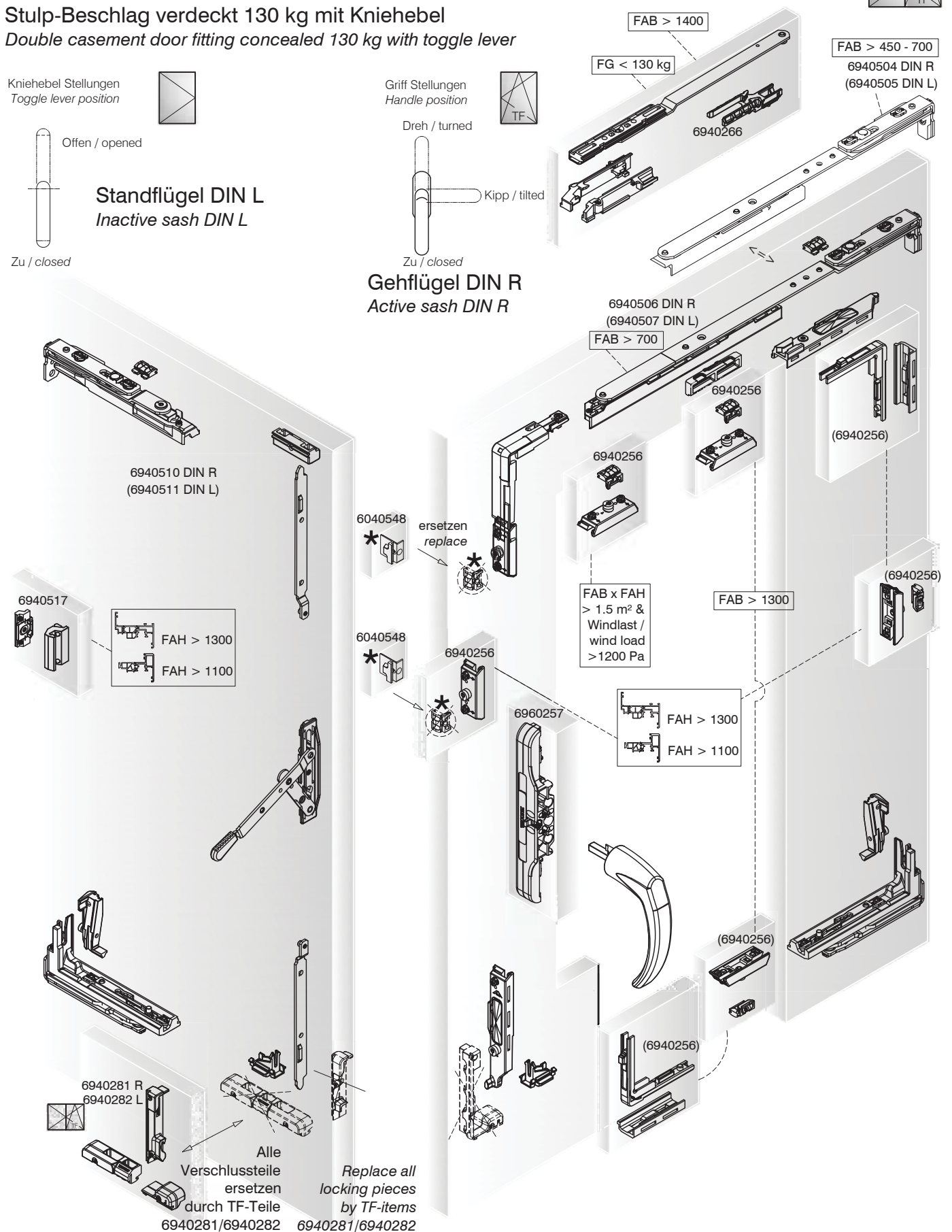

Alle Verschlusssteile ersetzen durch TF-Teile
Replace all locking pieces by TF-items
6940281/6940282 6940281/6940282

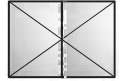

Stulp-Beschlag verdeckt 130 kg mit Kniehebel Double casement door fitting concealed 130 kg with toggle lever

Kniehebel Stellungen
Toggle lever position

Offen / opened



Standflügel DIN L
Inactive sash DIN L

Zu / closed



Griff Stellungen
Handle position



Dreh / turned

Zu / closed

Gehflügel DIN R
Active sash DIN R

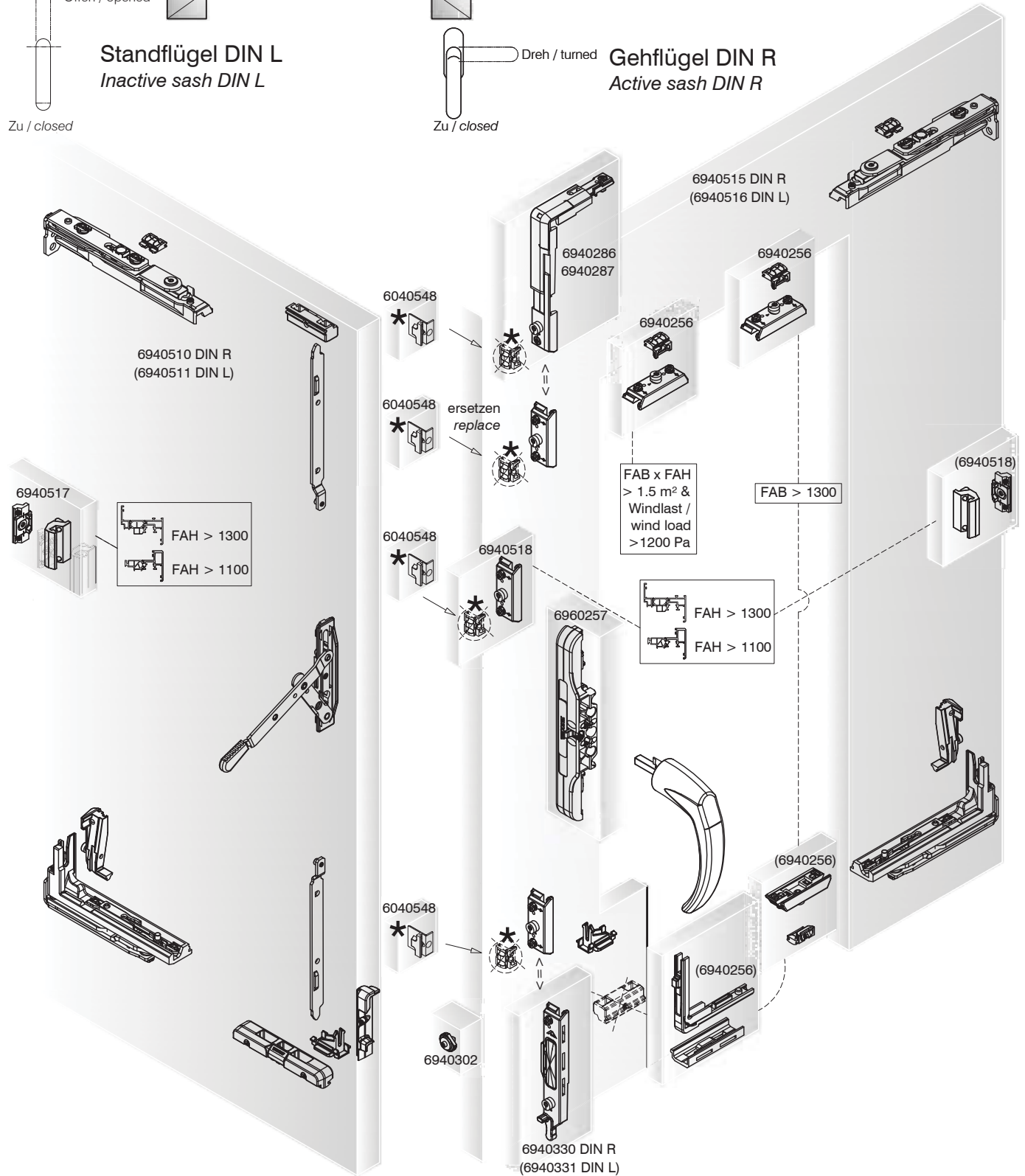



Stulp-Beschlag verdeckt 160 kg mit Stulpgetriebe Double casement door fitting concealed 160 kg with double casement gear

Stulpgetriebe Stellungen
Double casement gear
position

Zu / closed



Standflügel DIN L
Inactive sash DIN L

Offen / opened

Griff Stellungen
Handle position



Dreh / turned



Kipp / tilted



Zu / closed

Gehflügel DIN R
Active sash DIN R

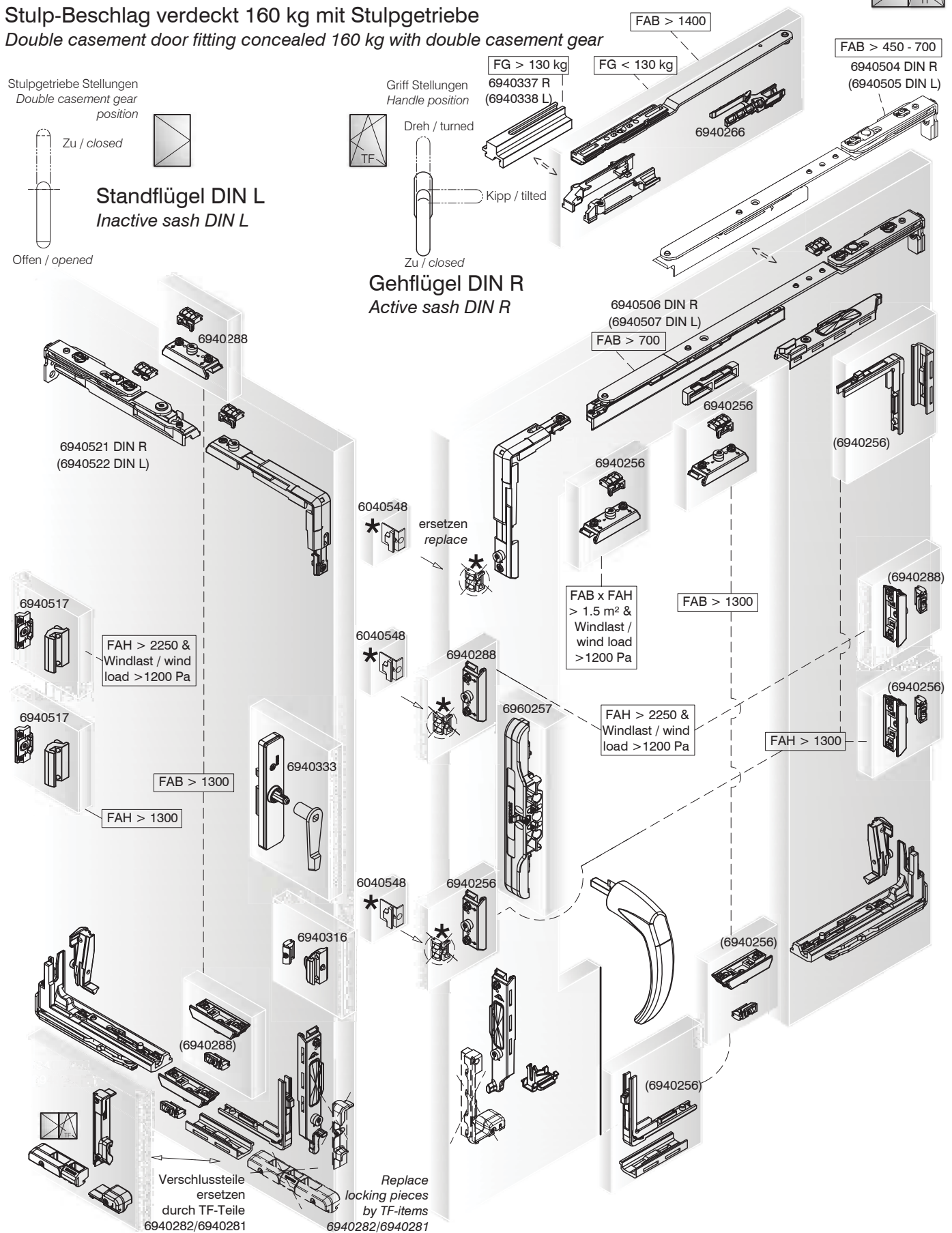

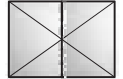

Stulp-Beschlag verdeckt 160 kg mit Stulpgetriebe Double casement door fitting concealed 160 kg with double casement gear

Stulpgetriebe Stellungen
Double casement gear
position



Griff Stellungen
Handle position



Gehflügel DIN R Active sash DIN R

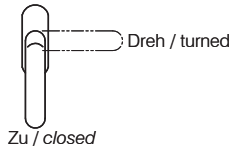

Zu / closed
Standflügel DIN L
Inactive sash DIN L

Offen / opened

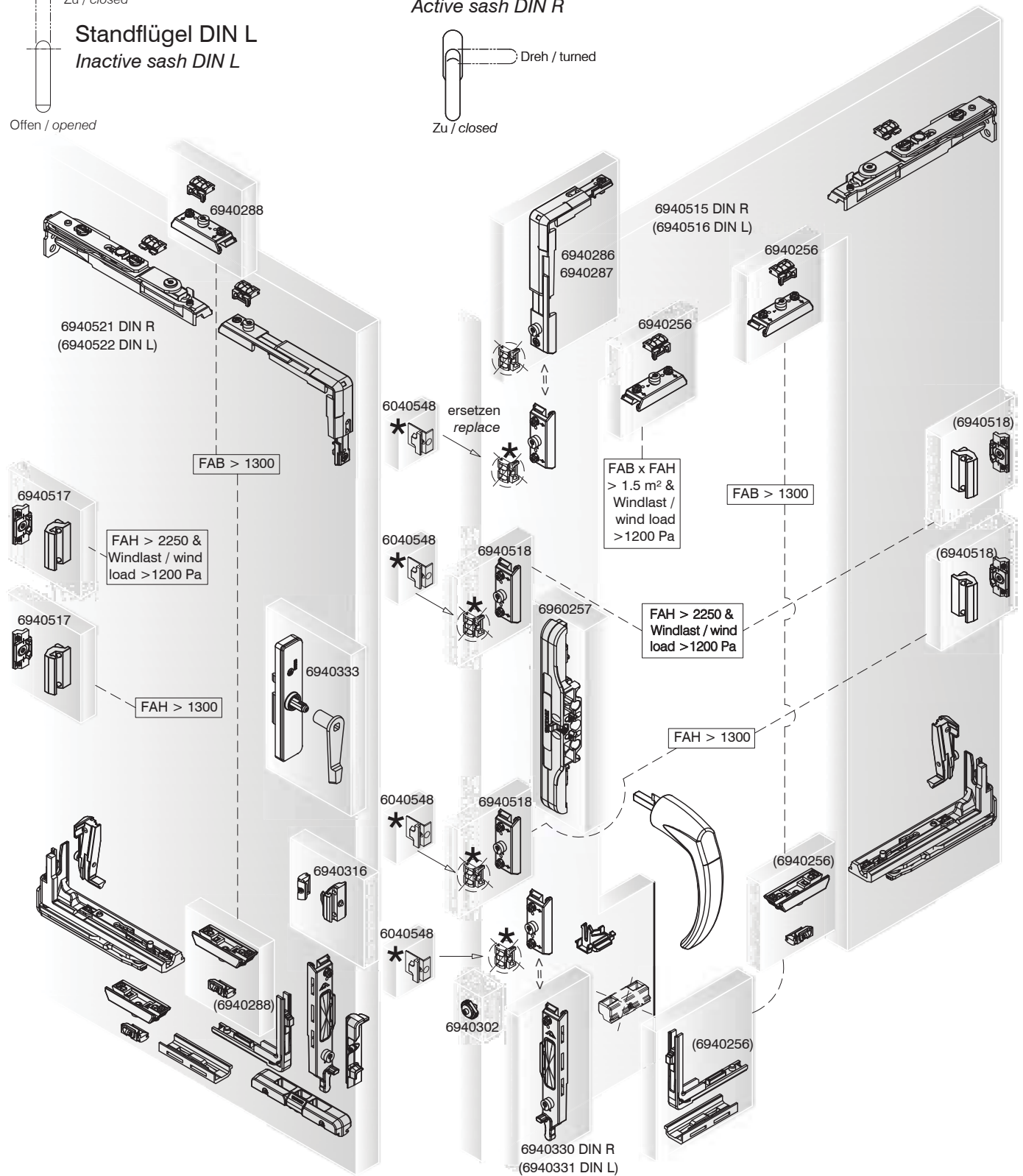



Kipp-Beschlag verdeckt 130 kg Querformat Tilt fitting concealed 130 kg landscape

Griff Stellungen
Handle position

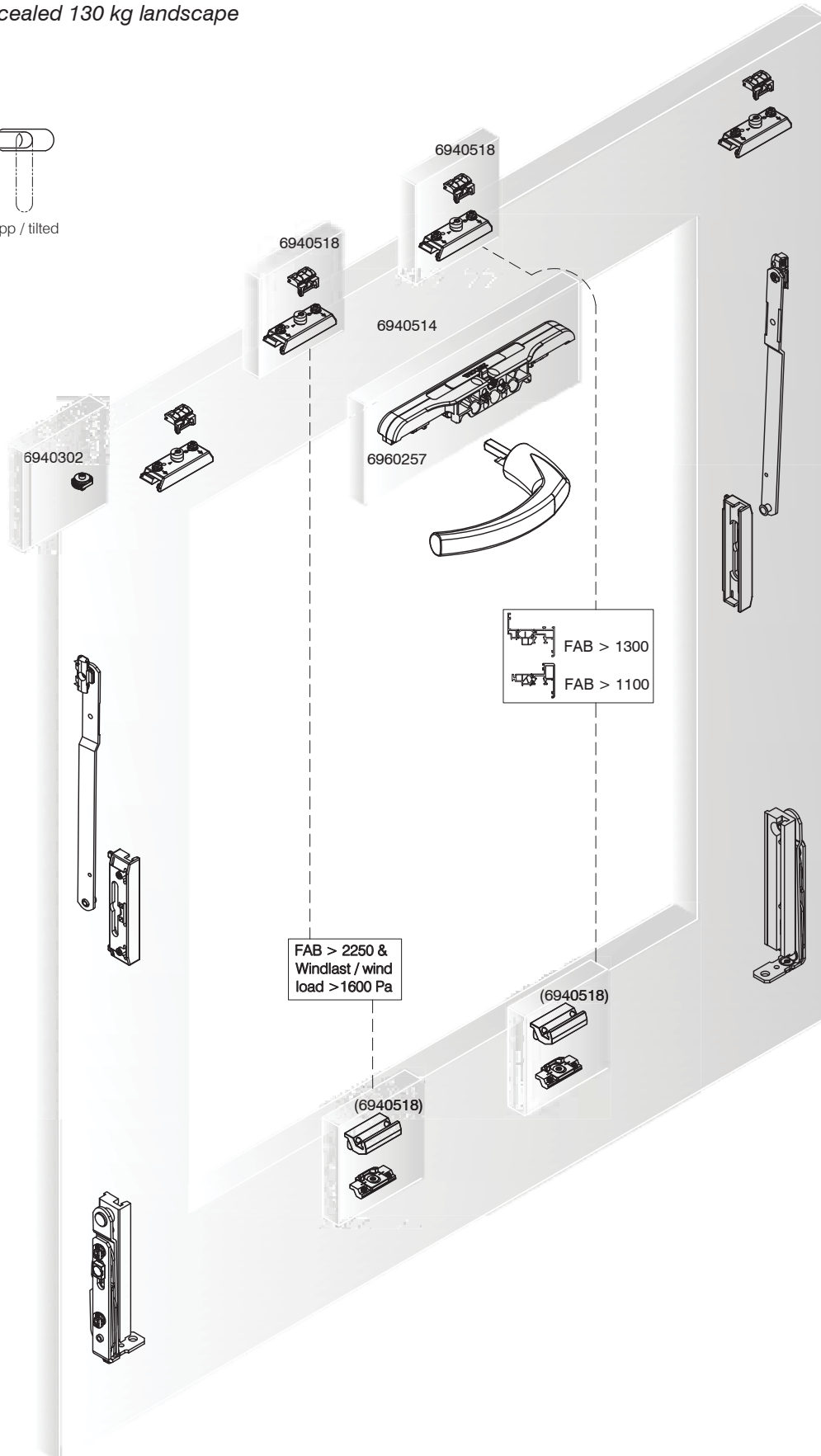
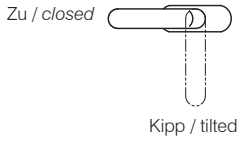



Kipp-Beschlag verdeckt 130 kg Querformat mit vertikalen Mittelverriegelungen Tilt fitting concealed 130 kg landscape with vertical centre lockings

Griff Stellungen
Handle position

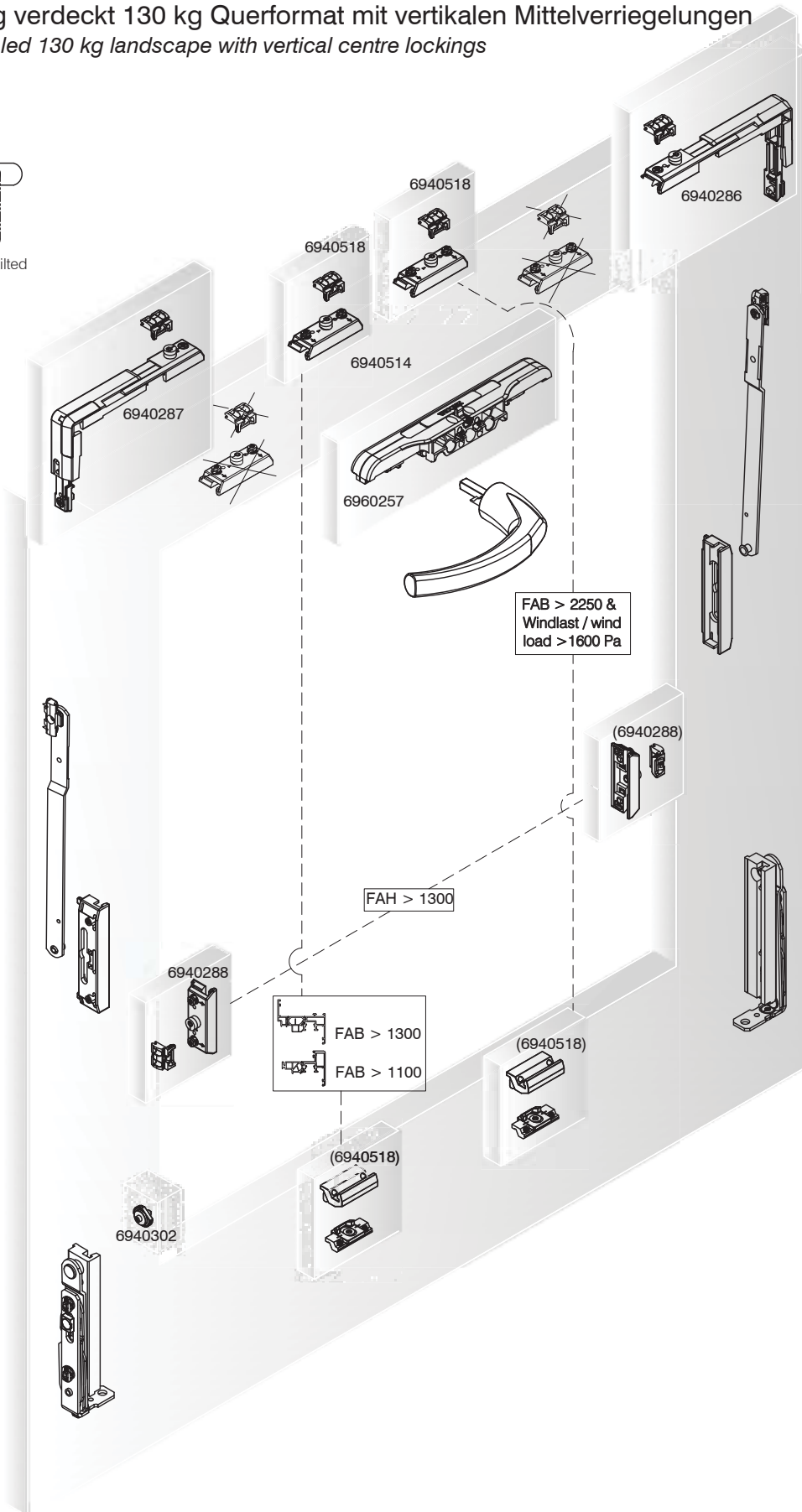
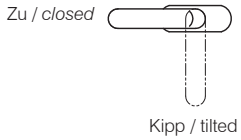



Kipp-Beschlag verdeckt 130 kg Hochformat Tilt fitting concealed 130 kg portrait

Griff Stellungen
Handle position

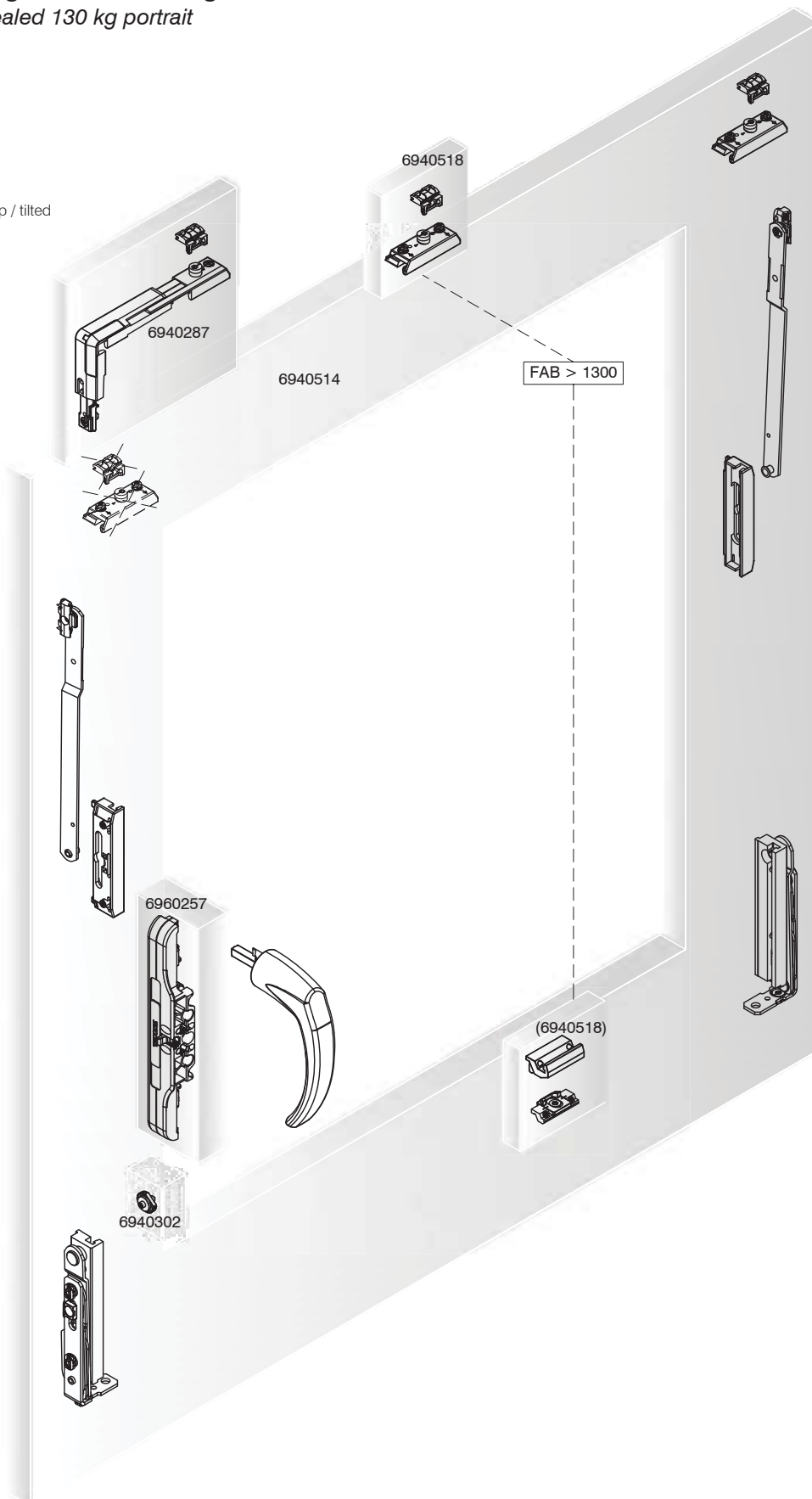
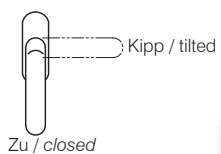



Kipp-Beschlag verdeckt 130 kg Hochformat mit vertikalen Mittelverriegelungen Tilt fitting concealed 130 kg portrait with vertical centre lockings

Griff Stellungen
Handle position

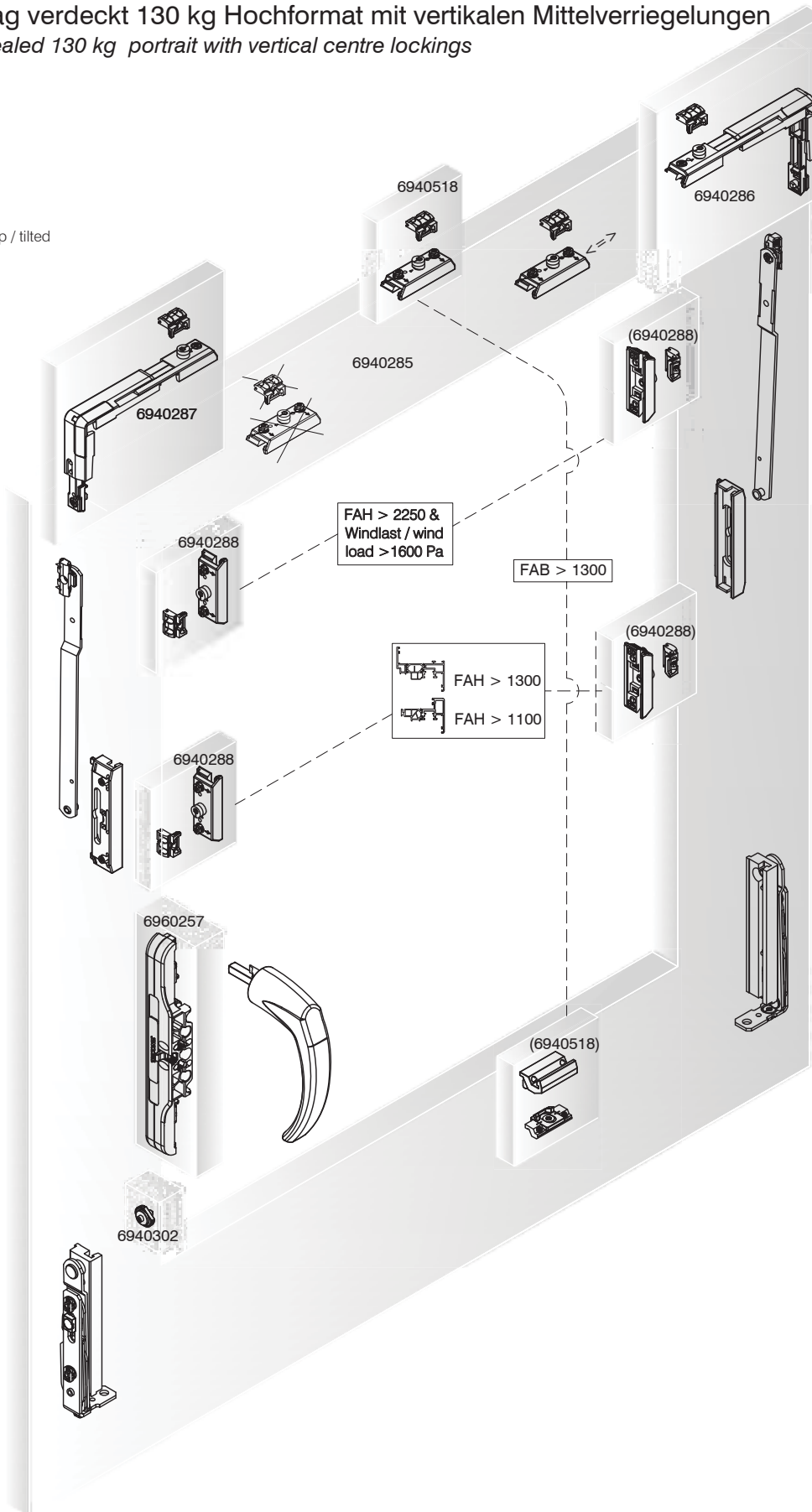
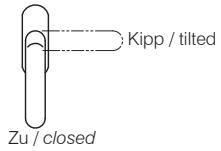

	Seite Page
Aufliegende Beschläge <i>Top mounted fittings</i>	
Zulässige Flügelgrößen, sichtbarer Flügel <i>Admissible sash sizes, visible sash</i>	3/240
Zulässige Flügelgrößen, verdeckter Flügel <i>Admissible sash sizes, concealed sash</i>	3/267
Zulässige Formatgrößen <i>Admissible format sizes</i>	3/276
Beschlagsübersichten <i>Survey of fittings</i>	3/299

WICLINE 75

Aufliegende Beschläge
Top mounted fittings

Zulässige Flügelgrößen
Admissible sash sizes

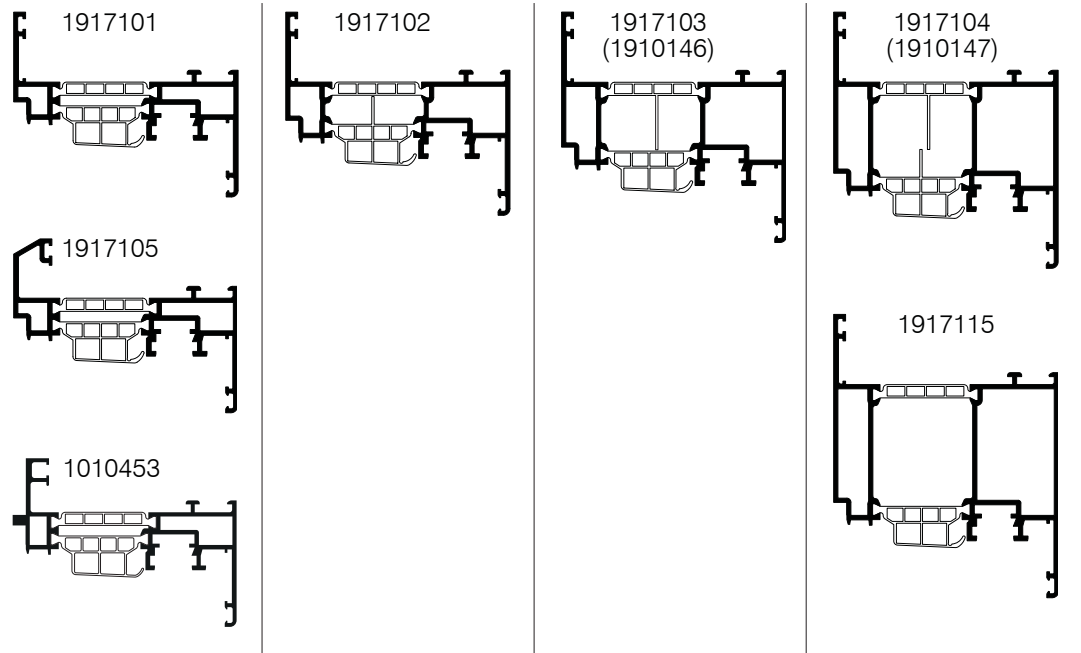

	(Pa)	800	1200	2000	-	800	1200	2000	2000	800	1200	2000	2000*	800	1200	2000*	-	
	(Pa)	150	300	600	-	150	300	600	600	150	300	600	600	150	300	600	-	
	max.	FAB (m)	1.3	1.2	1.1	-	1.6	1.5	1.4	1.0	1.6	1.6	1.5	1.0	1.7	1.7	1.6	-
		FAH (m)	1.7	1.7	1.7	-	2.0	2.0	2.0	2.25	2.25	2.25	2.25	2.5	2.5	2.5	2.5	-
	min.	FAB (m)	0.45	0.45	0.45	-	0.45	0.45	0.45	0.45	0.45	0.45	0.45	0.45	0.45	0.45	0.45	-
		FAH (m)	0.6	0.6	0.6	-	0.6	0.6	0.6	0.6	0.6	0.6	0.6	0.6	0.6	0.6	0.6	-
MV / MB		FAB (m)	-	-	-	-	-	-	1.3	-	-	-	1.3	-	-	-	1.3	-
		FAH (m)	1.5	1.5	1.3	-	1.7	1.6	1.5	1.5	1.8	1.7	1.6	1.5*	1.8	1.7	1.6*	-
	min.	FAB (m)	0.45	0.45	0.45	-	0.45	0.45	0.45	0.45	0.45	0.45	0.45	0.45	0.45	0.45	0.45	-
		FAH (m)	0.83	0.83	0.83	-	0.83	0.83	0.83	0.83	0.83	0.83	0.83	0.83	0.83	0.83	0.83	-
	min.	FAB (m)	0.65	0.65	0.65	-	0.65	0.65	0.65	0.65	0.65	0.65	0.65	0.65	0.65	0.65	0.65	-
		FAH (m)	0.9	0.9	0.9	-	0.9	0.9	0.9	0.9	0.9	0.9	0.9	0.9	0.9	0.9	0.9	-
	max.(kg)		100			160				200								

* Windlast > 1600 Pa und FAH > 2.25 m werden zwei vertikale Zusatzverriegelungen benötigt

* Wind load > 1600 Pa and FAH 2.25 m requires two vertical additional locking points

WICLINE 75

Aufliegende Beschläge
Top mounted fittings

Zulässige Flügelgrößen
Admissible sash sizes

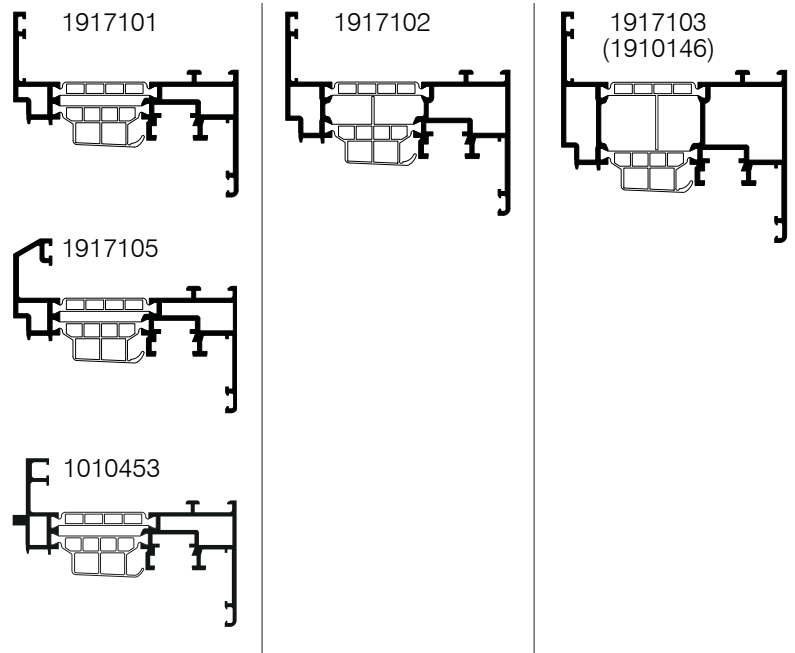
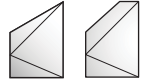

	(Pa)	1600	-	-	-	1600	1600	-	-	1600	1600*	-	-					
	(Pa)	600	-	-	-	600	600	-	-	600	600	-	-					
	max.	FAB (m)	1.1	-	-	-	1.3	1.0	-	-	1.3	1.0	-	-				
		FAH (m)	1.7	-	-	-	2.0	2.25	-	-	2.25	2.5	-	-				
	min.	FAB (m)	0.45	-	-	-	0.45	0.45	-	-	0.45	0.45	-	-				
		FAH (m)	0.6**	-	-	-	0.6**	0.6**	-	-	0.6**	0.6**	-	-				
MV / MB		FAB (m)	-	-	-	-	-	-	-	-	-	-	-	-				
		FAH (m)	1.3	-	-	-	1.5	1.5	-	-	1.6	1.5*	-	-				
	min.	FAB (m)	-	-	-	-	-	-	-	-	-	-	-	-				
		FAH (m)	-	-	-	-	-	-	-	-	-	-	-	-				
	min.	FAB (m)	-	-	-	-	-	-	-	-	-	-	-	-				
		FAH (m)	-	-	-	-	-	-	-	-	-	-	-	-				
	max.(kg)		100				160				160							

* Windlast > 1200 Pa und FAH > 2.25 m werden zwei vertikale Zusatzverriegelungen benötigt

* Wind load > 1200 Pa and FAH > 2.25 m requires two vertical additional locking points

** FAH_{min.} begrenzt über FAH1_{min.} = 0.6 m

** FAH_{min.} limited through FAH1_{min.} = 0.6 m



FAB1_{min.} = 0.3 m

WICLINE 75

Aufliegende Beschläge
Top mounted fittings

Zulässige Flügelgrößen
Admissible sash sizes

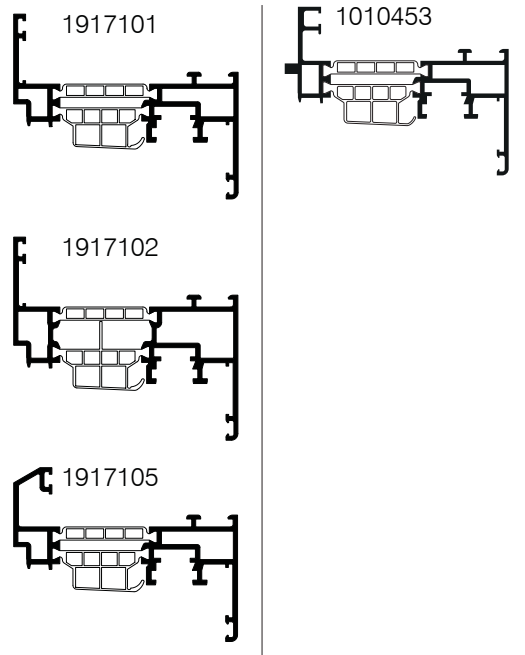
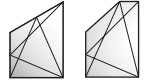

	(Pa)	800	1200	-	-	800	1200	-	-								
	(Pa)	600	600	-	-	600	600	-	-								
	max.	FAB (m)	1.3	1.2	-	-	1.3	1.2	-	-							
		FAH (m)	1.7	1.7	-	-	1.7	1.7	-	-							
	min.	FAB (m)	0.49	0.49	-	-	0.49	0.49	-	-							
		FAH (m)	0.6*	0.6*	-	-	0.6*	0.6*	-	-							
MV / MB		FAB (m)	-	-	-	-	-	-	-	-							
		FAH (m)	1.3	1.3	-	-	1.3	1.3	-	-							
	min.	FAB (m)	-	-	-	-	-	-	-	-							
		FAH (m)	-	-	-	-	-	-	-	-							
	min.	FAB (m)	-	-	-	-	-	-	-	-							
		FAH (m)	-	-	-	-	-	-	-	-							
	max.(kg)		80			80											

* FAH_{min.} begrenzt über FAH1_{min.} = 0.6 m
*FAH_{min.} limited through FAH1_{min.} = 0.6 m



FAB1_{min.} = 0.3 m

WICLINE 75

Aufliegende Beschläge
Top mounted fittings

Zulässige Flügelgrößen
Admissible sash sizes

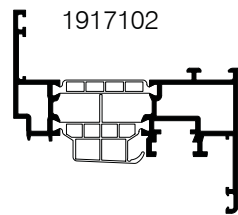

	(Pa)	800	800	-	-												
	(Pa)	150	150	-	-												
max.	FAB (m)	1.3	1.0	-	-												
	FAH (m)	2.0	2.25	-	-												
min.	FAB (m)	0.45	0.45	-	-												
	FAH (m)	0.6*	0.6*	-	-												
MV / MB	FAB (m)	-	-	-	-												
	FAH (m)	1.5**	1.5**	-	-												
	min.	FAB (m)	-	-	-	-											
		FAH (m)	-	-	-	-											
	min.	FAB (m)	-	-	-	-											
		FAH (m)	-	-	-	-											
	max.(kg)		160														

* FAH_{min.} begrenzt über FAH1_{min.} = 0.6 m
*FAH_{min.} limited through FAH1_{min.} = 0.6 m

** MV ab FAH1 > 1.3 m
** MV from FAH1 > 1.3 m

WICLINE 75

Aufliegende Beschläge
Top mounted fittings

Zulässige Flügelgrößen
Admissible sash sizes

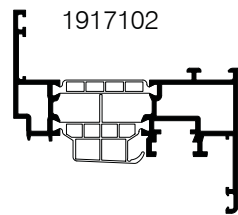

	(Pa)	800	800	800	-													
	(Pa)	150	150	150	-													
	max.	FAB (m)	1.3	1.2	1.1	-												
		FAH (m)	1.7	1.8	1.9	-												
	min.	FAB (m)	0.7	0.7	0.7	-												
		FAH (m)	0.6*	0.6*	0.6*	-												
MV / MB	FAB (m)	-	-	-	-													
	FAH (m)	-	-	-	-													
	min.	FAB (m)	-	-	-	-												
		FAH (m)	-	-	-	-												
	min.	FAB (m)	-	-	-	-												
		FAH (m)	-	-	-	-												
	max.(kg)		80															

* FAH_{min.} begrenzt über FAH1_{min.} = 0.6 m
*FAH_{min.} limited through FAH1_{min.} = 0.6 m

WICLINE 75

Aufliegende Beschläge
Top mounted fittings

Zulässige Flügelgrößen
Admissible sash sizes



		1917101				1917102				1917103 (1910146)				1917104 (1910147)				
	(Pa) (m ²)**	800	1200	1600 (1.5)**	-	800	1200	1600 (1.7)**	1600 (1.7)**	800	1200	1600 (1.8)**	1600* (1.8)**	800	1200	1600* (2.0)**	-	
	(Pa)	150	300	600	-	150	300	600	600	150	300	600	600	150	300	450	-	
max.	FAB (m)	1.3	1.2	1.1	-	1.6	1.5	1.4	1.0	1.6	1.6	1.5	1.0	1.7	1.7	1.6	-	
	FAH (m)	1.7	1.7	1.7	-	2.0	2.0	2.0	2.25	2.25	2.25	2.25	2.5	2.5	2.5	2.5	-	
min.	FAB (m)	0.45	0.45	0.45	-	0.45	0.45	0.45	0.45	0.45	0.45	0.45	0.45	0.45	0.45	0.45	-	
	FAH (m)	0.68	0.68	0.68	-	0.68	0.68	0.68	0.68	0.68	0.68	0.68	0.68	0.68	0.68	0.68	-	
MV / MB	FAB (m)	-	-	-	-	-	-	1.3	-	1.3	1.3	1.3	-	1.3	1.3	1.3	-	
	FAH (m)	1.5	1.5	1.3	-	1.7	1.6	1.5	1.5	1.8	1.7	1.6	1.5*	1.8	1.7	1.6*	-	
	min.	FAB (m)	0.65	0.65	0.65	-	0.65	0.65	0.65	0.65	0.65	0.65	0.65	0.65	0.65	0.65	0.65	-
		FAH (m)	1.05	1.05	1.05	-	1.05	1.05	1.05	1.05	1.05	1.05	1.05	1.05	1.05	1.05	1.05	-
	min.	FAB (m)	0.65	0.65	0.65	-	0.65	0.65	0.65	0.65	0.65	0.65	0.65	0.65	0.65	0.65	0.65	-
		FAH (m)	1.12	1.12	1.12	-	1.12	1.12	1.12	1.12	1.12	1.12	1.12	1.12	1.12	1.12	1.12	-
	max.(kg)									160								

* Windlast > 1200 Pa und FAH > 2.25 m werden zwei vertikale Zusatzverriegelungen benötigt

* Wind load > 1200 Pa and FAH 2.25 m requires two vertical additional locking points

** Flügelgröße > () m² benötigt eine horizontale Zusatzverriegelung

** Sash size > () m² requires a horizontal additional locking point

WICLINE 75

Aufliegende Beschläge
Top mounted fittings

Zulässige Flügelgrößen
Admissible sash sizes



		1917101				1917102				1917103 (1910146)				1917104 (1910147)				
		1917105												1917115				
1917121																		
		(Pa)	800	1200	1600	-	800	1200	1600	1600	800	1200	1600	1600	800	1200	1600	-
		(m²)**			(1.5)**				(1.7)**	(1.7)**			(1.8)**	(1.8)**			(2.0)**	
		(Pa)	150	300	600	-	150	300	600	600	150	300	600	600	150	300	600	-
max.	FAB (m)	1.2	1.2	1.2	-	1.3	1.3	1.3	1.0	1.3	1.3	1.3	1.0	1.3	1.3	1.3	-	
	FAH (m)	1.7	1.6	1.5	-	1.9	1.8	1.7	2.25	2.0	1.9	1.7	2.25	2.25	2.25	2.25	-	
min.	FAB (m)	0.45	0.45	0.45	-	0.45	0.45	0.45	0.45	0.45	0.45	0.45	0.45	0.45	0.45	0.45	-	
	FAH (m)	0.72	0.72	0.72	-	0.72	0.72	0.72	0.72	0.72	0.72	0.72	0.72	0.72	0.72	0.72	-	
MV / MB	FAB (m)	-	-	-	-	-	-	-	-	-	-	-	-	-	-	-	-	
	FAH (m)	1.5	1.5	1.3	-	1.7	1.6	1.5	1.5	1.8	1.7	1.6	1.5	1.8	1.7	1.6	-	
	min.	FAB (m)	-	-	-	-	-	-	-	-	-	-	-	-	-	-	-	
	FAH (m)	-	-	-	-	-	-	-	-	-	-	-	-	-	-	-	-	
	min.	FAB (m)	-	-	-	-	-	-	-	-	-	-	-	-	-	-	-	
	FAH (m)	-	-	-	-	-	-	-	-	-	-	-	-	-	-	-	-	
	max. (kg)		100				160											

** Flügelgröße > ()m² benötigt eine horizontale Zusatzverriegelung am Gehflügel

** Sash size > ()m² requires a horizontal additional locking point on the active leaf

WICLINE 75

Aufliegende Beschläge
Top mounted fittings

Zulässige Flügelgrößen
Admissible sash sizes

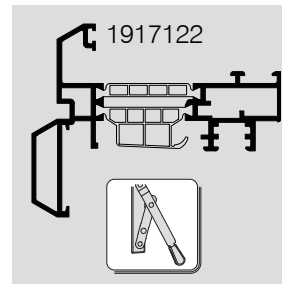
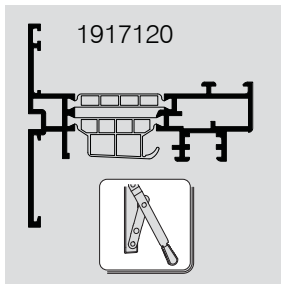
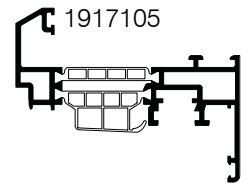
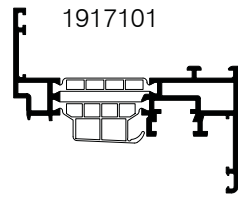

	(Pa)	800	1200	-	-
	(Pa)	300	600	-	-
max.	FAB (m)	1.2	1.2	-	-
	FAH (m)	1.6	1.5	-	-
min.	FAB (m)	0.45	0.45	-	-
	FAH (m)	0.72	0.72	-	-
MV / MB	FAB (m)	-	-	-	-
	FAH (m)	1.4	1.3	-	-
	min. FAB (m)	-	-	-	-
	min. FAH (m)	-	-	-	-
	min. FAB (m)	-	-	-	-
	min. FAH (m)	-	-	-	-
	max.(kg)		100		

	(Pa)	800	1200	-	-
	(Pa)	300	600	-	-
max.	FAB (m)	1.2	1.2	-	-
	FAH (m)	1.6	1.5	-	-
min.	FAB (m)	0.45	0.45	-	-
	FAH (m)	0.72	0.72	-	-
MV / MB	FAB (m)	-	-	-	-
	FAH (m)	1.4	1.3	-	-
	min. FAB (m)	-	-	-	-
	min. FAH (m)	-	-	-	-
	min. FAB (m)	-	-	-	-
	min. FAH (m)	-	-	-	-
	max.(kg)		100		

WICLINE 75

Aufliegende Beschläge
Top mounted fittings

Zulässige Flügelgrößen
Admissible sash sizes

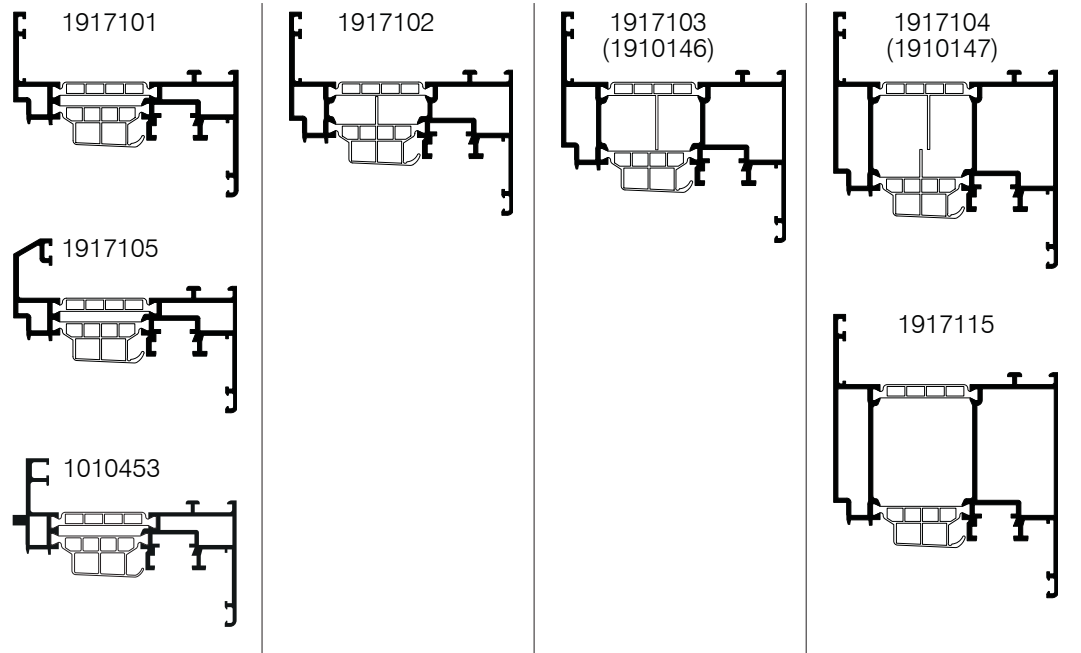

	(Pa)	800	1200	2000	-	800	1200	2000	2000	800	1200	2000	2000*	800	1200	2000*	-	
	(Pa)	150	300	600	-	150	300	600	600	150	300	600	600	150	300	600	-	
	max.	FAB (m)	1.3	1.2	1.1	-	1.6	1.5	1.4	1.0	1.6	1.6	1.5	1.0	1.7	1.7	1.6	-
		FAH (m)	1.7	1.7	1.7	-	2.0	2.0	2.0	2.25	2.25	2.25	2.25	2.5	2.5	2.5	2.5	-
	min.	FAB (m)	0.425	0.425	0.425	-	0.425	0.425	0.425	0.425	0.425	0.425	0.425	0.425	0.425	0.425	0.425	-
		FAH (m)	0.7	0.7	0.7	-	0.7	0.7	0.7	0.7	0.7	0.7	0.7	0.7	0.7	0.7	0.7	-
MV / MB		FAB (m)	-	-	-	-	-	-	1.3	-	-	-	1.3	-	-	-	1.3	-
		FAH (m)	1.5	1.5	1.3	-	1.7	1.6	1.5	1.5	1.8	1.7	1.6	1.5*	1.8	1.7	1.6*	-
	min.	FAB (m)	0.425	0.425	0.425	-	0.425	0.425	0.425	0.425	0.425	0.425	0.425	0.425	0.425	0.425	0.425	-
		FAH (m)	0.7	0.7	0.7	-	0.7	0.7	0.7	0.7	0.7	0.7	0.7	0.7	0.7	0.7	0.7	-
	min.	FAB (m)	0.68	0.68	0.68	-	0.68	0.68	0.68	0.68	0.68	0.68	0.68	0.68	0.68	0.68	0.68	-
		FAH (m)	0.9	0.9	0.9	-	0.9	0.9	0.9	0.9	0.9	0.9	0.9	0.9	0.9	0.9	0.9	-
	max.(kg)		100			130				130				130				

* Windlast > 1600 Pa und FAH > 2.25 m werden zwei vertikale Zusatzverriegelungen benötigt
* Wind load > 1600 Pa and FAH 2.25 m requires two vertical additional locking pointst

WICLINE 75

Aufliegende Beschläge
Top mounted fittings

Zulässige Flügelgrößen
Admissible sash sizes

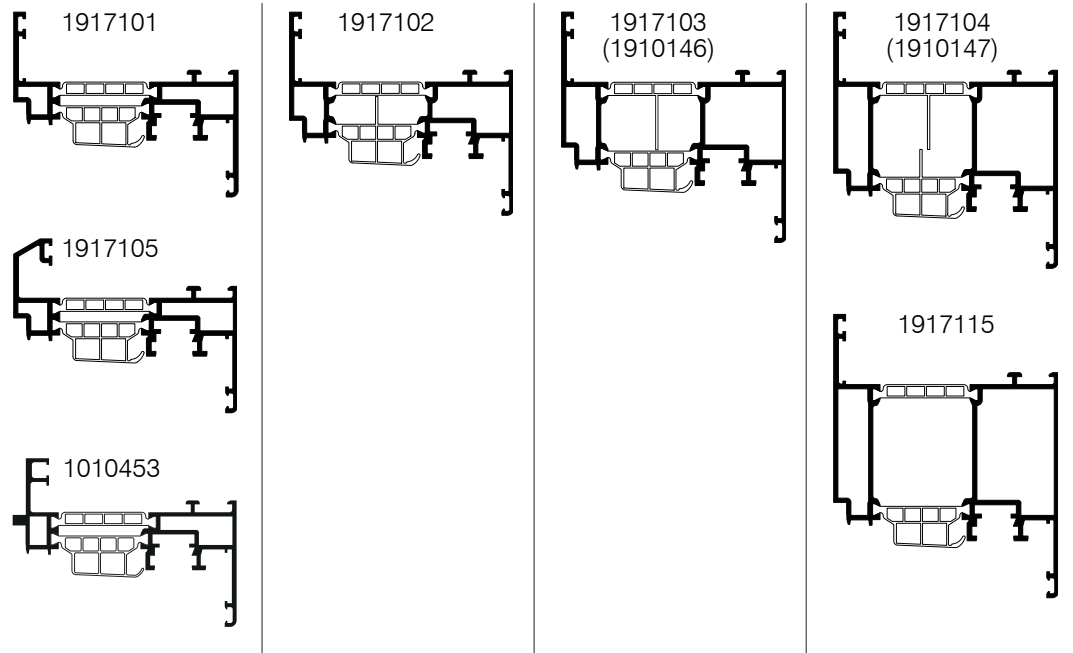

	(Pa)	800	1200	2000	-	800	1200	2000	2000	800	1200	2000	2000*	800	1200	2000*	-		
	(Pa)	150	300	600	-	150	300	600	600	150	300	600	600	150	300	600	-		
	max.	FAB (m)	1.7	1.7	1.7	-	2.0	2.0	2.0	2.25	2.25	2.25	2.25	2.5	2.5	2.5	2.5	-	
		FAH (m)	1.3	1.2	1.1	-	1.6	1.5	1.4	1.0	1.6	1.6	1.5	1.0	1.7	1.7	1.6	-	
	min.	FAB (m)	0.6	0.6	0.6	-	0.6	0.6	0.6	0.6	0.6	0.6	0.6	0.6	0.6	0.6	0.6	0.6	-
		FAH (m)	0.45	0.45	0.45	-	0.45	0.45	0.45	0.45	0.45	0.45	0.45	0.45	0.45	0.45	0.45	0.45	-
MV / MB		FAB (m)	1.5	1.5	1.3	-	1.7	1.6	1.5	1.5	1.8	1.7	1.6	1.5*	1.8	1.7	1.6*	-	
		FAH (m)	-	-	-	-	-	-	1.3	-	-	-	1.3	-	-	-	1.3	-	
	min.	FAB (m)	0.74	0.74	0.74	-	0.74	0.74	0.74	0.74	0.74	0.74	0.74	0.74	0.74	0.74	0.74	0.74	-
		FAH (m)	0.45	0.45	0.45	-	0.45	0.45	0.45	0.45	0.45	0.45	0.45	0.45	0.45	0.45	0.45	0.45	-
	min.	FAB (m)	0.9	0.9	0.9	-	0.9	0.9	0.9	0.9	0.9	0.9	0.9	0.9	0.9	0.9	0.9	0.9	-
		FAH (m)	0.6	0.6	0.6	-	0.6	0.6	0.6	0.6	0.6	0.6	0.6	0.6	0.6	0.6	0.6	0.6	-
	max. (kg)		100			130				130				130					

* Windlast > 1600 Pa und FAB > 2.25 m werden zwei horizontale Zusatzverriegelungen benötigt

* Wind load > 1600 Pa and FAB 2.25 m requires two horizontal additional locking points

WICLINE 75

Aufliegende Beschläge
Top mounted fittings

Zulässige Flügelgrößen
Admissible sash sizes

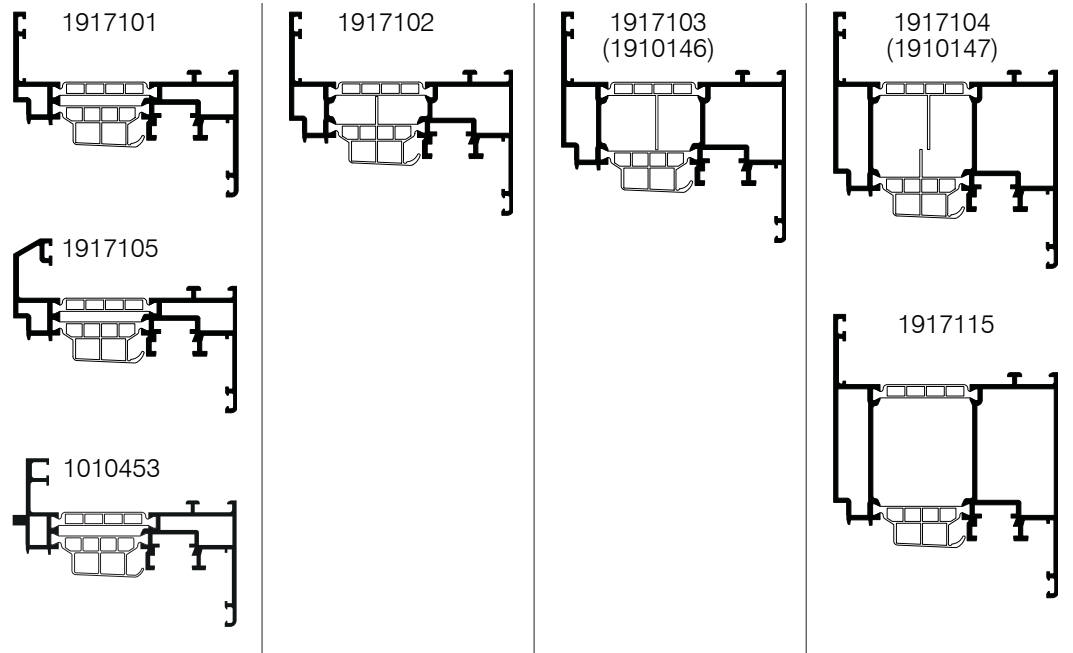

	(Pa)	800	1200	2000	-	800	1200	2000	2000	800	1200	2000	2000*	800	1200	2000*	-	
	(Pa)	150	300	600	-	150	300	600	600	150	300	600	600	150	300	600	-	
	max.	FAB (m)	1.7	1.7	1.7	-	2.0	2.0	2.0	2.25	2.25	2.25	2.25	2.5	2.5	2.5	2.5	-
		FAH (m)	1.3	1.2	1.1	-	1.6	1.5	1.4	1.0	1.6	1.6	1.5	1.0	1.7	1.7	1.6	-
	min.	FAB (m)	0.55	0.55	0.55	-	0.55	0.55	0.55	0.55	0.55	0.55	0.55	0.55	0.55	0.55	0.55	-
		FAH (m)	0.45	0.45	0.45	-	0.45	0.45	0.45	0.45	0.45	0.45	0.45	0.45	0.45	0.45	0.45	-
MV / MB		FAB (m)	1.5	1.5	1.3	-	1.7	1.6	1.5	1.5	1.8	1.7	1.6	1.5*	1.8	1.7	1.6*	-
		FAH (m)	-	-	-	-	-	-	1.3	-	-	-	1.3	-	-	-	1.3	-
	min.	FAB (m)	0.88	0.88	0.88	-	0.88	0.88	0.88	0.88	0.88	0.88	0.88	0.88	0.88	0.88	0.88	-
		FAH (m)	0.45	0.45	0.45	-	0.45	0.45	0.45	0.45	0.45	0.45	0.45	0.45	0.45	0.45	0.45	-
	min.	FAB (m)	0.88	0.88	0.88	-	0.88	0.88	0.88	0.88	0.88	0.88	0.88	0.88	0.88	0.88	0.88	-
		FAH (m)	0.6	0.6	0.6	-	0.6	0.6	0.6	0.6	0.6	0.6	0.6	0.6	0.6	0.6	0.6	-
	max. (kg)		80			80 / 120												

* Windlast > 1600 Pa und FAB > 2.25 m werden zwei horizontale Zusatzverriegelungen/Mittelbänder benötigt

* Wind load > 1600 Pa and FAB 2.25 m requires two horizontal additional locking points/centre hinges

WICLINE 75

Aufliegende Beschläge
Top mounted fittings

Zulässige Flügelgrößen
Admissible sash sizes

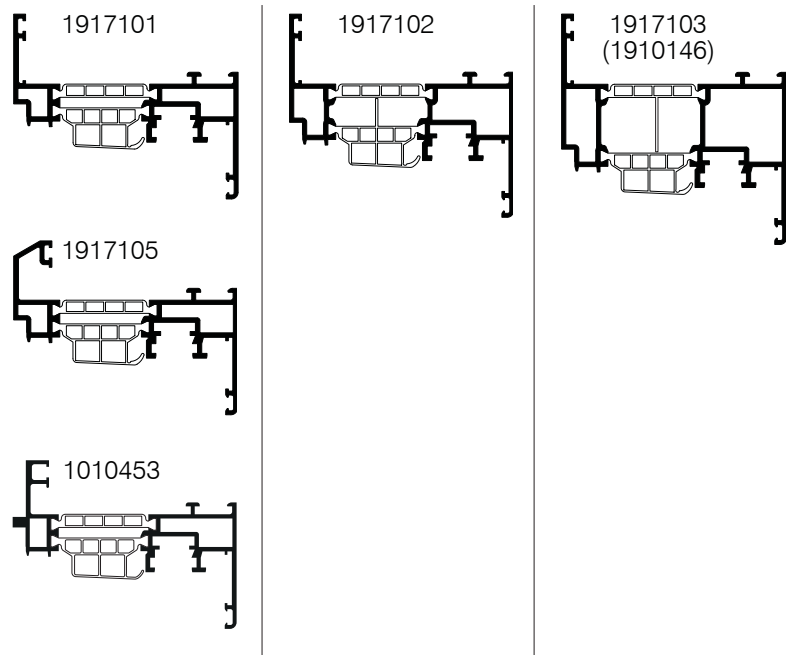

	(Pa)	800	1200	1600	-	800	1200	1600	-	800	1200	1600	-					
	(Pa)	150	300	600	-	150	300	600	-	150	300	600	-					
	max.	FAB (m)	1.7	1.7	1.7	-	2.0	2.0	2.0	-	2.0	2.0	2.0	-				
		FAH (m)	1.3	1.2	1.1	-	1.6	1.5	1.3	-	1.6	1.6	1.3	-				
	min.	FAB (m)	0.55	0.55	0.55	-	0.55	0.55	0.55	-	0.55	0.55	0.55	-				
		FAH (m)	0.45	0.45	0.45	-	0.45	0.45	0.45	-	0.45	0.45	0.45	-				
MV / MB		FAB (m)	1.5	1.5	1.3	-	1.7	1.6	1.5	-	1.8	1.7	1.6	-				
		FAH (m)	-	-	-	-	-	-	-	-	-	-	-	-				
	min.	FAB (m)	-	-	-	-	-	-	-	-	-	-	-	-				
		FAH (m)	-	-	-	-	-	-	-	-	-	-	-	-				
	min.	FAB (m)	-	-	-	-	-	-	-	-	-	-	-	-				
		FAH (m)	-	-	-	-	-	-	-	-	-	-	-	-				
	max.(kg)		80															

WICLINE 75

Aufliegende Beschläge
Top mounted fittings

Zulässige Flügelgrößen
Admissible sash sizes

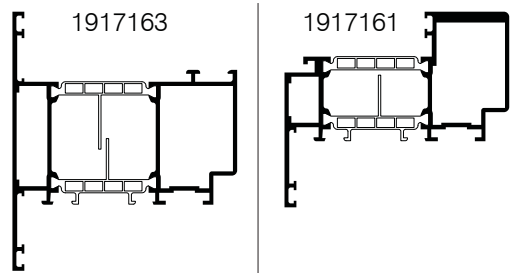

Bei Verwendung von Elektroantrieben FAH_{min.} auf Antrieb anpassen. Bei Anwendung in Fassaden ist eine Riegelüberprüfung erforderlich.

When using electric drives adjust FAH_{min.} to drive. Check transom profile for application in façades.

	(Pa)	-	2000	2000	2000	-	2000	2000	2000								
	(Pa)	-	600	600	600	-	600	600	600								
max.	FAB (m)	-	1.5	2.0	2.0	-	1.4	1.8	1.4								
	FAH (m)	-	1.5	2.0	2.0	-	1.4	1.4	1.8								
min.	FAB (m)	-	0.6	0.6	0.6	-	0.6	0.6	0.6								
	FAH (m)	-	0.425	0.425	0.425	-	0.425	0.425	0.425								
MV / MB	FAB (m)	-	-	1.5	1.5*	-	-	1.4	-								
	FAH (m)	-	-	1.5	1.5	-	-	-	1.4								
	min.	FAB (m)	-	-	-	-	-	-	-								
	FAH (m)	-	-	-	-	-	-	-	-								
	min.	FAB (m)	-	-	-	-	-	-	-								
	FAH (m)	-	-	-	-	-	-	-	-								
	max. (kg)		80	100	150***		80	100									

* FAB > 1.8 m werden zwei horizontale Mittelbänder (MB) benötigt
* FAB > 1.8 m requires two horizontal centre hinges (MB)

*** Zusätzliche Verklebung > 120 kg
*** Additional gluing > 120 kg



FAH ≤ 2.5 x FAB

WICLINE 75

Aufliegende Beschläge
Top mounted fittings

Zulässige Flügelgrößen
Admissible sash sizes

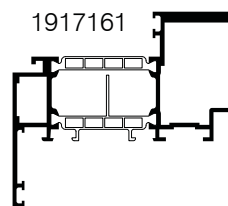
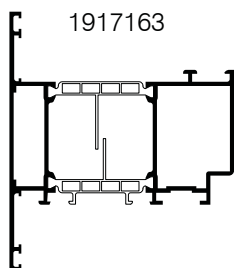

	(Pa)	-	2000	2000	2000	-	2000	2000	2000	-	2000	2000	2000	-	2000	2000	2000	
	(Pa)	-	600	600	600	-	600	600	600	-	600	600	600	-	600	600	600	
	max.	FAB (m)	-	2.4	2.3	2.1	-	1.9	1.7	2.0	-	2.3	2.2	2.1	-	2.0	1.9	1.8
		FAH (m)	-	1.4	1.5	1.6	-	1.8	2.0	1.7	-	1.0	1.1	1.2	-	1.4	1.6	1.8
	min.	FAB (m)	-	0.7	0.7	0.7	-	0.7	0.7	0.7	-	0.7	0.7	0.7	-	0.7	0.7	0.7
		FAH (m)	-	0.7	0.7	0.7	-	0.7	0.7	0.7	-	0.7	0.7	0.7	-	0.7	0.7	0.7
MV / MB		FAB (m)	-	1.5	1.5	1.5	-	1.5	1.5	1.5	-	1.4	1.4	1.4	-	1.4	1.4	1.4
		FAH (m)	-	-	-	-	-	-	-	-	-	-	-	-	-	-	-	-
	min.	FAB (m)	-	-	-	-	-	-	-	-	-	-	-	-	-	-	-	-
		FAH (m)	-	-	-	-	-	-	-	-	-	-	-	-	-	-	-	-
	min.	FAB (m)	-	-	-	-	-	-	-	-	-	-	-	-	-	-	-	-
		FAH (m)	-	-	-	-	-	-	-	-	-	-	-	-	-	-	-	-
	max.	max.(kg)	100			100			80			100						

WICLINE 75

Aufliegende Beschläge
Top mounted fittings

Zulässige Flügelgrößen
Admissible sash sizes

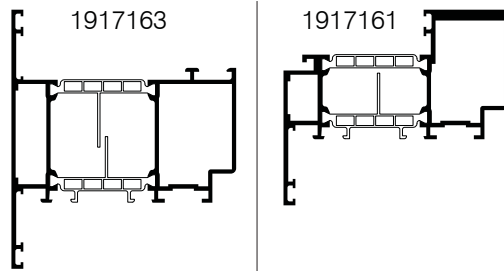

	(Pa)	800	800	-	-	800	800	-	-								
	(Pa)	150	150	-	-	150	150	-	-								
max.	FAB (m)	1.8	1.7	-	-	1.8	1.6	-	-								
	FAH (m)	1.8	2.0	-	-	1.8	1.9	-	-								
min.	FAB (m)	0.7	0.7	-	-	0.7	0.7	-	-								
	FAH (m)	0.7	0.7	-	-	0.7	0.7	-	-								
MV / MB	FAB (m)	-	-	-	-	-	-	-	-								
	FAH (m)	1.5	1.5	-	-	1.4	1.4	-	-								
	min.	FAB (m)	-	-	-	-	-	-	-								
	FAH (m)	-	-	-	-	-	-	-	-								
	min.	FAB (m)	-	-	-	-	-	-	-								
	FAH (m)	-	-	-	-	-	-	-	-								
	max.(kg)	100			100												

WICLINE 75

Aufliegende Beschläge, Fenstertür einwärts
Top mounted fittings, casement door inwards

Zulässige Flügelgrößen
Admissible sash sizes

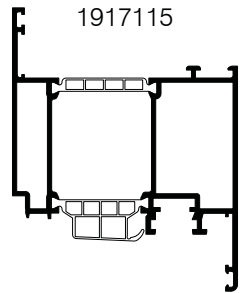
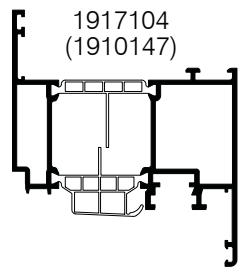

	(Pa)	800	1200	1600	2000*													
	(Pa)	150	300	600	600													
max.	FAB (m)	1.7	1.7	1.6	1.6													
	FAH (m)	2.5	2.5	2.5	2.5													
min.	FAB (m)	0.45	0.45	0.45	0.45													
	FAH (m)	0.95	0.95	0.95	0.95													
MV / MB	FAB (m)	-	-	-	1.3													
	FAH (m)	1.8	1.7	1.6	1.6*													
	min.	FAB (m)	-	-	-	-												
		FAH (m)	-	-	-	-												
	min.	FAB (m)	-	-	-	-												
		FAH (m)	-	-	-	-												
	max.(kg)		160															

* Windlast > 1200 Pa und FAH > 2.25 m werden zwei vertikale Zusatzverriegelung benötigt

* Wind load > 1200 Pa and FAH > 2.25 m requires two vertical additional locking points

WICLINE 75

Aufliegende Beschläge, Fenstertür einwärts, barrierefrei
 Top mounted fittings, casement door inwards, accessible

Zulässige Flügelgrößen
 Admissible sash sizes

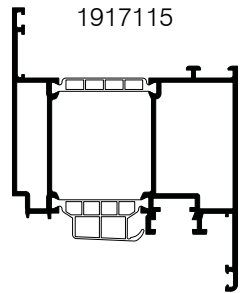
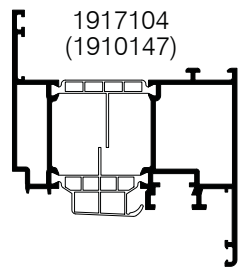

	(Pa)	800	1200	1600	2000*													
	(Pa)	150	300	600	600													
max.	FAB (m)	1.4	1.4	1.3	1.3													
	FAH (m)	2.5	2.5	2.5	2.5													
min.	FAB (m)	0.45	0.45	0.45	0.45													
	FAH (m)	0.95	0.95	0.95	0.95													
MV / MB	FAB (m)	-	-	-	-													
	FAH (m)	1.8	1.7	1.6	1.5*													
	min.	FAB (m)	-	-	-	-												
		FAH (m)	-	-	-	-												
	min.	FAB (m)	-	-	-	-												
		FAH (m)	-	-	-	-												
	max.(kg)	130																

* Windlast > 1200 Pa und FAH > 2.25 m werden zwei vertikale Zusatzverriegelung benötigt

* Wind load > 1200 Pa and FAH > 2.25 m requires two vertical additional locking points

WICLINE 75

Aufliegende Beschläge, Fenstertür einwärts
Top mounted fittings, casement door inwards

Zulässige Flügelgrößen
Admissible sash sizes



		1917104 (1910147)		1917115															
	(Pa)	800	1200	1600* (2.0)**	-														
	(Pa)	150	300	600	-														
max.	FAB (m)	1.7	1.7	1.6	-														
	FAH (m)	2.5	2.5	2.5	-														
min.	FAB (m)	0.45	0.45	0.45	-														
	FAH (m)	0.95	0.95	0.95	-														
MV / MB	FAB (m)	1.3	1.3	1.3	-														
	FAH (m)	1.8	1.7	1.6*	-														
	min.	FAB (m)	-	-	-	-													
		FAH (m)	-	-	-	-													
	min.	FAB (m)	-	-	-	-													
		FAH (m)	-	-	-	-													
	max.(kg)	160																	

* Windlast > 1200 Pa und FAH > 2.25 m werden zwei vertikale Zusatzverriegelung benötigt
* Wind load > 1200 Pa and FAH > 2.25 m requires two vertical additional locking points

** Flügelgröße > ()m² benötigt eine horizontale Zusatzverriegelung am Gehflügel und Standflügel
** Sash size > ()m² requires a horizontal additional locking points in active leaf and inactive leaf

WICLINE 75

Aufliegende Beschläge, Fenstertür einwärts
Top mounted fittings, casement door inwards

Zulässige Flügelgrößen
Admissible sash sizes



	(Pa)	800	1200	1600 (2.0)**	-										
	(Pa)	150	300	600	-										
max.	FAB (m)	1.3	1.3	1.3	-										
	FAH (m)	2.25	2.25	2.25	-										
min.	FAB (m)	0.45	0.45	0.45	-										
	FAH (m)	0.95	0.95	0.95	-										
MV / MB	FAB (m)	-	-	-	-										
	FAH (m)	1.8	1.7	1.6	-										
	min.	FAB (m)	-	-	-	-									
		FAH (m)	-	-	-	-									
	min.	FAB (m)	-	-	-	-									
		FAH (m)	-	-	-	-									
	max. (kg)	160													

** Flügelgröße > ()m² benötigt eine horizontale Zusatzverriegelung am Gehflügel
** Sash size > ()m² requires a horizontal additional locking points in active leaf

WICLINE 75

Aufliegende Beschläge, Fenstertür einwärts, barrierefrei
 Top mounted fittings, casement door inwards, accessible

Zulässige Flügelgrößen
 Admissible sash sizes



		<p>1917104 (1910147)</p>																
		<p>1917115</p>																
<p>1917121</p>																		
	(Pa)	400	800	1200* (2.0)**	-													
	(Pa)	150	200	300	-													
max.	FAB (m)	1.2	1.1	1.0	-													
	FAH (m)	2.5	2.5	2.5	-													
min.	FAB (m)	0.45	0.45	0.45	-													
	FAH (m)	0.95	0.95	0.95	-													
MV / MB	FAB (m)	-	-	-	-													
	FAH (m)	1.8	1.7	1.6*	-													
	min. FAB (m)	-	-	-	-													
	min. FAH (m)	-	-	-	-													
	min. FAB (m)	-	-	-	-													
	min. FAH (m)	-	-	-	-													
	max.(kg)	130																

* Windlast > 800 Pa und FAH > 2.25 m werden zwei vertikale Zusatzverriegelung benötigt
 * Wind load > 800 Pa and FAH > 2.25 m requires two vertical additional locking points

** Flügelgröße > () m² benötigt eine horizontale Zusatzverriegelung am Gehflügel oben
 ** Sash size > () m² requires a horizontal additional locking points in active leaf on top

WICLINE 75

Aufliegende Beschläge, Fenstertür auswärts
Top mounted fittings, casement door outwards

Zulässige Flügelgrößen
Admissible sash sizes

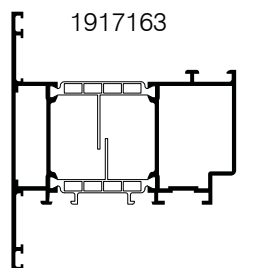

	(Pa)	2000	2000	2000	2000												
	(Pa)	600	600	600	600												
max.	FAB (m)	1.2	1.5	1.4	1.2												
	FAH (m)	2.25	2.1	2.25	2.5												
min.	FAB (m)	0.45	0.45	0.45	0.45												
	FAH (m)	0.75	0.75	0.75	0.75												
MV / MB	FAB (m)	-	1.3	1.3	-												
	FAH (m)	1.4	1.4	1.4	1.4												
	min.	FAB (m)	-	-	-	-											
	FAH (m)	-	-	-	-												
	min.	FAB (m)	-	-	-	-											
	FAH (m)	-	-	-	-												
	max.(kg)	80	100														

WICLINE 75

Aufliegende Beschläge, Fenstertür auswärts, barrierefrei
 Top mounted fittings, casement door outwards, accessible

Zulässige Flügelgrößen
 Admissible sash sizes

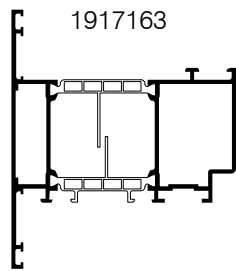

	(Pa)	800	1200	2000	-												
	(Pa)	150	300	600	-												
max.	FAB (m)	1.3	1.2	1.1	-												
	FAH (m)	2.25	2.25	2.25	-												
min.	FAB (m)	0.45	0.45	0.45	-												
	FAH (m)	0.75	0.75	0.75	-												
MV / MB	FAB (m)	-	-	-	-												
	FAH (m)	1.4	1.4	1.4	-												
	min.	FAB (m)	-	-	-	-											
		FAH (m)	-	-	-	-											
	min.	FAB (m)	-	-	-	-											
		FAH (m)	-	-	-	-											
	max.(kg)	80 / 100															



Bei Einsatz von 4x Bänder Flügelgewicht
 max. 100 kg möglich
 When using 4x hinges sash weight
 max. 100 kg possible

WICLINE 75

Aufliegende Beschläge, Fenstertür auswärts
 Top mounted fittings, casement door outwards

Zulässige Flügelgrößen
 Admissible sash sizes

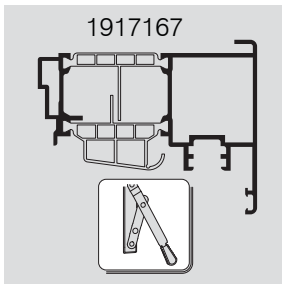
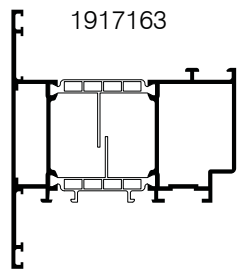
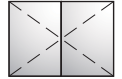

	(Pa)	1600	1600	1600	-													
	(Pa)	600	600	600	-													
max.	FAB (m)	1.3	1.2	1.0	-													
	FAH (m)	2.1	2.25	2.5	-													
min.	FAB (m)	0.45	0.45	0.45	-													
	FAH (m)	0.75	0.75	0.75	-													
MV / MB	FAB (m)	-	-	-	-													
	FAH (m)	1.4	1.4	1.4	-													
	min.	FAB (m)	-	-	-	-												
		FAH (m)	-	-	-	-												
	min.	FAB (m)	-	-	-	-												
		FAH (m)	-	-	-	-												
	max.(kg)	80 / 100																







Bei Einsatz von 4x Bänder Flügelgewicht
 max. 100 kg möglich
 When using 4x hinges sash weight
 max. 100 kg possible

WICLINE 75

Aufliegende Beschläge, Fenstertür auswärts, barrierefrei
 Top mounted fittings, casement door outwards, accessible

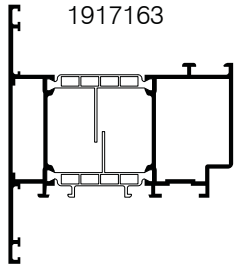
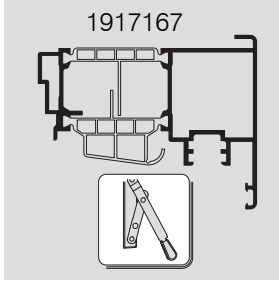
Zulässige Flügelgrößen
 Admissible sash sizes

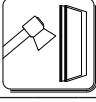
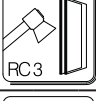

		 <p>1917163</p>																
		 <p>1917167</p>																
	(Pa)	400	800	1200	-													
	(Pa)	150	200	300	-													
max.	FAB (m)	1.2	1.1	1.0	-													
	FAH (m)	2.25	2.25	2.25	-													
min.	FAB (m)	0.45	0.45	0.45	-													
	FAH (m)	0.75	0.75	0.75	-													
MV / MB	FAB (m)	-	-	-	-													
	FAH (m)	1.4	1.4	1.4	-													
	min. FAB (m)	-	-	-	-													
	min. FAH (m)	-	-	-	-													
	min. FAB (m)	-	-	-	-													
	min. FAH (m)	-	-	-	-													
	max. (kg)	80 / 100																



Bei Einsatz von 4x Bänder Flügelgewicht
 max. 100 kg möglich
 When using 4x hinges sash weight
 max. 100 kg possible

WICLINE 75

Zulässige Flügelgrößen

Admissible sash sizes

Aufliegende Beschläge, ohne Zwangssteuerung OZ

Top mounted fittings, without force control

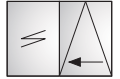

		1917116				1917117				1917116				1917117			
						1917118 *								1917118 *			
	(Pa)	-	1200	2000	-	-	1200	2000	-	-	1200	2000	-	-	1200	2000	-
	(Pa)	-	300	600	-	-	300	600	-	-	300	600	-	-	300	600	-
max.	FAB (m)	-	1.4	1.3	-	-	1.4	1.3	-	-	1.6	1.5	-	-	1.685	1.6	-
	FAH (m)	-	2.35	2.35	-	-	2.35	2.35	-	-	2.4	2.4	-	-	2.5	2.5	-
min.	FAB (m)	-	0.655	0.655	-	-	0.655	0.655	-	-	0.655	0.655	-	-	0.655	0.655	-
	FAH (m)	-	0.685	0.685	-	-	0.685	0.685	-	-	0.685	0.685	-	-	0.685	0.685	-
MV / MB	FAB (m)	-	-	-	-	-	-	-	-	-	-	-	-	-	-	-	-
	FAH (m)	-	-	-	-	-	-	-	-	-	-	-	-	-	-	-	-
	min. FAB (m)	-	-	-	-	-	-	-	-	-	-	-	-	-	-	-	-
	min. FAH (m)	-	-	-	-	-	-	-	-	-	-	-	-	-	-	-	-
	min. FAB (m)	-	-	-	-	-	-	-	-	-	-	-	-	-	-	-	-
	min. FAH (m)	-	-	-	-	-	-	-	-	-	-	-	-	-	-	-	-
	max. (kg)	100				100				160				160			

* für Einsatz von PZ-Getriebe DM 40
* for use of PZ gear DM 40



FAH ≤ 2 x FAB

WICLINE 75

Aufliegende Beschläge, mit Zwangssteuerung MZ
Top mounted fittings, with force control

Zulässige Flügelgrößen
Admissible sash sizes

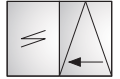

		1917116				1917117				1917116				1917117			
						1917118 *								1917118 *			
	(Pa)	-	1200	2000	-	-	1200	2000	-	800	1200	2000	-	-	1200	2000	-
	(Pa)	-	300	600	-	-	300	600	-	150	300	600	-	-	300	600	-
max.	FAB (m)	-	1.4	1.3	-	-	1.4	1.3	-	1.6	1.5	1.4	-	-	1.6	1.5	-
	FAH (m)	-	2.35	2.35	-	-	2.35	2.35	-	2.5	2.5	2.5	-	-	2.7	2.7	-
min.	FAB (m)	-	0.755	0.755	-	-	0.755	0.755	-	0.755	0.755	0.755	-	-	0.755	0.755	-
	FAH (m)	-	0.935	0.935	-	-	0.935	0.935	-	0.935	0.935	0.935	-	-	0.935	0.935	-
MV / MB	FAB (m)	-	-	-	-	-	-	-	-	-	-	-	-	-	-	-	-
	FAH (m)	-	-	-	-	-	-	-	-	-	-	-	-	-	-	-	-
	min. FAB (m)	-	-	-	-	-	-	-	-	-	-	-	-	-	-	-	-
	min. FAH (m)	-	-	-	-	-	-	-	-	-	-	-	-	-	-	-	-
	min. FAB (m)	-	-	-	-	-	-	-	-	-	-	-	-	-	-	-	-
	min. FAH (m)	-	-	-	-	-	-	-	-	-	-	-	-	-	-	-	-
	max.(kg)	100				100				160				160			

* für Einsatz von PZ-Getriebe DM 40
* for use of PZ gear DM 40



FAH ≤ 2 x FAB

WICLINE 75

Aufliegende Beschläge, mit Zwangssteuerung MZ
 Top mounted fittings, with force control

Zulässige Flügelgrößen
 Admissible sash sizes

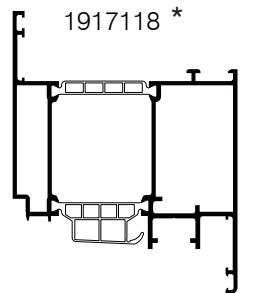
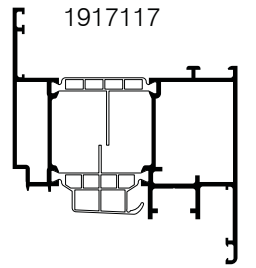
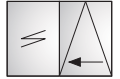

	(Pa)	800	1200	2000	-													
	(Pa)	150	300	600	-													
max.	FAB (m)	2.0	1.8	1.6	-													
	FAH (m)	2.7	2.7	2.7	-													
min.	FAB (m)	1.085	1.085	1.085	-													
	FAH (m)	0.935	0.935	0.935	-													
MV / MB	FAB (m)	-	-	-	-													
	FAH (m)	-	-	-	-													
	min. FAB (m)	-	-	-	-													
	min. FAH (m)	-	-	-	-													
	min. FAB (m)	-	-	-	-													
	min. FAH (m)	-	-	-	-													
	max.(kg)	200																

* für Einsatz von PZ-Getriebe DM 40
 * for use of PZ gear DM 40



FAH ≤ 2 x FAB

WICLINE 75

Aufliegende Beschläge
Top mounted fittings

Zulässige Flügelgrößen
Admissible sash sizes

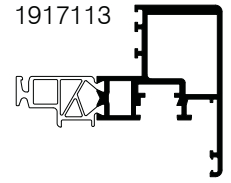
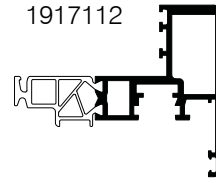
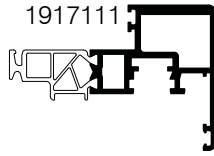
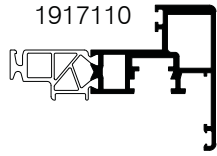

	(Pa)	800	1200	2000	-	800	1200	2000	-	800	1200	2000	-	800	1200	2000	-	
	(Pa)	150	300	600	-	150	300	600	-	150	300	600	-	150	300	600	-	
	max.	FAB (m)	1.2	1.1	1.0	-	1.3	1.2	1.1	-	1.4	1.3	1.2	-	1.4	1.4	1.3	-
		FAH (m)	1.4	1.4	1.4	-	1.6	1.6	1.6	-	1.7	1.7	1.7	-	1.8	1.8	1.8	-
	min.	FAB (m)	0.45	0.45	0.45	-	0.45	0.45	0.45	-	0.45	0.45	0.45	-	0.45	0.45	0.45	-
		FAH (m)	0.6	0.6	0.6	-	0.6	0.6	0.6	-	0.6	0.6	0.6	-	0.6	0.6	0.6	-
MV / MB	FAB (m)	-	-	-	-	-	-	-	-	-	-	-	-	-	-	-	-	
	FAH (m)	1.3	1.2	1.1	-	1.4	1.3	1.2	-	1.5	1.4	1.3	-	1.5	1.5	1.4	-	
	min.	FAB (m)	0.45	0.45	0.45	-	0.45	0.45	0.45	-	0.45	0.45	0.45	-	0.45	0.45	0.45	-
		FAH (m)	0.83	0.83	0.83	-	0.83	0.83	0.83	-	0.83	0.83	0.83	-	0.83	0.83	0.83	-
	min.	FAB (m)	0.65	0.65	0.65	-	0.65	0.65	0.65	-	0.65	0.65	0.65	-	0.65	0.65	0.65	-
		FAH (m)	0.9	0.9	0.9	-	0.9	0.9	0.9	-	0.9	0.9	0.9	-	0.9	0.9	0.9	-
	max.(kg)	80				100				100				100				

WICLINE 75

Aufliegende Beschläge
Top mounted fittings

Zulässige Flügelgrößen
Admissible sash sizes

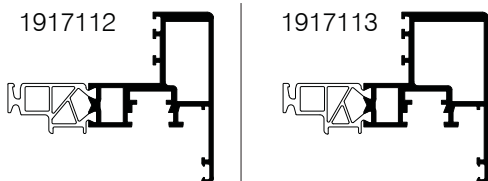

	(Pa)	800	1200	2000	-	800	1200	2000	-								
	(Pa)	150	300	600	-	150	300	600	-								
max.	FAB (m)	1.4	1.3	1.2	-	1.4	1.4	1.3	-								
	FAH (m)	1.8	2.0	2.1	-	2.0	2.0	2.25	-								
min.	FAB (m)	0.45	0.45	0.45	-	0.45	0.45	0.45	-								
	FAH (m)	0.6	0.6	0.6	-	0.6	0.6	0.6	-								
MV / MB	FAB (m)	-	-	-	-	-	-	-	-								
	FAH (m)	1.5	1.4	1.3	-	1.5	1.5	1.4	-								
	min. FAB (m)	0.45	0.45	0.45	-	0.45	0.45	0.45	-								
	min. FAH (m)	0.83	0.83	0.83	-	0.83	0.83	0.83	-								
	min. FAB (m)	0.65	0.65	0.65	-	0.65	0.65	0.65	-								
	min. FAH (m)	0.9	0.9	0.9	-	0.9	0.9	0.9	-								
	max. (kg)	130***				130***											

*** Zusätzliche Verklebung, Angaben in den Verarbeitungsrichtlinien beachten!
*** Additional gluing, pay attention to specifications in the workshop manual!

WICLINE 75

Aufliegende Beschläge
Top mounted fittings

Zulässige Flügelgrößen
Admissible sash sizes

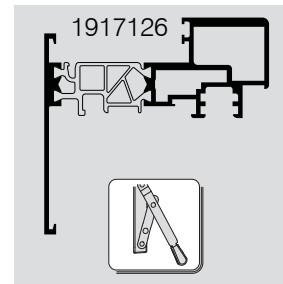
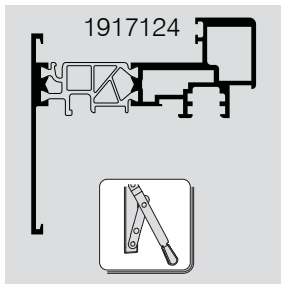
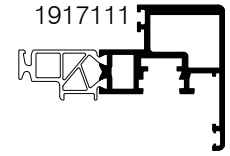
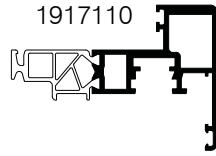

	(Pa)	400	800	1200	-
	(Pa)	150	300	600	-
max.	FAB (m)	1.2	1.1	1.0	-
	FAH (m)	1.4	1.4	1.3	-
min.	FAB (m)	0.45	0.45	0.45	-
	FAH (m)	0.72	0.72	0.72	-
MV / MB	FAB (m)	-	-	-	-
	FAH (m)	1.3	1.2	1.1	-
	min. FAB (m)	-	-	-	-
	min. FAH (m)	-	-	-	-
	min. FAB (m)	-	-	-	-
	min. FAH (m)	-	-	-	-
	max.(kg)	80			

	(Pa)	400	800	1200	-
	(Pa)	150	300	600	-
max.	FAB (m)	1.3	1.2	1.1	-
	FAH (m)	1.6	1.6	1.5	-
min.	FAB (m)	0.45	0.45	0.45	-
	FAH (m)	0.72	0.72	0.72	-
MV / MB	FAB (m)	-	-	-	-
	FAH (m)	1.4	1.3	1.2	-
	min. FAB (m)	-	-	-	-
	min. FAH (m)	-	-	-	-
	min. FAB (m)	-	-	-	-
	min. FAH (m)	-	-	-	-
	max.(kg)	100			

WICLINE 75

Aufliegende Beschläge
Top mounted fittings

Zulässige Flügelgrößen
Admissible sash sizes

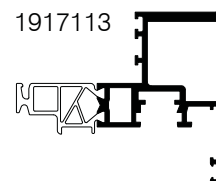
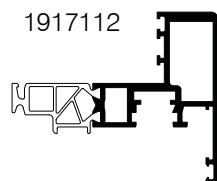
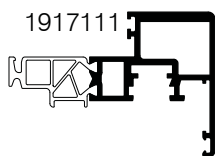
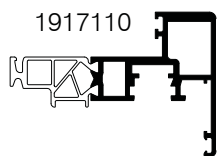

	(Pa)	800	1200	2000	-	800	1200	2000	-	800	1200	2000	-	800	1200	2000	-	
	(Pa)	150	300	600	-	150	300	600	-	150	300	600	-	150	300	600	-	
	max.	FAB (m)	1.2	1.1	1.0	-	1.3	1.2	1.1	-	1.4	1.3	1.2	-	1.4	1.4	1.3	-
		FAH (m)	1.4	1.4	1.4	-	1.6	1.6	1.6	-	1.7	1.7	1.7	-	1.8	1.8	1.8	-
	min.	FAB (m)	0.425	0.425	0.425	-	0.425	0.425	0.425	-	0.425	0.425	0.425	-	0.425	0.425	0.425	-
		FAH (m)	0.7	0.7	0.7	-	0.7	0.7	0.7	-	0.7	0.7	0.7	-	0.7	0.7	0.7	-
MV / MB	FAB (m)	-	-	-	-	-	-	-	-	-	-	-	-	-	-	-	-	
	FAH (m)	1.3	1.2	1.1	-	1.4	1.3	1.2	-	1.5	1.4	1.3	-	1.5	1.5	1.4	-	
	min.	FAB (m)	0.425	0.425	0.425	-	0.425	0.425	0.425	-	0.425	0.425	0.425	-	0.425	0.425	0.425	-
		FAH (m)	0.7	0.7	0.7	-	0.7	0.7	0.7	-	0.7	0.7	0.7	-	0.7	0.7	0.7	-
	min.	FAB (m)	0.68	0.68	0.68	-	0.68	0.68	0.68	-	0.68	0.68	0.68	-	0.68	0.68	0.68	-
		FAH (m)	0.9	0.9	0.9	-	0.9	0.9	0.9	-	0.9	0.9	0.9	-	0.9	0.9	0.9	-
	max.(kg)	80				100				100				100				

WICLINE 75

Aufliegende Beschläge
Top mounted fittings

Zulässige Flügelgrößen
Admissible sash sizes

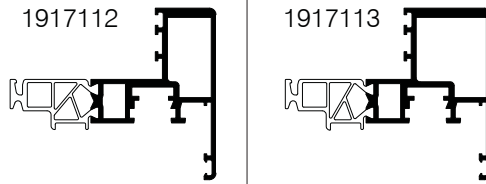

	(Pa)	800	1200	2000	-	800	1200	2000	-								
	(Pa)	150	300	600	-	150	300	600	-								
max.	FAB (m)	1.4	1.3	1.2	-	1.4	1.4	1.3	-								
	FAH (m)	1.8	2.0	2.1	-	2.0	2.0	2.25	-								
min.	FAB (m)	0.425	0.425	0.425	-	0.425	0.425	0.425	-								
	FAH (m)	0.7	0.7	0.7	-	0.7	0.7	0.7	-								
MV / MB	FAB (m)	-	-	-	-	-	-	-	-								
	FAH (m)	1.5	1.4	1.3	-	1.5	1.5	1.4	-								
	min. FAB (m)	0.425	0.425	0.425	-	0.425	0.425	0.425	-								
	min. FAH (m)	0.7	0.7	0.7	-	0.7	0.7	0.7	-								
	min. FAB (m)	0.68	0.68	0.68	-	0.68	0.68	0.68	-								
	min. FAH (m)	0.9	0.9	0.9	-	0.9	0.9	0.9	-								
	max.(kg)	130***				130***											

*** Zusätzliche Verklebung, Angaben in den Verarbeitungsrichtlinien beachten!
*** Additional gluing, pay attention to specifications in the workshop manual!

WICLINE 75

Aufliegende Beschläge
Top mounted fittings

Zulässige Flügelgrößen
Admissible sash sizes



		1917110				1917111				1917112				1917113				
	(Pa)	800	1200	2000	-	800	1200	2000	-	800	1200	2000	-	800	1200	2000	-	
	(Pa)	150	300	600	-	150	300	600	-	150	300	600	-	150	300	600	-	
	max.	FAB (m)	1.4	1.4	1.4	-	1.6	1.6	1.6	-	1.7	1.7	1.7	-	1.8	1.8	1.8	-
		FAH (m)	1.2	1.1	1.0	-	1.3	1.2	1.1	-	1.4	1.3	1.2	-	1.4	1.4	1.3	-
	min.	FAB (m)	0.6	0.6	0.6	-	0.6	0.6	0.6	-	0.6	0.6	0.6	-	0.6	0.6	0.6	-
		FAH (m)	0.45	0.45	0.45	-	0.45	0.45	0.45	-	0.45	0.45	0.45	-	0.45	0.45	0.45	-
MV / MB	FAB (m)	1.3	1.2	1.1	-	1.4	1.3	1.2	-	1.5	1.4	1.3	-	1.5	1.5	1.4	-	
	FAH (m)	-	-	-	-	-	-	-	-	-	-	-	-	-	-	-	-	
	min.	FAB (m)	0.74	0.74	0.74	-	0.74	0.74	0.74	-	0.74	0.74	0.74	-	0.74	0.74	0.74	-
		FAH (m)	0.45	0.45	0.45	-	0.45	0.45	0.45	-	0.45	0.45	0.45	-	0.45	0.45	0.45	-
	min.	FAB (m)	0.9	0.9	0.9	-	0.9	0.9	0.9	-	0.9	0.9	0.9	-	0.9	0.9	0.9	-
		FAH (m)	0.6	0.6	0.6	-	0.6	0.6	0.6	-	0.6	0.6	0.6	-	0.6	0.6	0.6	-
	max.(kg)	80				100				100				100				

WICLINE 75

Aufliegende Beschläge
Top mounted fittings

Zulässige Flügelgrößen
Admissible sash sizes

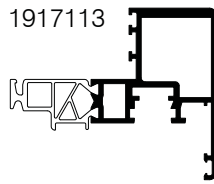
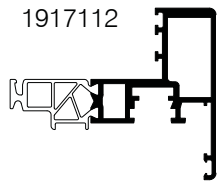

	(Pa)	800	1200	2000	-	800	1200	2000	-									
	(Pa)	150	300	600	-	150	300	600	-									
	max.	FAB (m)	1.8	2.0	2.1	-	2.0	2.0	2.25	-								
		FAH (m)	1.4	1.3	1.2	-	1.4	1.4	1.3	-								
	min.	FAB (m)	0.6	0.6	0.6	-	0.6	0.6	0.6	-								
		FAH (m)	0.45	0.45	0.45	-	0.45	0.45	0.45	-								
MV / MB	FAB (m)	1.5	1.4	1.3	-	1.5	1.5	1.4	-									
	FAH (m)	-	-	-	-	-	-	-	-									
	min.	FAB (m)	0.74	0.74	0.74	-	0.74	0.74	0.74	-								
		FAH (m)	0.45	0.45	0.45	-	0.45	0.45	0.45	-								
	min.	FAB (m)	0.9	0.9	0.9	-	0.9	0.9	0.9	-								
		FAH (m)	0.6	0.6	0.6	-	0.6	0.6	0.6	-								
	max.(kg)	130***				130***												

*** Zusätzliche Verklebung, Angaben in den Verarbeitungsrichtlinien beachten!
*** Additional gluing, pay attention to specifications in the workshop manual!

WICLINE 75

Aufliegende Beschläge
Top mounted fittings

Zulässige Flügelgrößen
Admissible sash sizes



		1917110				1917111				1917112				1917113				
	(Pa)	800	1200	2000	-	800	1200	2000	-	800	1200	2000	-	800	1200	2000	-	
	(Pa)	150	300	600	-	150	300	600	-	150	300	600	-	150	300	600	-	
	max.	FAB (m)	1.4	1.4	1.4	-	1.6	1.6	1.6	-	1.7	1.7	1.7	-	1.8	1.8	1.8	-
		FAH (m)	1.2	1.1	1.0	-	1.3	1.2	1.1	-	1.4	1.3	1.2	-	1.4	1.4	1.3	-
	min.	FAB (m)	0.55	0.55	0.55	-	0.55	0.55	0.55	-	0.55	0.55	0.55	-	0.55	0.55	0.55	-
		FAH (m)	0.45	0.45	0.45	-	0.45	0.45	0.45	-	0.45	0.45	0.45	-	0.45	0.45	0.45	-
MV / MB	FAB (m)	1.3	1.2	1.1	-	1.4	1.3	1.2	-	1.5	1.4	1.3	-	1.5	1.5	1.4	-	
	FAH (m)	-	-	-	-	-	-	-	-	-	-	-	-	-	-	-	-	
	min.	FAB (m)	0.88	0.88	0.88	-	0.88	0.88	0.88	-	0.88	0.88	0.88	-	0.88	0.88	0.88	-
		FAH (m)	0.45	0.45	0.45	-	0.45	0.45	0.45	-	0.45	0.45	0.45	-	0.45	0.45	0.45	-
	min.	FAB (m)	0.88	0.88	0.88	-	0.88	0.88	0.88	-	0.88	0.88	0.88	-	0.88	0.88	0.88	-
		FAH (m)	0.6	0.6	0.6	-	0.6	0.6	0.6	-	0.6	0.6	0.6	-	0.6	0.6	0.6	-
	max.(kg)	80				80				80				80				

WICLINE 75

Aufliegende Beschläge
Top mounted fittings

Zulässige Flügelgrößen
Admissible sash sizes

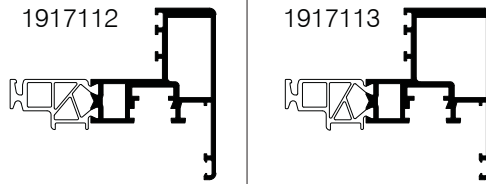

	(Pa)	800	1200	2000	-	800	1200	2000	-								
	(Pa)	150	300	600	-	150	300	600	-								
max.	FAB (m)	1.8	2.0	2.1	-	2.0	2.0	2.25	-								
	FAH (m)	1.4	1.3	1.2	-	1.4	1.4	1.3	-								
min.	FAB (m)	0.55	0.55	0.55	-	0.55	0.55	0.55	-								
	FAH (m)	0.45	0.45	0.45	-	0.45	0.45	0.45	-								
MV / MB	FAB (m)	1.5	1.4	1.3	-	1.5	1.5	1.4	-								
	FAH (m)	-	-	-	-	-	-	-	-								
	min. FAB (m)	0.88	0.88	0.88	-	0.88	0.88	0.88	-								
	min. FAH (m)	0.45	0.45	0.45	-	0.45	0.45	0.45	-								
	min. FAB (m)	0.88	0.88	0.88	-	0.88	0.88	0.88	-								
	min. FAH (m)	0.6	0.6	0.6	-	0.6	0.6	0.6	-								
	max.(kg)	80 / 120***				80 / 120***											

*** Zusätzliche Verklebung, Angaben in den Verarbeitungsrichtlinien beachten!
*** Additional gluing, pay attention to specifications in the workshop manual!

WICLINE

Beschläge
Fittings

Zulässige Formatgrößen, aufliegende Beschläge
Admissible format sizes, top mounted fittings

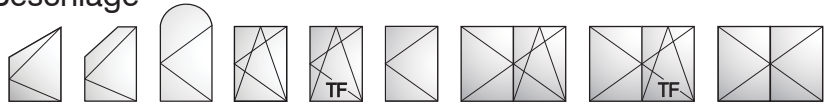

WICSTAR

mit Zusatzschraube Flügengewicht 130-160 kg
with additional screws sash weight 130-160 kg

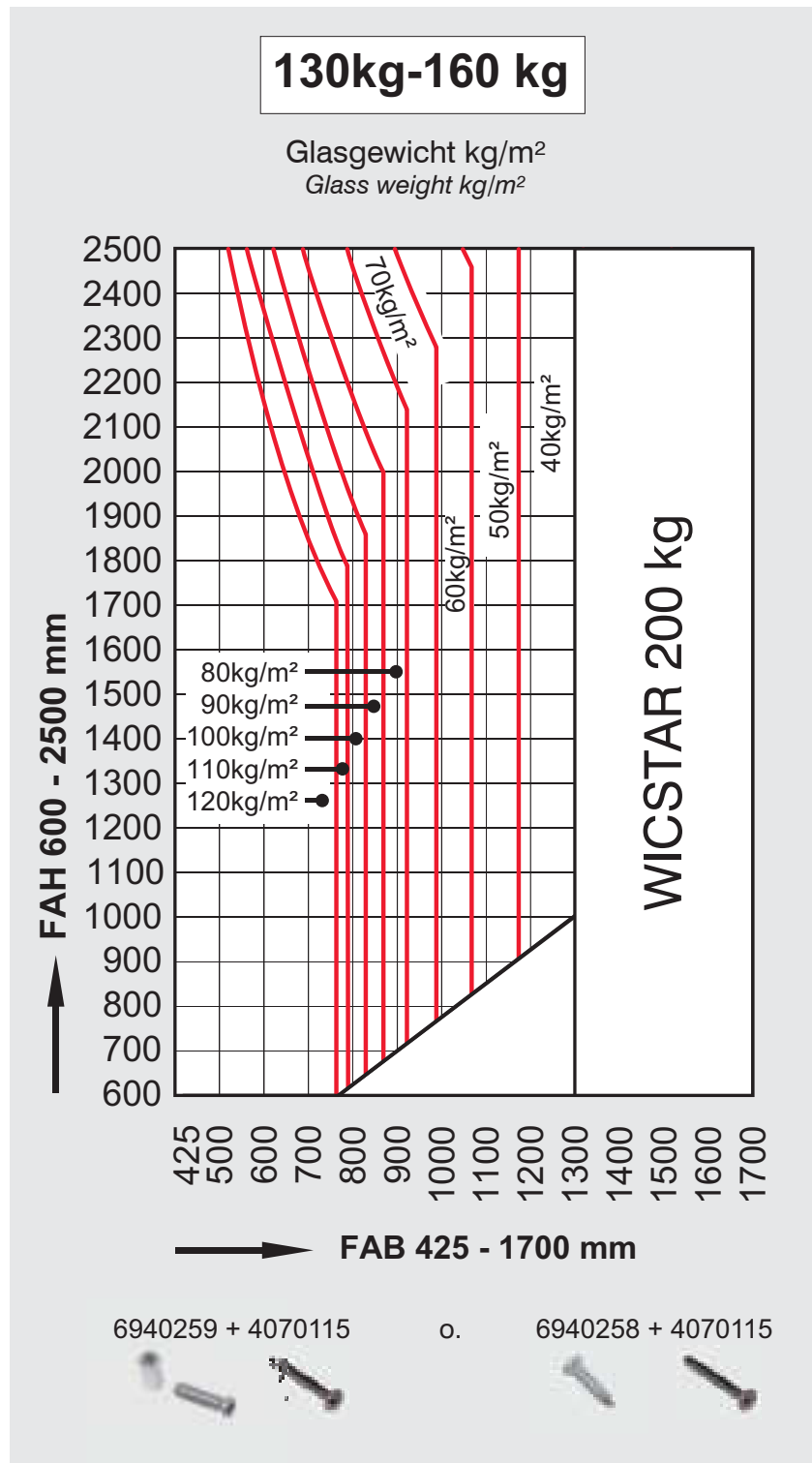

Zulässige Formatgrößen, aufliegende Beschläge
Admissible format sizes, top mounted fittings

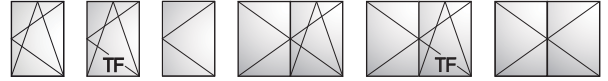

WICSTAR

mit Zusatzschraube Flügelgewicht 100-130 kg
with additional screw sash weight 100-130 kg

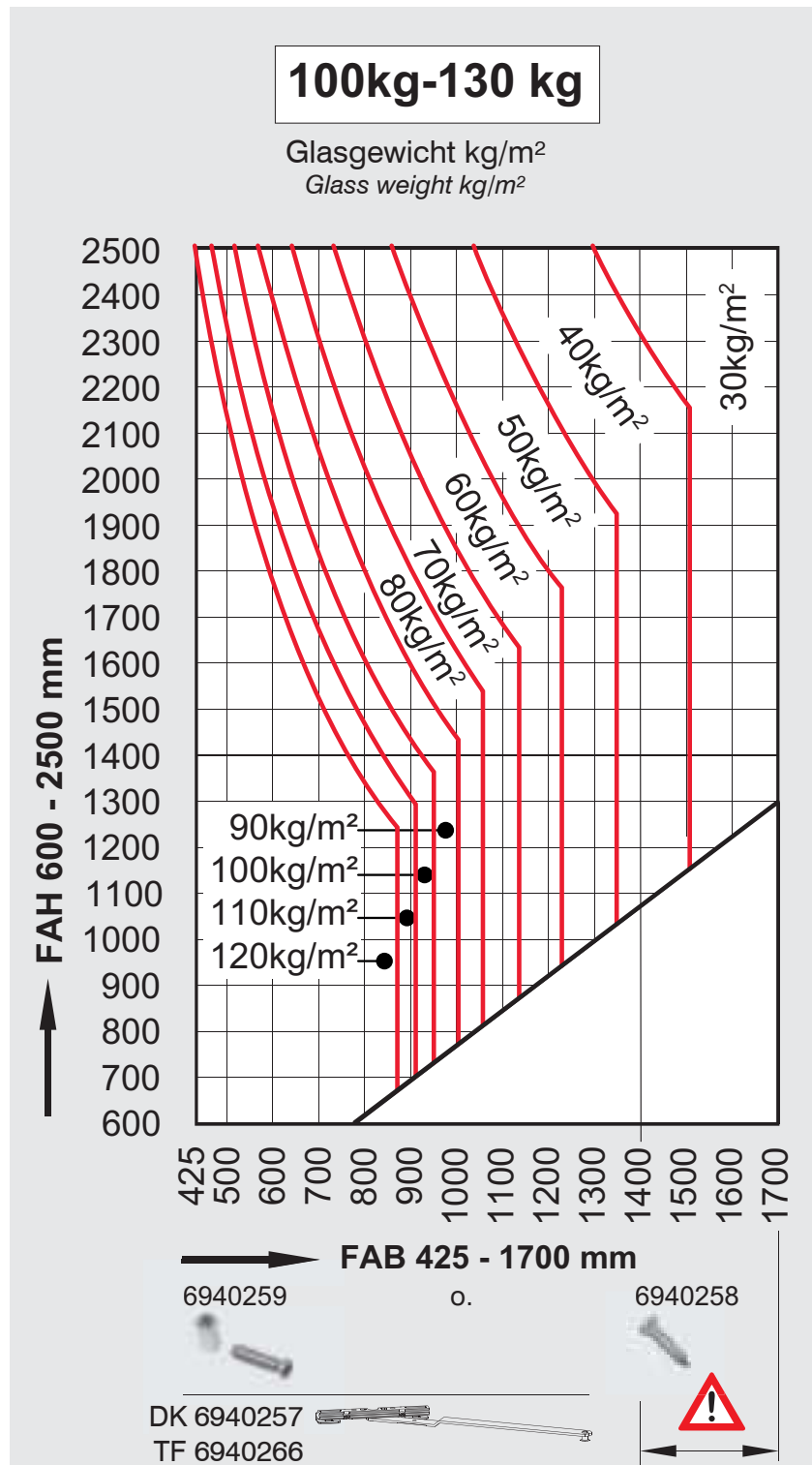

WICLINE

Beschläge
Fittings

Zulässige Formatgrößen, aufliegende Beschläge
Admissible format sizes, top mounted fittings

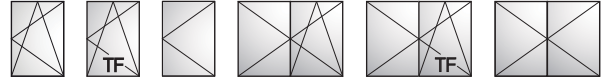

WICSTAR

Flügelgewicht max. 100 kg
Sash weight max. 100 kg

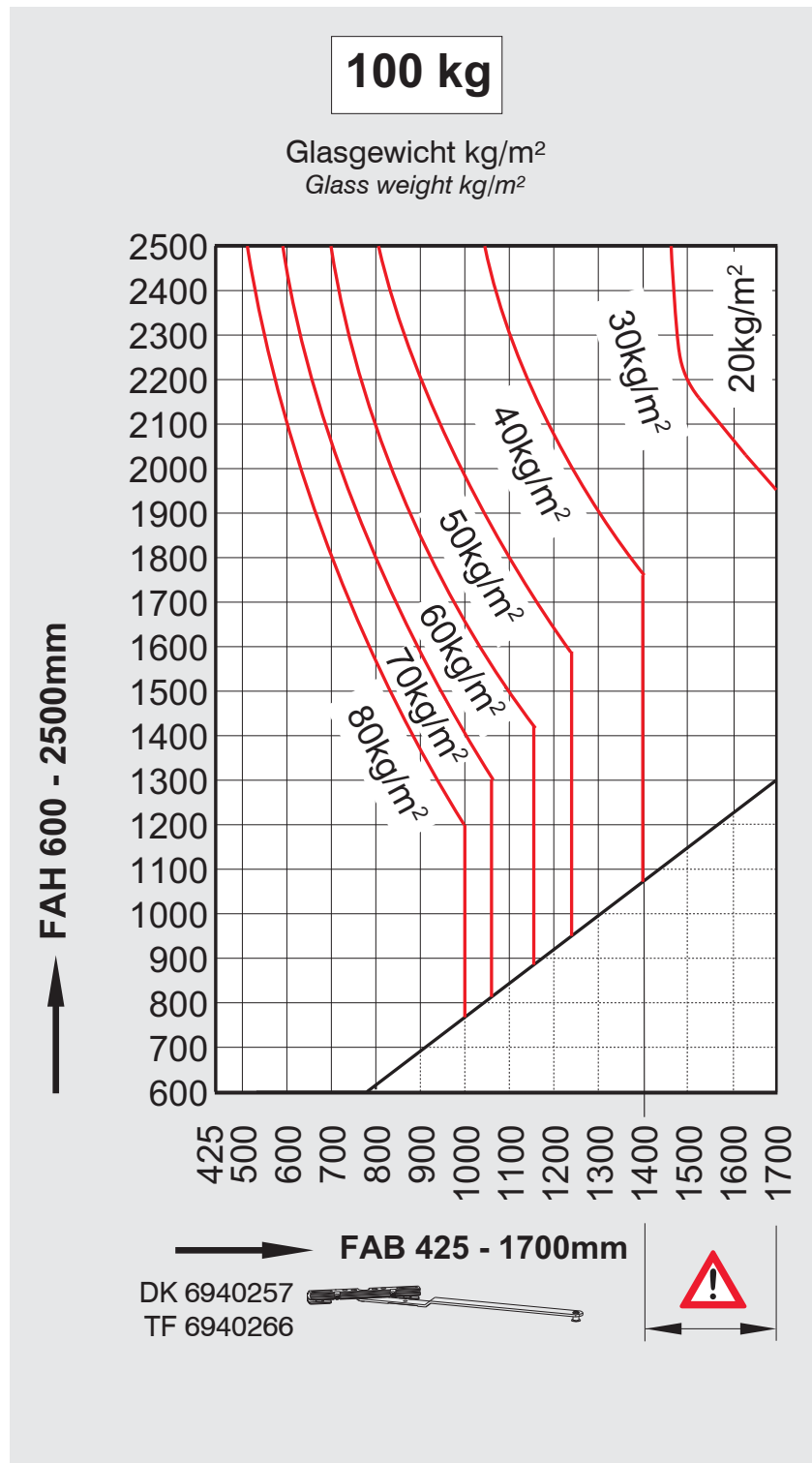

Zulässige Formatgrößen, aufliegende Beschläge
Admissible format sizes, top mounted fittings



WICSTAR

Flügelgewicht max. 200 kg
Sash weight max. 200 kg



Die Befestigung der Blendrahmenbänder erfordert Rahmenprofile mit einer Kammerhöhe ≥ 28 mm (z.B. 1916004)
The fixation of the hinges require frame profiles with a chamber height of 28 mm or higher (e.g. 1916004)

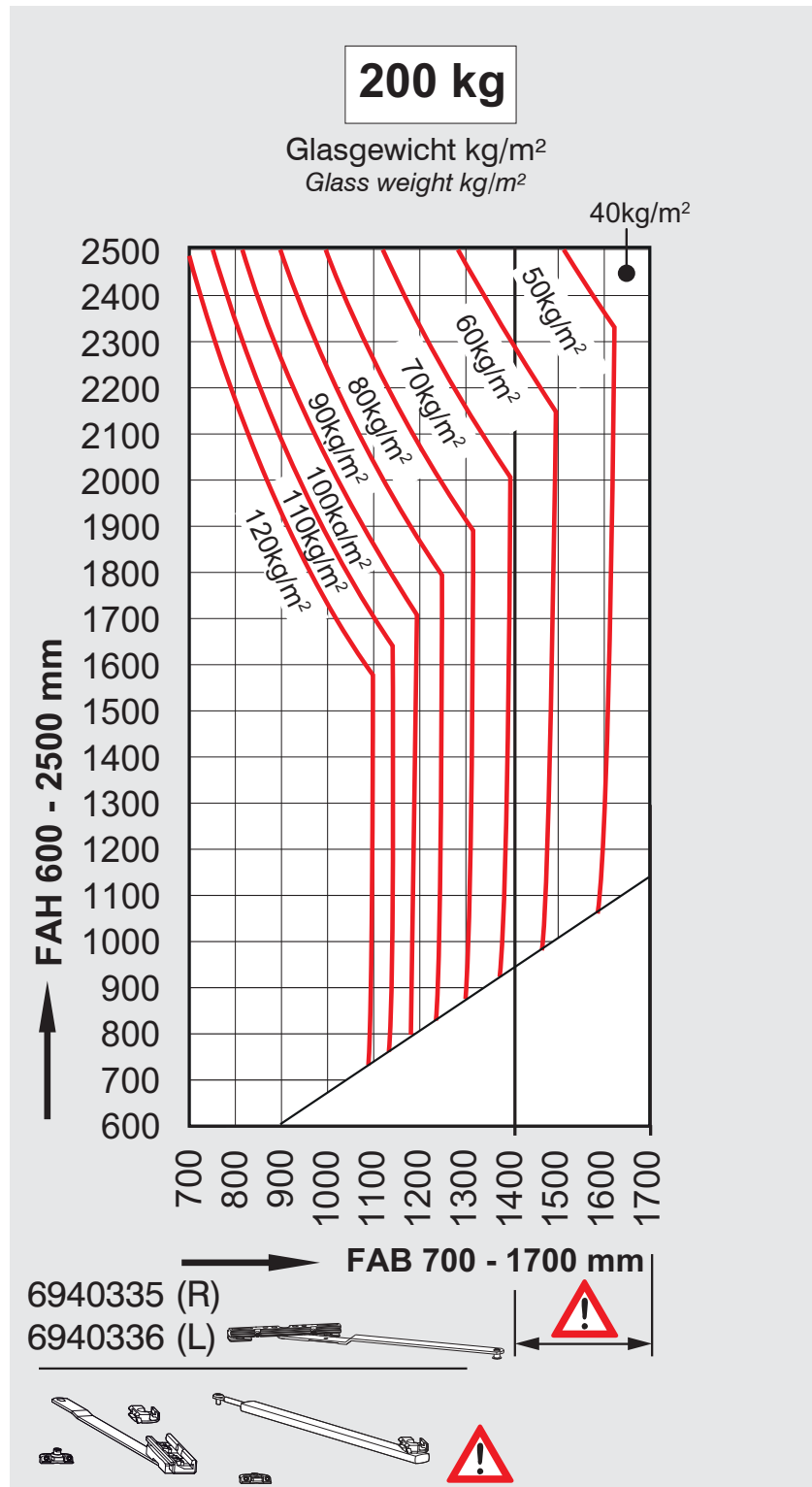

WICLINE

Zulässige Formatgrößen, aufliegende Beschläge
Admissible format sizes, top mounted fittings



WICSTAR

Flügelgewicht max. 80 kg
Sash weight max. 80 kg

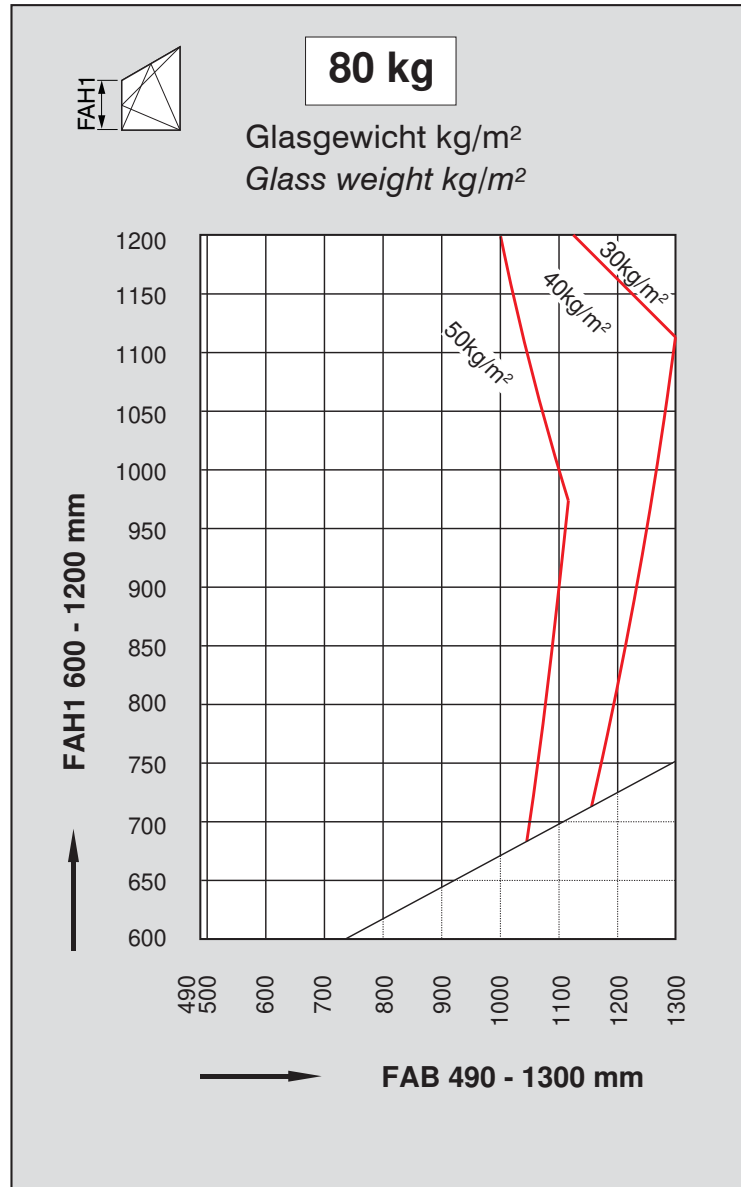

WICLINE

Zulässige Formatgrößen, aufliegende Beschläge
Admissible format sizes, top mounted fittings



WICSTAR

Flügelgewicht max. 80 kg
Sash weight max. 80 kg

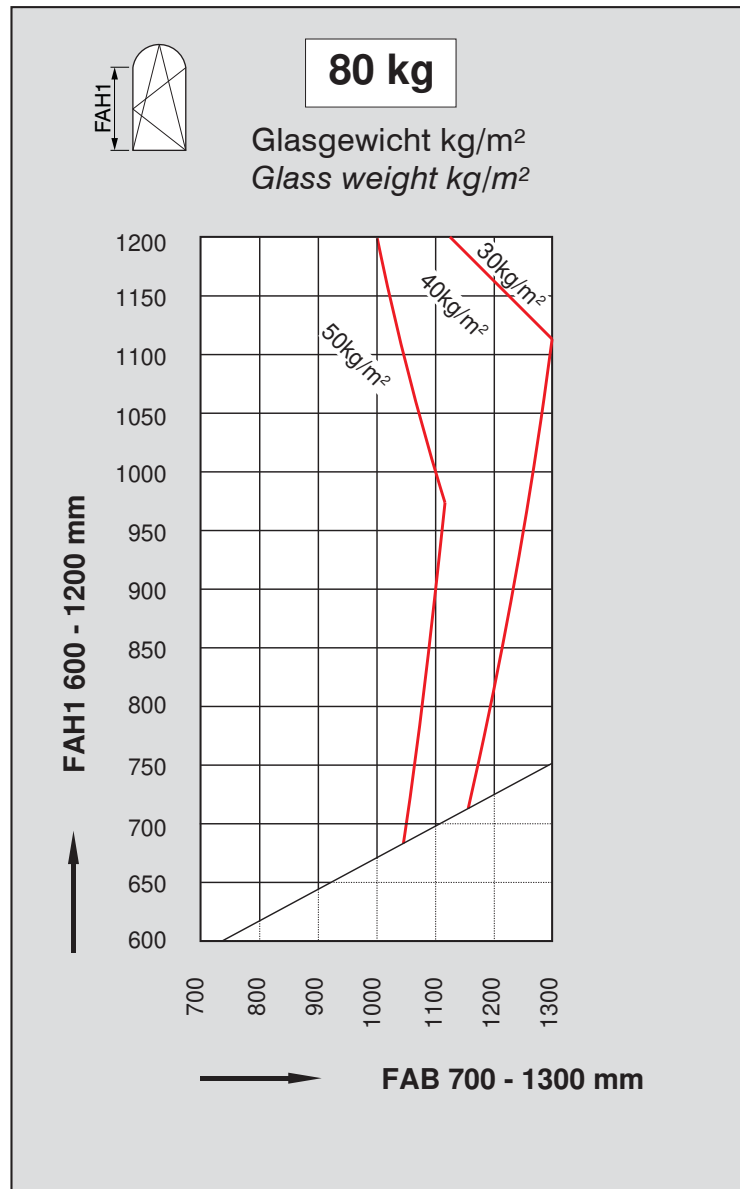

Zulässige Formatgrößen, aufliegende Beschläge
Admissible format sizes, top mounted fittings



WICSTAR

Flügelgewicht max. 200 kg
Sash weight max. 200 kg



Die Befestigung der Blendrahmenbänder erfordert Rahmenprofile mit einer Kammerhöhe ≥ 28 mm (z.B. 1916004)
The fixation of the hinges require frame profiles with a chamber height of 28 mm or higher (e.g. 1916004)

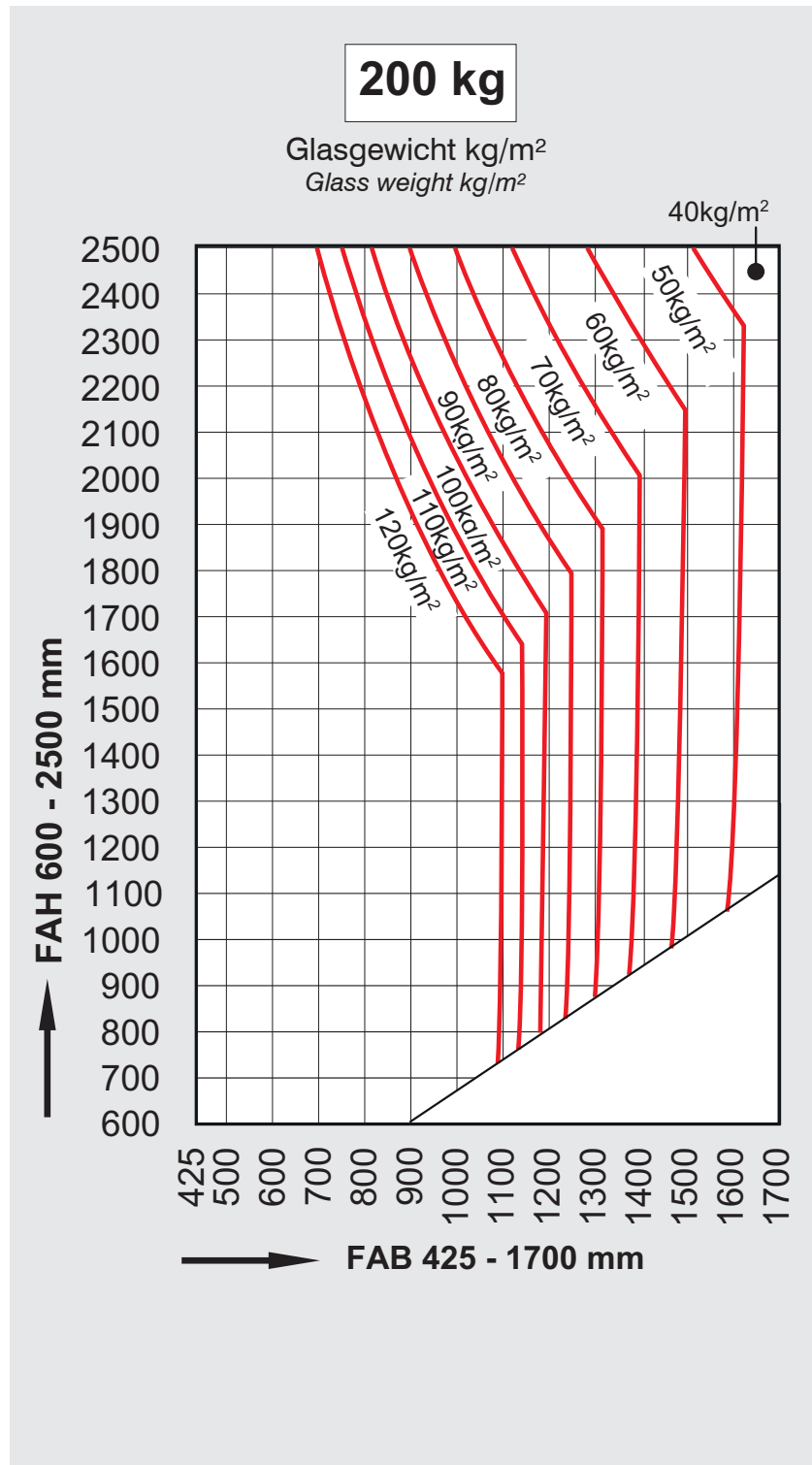

Zulässige Formatgrößen, aufliegende Beschläge
Admissible format sizes, top mounted fittings



WICSTAR

Flügelgewicht max. 130 kg
Sash weight max. 130 kg

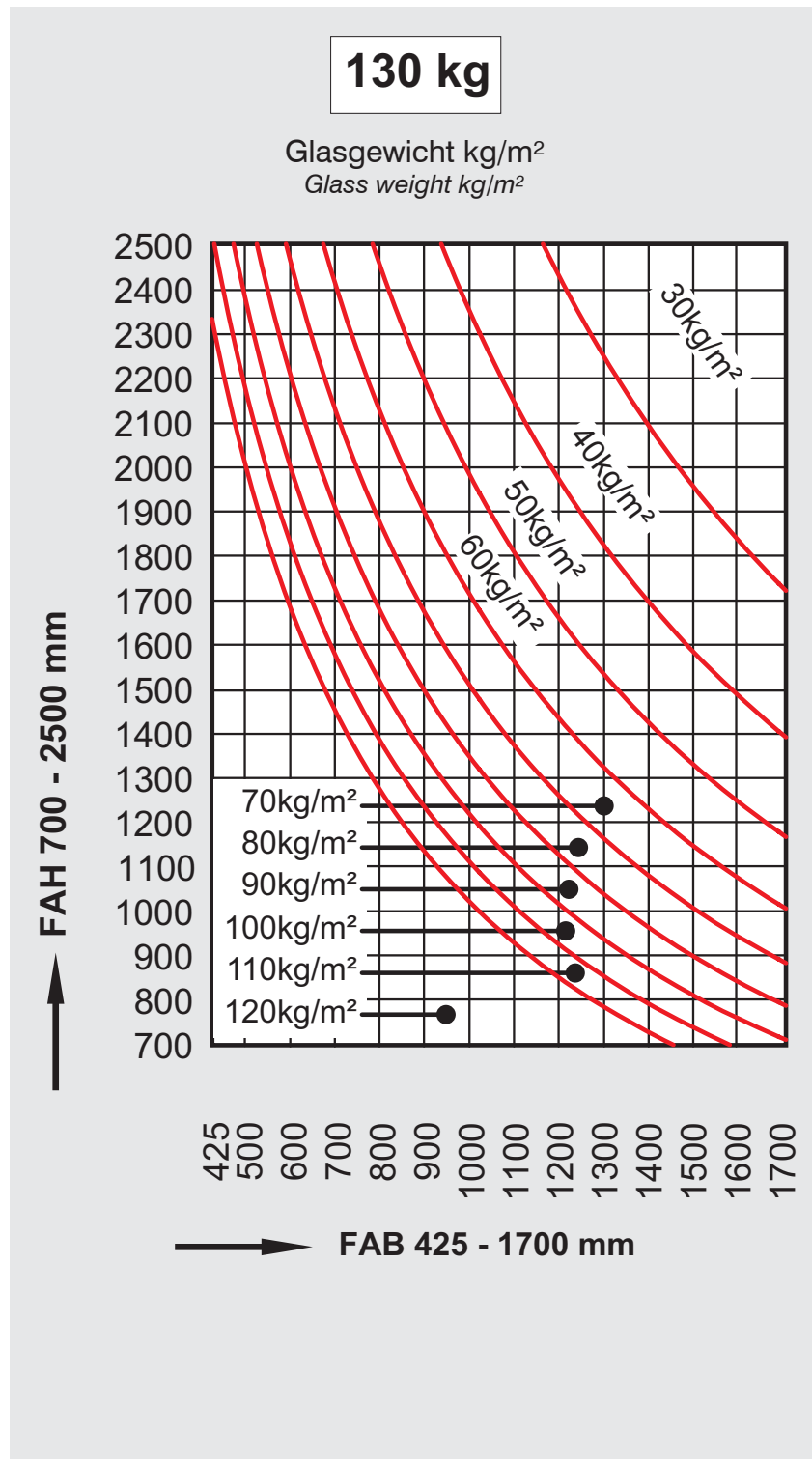

Zulässige Formatgrößen, aufliegende Beschläge
Admissible format sizes, top mounted fittings



WICSTAR

Flügelgewicht max. 130 kg
Sash weight max. 130 kg

130 kg

Glasgewicht kg/m²
Glass weight kg/m²

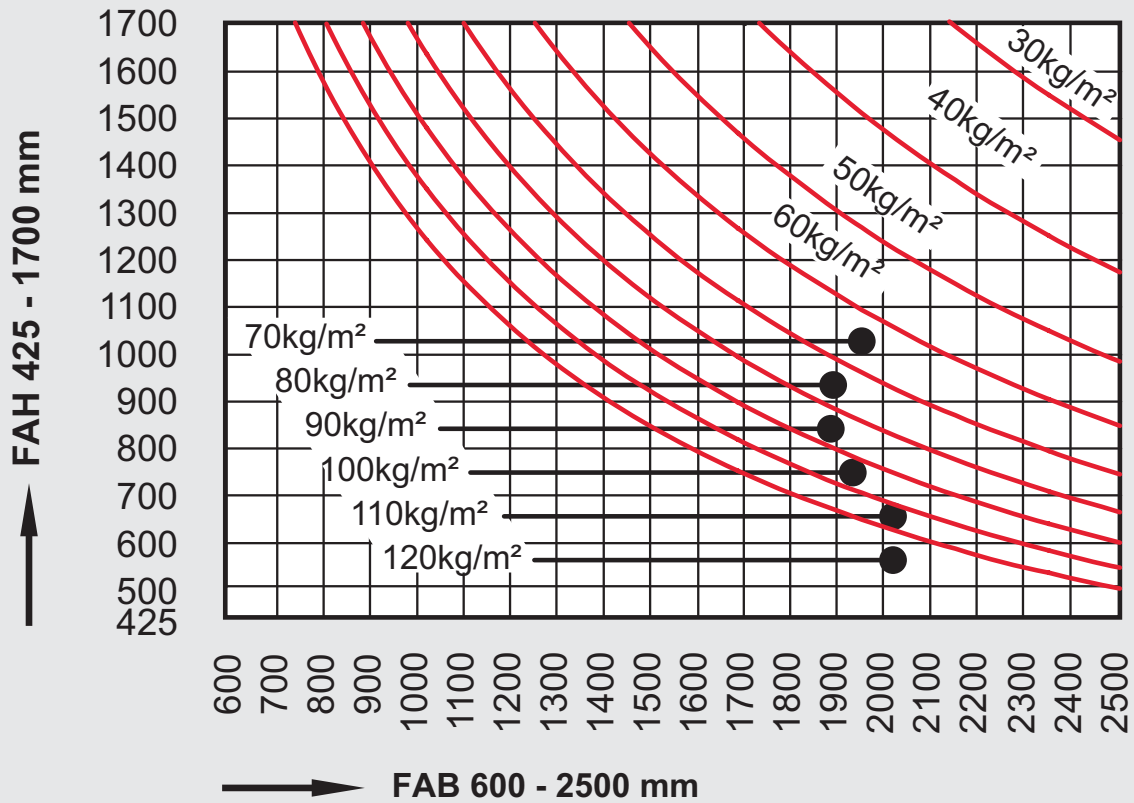

Zulässige Formatgrößen, aufliegende und verdeckte Beschläge
Admissible format sizes, top mounted and concealed fittings



WICSTAR

Flügelgewicht max. 80 kg
Sash weight max. 80 kg

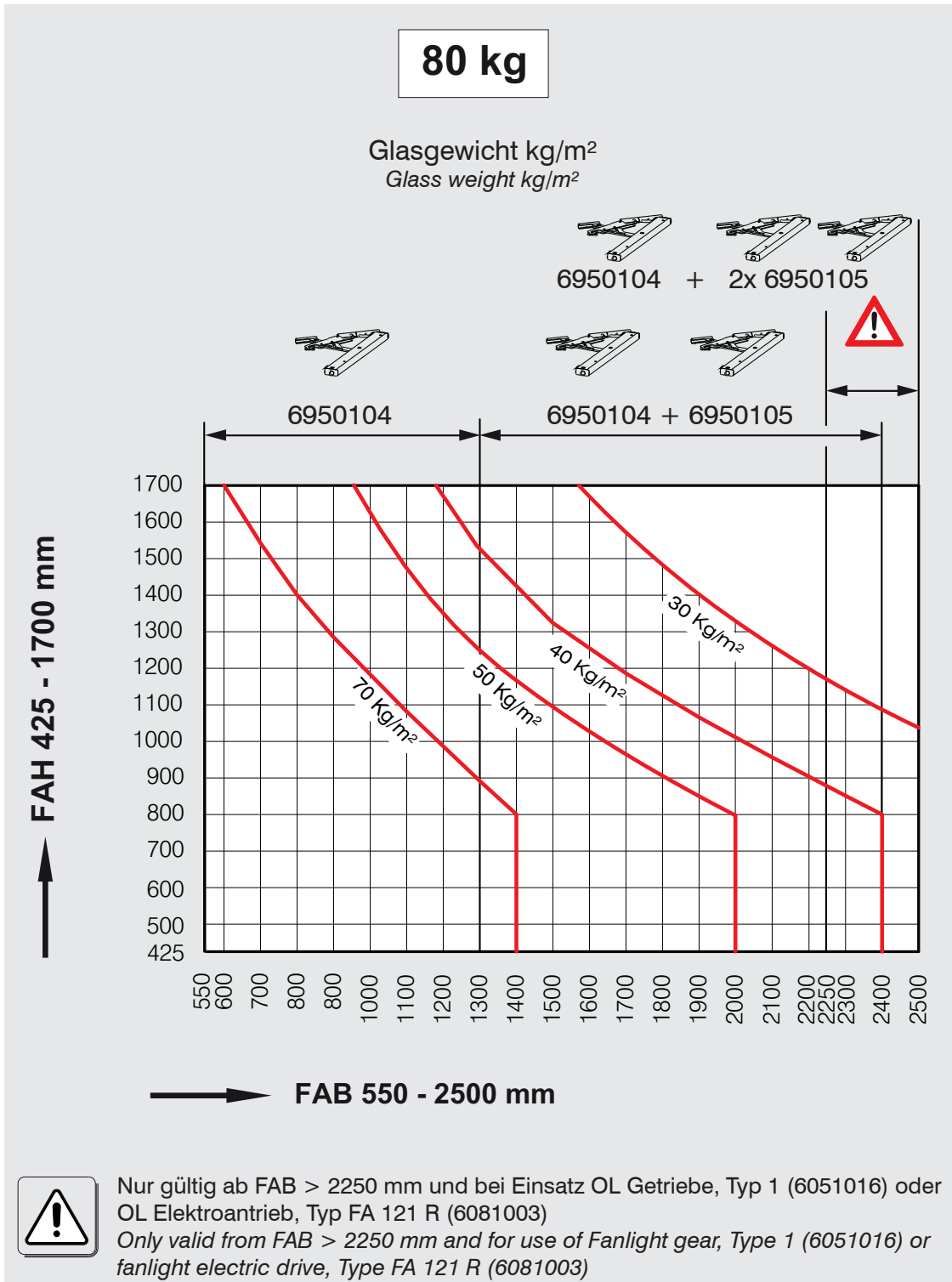

Zulässige Formatgrößen, aufliegende und verdeckte Beschläge
Admissible format sizes, top mounted and concealed fittings



WICSTAR

Flügelgewicht max. 120 kg mit Spindelgetriebe
Sash weight max. 120 kg with spindle gear

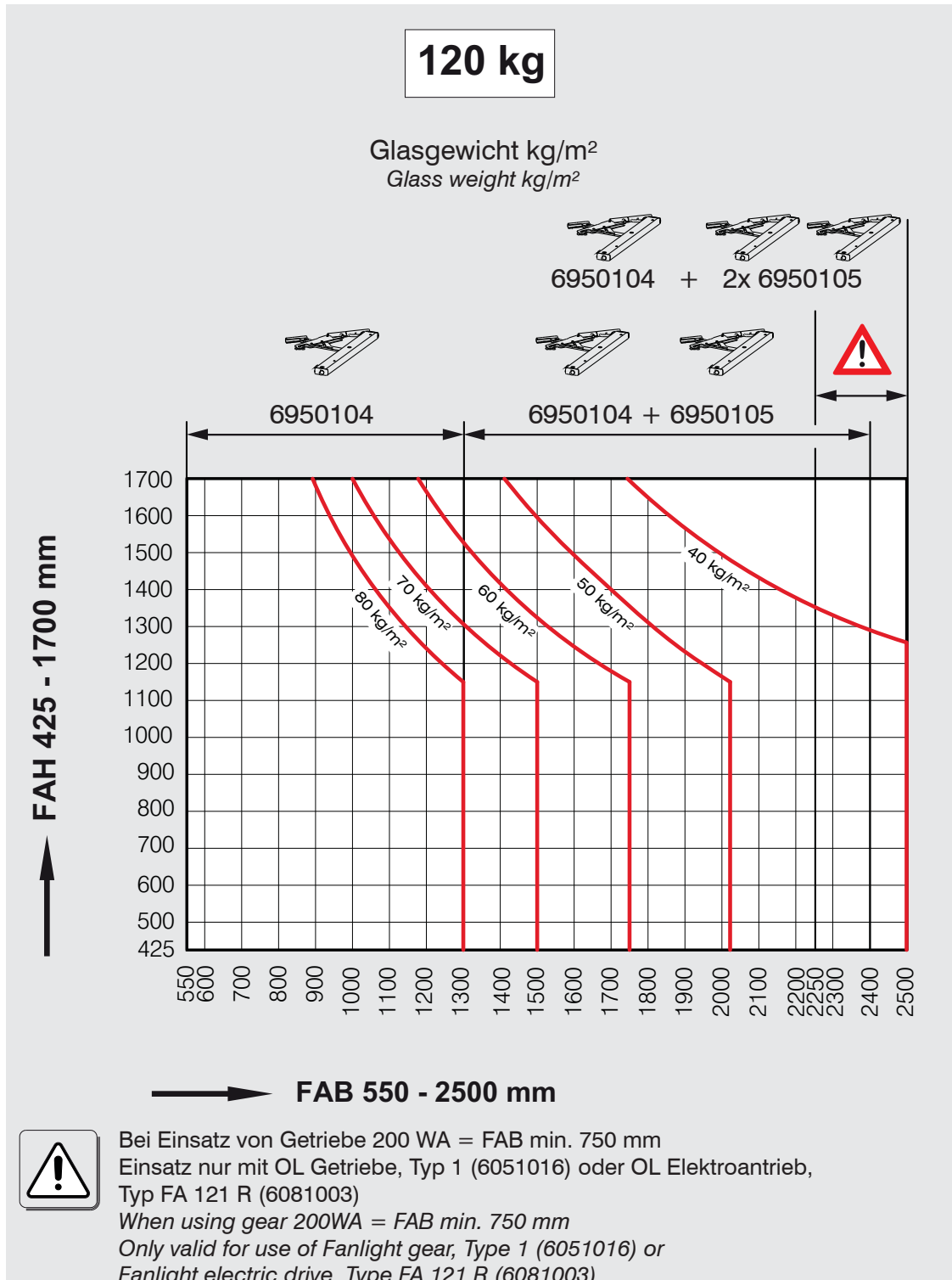

Zulässige Formatgrößen, aufliegende und verdeckte Beschläge
Admissible format sizes, top mounted and concealed fittings



WICSTAR

Flügelgewicht max. 120 kg mit Elektroantrieb
Sash weight max. 120 kg with electric drive

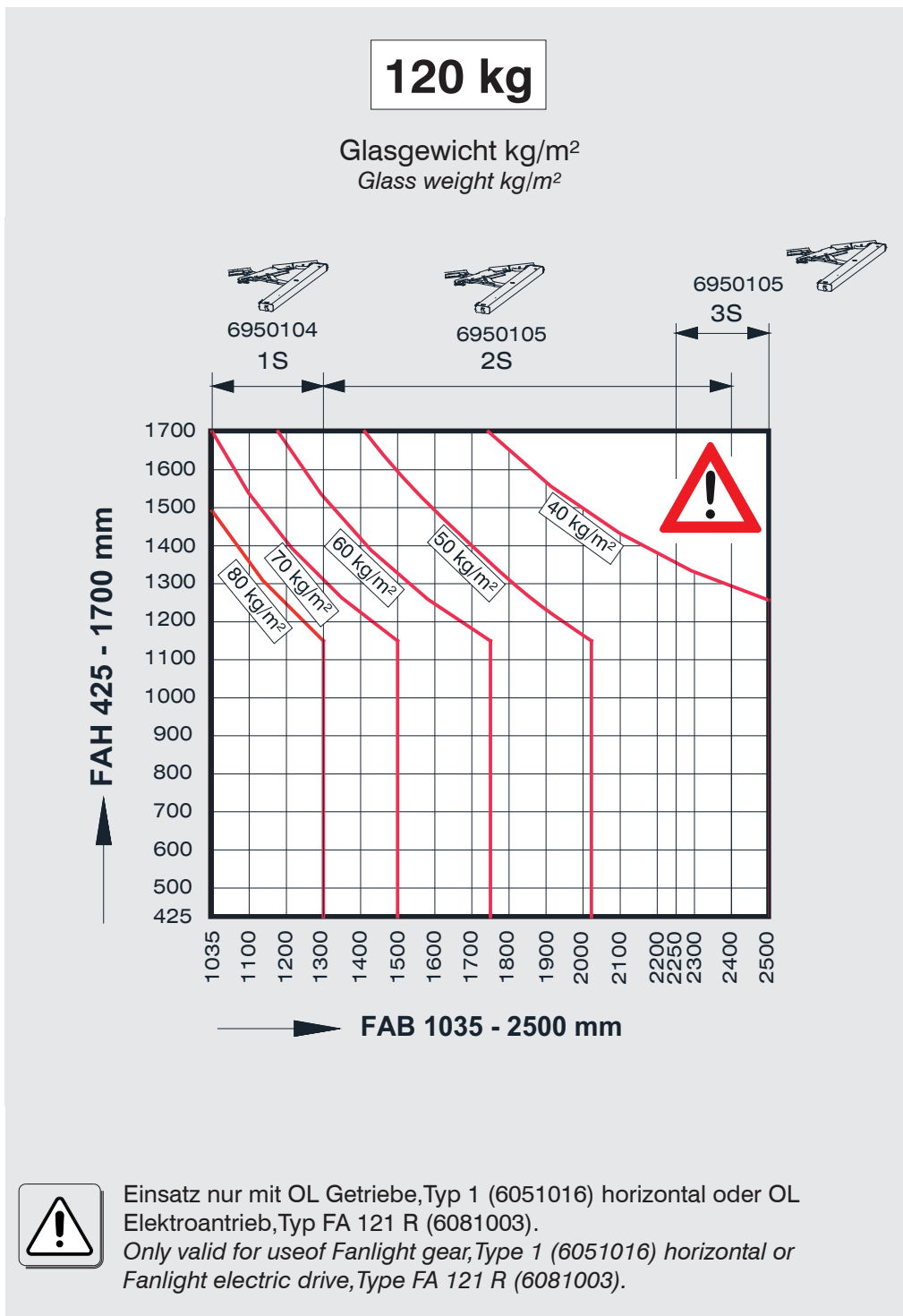

Zulässige Formatgrößen, aufliegende und verdeckte Beschläge
Admissible format sizes, top mounted and concealed fittings



WICSTAR

Flügelgewicht max. 80 kg

Einbruchhemmung RC 1N / RC 2N / RC 2

Sash weight max. 80 kg

Burglar resistance RC 1N / RC 2N / RC 2

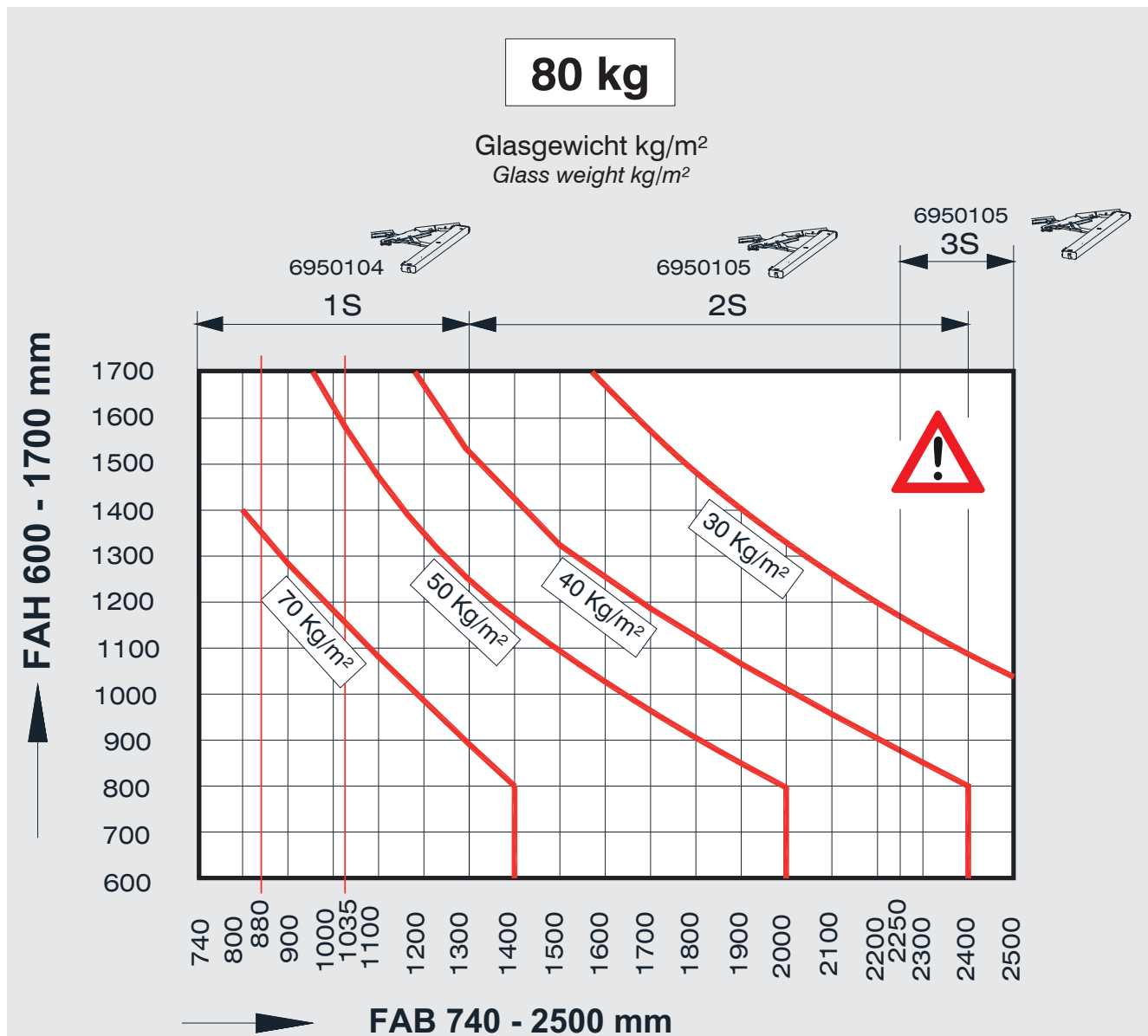

Bei Einsatz von Getriebe 200WA = FAB min. 880 mm; bei Elektroantrieb = FAB min. 1035 mm.
When using gear 200WA = FAB min. 880 mm; with electric drive = FAB min. 1035 mm.

Nur gültig ab FAB > 2250 mm und bei Einsatz OL Getriebe, Typ 1 (6051016) oder OL Elektroantrieb, Typ FA 121 R (6081003).

Flügelgewichte > 80kg nur in Verbindung mit Beschlageinbauplan 45401 (OL Getriebe, Typ 1) und 45601 (OL Elektroantrieb, Typ FA 121 R).

Only valid from FAB > 2250 mm and for use of fanlight gear, Type 1 (6051016) or fanlight electric drive, Type FA 121 R (6081003).

Sash weight > 80kg only in connection with fitting installation plan 45401 (fanlight gear, Type 1) and 45601 (fanlight electric drive, Type FA 121R).

Zulässige Formatgrößen, aufliegende und verdeckte Beschläge
Admissible format sizes, top mounted and concealed fittings



WICSTAR

Flügelgewicht max. 80 kg
Einbruchhemmung RC 3
Sash weight max. 80 kg
Burglar resistance RC 3

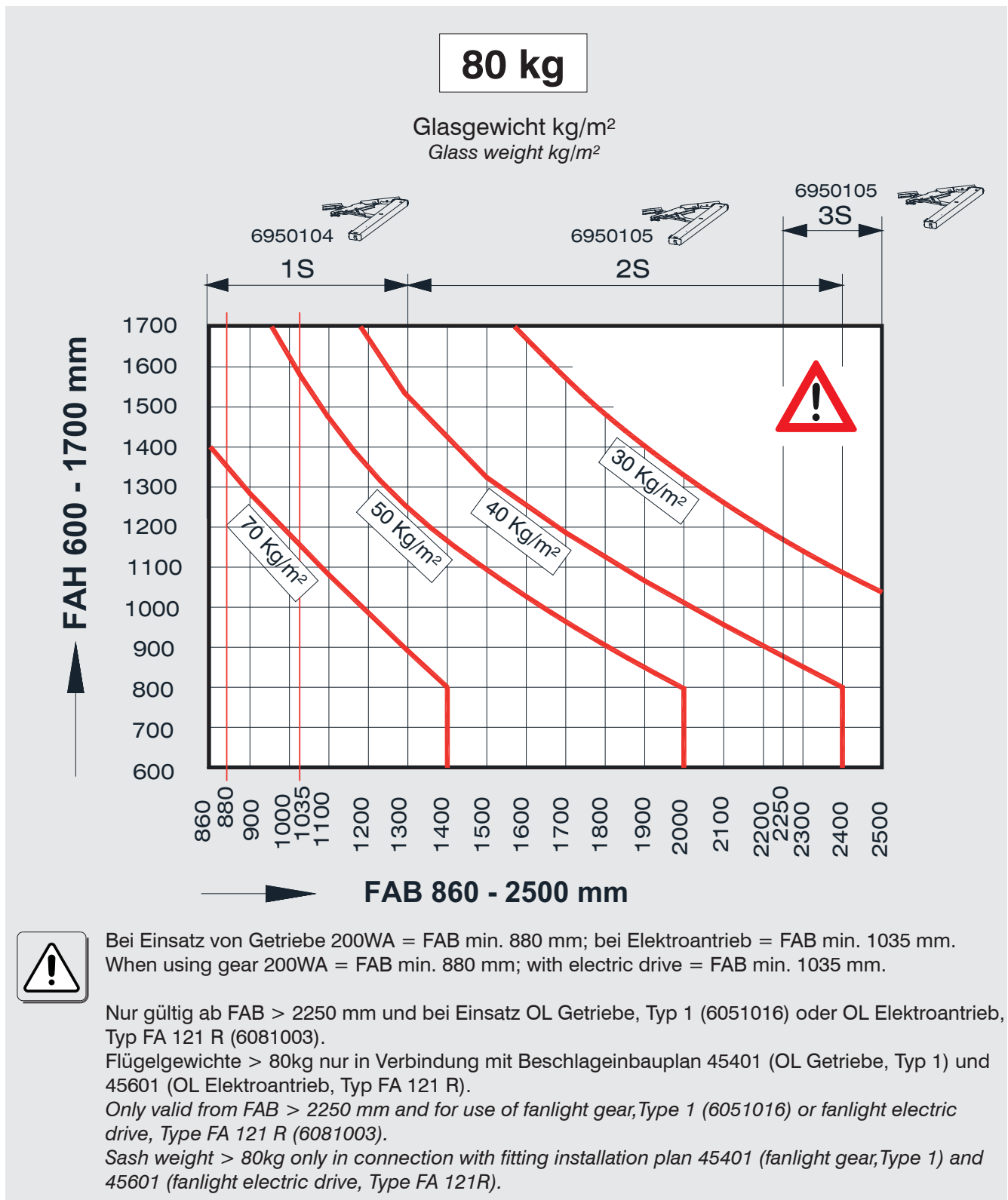

Zulässige Formatgrößen, aufliegende und verdeckte Beschläge
Admissible format sizes, top mounted and concealed fittings



WICSTAR

Flügelgewicht max. 120 kg

Oberlicht-Schrägfenster

Sash weight max. 120 kg

Fanlight sloped window

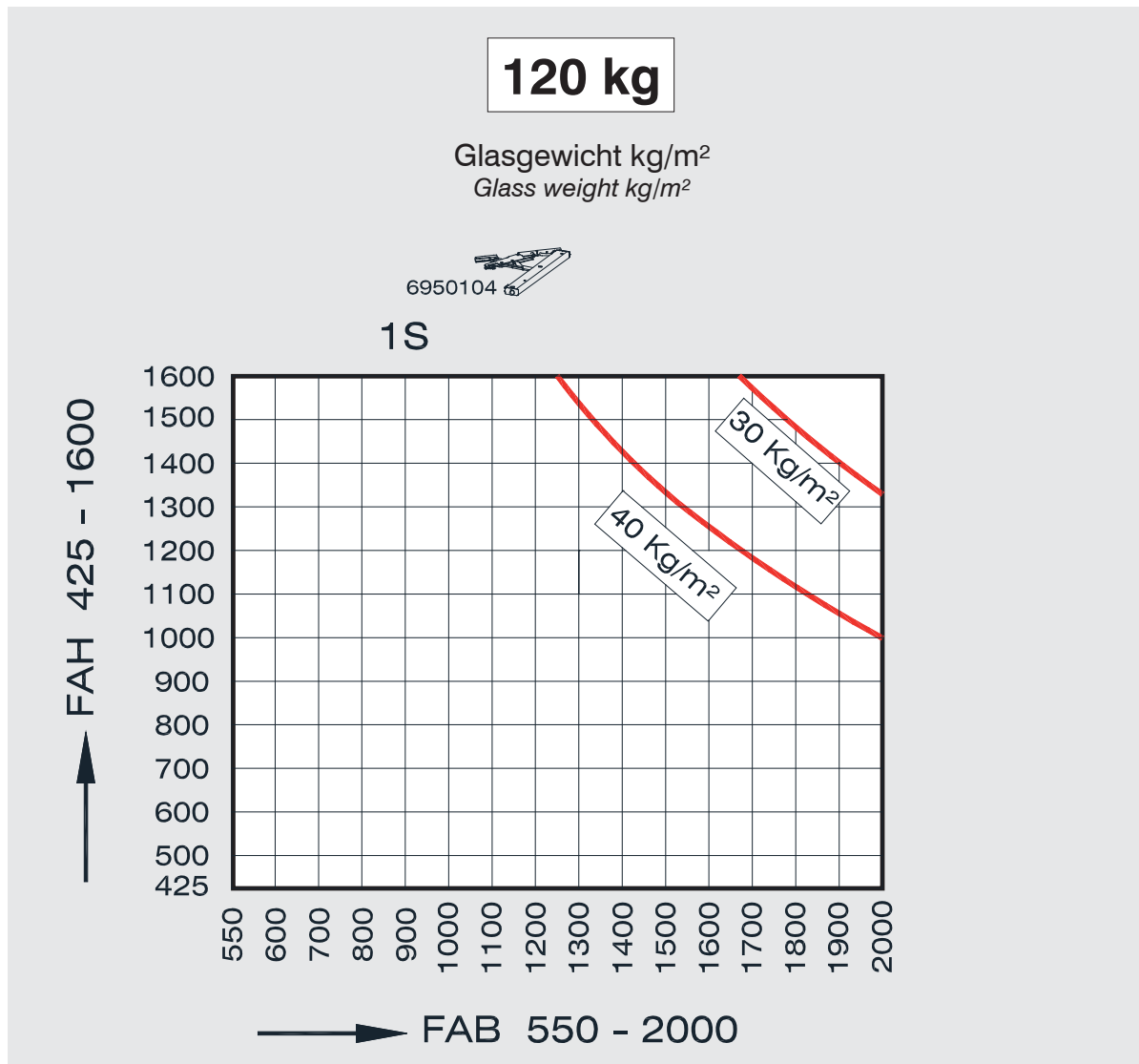

Zulässige Formatgrößen, aufliegende Beschläge
Admissible format sizes, top mounted fittings



WICSTAR

Flügelgewicht max. 160 kg
Sash weight max. 160 kg

PSK-OZ 160 FG max. 160 kg

FAB	mm	655 - 1685
FAH	mm	685 - 2500

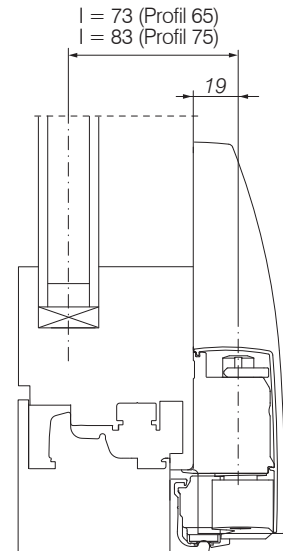
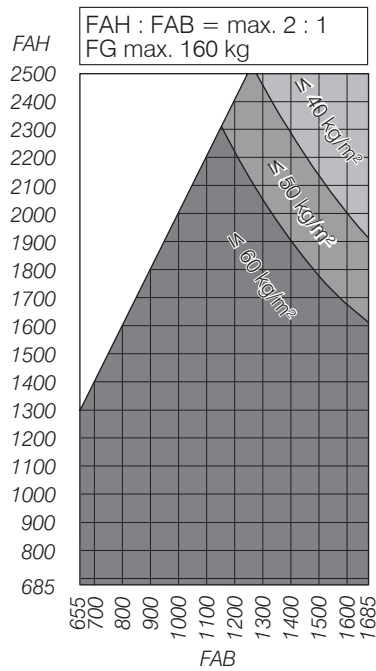

PSK-OZ 100 FG max. 100 kg

FAB	mm	655 - 1400
FAH	mm	685 - 2350

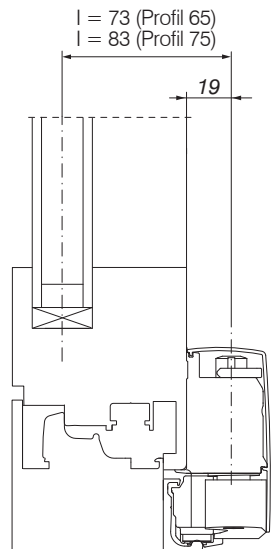
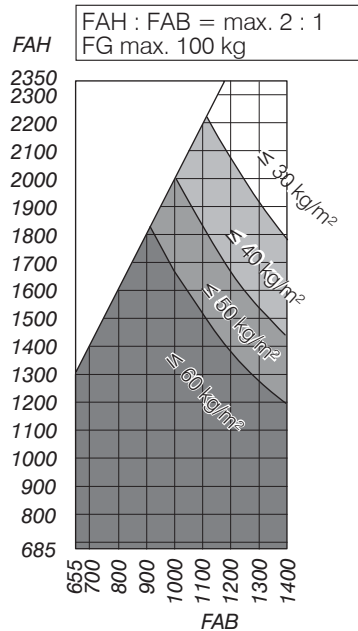

Zulässige Formatgrößen, aufliegende Beschläge
Admissible format sizes, top mounted fittings



WICSTAR

Flügelgewicht max. 200 kg
Sash weight max. 200 kg

- 1) Bei einem Flügelgewicht von 160 bis 200 kg werden Laufwagen Typ 2 eingesetzt. Die in der Montageabfolge abgebildeten Laufwagen gelten in diesem Fall symbolisch. Bei spezifischen Anweisungen für Laufwagen Typ 2 wird auf den Abschnitt am Ende des Dokuments verwiesen.
- 1) For sash weights from 160 to 200 kg running carriages type 2 will be used. Within the mounting sequence, the illustrated running carriages are exemplary. In case of specific instructions for running carriages type 2, please refer to the section at the end of this document.

PSK-MZ 200 TWIN FG¹⁾ max. 200 kg

FAB	mm	1085 - 2000
FAH	mm	935 - 2700 ¹⁾

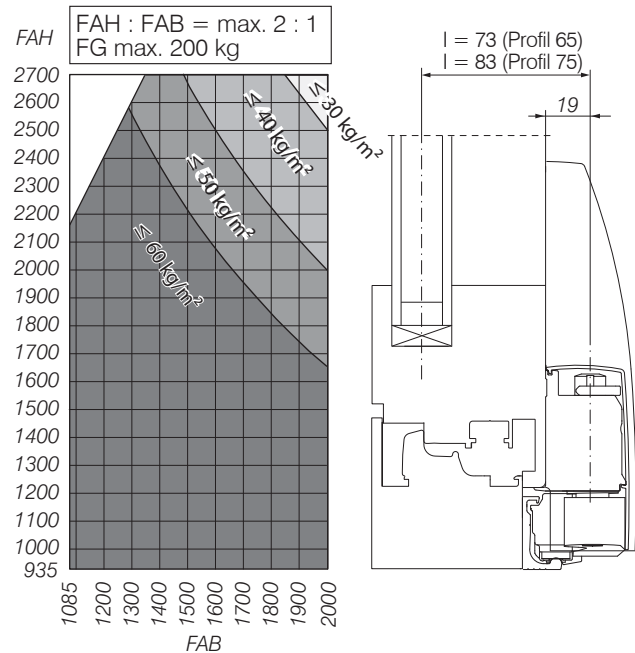

PSK-MZ 200 FG max. 160 kg

FAB	mm	755 - 1600
FAH	mm	935 - 2700

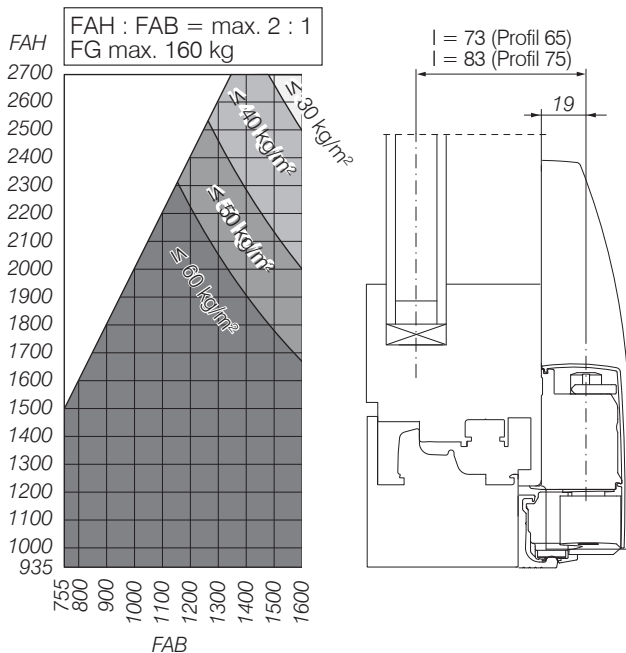

PSK-MZ 200 FG max. 100 kg

FAB	mm	755 - 1400
FAH	mm	935 - 2350

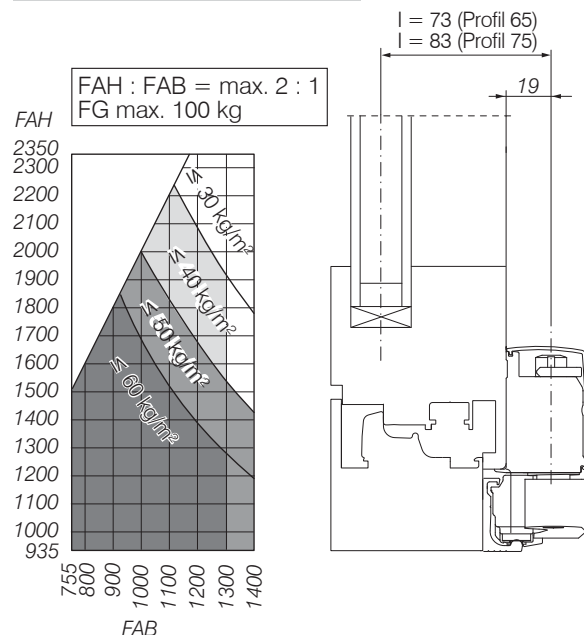

Zulässige Formatgrößen, aufliegende Beschläge
Admissible format sizes, top mounted fittings

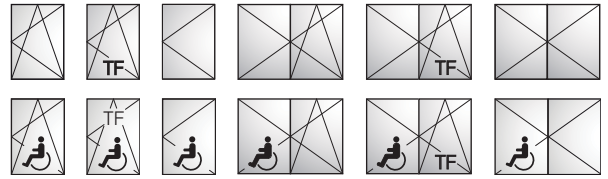

WICSTAR

Flügelgewicht max. 130 kg
Fenster-Beschlag einwärts
Sash weight max. 130 kg
Casement door fitting inwards

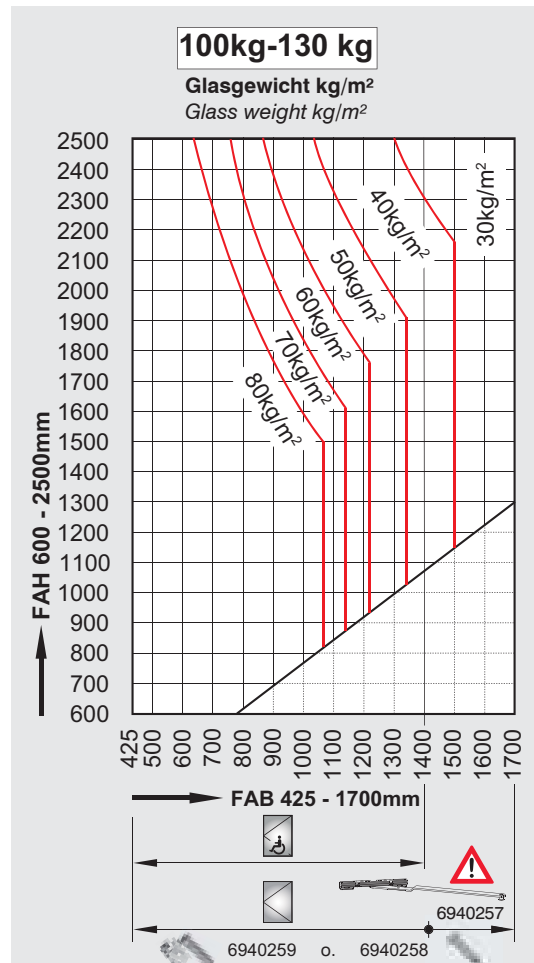
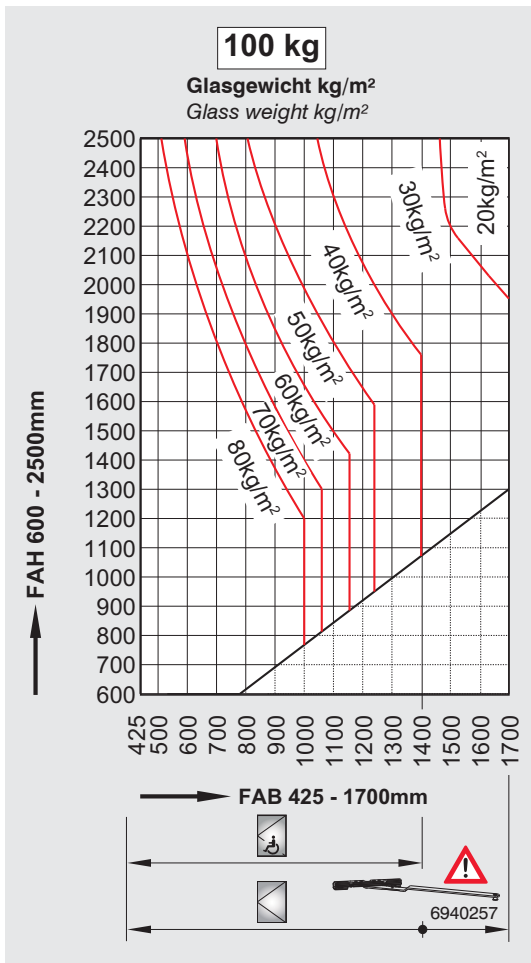

DK 6940257
TF 6940266



Bei Einsatz der barrierefreien Schwelle ist auf der unteren Seite kein vertikaler Mittelverschluss möglich.

The installation of an additional vertical locking point is not possible on the lower edge while using the accessible threshold.

Zulässige Formatgrößen, aufliegende Beschläge
Admissible format sizes, top mounted fittings

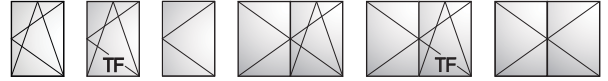

WICSTAR

Flügelgewicht max. 160 kg
Fensterür-Beschlag einwärts
Sash weight max. 160 kg
Casement door fitting inwards

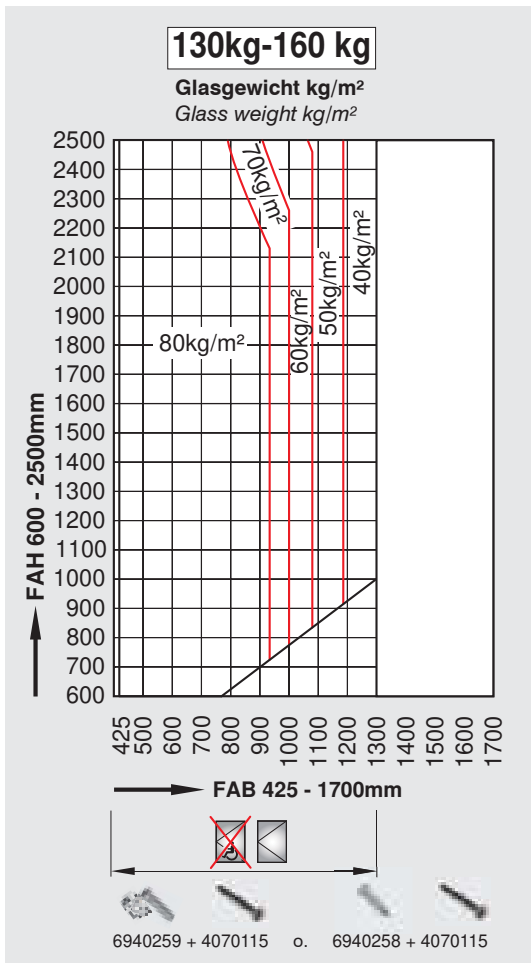

Nicht möglich bei 130-160 kg!
Not possible at 130-160 kg!

Zulässige Formatgrößen, aufliegende Beschläge
Admissible format sizes, top mounted fittings



WICSTAR

Flügelgewicht max. 100 kg
Fensterür-Beschlag auswärts
Sash weight max. 100 kg
Casement door fitting outwards

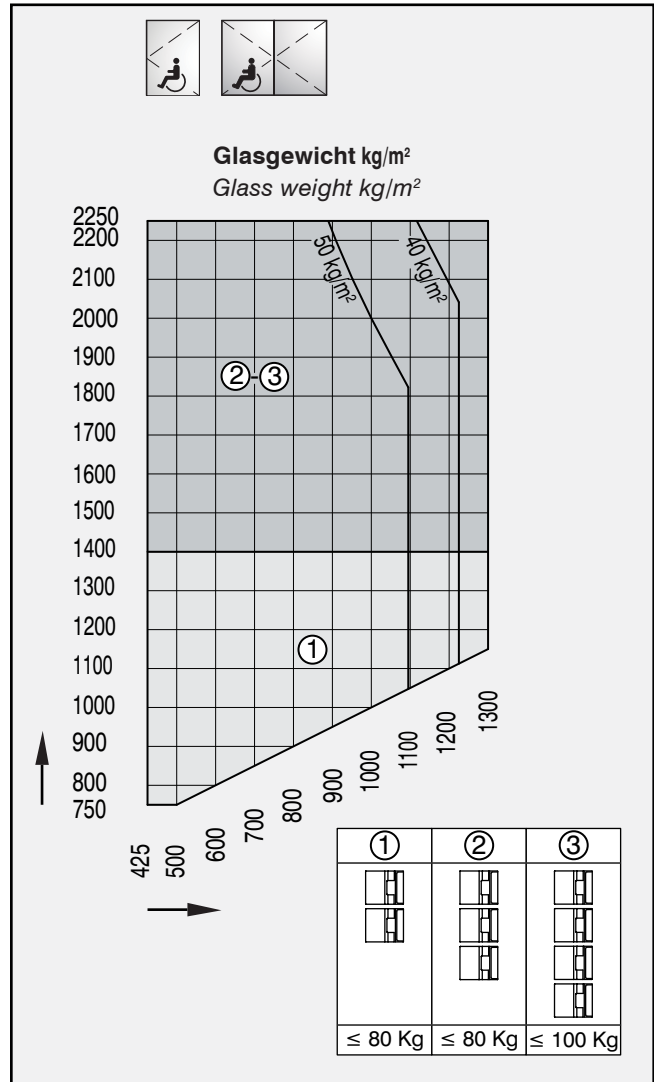
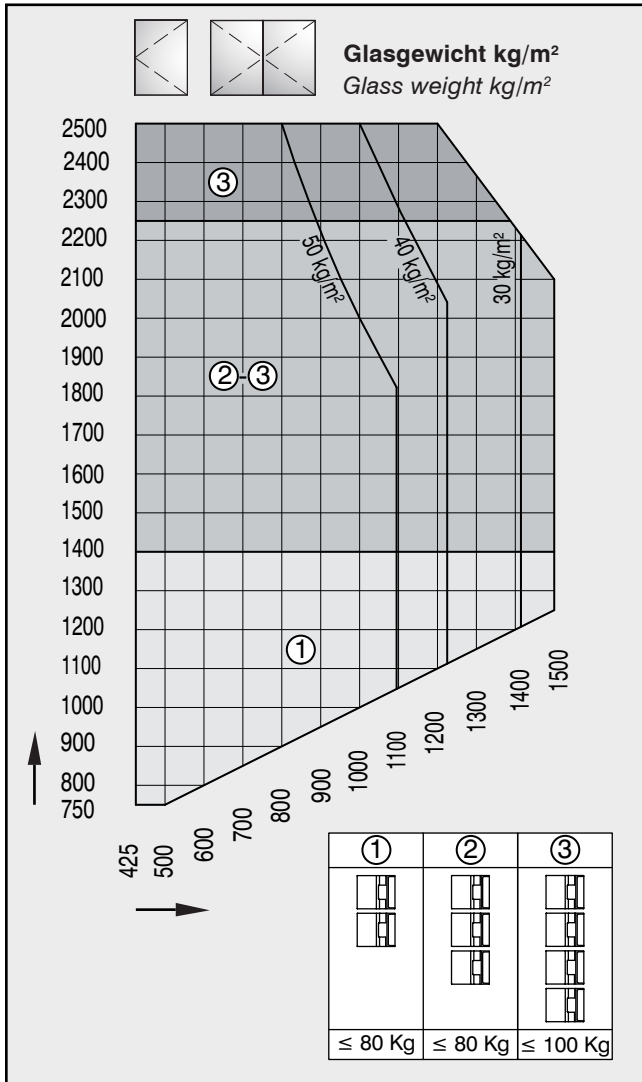

Zulässige Formatgrößen, aufliegende Beschläge
Admissible format sizes, top mounted fittings



WICSTAR

Flügelgewicht max. 150 kg
Klapp-Beschlag auswärts
Sash weight max. 150 kg
Top-hung window fitting outwards

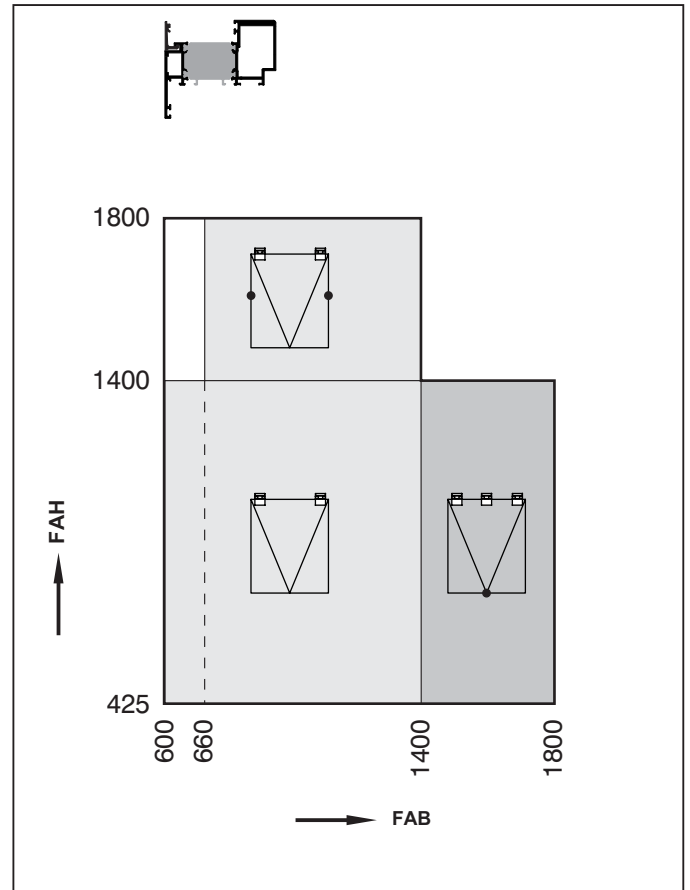
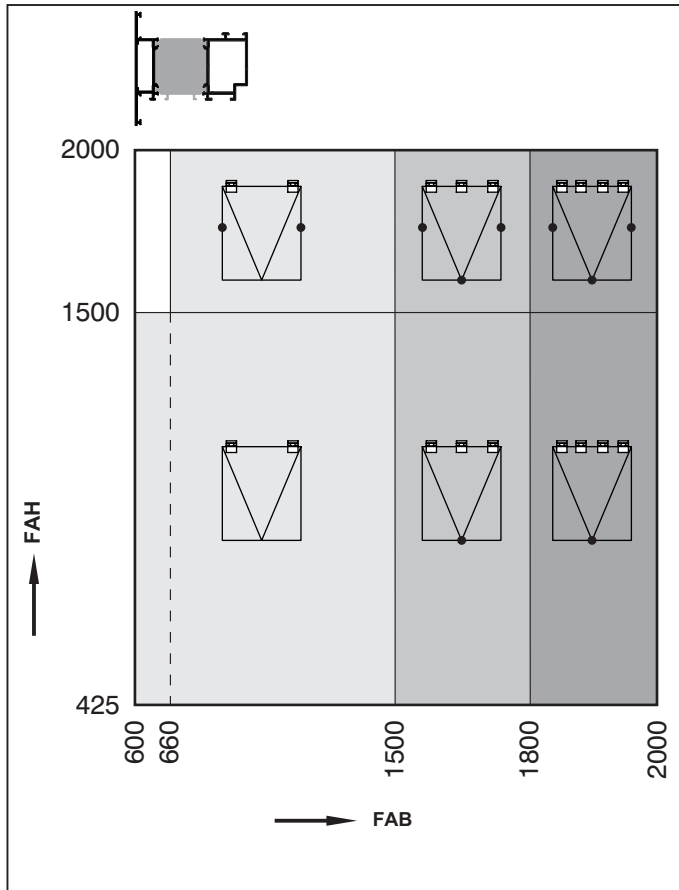

FG ≤ 80kg	
80kg < FG ≤ 100kg	
100kg < FG ≤ 150kg	
• Zusatzverriegelung /	Additional locking point

FG ≤ 80kg	
80kg < FG ≤ 100kg	
• Zusatzverriegelung /	Additional locking point

Für FG ≥ 120kg sind Flügel und Füllung gemäss VAR miteinander zu verkleben!

For sash weights ≥ 120kg the sash frame and the infill must be bonded according to the WSM!



FAH ≤ 2.5 x FAB
Das Flügelgewicht ist vorrangig zu beachten!
The sash weight has first priority!

Zulässige Formatgrößen, aufliegende Beschläge
Admissible format sizes, top mounted fittings



WICSTAR

Flügelgewicht max. 100 kg

Schwing-Wende-Beschlag

Sash weight max. 100 kg

Horizontal / Vertical pivot window fitting

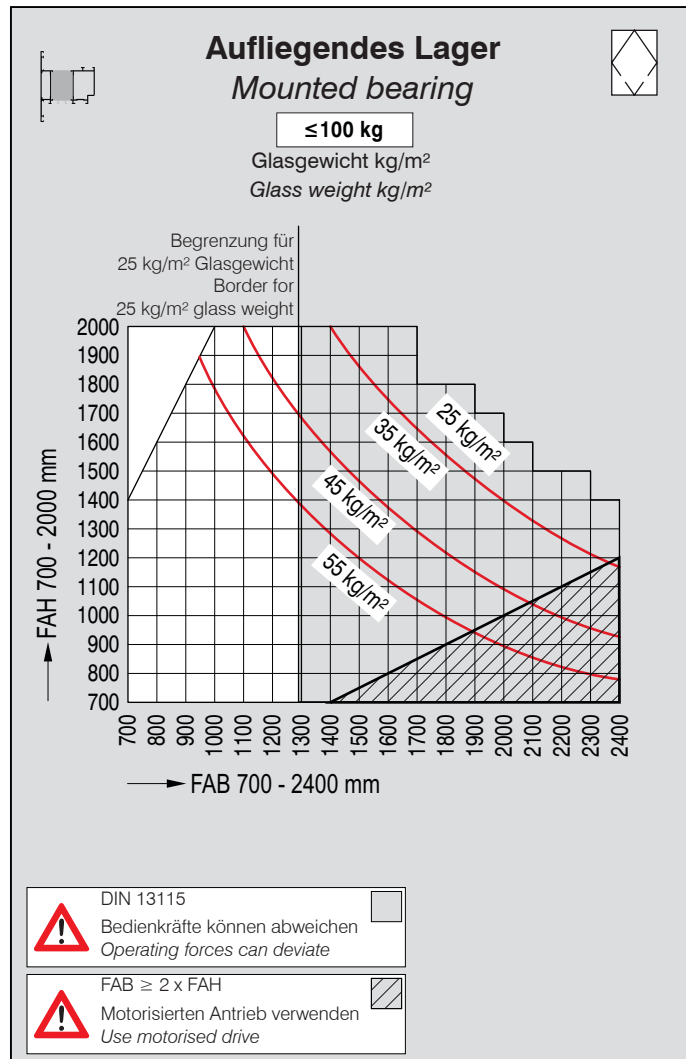
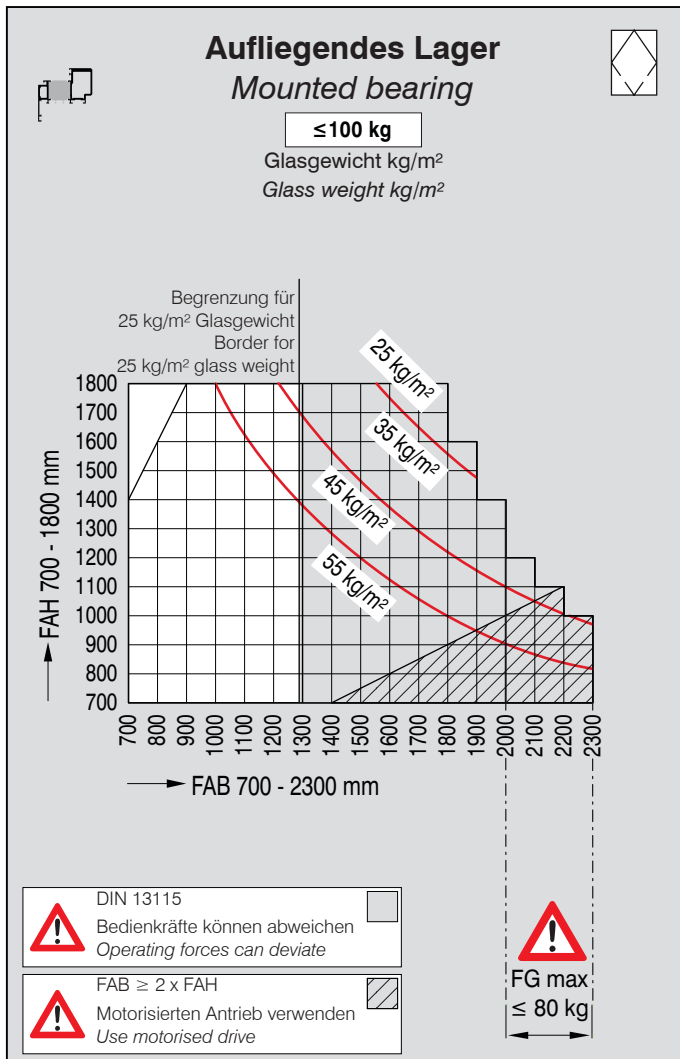

Zulässige Formatgrößen, aufliegende Beschläge
Admissible format sizes, top mounted fittings



WICSTAR

Flügelgewicht max. 100 kg
Schwing-Wende-Beschlag
Sash weight max. 100 kg
Horizontal / Vertical pivot window fitting

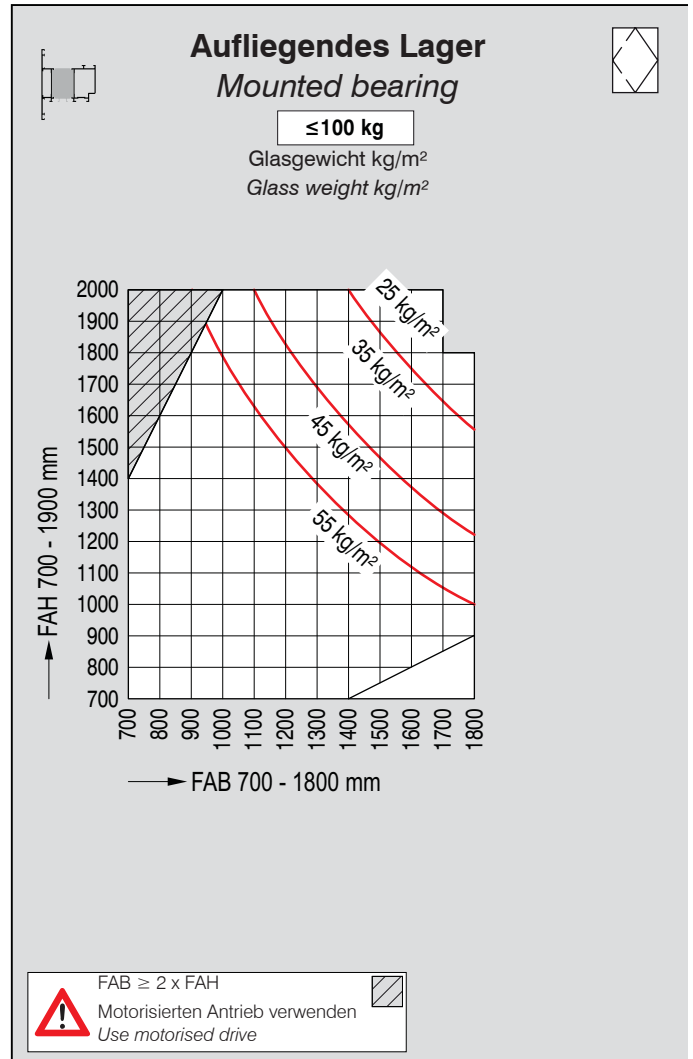
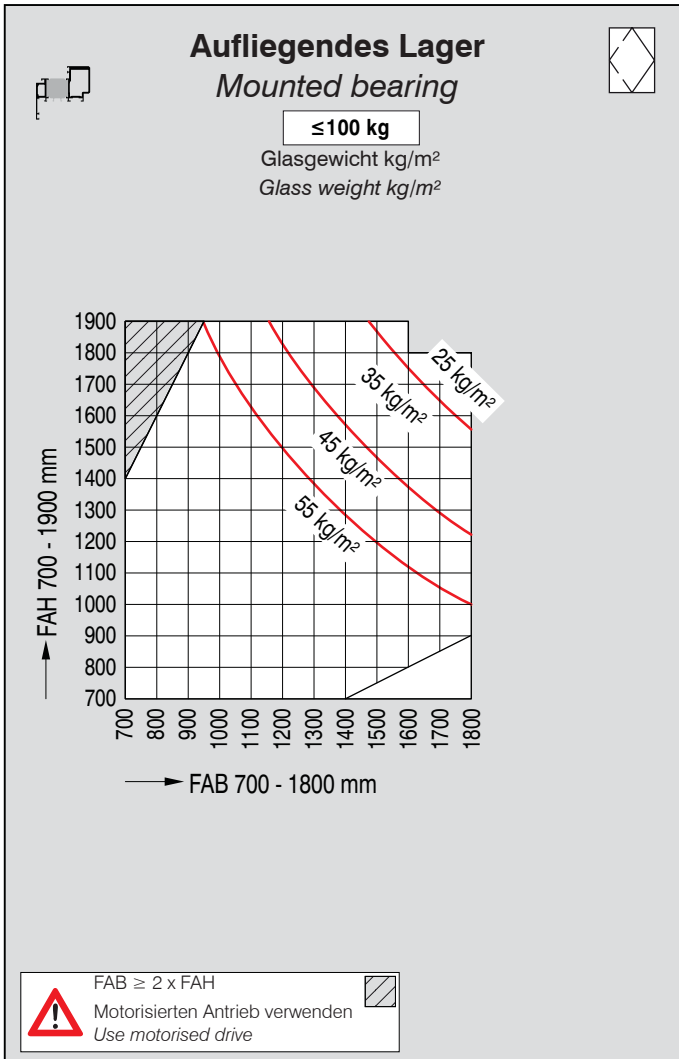



Dreh-Kipp-Beschlag Turn/tilt fitting

Griff Stellungen
Handle position

Kipp / tilted



Dreh / turned

Zu / closed

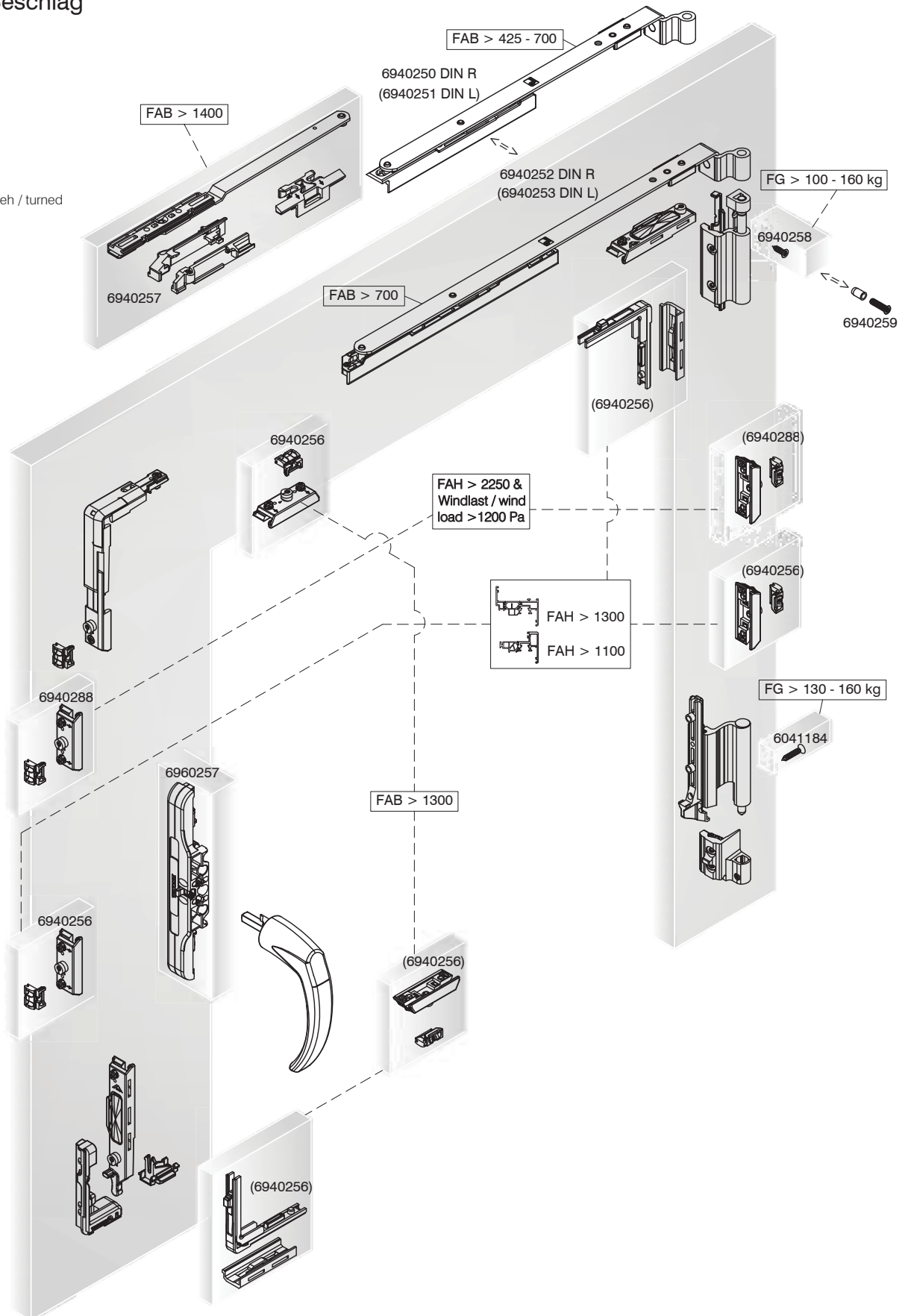



Dreh-Kipp-Beschlag 200 kg Turn/tilt fitting 200 kg

Griff Stellungen
Handle position

Kipp / tilted

Dreh / turned

Zu / closed

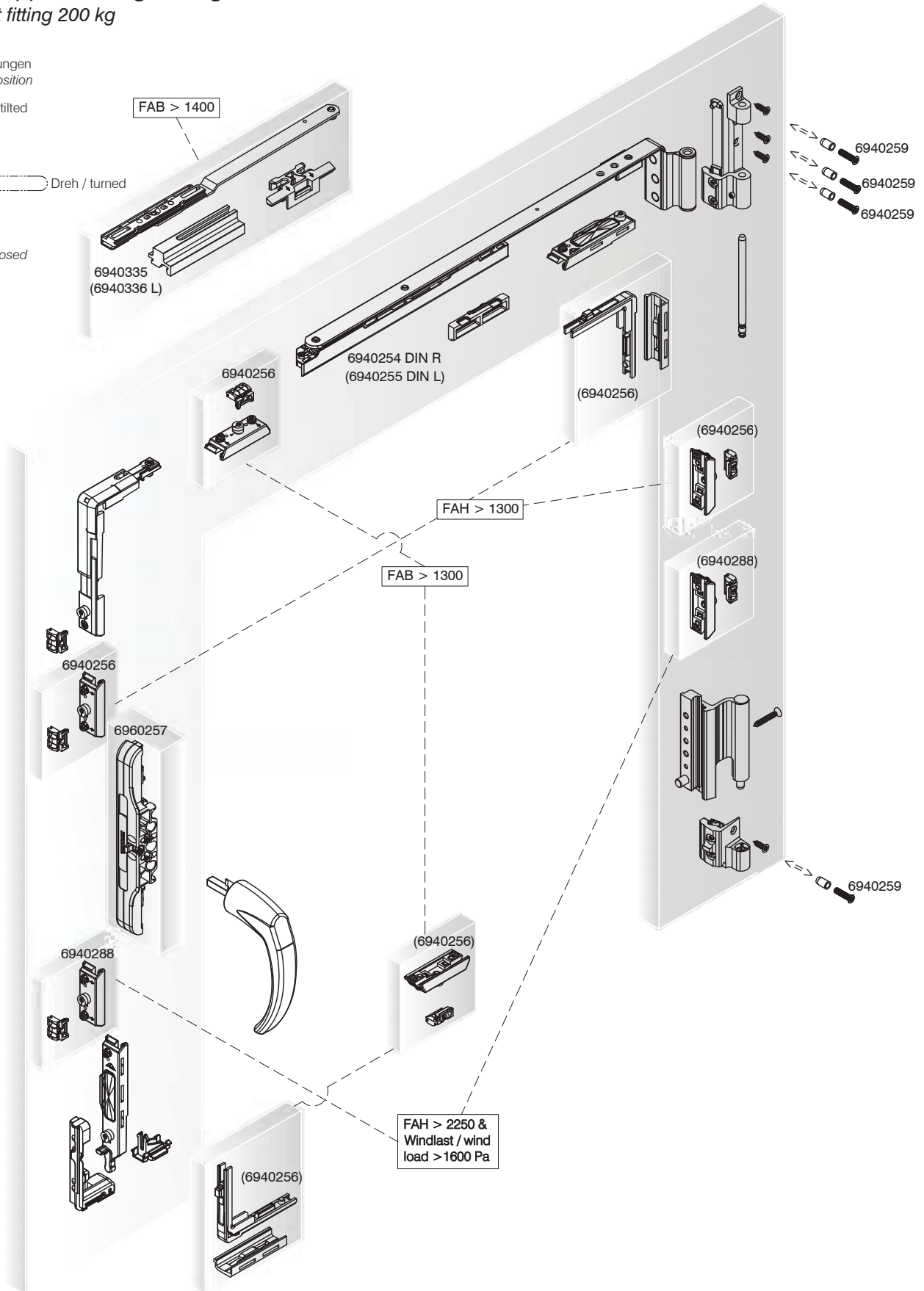

WICLINE

Grundbeschlag
Basic fitting

Beschläge
Fittings



Schräg / Rundbogen-Beschlag
Sloped / arched fitting

Griff Stellungen
Handle position

Kipp / tilted



Dreh / turned

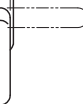

Zu / closed

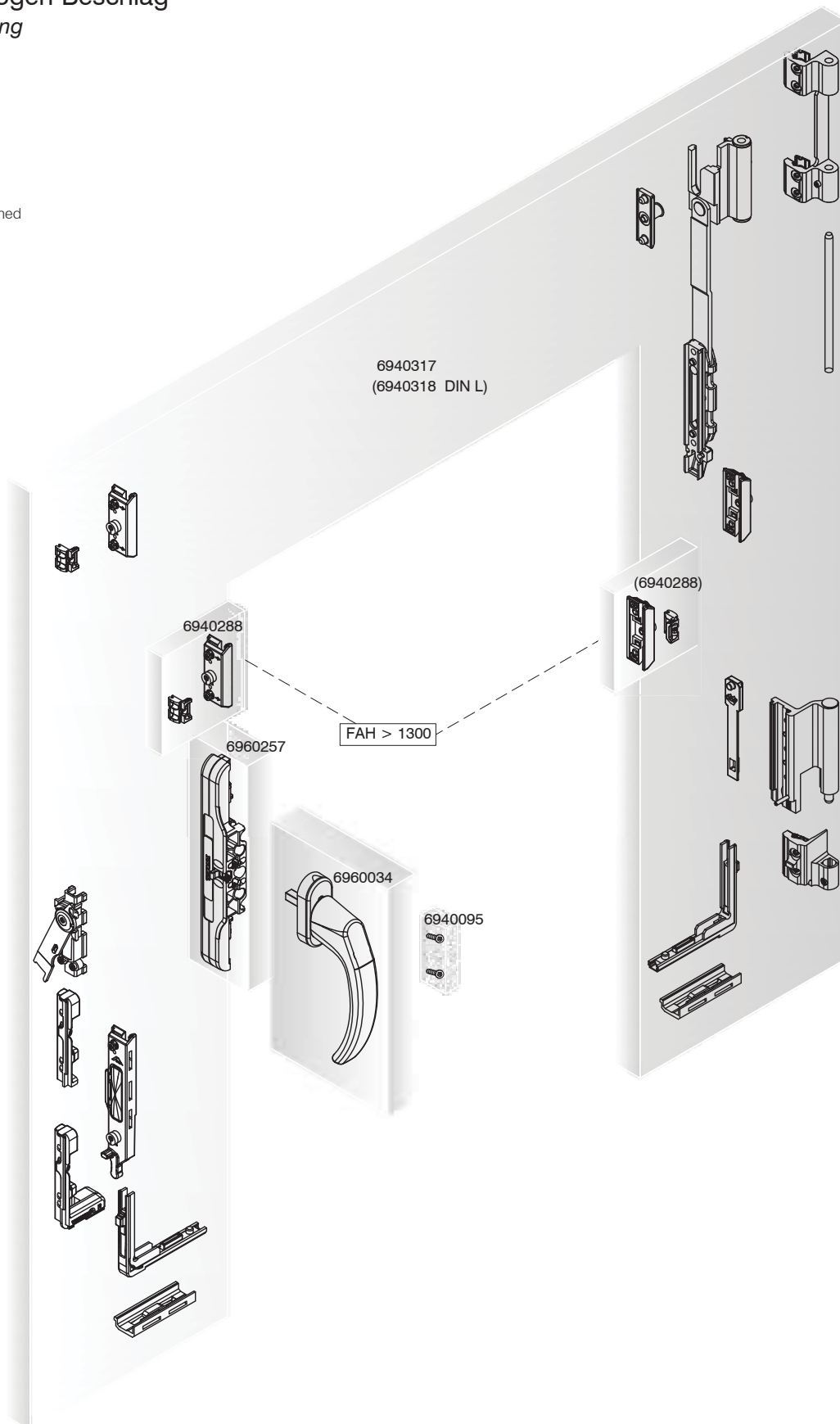



Tilt-First-Beschlag Tilt-first fitting

Griff Stellungen
Handle position

Dreh / turned



Kipp / tilted

Zu / closed

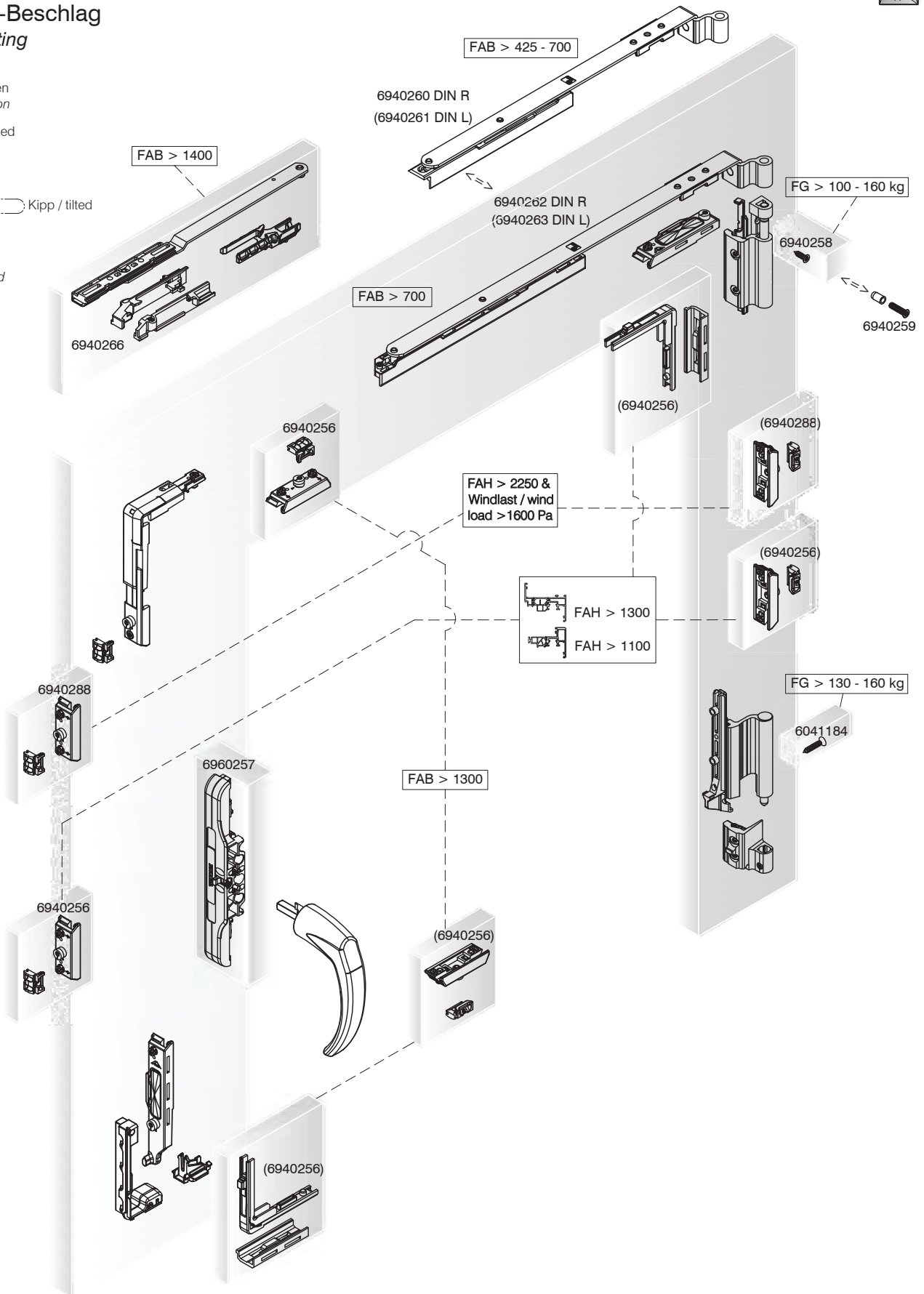



Dreh-Beschlag Turn fitting

Griff Stellungen
Handle position

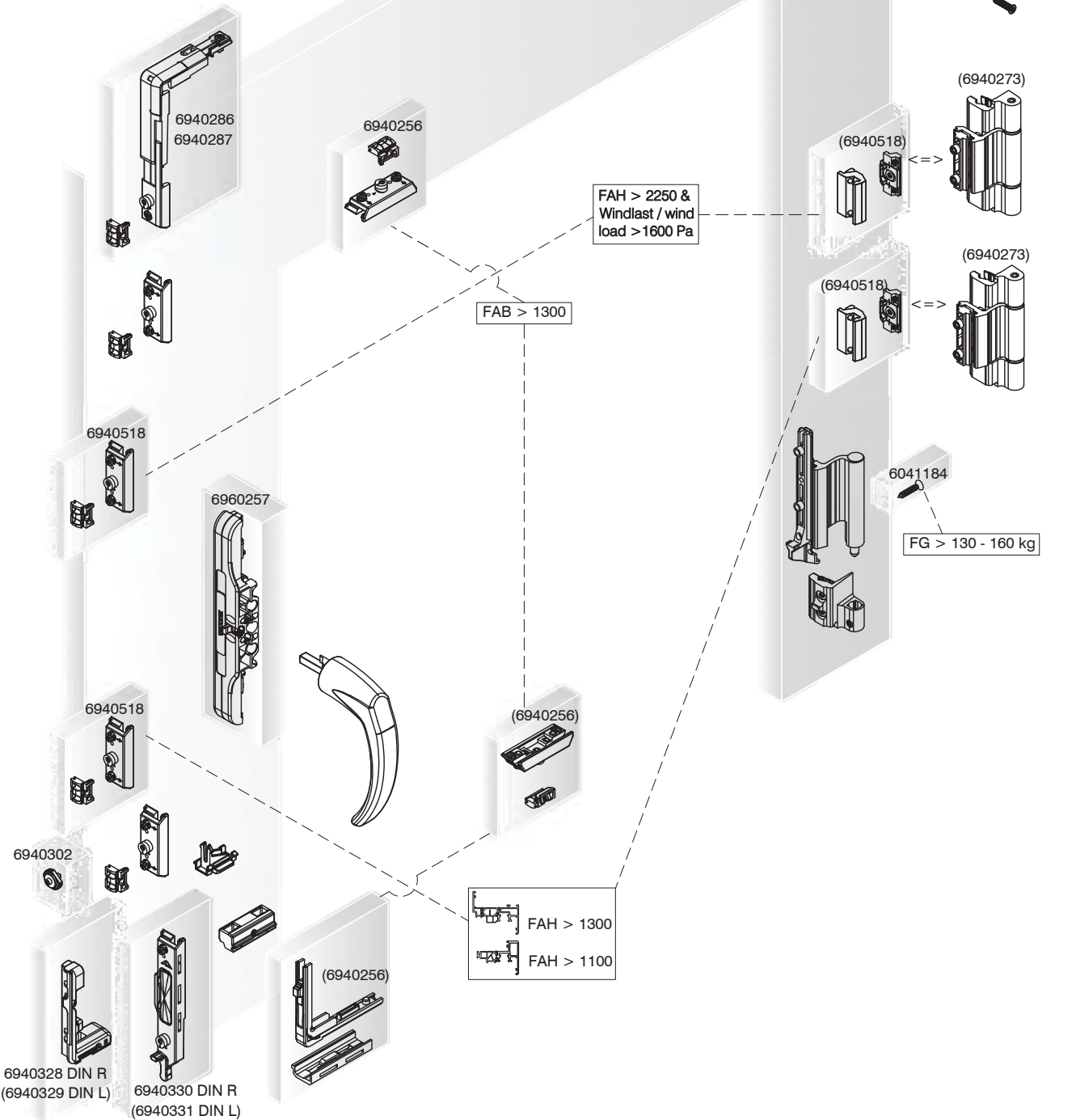
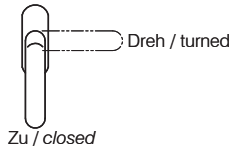

WICLINE

Grundbeschlag
Basic fitting

Beschläge Fittings



Dreh-Beschlag 200 kg
Turn fitting 200 kg

Griff Stellungen
Handle position

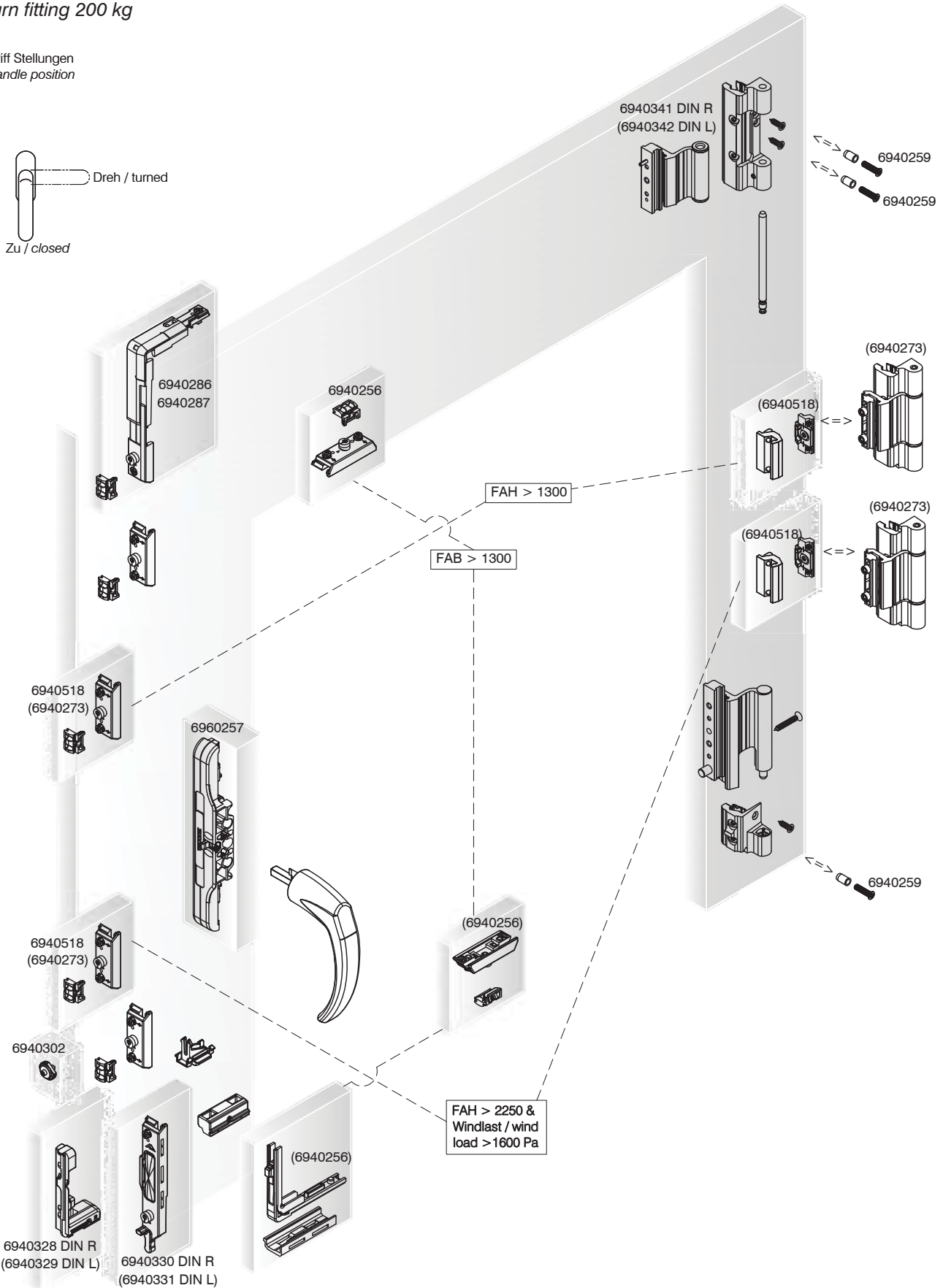
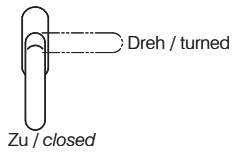

Stulp-Beschlag 130 kg mit Kniehebel Double casement door fitting 130 kg with toggle lever

Kniehebel Stellungen
Toggle lever position

Offen / opened

Zu / closed

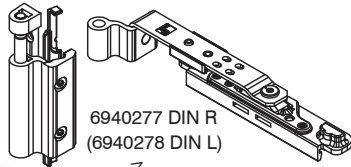

Griff Stellungen
Handle position

Dreh / turned

Zu / closed



Kipp / tilted

Zu / closed

FG > 100 - 160 kg

Standflügel DIN L
Inactive sash DIN L

Gehflügel DIN R
Active sash DIN R

FAB > 700

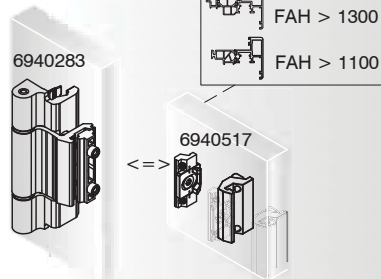
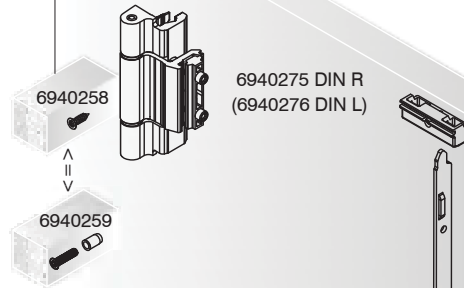

FAH > 1300
FAH > 1100



ersetzen
replace



ersetzen
replace

FAB x FAH
> 1.5 m² &
Windlast /
wind load
> 1200 Pa

FAH > 1300
FAH > 1100

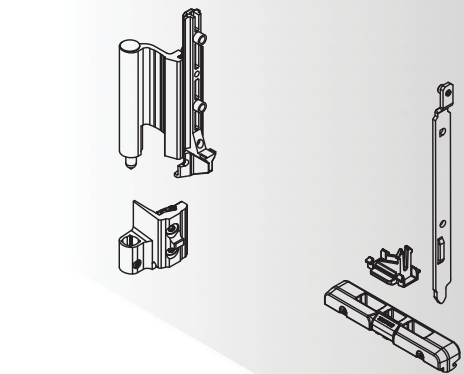

ersetzen
replace

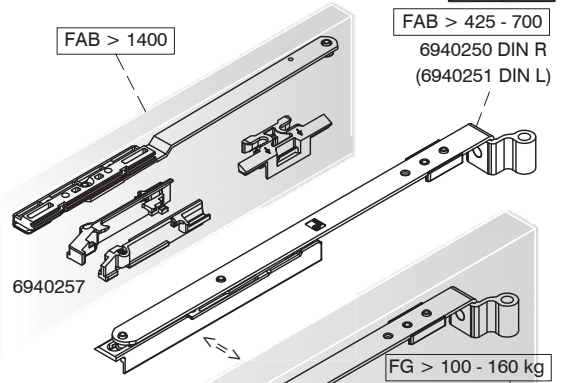

FAB > 425 - 700
6940250 DIN R
(6940251 DIN L)

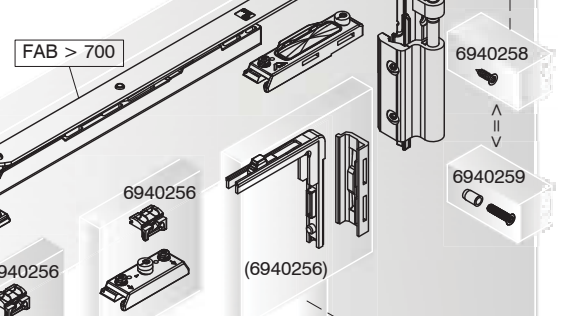

FAB > 1300

FAH > 1300
FAH > 1100

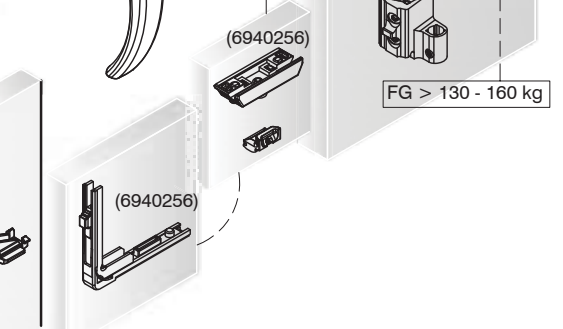

FG > 130 - 160 kg

Stulp-Beschlag 130 kg mit Kniehebel Double casement door fitting 130 kg with toggle lever

Kniehebel Stellungen
Toggle lever position

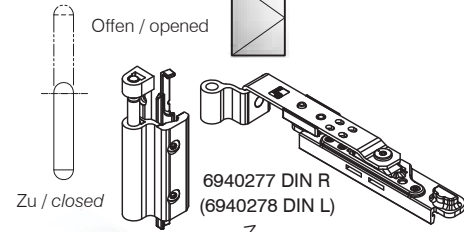

Griff Stellungen
Handle position

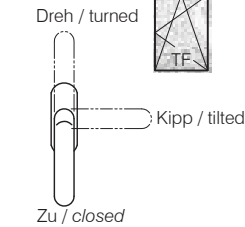

FG > 100 - 160 kg

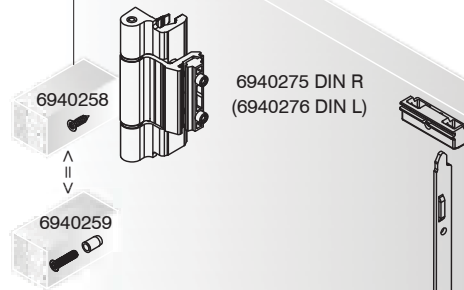

Standflügel DIN L
Inactive sash DIN L

Gehflügel DIN R
Active sash DIN R

FAH > 1300
FAH > 1100

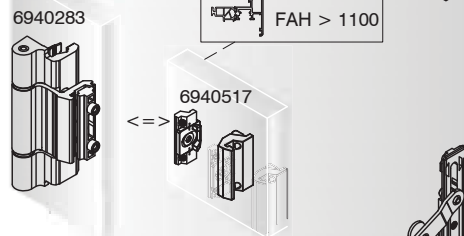

6040548
ersetzen
replace

6040548
6940256

6960257

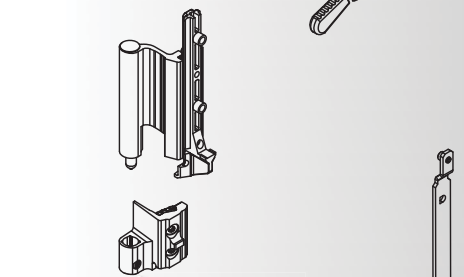

6940281 R
6940282 L

Alle Verschlusssteile
ersetzen
durch
TF-Teile
6940281/6940282

Replace all
locking pieces
by TF-items
6940281/6940282

FAB > 1400

FAB > 425 - 700
6940260 DIN R
(6940261 DIN L)

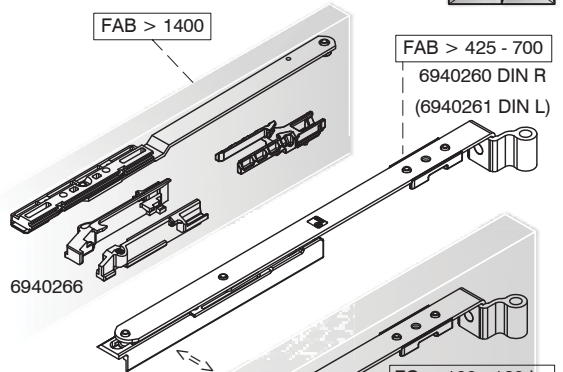

FAB > 700

6940262 DIN R
(6940263 DIN L)

6940256

(6940256)

FG > 100 - 160 kg

6940258

6940259

FAB > 1300

FAB x FAH
> 1.5 m² &
Windlast /
wind load
> 1200 Pa

FAH > 1300
FAH > 1100

(6940256)



6041184

(6940256)

FG > 130 - 160 kg

Stulp-Beschlag 130 kg mit Kniehebel Double casement door fitting 130 kg with toggle lever

Kniehebel Stellungen
Toggle lever position

Griff Stellungen
Handle position



Offen / opened



Standflügel DIN L
Inactive sash DIN L

Zu / closed

Zu / closed

Dreh / turned

Gehflügel DIN R
Active sash DIN R

FG > 100 - 130 kg

FG > 100 - 160 kg

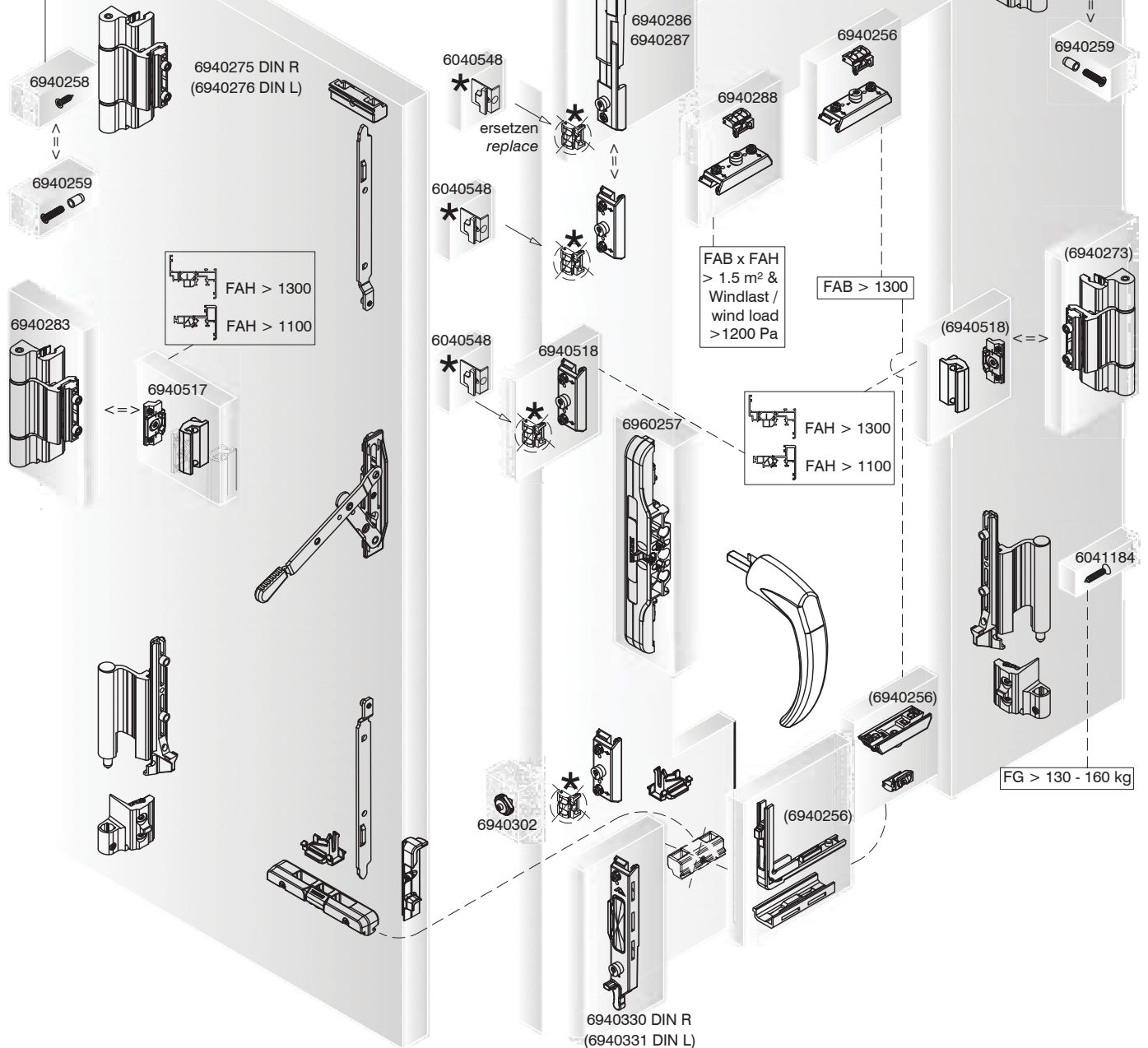

Stulp-Beschlag 160 kg mit Stulpgetriebe Double casement door fitting 160 kg with double casement gear

Kniehebel Stellungen
Toggle lever position

Zu / closed

Offen / opened

 **Standflügel DIN L**
Inactive sash DIN L

Griff Stellungen
Handle position

Dreh / turned

Kipp / tilted

Zu / closed

 **Gehflügel DIN R**
Active sash DIN R

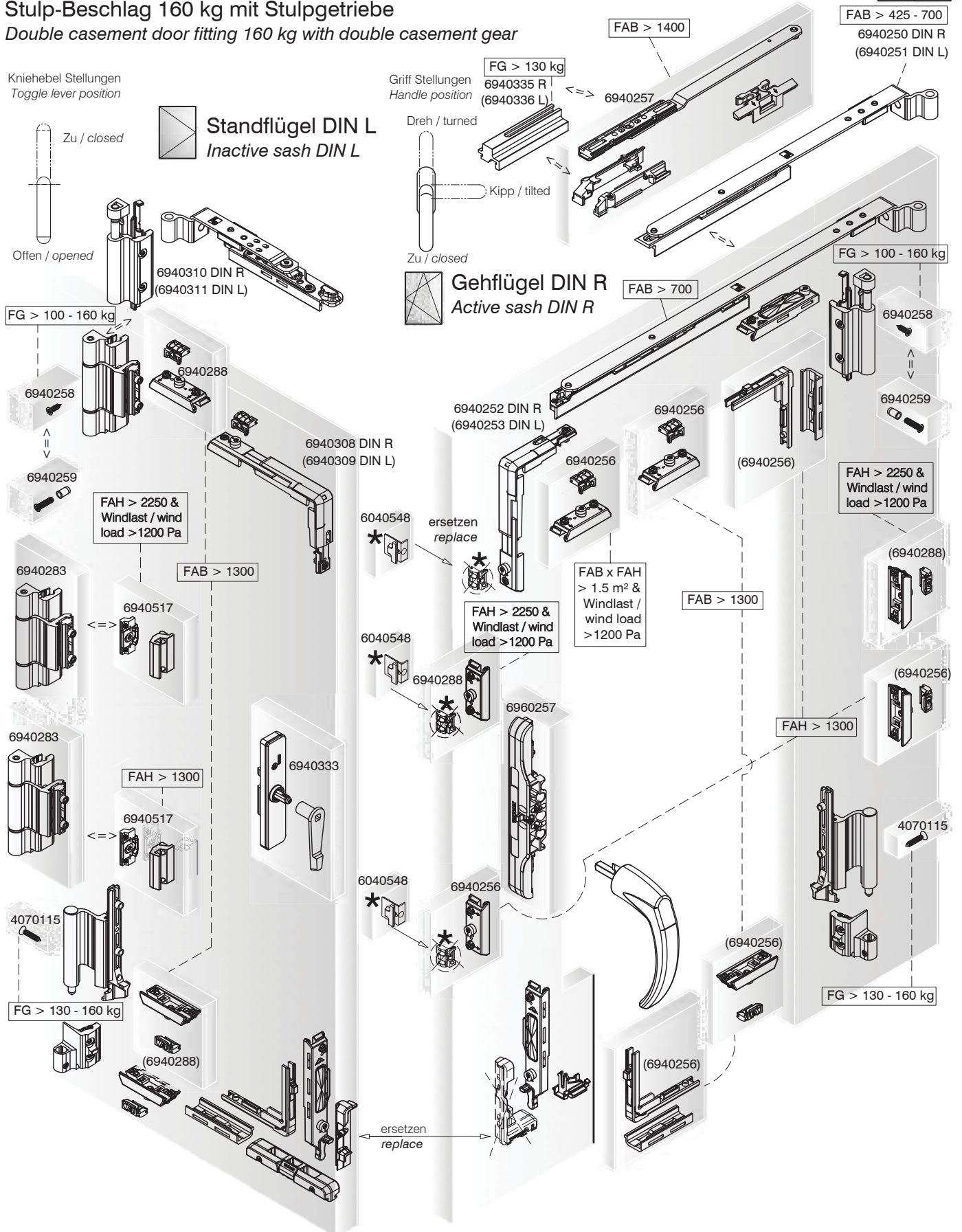

Stulp-Beschlag 160 kg mit Stulpgetriebe Double casement door fitting 160 kg with double casement gear

Kniehebel Stellungen
Toggle lever position

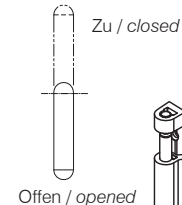

Standflügel DIN L
Inactive sash DIN L

Griff Stellungen
Handle position

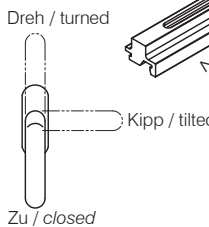

Gehflügel DIN R
Active sash DIN R

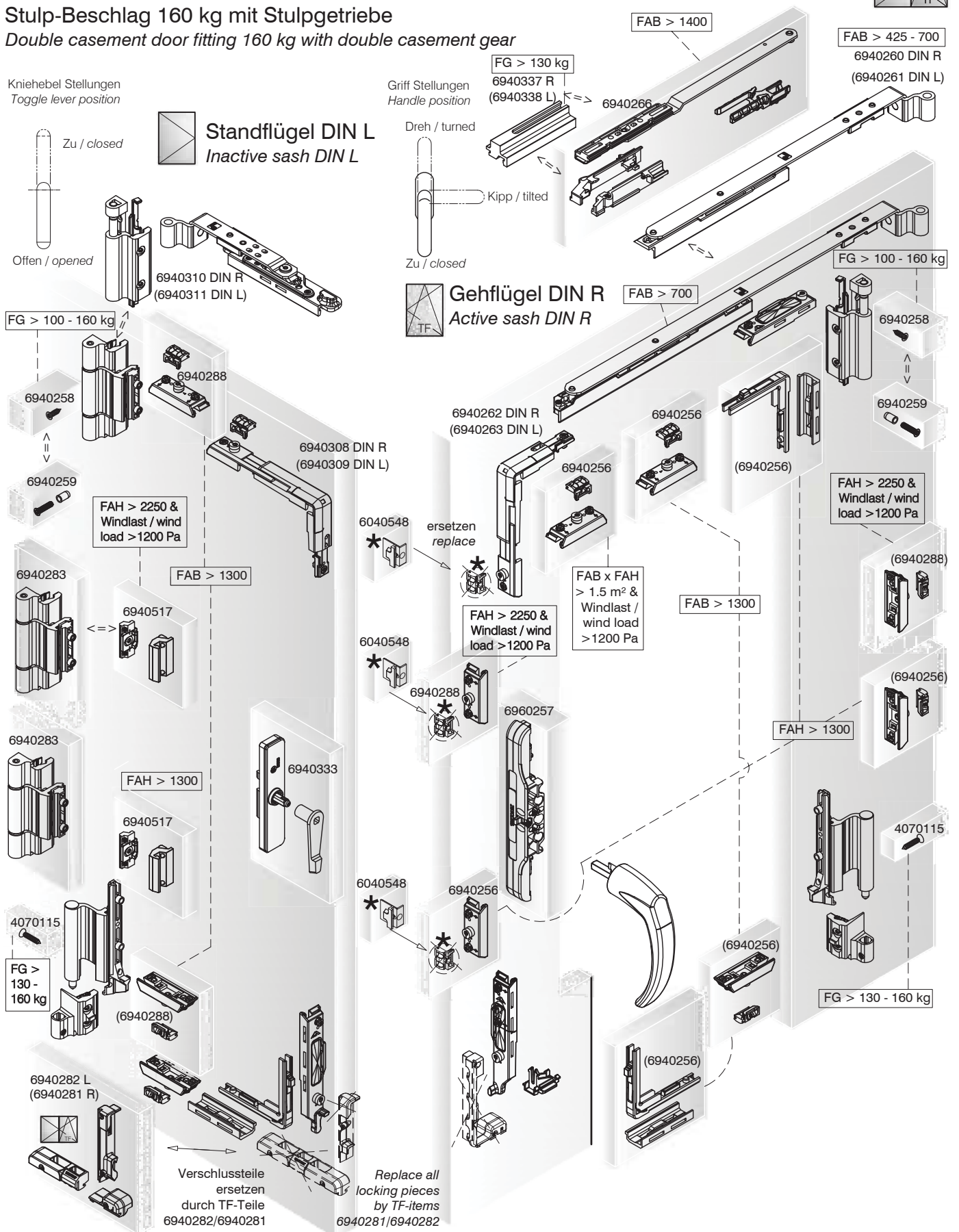

Stulp-Beschlag 160 kg mit Stulpgetriebe Double casement door fitting 160 kg with double casement gear

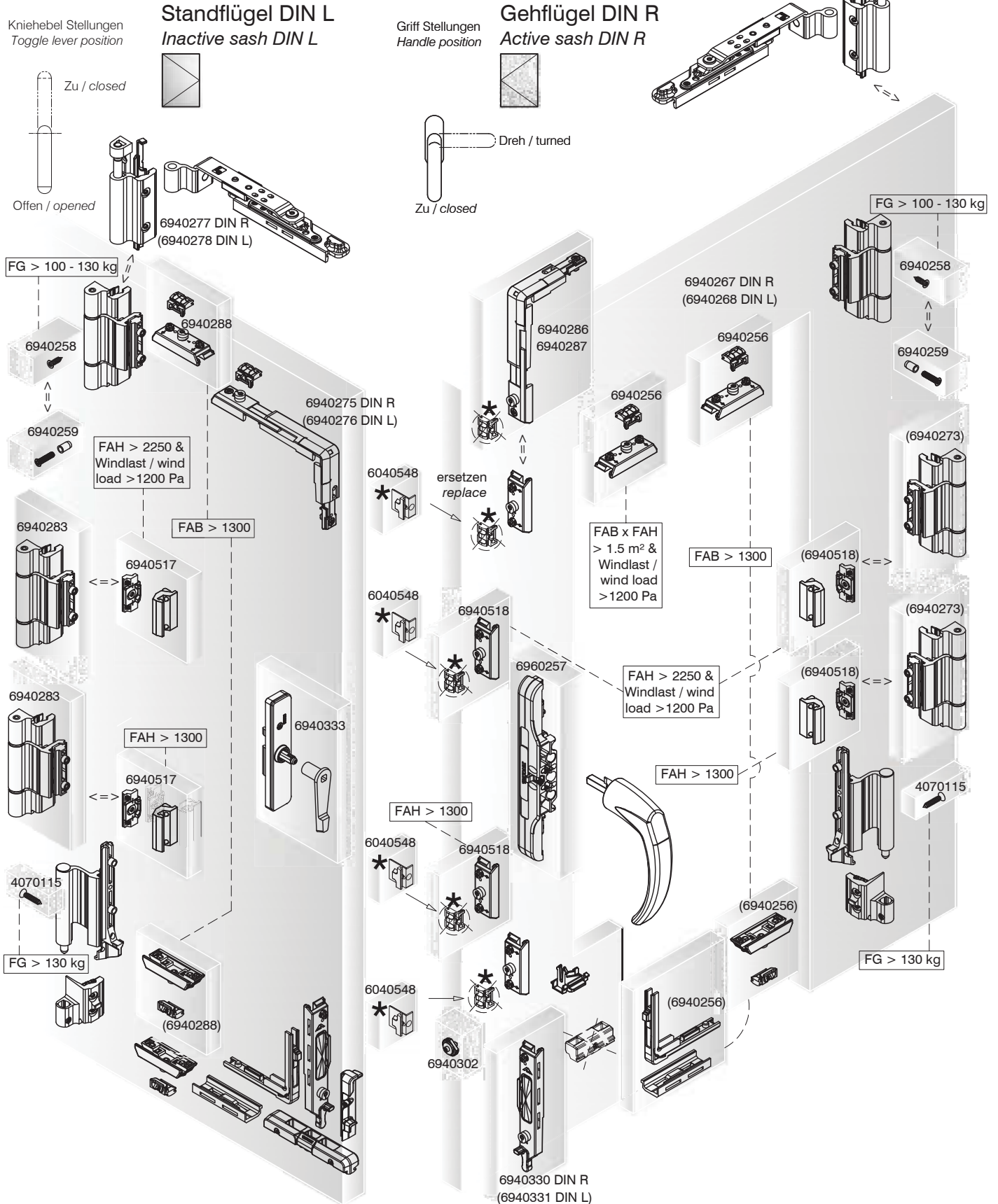



Kipp-Beschlag 130 kg Querformat Tilt fitting 130 kg landscape

Griff Stellungen
Handle position

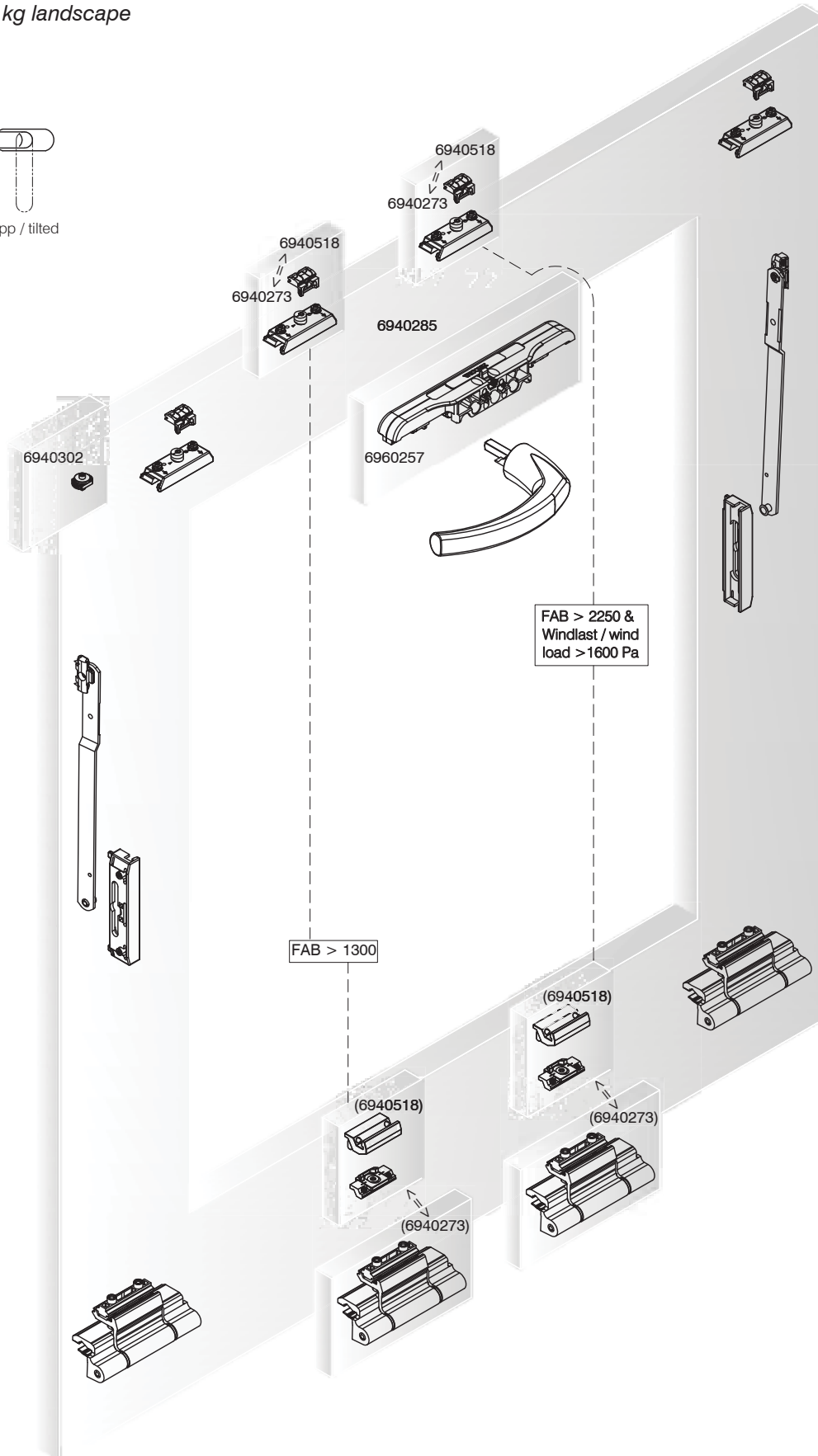
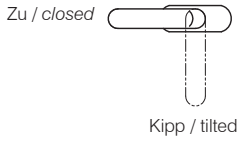



Kipp-Beschlag 130 kg Querformat mit vertikalen Mittelverriegelungen Tilt fitting 130 kg landscape with vertical centre lockings

Griff Stellungen
Handle position

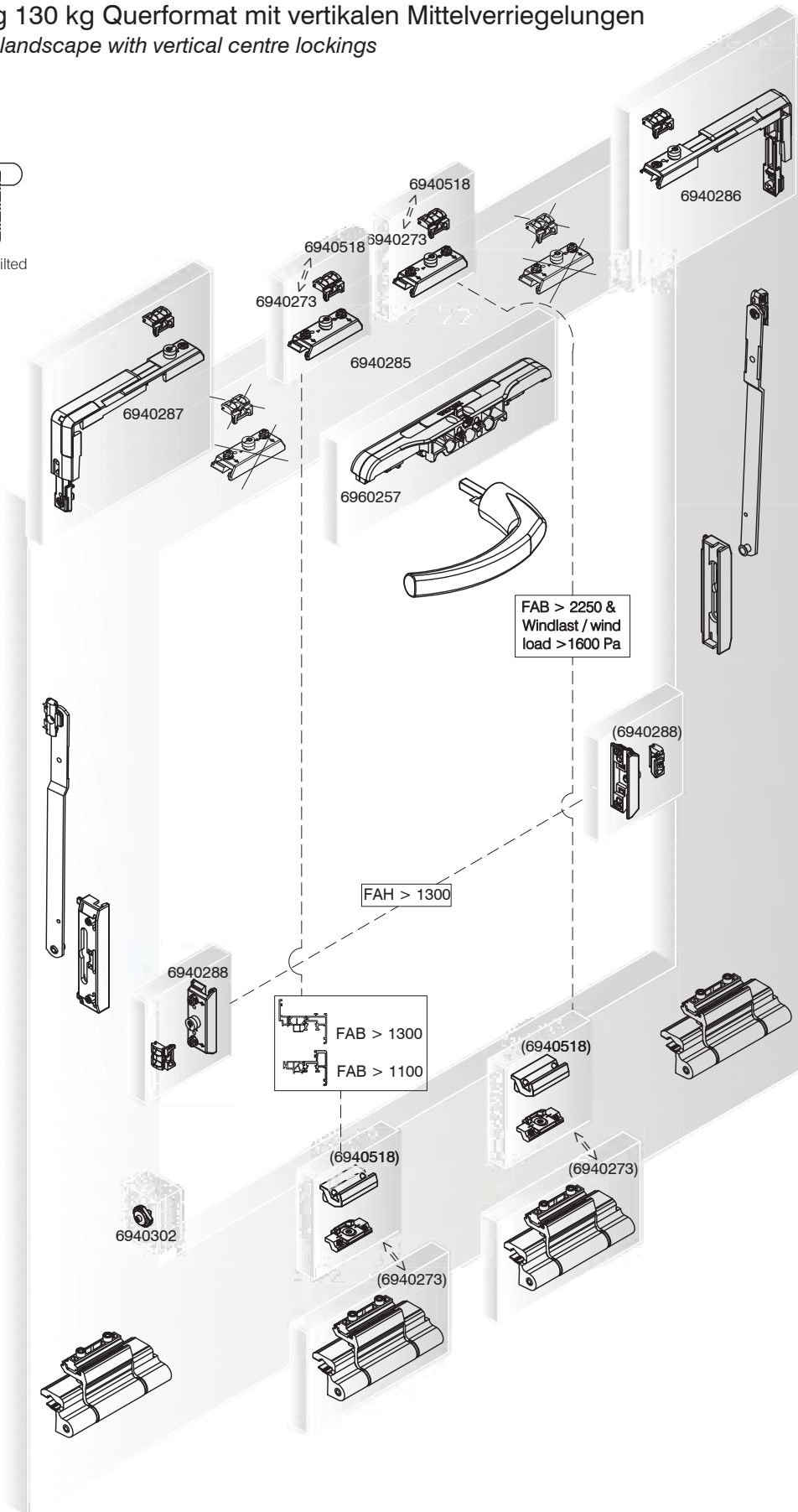
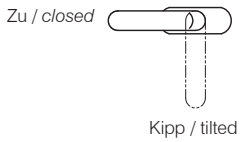



Kipp-Beschlag 130 kg Hochformat Tilt fitting 130 kg portrait

Griff Stellungen
Handle position

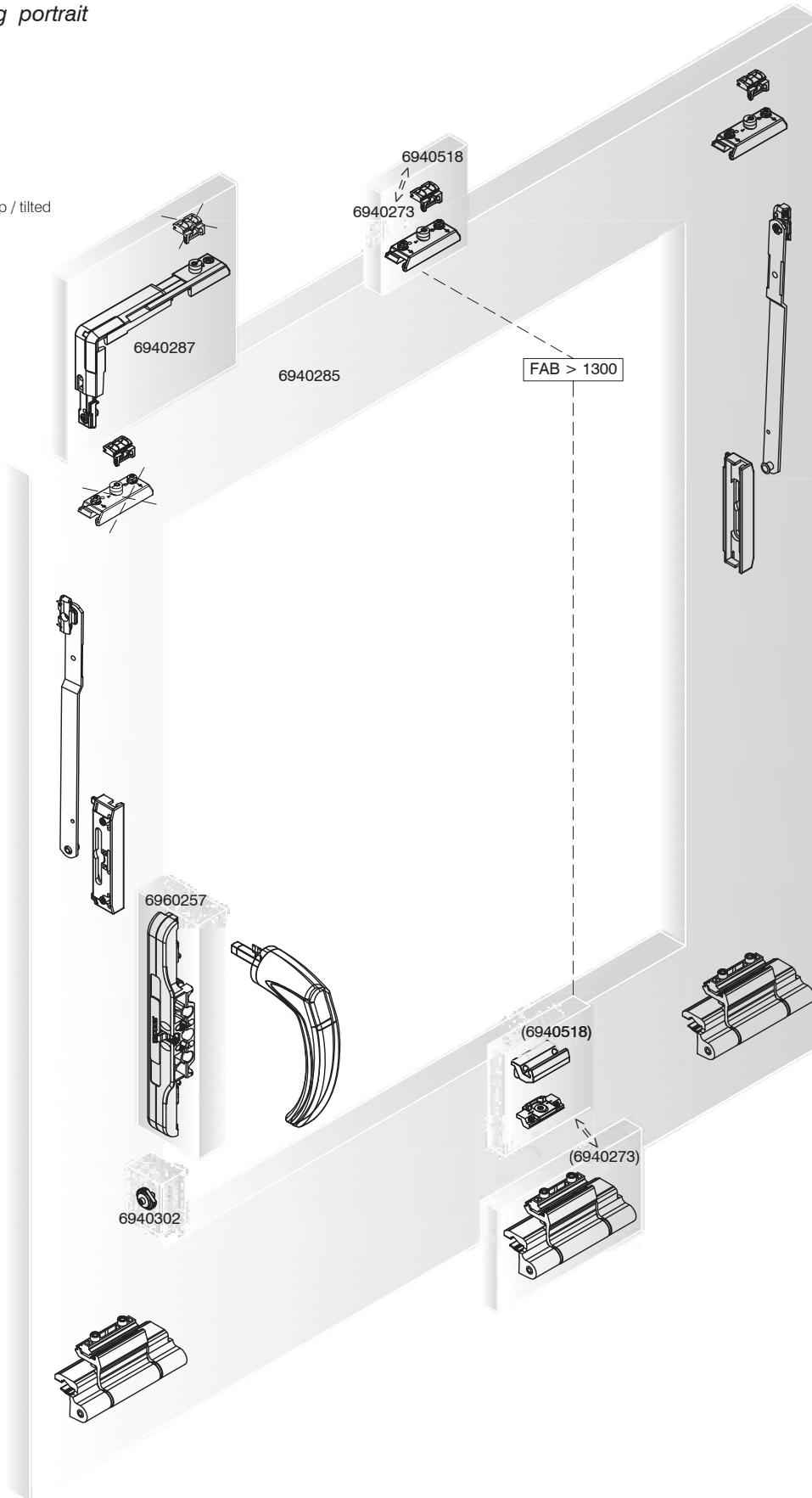
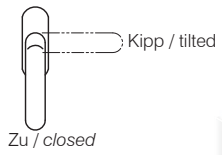



Kipp-Beschlag 130 kg Hochformat mit vertikalen Mittelverriegelungen Tilt fitting 130 kg portrait with vertical centre lockings

Griff Stellungen
Handle position

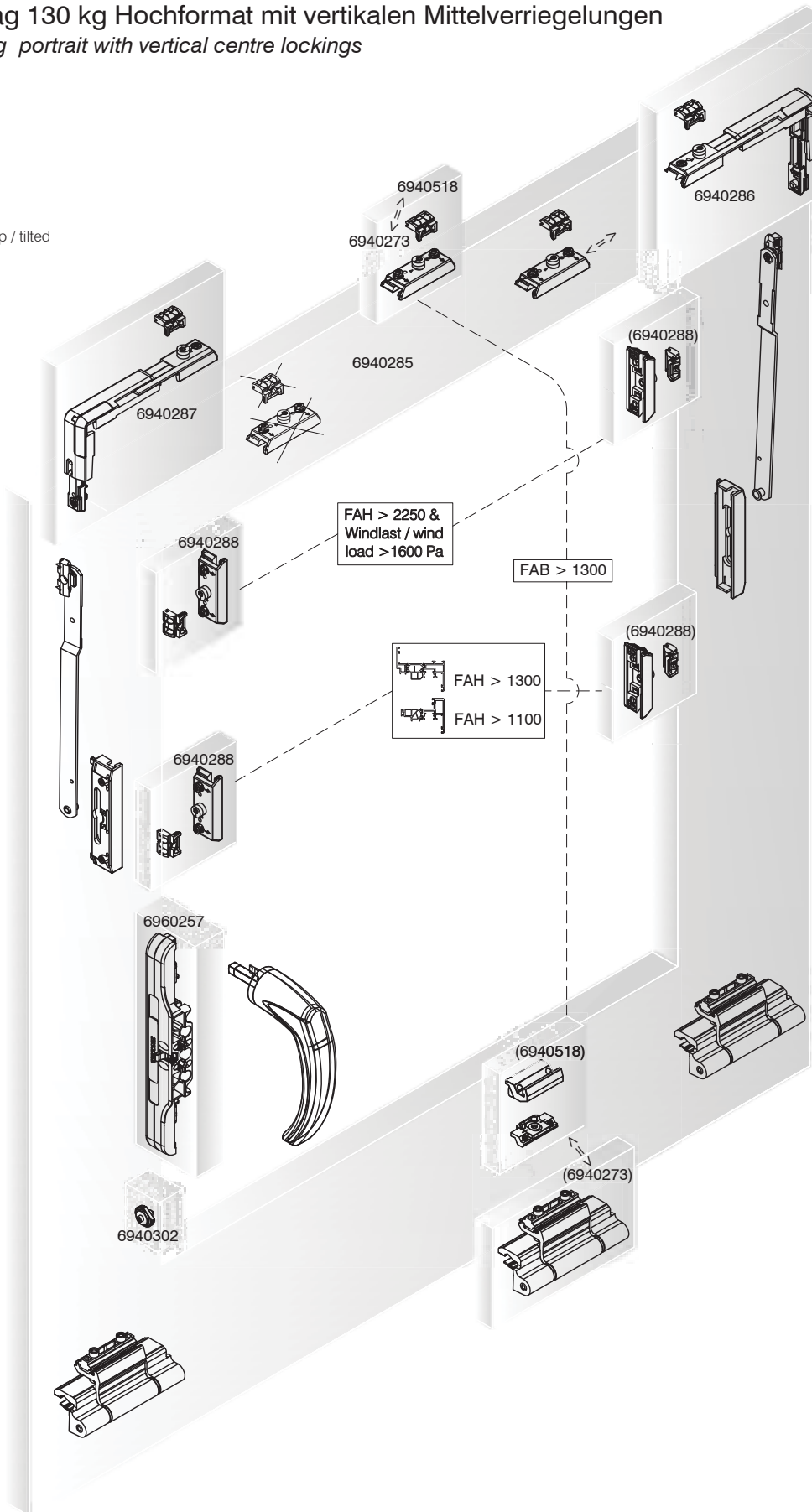
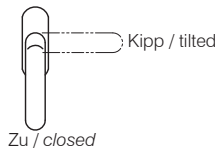



Dreh-Beschlag für Lüftungsklappe Turn fitting for ventilation flap

Griff Stellungen
Handle position

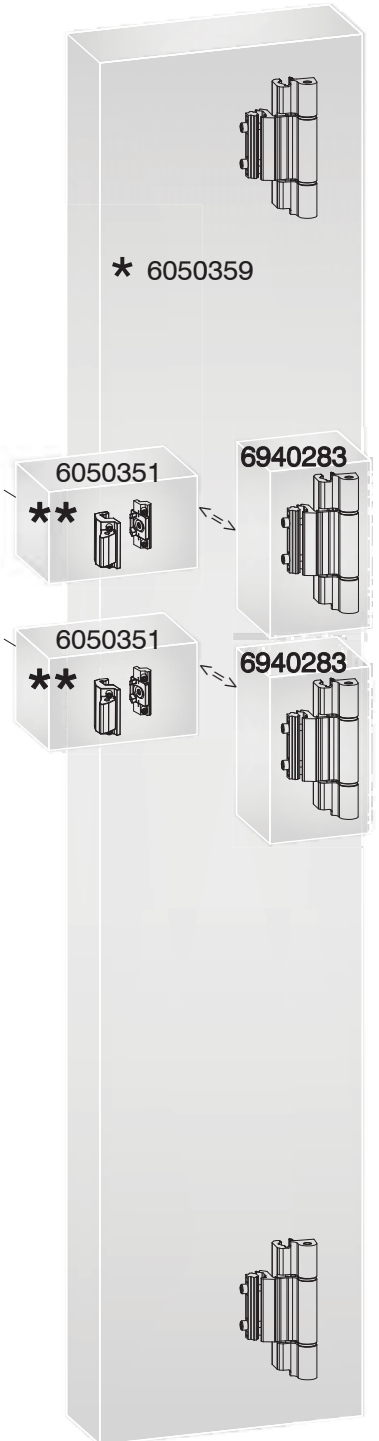
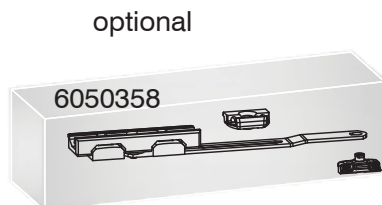
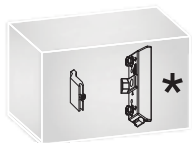
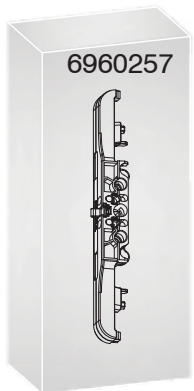
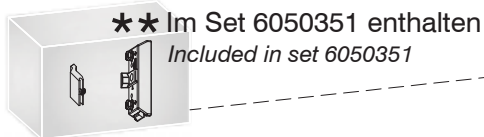
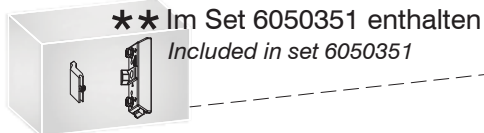
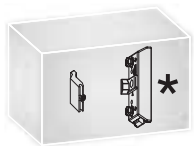
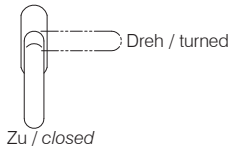



Dreh-Beschlag, verdeckt für Lüftungsklappe Turn fitting, concealed for ventilation flap

Griff Stellungen
Handle position

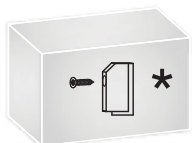
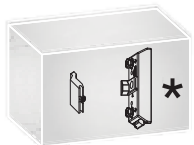
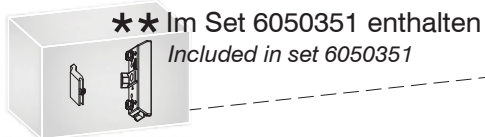
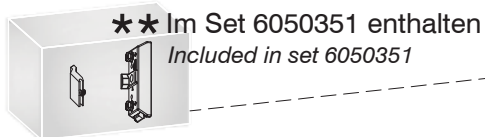
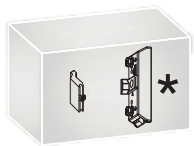
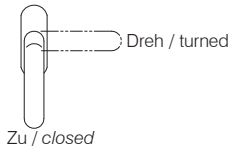

* Im Grundbeschlag enthalten
Included in the basic fitting





Dreh-Beschlag für Lüftungsklappe mit Lüftungsklappenantrieb
Turn fitting for ventilation flap with ventilation flap drive

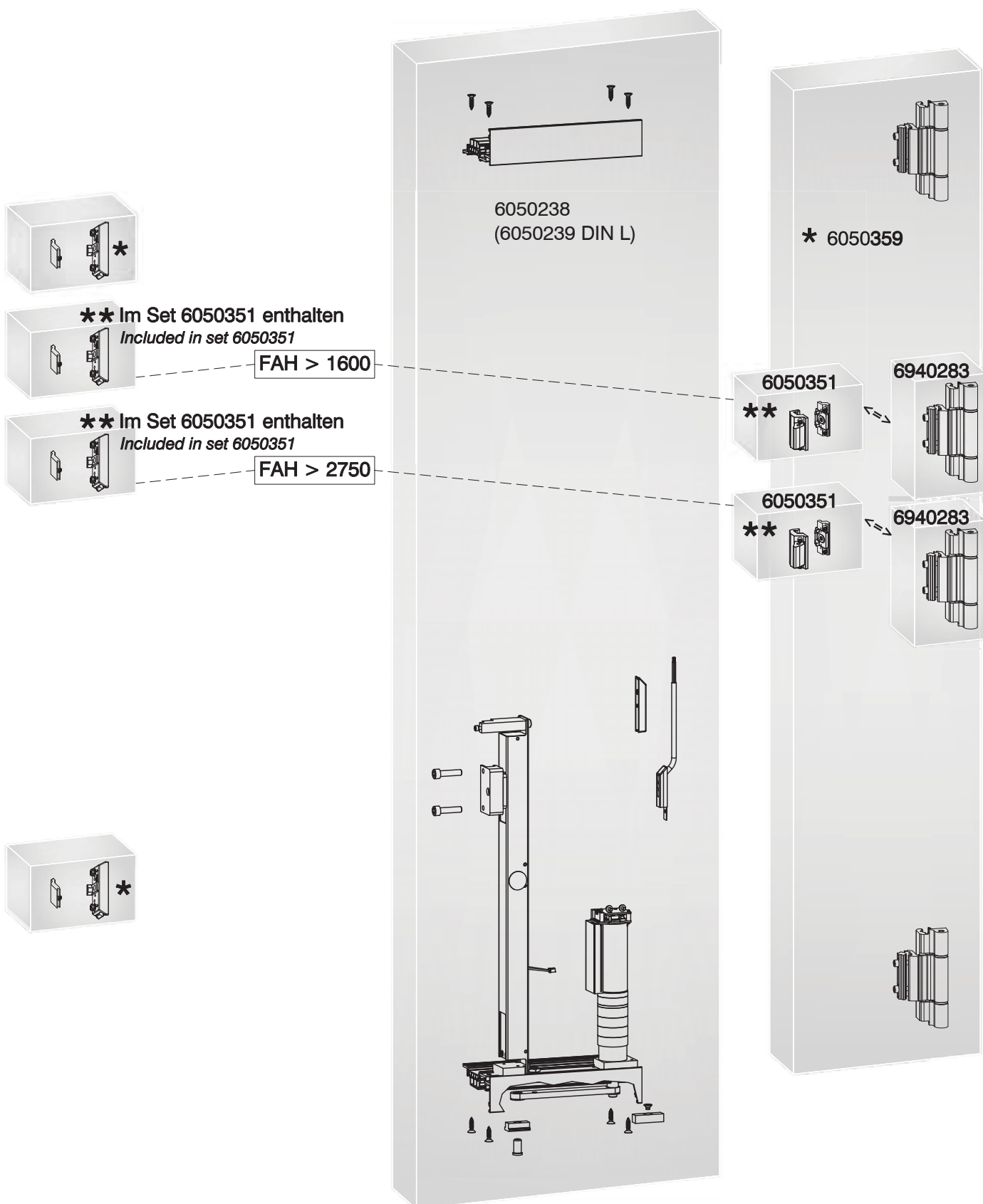



Oberlicht-Beschlag verdeckt
Fanlight fitting concealed



Griff Stellungen
Handle position

Zu / closed



Kipp / tilted

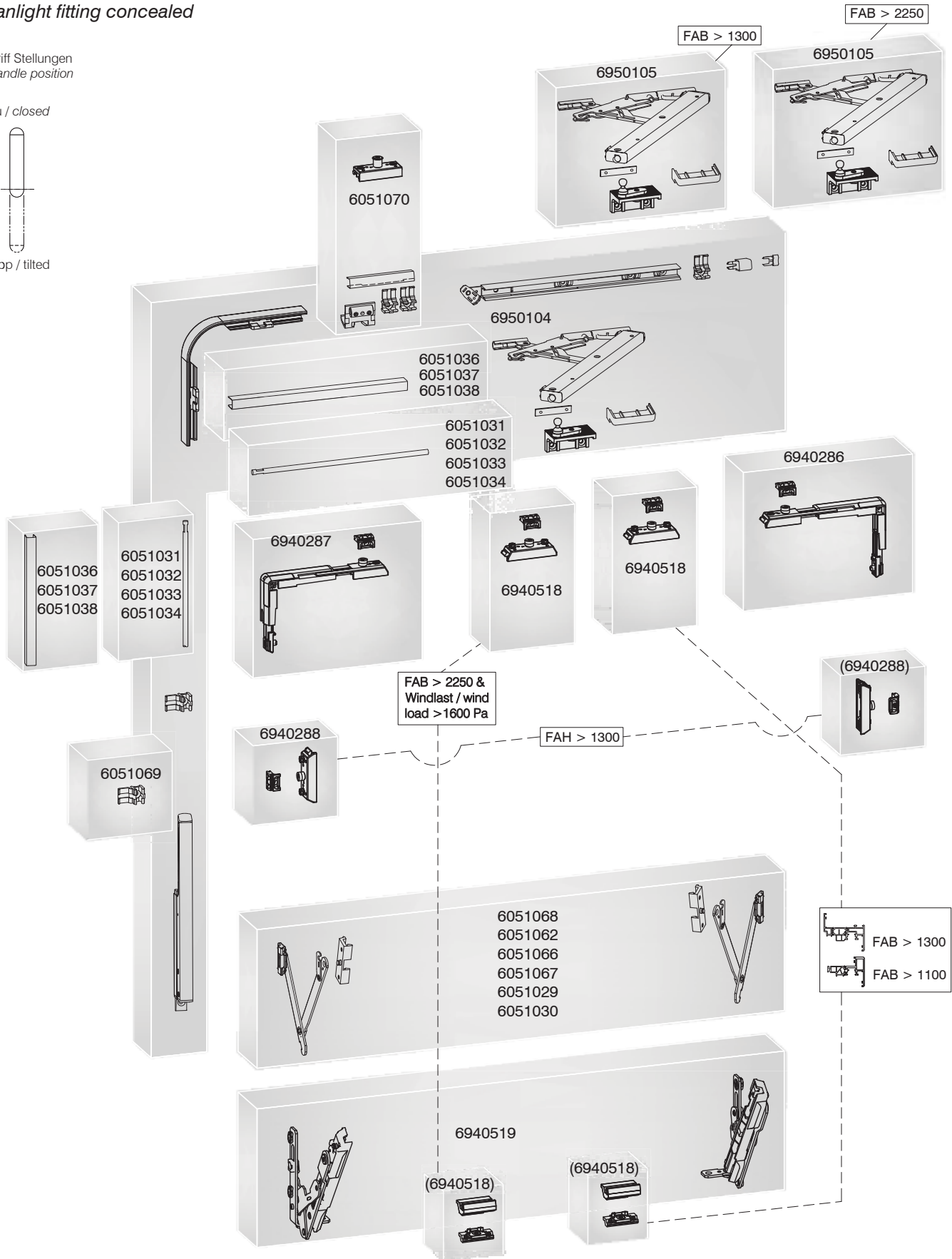

Grundbeschlag
Basic fitting

Oberlicht-Beschlag
Fanlight fitting



Griff Stellungen
Handle position

Zu / closed

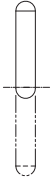

Kipp / tilted

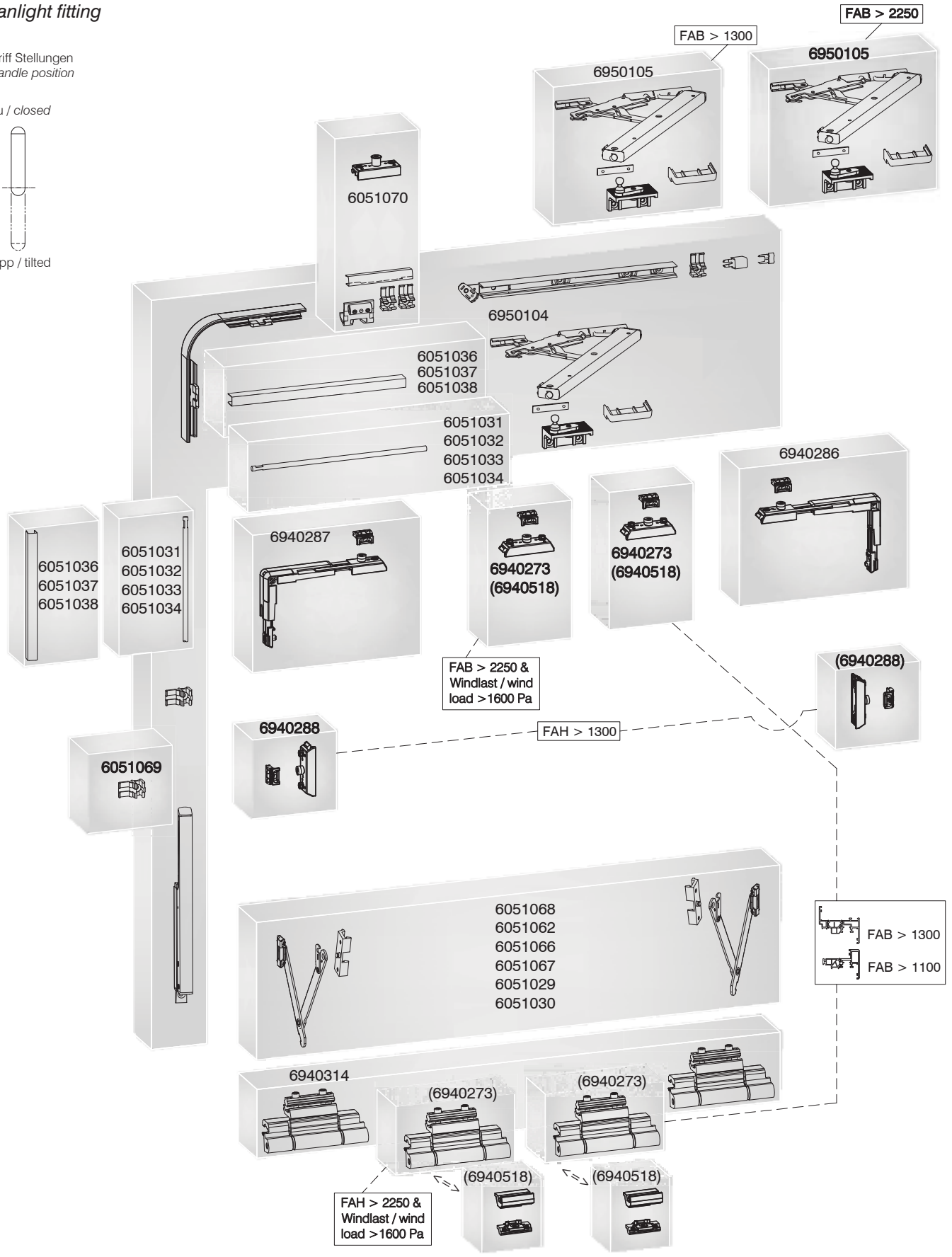



Oberlicht-Beschlag verdeckt, Schrägfenster
Fanlight fitting concealed, sloped window

Griff Stellungen
Handle position

Zu / closed

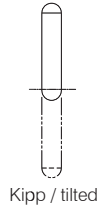

Kipp / tilted

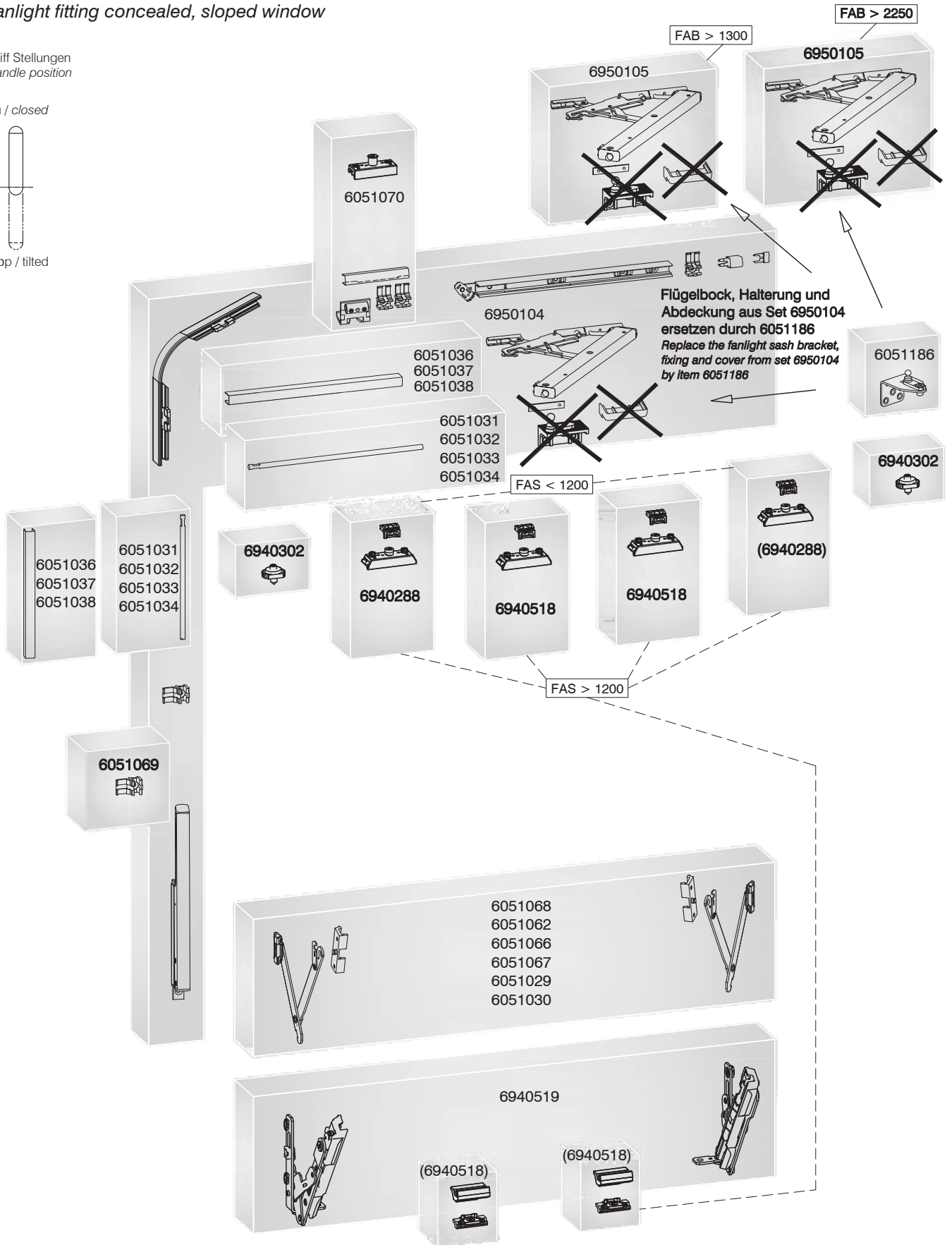

Grundbeschlag
Basic fitting

Oberlicht-Beschlag Schrägfenster
Fanlight fitting sloped window



Griff Stellungen
Handle position

Zu / closed

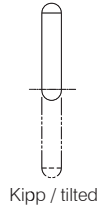

Kipp / tilted

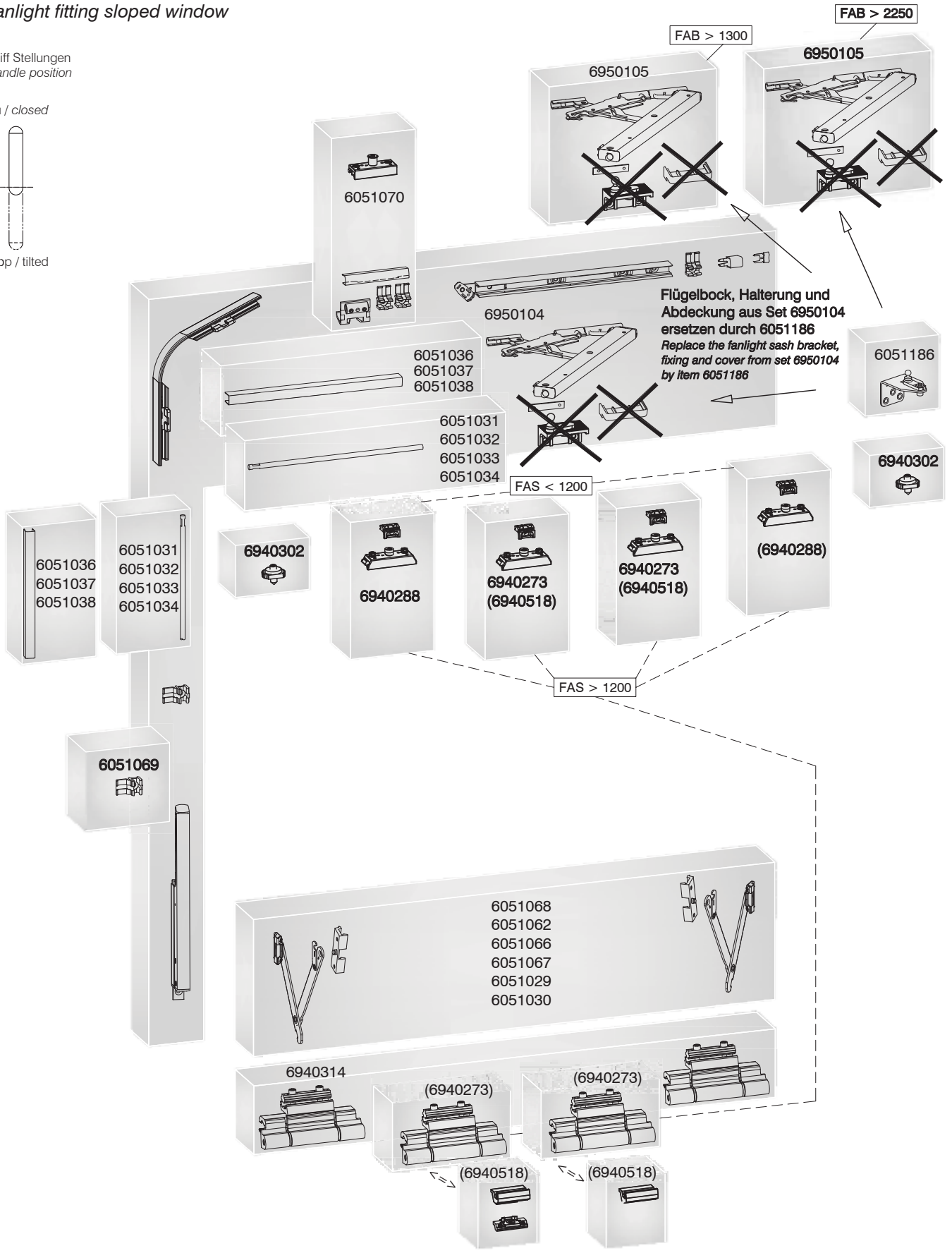

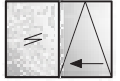

Parallel-Schiebe-Kipp-Beschlag ohne Zwangssteuerung bis 160 kg
Parallel sliding tilt fitting without force control up to 160 kg

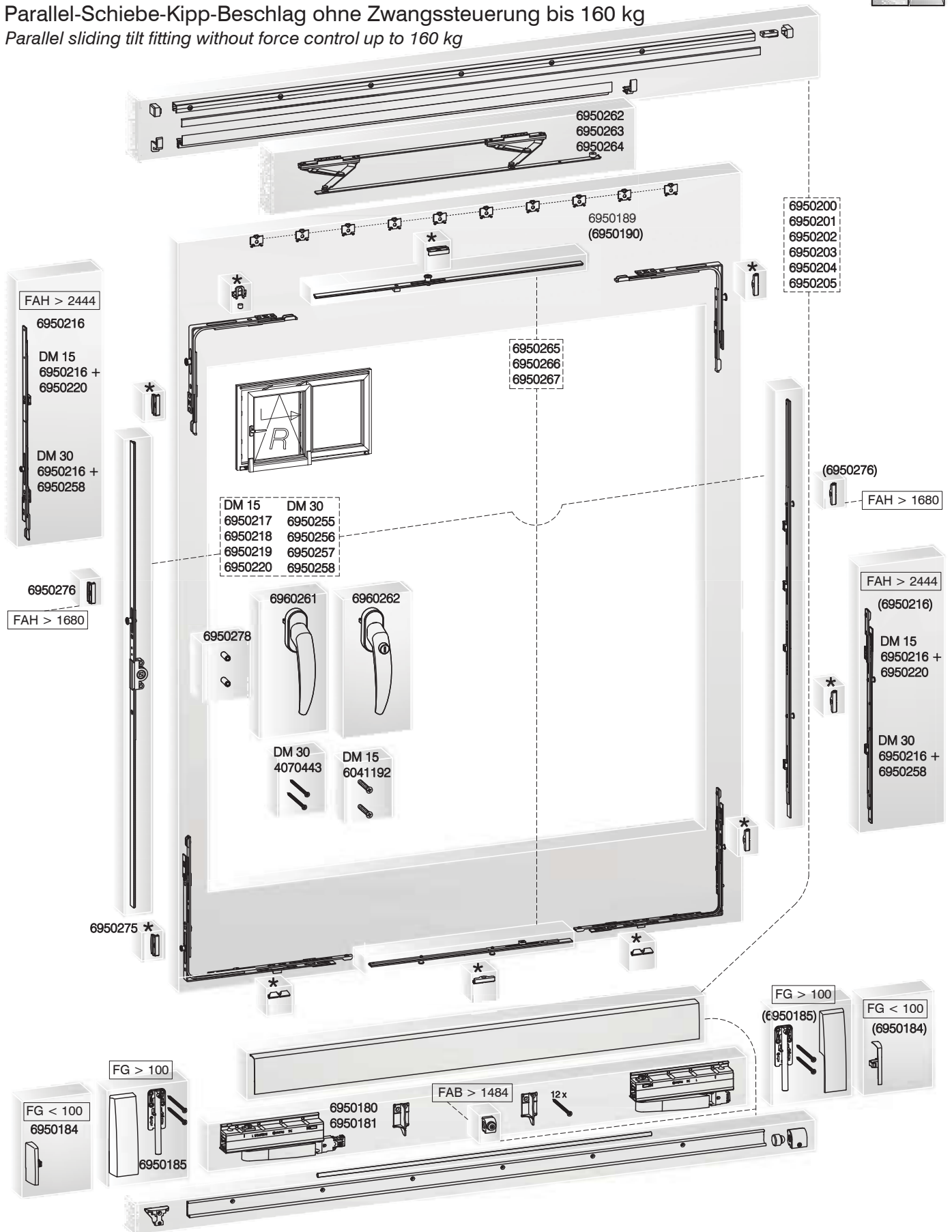

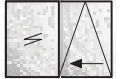

Parallel-Schiebe-Kipp-Beschlag mit Zwangssteuerung bis 200 kg
Parallel sliding tilt fitting with force control up to 200 kg

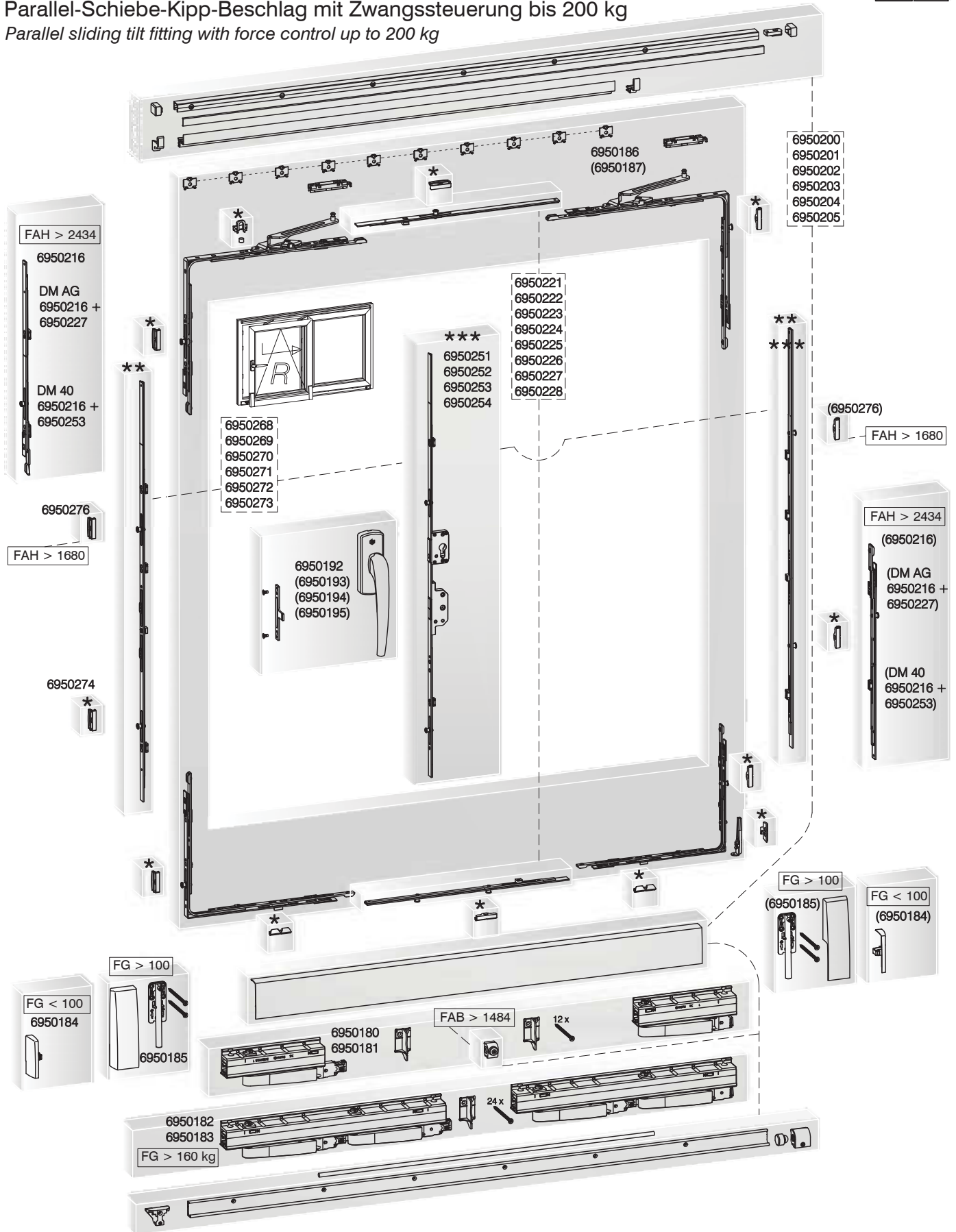

Grundbeschlag Basic fitting

Dreh-Beschlag auswärts Turn fitting outwards

Griff Stellungen
Handle position

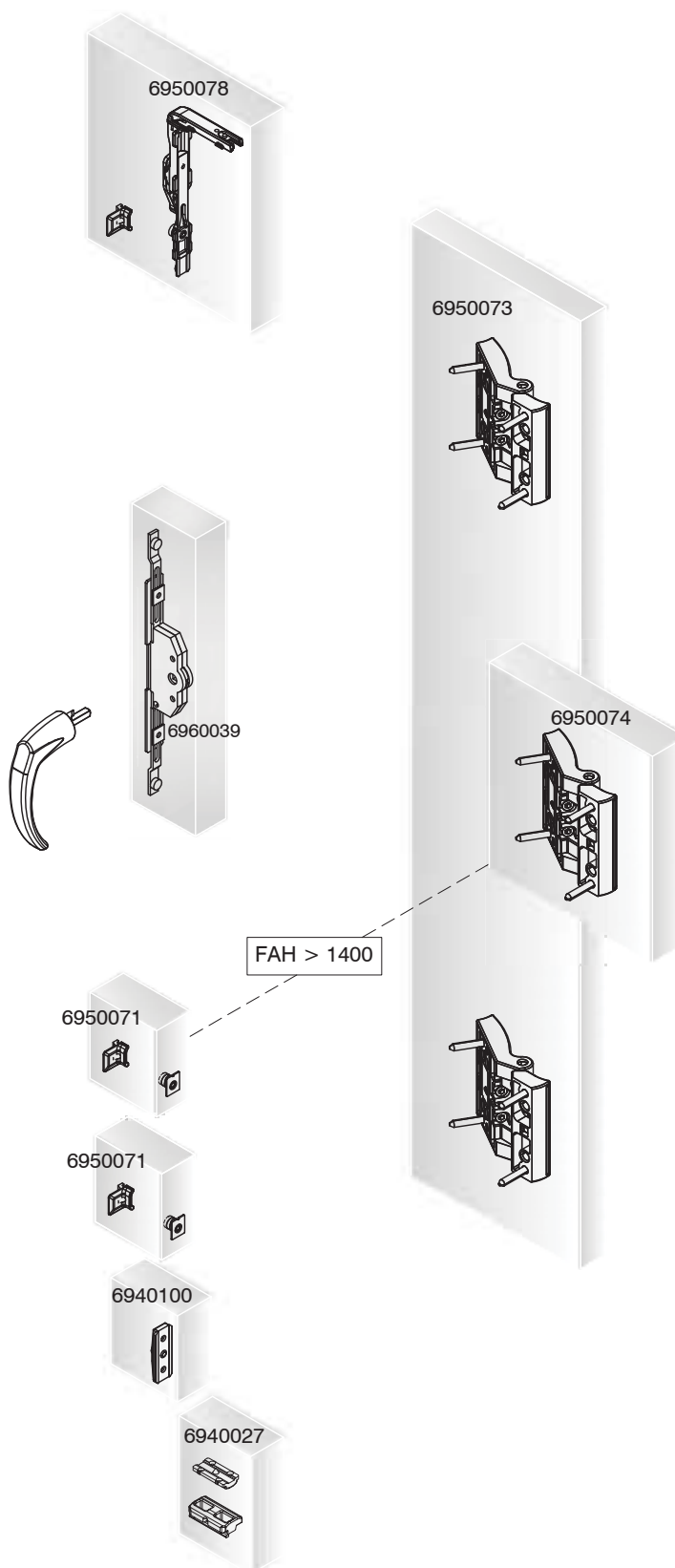
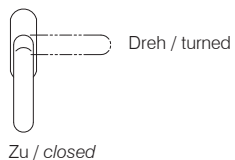

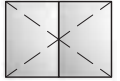

Stulp-Beschlag Dreh auswärts Double casement door turn outwards

Kniehebel Stellungen
Toggle lever position

Griff Stellungen
Handle position

Dreh / turned



Zu / closed

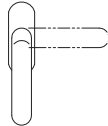

Zu / closed

Dreh / turned

* Schließstück aus Set
6950078 ersetzen
durch 6950083
Replace the locking
piece from set
6950078
by item
6950083

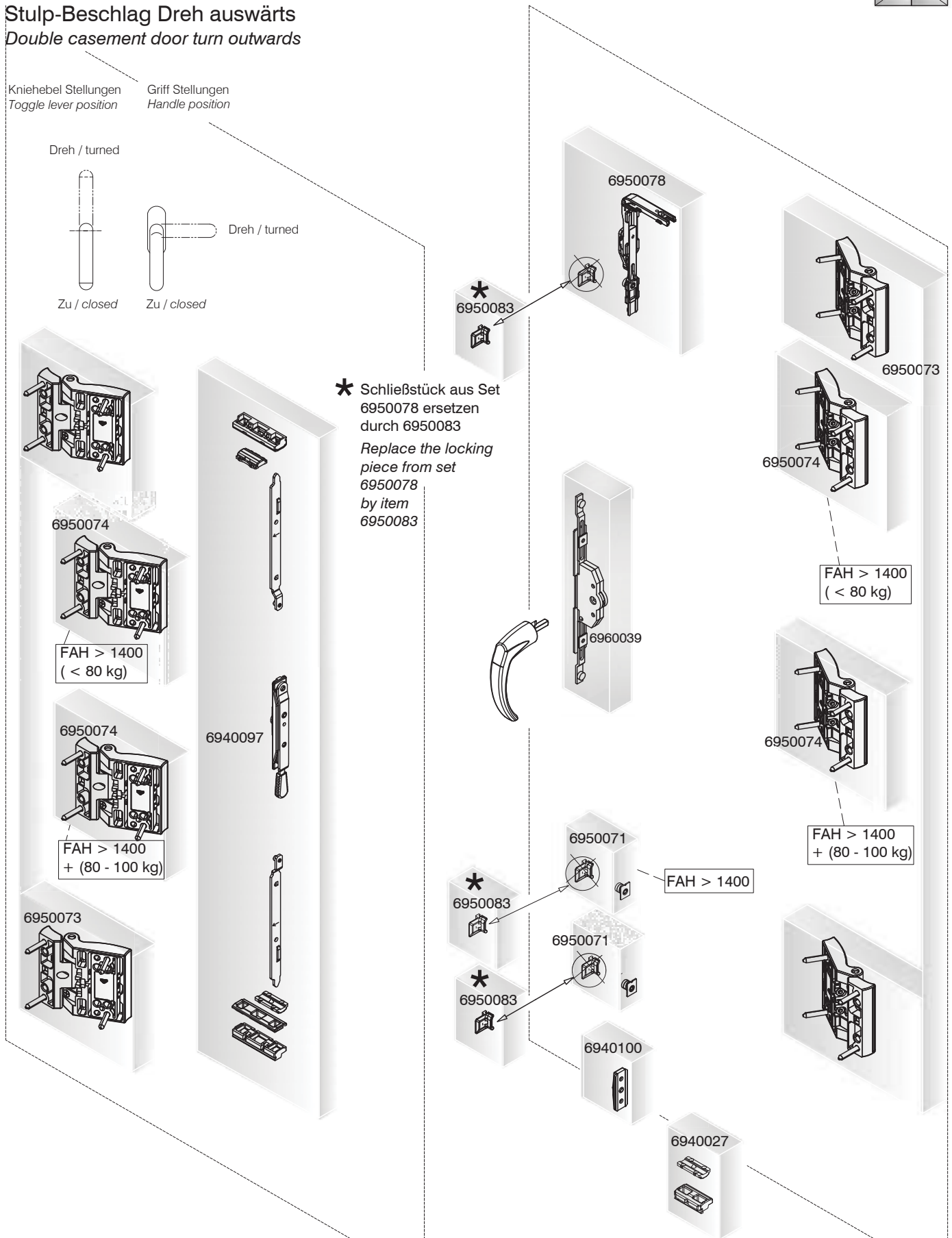



Fenstertür-Beschlag 130 kg DK einwärts 1-flg., barrierefrei
Single casement door fitting 130 kg T/T inwards accessible

Griff Stellungen
Handle position

Kipp / tilted

Dreh / turned

Zu / closed

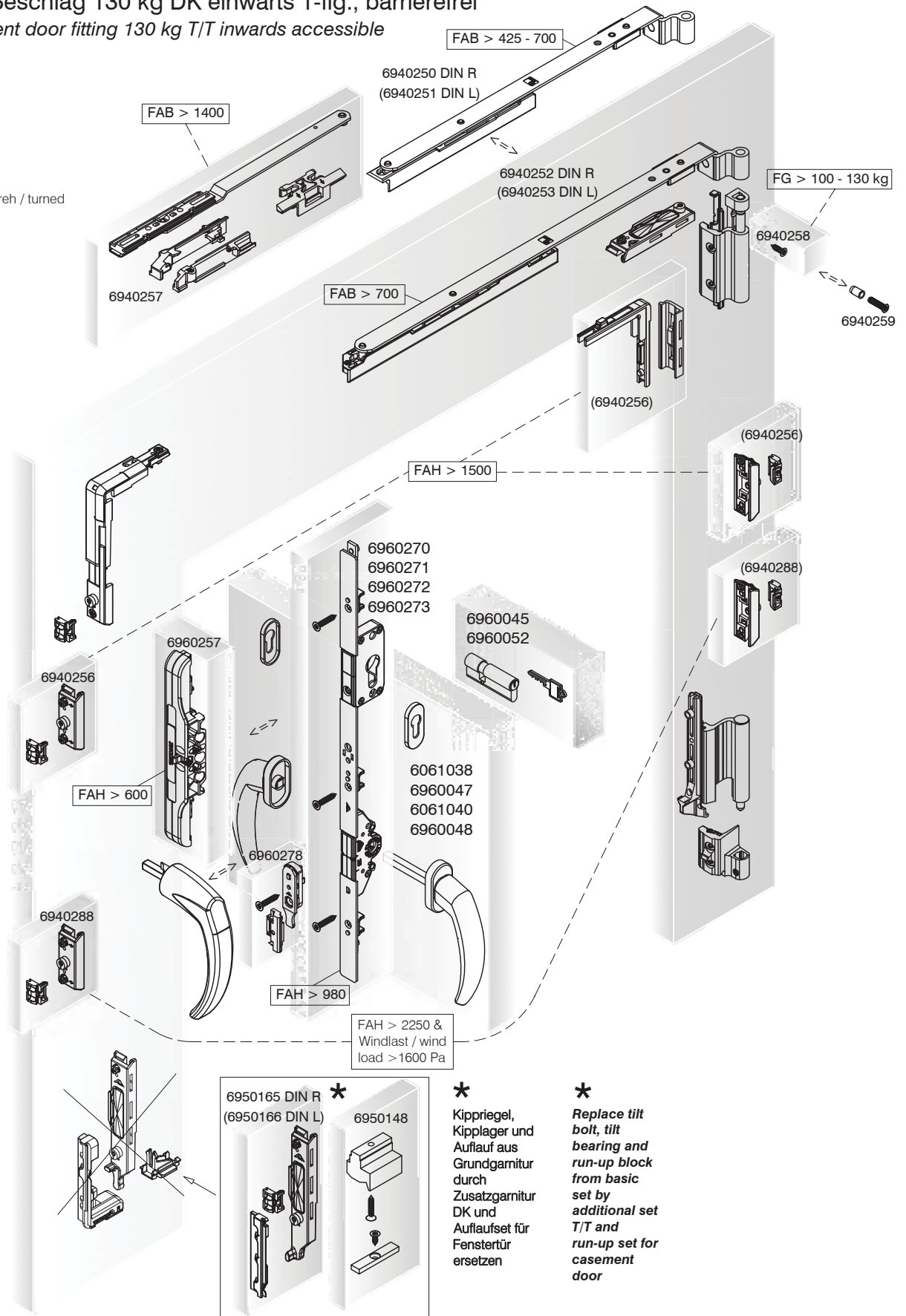



Fenstertür-Beschlag 130 kg TF einwärts 1-flg., barrierefrei
Single casement door fitting 130 kg TF inwards accessible

Griff Stellungen
Handle position

Dreh / turned

Kipp / tilted

Zu / closed

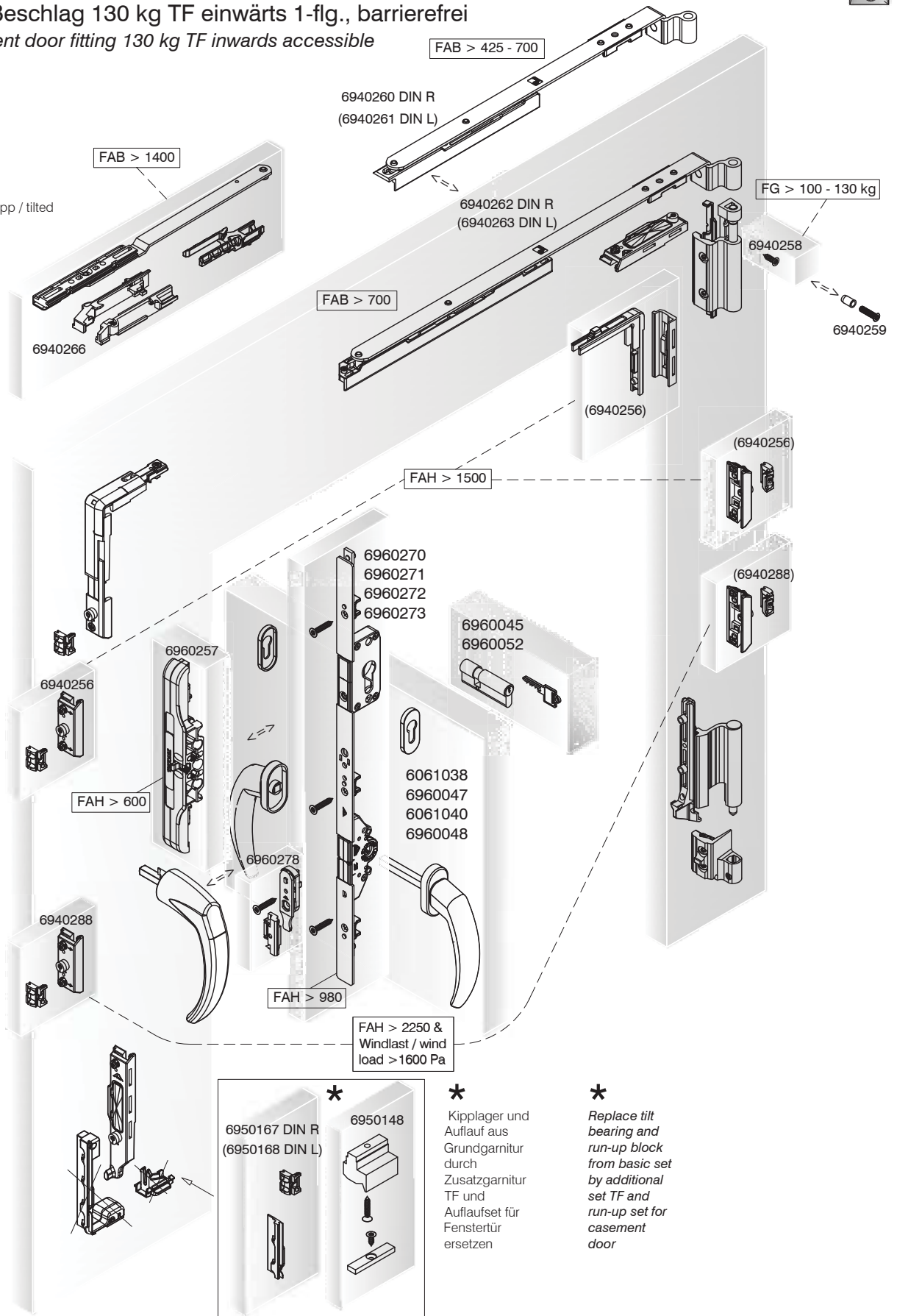



Fenstertür-Beschlag 130 kg Dreh einwärts 1-flg., barrierefrei Single casement door fitting 130 kg turn inwards accessible

Griff Stellungen
Handle position

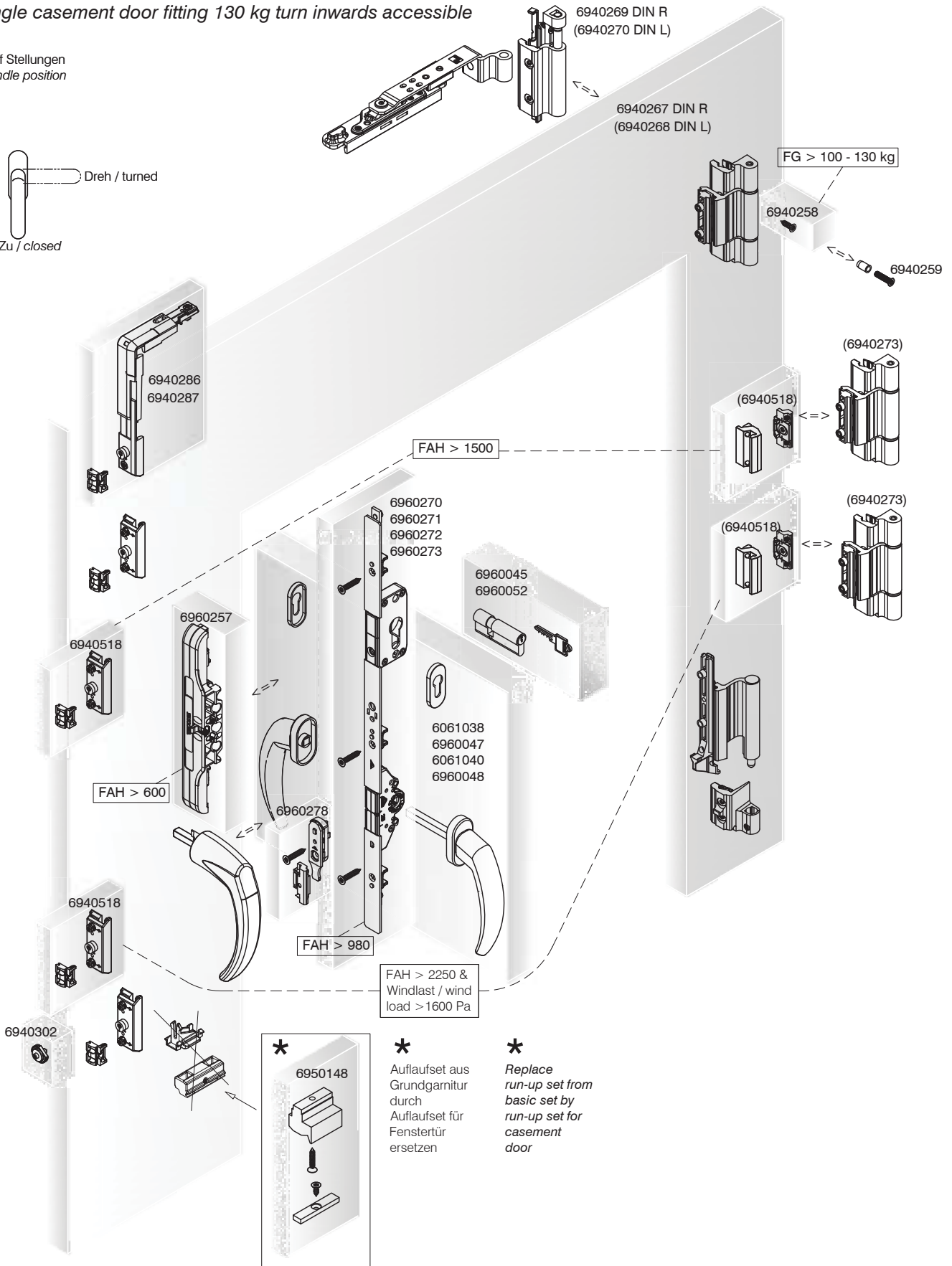
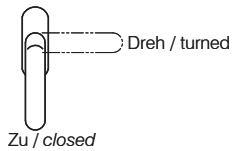

Fenstertür-Beschlag 130 kg DK einwärts 2-flg., beidseitig barrierefrei
Double casement door fitting 130 kg T/T inwards both sided accessible



Standflügel DIN L
Inactive sash DIN L

Kniehebel Stellungen
Toggle lever position

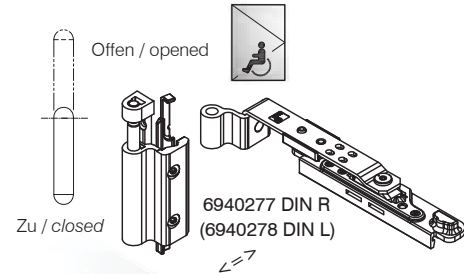

6940277 DIN R
(6940278 DIN L)

Gehflügel DIN R
Active sash DIN R

Griff Stellungen
Handle position

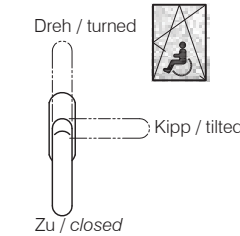

6940257

FAB > 1400

FAB > 425 - 700
6940250 DIN R
(6940251 DIN L)

FG > 100 - 130 kg

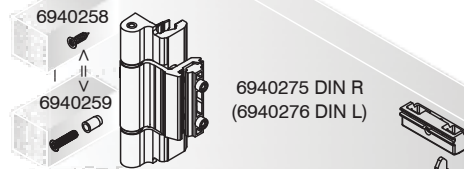

6940275 DIN R
(6940276 DIN L)

FAB x FAH > 2.0 m² &
Windlast / wind load > 800 Pa

FAB > 700

6940252 DIN R
(6940253 DIN L)

FG > 100 - 130 kg

6940258
6940259
(6940288)
(6940256)

6940283
6940517
FAH > 2250 &
Windlast / wind load > 800 Pa

FAH > 2250 &
Windlast / wind load > 800 Pa

FAH > 1600

FAH > 2250 &
Windlast / wind load > 800 Pa

6940283
6940517
FAH > 1600

6040548
* ersetzen
replace

FAH > 600

6960270
6960271
6960272
6960273

6960045
6960052

(6940256)

6061038
6960047
6061040
6960048

FAH > 980

Detail A

6950063 R
(6950064 L)

ersetzen
replace

6950149

ersetzen
replace

**
6950165 DIN R
(6950166 DIN L)

**
Kipriegel,
Kippklager und
Auflauf aus
Grundgarnitur
Zusatzgarnitur
und Auflaufset
für Fenstertür
ersetzen

**
Replace tilt
bolt, tilt
bearing and
run-up block
from basic
set by
additional set
and run-up
set for
casement
door



Fenstertür-Beschlag 130 kg TF einwärts 2-flg., beidseitig barrierefrei
Double casement door fitting 130 kg TF inwards both sided accessible

Standflügel DIN L
Inactive sash DIN L

Kniehebel Stellungen
Toggle lever position

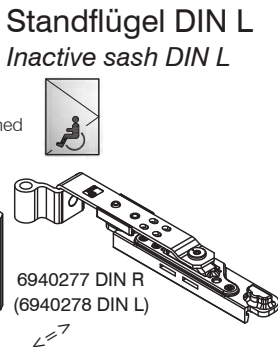
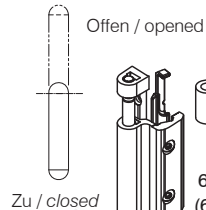

6940277 DIN R
(6940278 DIN L)

Griff Stellungen
Handle position

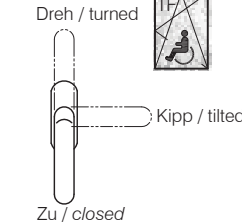

Gehflügel DIN R
Active sash DIN R

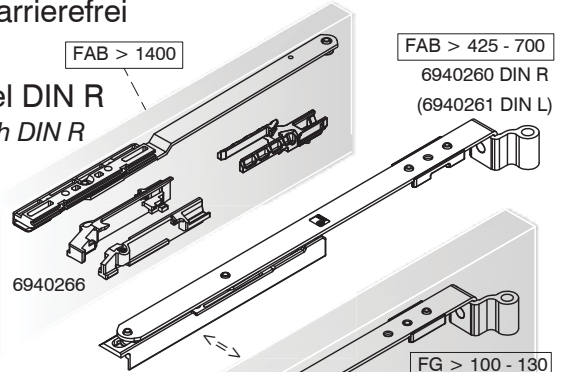

FAB > 1400

FAB > 425 - 700
6940260 DIN R
(6940261 DIN L)

6940266

FG > 100 - 130

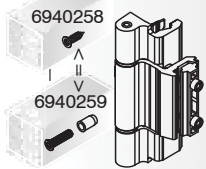

6940275 DIN R
(6940276 DIN L)

FAB x FAH
> 2.0 m² &
Windlast /
wind load
> 800 Pa



FAB > 700

6940262 DIN R
(6940263 DIN L)

FAH > 1600

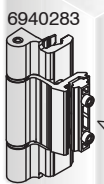

FAH > 2250 &
Windlast / wind
load > 800 Pa



FAH > 2250 &
Windlast / wind
load > 800 Pa

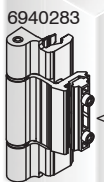
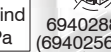

FAH > 1600

6040548
* ersetzen
replace

6040548
* ersetzen
replace

6940256

6940256

6960270
6960271
6960272
6960273

FAH > 2250 &
Windlast / wind
load > 800 Pa

6960045
6960052

(6940256)

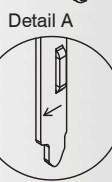
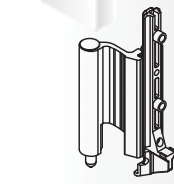

6950063 R
(6950064 L)

ersetzen
replace

FAH > 600

FAH > 980

**
6950167 DIN R
(6950168 DIN L)

**
Kipplager und
Auflauf aus
Grundgarnitur
durch
Zusatzgarnitur
TF und
Auflaufset für
Fenstertür
ersetzen

**
Replace tilt
bearing and
run-up block
from basic set
by additional
set TF and
run-up set for
casement
door



Fenstertür-Beschlag 130 kg Dreh einwärts 2-flg., beidseitig barrierefrei
Double casement door fitting 130 kg turn inwards both sided accessible

Kniehebel Stellungen
Toggle lever position

Griff Stellungen
Handle position

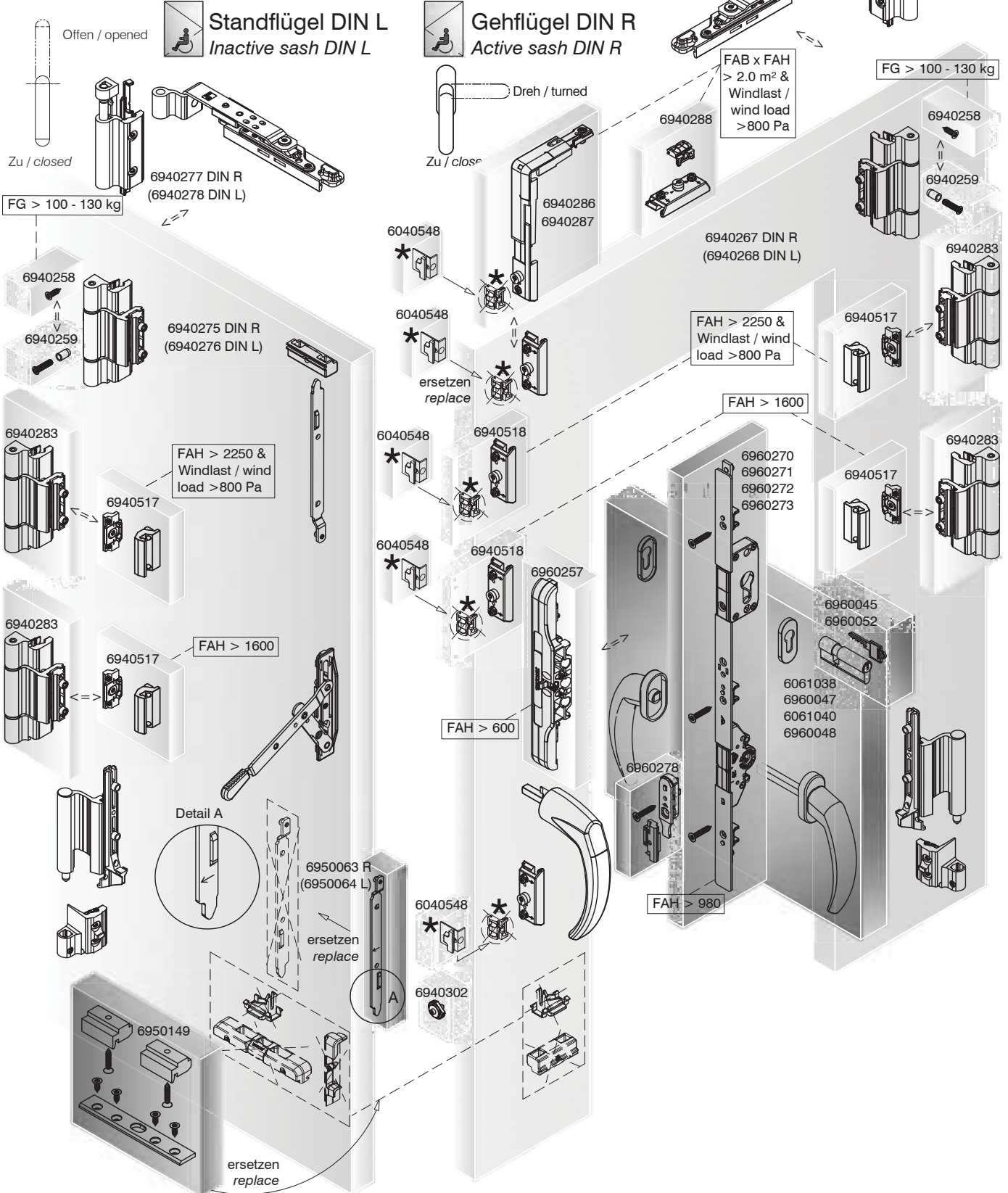

Grundbeschlag
Basic fitting



Fenstertür auswärts 1-flg.
Casement door outwards

Griff Stellungen
Handle position

Typ 1
Type 1

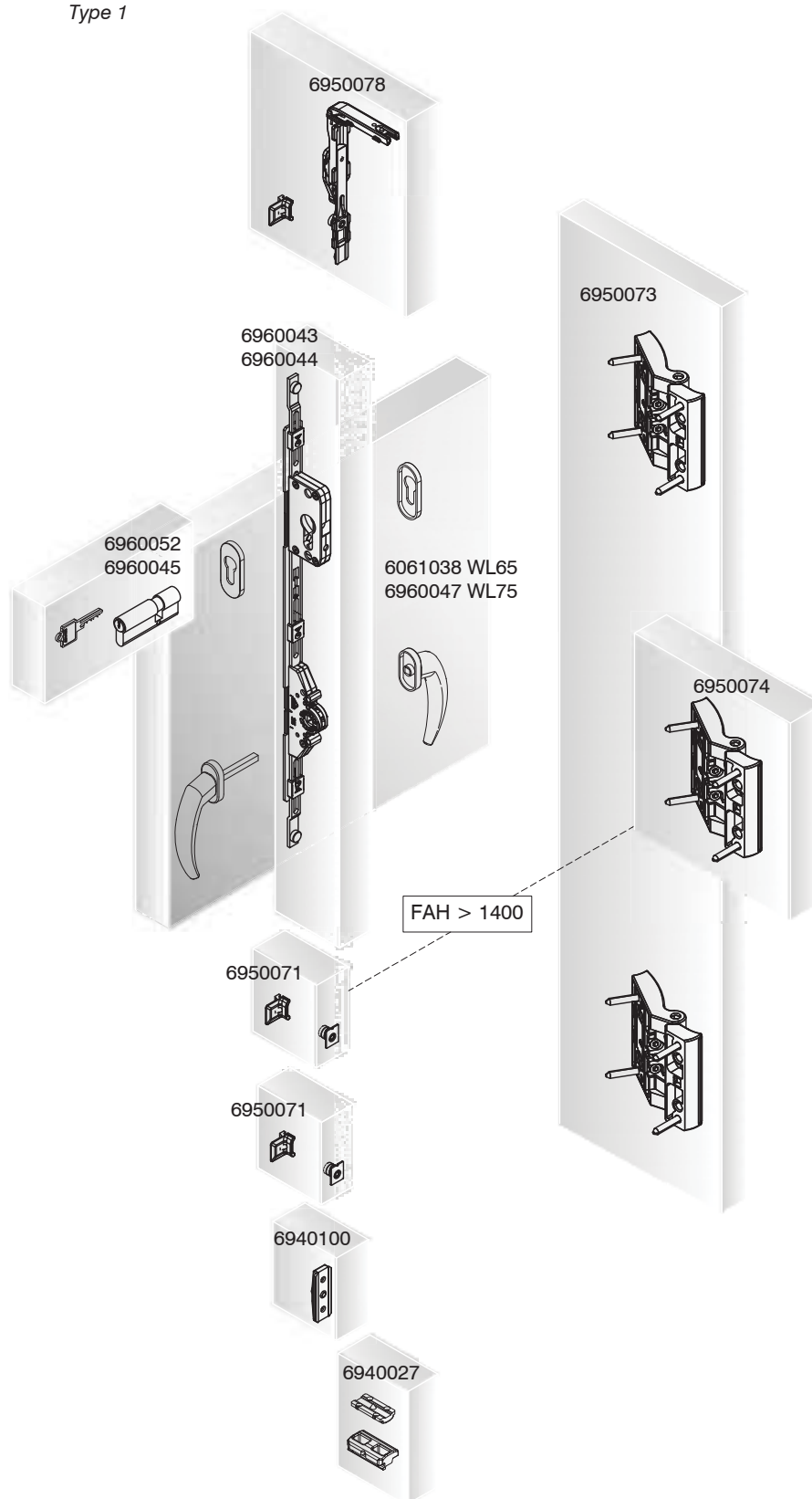
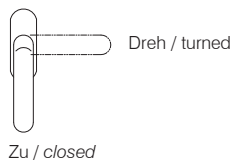



Fenstertür auswärts mit horizontalen Mittelverriegelungen
Casement door outwards with horizontal centre locks

Griff Stellungen
Handle position

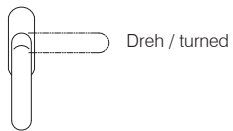

Typ 1
Type 1

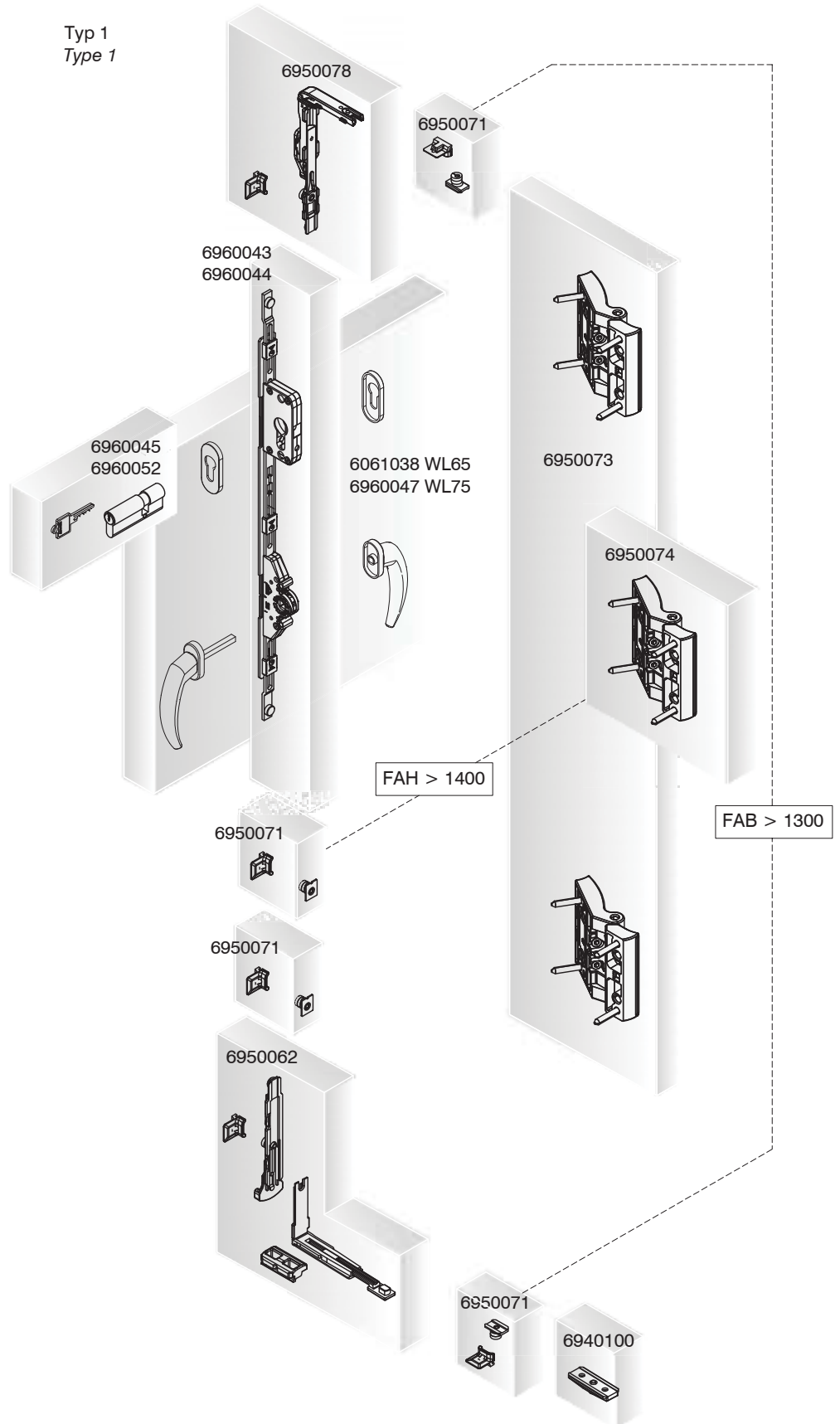

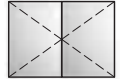

Fenstertür auswärts 2-flg.
Double casement door outwards

Kniehebel Stellungen
Toggle lever position

Griff Stellungen
Handle position

Dreh / turned



Zu / closed

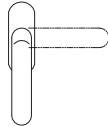

Zu / closed

Dreh / turned

Typ 2
Type 2

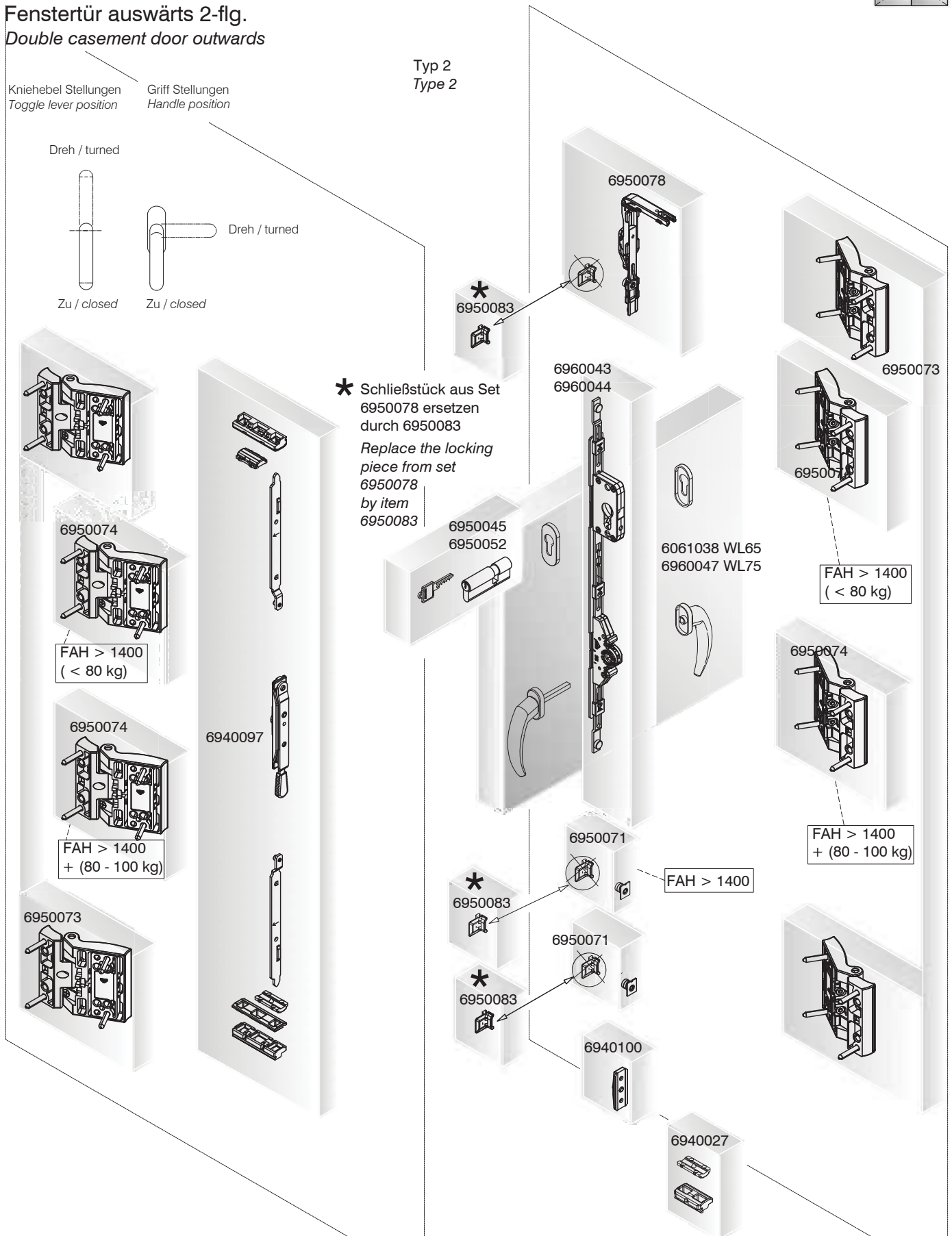

Grundbeschlag
Basic fitting



Fenstertür auswärts 1-flg., barrierefrei
Casement door outwards, both sided accessible

Griff Stellungen
Handle position

Typ 3
Type 3

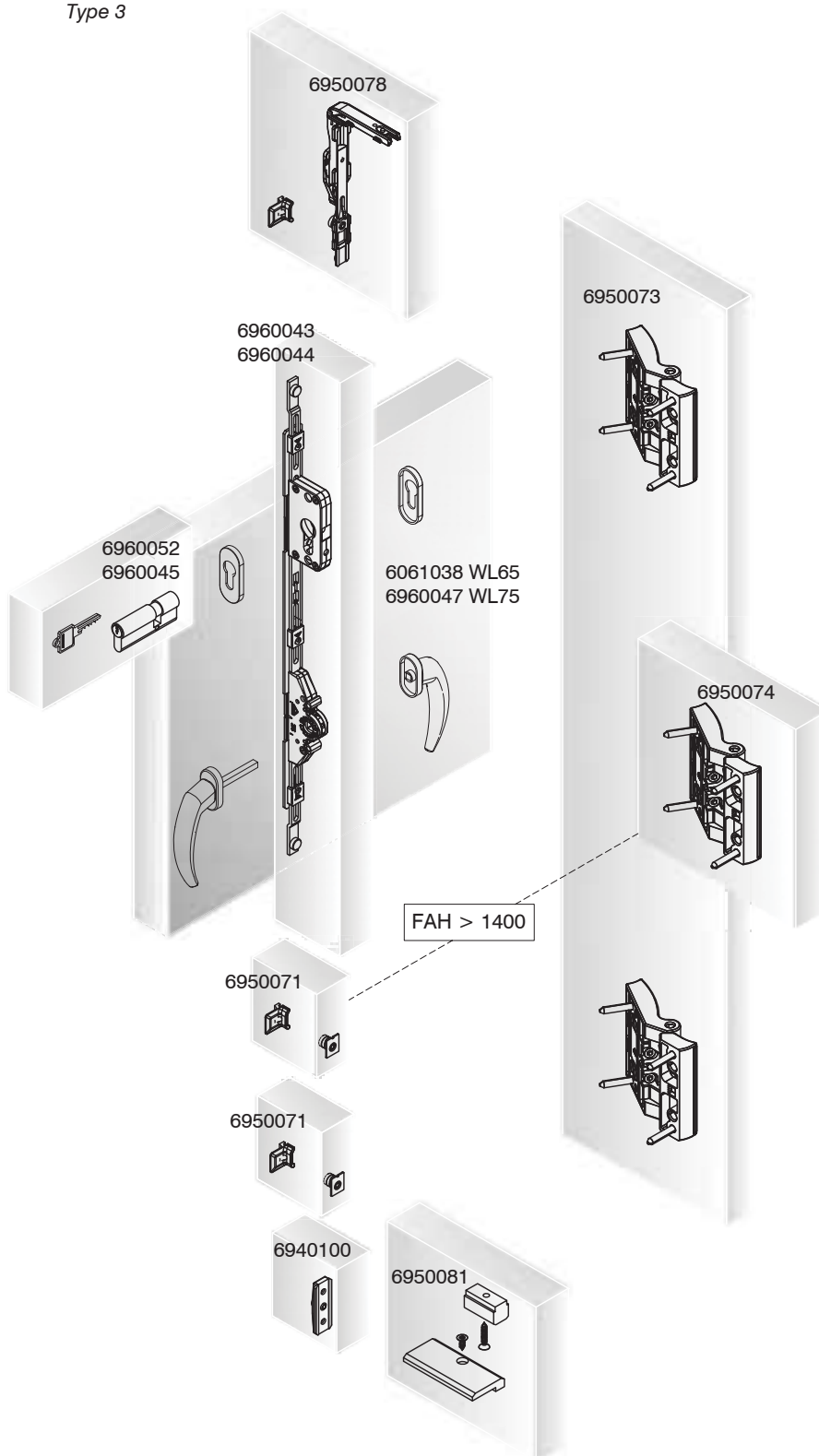
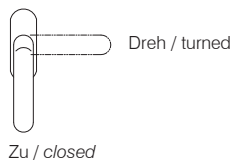



Fenstertür auswärts 2-flg., barrierefrei
Double casement door outwards, both sided accessible

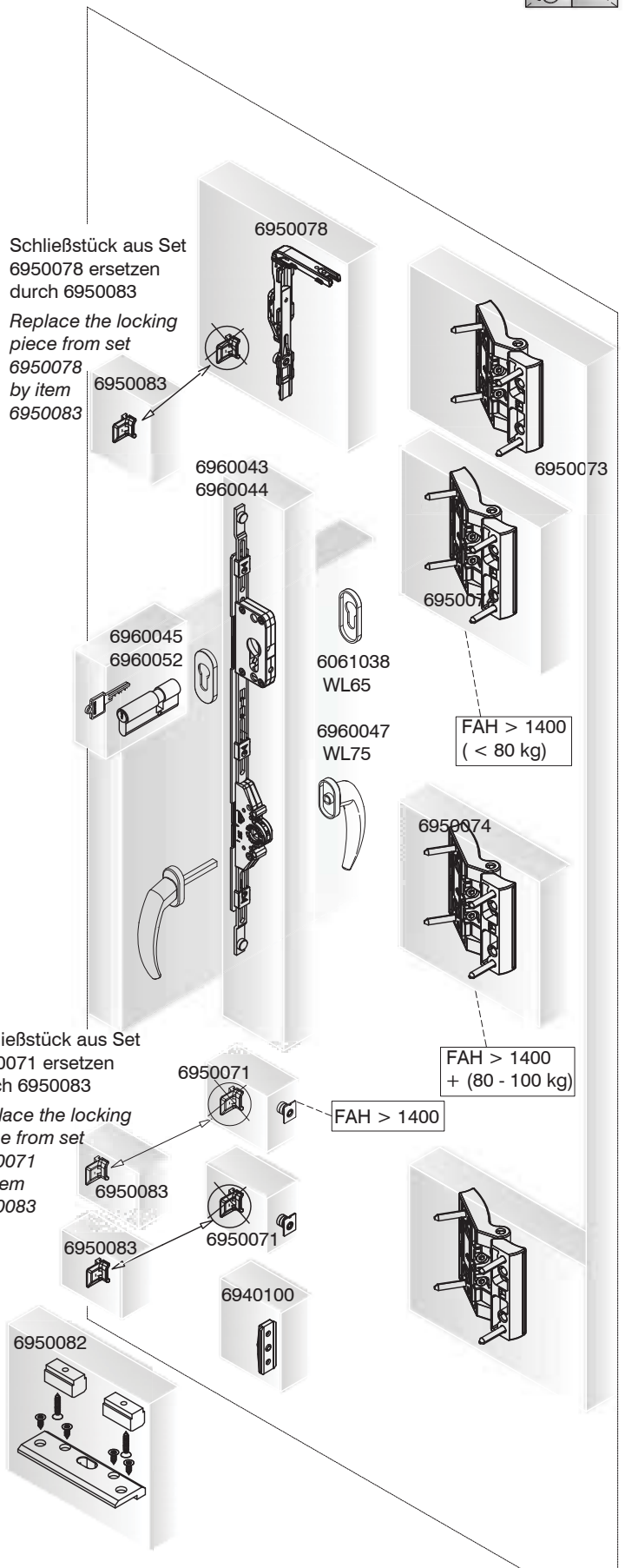
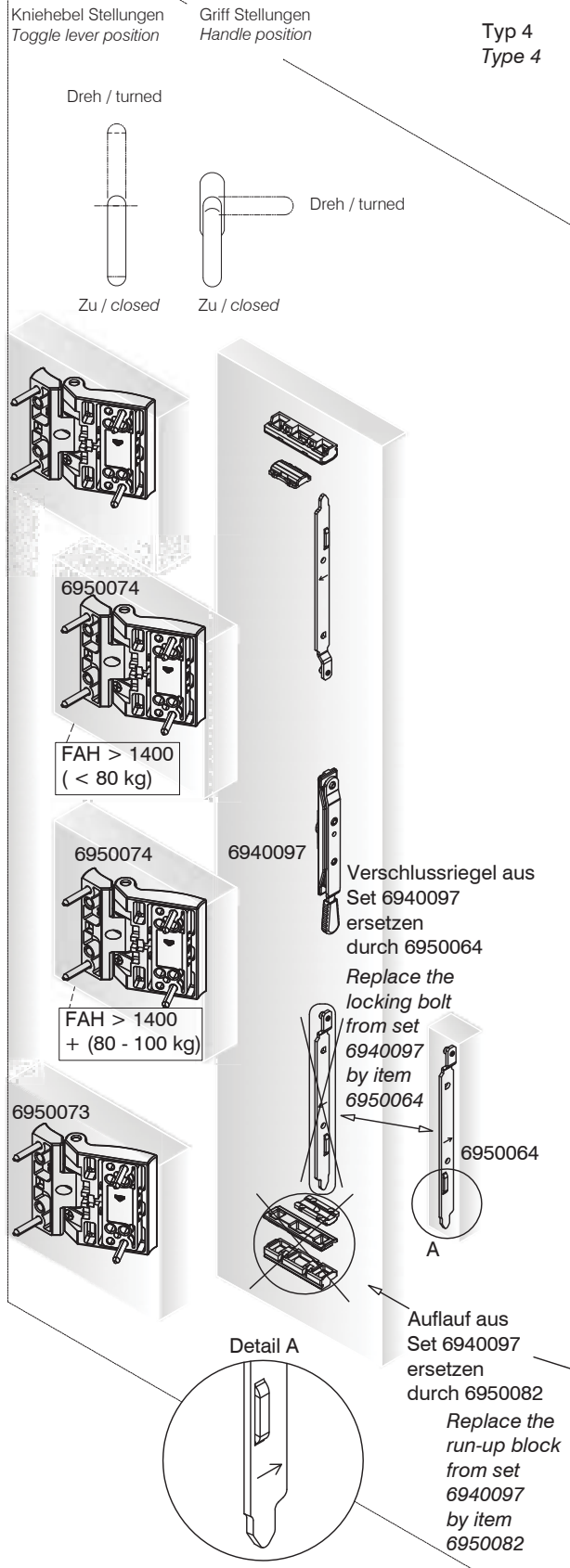

WICLINE

Grundbeschlag
Basic fitting

Beschläge
Fittings

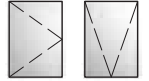

Klapp-Beschlag
Top hung fitting

Griff Stellungen
Handle position

Klapp / tilted

Zu / closed

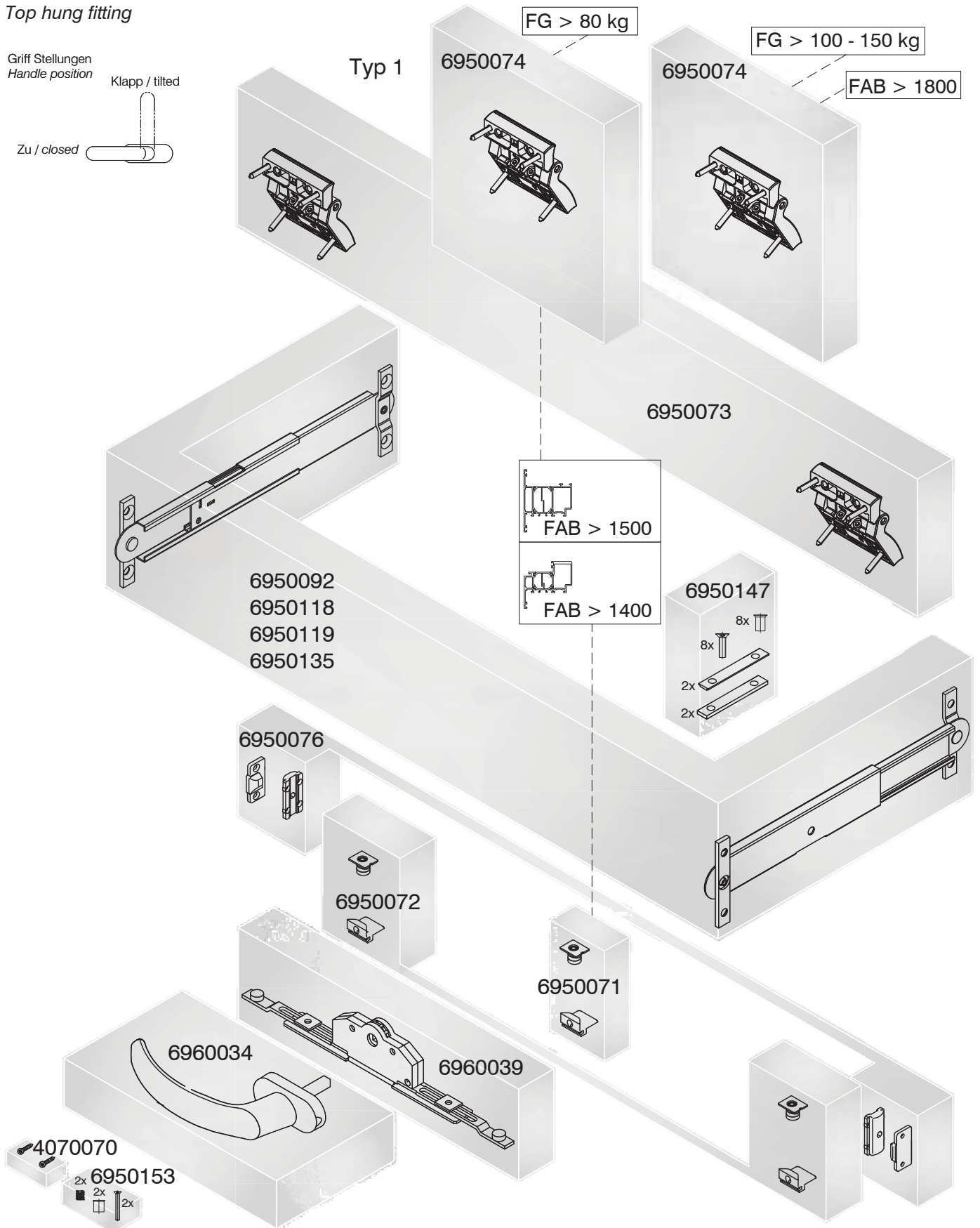
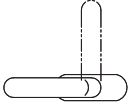

Grundbeschlag
Basic fitting

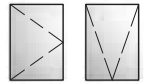

Klapp-, Dreh-Beschlag mit vertikalen Mittelverriegelungen

Top hung, Turn fitting with vertical centre locks

Griff Stellungen
Handle position

Klapp / tilted

Zu / closed

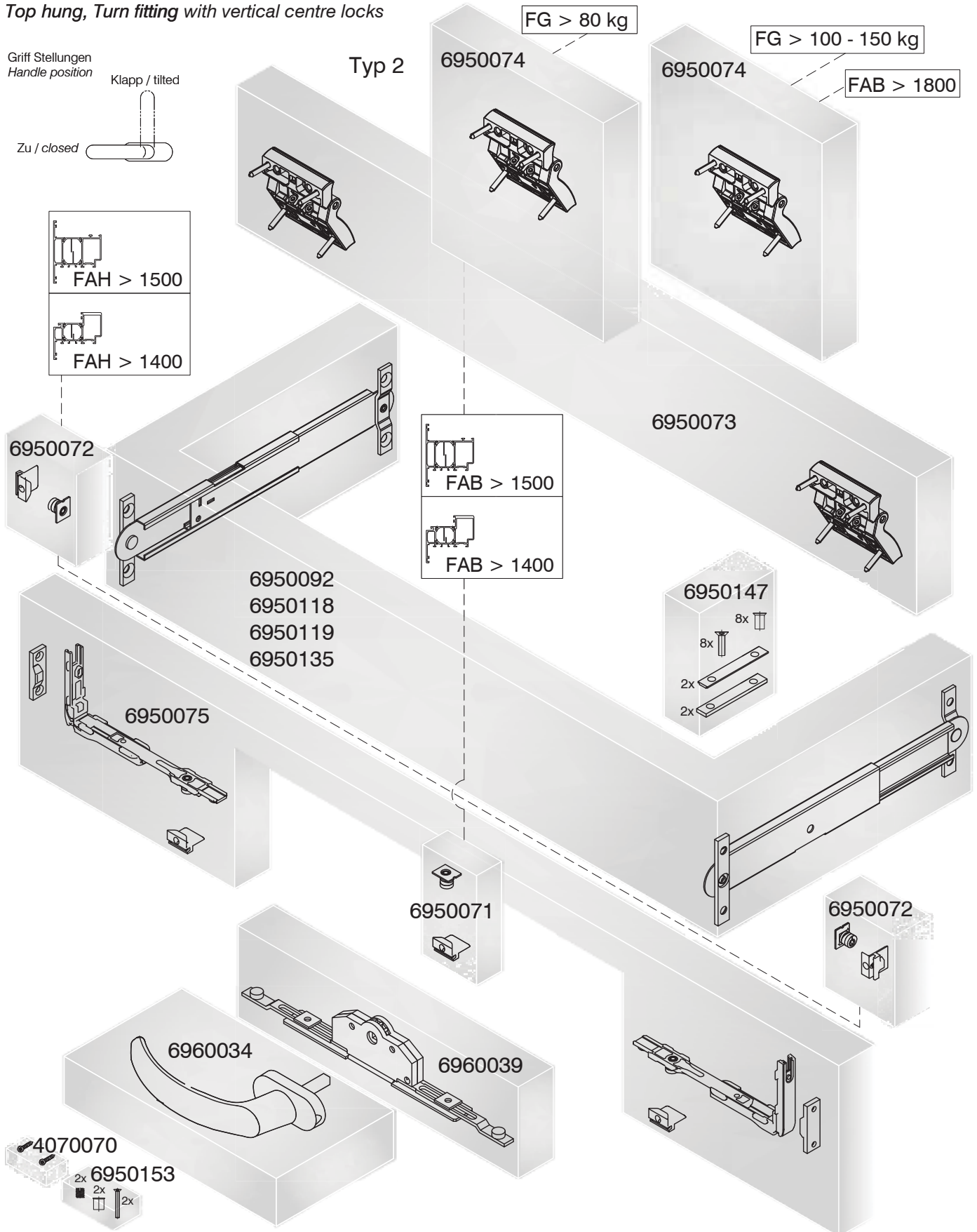
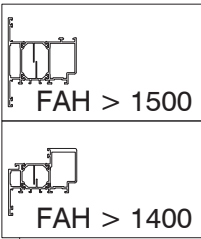
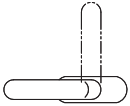

Grundbeschlag
Basic fitting



Senk-Klapp-Beschlag
Italian Style fitting

Griff Stellungen
Handle position

Klapp / tilted

Zu / closed

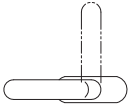

(A)

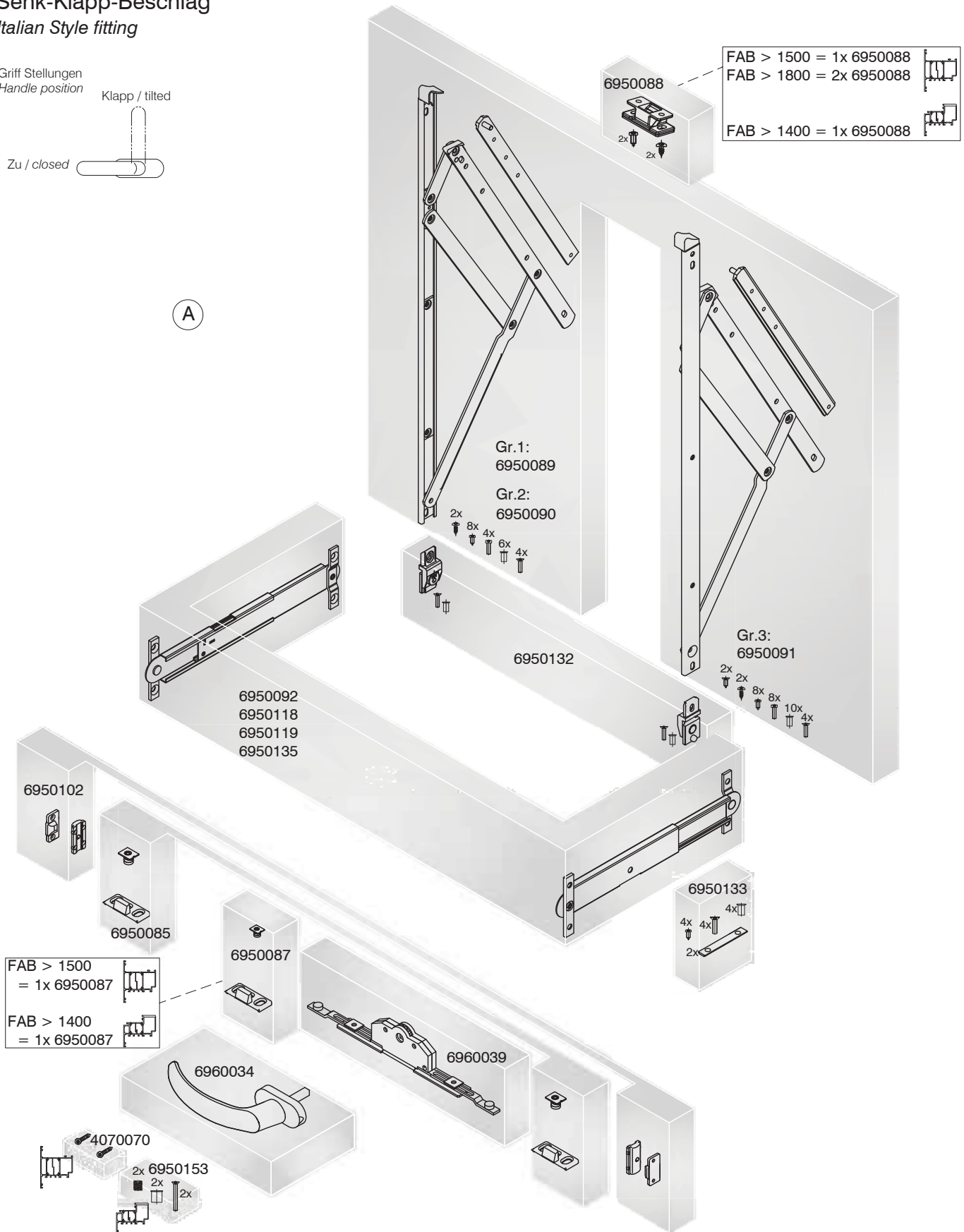

Grundbeschlag
Basic fitting



Senk-Klapp-Beschlag mit vertikalen Mittelverriegelungen Italian Style fitting with vertical centre locks

Griff Stellungen
Handle position

Klapp / tilted

Zu / closed

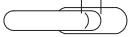

(B)

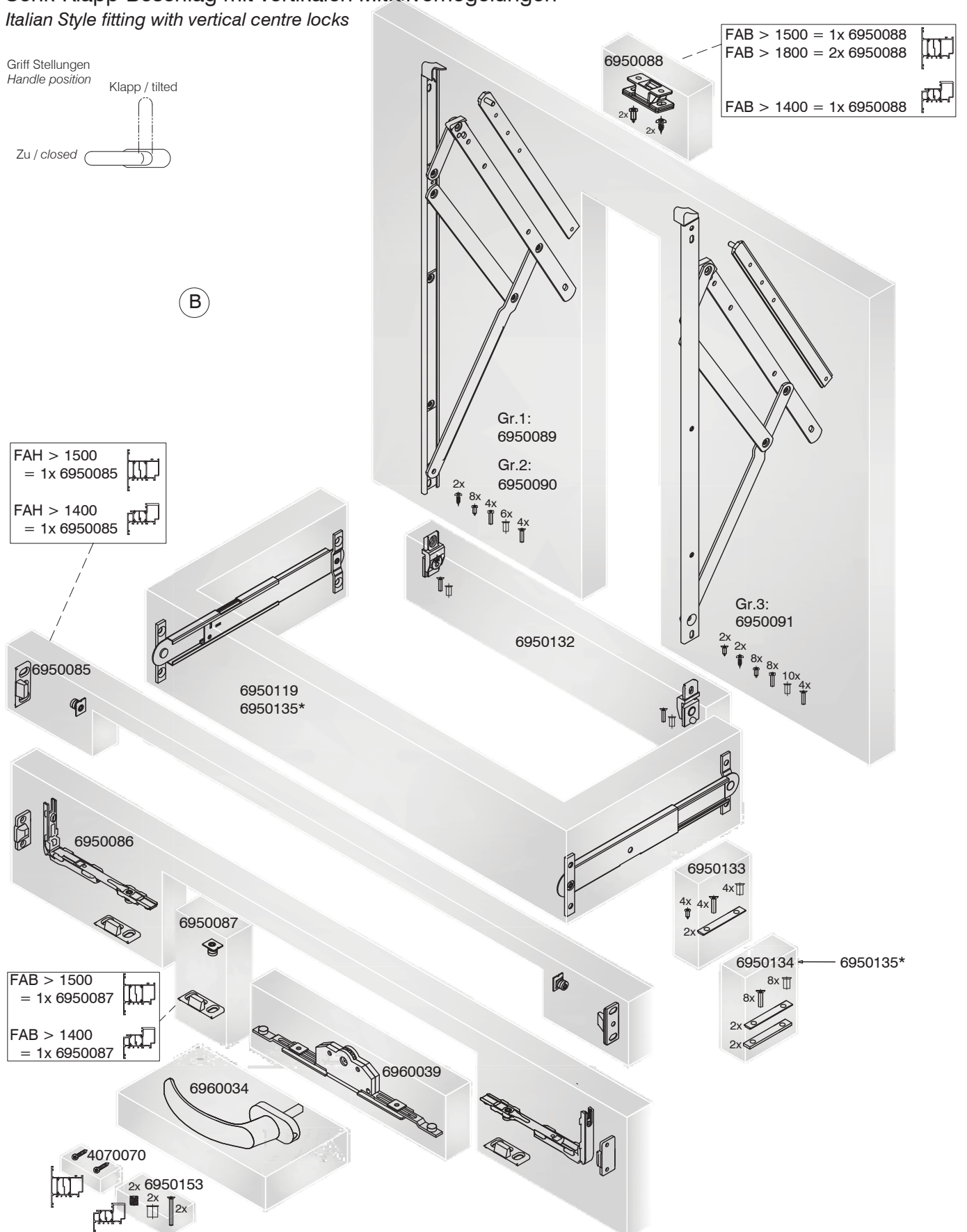

Grundbeschlag
Basic fitting



Schwing-Beschlag, verdecktes Lager
Pivot horizontal fitting, concealed fitting

Griff Stellungen
Handle position

Klapp / tilted

Zu / closed

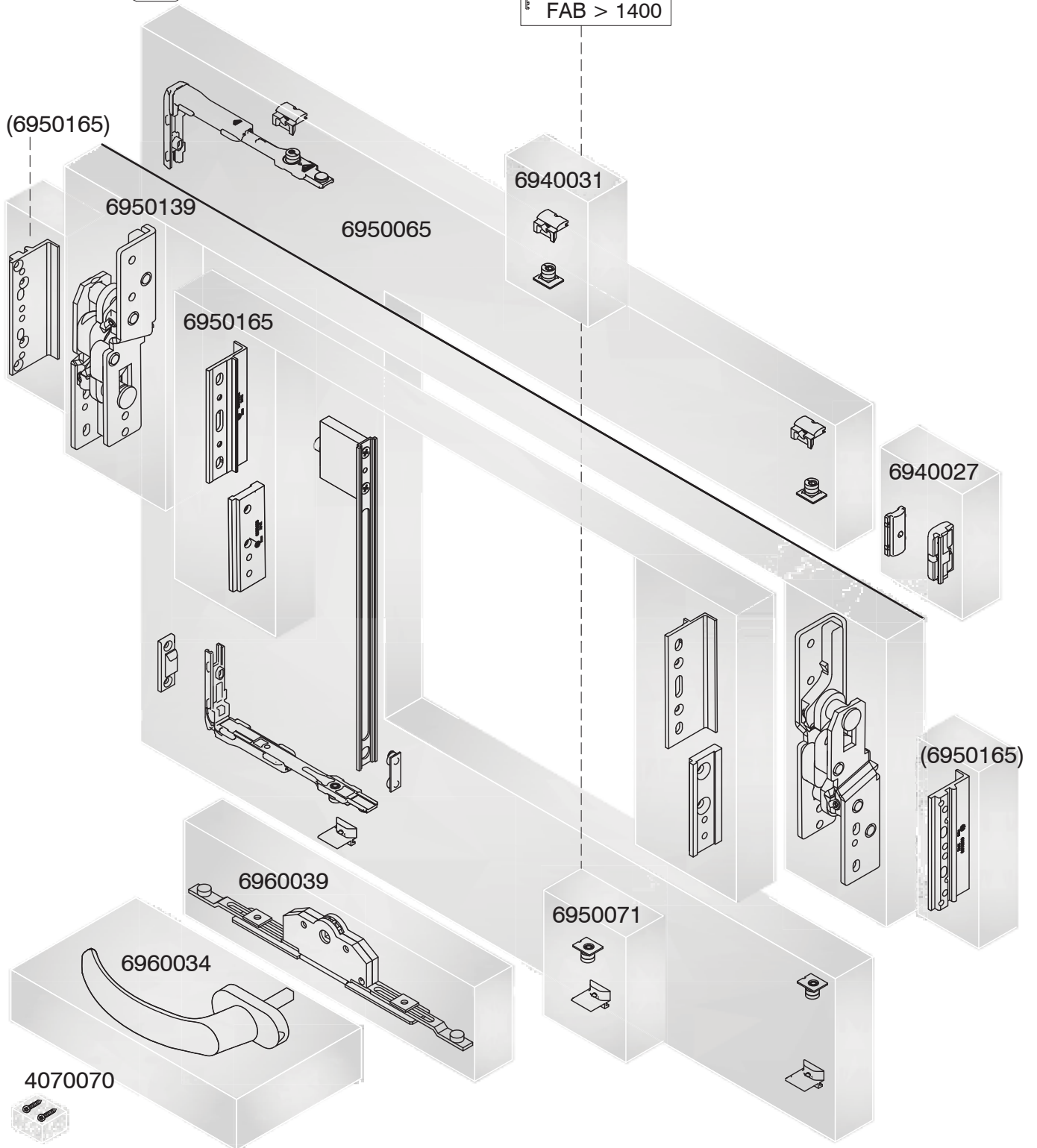
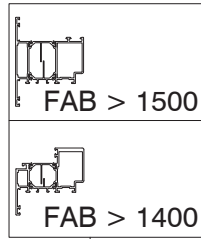

Grundbeschlag
Basic fitting

Schwing-Beschlag
Pivot horizontal fitting



Griff Stellungen
Handle position

Klapp / tilted

Zu / closed

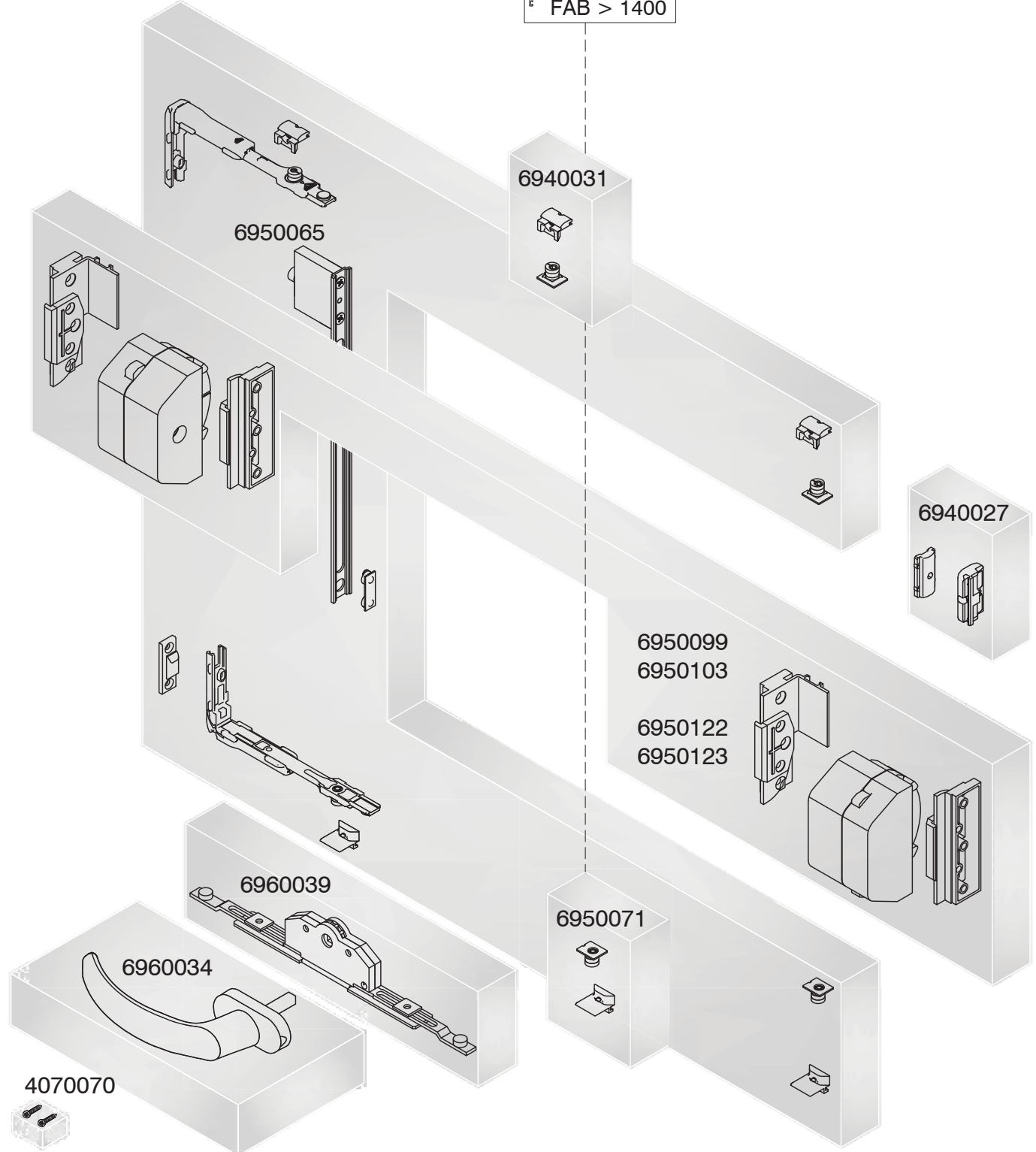
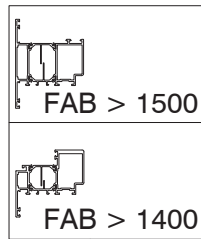
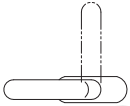

Grundbeschlag
Basic fitting



Wende-Beschlag
Pivot vertical fitting

Griff Stellungen
Handle position

Zu / closed

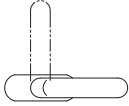

Dreh / turned

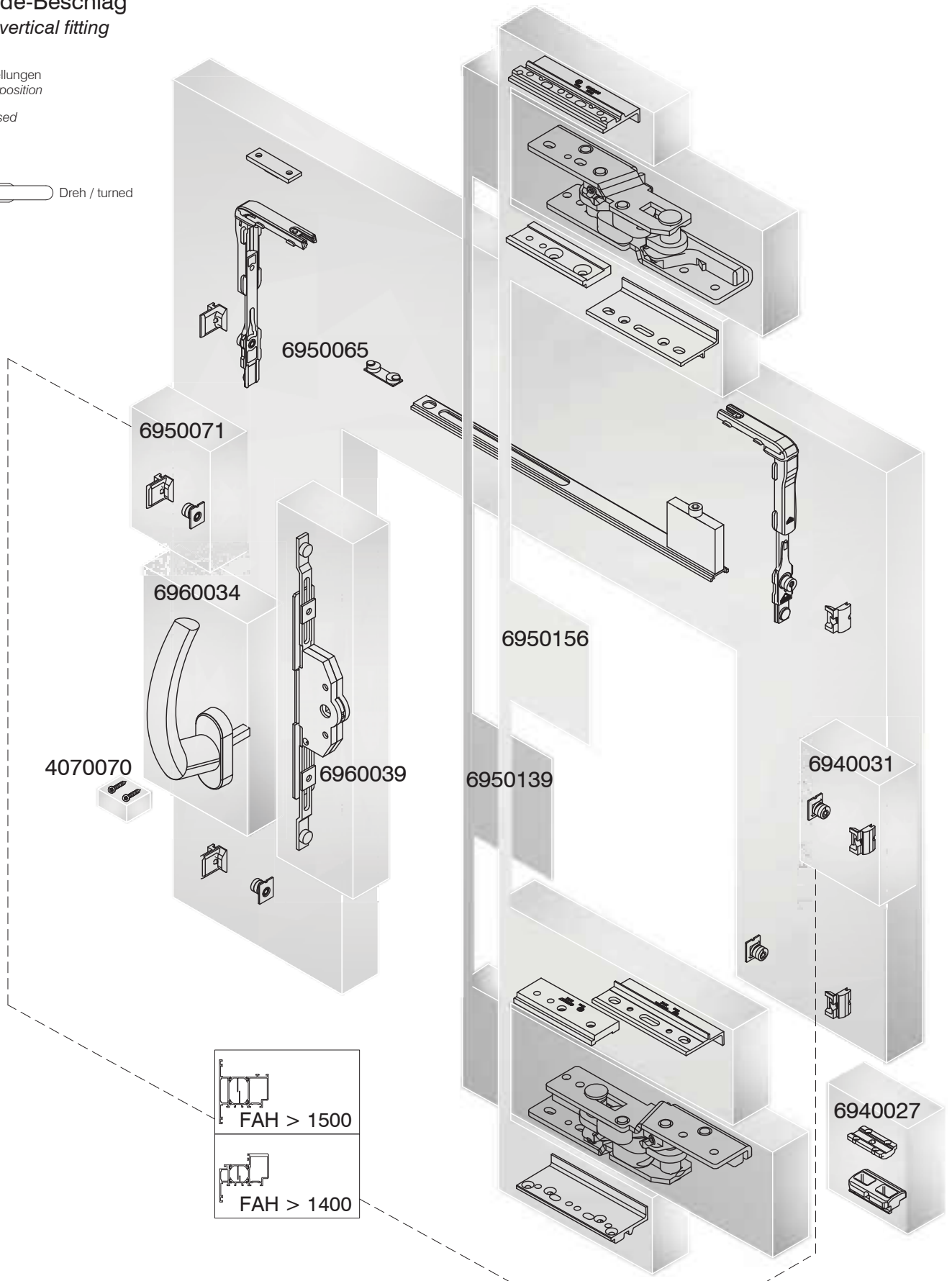

Grundbeschlag
Basic fitting

Wende-Beschlag
Pivot vertical fitting

Griff Stellungen
Handle position

Zu / closed

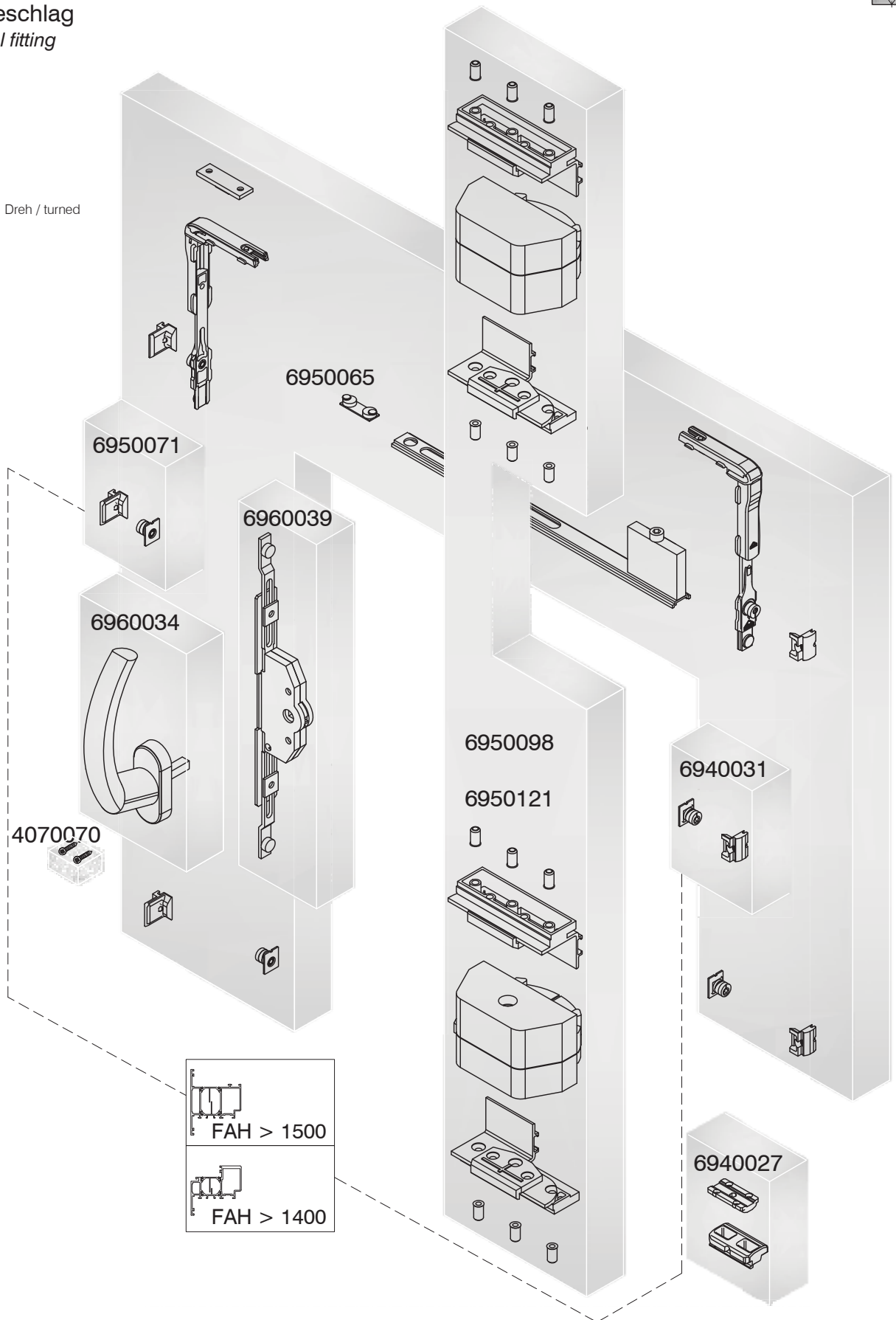

	Seite <i>Page</i>
Glasleistenprofile <i>Glazing bead profiles</i>	4/3
Zusatzprofile <i>Additional profiles</i>	4/9
Eckwinkelprofile <i>Corner angle profiles</i>	4/29

	 m	 mm	 mm
--	---	--	--

3991001	6,5	89	22
3991002	6,5	100	22
3991003	6,5	90	28
3991004	6,5	92	31
3991005	6,5	95	34
3991006	6,5	110	38
3991007	6,5	116	41
3991008	6,5	120	43
3991009	6,5	124	45
3991010	6,5	130	48
3991011	6,5	136	51



3991001



3991002



3991003

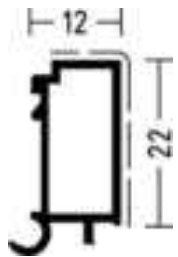

3991004



3991005



3991006

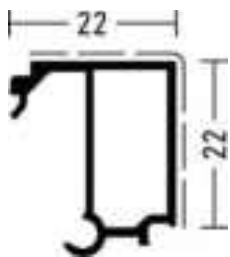

3991007

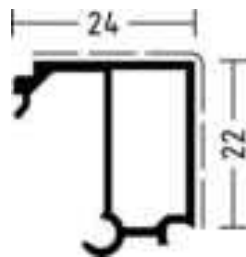

3991008

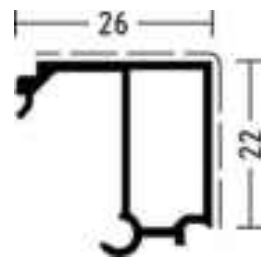

3991009

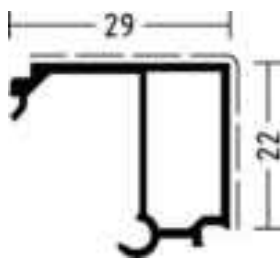

3991010

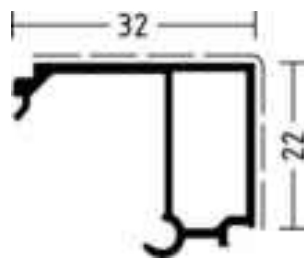

3991011

	 m	 mm	 mm
--	---	--	--

3991012	6,5	140	53
3991013	6,5	146	56
3991014	6,5	154	60
3991015	6,5	162	64
3991016	6,5	170	68
3991017	6,5	176	71
3011029	6	71	22

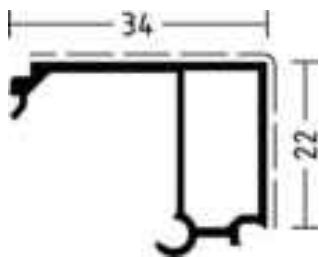

3991012

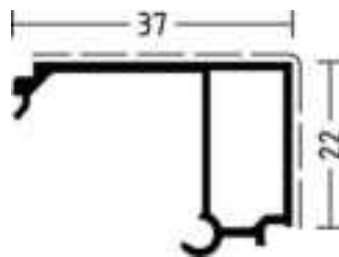

3991013

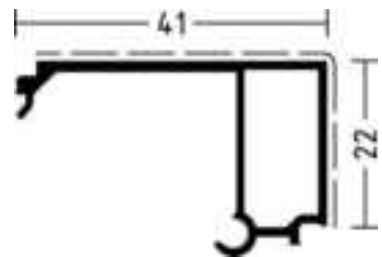

3991014

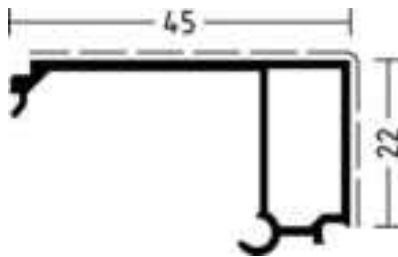

3991015

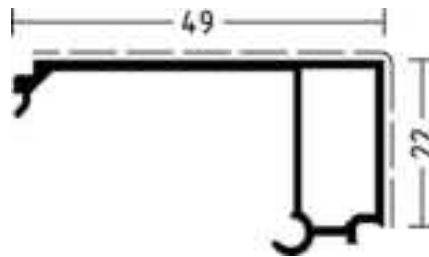

3991016

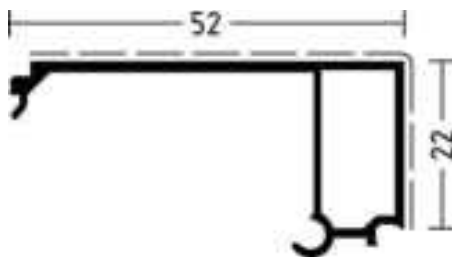

3991017



3011029

Glasleiste, Senk-Klappfenster
Glazing bead for lowering and projecting top-hung sash

 m mm mm

	m	mm	mm
3090258	6,5	91	22
3090259	6,5	103	25
3090262	6,5	122	40
3090263	6,5	128	43
3991022	6,5	92	18
3991023	6,5	82	24
3991024	6,5	84	27
3991025	6,5	87	30
3991026	6,5	102	34
3991027	6,5	108	37
3991028	6,5	112	39

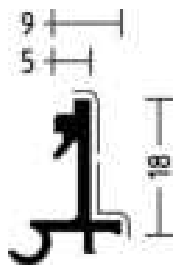

3090258

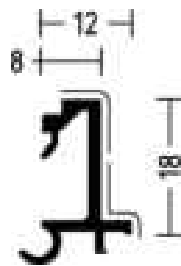

3090259

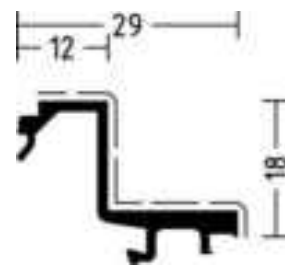

3090262

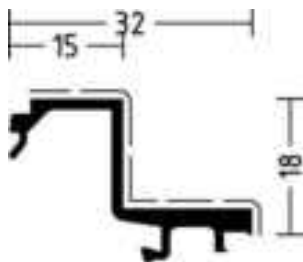

3090263



3991022



3991023

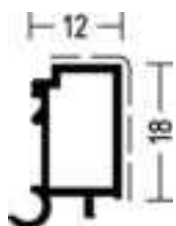

3991024



3991025

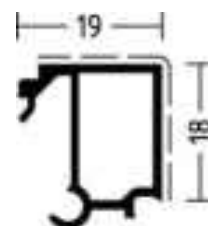

3991026

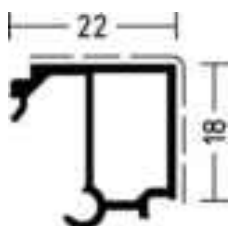

3991027

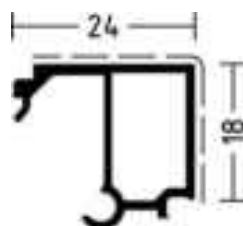

3991028



	m	mm	mm
3991029	6,5	116	41
3991030	6,5	122	44
3991031	6,5	128	47
3991032	6,5	132	49
3991033	6,5	138	52
3991034	6,5	146	56
3991035	6,5	154	60
3991036	6,5	162	64
3991037	6,5	168	67

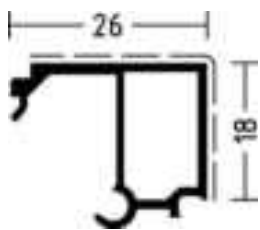

3991029

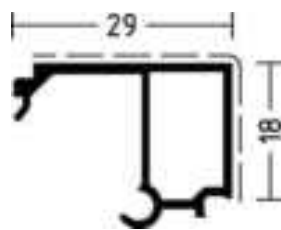

3991030

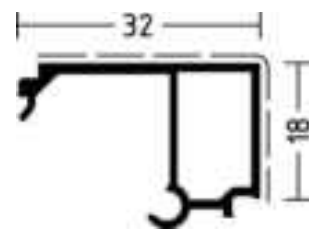

3991031

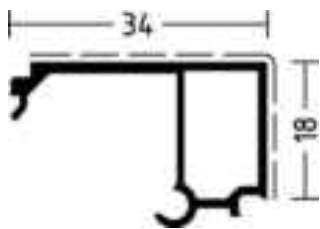

3991032

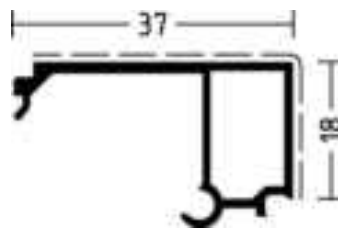

3991033

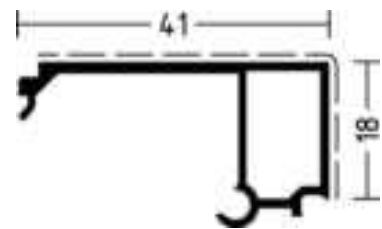

3991034

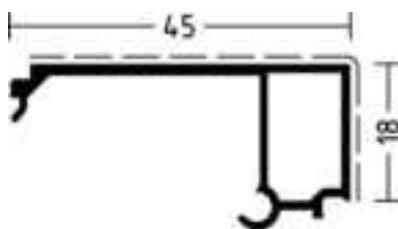

3991035

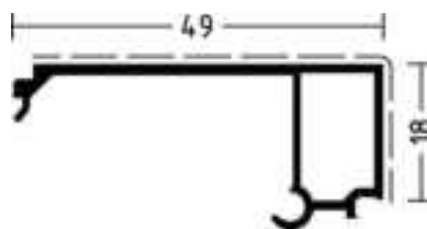

3991036

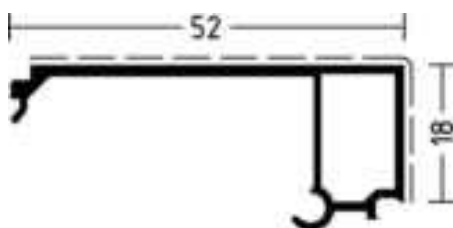

3991037

	 m	 mm	 mm
--	---	--	--

3991263	6,5	89	22
3991264	6,5	116	27
3991265	6,5	90	31
3991266	6,5	92	34
3991267	6,5	92	37
3991268	6,5	124	41
3991269	6,5	130	44
3991270	6,5	134	46
3991271	6,5	138	48
3991272	6,5	144	51
3991273	6,5	150	54



3991263



3991264



3991265

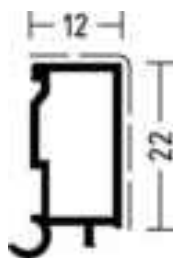

3991266



3991267



3991268

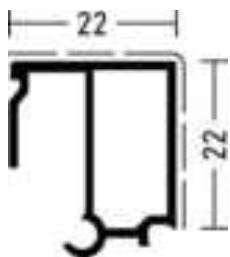

3991269

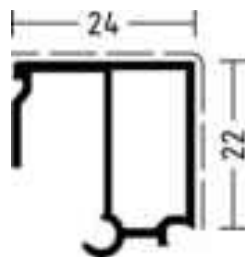

3991270

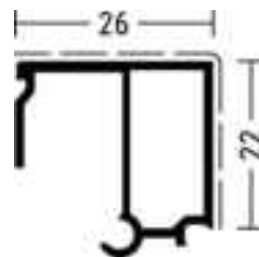

3991271

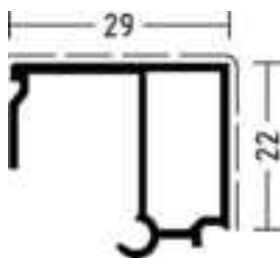

3991272

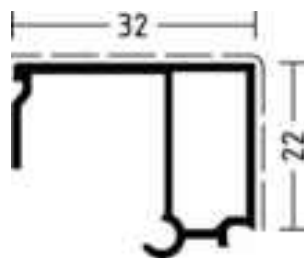

3991273

WICLINE 75

Glisleistenprofile
Glazing bead profiles



	m	mm	mm
3991274	6,5	154	56
3991275	6,5	160	59
3991276	6,5	164	63
3991277	6,5	172	67
3991278	6,5	180	71
3991279	6,5	186	74

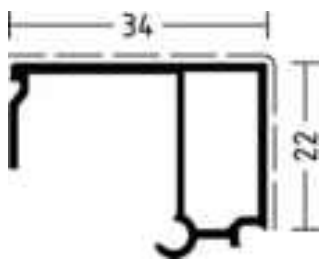

3991274

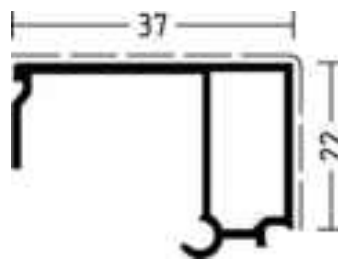

3991275

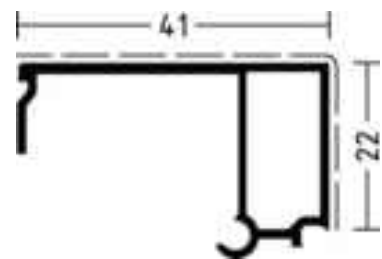

3991276

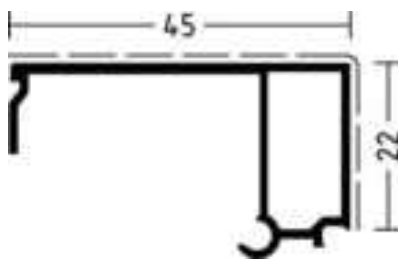

3991277

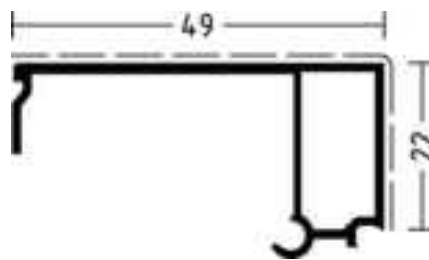

3991278

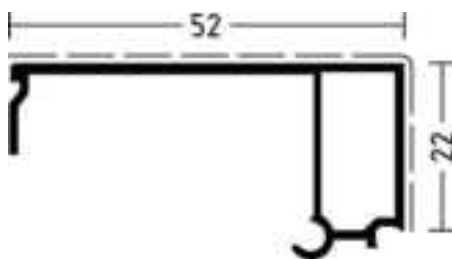

3991279



	m	mm	mm
3011015	6	41	0
3011021	6	51	0
3011022	6	41	0

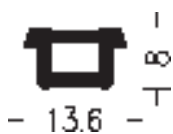

3011015

Schieberstangenprofil (E6/EV1) für Überschlagflügelprofile.
Schieberstangenprofile nur in eloxierter Ausführung E6/C0.
*Slide rod profile (E6/EV1) for overlapping sash profiles.
Slide rod profiles only in anodized finish E6/C0.*

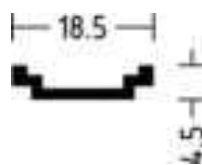

3011021

Schieberstangenprofil (E6/EV1) für Schwing-Wende- und Senk-Klappflügelprofile.
Schieberstangenprofile nur in eloxierter Ausführung E6/EV1
*Slide rod profile (E6/EV1) for horizontal/vertical pivot and outward projecting top-hung sash profiles.
Slide rod profiles only in anodized finish E6/EV1*

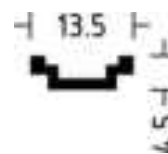

3011022

Schieberstangenprofil (E6/EV1) für Stulpflügelprofile. Schieberstangenprofile nur in eloxierter Ausführung E6/C0
Slide rod profile (E6/EV1) for double casement sash profiles. Slide rod profiles only in anodized finish E6/C0

WICLINE 75

Zusatzprofile Additional profiles

 m mm mm

	m	mm	mm
3091044	6	134	51
3091045	6	74	22
3091052	6	73	37
3091053	6	76	0

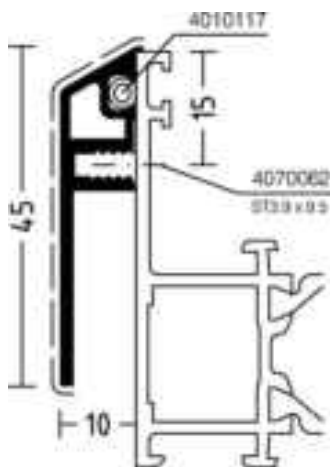

3091044

Verstärkungsprofil Fenstertüren
Reinforcement profile for casement doors



3091045

Wetterschenkelprofil
Weather bar profile

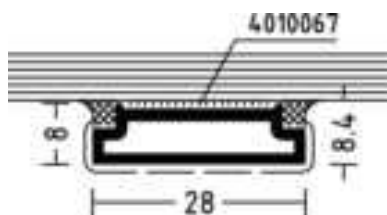

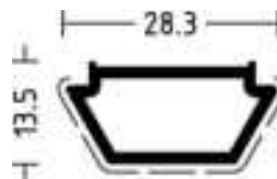

3091052

Ziersprossenprofil
Glazing bar profile



3091053

Ziersprossenprofil
Glazing bar profile

	 m	 mm	 mm
3091054	6	227	56
3991238	6,5	135	17
3991239	6,5	165	23
3091069	6	110	16

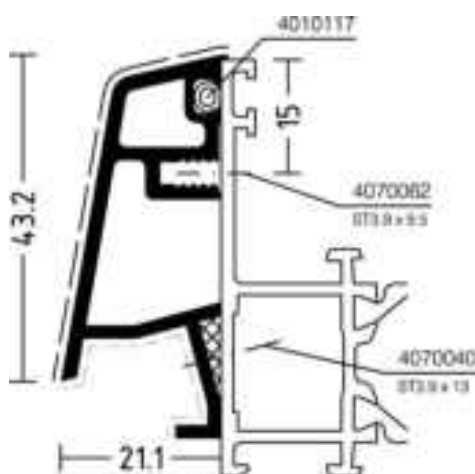

3091054

Verstärkungsprofil Fenstertüren
Reinforcement profile for casement doors

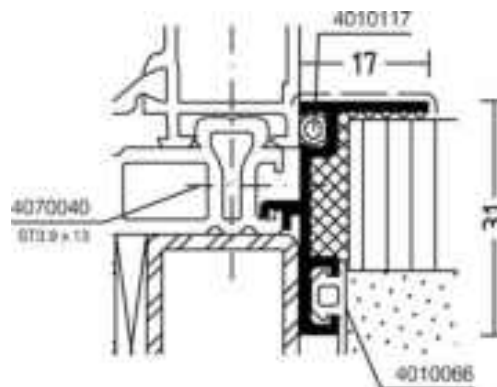

3991238

Anschlußprofil
Profile for junction to structure

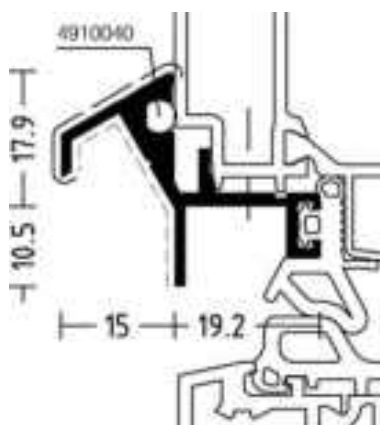

3991239

Wetterschenkelprofil für Fenstertüre einwärts
Weather bar profile casement door inwards

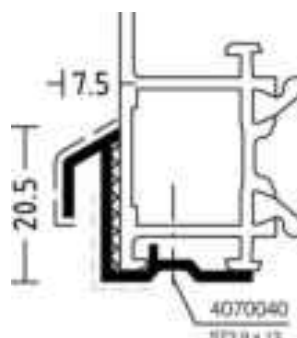

3091069

Unterstückverbindungsprofil
Sill connection profile

WICLINE 75

Zusatzprofile Additional profiles



	m	mm	mm
126793	6	115	56
126808	6	106	52
126807	6	136	67
126809	6	177	86
126762	6	159	78

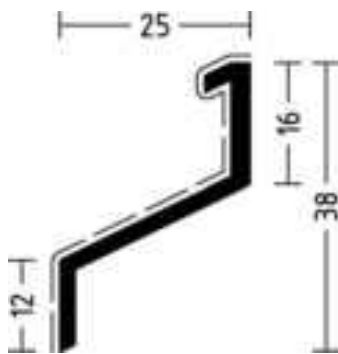

126793

Wetterschenkel
Weather bar profile

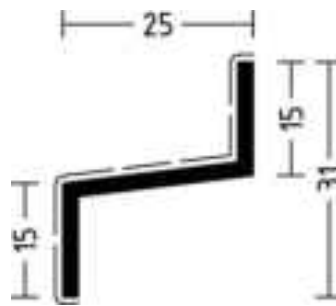

126808

Wetterschenkel
Weather bar profile

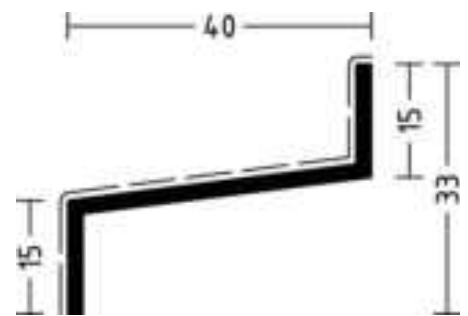

126807

Wetterschenkel
Weather bar profile

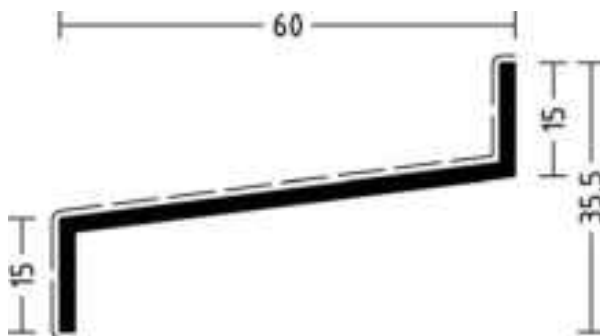

126809

Wetterschenkel
Weather bar profile

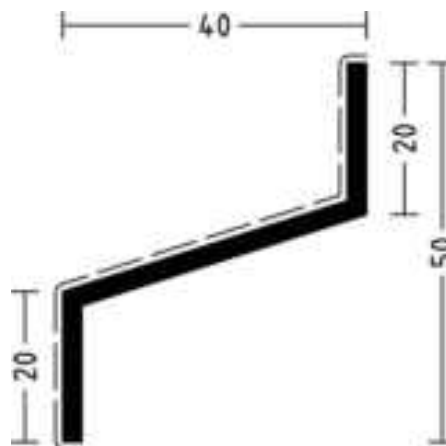

126762

Wetterschenkel
Weather bar profile

WICLINE 75

Zusatzprofile Additional profiles



	m	mm	mm
126763	6	123	59
151198	6	70	30

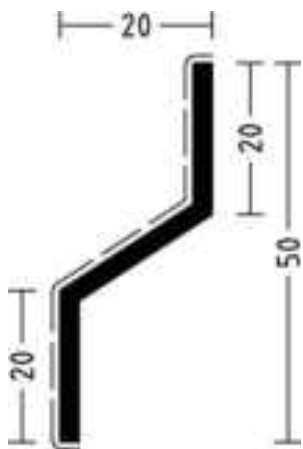

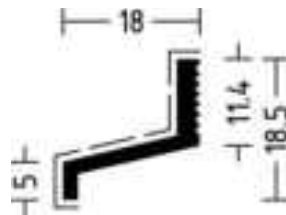

126763

Wetterschenkel
Weather bar profile



151198

Wetterschenkel
Weather bar profile

	 m	 mm	 mm
3991215	6,5	77	20
3991216	6,5	97	30
3991217	6,5	117	40
3091036	6	144	60

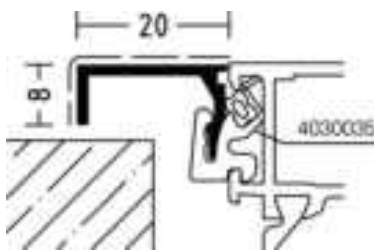

3991215

Bauanschlussprofil
Profile for junction to structure

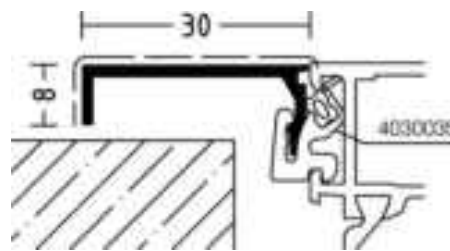

3991216

Bauanschlussprofil
Profile for junction to structure

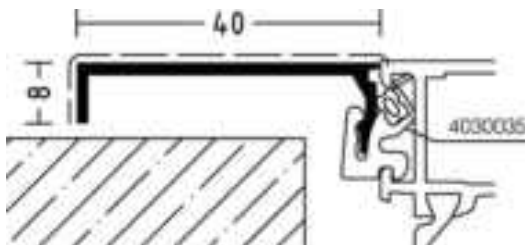

3991217

Bauanschlussprofil
Profile for junction to structure

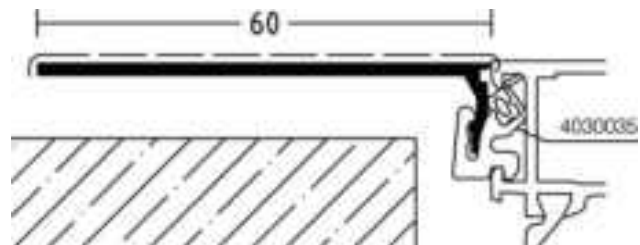

3091036

Bauanschlussprofil
Profile for junction to structure



	m	mm	mm
125776	6	128	38
149346	6	127	36
151063	6	106	30
149362	6	78	36
123943	6	88	23
126855	6	132	36

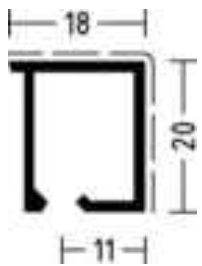

125776

Glasleistenprofil
Glazing bead profile



149346

Glasleistenprofil
Glazing bead profile



151063

Glasleistenprofil
Glazing bead profile

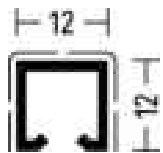

149362

Glasleistenprofil
Glazing bead profile



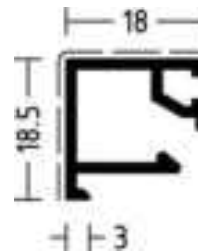

123943

Glasleistenprofil
Glazing bead profile



126855

Glasleistenprofil
Glazing bead profile

	 m	 mm	 mm
3091039	6	72	0
3091040	6	93	22

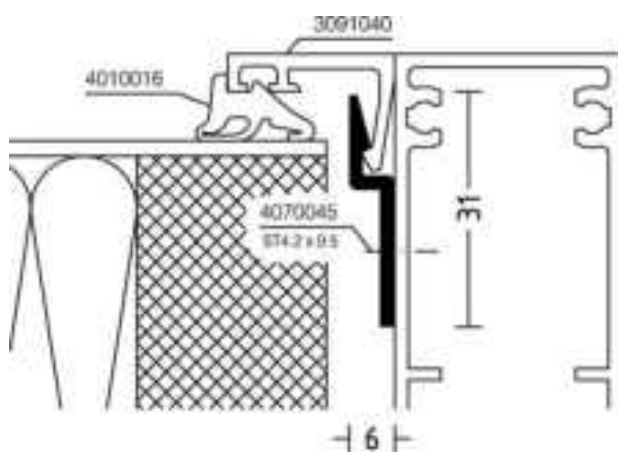

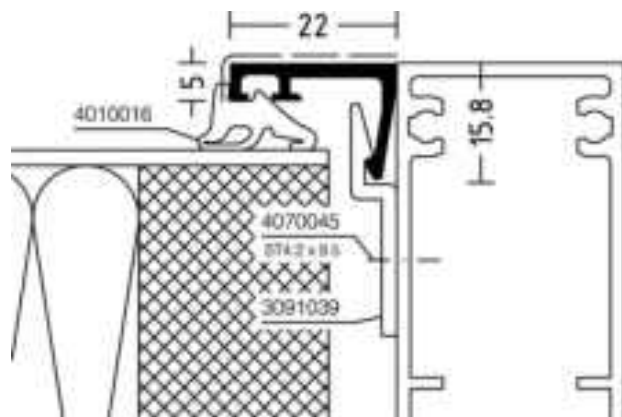

3091039

Klemmprofil
Clamping profile



3091040

Halteprofil
Retaining profile

	 m	 mm	 mm
3091037	6	160	25
3091055	6	124	44
3091056	6	126	22
3091057	6	123	17

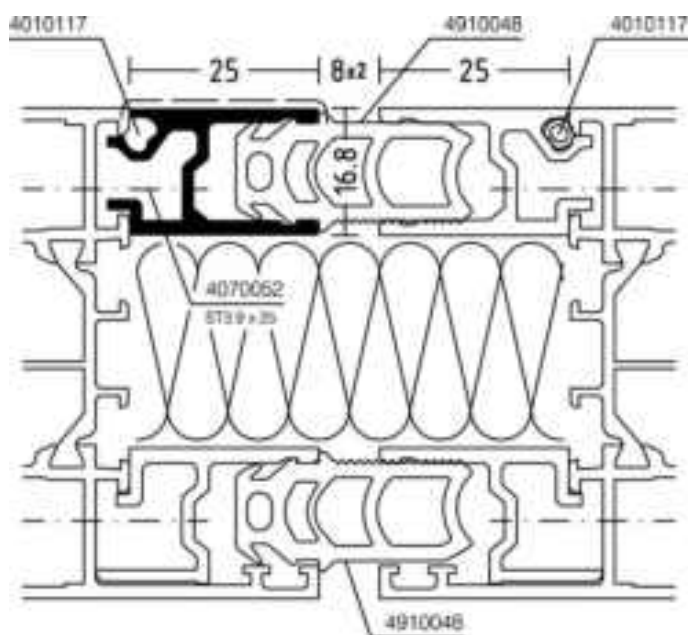

3091037

Kupplungsprofil
Coupling profile

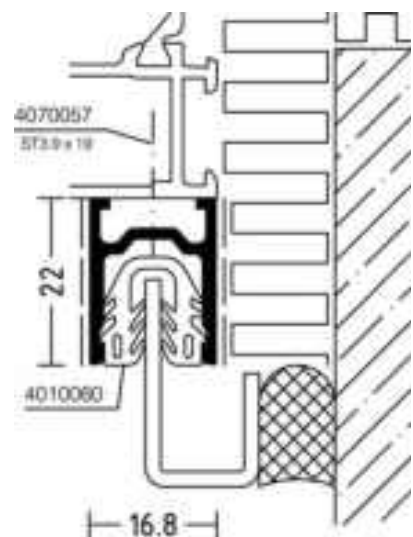

3091055

Bauanschlußprofil
Profile for junction to structure

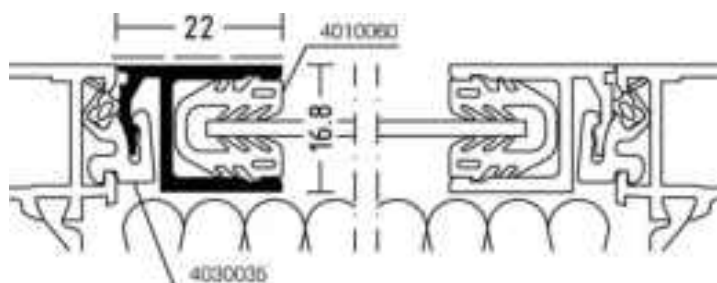

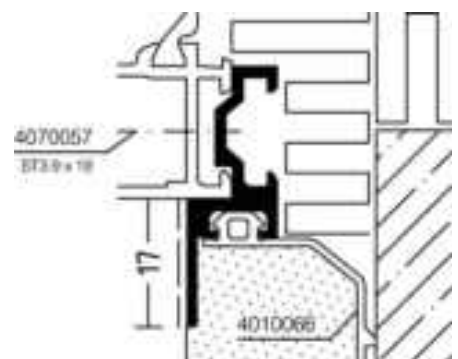

3091056

Dehnungsstoß-Profil
Expansion joint profile



3091057

Bauanschlußprofil
Profile for junction to structure

	 m	 mm	 mm
3091047	6	156	23
160747	6	147	0
3091031	6	130	

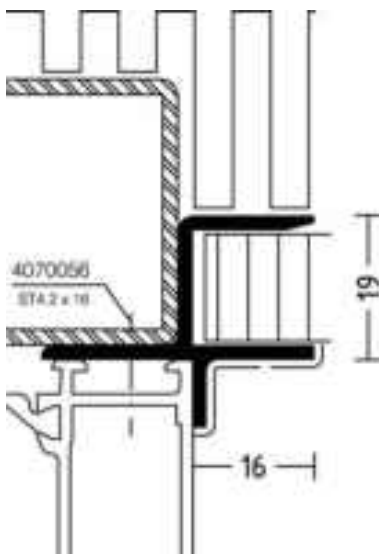

3091047

Bauanschlussprofil
Profile for junction to structure

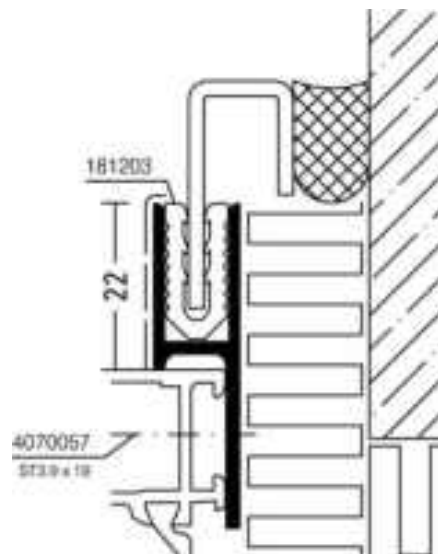

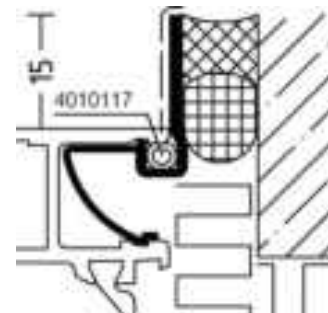

160747

Bauanschlussprofil
Profile for junction to structure



3091031

Bauanschlussprofil
Profile for junction to structure

	 m	 mm	 mm
3991234	6,5	136	27
3991237	6,5	125	23

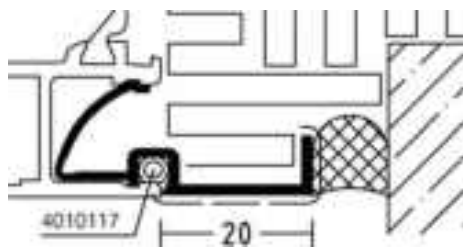

3991234

Bauanschlußprofil
Profile for junction to structure

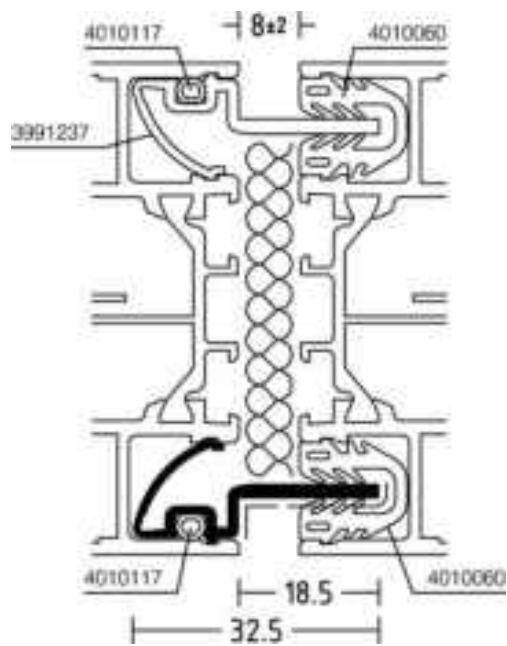

3991237

Zusatzprofil für Dehnstoß
Additional profile for expansion joint

WICLINE 75

Zusatzprofile Additional profiles

	 m	 mm	 mm
--	---	--	--

1010374	6,5	291	62
3991213	6,5	103	25
3991214	6,5	113	25

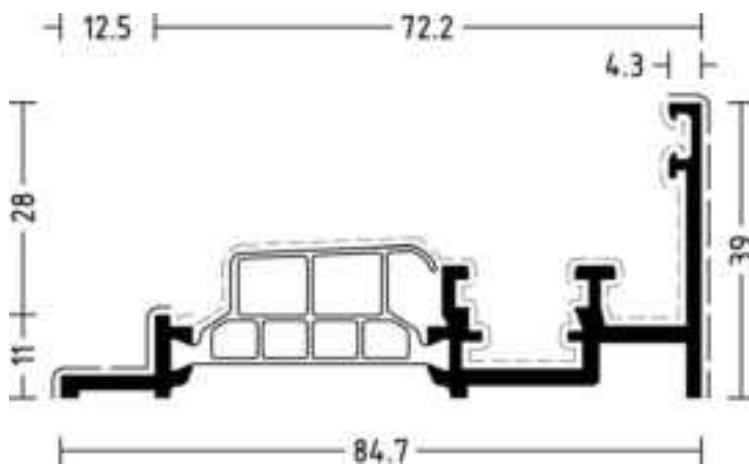

1010374

Abdeckprofil für Lüftungsklappenflügel
1010375 & 1010383
Cover profile for ventilation flap sash 1010375
& 1010383



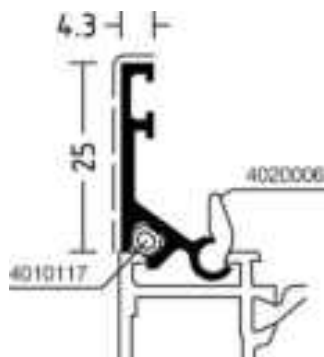

3991213

Falzprofil
Rebate profile



3991214

Glasleistenprofil
Glazing bead profile

	 m	 mm	 mm
3991220	6,5	98	15
3991236	6,5	109	19
3991280	6,5	125	0

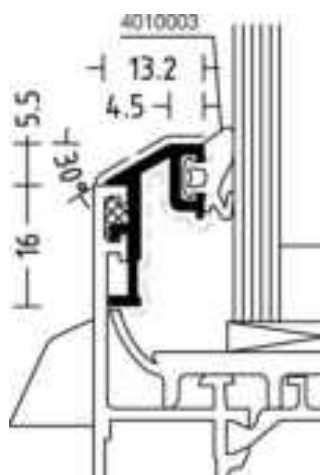

3991220

Glasleistenprofil, für Klassik-Design, aus Vormaterial 3991212, Einsatz nur mit Mitteldichtung und Formecken / Eckvulkanisierter Dichtungsrahmen
Glazing bead profile, for classic design, from prematerial 3991212, usage only with centre gasket and moulded gasket angle / corner vulcanized gasket frame

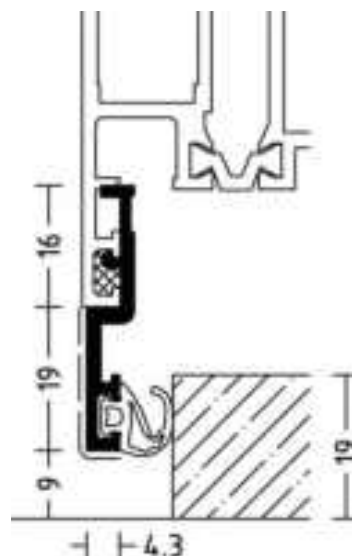

3991236

Falzverbreiterungsprofil, Einsatz nur mit Mitteldichtung und Formecke / Eckvulkanisierter Dichtungsrahmen
Rebate widening profile, usage only with centre gasket and moulded gasket angle / corner vulcanized gasket frame

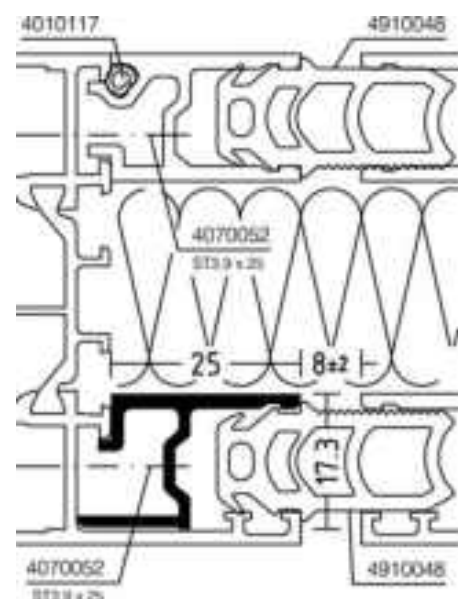

3991280

Profil 3991280 nur für vertikale Element-Dehnungsstöße geeignet.
Profile 3991280 is suitable only for vertical application of unit expansion joints.



	m	mm	mm
3991240	6,5	69	21
3910026	6,5	111	22

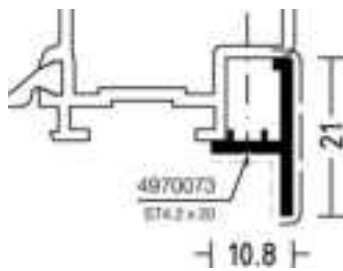

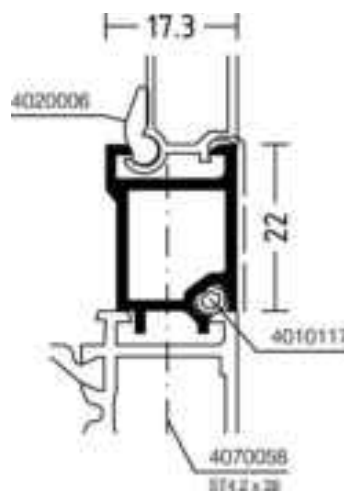

3991240

Aufsatzprofil,
Fenstertüre auswärts
Supplementary profile, casement door outwards



3910026

Adapterprofil
Adapter profile

	 m	 mm	 mm
3091042	6	116	19
3091059	6	138	30
3091041	6	281	144
3091058	6	352	147

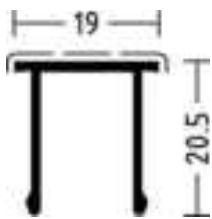

3091042

Abdeckprofil für 3091041
Cover profile for 3091041

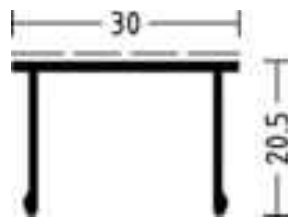

3091059

Abdeckprofil für Verstärkung 3091058
Cover profile for reinforcement 3091058



3091041

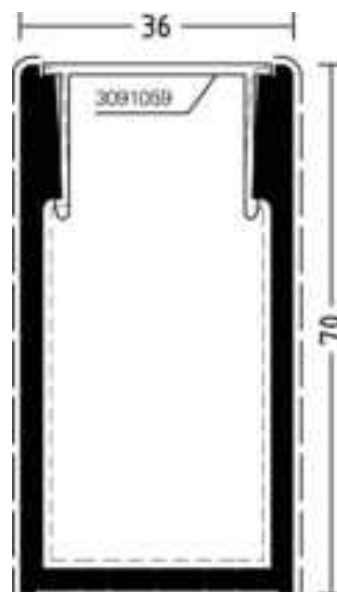

Verstärkungsprofil
Reinforcement profile



3091058

WICLINE 75

Zusatzprofile
Additional profiles

	 m	 mm	 mm
3091051	6	335	70
3091048	6	388	70

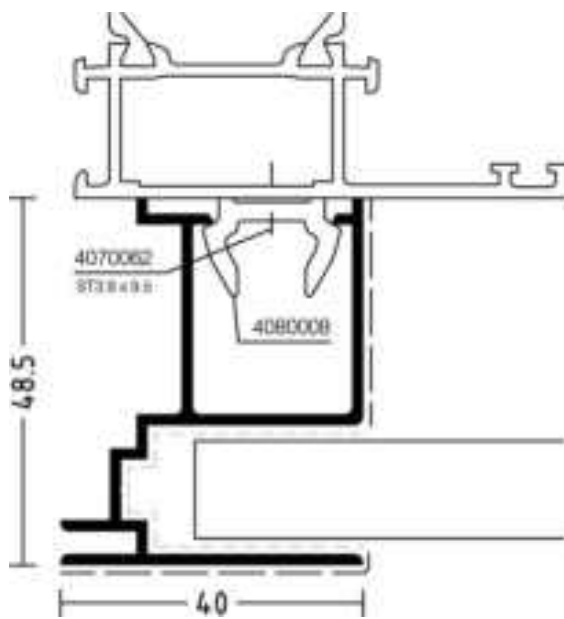

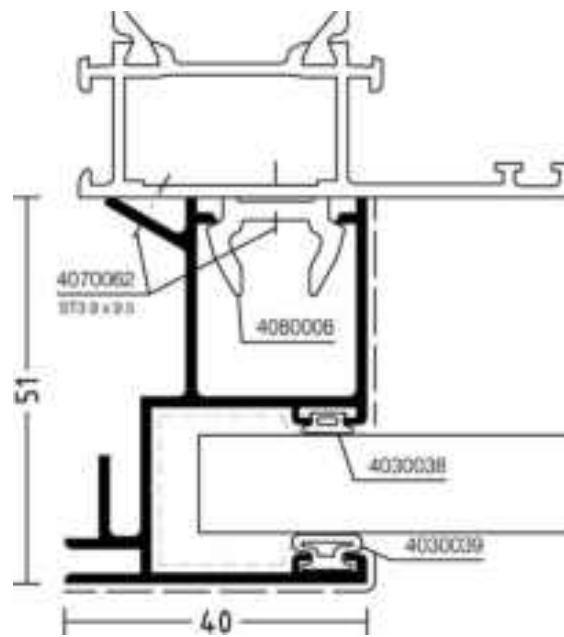

3091051
Führungsprofil
Guide profile



3091048
Rolladen-Führungsprofil
Shutter guide profile

WICLINE 75

Zusatzprofile
Additional profiles

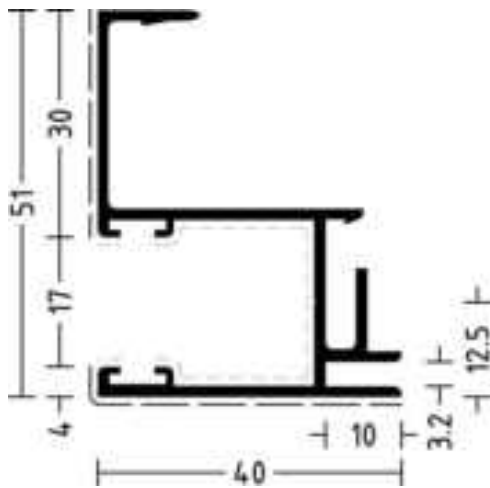

	 m	 mm	 mm
3091049	6	338	70
3091050	6	171	0

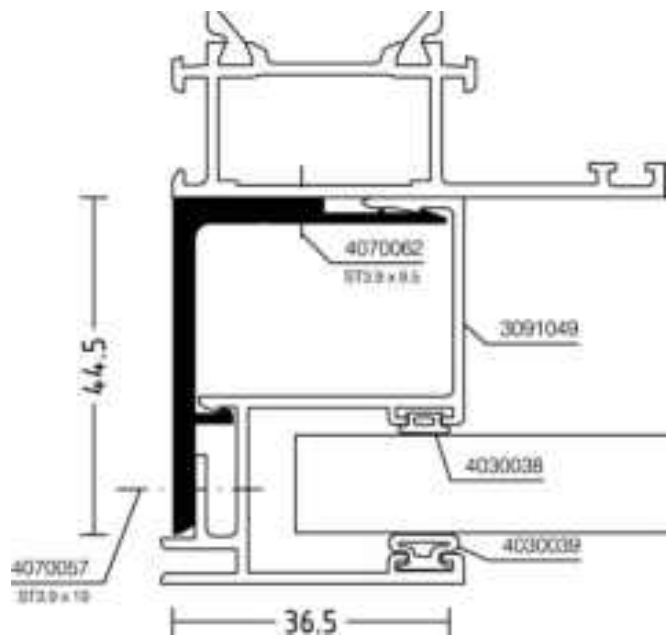

3091049
Führungsprofil
Guide profile



3091050
Befestigungsprofil
Fastening profile

	 m	 mm	 mm
3091046	6	171	0

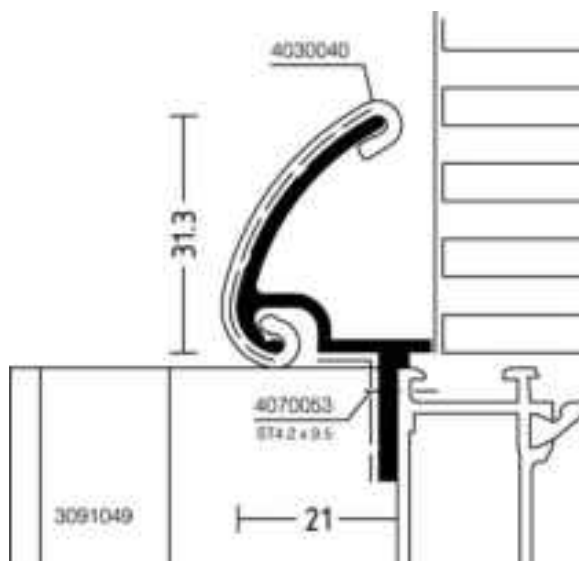

3091046

Rolladen-Einlaufprofil
Shutter inlet profile



	m	mm	mm
3991253	6,5	216	113
3090244	6,5	317	154
3991254	6,5	322	154



3991253

Verwendung:
1916004, 1917004

Application:
1916004, 1917004

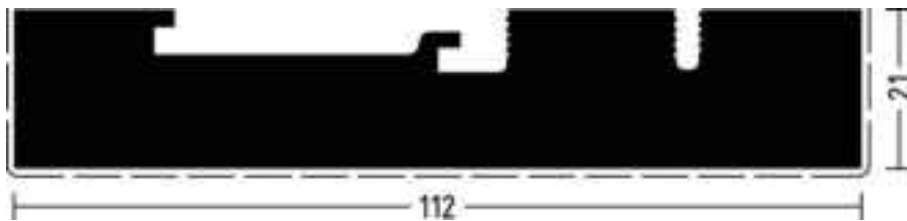

3090244

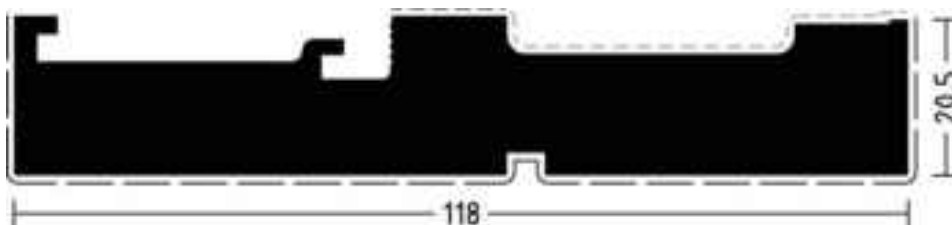



3991254

Verwendung:
1916004, 1917004

Application:
1916004, 1917004

WICLINE 75

Eckwinkelprofile
Corner angle profiles

	 m	 mm	 mm
3900030	3	235	0
3000074	3	242	0
3900048	3	291	0
3900049	3	325	0



3900030

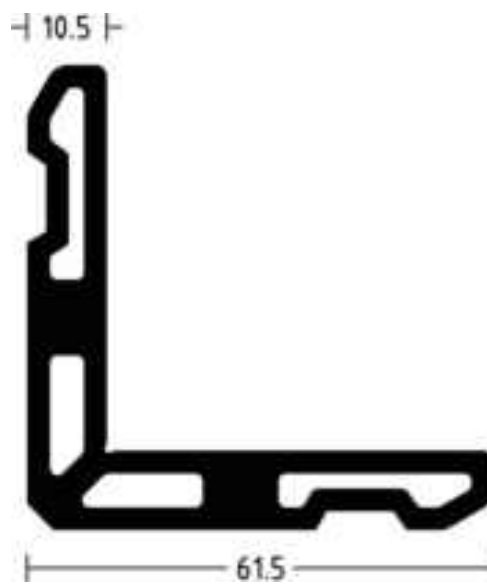

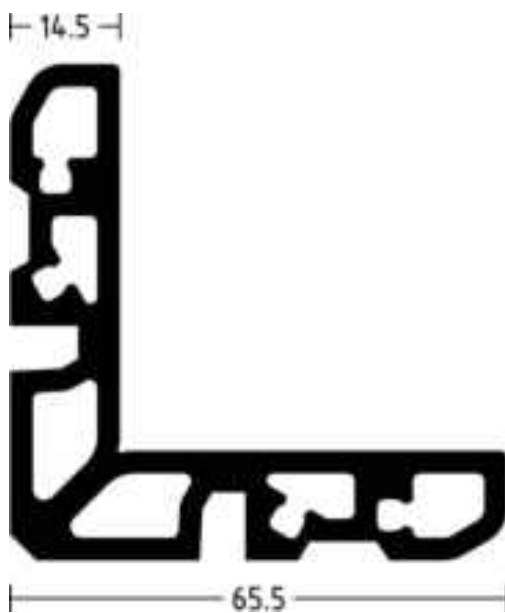

3000074



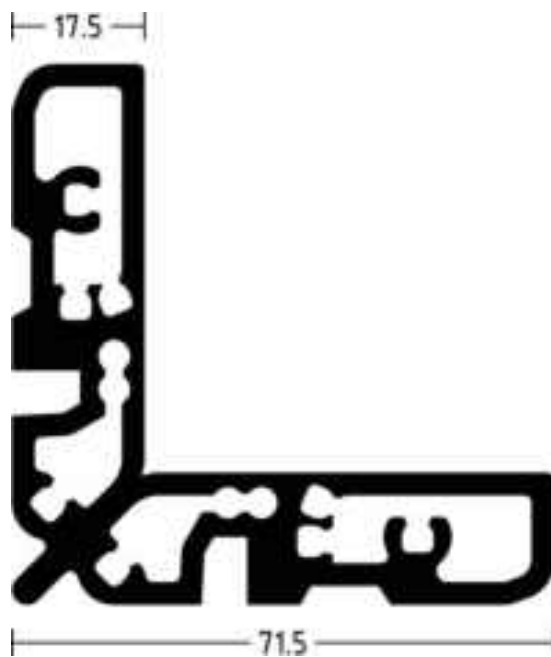



3900048

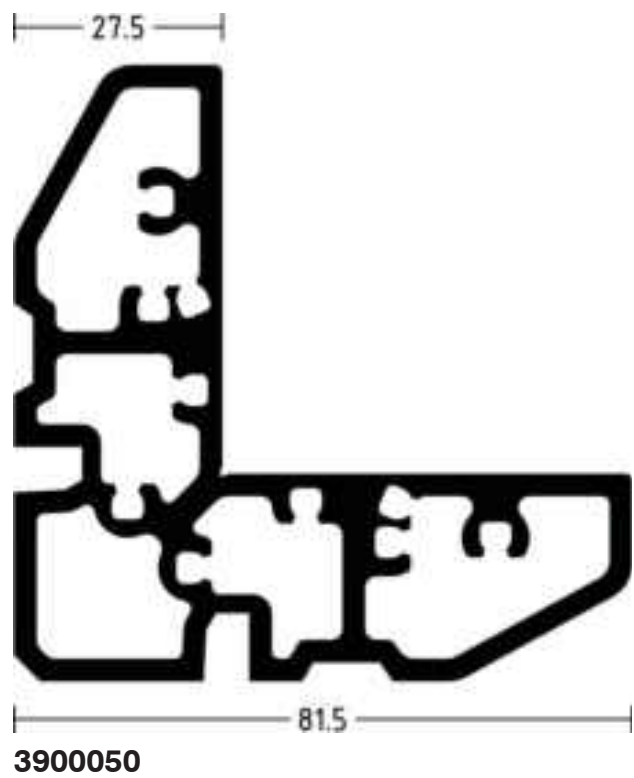
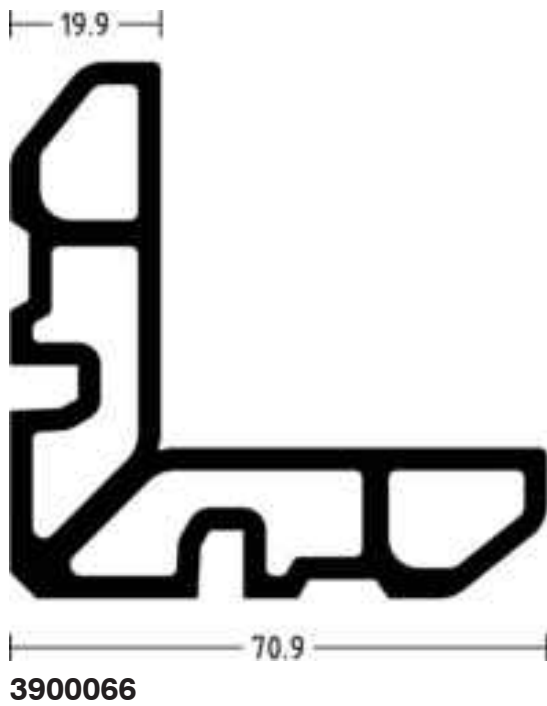

3900049

	 m	 mm	 mm
3900066	3	306	0
3900050	3	342	0



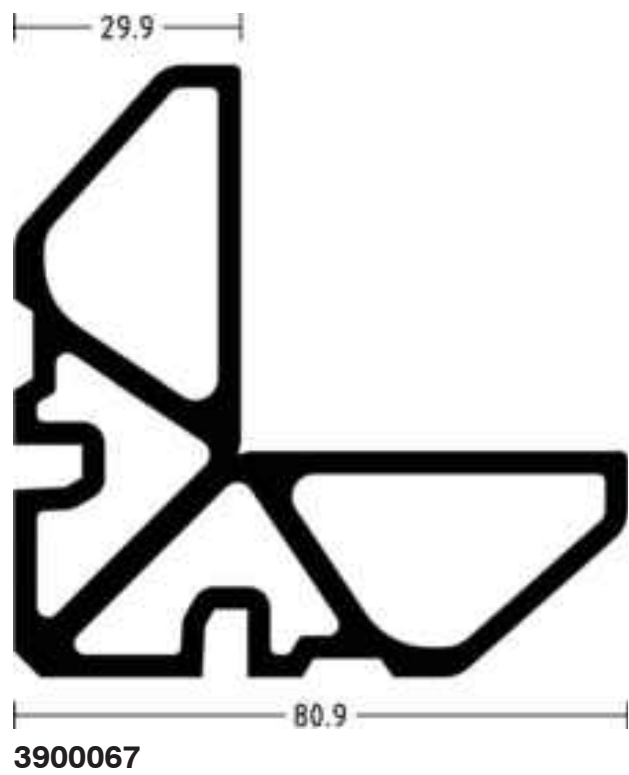
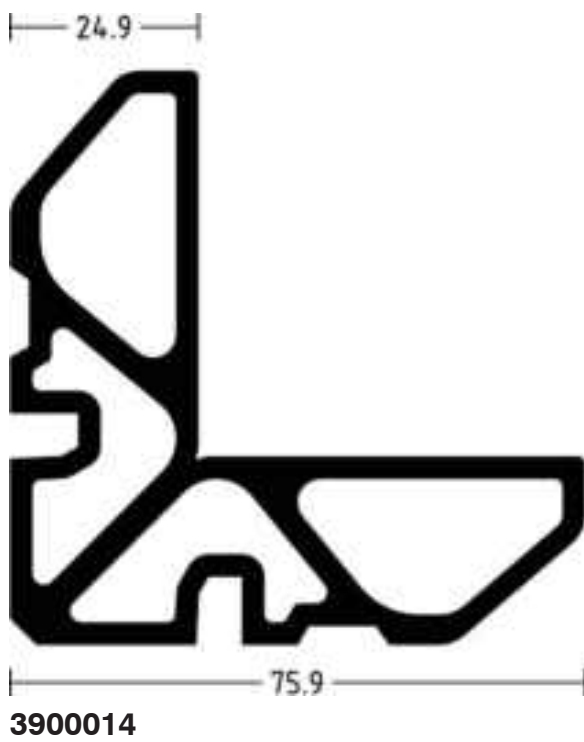

	 m	 mm	 mm
3900014	3	320	0
3900067	3	334	0



WICLINE 75

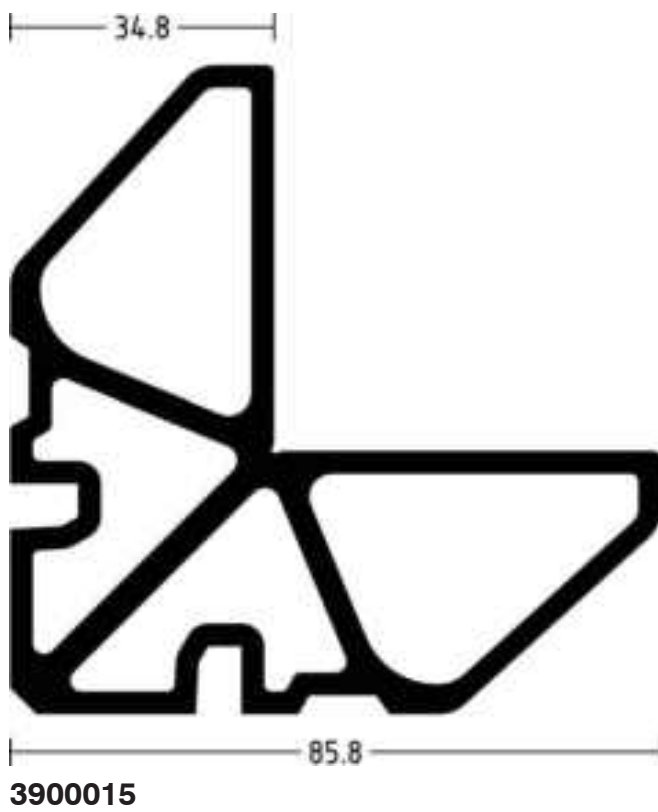

Eckwinkelprofile
Corner angle profiles

			
	m	mm	mm
3900015	3	348	0



WICLINE 75

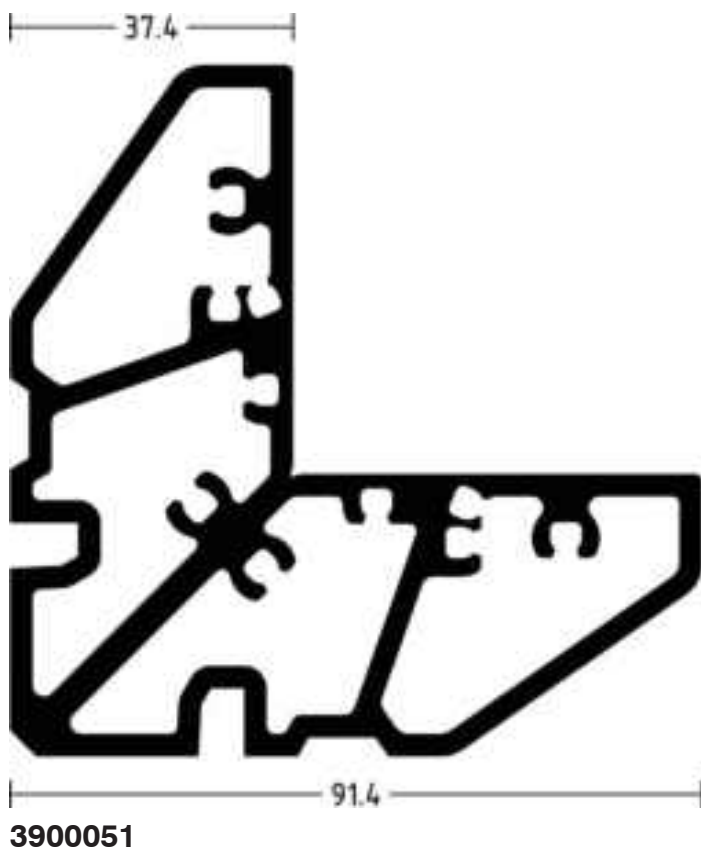

Eckwinkelprofile
Corner angle profiles

			
	m	mm	mm
3900051	3	369	0



WICLINE 75

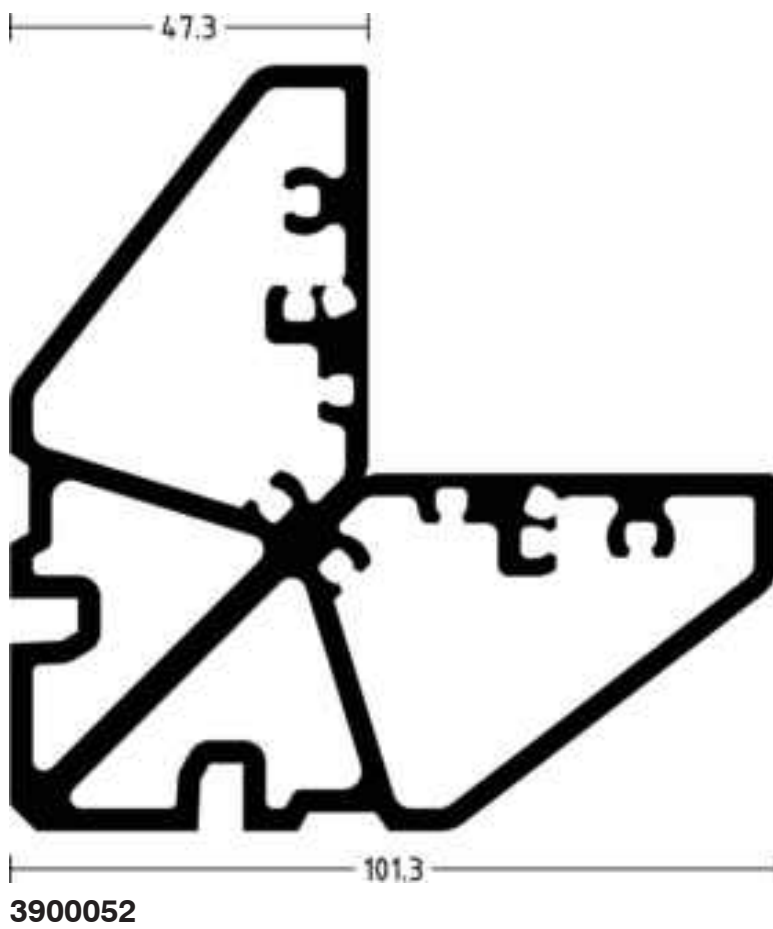

Eckwinkelprofile
Corner angle profiles

			
	m	mm	mm
3900052	3	397	0



WICLINE 75

Eckwinkelprofile
Corner angle profiles

			
	m	mm	mm
3900053	3	425	0

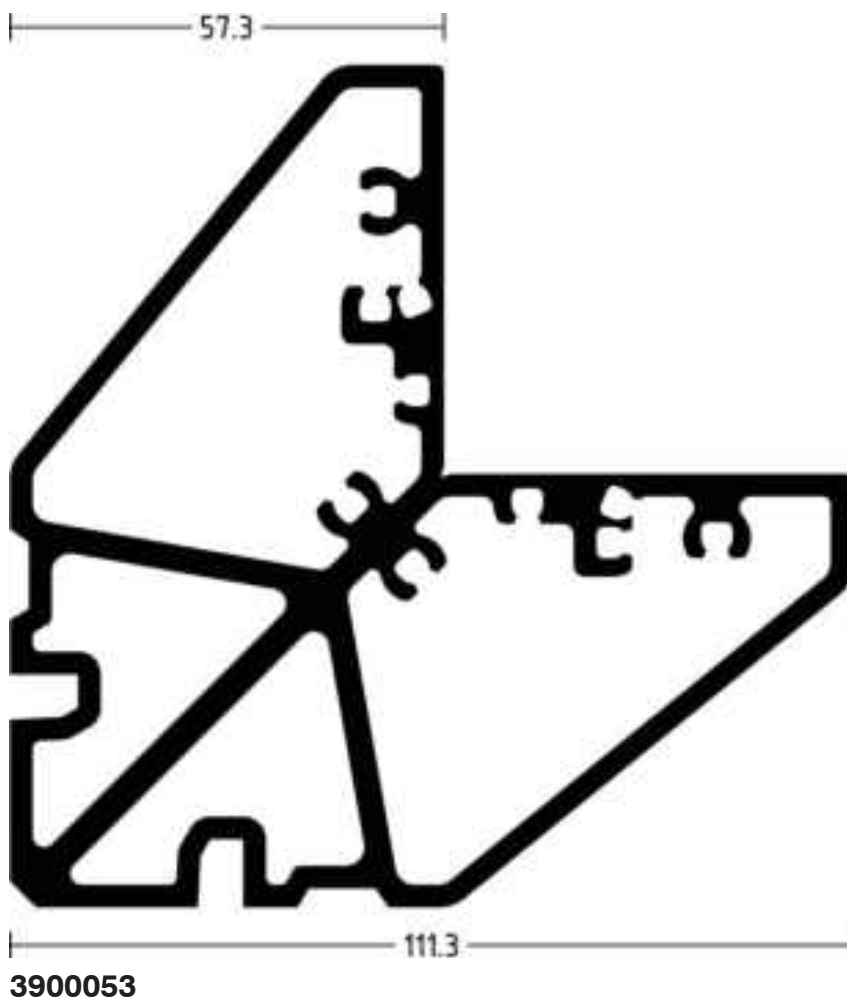

	Seite
	Page
Übersicht Zubehör	5/3
<i>Survey of accessories</i>	
Dichtungen Meterware	5/18
<i>Gaskets metre ware</i>	
Dichtungen Stückware	5/31
<i>Gaskets single parts</i>	
Kunststoffprofile, Formstücke	5/41
<i>Plastic profiles, moulded pieces</i>	
Eckwinkel, Blechteile	5/55
<i>Corner angles, Metal sheet parts</i>	
Verbinder	5/67
<i>Butt-joint connectors</i>	
Verbindungselemente / Schrauben	5/77
<i>Connecting components / Screws</i>	
Verschiedenes	5/81
<i>Miscellaneous</i>	
Schrauben-Tabellen	5/88
<i>Screw tables</i>	

WICLINE 75

Technische Information
Technical information

Übersicht Zubehör
Survey of accessories



4910002



4910004



4010003



4010243



4010015



4010235



4010016



4010236



4010017



4010237



4010018



4010238



4010495



4010082



4010045



4010245



4010046



4010047



4010052



4010060



4010066



4010090



4010180



4010436



4910018

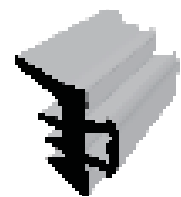

4910021



4910022



4910023



4010065



4910024

WICLINE 75

Technische Information
Technical information

Übersicht Zubehör
Survey of accessories



4910025



4910026



4910027



4910028



4910029



4910030



4910048



4910065



4910041



4910066



4910068



4910069



4910070



4910040



4010114



4010117



4010494



4910016



4910073



4910076



4910077



4910081

WICLINE 75

Technische Information
Technical information

Übersicht Zubehör
Survey of accessories



4920070



4920082



4920111



4020005

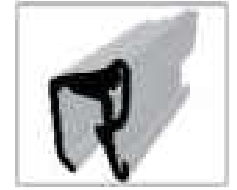

4020422



4020114



4020425



4020637



4020132



4020426



4920048



4920053

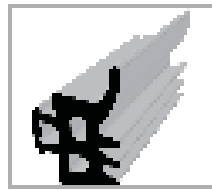

4920049

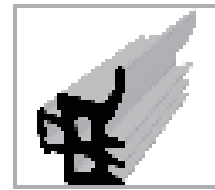

4920054



4920050



4920055



4920051



4920056



4020133



4020427



4920052



4920057



4020006



4020580



4920083



4920085

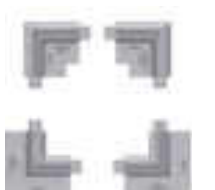

4920098



4920076

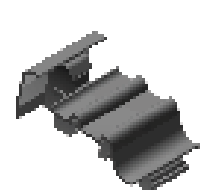

4920018



4920019

WICLINE 75

Technische Information
Technical information

Übersicht Zubehör
Survey of accessories



4020662



4920105



4920029



4920086



4920087

WICLINE 75

Technische Information
Technical information

Übersicht Zubehör
Survey of accessories



188413



188719



197157



197158



197159



4020049



4030001



4030019



4030022



4030026



4030035



4030036



4030038



4030039



4030040



4030043



4030365



4040008



4040087



4940078



4940079



4940090



4040026



4040027



4040028



4040029



4040030



4040036



4040037



4040040

WICLINE 75

Technische Information
Technical information

Übersicht Zubehör
Survey of accessories



4040086



4040088



4040682



4040729



4040730



4040731



4040732



4070030

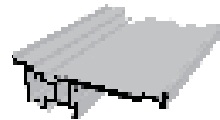

4930047



4940071



4940075



4940474



4940072



4940077



4940083



4940121



4940171



4940178



4940187



4940493



4940406



4940408



4940426



4940433



4940434



4940435



4940440



4940443



4940441



4940442

WICLINE 75

Technische Information
Technical information

Übersicht Zubehör
Survey of accessories

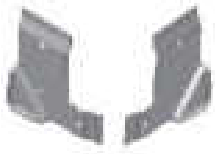

4040727



4040744



4040085



4940141



4940145

WICLINE 75

Technische Information
Technical information

Übersicht Zubehör
Survey of accessories



4050567



4050568



4050571



4050574



4050577



4950005



4950006



4950007



4950008



4950009



4950010



4950011



4950012



4950013



4950014



4950018



4950019



4950020



4950021



4950022



4950024



4950025



4950028



4950029



4950030



4950031



4950032



4950033



4950034



4950035

WICLINE 75

Technische Information
Technical information

Übersicht Zubehör
Survey of accessories



4950036



4950037



4950038



4950047



4950049



4950051



4950052



4950053



4950054



4950055



4950056



4950057



4950349



4950060



4950061



4950062



4950063



4950065



4950066



4950067



4950075



4950076



4950077



4950078



4950079



4950085



4950086



4950087



4050150



4050153

WICLINE 75

Technische Information
Technical information

Übersicht Zubehör
Survey of accessories



4950082



4950083

WICLINE 75

Technische Information
Technical information

Übersicht Zubehör
Survey of accessories



4960002



4960003



4960004



4960005



4960006



4960007



4960008



4960009



4960010



4960011



4960012



4960013



4960020



4960021



4960025



4960026



4960030



4960031



4960035



4960036



4960037



4060056



4960050



4960052



4960053



4960054



4960055



4960056



4960057



4960058

WICLINE 75

Technische Information
Technical information

Übersicht Zubehör
Survey of accessories



4960059



4960060



4960061



4960062



4960063



4960229



4960230



4960040



4960041



4960042



4960043



4960045



4960046



4960047



4960048

WICLINE 75

Technische Information
Technical information

Übersicht Zubehör
Survey of accessories



6041192



180311



186016



198069



4070000



4070002



4070003



4070004



4070008



4070009



4070010



4070011



4070012



4070013



4070036



4070068



4070069



4070241



4970077



4970079

WICLINE 75

Technische Information
Technical information

Übersicht Zubehör
Survey of accessories



4080446



4080447



4080448



4080007



4080006



4010067



180172



180179



188206



188250



4080008



4080444



4080445



4980054



4980055



4090157



4090158



4900187



4980067



4090152



4090200



4390002



4990001



4990003



4990004



4990006



4090097



4090098



4090099

WICLINE 75

Technische Information
Technical information

Übersicht Zubehör
Survey of accessories



4090100



4090101



4990014







4990016

WICLINE 75

Dichtungen Meterware

Gaskets metre ware





Zubehör
Accessories

Artikel Article	VE PU	Anwendung Application	Bezeichnung / Hinweise Designation / Indications	Abbildung Figure
		Material / Material Farbe / Colour	Zuordnung Assignment	
4910002	200 m 200 m	WICLINE 75	Dichtung Verglasungsdichtung innen, Spalt 2 mm. Dichtung umlaufend, Stoß oben horizontal.	
		EPDM	Gasket Inner glazing gasket, Gap 2 mm. Perimetric gasket, top horizontal joint.	
		schwarz black		
4910004	200 m 200 m	WICLINE 75	Dichtung Verglasungsdichtung innen. Spalt 4 mm. Dichtung umlaufend, Stoß oben horizontal.	
		EPDM	Glazing Inner glazing gasket. Gap 4 mm. Perimetric gasket, butt joint top horizontal.	
		schwarz black		
4010003	200 m 200 m	WICLINE 75	Verglasungsdichtung Verglasungsdichtung außen. Spalt 4 mm. Dichtung umlaufend. Stoß oben horizontal.	
		EPDM, geschäumt EPDM, foamed	External glazing gasket Outer glazing gasket. Gap 4 mm. Perimetric gasket. Butt joint top horizontal.	
		schwarz black		
4010243	200 m 200 m	WICLINE 75	Verglasungsdichtung Verglasungsdichtung außen. Spalt 4 mm. Dichtung umlaufend. Stoß oben horizontal.	
		EPDM	Glazing gasket, grey EPDM Outer glazing gasket. Gap 4 mm. Perimetric gasket. Top horizontal joint.	
		grau grey		
4010015	200 m 200 m	WICLINE 75	Dichtung Verglasungsdichtung innen. Spalt 5 mm. Dichtung umlaufend. Stoß oben horizontal. Kennzeichen 2 x blau (bisherige Art.-Nr. 190225)	
		EPDM	Gasket Inner glazing gasket. Gap 5 mm. Perimetric gasket. Butt joint top horizontal.	
		schwarz black	Marked with 2 x blue (former art. no. 190225)	

WICLINE 75

Dichtungen Meterware
Gaskets metre ware





Zubehör
Accessories





Artikel Article	VE PU	Anwendung Application	Bezeichnung / Hinweise Designation / Indications	Abbildung Figure
		Material / Material Farbe / Colour	Zuordnung Assignment	
4010235	200 m 200 m	WICLINE 75	Dichtung Verglasungsdichtung innen. Spalt 5 mm. Dichtung umlaufend. Stoß oben horizontal. Kennzeichen 2 x blau.	
		EPDM	Gasket Inner glazing gasket. Gap 5 mm. Perimetric gasket. Top horizontal joint. Marked with 2 x blue.	
		grau grey		
4010016	200 m 200 m	WICLINE 75	Dichtung Verglasungsdichtung innen. Spalt 6 mm. Dichtung umlaufend. Stoß oben horizontal. Kennzeichen 2 x rot (bisherige Art.-Nr. 190226)	
		EPDM	Gasket Inner glazing gasket. Gap 6 mm. Perimetric gasket. Butt joint top horizontal. Marked with 2 x red. (former article no. 190226)	
		schwarz black		
4010236	200 m 200 m	WICLINE 75	Dichtung Verglasungsdichtung innen. Spalt 6 mm. Dichtung umlaufend. Stoß oben horizontal. Kennzeichen 2 x rot.	
		EPDM	Gasket Inner glazing gasket. Gap 6 mm. Perimetric gasket. Top horizontal joint. Marked with 2 x red.	
		grau grey		
4010017	200 m 200 m	WICLINE 75	Dichtung Verglasungsdichtung innen. Spalt 7 mm. Dichtung umlaufend. Stoß oben horizontal. Kennzeichen 2 x grün. (bisherige Art.-Nr. 190227)	
		EPDM	Gasket Inner glazing gasket. Gap 7 mm. Perimetric gasket. Butt joint top horizontal. Marked with 2 x green. (former article no. 190227)	
		schwarz black		

WICLINE 75

Dichtungen Meterware
Gaskets metre ware

Zubehör
Accessories





Artikel Article	VE PU	Anwendung Application	Bezeichnung / Hinweise Designation / Indications	Abbildung Figure
		Material / Material Farbe / Colour	Zuordnung Assignment	
4010237	200 m 200 m	WICLINE 75	Dichtung Verglasungsdichtung innen. Spalt 7 mm. Dichtung umlaufend. Stoß oben horizontal. Kennzeichen 2 x grün.	
		EPDM	Gasket Inner glazing gasket. Gap 7 mm. Perimetric gasket. Top horizontal joint. Marked with 2 x green.	
		grau grey		
4010018	200 m 200 m	WICLINE 75	Dichtung Verglasungsdichtung innen. Spalt 8 mm. Dichtung umlaufend. Stoß oben horizontal. Kennzeichen 2 x weiß. (bisherige Art.-Nr. 190258)	
		EPDM	Gasket Inner glazing gasket. Gap 8 mm. Perimetric gasket. Butt joint top horizontal. Marked with 2x white. (former article no. 190258)	
		schwarz black		
4010238	200 m 200 m	WICLINE 75	Dichtung Verglasungsdichtung innen. Spalt 8 mm. Dichtung umlaufend. Stoß oben horizontal. Kennzeichen 2 x weiß.	
		EPDM	Gasket Inner glazing gasket. Gap 8 mm. Perimetric gasket. Top horizontal joint. Marked with 2 x white.	
		grau grey		
4010495	100 m 100 m	WICLINE 75	Verglasungsdichtung Verglasungsdichtung außen. Spalt 9 mm. Oberfläche: gleitpolymerisiert	
		EPDM	Glazing gasket Glazing gasket outside. Gap 9 mm. Surface: glide-polymerized	

Artikel Article	VE PU	Anwendung Application	Bezeichnung / Hinweise Designation / Indications	Abbildung Figure
		Material / Material Farbe / Colour	Zuordnung Assignment	
4010082	100 m 100 m	WICLINE 75	Verglasungsdichtung Verglasungsdichtung außen. Spalt 11 mm. Rahmenvulkanisation möglich. Lieferzeit anfragen. Bestellformular 4020133 anfordern. Festfeld in Verbindung mit Flügeln verdeckt liegend.	
		EPDM	Glazing gasket Outer glazing gasket. Gap 11 mm. Gasket frame vulcanization is possible. Ask for delivery time. Request order form 4020133. Fixed field in connection with concealed sashes.	
		schwarz black		
4010045	200 m 200 m	WICLINE 75	Anschlagdichtung Flügel-Anschlagdichtung.	
		EPDM	Stop gasket Sash stop gasket.	
		schwarz black		
4010245	200 m 200 m	WICLINE 75	Anschlagdichtung Verwendung: universell	
		EPDM	Stop gasket Application: universal	
		grau grey		
4010046	100 m 100 m	WICLINE 75	Dichtung Dichtung für Bauanschlussprofil, in Verbindung mit 4030026 einsetzbar.	
		EPDM	Gasket Gasket for junction to structure profile 4030026.	
		schwarz black		

WICLINE 75

Dichtungen Meterware
Gaskets metre ware





Zubehör
Accessories

Artikel Article	VE PU	Anwendung Application	Bezeichnung / Hinweise Designation / Indications	Abbildung Figure
		Material / Material Farbe / Colour	Zuordnung Assignment	
4010047	20 m 20 m	WICLINE 75	Kederdichtung Dichtung bei Stoß zweier mit einander verschraubten Blendrahmen. Dichtungsenden mit dauerelastischer Dichtungsmasse abdichten.	
		EPDM	Profile joint gasket Gasket for joints between two frames screwed together. Seal gasket ends with sealing compound.	
		schwarz black		
4010052	20 m 20 m	WICLINE 75	Nutabdeckprofil Verwendung: universell passend in die Nut der Blendrahmenseite.	
		EPDM	Groove cover profile Application: universal Fits into the outer groove of the frame profile.	
		schwarz black		
4010060	50 m 50 m	WICLINE 75	Dichtung für Dehnnuten. Für Dehnnuten 12.8 mm. Blecheinschub 2 - 3 mm.	
		EPDM	Gasket for expansion joint grooves. For 12.8 mm expansion joint grooves. Slide-in plate thickness 2 - 3 mm.	
		schwarz black		
4010066	50 m 50 m	WICLINE 75	Dichtbahn Verwendung: Wandanschlussfolie, Dichtbahn 430 mm breit. Dichtbahnen mit EPDM-Klebstoff auf Überlappungen und Untergrund kleben.	
		EPDM	Sealing web Application: Wall junction foil, sealing web width 430 mm. Glue sealing webs with EPDM adhesive on overlappings and underground.	
		schwarz black		
4010090	50 m 50 m	WICLINE 75	Verglasungsdichtung für Durchschusshemmung. Spalt 4 mm	
		EPDM	Glazing gasket for bullet resistance. Gap 4 mm	
		schwarz black		

WICLINE 75

Dichtungen Meterware
Gaskets metre ware





Zubehör
Accessories

Artikel Article	VE PU	Anwendung Application	Bezeichnung / Hinweise Designation / Indications	Abbildung Figure
		Material / Material Farbe / Colour	Zuordnung Assignment	
4010180	50 m 50 m	WICLINE 75	Dichtung Zur Verbesserung der Schalldämmwerte. Dichtung oben horizontal 2 x 100 mm aus der Ecke unterbrechen.	
		EPDM	Gasket For improvement of sound insulation. Cut out gasket 2 x 100 mm in corner area at the top horizontal.	
		schwarz black		
4010436	30 m 30 m	WICLINE 75	Mitteldichtung Einbau mit Formecken 4020580. Einsetzbar in alle Blendrahmenprofile.	
		EPDM	Centre gasket Assembly with moulded gasket corner angle 4020580. Applicable in all frame profiles.	
		schwarz black		
4910018	200 m 200 m	WICLINE 75	Stoßdichtung Universell einsetzbar, Zur Abdichtung am Elementstoß, Dichtungsenden mit dauerelastischer Dichtungsmasse abdichten. Oberflächenbehandlung: polymerisiert	
		EPDM, geschäumt EPDM, foamed	Joint sealing gasket Universal application. For sealing unit joints. Seal gasket ends with non-setting sealing compound. Surface treatment: polymerized	
		schwarz black		
4910021	100 m 100 m	WICLINE 75	Verglasungsdichtung Verglasungsdichtung innen. Spalt 4.5 mm. (gleitpolymerisiert) Bei verdecktliegenden Flügeln einsetzbar. Rahmenvulkanisation mit 4910059 möglich.	
		EPDM	Glazing gasket Inner glazing gasket. Gap 4.5 mm. (glide polymerized) Applicable in concealed sashes. Gasket frame vulcanization possible with 4910059.	
		schwarz black		

WICLINE 75

Dichtungen Meterware
Gaskets metre ware



Zubehör
Accessories

Artikel Article	VE PU	Anwendung Application	Bezeichnung / Hinweise Designation / Indications	Abbildung Figure
		Material / Material Farbe / Colour	Zuordnung Assignment	
4910022	100 m 100 m	WICLINE 75	Verglasungsdichtung Verglasungsdichtung. Spalt 6.5 mm. (gleitpolymerisiert) Rahmenvulkanisation mit 4910060 möglich.	
		EPDM	Glazing gasket <i>Glazing gasket. Gap 6.5 mm. (glide polymerized)</i>	
		schwarz black	<i>Gasket frame vulcanization possible with 4910060.</i>	
4910023	100 m 100 m	WICLINE 75	Verglasungsdichtung Verglasungsdichtung. Spalt 8.5 mm. (gleitpolymerisiert. Bei verdecktliegenden Flügeln einsetzbar. Rahmenvulkanisation mit 4910061 möglich.	
		EPDM	Glazing gasket <i>Glazing gasket. Gap 8.5 mm. (glide polymerized).</i>	
		schwarz black	<i>Applicable in concealed sashes. Gasket frame vulcanization possible with 4910061.</i>	
4010065	100 m 100 m	WICLINE 75	Verglasungsdichtung Verglasungsdichtung. Spalt 9 mm. Rahmenvulkanisation möglich. Lieferzeit anfragen. Bestellformular 4020132 anfordern.	
		EPDM	Glazing gasket <i>Glazing gasket. Gap 9 mm. Gasket frame vulcanization is possible. Ask for time of delivery.</i>	
		schwarz black	<i>Request order form 4020132.</i>	
4910024	100 m 100 m	WICLINE 75	Verglasungsdichtung Verglasungsdichtung innen. Spalt 10.5 mm. (gleitpolymerisiert) Bei verdecktliegenden Flügeln einsetzbar. Rahmenvulkanisation mit 4910062 möglich.	
		EPDM	Glazing gasket <i>Inner glazing gasket. Gap 10.5 mm. (glide polymerized)</i>	
		schwarz black	<i>Applicable in concealed sashes. Gasket frame vulcanization possible with 4910062.</i>	

WICLINE 75

Dichtungen Meterware
Gaskets metre ware



Zubehör
Accessories

Artikel Article	VE PU	Anwendung Application	Bezeichnung / Hinweise Designation / Indications	Abbildung Figure
		Material / Material Farbe / Colour	Zuordnung Assignment	
4910025	100 m 100 m	WICLINE 75	Verglasungsdichtung Verglasungsdichtung innen. Spalt 12.5 mm. (gleitpolymerisiert) Bei verdecktliegenden Flügeln einsetzbar. Rahmenvulkanisation mit 4910063 möglich.	
		EPDM	Glazing gasket Inner glazing gasket. Gap 12.5 mm. (glide polymerized) Applicable in concealed sashes. Gasket frame vulcanization possible with 4910063.	
		schwarz black		
4910026	50 m 50 m	WICLINE 75	Ausgleichsdichtung Oberfläche: polymerisiert Verwendung: Adapterdichtung in Verbindung mit Einspannblendrahmen bei WICTEC 50/60. Dicke 2 mm. In der Ecke auf Gehrung schneiden und verkleben.	
		EPDM	Compensating gasket Surface: polymerized. Application: Adapter gasket in connection with clamping frame for WICTEC 50/60. Thickness 2 mm. Mitre cut corners and glued.	
		schwarz black		
4910027	50 m 50 m	WICLINE 75	Ausgleichsdichtung Oberfläche: polymerisiert Verwendung: Adapterdichtung in Verbindung mit Einspannblendrahmen bei WICTEC 50/60. Dicke 4 mm. In der Ecke auf Gehrung schneiden und verkleben.	
		EPDM	Compensating gasket Surface: polymerized. Application: Adapter gasket in connection with clamping frame for WICTEC 50/60. Thickness 4 mm. Mitre cut corners and glued.	
		schwarz black		

WICLINE 75

Dichtungen Meterware
Gaskets metre ware





Zubehör
Accessories

Artikel Article	VE PU	Anwendung Application	Bezeichnung / Hinweise Designation / Indications	Abbildung Figure
		Material / Material Farbe / Colour	Zuordnung Assignment	
4910028	50 m 50 m	WICLINE 75	Ausgleichsdichtung Oberfläche: polymerisiert. Verwendung: Adapterdichtung in Verbindung mit Einspannblendrahmen bei WICTEC 50/60. Dicke 6 mm. In der Ecke auf Gehrung schneiden und verkleben.	
		EPDM	Compensating gasket Surface: polymerized. Application: Adapter gasket in connection with clamping frame for WICTEC 50/60. Thickness 6 mm. Mitre cut corners and glued.	
		schwarz black		
4910029	50 m 50 m	WICLINE 75	Ausgleichsdichtung Oberfläche: polymerisiert. Verwendung: Adapterdichtung in Verbindung mit Einspannblendrahmen bei WICTEC 50/60. Dicke 8 mm. In der Ecke auf Gehrung schneiden und verkleben.	
		EPDM	Compensating gasket Surface: polymerized. Application: Adapter gasket in connection with clamping frame for WICTEC 50/60. Thickness 8 mm. Mitre cut corners and glued.	
		schwarz black		
4910030	50 m 50 m	WICLINE 75	Ausgleichsdichtung Oberfläche: polymerisiert. Verwendung: Adapterdichtung in Verbindung mit Einspannblendrahmen bei WICTEC 50/60. Dicke 10 mm. In der Ecke auf Gehrung schneiden und verkleben.	
		EPDM	Compensating gasket Surface: polymerized. Application: Adapter gasket in connection with clamping frame for WICTEC 50/60. Thickness 10 mm. Mitre cut corners and glued.	
		schwarz black		

WICLINE 75

Dichtungen Meterware
Gaskets metre ware

Zubehör
Accessories

Artikel Article	VE PU	Anwendung Application	Bezeichnung / Hinweise Designation / Indications	Abbildung Figure
		Material / Material Farbe / Colour	Zuordnung Assignment	
4910048	50 m 50 m	WICLINE 75	Dichtung für Dehnfugen Universell in Dehnstoßprofilen einsetzbar. Dehnnut 12,8 mm.	
		EPDM	Gasket for expansion grooves Universal application in expansion joint profiles. Expansion groove 12,8 mm	
		schwarz black	1910170,1917062,1917064,1917067,1917256 1917258,1917259,1917260	
4910065	20 m 20 m	WICLINE 75	Schwelldichtung Mit Eckstück 4920076 dicht einkleben.	
		EPDM	Threshold gasket Glue compact with corner parts 4920076.	
		schwarz black	1917304,1917305,4910016	
4910041	50 m 50 m	WICLINE 75	Anschlagdichtung Verkleben mit Formecken 4920028 bzw. 4920029	
		EPDM	Stop gasket Glue with moulded gasket angles 4920028 respectively 4920029.	
		schwarz black		
4910066	20 m 20 m	WICLINE 75	Anschlagdichtung Für Fenstertüre. Mit Eckstücken dicht verkleben.	
		EPDM, geschäumt EPDM, foamed	Stop gasket For casement door. Glue tightly with corner parts.	
		schwarz black	3991239	
4910068	30 m 30 m	WICLINE 75	Dichtung Mitteldichtung für Schwing- Wendefenster	
		EPDM	Gasket Centre gasket for pivot window	
		schwarz black	3910040,5960016	

WICLINE 75

Dichtungen Meterware

Gaskets metre ware





Zubehör
Accessories

Artikel Article	VE PU	Anwendung Application	Bezeichnung / Hinweise Designation / Indications	Abbildung Figure
		Material / Material Farbe / Colour	Zuordnung Assignment	
4910069	200 m 200 m	WICLINE 75	Anschlagdichtung	
		EPDM	Stop gasket	
		schwarz black	1917161,1917161,1917163,1917163	
4910070	100 m 100 m	WICLINE 75	Dichtrundschnur D=3 mm Universell einsetzbar. Zum Abdichten von Aufsatzprofilen.	
		EPDM, geschäumt EPDM, foamed	Sealing cord D=3 mm Universal application. For sealing supplementary profiles.	
		schwarz black	1917121	
4910040	100 m 100 m	WICLINE 75	Dichtrundschnur D=4.5 mm Universell einsetzbar. Zum Abdichten von Aufsatzprofilen.	
		EPDM	Sealing cord D=4.5 mm Universal application. For sealing supplementary profiles.	
		schwarz black		
4010114	100 m 100 m	WICLINE 75	Dichtschnur, D = 5,3 mm Zum Abdichten von Aufsatzprofilen.	
		EPDM, geschäumt EPDM, foamed	Sealing cord, D = 5.3 mm For sealing supplementary profiles.	
		schwarz black		
4010117	100 m 100 m	WICLINE 75	Schlauchdichtung D=4 mm. Zum Abdichten von Aufsatzprofilen.	
		Silikon Silicone	Tubular gasket D=4 mm. For sealing supplementary profiles.	
		weiß white		

WICLINE 75

Dichtungen Meterware
Gaskets metre ware

Zubehör
Accessories

Artikel Article	VE PU	Anwendung Application	Bezeichnung / Hinweise Designation / Indications	Abbildung Figure
		Material / Material Farbe / Colour	Zuordnung Assignment	
4010494	30 m 30 m	WICLINE 75	Mitteldichtung für Stulpfenster Oberflächenbehandlung: polymerisiert	
		EPDM	Centre gasket for double casement window Surface treatment: polymerized	
			1017120,1017124,1017125,1017126	
4910016	30 m 30 m	WICLINE 75	Mitteldichtung Einsetzbar umlaufend als Meterware (gleit-polymerisiert) mit Verbindungsteil 4920018 oder mit Dichtungseckteilen 4920083. Einsetzbar in alle Blendrahmenprofile. Zuschnittsmaße +2,5% beachten!	
		EPDM	Centre Gasket Usable as continuous metre ware (glide polymerized) with junction part 4920018 or with corner gasket angles 4920083. Applicable in all frame profiles. Consider cutting dimension of +2,5%!	
		schwarz black	4910065,4920018,4920070,5060080,5960006	
4910073	30 m 30 m	WICLINE 75	Mitteldichtung für Stulpfenster Oberflächenbehandlung: polymerisiert	
		EPDM	Centre gasket for double casement window Surface treatment: polymerized	
		schwarz black	1917120,1917122,1917124,1917126	
4910076	20 m 20 m	WICLINE 75	Füllungssicherung Verwendung: Rahmenprofile, Kämpfer, Türen, einbruchhemmend, Zuschnitt 100 mm.	
		EPDM	Infill safeguard Application: frame profiles, transoms, door profiles, burglar resistance, cut to length 100mm.	
		schwarz black		
4910077	20 m 20 m	WICLINE 75	Füllungssicherung Verwendung: Flügelprofil	
		EPDM	Infill safeguard Application: sash profile	
		schwarz black		

WICLINE 75

Dichtungen Meterware

Gaskets metre ware



Zubehör
Accessories

Artikel Article	VE PU	Anwendung Application	Bezeichnung / Hinweise Designation / Indications	Abbildung Figure
		Material / Material Farbe / Colour	Zuordnung Assignment	
4910081	50 m 50 m	WICLINE 75	Kederdichtung Als Abdichtung zwischen Grundprofil und Aufsatzprofil	
		EPDM	Profile joint gasket As sealant between base profile and supplement profile	
		schwarz black	1917165,1917166,1917167	

WICLINE 75

Dichtungen Stückware
Gaskets single parts





Zubehör
Accessories

Artikel Article	VE PU	Anwendung Application	Bezeichnung / Hinweise Designation / Indications	Abbildung Figure
		Material / Material Farbe / Colour	Zuordnung Assignment	
4920070	1 St. 1 pcs	WICLINE 75	Vulkanisierter Dichtungsrahmen Vulkanisierter Dichtungsrahmen, bestehend aus 4910057. Alternativ zur Mitteldichtung 4910016 einsetzbar! Lieferzeit anfragen. Bestellformular anfordern. Oberflächenbehandlung: gleitpolymerisiert	
		EPDM	Vulcanized gasket frame Vulcanized gasket consisting of 4910057, alternative to centre gasket 4910016. Ask for delivery time. Request order form. Surface treatment: glide-polymerized	
		schwarz black		
		4910016		
4920082	1 St. 1 pcs	WICLINE 75	Vulkanisierter Dichtungsrahmen Vulkanisierter Dichtungsrahmen, bestehend aus 4910057. Alternativ zur Mitteldichtung 4910016 einsetzbar! Lieferzeit anfragen. Bestellformular anfordern. Oberflächenbehandlung: trocken	
		EPDM	Vulcanized gasket frame Vulcanized gasket frame, consisting of 4910057. Alternative to centre gasket 4910016! Ask for delivery time. Request order form. Surface treatment: dry	
		schwarz black		
4920111	1 St. 1 pcs	WICLINE 75	Vulkanisierter Dichtungsrahmen Vulkanisierter Dichtungsrahmen, bestehend aus 4910093. Lieferzeit anfragen. Bestellformular anfordern. Oberflächenbehandlung: trocken. Achtung: Dichtungsrahmen nur für Parallel-Schiebe-Kipp (PSK) oder Brandschutzfenster einsetzbar.	
		EPDM	Vulcanized gasket frame Vulcanized gasket consisting of 4910093. Ask for delivery time. Request order form. Surface treatment: dry. Usage for PSK-window (door) or fire protection window.	
		schwarz black		

WICLINE 75

Dichtungen Stückware
Gaskets single parts





Zubehör
Accessories

Artikel Article	VE PU	Anwendung Application	Bezeichnung / Hinweise Designation / Indications	Abbildung Figure
		Material / Material Farbe / Colour	Zuordnung Assignment	
4020005	1 St. 1 pcs	WICLINE 75	Vulkanisierter Dichtungsrahmen Spalt 3 mm. Vulkanisierter Rahmen, bestehend aus 4010054. Lieferzeit anfragen. Bestellformular anfordern. Oberflächenbehandlung: silikonisiert.	
		EPDM	Vulcanized gasket frame Gap 3 mm. Vulcanized gasket frame, consisting of 4010054. Ask for delivery time. Demand for order form. Surface treatment: siliconized.	
		schwarz black		
4020422	1 St. 1 pcs	WICLINE 75	Vulkanisierter Dichtungsrahmen Spalt 3 mm. Vulkanisierter Rahmen, bestehend aus 4010054. Lieferzeit anfragen. Bestellformular anfordern. Oberflächenbehandlung: nicht silikonisiert.	
		EPDM	Vulcanized gasket frame Gap 3 mm. Vulcanized gasket frame, consisting of 4010054. Ask for delivery time. Request order form. Surface treatment: not siliconized.	
		schwarz black		
4020114	1 St. 1 pcs	WICLINE 75	Vulkanisierter Dichtungsrahmen Spalt 5 mm Vulkanisierter Rahmen, bestehend aus 4010081. Lieferzeit anfragen. Bestellformular anfordern. Oberflächenbehandlung: silikonisiert	
		EPDM	Vulcanized gasket frame Gap 5 mm. Vulcanized gasket frame, consisting of 4010081. Ask for delivery time. Request order form. Surface treatment: siliconized	
		schwarz black		
4020425	1 St. 1 pcs	WICLINE 75	Vulkanisierter Dichtungsrahmen Spalt 5 mm. Vulkanisierter Rahmen, bestehend aus 4010081. Lieferzeit anfragen. Bestellformular anfordern. Oberflächenbehandlung: nicht silikonisiert	
		EPDM	Vulcanized gasket frame Gap 5 mm. Vulcanized gasket frame, consisting of 4010081. Ask for delivery time. Request order form. Surface treatment: not siliconized	
		schwarz black		

WICLINE 75

Dichtungen Stückware
Gaskets single parts



Zubehör
Accessories

Artikel Article	VE PU	Anwendung Application	Bezeichnung / Hinweise Designation / Indications	Abbildung Figure
		Material / Material Farbe / Colour	Zuordnung Assignment	
4020637	1 St. 1 pcs	WICLINE 75	Vulkanisierter Dichtungsrahmen bestehend aus 4010484, gleitpolymerisiert	
		EPDM	Vulcanized gasket frame consisting of 4010484, glide-polymerized	
		schwarz black		
4020132	1 St. 1 pcs	WICLINE 75	Vulkanisierter Dichtungsrahmen Vulkanisierter Rahmen, bestehend aus 4010065. Lieferzeit anfragen. Bestellformular anfordern. Oberflächenbehandlung: silikonisiert.	
		EPDM	Vulcanized gasket frame Vulcanized gasket frame, consisting of 4010065. Ask for delivery time. Request order form. Surface treatment: siliconized.	
		schwarz black		
4020426	1 St. 1 pcs	WICLINE 75	Vulkanisierter Dichtungsrahmen Vulkanisierter Rahmen, bestehend aus 4010065. Lieferzeit anfragen. Bestellformular anfordern. Oberflächenbehandlung: nicht silikonisiert.	
		EPDM	Vulcanized gasket frame Vulcanized gasket frame, consisting of 4010065. Aks for delivery time. Request order form. Surface treatment: not siliconized.	
		schwarz black		
4920048	1 St. 1 pcs	WICLINE 75	Vulkanisierter Dichtungsrahmen Vulkanisierter Dichtungsrahmen für Spalt 4,5 mm, bestehend aus 4910059. Lieferzeit anfragen. Bestellformular anfordern. Oberflächenbehandlung: silikonisiert.	
		EPDM	Vulcanized gasket frame Vulcanized gasket frame for 4,5 mm gap, consisting of 4910059. Ask for delivery time. Request order forms. Surface treatment: siliconized.	
		schwarz black		

WICLINE 75

Dichtungen Stückware
Gaskets single parts



Zubehör
Accessories

Artikel Article	VE PU	Anwendung Application	Bezeichnung / Hinweise Designation / Indications	Abbildung Figure
		Material / Material Farbe / Colour	Zuordnung Assignment	
4920053	1 St. 1 pcs	WICLINE 75	Vulkanisierter Dichtungsrahmen Vulkanisierter Dichtungsrahmen für Spalt 4,5 mm, bestehend aus 4910059. Lieferzeit anfragen. Bestellformular anfordern. Oberflächenbehandlung: nicht silikonisiert.	
		EPDM	Vulcanized gasket frame Vulcanized gasket frame for 4,5 mm gap, consisting of 4910059. Ask for delivery time. Request order form. Surface treatment: not siliconized.	
		schwarz black		
4920049	1 St. 1 pcs	WICLINE 75	Vulkanisierter Dichtungsrahmen Vulkanisierter Dichtungsrahmen für Spalt 6,5 mm, bestehend aus 4910060. Lieferzeit anfragen. Bestellformular anfordern. Oberflächenbehandlung: silikonisiert.	
		EPDM	Vulcanized gasket frame Vulcanized gasket frame for 6,5 mm gap, consisting of 4910060. Ask for delivery time. Request order forms. Surface treatment: siliconized.	
		schwarz black		
4920054	1 St. 1 pcs	WICLINE 75	Vulkanisierter Dichtungsrahmen Vulkanisierter Dichtungsrahmen für Spalt 6,5 mm, bestehend aus 4910060. Lieferzeit anfragen. Bestellformular anfordern. Oberflächenbehandlung: nicht silikonisiert.	
		EPDM	Vulcanized gasket frame Vulcanized gasket frame for 6,5 mm gap, consisting of 4910060. Ask for delivery time. Request order form. Surface treatment: not siliconized.	
		schwarz black		

WICLINE 75

Dichtungen Stückware
Gaskets single parts



Zubehör
Accessories

Artikel Article	VE PU	Anwendung Application	Bezeichnung / Hinweise Designation / Indications	Abbildung Figure
		Material / Material Farbe / Colour	Zuordnung Assignment	
4920050	1 St. 1 pcs	WICLINE 75	Vulkanisierter Dichtungsrahmen Vulkanisierter Dichtungsrahmen für Spalt 8,5 mm, bestehend aus 4910061. Lieferzeit anfragen. Bestellformular anfordern. Oberflächenbehandlung: silikonisiert.	
		EPDM	Vulcanized gasket frame Vulcanized gasket frame for 8,5 mm gap, consisting of 4910061. Ask for delivery time. Request order form. Surface treatment: siliconized.	
		schwarz black		
4920055	1 St. 1 pcs	WICLINE 75	Vulkanisierter Dichtungsrahmen Vulkanisierter Dichtungsrahmen für Spalt 8,5 mm, bestehend aus 4910061. Lieferzeit anfragen. Bestellformular anfordern. Oberflächenbehandlung: nicht silikonisiert.	
		EPDM	Vulcanized gasket frame Vulcanized gasket frame for 8,5 mm gap, consisting of 4910061. Ask for time of delivery. Request order form. Surface treatment: not siliconized.	
		schwarz black		
4920051	1 St. 1 pcs	WICLINE 75	Vulkanisierter Dichtungsrahmen Vulkanisierter Dichtungsrahmen für Spalt 10,5 mm, bestehend aus 4910062. Lieferzeit anfragen. Bestellformular anfordern. Oberflächenbehandlung: silikonisiert.	
		EPDM	Vulcanized gasket frame Vulcanized gasket frame for 10,5 mm gap, consisting of 4910062. Ask for delivery time. Request order form. Surface treatment: siliconized.	
		schwarz black		

WICLINE 75

Dichtungen Stückware
Gaskets single parts



Zubehör
Accessories

Artikel Article	VE PU	Anwendung Application	Bezeichnung / Hinweise Designation / Indications	Abbildung Figure
		Material / Material Farbe / Colour	Zuordnung Assignment	
4920056	1 St. 1 pcs	WICLINE 75	Vulkanisierter Dichtungsrahmen Vulkanisierter Dichtungsrahmen für Spalt 10,5 mm, bestehend aus 4910062. Lieferzeit anfragen. Bestellformular anfordern. Oberflächenbehandlung: nicht silikonisiert.	
		EPDM	Vulcanized gasket frame Vulcanized gasket frame for 10,5 mm gap, consisting of 4910062. Ask for delivery time: Request order form. Surface treatment: not siliconized.	
		schwarz black		
4020133	1 St. 1 pcs	WICLINE 75	Vulkanisierter Dichtungsrahmen Vulkanisierter Dichtungsrahmen für Spalt 11 mm, bestehend aus 4010082. Lieferzeit anfragen. Bestellformular anfordern. Oberflächenbehandlung silikonisiert.	
		EPDM	Vulcanized gasket frame Vulcanized gasket frame for 11 mm gap, consisting of 4010082. Ask for delivery time. Request order form. Surface treatment siliconized.	
		schwarz black		
4020427	1 St. 1 pcs	WICLINE 75	Vulkanisierter Dichtungsrahmen Vulkanisierter Dichtungsrahmen für Spalt 11 mm, bestehend aus 4010082. Lieferzeit anfragen. Bestellformular anfordern. Oberflächenbehandlung: nicht silikonisiert	
		EPDM	Vulcanized gasket frame Vulcanized gasket frame for Gap 11 mm, consisting of 4010082. Ask for delivery time. Request order form. Surface treatment: not siliconized	
		schwarz black		

WICLINE 75

Dichtungen Stückware
Gaskets single parts



Zubehör
Accessories

Artikel Article	VE PU	Anwendung Application	Bezeichnung / Hinweise Designation / Indications	Abbildung Figure
		Material / Material Farbe / Colour	Zuordnung Assignment	
4920052	1 St. 1 pcs	WICLINE 75	Vulkanisierter Dichtungsrahmen Vulkanisierter Dichtungsrahmen für Spalt 12,5 mm, bestehend aus 4910063. Lieferzeit anfragen. Bestellformular anfordern. Oberflächenbehandlung: silikonisiert.	
		EPDM	Vulcanized gasket frame Vulcanized gasket frame for 12,5 mm gap, consisting of 4910063. Ask for delivery time. Request order form. Surface treatment: siliconized.	
		schwarz black		
4920057	1 St. 1 pcs	WICLINE 75	Vulkanisierter Dichtungsrahmen Vulkanisierter Dichtungsrahmen für Spalt 12,5 mm, bestehend aus 4910063. Lieferzeit anfragen. Bestellformular anfordern. Oberflächenbehandlung: nicht silikonisiert.	
		EPDM	Vulcanized gasket frame Vulcanized gasket frame for 12,5 mm gap, consisting of 4910063. Ask for delivery time. Request order forms. Surface treatment: not siliconized.	
		schwarz black		
4020006	100 St. 100 pcs	WICLINE 75	Federstück Bei pulverbeschichteten Glasleistenprofilen. Federstücke 15 mm lang. Als Montagehilfe jeweils an den Enden der Glasleisten und mittig einlegen. Anwendung ab 15 mm Glasleistenbreite.	
		EPDM	Spring piece For powder coated glazing beads. Length of spring piece 15 mm. Insert spring pieces at the respective ends of glazing beads and in the centre as assembly help. Application above 15 mm glazing bead width.	
		schwarz black		

WICLINE 75

Dichtungen Stückware
Gaskets single parts

Zubehör
Accessories

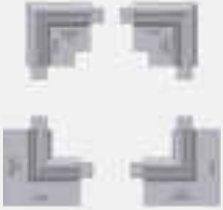
Artikel Article	VE PU	Anwendung Application	Bezeichnung / Hinweise Designation / Indications	Abbildung Figure
		Material / Material Farbe / Colour	Zuordnung Assignment	
4020580	50 St. 50 pcs	WICLINE 75	Formecke Mit Mitteldichtung 4010436 stoßen und verkleben. Zuschnittsmaße Mitteldichtung +1% beachten!	
		EPDM	Moulded gasket angle Glued butt-joint with centre gasket 4010436. Consider the cutting dimension of centre gasket +1%!	
		schwarz black		
4920083	100 St. 100 pcs	WICLINE 75	Formecke für Mitteldichtung 4910016, ohne Verklebung stoßen, Zuschnittsmaße Mitteldichtung +2,5% beachten!	
		EPDM	Moulded gasket corner angle Butt joint with centre gasket 4910016 without glueing. Consider the cutting dimension of centre gasket +2,5%!	
		schwarz black		
4920085	1 Garn. 1 set	WICLINE 75	Garnitur Formecken, für auswärts öffnende Flügel Mit Mitteldichtung 4910016 stoßen und abdichten, Zuschnittsmaße Mitteldichtung +2,5%.	
		EPDM	Set gasket corner parts, for outward opened sashes Gasket corner part with centre gasket 4910016 with sealant. Length of centre gasket + 2,5%.	
		schwarz black	1917161,1917163	
4920098	1 Garn. 1 set	WICLINE 75	Garnitur Formecken Mit Schwing-Wende-Dichtung 4910068 stoßen und verkleben, Zuschnittsmaße Mitteldichtung +1,0% beachten!	
		EPDM	Set gasket corner parts Gasket angle with horizontal / vertical pivot gasket 4910068 with glue. Length of centre gasket +1,0%!	
		schwarz black	3910040	

WICLINE 75

Dichtungen Stückware
Gaskets single parts



Zubehör
Accessories

Artikel Article	VE PU	Anwendung Application	Bezeichnung / Hinweise Designation / Indications	Abbildung Figure
		Material / Material Farbe / Colour	Zuordnung Assignment	
4920076	1 Garn. 1 set	WICLINE 75	Garnitur Eckstücke Für Fenstertüre einwärtsöffnend mit Schwelle. Eckstücke mit 4910016 und 4910065, Abschlussteil mit 4910066 dicht verkleben.	
		EPDM	Set corner parts For casement door inwards opening with threshold. Glue tightly: corner part with 4910016 and 4910065, end part with 4910066.	
		schwarz black		
4920018	100 St. 100 pcs	WICLINE 75	Verbindungsstück für Mitteldichtung 4910016. Zuschnittsmaße Mitteldichtung +2,5% beachten!	
		EPDM	Connecting piece for center gasket 4910016. Consider the cutting dimension of center gasket +2,5%!	
		schwarz black	4910016	
4920019	100 St. 100 pcs	WICLINE 75	Versiegelungsvorlage Klassik-Design Offene Profillfugen in Verbindung mit Kämpferstoßhinterlegungsteilen an den Kämpferstößen mit Versiegelung abdichten!	
		EPDM, geschäumt EPDM, foamed	Backing for sealing, Classic design Seal open profile grooves with sealant at the transom joints with backing for sealing.	
		schwarz black	1917009,1917334	
4020662	50 St. 50 pcs	WICLINE 75	Dichtteil für Dämmauflage Blendrahmen Zum Abdichten des Kopplungstoßes (Blendrahmen), in Verwendung mit Dämmauflage 4030365	
		EPDM, geschäumt EPDM, foamed	Sealing part for frame thermal break support For sealing of the coupling joint (frame), use with thermal break support 4030365	
		roh untreated		
4920105	20 St. 20 pcs	WICLINE 75	Dichtteil für Dämmauflage Blendrahmen Zum Abdichten des Kopplungstoßes (Blendrahmen), in Verwendung mit Dämmauflage 4930044, 4930045.	
		EPDM, geschäumt EPDM, foamed	Sealing part for frame thermal break support For sealing of the coupling joint (frame), use with thermal break support 4930044, 4930045	
		roh untreated		

WICLINE 75

Dichtungen Stückware
Gaskets single parts





Zubehör
Accessories

Artikel Article	VE PU	Anwendung Application	Bezeichnung / Hinweise Designation / Indications	Abbildung Figure
		Material / Material Farbe / Colour	Zuordnung Assignment	
4920029	50 St. 50 pcs	WICLINE 75	Dichtungsecke Für Blendrahmenprofile. Mit Anschlagdichtung 4910041 verkleben.	
		EPDM	Gasket angle For frame profile. Glue with stop gasket 4910041.	
		schwarz black		
4920086	1 St. 1 pcs	WICLINE 75	Garnitur Kopfstücke Für Fenstertüre einwärtsöffnend mit Schwelle. Gehflügel rechts. Geschraubt mit 4070066. Mit 4910066 dicht verkleben. Mit Versiegelung Teile fixieren.	
		EPDM	Set head pieces For casement door inwards opening with threshold. Active leaf right hand side. Screwed with 4070066. Glue tightly with 4910066. Fixing with sealant.	
		schwarz black	3991239	
4920087	1 St. 1 pcs	WICLINE 75	Garnitur Kopfstücke Für Fenstertüre einwärtsöffnend mit Schwelle. Gehflügel links. Geschraubt mit 4070066. Mit 4910066 dicht verkleben. Mit Versiegelung Teile fixieren.	
		EPDM	Set head pieces For casement door inwards opening with threshold. Active leaf left hand side. Screwed with 4070066. Glue tightly with 4910066. Fixing with sealant.	
		schwarz black	3991239	

WICLINE 75

Kunststoffprofile, Formstücke
Plastic profiles, moulded pieces





Zubehör
Accessories

Artikel Article	VE PU	Anwendung Application	Bezeichnung / Hinweise Designation / Indications	Abbildung Figure
		Material / Material Farbe / Colour	Zuordnung Assignment	
188413	1 St. 1 pcs	WICLINE 75	Entwässerungsschlauch Zur Entwässerung und Dampfdruckausgleich, z.B. am Fußpunkt. Bohrung Ø 10 mm. Zum Einsatz für die verdeckte Entwässerung durch den Kämpfer. Einsetzen nur mit 4940187!	
		EPDM	Drainage tube For drainage and air pressure equalization e.g. at the base point. Drilling Ø 10 mm. For concealed drainage through transom. Applicable only with 4940187!	
		schwarz black		
188719	3 m 3 m	WICLINE 75	Dämmprofil Universell einsetzbar.	
		PA	Thermal break profile Universal application.	
		schwarz black		
197157	100 St. 100 pcs	WICLINE 75	Entwässerungsabdeckung Zum Dampfdruckausgleich und Entwässerung der Dichtungsvorkammer. Wandung 3 - 5 mm.	
			Weephole cover For air pressure equalization and drainage of gasket prechamber. Profile wall thickness: 3 - 5 mm.	
		schwarz black		
197158	100 St. 100 pcs	WICLINE 75	Entwässerungsabdeckung Zum Dampfdruckausgleich und Entwässerung der Dichtungsvorkammer. Wandung 3 - 5 mm.	
			Weephole cover For air pressure equalization and drainage of gasket prechamber. Profile wall thickness: 3 - 5 mm.	
		weiß white		

WICLINE 75

Kunststoffprofile, Formstücke
Plastic profiles, moulded pieces





Zubehör
Accessories

Artikel Article	VE PU	Anwendung Application	Bezeichnung / Hinweise Designation / Indications	Abbildung Figure
		Material / Material Farbe / Colour	Zuordnung Assignment	
197159	100 St. 100 pcs	WICLINE 75	Entwässerungsabdeckung Zum Dampfdruckausgleich und Entwässerung der Dichtungsvorkammer. Wandung 3 - 5 mm.	
			Weephole cover For air pressure equalization and drainage of gasket prechamber. Profile wall thickness: 3 - 5 mm.	
		grau grey		
4020049	100 St. 100 pcs	WICLINE 75	Federstück Bei eloxierten Glasleistenprofilen. Federstücke 15 mm lang. Als Montagehilfe ca. 50 mm von den Glasleistenenden und jede weitere Abstände 250 - 300 mm. Anwendung ab 15 mm Glasleistenbreiten.	
		PA	Spring piece For anodized glazing beads. Length of spring piece 15 mm. Insert spring pieces approx. 50 mm from the respective ends of glazing beads as assembly help and every further distances of 250 - 300 mm. Application above 15 mm glazing bead width.	
		schwarz black		
4030001	6 m 6 m	WICLINE 75	Glasleiste Einsatz bei verdeckten Flügeln.	
		PA	Glazing bead Application in concealed sashes.	
		schwarz black		
4030019	3 m 3 m	WICLINE 75	Abdeckprofil Zum Abdecken der Glasleistennut.	
		Kunststoff Plastic	Cover profile To cover the glazing bead retaining groove.	
		schwarz black		

WICLINE 75

Kunststoffprofile, Formstücke
Plastic profiles, moulded pieces

Zubehör
Accessories

Artikel Article	VE PU	Anwendung Application	Bezeichnung / Hinweise Designation / Indications	Abbildung Figure
		Material / Material Farbe / Colour	Zuordnung Assignment	
4030022	3 m 3 m	WICLINE 75	Abdeckprofil Zum Abdecken der Dehnnut.	
		Kunststoff Plastic	Cover profile To cover the expansion joint groove.	
		schwarz black		
4030026	3 m 3 m	WICLINE 75	Halter Halter für Bauanschlussprofil, in Verbindung mit 4010046 einsetzbar.	
		Kunststoff Plastic	Wedge gasket Wedge gasket for junction to structure profile 4010046.	
		schwarz black		
4030035	4 m 4 m	WICLINE 75	Federprofil Verwendung: Glasleistennut für Außen- und Innenanwendung. Lieferung mit vormontierter Dichtung.	
		ABS	Spring profile Application: Glazing bead retaining groove. For external and internal use. Delivery with pre-assembled gasket.	
		schwarz black		
4030036	4 m 4 m	WICLINE 75	Federprofil Verwendung: Dehnnut Für Außen- und Innenanwendung Lieferung mit vormontierter Dichtung Kurzstücke nicht zugelassen	
		ABS	Spring profile Application: Expansion joint groove. For external and internal use. Delivery with pre-assembled gasket. Short pieces are not admissible.	
		schwarz black		
4030038	20 m 20 m	WICLINE 75	Einlage für Rolladenführung Gegen Abrutschen sichern.	
		PE	Inlay for shutter guide profile Secure against slipping.	

WICLINE 75

Kunststoffprofile, Formstücke
Plastic profiles, moulded pieces



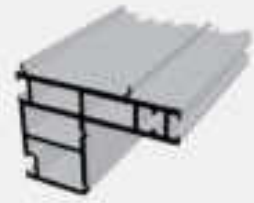

Zubehör
Accessories

Artikel Article	VE PU	Anwendung Application	Bezeichnung / Hinweise Designation / Indications	Abbildung Figure
		Material / Material Farbe / Colour	Zuordnung Assignment	
4030039	20 m 20 m	WICLINE 75	Einlage für Rolladenführung Gegen Abrutschen sichern.	
		PE	Inlay for shutter guide profile Secure against slipping.	
4030040	3 m 3 m	WICLINE 75	Kunststoffleitprofil Wahlweise als Kurzstücke, 100 mm lang. An beiden Enden und in der Mitte möglich. Zuordnung: 3091046	
		Kunststoff Plastic	Plastic guide profile Selectively as short pieces, length 100 mm. Applicable on both ends and in the centre. Assignment: 3091046	
		schwarz black		
4030043	20 m 20 m	WICLINE 75	Einlage Gegen Abrutschen sichern.	
		Kunststoff Plastic	Inlay Secure against slipping.	
		schwarz black		
4030365	6,5 m 6,5 m	WICLINE 75	Dämmauflage Blendrahmen Bei Elementmontage, Einhebeweg von oben beachten! Dämmauflage klipsbar.	
		Kunststoff Plastic	Thermal break support for frame Pay attention to lifting mode while assembling element! Thermal break support is with clipsfunction.	
4040008	100 St. 100 pcs	WICLINE 75	Vorklotz Verwendung: Für alle Überschlagsflügel Klassik-Design. Gegen Abrutschen sichern!	
		PA	Glazing support Application: For all sash classic design profiles. Secure against slipping!	
		schwarz black		

WICLINE 75

Kunststoffprofile, Formstücke
Plastic profiles, moulded pieces





Zubehör
Accessories

Artikel Article	VE PU	Anwendung Application	Bezeichnung / Hinweise Designation / Indications	Abbildung Figure
		Material / Material Farbe / Colour	Zuordnung Assignment	
4040087	100 St. 100 pcs	WICLINE 75	Vorklotz Verwendung: Für alle Überschlagsflügel Industrial Design! Gegen Abrutschen sichern!	
		PA	Glazing support Application: For all Industrial Design sash profiles! Secure against slipping!	
4940078	100 St. 100 pcs	WICLINE 75	Vorklotz Verwendung: Für alle Überschlagsflügel! Gegen Abrutschen sichern!	
		PA	Glazing support Application: For all sash profiles! Secure against slipping!	
		schwarz black		
4940079	100 St. 100 pcs	WICLINE 75	Vorklotz Verwendung: Für alle Fensterrahmenprofile und Türflügelprofile! Gegen Abrutschen sichern!	
		PA	Glazing support Application: For window frame profiles and door leaf profiles. Secure against slipping.	
		schwarz black		
4940090	100 St. 100 pcs	WICLINE 75	Vorklotz Verwendung: Blendrahmenprofil Klassik-Design. Gegen Abrutschen sichern.	
		PA	Glazing support Application: For classic design frame profile. Secure against slipping.	
		schwarz black		
4040026	100 St. 100 pcs	WICLINE 75	Entwässerungsabdeckung Zum Dampfdruckausgleich und Entwässerung der Dichtungsvorkammer.	
		PA	Weephole cover For air pressure equalization and drainage of gasket prechamber.	
		schwarz black		

WICLINE 75

Kunststoffprofile, Formstücke
Plastic profiles, moulded pieces

Zubehör
Accessories

Artikel Article	VE PU	Anwendung Application	Bezeichnung / Hinweise Designation / Indications	Abbildung Figure
		Material / Material Farbe / Colour	Zuordnung Assignment	
4040027	100 St. 100 pcs	WICLINE 75	Entwässerungsabdeckung Zum Dampfdruckausgleich und Entwässerung der Dichtungsvorkammer.	
		PA	Weep hole cover For air pressure equalization and drainage of gasket prechamber.	
		weiß white		
4040028	100 St. 100 pcs	WICLINE 75	Entwässerungsabdeckung Zum Dampfdruckausgleich und Entwässerung der Dichtungsvorkammer.	
		PA	Weep hole cover For air pressure equalization and drainage of gasket prechamber.	
		grau grey		
4040029	50 St. 50 pcs	WICLINE 75	Endstück Wetterschenkel links In Profil einkleben. Längenkorrektur gesamt = - 8 mm.	
		ABS	End piece weather bar left Glue into profile. Total length correction = - 8 mm.	
		schwarz black	3091045,3991239	
4040030	50 St. 50 pcs	WICLINE 75	Endstück Wetterschenkel rechts In Profil einkleben. Längenkorrektur gesamt = - 8 mm.	
		ABS	End piece weather bar, right Glue into profile. Total length correction: - 8 mm.	
		schwarz black	3091045,3991239	
4040036	1 St. 1 pcs	WICLINE 75	Klotzbrücke Verwendung: Für alle Rahmenprofile mit Festverglasung, Falz 44. Gegen Abrutschen sichern!	
		PA	Shim bridge Application: For all frame profiles with fixed glazing, rebate 44 mm. Secure against slipping!	
		schwarz black		

WICLINE 75

Kunststoffprofile, Formstücke
Plastic profiles, moulded pieces



Zubehör
Accessories

Artikel Article	VE PU	Anwendung Application	Bezeichnung / Hinweise Designation / Indications	Abbildung Figure
		Material / Material Farbe / Colour	Zuordnung Assignment	
4040037	10 Garn. 10 set	WICLINE 75	Einlauftrichter Spaltfrei an Führungsprofil stoßen, verschrauben und verkleben. Zuordnung: 3091048, 3091049	
		PA	Inlet funnel Apply glue, insert into guide profile and screw. Assignment: 3091048, 3091049.	
		schwarz black		
4040040	10 Garn. 10 set	WICLINE 75	Einlauftrichter Spaltfrei an Führungsprofil stoßen, verschrauben und verkleben. Zuordnung: 3091051	
			Inlet funnel Apply glue, insert into guide profile and screw. Assignment 3091051.	
		schwarz black		
4040086	100 St. 100 pcs	WICLINE 75	Abdeckkappe Bohrung Ø12 mm.	
		ABS	Cover cap Borehole Ø12 mm.	
		schwarz black		
4040088	100 St. 100 pcs	WICLINE 75	Abdeckkappe Bohrung Ø10 mm.	
		PE	Cover cap Borehole Ø10 mm.	
		schwarz black		
4040682	20 St. 20 pcs	WICLINE 75	Eckstück für Lüftungsklappe	
		PA	Corner part for ventilation flap	
		schwarz black		

WICLINE 75

Kunststoffprofile, Formstücke
Plastic profiles, moulded pieces





Zubehör
Accessories

Artikel Article	VE PU	Anwendung Application	Bezeichnung / Hinweise Designation / Indications	Abbildung Figure
		Material / Material Farbe / Colour	Zuordnung Assignment	
4040729	50 Paar 50 pair	WICLINE 75	Endkappe Abdeckprofil 100 mm Zur unteren Abdichtung Abdeckprofil 100 mm	
			End caps for flashing 100 mm For lower sealing of 100 mm flashing profile	
		roh untreated		
4040730	50 Paar 50 pair	WICLINE 75	Endkappe Abdeckprofil 120 mm Zur unteren Abdichtung Abdeckprofil 120 mm	
			End caps for flashing 120 mm For lower sealing of 120 mm flashing profile	
		roh untreated		
4040731	50 Paar 50 pair	WICLINE 75	Endkappe Abdeckprofil 140 mm Zur unteren Abdichtung Abdeckprofil 140 mm	
			End caps for flashing 140 mm For lower sealing of 140 mm flashing profile	
		roh untreated		
4040732	50 Paar 50 pair	WICLINE 75	Endkappe Abdeckprofil 160 mm Zur unteren Abdichtung Abdeckprofil 160 mm	
			End caps for flashing 160 mm For lower sealing of 160 mm flashing profile	
		roh untreated		
4070030	100 St. 100 pcs	WICLINE 75	Leitteil für Injektion In Stoßverbinder stecken für Klebereinspritzung	
		PA	Injection guide part Insert in butt connector for glue injection	

WICLINE 75

Kunststoffprofile, Formstücke
Plastic profiles, moulded pieces





Zubehör
Accessories

Artikel Article	VE PU	Anwendung Application	Bezeichnung / Hinweise Designation / Indications	Abbildung Figure
		Material / Material Farbe / Colour	Zuordnung Assignment	
4930047	6,5 m 6,5 m	WICLINE 75	Aufsatzprofil als Einspannblendrahmen Verwendung: Aufsatzprofil für Blendrahmenprofile zur Einspannung in WICTEC Serie. Nur in Verbindung mit 4010180 einzusetzen!	
		PA	Supplementary clamping profile Application: Supplementary profile of frame profiles for clamping in WICTEC series. Only use in connection with gasket 4010180.	
		schwarz black	1917001,1917002,1917003,1917004,1917005 1917055,1917056,1917057,1917058,1917059 1917060	
4940071	20 St. 20 pcs	WICLINE 75	Eckteil Mitteldichtung Einbau vor Montage der Mitteldichtung. Einsetzbar bei Profilen mit Falz 25 mm.	
		PA	Corner part for centre gasket Insert in the corner prior to mounting centre gasket. Applicable for profiles with 25 mm rebate.	
		schwarz black		
4940075	20 St. 20 pcs	WICLINE 75	Eckteil Mitteldichtung Einbau vor Montage der Mitteldichtung. Einsetzbar bei Profilen mit Falz 44 mm.	
		PA	Corner part for centre gasket. Insert in the corner prior to mounting centre gasket. Applicable for profiles with 44 mm rebate.	
		schwarz black		
4940474	20 St. 20 pcs	WICLINE 75	Eckteil Mitteldichtung Einbau vor Montage der Mitteldichtung. Einsetzbar bei Profilen mit Falz 25 mm und Mitteldichtungsrahmen 4920111, 4920112.	
		PA	Corner part for centre gasket Insert in the corner prior to mounting centre gasket. Applicable for profiles with 25 mm rebate and vulcanized gasket frame 4920111, 4920112.	
		schwarz black		

WICLINE 75

Kunststoffprofile, Formstücke
Plastic profiles, moulded pieces

Zubehör
Accessories

Artikel Article	VE PU	Anwendung Application	Bezeichnung / Hinweise Designation / Indications	Abbildung Figure
		Material / Material Farbe / Colour	Zuordnung Assignment	
4940072	20 St. 20 pcs	WICLINE 75	Gehrungs- und Kämpferstoßhinterlegungsteil Einsetzbar für Stoß- und Eckverbindung mit Falzmaß 25. Hinweis: Erforderlich für die Abdichtung beim T-Stoß.	
		PA	Backling part for mitre and butt-joints. Applicable for mitre and butt-joint connections with 25 mm rebate. Note: necessary for sealing T-joints.	
		schwarz black		
4940077	100 St. 100 pcs	WICLINE 75	Vorklotz Verwendung: Für alle Fensterrahmenprofile und Türflügelprofile! Gegen Abrutschen sichern!	
		PA	Glazing shim Application: For window frame profiles and door leaf profiles. Secure against slipping.	
		schwarz black		
4940083	20 St. 20 pcs	WICLINE 75	Gehrungs- und Kämpferstoßhinterlegungsteil Einsetzbar für Stoß- und Eckverbindung mit Falzmaß 44. Hinweis: Erforderlich für die Abdichtung beim T-Stoß.	
		PA	Backling part for mitre and transom butt-joints. Applicable for mitre and butt-joint connections with 44 mm rebate. Note: necessary for sealing T-joints.	
		schwarz black		
4940121	25 St. 25 pcs	WICLINE 75	Abdeckkappe für Mitteldichtung Einbau nach Einsetzen der Mitteldichtung. Einsetzbar bei Profilen mit Falz 25/44 mm und Mitteldichtung 4910016 und 4910017.	
		PA	Shutting part for centre gasket. Fit after the installation of the centre gasket. Use for profiles with 25/44 mm rebate and centre gasket 4910016 and 4910017.	

WICLINE 75

Kunststoffprofile, Formstücke
Plastic profiles, moulded pieces





Zubehör
Accessories

Artikel Article	VE PU	Anwendung Application	Bezeichnung / Hinweise Designation / Indications	Abbildung Figure
		Material / Material Farbe / Colour	Zuordnung Assignment	
4940171	50 St. 50 pcs	WICLINE 75	Befestigungsteil Bauanschlussbefestigung: HUS-S 7.5 Dübel Ø8 mm, M16 für Adjufix-Befestigung	
		PA	Fastening part For fixation of junction to structure: HUS-S 7.5 Dowel Ø8 mm, M16 for Adjufix fixation	
		schwarz black	1910148,1910170,1917001,1917002,1917003 1917004,1917005,1917055,1917056,1917057 1917058,1917059,1917060,1917062,1917064 1917067,1917081,1917082,1917086	
4940178	50 St. 50 pcs	WICLINE 75	Abstandshalterprofile Bei Kämpfer 1916220 und 1916224 zur Verbesserung der Maßhaltigkeit am Stabende einsetzbar.	
		PA	Spacer profile Can be used for transom 1917220 and 1917224 for a better dimensional accuracy at profile ends.	
		schwarz black		
4940187	20 St. 20 pcs	WICLINE 75	Entwässerungsteil, verdeckte Entwässerung, Falz 25 mm Einsetzbar für Blendrahmen- und Kämpferprofile bis Ansichtsbreite 140 mm! Nur mit 188413 einzusetzen!	
		PA	Drainage part for concealed drainage, rebate 25 mm Can be used for frame and transom profiles of up to 140 mm view width! Applicable only with 188413!	
		schwarz black	1910149,1917201,1917202,1917203,1917204 1917205,1917206,1917207,1917209	
4940493	10 St. 10 pcs	WICLINE 75	Entwässerungsteil, verdeckte Entwässerung, Falz 44 mm Einsetzbar für Blendrahmen- und Kämpferprofile bis Ansichtsbreite 140 mm. Nur mit 188413 einzusetzen.	
		PA	Drainage part for concealed drainage, rebate 44 mm. Can be used for frame and transom profiles up to 140 mm view width. Applicable only with 188413.	
		schwarz black	1917231,1917235	

WICLINE 75

Kunststoffprofile, Formstücke
Plastic profiles, moulded pieces





Zubehör
Accessories

Artikel Article	VE PU	Anwendung Application	Bezeichnung / Hinweise Designation / Indications	Abbildung Figure
		Material / Material Farbe / Colour	Zuordnung Assignment	
4940406	1 Garn. 1 set	WICLINE 75	Garnitur Schwellenverbinder Für Fenstertüre einwärtsöffnend. Geschraubt mit 2 x 4970087. Mit Versiegelung Teile fixieren.	
		PA	Set threshold connectors For casement door inwards opening. Screwed with 2 x 4970087. Fixing with sealant.	
		schwarz black	1917305	
4940408	1 Garn. 1 set	WICLINE 75	Garnitur Schwellenverbinder Für Fenstertüre auswärtsöffnend. Geschraubt mit 2 x 4970087. Mit Versiegelung Teile fixieren.	
		PA	Set threshold connectors For French window outwards opening. Screwed with 2 x 4970087. Fixation with sealant.	
		schwarz black	1917304	
4940426	1 Garn. 1 set	WICLINE 75	Garnitur Endkappen Für Fenstertüre auswärtsöffnend mit Schwelle. Geschraubt mit 4970073. Mit Versiegelung Teile fixieren.	
		PA	Set end caps For casement door outwards opening with threshold. Screwed with 4970073. Fixation with sealant.	
		schwarz black	3991240	
4940433	1 Garn. 1 set	WICLINE 75	Garnitur Kopf- und Endstücke Für Fenstertür auswärts öffnend zweiflügelig. Teile mit Versiegelung fixieren.	
		PA	Set Head and end pieces For casement door outward opening double sashes. Fixation with sealant.	
		schwarz black	1917167	
4940434	10 St. 10 pcs	WICLINE 75	Abschlussstück, rechts Für Fenstertüre auswärtsöffnend zweiflügelig mit Schwelle. Gehflügel rechts. Geschraubt mit 2 x 4070062. Mit Versiegelung Teile fixieren.	
		PA	End part, right For French window outwards opening double sashes with threshold. Active leaf right hand side. Screwed with 2 x 4070062. Fixation with sealant.	
		schwarz black	1917167,3991240	

WICLINE 75

Kunststoffprofile, Formstücke
Plastic profiles, moulded pieces





Zubehör
Accessories

Artikel Article	VE PU	Anwendung Application	Bezeichnung / Hinweise Designation / Indications	Abbildung Figure
		Material / Material Farbe / Colour	Zuordnung Assignment	
4940435	10 St. 10 pcs	WICLINE 75	Abschlussteil, links Für Fenstertüre auswärtsöffnend zweiflügelig mit Schwelle. Gehflügel links. Geschraubt mit 2 x 4070062. Mit Versiegelung Teile fixieren.	
		PA	End part, left For French window outwards opening double sashes with threshold. Active leaf left hand side. Screwed with 2 x 4070062. Fixation with sealant.	
		schwarz black	1917167,3991240	
4940440	5 Garn. 5 set	WICLINE 75	Garnitur Kopf- und Endstücke Für Stulpflügel Aufsatzprofil. Geschraubt mit 4070066 und 4070071. Mit Versiegelung Teile fixieren.	
		PA	Set head and end pieces For Double casement sash supplementary profile. Screwed with 4070066 and 4070071. Fixation with sealant.	
		schwarz black	1917121	
4940443	5 Garn. 5 set	WICLINE 75	Garnitur Kopf- und Endstücke Für Stulpflügelprofil verdeckt. Mit Versiegelung Teile fixieren.	
		PA	Set Head and end pieces For concealed double casement sash. Fixation with sealant.	
		schwarz black	1917124,1917126	
4940441	5 Garn. 5 set	WICLINE 75	Garnitur Kopf- und Endstücke Für Stulpflügelprofil. Mit Versiegelung Teile fixieren.	
		PA	Set Head and end pieces For Double casement sash profile. Fixation with sealant.	
		schwarz black	1917120	
4940442	5 Garn. 5 set	WICLINE 75	Garnitur Kopf- und Endstücke Für Stulpflügelprofil Klassik-Design. Mit Versiegelung Teile fixieren.	
		PA	Set Head and end pieces set For double casement Classic design sash profile. Fixation with sealant.	
		schwarz black	1917122	

WICLINE 75

Kunststoffprofile, Formstücke
Plastic profiles, moulded pieces

Zubehör
Accessories

Artikel Article	VE PU	Anwendung Application	Bezeichnung / Hinweise Designation / Indications	Abbildung Figure
		Material / Material Farbe / Colour	Zuordnung Assignment	
4040727	10 Garn. 10 set	WICLINE 75	Eckteil für Falz 44/25, Garnitur	
		PA	Corner part for rebate 44/25, set	
4040744	10 Garn. 10 set	WICLINE 75	Eckteil für Falz 44/25, Garnitur	
		PA	Corner part for rebate 44/25, set	
4040085	10 St. 10 pcs	WICLINE 75	Kugelrückschlagventil Bohrung Ø12 mm.	
			Ball check valve Borehole Ø12 mm.	
4940141	20 St. 20 pcs	WICLINE 75	Versiegelungsleitteil Versiegelungsleitteil für verdeckten Flügel. Einspannstärke 20-31 mm. Verklebung gemäß Verarbeitungsrichtlinien.	
		EPDM	Sealant guide part Sealant guide part for concealed sash Infill thickness from 20-31 mm. Sealing in accordance with the instructions in the Workshop Manual.	
		schwarz black		
4940145	20 St. 20 pcs	WICLINE 75	Versiegelungsleitteil Versiegelungsleitteil für verdeckten Flügel. Füllungsdicke 31-42 mm. Verklebung gemäß Verarbeitungsrichtlinien.	
		EPDM	Sealant guide part Sealant guide part for concealed sash Infill thickness from 31-42 mm. Sealing in accordance with the instructions in the Workshop Manual.	
		schwarz black		

WICLINE 75

Eckwinkel, Blechteile
Corner angles, Metal sheet parts





Zubehör
Accessories

Artikel Article	VE PU	Anwendung Application	Bezeichnung / Hinweise Designation / Indications	Abbildung Figure
		Material / Material Farbe / Colour	Zuordnung Assignment	
4050567	20 St. 20 pcs	WICLINE 75	Al-Eckwinkel Verbindungselement: 2 x 4070004	
		Al	Corner angle, aluminium Connecting element: 2 x 4070004	
			1010453	
4050568	20 St. 20 pcs	WICLINE 75	Al-Gusseckwinkel Verbindungselement: 2 x 4070000	
		Al	Cast Al corner angle Connecting element: 2 x 4070000	
			1017111,1017124	
4050571	20 St. 20 pcs	WICLINE 75	Al-Gusseckwinkel Verbindungselement: 2 x 4070000	
		Al	Cast Al corner angle Connecting element: 2 x 4070000	
			1010433,1010434,1010469,1010481,1010482 1010483,1010488,1010489,1010490	
4050574	20 St. 20 pcs	WICLINE 75	Al-Gusseckwinkel Verbindungselement: 2 x 4070000	
			Cast Al corner angle Connecting element: 2 x 4070000	
			1010484,1010485,1010486,1010491,1010492 1010493,1010494,1017050,1017051	
4050577	20 St. 20 pcs	WICLINE 75	Al-Gusseckwinkel Verbindungselement: 2 x 4070000	
			Cast Al corner angle Connecting element: 2 x 4070000	
			1010495	
4950005	20 St. 20 pcs	WICLINE 75	Al-Gusseckwinkel Verbindungselement: 2 x 4070009	
		Al	Cast Al corner angle Connecting element: 2 x 4070009	
			1017062,1917062,1917256,1917258,1917259 1917260	

WICLINE 75

Eckwinkel, Blechteile
Corner angles, Metal sheet parts







Zubehör
Accessories

Artikel Article	VE PU	Anwendung Application	Bezeichnung / Hinweise Designation / Indications	Abbildung Figure
		Material / Material Farbe / Colour	Zuordnung Assignment	
4950006	20 St. 20 pcs	WICLINE 75	Al-Gusseckwinkel Verbindungselement: 2 x 4070000	
		Al	Cast Al corner angle Connecting element: 2 x 4070000	
			1010452,1017001,1910134,1917001,1917055 1917068,1917076,1917089,1917201	
4950007	20 St. 20 pcs	WICLINE 75	Al-Gusseckwinkel Verbindungselement: 2 x 4070000	
		Al	Cast Al corner angle Connecting element: 2 x 4070000	
			1917002,1917056,1917202	
4950008	20 St. 20 pcs	WICLINE 75	Al-Gusseckwinkel Verbindungselement: 2 x 4070000	
			Cast Al corner angle Connecting element: 2 x 4070000	
			1010344,1010433,1010434,1010469,1010481 1010482,1010483,1010488,1010489,1010490 1017003,1017064,1017077,1017081,1017090 1017203,1017231,1310991,1910135,1917003 1917009,1917057,1917064,1917069,1917073 1917077,1917081,1917086,1917203,1917231 1917235,1917241,1917244,1917246,1917247 1917248,1917301,1917303,1917331,1917334	
4950009	20 St. 20 pcs	WICLINE 75	Al-Gusseckwinkel Verbindungselement: 2 x 4070000	
			Cast Al corner angle Connecting element: 2 x 4070000	
			1010346,1010484,1010485,1010486,1010491 1010492,1010493,1010494,1017004,1017050 1017051,1017082,1017204,1917004,1917058 1917082,1917204	
4950010	20 St. 20 pcs	WICLINE 75	Al-Gusseckwinkel Verbindungselement: 2 x 4070000	
			Cast Al corner angle Connecting element 2 x 4070000	
			1010495,1017005,1017066,1017205,1910148 1910149,1917005,1917059,1917205,1917249 1917250,1917251	

WICLINE 75

Eckwinkel, Blechteile
Corner angles, Metal sheet parts





Zubehör
Accessories

Artikel Article	VE PU	Anwendung Application	Bezeichnung / Hinweise Designation / Indications	Abbildung Figure
		Material / Material Farbe / Colour	Zuordnung Assignment	
4950011	20 St. 20 pcs	WICLINE 75	Al-Gusseckwinkel Verbindungselement: 2 x 4070000	
			Cast Al corner angle Connecting element: 2 x 4070000	
			1017006,1017206,1910170,1917067,1917206	
4950012	20 St. 20 pcs	WICLINE 75	Al-Gusseckwinkel Verbindungselement: 2 x 4070000	
			Cast Al corner angle Connecting element: 2 x 4070000	
			1310991,1917009,1917334	
4950013	20 St. 20 pcs	WICLINE 75	Al-Gusseckwinkel für Einspannblendrahmen Verbindungselement: 2 x 4070000	
		Al	Cast Al corner angle for clamping frame Connecting element: 2 x 4070000	
			1910134,1917076,1917089	
4950014	20 St. 20 pcs	WICLINE 75	Al-Gusseckwinkel Verbindungselement: 2 x 4070000	
		Al	Cast Al corner angle Connecting element: 2 x 4070000	
			1017077,1910135,1917077	
4950018	20 St. 20 pcs	WICLINE 75	Al-Gusseckwinkel Verbindungselement: 2 x 4070000	
		Al	Cast Al corner angle Connecting element: 2 x 4070000	
			1017101,1017120,1917101,1917105,1917120 1917122	
4950019	20 St. 20 pcs	WICLINE 75	Al-Gusseckwinkel Verbindungselement: 2 x 4070000	
		Al	Cast Al corner angle Connecting element: 2 x 4070000	
			1017102,1917102	

WICLINE 75

Eckwinkel, Blechteile
 Corner angles, Metal sheet parts





Zubehör
 Accessories

Artikel Article	VE PU	Anwendung Application	Bezeichnung / Hinweise Designation / Indications	Abbildung Figure
		Material / Material Farbe / Colour	Zuordnung Assignment	
4950020	20 St. 20 pcs	WICLINE 75	Al-Gusseckwinkel Verbindungselement: 2 x 4070000	
		Al	Cast Al corner angle Connecting element: 2 x 4070000	
			1017103,1910146,1917103,1917116	
4950021	20 St. 20 pcs	WICLINE 75	Al-Gusseckwinkel Verbindungselement: 2 x 4070000	
		Al	Cast Al corner angle Connecting element: 2 x 4070000	
			1017104,1910147,1917104,1917117	
4950022	20 St. 20 pcs	WICLINE 75	Al-Gusseckwinkel Verbindungselement: 2 x 4070000	
		Al	Cast Al corner angle Connecting element: 2 x 4070000	
			1017105,1917115,1917118	
4950024	20 St. 20 pcs	WICLINE 75	Al-Gusseckwinkel Verbindungselement: 2 x 4070000	
		Al	Cast Al corner angle Connecting element: 2 x 4070000	
			1917092	
4950025	20 St. 20 pcs	WICLINE 75	Al-Gusseckwinkel Verbindungselement: 2 x 4070000	
		Al	Cast Al corner angle Connecting element: 2 x 4070000	
			1917165,1917166	

WICLINE 75

Eckwinkel, Blechteile
Corner angles, Metal sheet parts





Zubehör
Accessories

Artikel Article	VE PU	Anwendung Application	Bezeichnung / Hinweise Designation / Indications	Abbildung Figure
		Material / Material Farbe / Colour	Zuordnung Assignment	
4950028	20 St. 20 pcs	WICLINE 75	Al-Gusseckwinkel Verbindungselement: 2 x 4070000	
		Al	Cast Al corner angle Connecting element: 2 x 4070000	
			1010453,1017101,1017120,1917101,1917105 1917120,1917122	
4950029	20 St. 20 pcs	WICLINE 75	Al-Gusseckwinkel Verbindungselement: 2 x 4070000	
			Cast Al corner angle Connecting element: 2 x 4070000	
			1017102,1917102	
4950030	20 St. 20 pcs	WICLINE 75	Al-Gusseckwinkel Verbindungselement: 2 x 4070000	
			Cast Al corner angle Connecting element: 2 x 4070000	
			1017103,1910146,1917103,1917116	
4950031	20 St. 20 pcs	WICLINE 75	Al-Gusseckwinkel Verbindungselement: 2 x 4070000	
			Cast Al corner angle Connecting element: 2 x 4070000	
			1017104,1910147,1917104,1917117	
4950032	20 St. 20 pcs	WICLINE 75	Al-Gusseckwinkel Verbindungselement: 2 x 4070000	
			Cast Al corner angle Connecting element: 2 x 4070000	
			1017105,1917115,1917118	

WICLINE 75

Eckwinkel, Blechteile
 Corner angles, Metal sheet parts





Zubehör
 Accessories

Artikel Article	VE PU	Anwendung Application	Bezeichnung / Hinweise Designation / Indications	Abbildung Figure
		Material / Material Farbe / Colour	Zuordnung Assignment	
4950033	20 St. 20 pcs	WICLINE 75	Al-Gusseckwinkel Verbindungselement: 2 x 4070000	
		Al	Cast Al corner angle Connecting element: 2 x 4070000	
			1917163	
4950034	20 St. 20 pcs	WICLINE 75	Al-Gusseckwinkel Verbindungselement: 2 x 4070000	
			Cast Al corner angle Connecting element: 2 x 4070000	
			1917161,1917163	
4950035	20 St. 20 pcs	WICLINE 75	Al-Gusseckwinkel Verbindungselement: 2 x 4070000	
		Al	Cast Al corner angle Connecting element: 2 x 4070000	
			1917165,1917166	
4950036	20 St. 20 pcs	WICLINE 75	Al-Gusseckwinkel Verbindungselement: 2 x 4070000	
			Cast Al corner angle Connecting element: 2 x 4070000	
			3910040	
4950037	20 St. 20 pcs	WICLINE 75	Al-Gusseckwinkel Verbindungselement: 2 x 4070000	
		Al	Cast Al corner angle Connecting element: 2 x 4070000	
			1917161	

WICLINE 75

Eckwinkel, Blechteile
 Corner angles, Metal sheet parts







Zubehör
 Accessories

Artikel Article	VE PU	Anwendung Application	Bezeichnung / Hinweise Designation / Indications	Abbildung Figure
		Material / Material Farbe / Colour	Zuordnung Assignment	
4950038	20 St. 20 pcs	WICLINE 75	Al-Gusseckwinkel für verdeckten Flügel, HI Verbindungselement: 2 x 4070000	
		Al	Cast Al corner angle for concealed sash, HI Connecting element: 2 x 4070000	
			1017111,1017112,1017113,1017124,1017125 1017126,1917110,1917111,1917112,1917113 1917124,1917126	
4950047	20 St. 20 pcs	WICLINE 75	Al-Gusseckwinkel Verbindungselement: 2 x 4070000	
			Cast Al corner angle Connecting element: 2 x 4070000	
			1917093	
4950049	20 St. 20 pcs	WICLINE 75	Al-Gusseckwinkel Verbindungselement: 2 x 4070000	
			Cast Al corner angle Connecting element: 2 x 4070000	
			1017112,1017125	
4950051	20 St. 20 pcs	WICLINE 75	Al-Gusseckwinkel Verbindungselement: 2 x 4070000	
			Cast Al corner angle Connecting element: 2 x 4070000	
			1917110,1917124	
4950052	20 St. 20 pcs	WICLINE 75	Al-Gusseckwinkel Verbindungselement: 2 x 4070000	
			Cast Al corner angle Connecting element: 2 x 4070000	
			1917111,1917126	

WICLINE 75

Eckwinkel, Blechteile
 Corner angles, Metal sheet parts

Zubehör
 Accessories

Artikel Article	VE PU	Anwendung Application	Bezeichnung / Hinweise Designation / Indications	Abbildung Figure
		Material / Material Farbe / Colour	Zuordnung Assignment	
4950053	20 St. 20 pcs	WICLINE 75	Al-Gusseckwinkel Verbindungselement: 2 x 4070000	
			Cast Al corner angle Connecting element: 2 x 4070000	
			1017113,1017126,1917112	
4950054	20 St. 20 pcs	WICLINE 75	Al-Gusseckwinkel Verbindungselement: 2 x 4070000	
			Cast Al corner angle Connecting element: 2 x 4070000	
			1917113	
4950055	20 St. 20 pcs	WICLINE 75	Al-Eckwinkel Verbindungselement: 2 x 4070000	
		Al	Al corner angle Connecting element: 2 x 4070000	
			1917092	
4950056	20 St. 20 pcs	WICLINE 75	Al-Gusseckwinkel Verbindungselement: 2 x 4070000	
			Cast Al corner angle Connecting element: 2 x 4070000	
			1917093	
4950057	4 St. 4 pcs	WICLINE 75	Al-Eckwinkel Aufsatzprofil Fenstertür Verbindungselement: 2 x 4070000	
		Al	Al corner angle Mounting profile casement door Connecting element: 2 x 4070000	
			1917301,1917303	
4950349	4 St. 4 pcs	WICLINE 75	Al-Eckwinkel Verbindungselement: verkleben	
		Al	Al corner angle Connecting element: to glue	
			1310991	

WICLINE 75

Eckwinkel, Blechteile
Corner angles, Metal sheet parts





Zubehör
Accessories

Artikel Article	VE PU	Anwendung Application	Bezeichnung / Hinweise Designation / Indications	Abbildung Figure
		Material / Material Farbe / Colour	Zuordnung Assignment	
4950060	4 St. 4 pcs	WICLINE 75	Gelenkeckwinkel Verwendung: Vertikalecke Verbindungselement: 2 x 4070002	
			Hinged corner angle Application: Vertical corner Connecting element: 2 x 4070002	
			1010452,1017001,1917001,1917055,1917068 1917201	
4950061	4 St. 4 pcs	WICLINE 75	Gelenkeckwinkel Verwendung: Vertikalecke Verbindungselement: 2 x 4070002	
			Hinged corner angle Application: Vertical corner Connecting element: 2 x 4070002	
			1917002,1917056,1917202	
4950062	4 St. 4 pcs	WICLINE 75	Gelenkeckwinkel Verwendung: Vertikalecke Verbindungselement: 2 x 4070002	
			Hinged corner angle Application: Vertical corner Connecting element: 2 x 4070002	
			1010344,1017003,1017064,1017081,1017203 1017231,1917003,1917057,1917064,1917069 1917073,1917081,1917086,1917203,1917231 1917241,1917244,1917246,1917247,1917248	
4950063	4 St. 4 pcs	WICLINE 75	Gelenkeckwinkel Verwendung: Vertikalecke Verbindungselement: 2 x 4070002	
			Hinged corner angle Application: Vertical corner Connecting element: 2 x 4070002	
			1010346,1017004,1017082,1017204,1917004 1917058,1917082,1917204	
4950065	4 St. 4 pcs	WICLINE 75	Gelenkeckwinkel Verwendung: Vertikalecke Verbindungselement: 2 x 4070003	
			Hinged corner angle Application: Vertical corner Connecting element: 2 x 4070003	
			1017101,1917101,1917105	

WICLINE 75

Eckwinkel, Blechteile
 Corner angles, Metal sheet parts

Zubehör
 Accessories

Artikel Article	VE PU	Anwendung Application	Bezeichnung / Hinweise Designation / Indications	Abbildung Figure
		Material / Material Farbe / Colour	Zuordnung Assignment	
4950066	4 St. 4 pcs	WICLINE 75	Gelenkeckwinkel Verwendung: Vertikalecke Verbindungselement: 2 x 4070003	
			Hinged corner angle Application: Vertical corner Connecting element: 2 x 4070003	
			1017102,1917102	
4950067	4 St. 4 pcs	WICLINE 75	Gelenkeckwinkel Verwendung: Vertikalecke Verbindungselement: 2 x 4070003	
			Hinged corner angle Application: Vertical corner Connecting element: 2 x 4070003	
			1017103,1917103	
4950075	4 St. 4 pcs	WICLINE 75	Gelenkeckwinkel Verwendung: Horizontalecke Verbindungselement: 2 x 4070002	
			Hinged corner angle Application: Horizontal corner Connecting element: 2 x 4070002	
			1017062,1917062,1917256,1917258,1917259 1917260	
4950076	4 St. 4 pcs	WICLINE 75	Gelenkeckwinkel Verwendung: Horizontalecke Verbindungselement: 2 x 4070002	
			Hinged corner angle Application: Horizontal corner Connecting element: 2 x 4070002	
			1010452,1017001,1917001,1917055,1917068 1917201	
4950077	4 St. 4 pcs	WICLINE 75	Gelenkeckwinkel Verwendung: Horizontalecke Verbindungselement: 2 x 4070002	
			Hinged corner angle Application: Horizontal corner Connecting element: 2 x 4070002	
			1917002,1917056,1917202	

WICLINE 75

Eckwinkel, Blechteile
Corner angles, Metal sheet parts





Zubehör
Accessories

Artikel Article	VE PU	Anwendung Application	Bezeichnung / Hinweise Designation / Indications	Abbildung Figure
		Material / Material Farbe / Colour	Zuordnung Assignment	
4950078	4 St. 4 pcs	WICLINE 75	Gelenkeckwinkel Verwendung: Horizontalecke Verbindungselement: 2 x 4070002	
			Hinged corner angle Application: Horizontal corner Connecting element: 2 x 4070002	
			1010344,1017003,1017064,1017081,1017203 1017231,1917003,1917057,1917064,1917069 1917073,1917081,1917086,1917203,1917231 1917241,1917244,1917246,1917247,1917248	
4950079	4 St. 4 pcs	WICLINE 75	Gelenkeckwinkel Verwendung: Horizontalecke Verbindungselement: 2 x 4070002	
			Hinged corner angle Application: horizontal corner connecting element: 2 x 4070002	
			1010346,1017004,1017082,1017204,1917004 1917058,1917082,1917204	
4950085	4 St. 4 pcs	WICLINE 75	Gelenkeckwinkel Verwendung: Vertikalecke Verbindungselement: 2 x 4070002	
			Hinged corner angle Application: Vertical corner Connecting element: 2 x 4070002	
			1017101,1917101,1917105	
4950086	4 St. 4 pcs	WICLINE 75	Gelenkeckwinkel Verwendung: Vertikalecke Verbindungselement: 2 x 4070002	
			Hinged corner angle Application: Vertical corner Connecting element: 2 x 4070002	
			1017102,1917102	
4950087	4 St. 4 pcs	WICLINE 75	Gelenkeckwinkel Verwendung: Vertikalecke Verbindungselement: 2 x 4070002	
			Hinged corner angle Application: Vertical corner Connecting element: 2 x 4070002	
			1017103,1917103	

WICLINE 75

Eckwinkel, Blechteile
Corner angles, Metal sheet parts





Zubehör
Accessories

Artikel Article	VE PU	Anwendung Application	Bezeichnung / Hinweise Designation / Indications	Abbildung Figure
		Material / Material Farbe / Colour	Zuordnung Assignment	
4050150	20 St. 20 pcs	WICLINE 75	Zentriereindrehteil Verwendung: Flügelüberschlag innen. Verkleben	
		Stahl, rostfrei Stainless steel	Centering turn-in part Application: Inner sash overlap. Glue	
4050153	20 St. 20 pcs	WICLINE 75	Zentriereindrehteil Verwendung: Flügelglasfalz außen. Verkleben	
		Stahl, rostfrei Stainless steel	Centering turn-in part Application: Sash outer glazing rebate. Glue	
4950082	20 St. 20 pcs	WICLINE 75	Aufsteckwinkel für Einspannblendrahmen Falz 25 mm. Verwendung: Stegverstärkung Außenschale, verkleben.	
		Stahl, rostfrei Stainless steel	Plug on angle for 25 mm rebate of clamping frame. Application: For stabilization of profile web in the mitre joint corners of outer shell, stick.	
			1917076,1917077	
4950083	20 St. 20 pcs	WICLINE 75	Aufsteckwinkel für Einspannblendrahmen Falz 44 mm. Verwendung: Stegverstärkung Außenschale, verkleben.	
		Stahl, rostfrei Stainless steel	Plug on angle for 44 mm rebate of clamping frame. Application: For stabilization of profile web in the mitre joint corners of outer shell, stick.	
			1917089,1917092	

WICLINE 75

Verbinder
Butt-joint connectors





Zubehör
Accessories

Artikel Article	VE PU	Anwendung Application	Bezeichnung / Hinweise Designation / Indications	Abbildung Figure
		Material / Material Farbe / Colour	Zuordnung Assignment	
4960002	20 St. 20 pcs	WICLINE 75	Stoßverbinder Falz 25 mm, innen/außen Verbindungselement: 1 x 4070000	
			Butt-joint connector 25 mm rebate, inside/outside Connecting element: 1 x 4070000	
			1010452,1017001,1917001,1917055,1917068 1917201,1917336	
4960003	20 St. 20 pcs	WICLINE 75	Stoßverbinder Falz 25 mm, innen/außen Verbindungselement: 1 x 4070000 Injektionsleitteil: 1 x 4070030	
			Butt-joint connector 25 mm rebate, inside/outside Connecting element: 1 x 4070000 Injection guide part: 1 x 4070030	
			1917002,1917056,1917202	
4960004	20 St. 20 pcs	WICLINE 75	Stoßverbinder Falz 25 mm, innen/außen Verbindungselement: 1 x 4070000 Injektionsleitteil: 1 x 4070030	
			Butt-joint connector 25 mm rebate, inside/outside Connecting element: 1 x 4070000 Injection guide part: 1 x 4070030	
			1010344,1017003,1017008,1017064,1017203 1017213,1017215,1017220,1310991,1910172 1917003,1917009,1917057,1917064,1917069 1917073,1917203,1917213,1917215,1917220 1917224,1917241,1917244,1917246,1917247 1917248,1917331,1917334	
4960005	20 St. 20 pcs	WICLINE 75	Stoßverbinder Falz 25 mm, innen/außen Verbindungselement: 1 x 4070000 Injektionsleitteil: 1 x 4070030	
			Butt-joint connector 25 mm rebate, inside/outside Connecting element: 1 x 4070000 Injection guide part: 1 x 4070030	
			1010346,1017004,1017204,1917004,1917058 1917204,1917273	

WICLINE 75

Verbinder
Butt-joint connectors





Zubehör
Accessories

Artikel Article	VE PU	Anwendung Application	Bezeichnung / Hinweise Designation / Indications	Abbildung Figure
		Material / Material Farbe / Colour	Zuordnung Assignment	
4960006	20 St. 20 pcs	WICLINE 75	Stoßverbinder Falz 25 mm, innen/außen Verbindungselement: 1 x 4070000 Injektionsleitteil: 1 x 4070030	
			Butt-joint connector 25 mm rebate, inside/outside Connecting element: 1 x 4070000 Injection guide part: 1 x 4070030	
			1017005,1017066,1017205,1910148,1910149 1917005,1917059,1917205,1917249,1917250 1917251	
4960007	20 St. 20 pcs	WICLINE 75	Stoßverbinder Falz 25 mm, innen/außen Verbindungselement: 2 x 4070000 Injektionsleitteil: 2 x 4070030	
			Butt-joint connector 25 mm rebate, inside/outside Connecting element: 2 x 4070000 Injection guide part: 2 x 4070030	
			1017006,1017206,1917067,1917206,1917270 1917271,1917272	
4960008	10 St. 10 pcs	WICLINE 75	Stoßverbinder Falz 25 mm, innen/außen Verbindungselement: 2 x 4070000 Injektionsleitteil: 2 x 4070030	
			Butt-joint connector 25 mm rebate, inside/outside Connecting element: 2 x 4070000 Injection guide part: 2 x 4070030	
			1017008,1017207,1017213,1910172,1917060 1917207,1917213	
4960009	10 St. 10 pcs	WICLINE 75	Stoßverbinder Falz 25 mm, innen/außen Verbindungselement: 2 x 4070000 Injektionsleitteil: 2 x 4070030	
			Butt-joint connector 25 mm rebate, inside/outside Connecting element: 2 x 4070000 Injection guide part: 2 x 4070030	
			1017215,1917215	

WICLINE 75

Verbinder
Butt-joint connectors





Zubehör
Accessories

Artikel Article	VE PU	Anwendung Application	Bezeichnung / Hinweise Designation / Indications	Abbildung Figure
		Material / Material Farbe / Colour	Zuordnung Assignment	
4960010	10 St. 10 pcs	WICLINE 75	Stoßverbinder Falz 25 mm, innen/außen Verbindungselement: 2 x 4070000 Injektionsleitteil: 2 x 4070030	
			Butt-joint connector 25 mm rebate, inside/outside Connecting element: 2 x 4070000 Injection guide part: 2 x 4070030	
			1017209,1917209	
4960011	10 St. 10 pcs	WICLINE 75	Stoßverbinder Falz 25 mm, innen/außen Verbindungselement: 2 x 4070000 Injektionsleitteil: 2 x 4070030	
			Butt-joint connector 25 mm rebate, inside/outside Connecting element: 2 x 4070000 Injection guide part: 2 x 4070030	
			1017220,1917220	
4960012	10 St. 10 pcs	WICLINE 75	Stoßverbinder Falz 25 mm, innen/außen Verbindungselement: 2 x 4070000 Injektionsleitteil: 2 x 4070030	
			Butt-joint connector 25 mm rebate, inside/outside Connecting element: 2 x 4070000 Injection guide part: 2 x 4070030	
			1917211	
4960013	10 St. 10 pcs	WICLINE 75	Stoßverbinder Falz 25 mm, innen/außen Verbindungselement: 2 x 4070000 Injektionsleitteil: 2 x 4070030	
			Butt-joint connector 25 mm rebate, inside/outside Connecting element: 2 x 4070000 Injection guide part: 2 x 4070030	
			1917224	

WICLINE 75

Verbinder
Butt-joint connectors





Zubehör
Accessories

Artikel Article	VE PU	Anwendung Application	Bezeichnung / Hinweise Designation / Indications	Abbildung Figure
		Material / Material Farbe / Colour	Zuordnung Assignment	
4960020	20 St. 20 pcs	WICLINE 75	Stoßverbinder Falz 44 mm, innen/außen Verbindungselement: 1 x 4070000 Injektionsleitteil: 1 x 4070030	
			Butt-joint connector 44 mm rebate, inside/outside Connecting element: 1 x 4070000 Injection guide part: 1 x 4070030	
			1017081,1017231,1917081,1917086,1917231 1917235	
4960021	20 St. 20 pcs	WICLINE 75	Stoßverbinder Falz 44 mm, innen/außen Verbindungselement: 1 x 4070000 Injektionsleitteil: 1 x 4070030	
			Butt-joint connector 44 mm rebate, inside/outside Connecting element: 1 x 4070000 Injection guide part: 1 x 4070030	
			1017082,1917082	
4960025	10 St. 10 pcs	WICLINE 75	Stoßverbinder Falz 22 mm, außen Verbindungselement: 1 x 4070000	
			Butt-joint connector 22 mm rebate, outside Connecting element: 1 x 4070000	
			1917336,1917337	
4960026	10 St. 10 pcs	WICLINE 75	Stoßverbinder Falz 22 mm, außen Verbindungselement: 1 x 4070000	
			Butt-joint connector 22 mm rebate, outside Connecting element: 1 x 4070000	
			1917203,1917331	
4960030	10 St. 10 pcs	WICLINE 75	Stoßverbinder Falz 16 mm, außen Verbindungselement: 1 x 4070000 Injektionsleitteil: 1 x 4070030	
			Butt-joint connector 16 mm rebate, outside Connecting element: 1 x 4070000 Injection guide part: 1 x 4070030	
			1917081,1917086,1917203,1917231,1917235	

WICLINE 75

Verbinder
Butt-joint connectors



Zubehör
Accessories

Artikel Article	VE PU	Anwendung Application	Bezeichnung / Hinweise Designation / Indications	Abbildung Figure
		Material / Material Farbe / Colour	Zuordnung Assignment	
4960031	10 St. 10 pcs	WICLINE 75	Stoßverbinder Falz 16 mm, außen Verbindungselement: 1 x 4070000 Injektionsleitteil: 1 x 4070030	
			Butt-joint connector 16 mm rebate, outside Connecting element: 1 x 4070000 Injection guide part: 1 x 4070030	
			1917082,1917204	
4960035	10 St. 10 pcs	WICLINE 75	Stoßverbinder Falz 18 mm, außen Verbindungselement: 1 x 4070000	
			Butt-joint connector 18 mm rebate, outside Connecting element: 1 x 4070000	
			1917336,1917337	
4960036	10 St. 10 pcs	WICLINE 75	Stoßverbinder Falz 18 mm, außen Verbindungselement: 1 x 4070000	
			Butt-joint connector 18 mm rebate, outside Connecting element: 1 x 4070000	
			1917334	
4960037	10 St. 10 pcs	WICLINE 75	Stoßverbinder Falz 18 mm, außen Verbindungselement: 2 x 4070000, 1 x 4070063	
		Al	Butt-joint connector 18 mm rebate, outside Connecting element: 2 x 4070000, 1 x 4070063	
			1917338,1917339	
4060056	1 St. 1 pcs	WICLINE 75	Stoßverbinder Sprossenverbinder innen Verbindungselement: 1 x 4070000	
			Butt-joint connector Glazing bar connector, inside Connecting element: 1 x 4070000	
			1917336,1917337,1917338,1917339	

WICLINE 75

Verbinder
Butt-joint connectors





Zubehör
Accessories

Artikel Article	VE PU	Anwendung Application	Bezeichnung / Hinweise Designation / Indications	Abbildung Figure
		Material / Material Farbe / Colour	Zuordnung Assignment	
4960050	10 St. 10 pcs	WICLINE 75	Stoßverbinder 135° Ecke Falz 25 mm, innen Verbindungselement: 2 x 4070009, 2 x 4070067	
		Al	Butt-joint connector for 135° corner 25 mm rebate, inside Connecting element: 2 x 4070009, 2 x 4070067	
			1917273	
4960052	10 St. 10 pcs	WICLINE 75	Stoßverbinder Falz 25 mm, außen Verbindungselement: 1 x 4070000	
			Butt-joint connector 25 mm rebate, outside Connecting element: 1 x 4070000	
			1010452,1917201,1917336	
4960053	10 St. 10 pcs	WICLINE 75	Stoßverbinder Falz 25 mm, außen Verbindungselement: 1 x 4070000	
			Butt-joint connector 25 mm rebate, outside Connecting element: 1 x 4070000	
			1917202	
4960054	10 St. 10 pcs	WICLINE 75	Stoßverbinder Falz 25 mm, außen Verbindungselement: 1 x 4070000	
			Butt-joint connector 25 mm rebate, outside Connecting element: 1 x 4070000	
			1917203	
4960055	10 St. 10 pcs	WICLINE 75	Stoßverbinder Falz 25 mm, außen Verbindungselement: 1 x 4070000 Injektionsleitteil: 1 x 4070030	
			Butt-joint connector 25 mm rebate, outside Connecting element: 1 x 4070000 Injection guide part: 1 x 4070030	
			1917204	

WICLINE 75

Verbinder
Butt-joint connectors





Zubehör
Accessories

Artikel Article	VE PU	Anwendung Application	Bezeichnung / Hinweise Designation / Indications	Abbildung Figure
		Material / Material Farbe / Colour	Zuordnung Assignment	
4960056	10 St. 10 pcs	WICLINE 75	Stoßverbinder Falz 25 mm, außen Verbindungselement: 1 x 4070000 Injektionsleitteil: 1 x 4070030	
			Butt-joint connector 25 mm rebate, outside Connecting element: 1 x 4070000 Injection guide part: 1 x 4070030	
			1910149,1917205	
4960057	10 St. 10 pcs	WICLINE 75	Stoßverbinder Falz 25 mm, außen Verbindungselement: 2 x 4070000 Injektionsleitteil: 2 x 4070030	
			Butt-joint connector 25 mm rebate, outside Connecting element: 2 x 4070000 Injection guide part: 2 x 4070030	
			1917206	
4960058	10 St. 10 pcs	WICLINE 75	Stoßverbinder Falz 25 mm, außen Verbindungselement: 2 x 4070000 Injektionsleitteil: 2 x 4070030	
			Butt-joint connector 25 mm rebate, outside Connecting element: 2 x 4070000 Injection guide part: 2 x 4070030	
			1910172,1917207,1917213	
4960059	10 St. 10 pcs	WICLINE 75	Stoßverbinder Falz 25 mm, außen Verbindungselement: 2 x 4070000 Injektionsleitteil: 2 x 4070030	
			Butt-joint connector 25 mm rebate, outside Connecting element: 2 x 4070000 Injection guide part: 2 x 4070030	
			1917215	

WICLINE 75

Verbinder
Butt-joint connectors





Zubehör
Accessories

Artikel Article	VE PU	Anwendung Application	Bezeichnung / Hinweise Designation / Indications	Abbildung Figure
		Material / Material Farbe / Colour	Zuordnung Assignment	
4960060	10 St. 10 pcs	WICLINE 75	Stoßverbinder Falz 25 mm, außen Verbindungselement: 2 x 4070000 Injektionsleitteil: 2 x 4070030	
			Butt-joint connector 25 mm rebate, outside Connecting element: 2 x 4070000 Injection guide part: 2 x 4070030	
			1917209	
4960061	10 St. 10 pcs	WICLINE 75	Stoßverbinder Falz 25 mm, außen Verbindungselement: 2 x 4070000 Injektionsleitteil: 2 x 4070030	
			Butt-joint connector 25 mm rebate, outside Connecting element: 2 x 4070000 Injection guide part: 2 x 4070030	
			1917220	
4960062	10 St. 10 pcs	WICLINE 75	Stoßverbinder Falz 25 mm, außen Verbindungselement: 2 x 4070000 Injektionsleitteil: 2 x 4070030	
			Butt-joint connector 25 mm rebate, outside Connecting element: 2 x 4070000 Injection guide part: 2 x 4070030	
			1917211	
4960063	10 St. 10 pcs	WICLINE 75	Stoßverbinder Falz 25 mm, außen Verbindungselement: 2 x 4070000 Injektionsleitteil: 2 x 4070030	
			Butt-joint connector 25 mm rebate, outside Connecting element: 2 x 4070000 Injection guide part: 2 x 4070030	
			1917224	

WICLINE 75

Verbinder
Butt-joint connectors





Zubehör
Accessories

Artikel Article	VE PU	Anwendung Application	Bezeichnung / Hinweise Designation / Indications	Abbildung Figure
		Material / Material Farbe / Colour	Zuordnung Assignment	
4960229	20 St. 20 pcs	WICLINE 75	Stoßverbinder Falz 44 mm, außen für Blendrahmen mit verdeckter Entwässerung Verbindungselement: 1 x 4070000	
			Butt-joint connector 44 mm rebate, outside for frame profiles with concealed drainage Connecting element: 1 x 4070000	
			1917081,1917086,1917231,1917235	
4960230	20 St. 20 pcs	WICLINE 75	Stoßverbinder Falz 44 mm, außen für Blendrahmen mit verdeckter Entwässerung Verbindungselement: 1 x 4070000	
			Butt-joint connector 44 mm rebate, outside for frame profiles with concealed drainage Connecting element: 1 x 4070000	
			1917082	
4960040	4 St. 4 pcs	WICLINE 75	Gelenkverbinder innen Verbindungselement: 1 x 4070002	
			Hinged connector inside Connecting element: 1 x 4070002	
			1010452,1017001,1917001,1917055,1917068 1917201	
4960041	4 St. 4 pcs	WICLINE 75	Gelenkverbinder innen Verbindungselement: 1 x 4070002	
			Hinged connector inside Connecting element: 1 x 4070002	
			1917002,1917056,1917202	
4960042	4 St. 4 pcs	WICLINE 75	Gelenkverbinder innen Verbindungselement: 1 x 4070002	
			Hinged connector inside Connecting element: 1 x 4070002	
			1010344,1017003,1017064,1017081,1017203 1017231,1917003,1917057,1917064,1917069 1917073,1917081,1917086,1917203,1917231 1917241,1917244,1917246,1917247,1917248 1917334	

WICLINE 75

Verbinder
Butt-joint connectors

Zubehör
Accessories

Artikel Article	VE PU	Anwendung Application	Bezeichnung / Hinweise Designation / Indications	Abbildung Figure
		Material / Material Farbe / Colour	Zuordnung Assignment	
4960043	4 St. 4 pcs	WICLINE 75	Gelenkverbinder innen Verbindungselement: 1 x 4070002	
			Hinged connector inside Connecting element: 1 x 4070002	
			1010346,1017004,1017082,1017204,1917004 1917058,1917082,1917204	
4960045	4 St. 4 pcs	WICLINE 75	Gelenkverbinder außen Verbindungselement: 1 x 4070002	
			Hinged connector outside Connecting element: 1 x 4070002	
			1010452,1017001,1917001,1917055,1917068 1917201	
4960046	4 St. 4 pcs	WICLINE 75	Gelenkverbinder außen Verbindungselement: 1 x 4070002	
			Hinged connector outside Connecting element: 1 x 4070002	
			1917002,1917056,1917202	
4960047	4 St. 4 pcs	WICLINE 75	Gelenkverbinder außen Verbindungselement: 1 x 4070002	
			Hinged connector outside Connecting element: 1 x 4070002	
			1010344,1017003,1017064,1017081,1017203 1017231,1917003,1917057,1917064,1917069 1917073,1917081,1917086,1917203,1917231 1917241,1917244,1917246,1917247,1917248 1917334	
4960048	4 St. 4 pcs	WICLINE 75	Gelenkverbinder außen Verbindungselement: 1 x 4070002	
			Hinged connector outside Connecting element: 1 x 4070002	
			1010346,1017004,1017082,1017204,1917004 1917058,1917082,1917204	

WICLINE 75

Verbindungselemente / Schrauben
Connecting components / Screws

Zubehör
Accessories

Artikel Article	VE PU	Anwendung Application	Bezeichnung / Hinweise Designation / Indications	Abbildung Figure
		Material / Material Farbe / Colour	Zuordnung Assignment	
6041192	100 St. 100 pcs	WICLINE 75	Senkschraube M5x40 T25 für Fenstergriff mit Einlassgetriebe	
		Stahl rostfrei, A2 Stainless steel, A2	Countersunk screw M5x40 T25 for window handle with mortise gear	
		roh untreated		
180311	100 St. 100 pcs	WICLINE 75	Halteknopfschraube M4 x 6 mm	
			Retaining knob screw M4 x 6 mm	
		kadmiert cadmium coated		
186016	100 St. 100 pcs	WICLINE 75	Halteknopfschraube ST4.2 x 12 mm mit Blechschraubengewinde	
			Retaining knob screw ST4.2 x 12 mm with tapping screw thread	
198069	1 St. 1 pcs	WICLINE 75	Gewindestange M8 x 1000 mm	
			Threaded rod M8 x 1000 mm	
4070000	100 St. 100 pcs	WICLINE 75	Hülse Ø6 x 10 mm Setzdorn 5060053 / 5060055	
		Stahl, rostfrei Stainless steel	Bush Ø6 x 10 mm Mandrel for drive bush 5060053 / 5060055	
4070002	100 St. 100 pcs	WICLINE 75	Kegelschraube Ø6.6 x 9.5 T25	
		Stahl rostfrei, A1 Stainless steel, A1	Screwed bush Ø6.6 x 9.5 T25	

WICLINE 75

Verbindungselemente / Schrauben
Connecting components / Screws

Zubehör
Accessories

Artikel Article	VE PU	Anwendung Application	Bezeichnung / Hinweise Designation / Indications	Abbildung Figure
		Material / Material Farbe / Colour	Zuordnung Assignment	
4070003	100 St. 100 pcs	WICLINE 75	Stift Ø3 x 6 mm Universell einsetzbar.	
		Stahl, rostfrei Stainless steel	Pin Ø3 x 6 mm Universal	
4070004	100 St. 100 pcs	WICLINE 75	Zylinderstift Ø4 x 10 mm	
		Stahl, rostfrei Stainless steel	Cylindrical pin Ø4 x 10 mm	
4070008	100 St. 100 pcs	WICLINE 75	Hülse Ø6 x 10 mm Hülse ohne Bund	
		Stahl, rostfrei Stainless steel	Bush Ø6 x 10 mm Bush without collar	
4070009	100 St. 100 pcs	WICLINE 75	Hülse (kurz) Ø6 x 7 mm Schlaghülse 5060053/5060055	
		Stahl, rostfrei Stainless steel	Drive bush (short) Ø6 x 7 mm Drive bush 5060053/5060055	
4070010	100 St. 100 pcs	WICLINE 75	Zylinderkopfschraube M6 x 13.5 mm T25 Torx 25	
		Stahl rostfrei, A2 Stainless steel, A2	Socket-head cap screw M6 x 13.5 mm T25 Torx 25	
4070011	100 St. 100 pcs	WICLINE 75	Gewindestift M5 x 12 mm T8 Torx 8	
		Stahl Steel	Threaded pin M5 x 12 mm T8 Torx 8	

WICLINE 75

Verbindungselemente / Schrauben
Connecting components / Screws



Zubehör
Accessories

Artikel Article	VE PU	Anwendung Application	Bezeichnung / Hinweise Designation / Indications	Abbildung Figure
		Material / Material Farbe / Colour	Zuordnung Assignment	
4070012	100 St. 100 pcs	WICLINE 75	Zylinderkopfschraube M5 x 9 mm T10 Torx 10	
		Stahl rostfrei, A2 Stainless steel, A2	Socket-head cap screw M5 x 9 mm T10 Torx 10	
4070013	100 St. 100 pcs	WICLINE 75	Gewindestift M5 x 4.5 mm T10 Torx 10	
		Stahl Steel	Grub screw M5 x 4.5 mm T10 Torx 10	
4070036	100 St. 100 pcs	WICLINE 75	Stanzschraube M6 x 15 mm Torx 15	
		Stahl Steel	Punch screw M6 x 15 mm Torx 15	
4070068	100 St. 100 pcs	WICLINE 75	Zylinderkopfschraube M6 x 35 mm, T30 Torx 30	
		Stahl, rostfrei Stainless steel	Cheese-head screw M6 x 35 mm, T30 Torx 30	
4070069	50 St. 50 pcs	WICLINE 75	Gewindestift M5 x 16 mm Sicherung für Steckleiste 3011029.	
		Stahl Steel	Threaded pin M5 x 16 mm Safeguard for plug-in glazing bead 3011029.	
4070241	100 St. 100 pcs	WICLINE 75	Bohrschraube mit Linsenkopf DG50x16, T25	
		Stahl rostfrei, A2 Stainless steel, A2	Fillister head self-drilling screw DG50x16, T25	

WICLINE 75

Verbindungselemente / Schrauben
Connecting components / Screws

Zubehör
Accessories

Artikel Article	VE PU	Anwendung Application	Bezeichnung / Hinweise Designation / Indications	Abbildung Figure
		Material / Material Farbe / Colour	Zuordnung Assignment	
4970077	100 St. 100 pcs	WICLINE 75	Bohrschraube ST4.2 x 24, T20 Der Einsatz des Bit 5960013 wird wegen besserer Führung empfohlen!	
		Stahl rostfrei, A2 Stainless steel, A2	Drilling screw ST4.2 x 24, T20 <i>The usage of the tool 5960013 is due to the better guidance recommended.</i>	
4970079	100 St. 100 pcs	WICLINE 75	Bohrschraube ST4.2 x 35, T20 Der Einsatz des Bit 5960013 wird wegen besserer Führung empfohlen!	
		Stahl rostfrei, A2 Stainless steel, A2	Drilling screw ST4.2 x 35, T20 <i>The usage of the tool 5960013 is due to the better guidance recommended.</i>	

WICLINE 75

Verschiedenes
Miscellaneous





Zubehör
Accessories

Artikel Article	VE PU	Anwendung Application	Bezeichnung / Hinweise Designation / Indications	Abbildung Figure
		Material / Material Farbe / Colour	Zuordnung Assignment	
4080446	10 St. 10 pcs	WICLINE 75	Befestigungsteil	
		Al	Fastener Part	
4080447	10 St. 10 pcs	WICLINE 75	Befestigungsteil	
		Al	Fastener Part	
4080448	10 St. 10 pcs	WICLINE 75	Befestigungsteil	
		Al	Fastener part	
4080007	50 St. 50 pcs	WICLINE 75	Entwässerungsabdeckung Verwendung: Dampfdruckausgleich und Entwässerung der Dichtungsvorkammer.	
		Al	Weephole cover Application: Vapour pressure equalization and drainage of gasket prechamber.	
		roh untreated		
4080006	20 St. 20 pcs	WICLINE 75	Maueranker Verwendung: WICONA - Nut	
		Stahl, rostfrei Stainless steel	Wall anchor Application: WICONA groove	
		verzinkt galva- nized		

WICLINE 75

Verschiedenes
Miscellaneous

Zubehör
Accessories



Artikel Article	VE PU	Anwendung Application	Bezeichnung / Hinweise Designation / Indications	Abbildung Figure
		Material / Material Farbe / Colour	Zuordnung Assignment	
4010067	33 m 33 m	WICLINE 75	Klebeband 19 x 1.1 mm Zum Aufkleben von Sprossen auf Glas. Selbstklebend auf gereinigten Glasflächen. WICSTYLE 65/75: Zum Abdichten und Fixieren des Dichtungsaufnahmeprofiles 4930068.	
			Adhesive tape 19 x 1.1 mm For gluing glazing bars on glass. Self-adhesive on cleaned glass surfaces. WICSTYLE 65/75: For sealing and fixing with gasket retainer profile 4930068.	
		grau grey		
180172	100 St. 100 pcs	WICLINE 75	Halter Verbindungs-Mittel: Zylinderschraube ST 3.9	
			Holder Connecting device: Cheese-head screw ST 3.9	
180179	100 St. 100 pcs	WICLINE 75	Halter Verbindungs-Mittel: Zylinderschraube ST 3.9	
			Holder Connecting device: Cheese-head screw ST 3.9	
188206	100 St. 100 pcs	WICLINE 75	Gleitteil, 2 mm Bohrung Ø 8 mm, Bund 2 mm dick.	
			Slide part, 2 mm Drilling Ø 8 mm, Collar 2 mm thick.	
		schwarz black		
188250	100 St. 100 pcs	WICLINE 75	Gleitteil, 2.8 mm Bohrung Ø8 mm, Bund 2.8 mm dick.	
			Slide part, 2.8 mm Drilling Ø8 mm. Collar 2.8 mm thick.	
		schwarz black		

WICLINE 75

Verschiedenes
Miscellaneous

Zubehör
Accessories



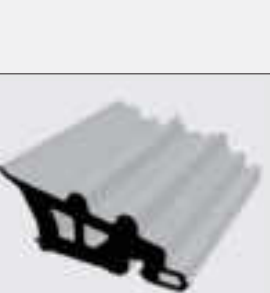

Artikel Article	VE PU	Anwendung Application	Bezeichnung / Hinweise Designation / Indications	Abbildung Figure
		Material / Material Farbe / Colour	Zuordnung Assignment	
4080008	20 St. 20 pcs	WICLINE 75	Halter Abstand 300 mm.	
		Al	Holder Distance 300 mm.	
4080444	100 St. 100 pcs	WICLINE 75	Vorklotz Klotzbrücke für verdeckten Flügel. Gegen Abrutschen sichern.	
		Al	Glazing support Glazing support for concealed sash profiles. Secure against slipping!	
4080445	100 St. 100 pcs	WICLINE 75	Vorklotz Klotzbrücke für verdeckten Flügel. Gegen Abrutschen sichern.	
		Al	Glazing support Glazing support for concealed sash profiles. Secure against slipping!	
4980054	100 St. 100 pcs	WICLINE 75	Vorklotz Klotzbrücke für verdeckten Flügel. Gegen Abrutschen sichern.	
		Al	Glazing support Glazing support for concealed sash profiles. Secure against slipping!	
4980055	100 St. 100 pcs	WICLINE 75	Vorklotz Klotzbrücke für verdeckten Flügel. Gegen Abrutschen sichern.	
		Al	Glazing support Glazing support for concealed sash profiles. Secure against slipping!	

Artikel Article	VE PU	Anwendung Application	Bezeichnung / Hinweise Designation / Indications	Abbildung Figure
		Material / Material Farbe / Colour	Zuordnung Assignment	
4090157	10 Garn. 10 set	WICLINE 75	Garnitur Kopfstücke, Lüftungsklappe 180mm Achtung: Abdeckung mit Entwässerungsbohrung unten anbringen	
		Al	Set head pieces, ventilation flap 180mm Attention: Cover plate with drainage on the bottom side	
4090158	10 Garn. 10 set	WICLINE 75	Garnitur Kopfstücke, Lüftungsklappe 250mm Achtung: Abdeckung mit Entwässerungsbohrungen unten anbringen!	
		Al	Set head pieces, Ventilation flap 250mm Attention: Cover plate with drainage openings on the bottom side	
4900187	10 St. 10 pcs	WICLINE 75	Kennzeichnungsschild, Einbruchhemmung Im Überschlagfalz unterhalb des Griffes dauerhaft einkleben.	
		Al	Identification marking plate, burglar resistance Glue in inner overlapping rebate, below handle.	
		roh untreated		
4980067	10 St. 10 pcs	WICLINE 75	Klemmprofil zur Befestigung von Zusatzprofilen Verbindungselement: 4x 4070062 ST 3.9 x 9.5, durchschusshemmend Montage mit Bohrschablone 5910081	
		Al	Clamping profile for fixing of additional profiles Connecting element: 4x 4070062 ST 3.9 x 9.5, bullet-resistance	
		roh untreated	Mounting with drill template 5910081	
4090152	100 m 100 m	WICLINE 75	Dämmprofil zur U-Wert Verbesserung	
		EPDM	Insulation profile to optimize the U-Value	
		schwarz black	5060418	





WICLINE 75

Verschiedenes
Miscellaneous

Zubehör
Accessories

Artikel Article	VE PU	Anwendung Application	Bezeichnung / Hinweise Designation / Indications	Abbildung Figure
		Material / Material Farbe / Colour	Zuordnung Assignment	
4090200	50 m 50 m	WICLINE 75	Dämmprofil	
		Polystyren Polystirene	Thermal break profile	
4390002	20 m 20 m	WICLINE 75	Dämmteil Glasfalz	
		PE, geschäumt PE, foamed	Insulation part glazing rebate	
		grau grey		
4990001	100 m 100 m	WICLINE 75	Spezial-Dämmprofil Verwendung: Flügelprofile. Bautiefe 75 mm. Umlaufend mit Unterbrechungen an Glasklötzen, Ecken und Entwässerung. Ausnehmungen für die Glasfalzbelüftung vornehmen!	
		PE, geschäumt PE, foamed	Special insulation profile Application in sash profiles. Construction depth 75 mm. Circumferential with cut-outs in area of glazing shims, corners and drainage areas. Make cut-outs for rebate ventilation!	
		grau grey		
4990003	100 m 100 m	WICLINE 75	Spezial-Dämmprofil Verwendung in Blendrahmen- und Kämpferprofilen. Umlaufend mit Unterbrechungen an Glasklötzen, Ecken und Entwässerung. Ausnehmungen für die Glasfalzbelüftung vornehmen!	
		PE, geschäumt PE, foamed	Special insulation profile Application in frame and transom profiles. Circumferential with cut-outs in area of glazing shims, corners and drainage areas. Make cut-outs for rebate ventilation!	
		grau grey		





Verschiedenes
Miscellaneous

Artikel Article	VE PU	Anwendung Application	Bezeichnung / Hinweise Designation / Indications	Abbildung Figure
		Material / Material Farbe / Colour	Zuordnung Assignment	
4990004	20 m 20 m	WICLINE 75	Spezial-Dämmprofil Verwendung in Blendrahmen und Kämpferprofilen. Bautiefe 65 und 75 mm, Falz 44 mm. Umlaufend mit Unterbrechungen an Glasklötzen, Ecken und Entwässerung. Ausnehmungen für die Glasfalzbelüftung vornehmen!	
		PE, geschäumt PE, foamed	Special insulation profile Application in frame and transom profiles.	
		grau grey	Construction depth 65 and 75 mm, Rebate 44 mm. Circumferential with cut-outs in area of glazing shims, corners and drainage areas. Make cut-outs for rebate ventilation!	
4990006	20 m 20 m	WICLINE 75	Dämmteil Zur Uf-Wert Verbesserung, Schwing-Wendefenster	
		EPDM, geschäumt EPDM, foamed	Insulation part For improvement of Uf-values, pivot window	
		schwarz black		
4090097	50 m 50 m	WICLINE 75	Einschub 20 x 30 mm	
		PUR, geschäumt PUR, foamed	Insertion 20 x 30 mm	
			1910146	
4090098	50 m 50 m	WICLINE 75	Einschub 30 x 30 mm	
		PUR, geschäumt PUR, foamed	Insertion 30 x 30 mm	
			1910147,1910148,1910149	
4090099	50 m 50 m	WICLINE 75	Einschub 40 x 30 mm	
		PUR, geschäumt PUR, foamed	Insertion 40 x 30 mm	
			1917206	

WICLINE 75

Zubehör
Accessories

Verschiedenes
Miscellaneous

Artikel Article	VE PU	Anwendung Application	Bezeichnung / Hinweise Designation / Indications	Abbildung Figure
		Material / Material Farbe / Colour	Zuordnung Assignment	
4090100	20 m 20 m	WICLINE 75	Einschub 130 x 30	
		PUR, geschäumt PUR, foamed	Insertion 130 x 30	
			1917215	
4090101	20 m 20 m	WICLINE 75	Einschub 220 x 30 mm	
		PUR, geschäumt PUR, foamed	Insertion 220 x 30 mm	
			1917224	
4990014	20 m 20 m	WICLINE 75	Einschub 110 x 30	
		PUR, geschäumt PUR, foamed	Insertion 110 x 30	
			1910172	
4990016	20 m 20 m	WICLINE 75	Einschub 50 x 30	
		PUR, geschäumt PUR, foamed	Insertion 50 x 30	
			1917067	

Artikel Article			VE PU	Bezeichnung Designation	Abbildung Figure
4070169	T15	ST3.5 x 6.5	100 St.	Linsenblechschraube	
4070170	T15	ST3.5 x 19	100 St.	ähnlich DIN ISO 7049	
4070062	T15	ST3.9 x 9.5	100 St.	Stahl rostfrei, A2	
4070040	T15	ST3.9 x 13	100 St.		
4070041	T15	ST3.9 x 19	100 St.	<i>Self-tapping pan head screw</i>	
4070043	T15	ST3.9 x 25	100 St.	<i>similar DIN ISO 7049</i>	
4070044	T20	ST3.9 x 50	100 St.	<i>Stainless steel, A2</i>	
4070045	T20	ST4.2 x 9.5	100 St.		
4070046	T20	ST4.2 x 13	100 St.		
4070225	T20	ST4.2 x 22	100 St.		
4070047	T20	ST4.2 x 25	100 St.		
4070048	T20	ST4.2 x 45	100 St.		
4070049	T20	ST4.2 x 50	100 St.		
4070059	T20	ST4.2 x 55	100 St.		
4070060	T20	ST4.2 x 60	100 St.		
4070175	T25	ST4.8 x 9.5	100 St.		
4070176	T25	ST4.8 x 11	100 St.		
4070025	T25	ST4.8 x 13	100 St.		
4070026	T25	ST4.8 x 16	100 St.		
4070027	T25	ST4.8 x 23	100 St.		
4070161	T25	ST4.8 x 25	100 St.		
4070050	T25	ST4.8 x 32	100 St.		
4070051	T25	ST4.8 x 60	100 St.		
4070231	T25	ST4.8 x 65	100 St.		
4070080	T25	ST5.5 x 23	100 St.		
4070081	T25	ST5.5 x 29	100 St.		
4070082	T25	ST5.5 x 35	100 St.		
4070083	T25	ST5.5 x 41	100 St.		
4070084	T25	ST5.5 x 47	100 St.		
4070085	T25	ST5.5 x 53	100 St.		
4070086	T25	ST5.5 x 59	100 St.		
4070087	T25	ST5.5 x 65	100 St.		
4070088	T25	ST5.5 x 71	100 St.		
4070028	T25	ST5.5 x 77	100 St.		
4070029	T25	ST5.5 x 83	100 St.		

Artikel Article		VE PU	Bezeichnung Designation	Abbildung Figure
4070110	T10	ST3.5 x 25	100 St.	
4070071	T15	ST3.9 x 9.5	100 St.	
4070067	T15	ST3.9 x 13	100 St.	
4070057	T15	ST3.9 x 19	100 St.	
4070179	T15	ST3.9 x 22	100 St.	
4070052	T15	ST3,9 x 25	100 St.	
4070063	T15	ST3.9 x 32	100 St.	
4070053	T20	ST4.2 x 9.5	100 St.	
4070177	T20	ST4.2 x 11	100 St.	
4070056	T20	ST4.2 x 16	100 St.	
4070042	T20	ST4.2 x 25	100 St.	
4070058	T20	ST4.2 x 38	100 St.	
4070061	T20	ST4.2 x 45	100 St.	
4070054	T20	ST4.2 x 50	100 St.	
4070055	T25	ST4.8 x 13	100 St.	
4070066	T25	ST4.8 x 19	100 St.	
4070115	T25	ST4.8 x 25	100 St.	
4070163	T25	ST4.8 x 32	100 St.	
4070070	T25	ST4.8 x 45	100 St.	
4070443	T25	ST4.8 x 60	100 St.	
4070165	T25	ST4.8 x 78	100 St.	
4070162	T25	ST4.8 x 90	100 St.	
4070164	T25	ST4.8 x 100	100 St.	
4070178	T25	ST4.8 x 110	100 St.	
4070229	T25	ST6.3 x 120	100 St.	

WICLINE 75

Verbindungselemente
Connecting components

Zubehör
Accessories

Artikel <i>Article</i>		VE <i>PU</i>	Bezeichnung <i>Designation</i>	Abbildung <i>Figure</i>
4070232	M6 x 20	100 St.	Senkschraube mit Innensechskant	
4070233	M8 x 16	100 St.	DIN 7991	
4070234	M8 x 25	100 St.	Stahl rostfrei, A2	
			<i>Hexagon socket-head countersunk screw DIN 7991 Stainless steel, A2</i>	

WICLINE 75

Verbindungselemente
Connecting components

Zubehör
Accessories

Artikel <i>Article</i>		VE <i>PU</i>	Bezeichnung <i>Designation</i>	Abbildung <i>Figure</i>
4070226	M6 x 35	100 St.	Zylinderschraube mit Innensechskant	
4070230	M6 x 50	100 St.	DIN 912	
4070227	M8 x 12	100 St.	Stahl rostfrei, A2	
4070228	M8 x 25	100 St.	<i>Fillister hexagon socket-head screw DIN 912 Stainless steel, A2</i>	

WICLINE 75

Verbindungselemente
Connecting components

Zubehör
Accessories

Artikel <i>Article</i>		VE <i>PU</i>	Bezeichnung <i>Designation</i>	Abbildung <i>Figure</i>
4070180	M8 x 45	100 St.	Sechskantschraube	
4070221	M8 x 65	100 St.	DIN 931	
4070222	M8 x 80	100 St.	Stahl rostfrei, A2	
4070223	M8 x 100	100 St.		
4070224	M8 x 130	100 St.	<i>Hexagon head screw DIN 931 Stainless steel, A2</i>	

WICLINE 75

Verbindungselemente
Connecting components

Zubehör
Accessories

Artikel Article			VE PU	Bezeichnung Designation	Abbildung Figure
4070244	T25	ST5.5 x 25	100 St.	Blechschaube mit Zylinderkopf	
4070245	T25	ST5.5 x 31	100 St.	Gewinde ähnlich DIN ISO 7049	
4070246	T25	ST5.5 x 37	100 St.	Kopf ähnlich DIN 7984	
4070247	T25	ST5.5 x 43	100 St.	Stahl rostfrei, A4	
4070248	T25	ST5.5 x 49	100 St.	<i>Self-tapping pan-head screw</i>	
4070249	T25	ST5.5 x 55	100 St.	<i>Thread similar DIN ISO 7049</i> <i>head similar DIN 7984</i> <i>Stainless steel, A4</i>	

Artikel Article			VE PU	Bezeichnung Designation	Abbildung Figure
4070240	SW4	ST4.8 x 32	100 St.	Blechschaube mit Zylinderkopf	
4070089	T25	ST5.5 x 23	100 St.	Gewinde ähnlich DIN ISO 7049	
4070090	T25	ST5.5 x 29	100 St.	Kopf ähnlich DIN 912	
4070091	T25	ST5.5 x 35	100 St.	Stahl rostfrei, A4	
4070092	T25	ST5.5 x 41	100 St.	<i>Self-tapping cylinder-head screw</i>	
4070093	T25	ST5.5 x 47	100 St.	<i>Thread similar DIN ISO 7049</i>	
4070094	T25	ST5.5 x 53	100 St.	<i>head similar DIN 912</i>	
4070095	T25	ST5.5 x 59	100 St.	<i>Stainless steel, A4</i>	
4070096	T25	ST5.5 x 65	100 St.		
4070097	T25	ST5.5 x 71	100 St.		

Artikel <i>Article</i>			VE <i>PU</i>	Bezeichnung <i>Designation</i>	Abbildung <i>Figure</i>
4070242	T25	ST4.8 x 25	100 St.	Bohrschraube mit Senkkopf	
4070243	T25	ST4.8 x 32	100 St.	ähnlich DIN ISO 1482 Stahl rostfrei, A2 <i>Countersunk head drilling screw similar DIN ISO 1482 Stainless steel, A2</i>	

WICLINE 75

Verbindungselemente
Connecting components

Zubehör
Accessories

Artikel <i>Article</i>			VE <i>PU</i>	Bezeichnung <i>Designation</i>	Abbildung <i>Figure</i>
4970082	T20	ST4.2 x 22	100 St.	Bohrschraube mit Linsenkopf	
4970081	T20	ST4.2 x 40	100 St.	Stahl rostfrei, A2	
4970074	T20	ST4.2 x 45	100 St.	<i>Fillister head drilling screw</i>	
4970086	T20	ST4.2 x 50	100 St.	<i>Stainless steel, A2</i>	
4970087	T20	ST4.2 x 55	100 St.		

	Seite
	Page
Dreh-Kipp-Beschlag verdeckt <i>Turn/Tilt fitting concealed</i>	6/3
Tilt-First-Beschlag verdeckt <i>Tilt-First fitting concealed</i>	6/4
Dreh-Beschlag verdeckt <i>Turn fitting concealed</i>	6/5
Stulp-Beschlag verdeckt <i>Double casement fitting concealed</i>	6/6
Kipp-Beschlag verdeckt <i>Tilt fitting concealed</i>	6/7
Dreh-Kipp-Beschlag <i>Turn/Tilt fitting</i>	6/8
Schräg / Rundbogen Dreh-Kipp-Beschlag <i>Sloped / arched turn/tilt fitting</i>	6/11
Tilt-First-Beschlag <i>Tilt-First fitting</i>	6/12
Dreh-Beschlag <i>Turn fitting</i>	6/14
Stulp-Beschlag <i>Double casement fitting</i>	6/16
Kipp-Beschlag <i>Tilt fitting</i>	6/20
Lüftungsklappenbeschlag (Grundbeschläge/Zusatzbeschläge/Antriebe) <i>Fittings for ventilation flap (basic fittings/additional fittings/window drives)</i>	6/21
Oberlicht-Beschlag <i>Fanlight fitting</i>	6/24
Parallelschiebekipp-Beschlag <i>Parallel sliding tilt fitting</i>	6/39
Zubehör einbruchhemmend (einwärts) <i>Accessory, burglar resistant (inwards)</i>	6/51
Zusatzbeschläge und Griffe (einwärts) <i>Additional hardware and handles (inwards)</i>	6/53
Drehbeschlag/Stulpbeschlag (auswärts) <i>Turn fitting/double casement fitting (outwards)</i>	6/68
Zusatzbeschläge Fenstertüren (einwärts / auswärts / barrierefreie Schwelle) <i>Additional hardware for casement doors (inwards / outwards)</i>	6/70
Klappbeschlag auswärts <i>Top hung fitting outwards</i>	6/81
Senk-Klapp-Beschlag <i>Italian Style fitting</i>	6/83
Schwing-Wende-Beschlag <i>Pivot fitting horizontal / vertical</i>	6/86
Zusatzbeschläge und Griffe (auswärts) <i>Additional hardware and handles (outwards)</i>	6/90

WICLINE 75

Dreh-Kipp-Beschlag (verdeckt)
Turn/Tilt fitting (concealed)

Beschläge
Fittings



Artikel Article	VE PU	Farbe Colour	DIN DIN	Bezeichnung / Hinweise Designation / Indications	Abbildung Figure
6940500	1 1	roh <i>untreated</i>	R	Dreh-Kipp-Grundbeschlag verdeckt Schere Gr. 1 FG max.: 160 kg	
6940501	1 1	roh <i>untreated</i>	L	FAB min. = 450 mm FAB max. = 700 mm FAH min. = 600 mm (FAH max. = siehe zulässige Flügelgrößen) Turn/Tilt basic fitting concealed <i>Retainer arm size 1</i> <i>max. sash weight: 160 kg</i> <i>min. sash width = 450 mm</i> <i>max. sash width = 700 mm</i> <i>min. sash height = 600 mm</i> <i>(max. sash height = see admissible sash sizes)</i>	
6940502	1 1	roh <i>untreated</i>	R	Dreh-Kipp-Grundbeschlag verdeckt Schere Gr. 2 FG max.: 160 kg	
6940503	1 1	roh <i>untreated</i>	L	FAB min. = 700 mm FAB >= 1400 mm: mit Zweitschere 6940257 FAH min. = 600 mm (FAB/FAH max. = siehe zulässige Flügelgrößen) Turn/Tilt basic fitting concealed <i>Retainer arm size 2</i> <i>max. sash weight = 160 kg</i> <i>min. sash width = 700 mm</i> <i>sash width >= 1400 mm: with second retainer arm 6940257</i> <i>min. sash height = 600 mm</i> <i>(max. sash width / height = see admissible sash sizes)</i>	

WICLINE 75

Tilt-First-Beschlag (verdeckt)

Tilt-First fitting (concealed)

Beschläge

Fittings



Artikel <i>Article</i>	VE <i>PU</i>	Farbe <i>Colour</i>	DIN <i>DIN</i>	Bezeichnung / Hinweise <i>Designation / Indications</i>	Abbildung <i>Figure</i>
6940504	1 1	roh <i>untreated</i>	R	Tilt-First-Grundbeschlag verdeckt Schere Gr. 1 FG max.: 160 kg	
6940505	1 1	roh <i>untreated</i>	L	FAB min. = 450 mm FAB max. = 700 mm FAH min. = 600 mm (FAH max. = siehe zulässige Flügelgrößen) Tilt-First basic fitting concealed <i>Retainer arm size 1</i> <i>max. sash weight: 160 kg</i> <i>min. sash width = 450 mm</i> <i>max. sash width = 700 mm</i> <i>min. sash height = 600 mm</i> <i>(max. sash height = see admissible sash sizes)</i>	
6940506	1 1	roh <i>untreated</i>	R	Tilt-First-Grundbeschlag verdeckt Schere Gr. 2 FG max.: 160 kg	
6940507	1 1	roh <i>untreated</i>	L	FAB min. = 700 mm FAB >= 1400 mm: mit Zweitschere 6940266 FAH min. = 600 mm (FAB/FAH max. = siehe zulässige Flügelgrößen) Tilt-First basic fitting concealed <i>Retainer arm size 2</i> <i>max. sash weight: 160 kg</i> <i>min. sash width = 700 mm</i> <i>sash width >= 1400 mm: with second retainer arm 6940266</i> <i>min. sash height = 600 mm</i> <i>(max. sash width / height = see admissible sash sizes)</i>	

WICLINE 75

Dreh-Beschlag (verdeckt)
Turn fitting (concealed)

Beschläge
Fittings

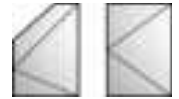

Artikel Article	VE PU	Farbe Colour	DIN DIN	Bezeichnung / Hinweise Designation / Indications	Abbildung Figure
6940515	1 1	roh <i>untreated</i>	R	Dreh-Grundbeschlag, verdeckt Dreh-Grundbeschlag verdeckt FG max.: 160 kg FAB min. = 450 mm FAH min. = 600 mm (FAB/FAH max. = siehe zulässige Flügelgrößen)	
6940516	1 1	roh <i>untreated</i>	L	Turn basic fitting, concealed <i>max. sash weight: 160 kg</i> <i>min. sash width = 450 mm</i> <i>min. sash height = 600 mm</i> <i>(max. sash width / height = see admissible sash sizes)</i>	

WICLINE 75

Stulp-Beschlag (verdeckt)
Double casement fitting (concealed)

Beschläge
Fittings

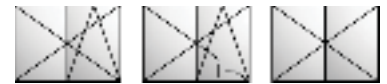

Artikel Article	VE PU	Farbe Colour	DIN DIN	Bezeichnung / Hinweise Designation / Indications	Abbildung Figure
6940510	1 1	roh <i>untreated</i>	R	Stulp-Grundbeschlag verdeckt, Ausführung mit Kniehebel FG max.: 160 kg FAB min. = 450 mm FAH min. = 720 mm (FAB/FAH max. = siehe zulässige Flügelgrößen)	
6940511	1 1	roh <i>untreated</i>	L	Double casement basic fitting concealed, <i>Version with toggle lever</i> <i>max. sash weight: 160 kg</i> <i>min. sash width = 450 mm</i> <i>min. sash height = 720 mm</i> <i>(max. sash width / height = see admissible sash sizes)</i>	
6940521	1 1	roh <i>untreated</i>	R	Stulp-Grundbeschlag verdeckt Ausführung mit Stulpgetriebe FG max.: 160 kg FAB min. = 450 mm FAH min. = 680 mm (FAB/FAH max. = siehe zulässige Flügelgrößen)	
6940522	1 1	roh <i>untreated</i>	L	Double casement basic fitting concealed <i>Version with double casement gear</i> <i>max. sash weight: 160 kg</i> <i>min. sash width = 450 mm</i> <i>min. sash height = 680 mm</i> <i>(max. sash width / height = see admissible sash sizes)</i>	

WICLINE 75

Kipp-Beschlag (verdeckt)
Tilt fitting (concealed)

Beschläge
Fittings



Artikel Article	VE PU	Farbe Colour	DIN DIN	Bezeichnung / Hinweise Designation / Indications	Abbildung Figure
6940514	1 1	roh <i>untreated</i>	R+L	<p>Kipp-Grundbeschlag verdeckt FG max.: 130 kg Kippflügel Hochformat: FAB min. = 600 mm FAH min. = 450 mm (FAB/FAH max. = siehe zulässige Flügelgrößen) Kippflügel Querformat: FAB min. = 425 mm FAH min. = 840 mm (FAB/FAH max. = siehe zulässige Flügelgrößen)</p> <p>Tilt basic fitting concealed <i>max. sash weight: 130 kg</i> <i>Tilt sash portrait format:</i> <i>min. sash width = 600 mm</i> <i>min. sash height = 450 mm</i> <i>(max. sash width / height = see admissible sash sizes)</i> <i>Tilt sash landscape format:</i> <i>min. sash width = 425 mm</i> <i>min. sash height = 840 mm</i> <i>(max. sash width / height = see admissible sash sizes)</i></p>	



Artikel Article	VE PU	Farbe Colour	DIN DIN	Bezeichnung / Hinweise Designation / Indications	Abbildung Figure
6940250	1	E6/C0	R	Dreh-Kipp-Grundbeschlag Schere Gr. 1 FG max.: bis 100 kg: ohne Zusatzschrauben > 100-130 kg: mit Zusatzschraube 6940258 oder bei Kämpfer-Stoßverbindung 6940259 > 130-160 kg: mit Zusatzschrauben 6940258 + 4070115 oder bei Kämpfer-Stoßverbindung 6940259 + 4070115 FAB min. = 425 mm FAB max. = 700 mm FAH min. = 600 mm (FAH max. = siehe zulässige Flügelgrößen)	
	5	E6/C0			
	20	E6/C0			
	1	Sonderfarbe			
	1	Niro-Design			
	1	RAL9016			
	5	RAL9016			
	20	RAL9016			
	1	anodized			
	5	anodized			
	20	anodized			
	1	Special colour			
	1	Niro design			
	1	RAL9016			
	5	RAL9016			
20	RAL9016				
6940251	1	E6/C0	L	Turn/Tilt basic fitting Retainer arm size 1 max. sash weight: up to 100 kg: without additional screws > 100-130 kg: with additional screw 6940258 or for transom butt-joint connections 6940259 > 130-160 kg: with additional screws 6940258 + 4070115 or for transom butt-joint connections 6940259 + 4070115 min. sash width = 425 mm max. sash width = 700 mm min. sash height = 600 mm (max. sash height = see admissible sash sizes)	
	5	E6/C0			
	20	E6/C0			
	1	Sonderfarbe			
	1	Niro-Design			
	1	RAL9016			
	5	RAL9016			
	20	RAL9016			
	1	anodized			
	5	anodized			
	20	anodized			
	1	Special colour			
	1	Niro design			
	1	RAL9016			
	5	RAL9016			
20	RAL9016				



Artikel Article	VE PU	Farbe Colour	DIN DIN	Bezeichnung / Hinweise Designation / Indications	Abbildung Figure
6940252	1	E6/C0	R	Dreh-Kipp-Grundbeschlag Schere Gr. 2 FG max.: bis 100 kg: ohne Zusatzschrauben > 100-130 kg: mit Zusatzschrauben 6940258 oder bei Kämpfer-Stoßverbindung 6940259 > 130-160 kg: mit Zusatzschrauben 6940258 + 4070115 oder bei Kämpfer-Stoßverbindung 6940259 + 4070115 FAB min. = 700 mm FAB ≥ 1400 mm: mit Zweitschere 6940257 FAH min. = 600 mm (FAB/FAH max. = siehe zulässige Flügelgrößen)	
	5	E6/C0			
	20	E6/C0			
	1	Sonderfarbe			
	1	Niro-Design			
	1	RAL9016			
	5	RAL9016			
	20	RAL9016			
	1	anodized			
	5	anodized			
	20	anodized			
	1	Special colour			
	1	Niro design			
	1	RAL9016			
	5	RAL9016			
20	RAL9016				
6940253	1	E6/C0	L	Turn/Tilt basic fitting Retainer arm size 2 max. sash weight: up to 100 kg: without additional screws > 100-130 kg: with additional screw 6940258 or for transom butt-joint connections 6940259 > 130-160 kg: with additional screws 6940258 + 4070115 or for transom butt-joint connections 6940259 + 4070115 min. sash width = 700 mm sash width ≥ 1400 mm: with turn/tilt second retainer arm 6940257 min. sash height = 600 mm (max. sash width / height = see admissible sash sizes)	
	5	E6/C0			
	20	E6/C0			
	1	Sonderfarbe			
	1	Niro-Design			
	1	RAL9016			
	5	RAL9016			
	20	RAL9016			
	1	anodized			
	5	anodized			
	20	anodized			
	1	Special colour			
	1	Niro design			
	1	RAL9016			
	5	RAL9016			
20	RAL9016				

WICLINE 75

Dreh-Kipp-Beschlag
Turn/Tilt fitting

Beschläge
Fittings



Artikel Article	VE PU	Farbe Colour	DIN DIN	Bezeichnung / Hinweise Designation / Indications	Abbildung Figure
6940254	1	E6/C0	R	Dreh-Kipp-Grundbeschlag FG max.: 200 kg FAB min. = 700 mm FAB >= 1400 mm: mit Zweitschere 6940335 DIN R oder 6940336 DIN L FAH min. = 600 mm (FAB/FAH max. = siehe zulässige Flügelgrößen)	
	1	Sonderfarbe			
	1	<i>anodized</i>			
	1	<i>Special colour</i>			
6940255	1	E6/C0	L	Turn/Tilt basic fitting max. sash weight: 200 kg min. sash width = 700 mm sash width >= 1400 mm: with second retainer arm 6940335 DIN R or 6940336 DIN L min. sash height = 600 mm (max. sash width / height = see admissible sash sizes)	
	1	Sonderfarbe			
	1	<i>anodized</i>			
	1	<i>Special colour</i>			

WICLINE 75

Schräg / Rundbogen Dreh-Kipp-Beschlag
Sloped / arched turn/tilt fitting

Beschläge
Fittings



Artikel Article	VE PU	Farbe Colour	DIN DIN	Bezeichnung / Hinweise Designation / Indications	Abbildung Figure
6940317	1	E6/C0	R	Schräg-Rundbogen Grundbeschlag Schräg-Beschlag: max. Flügelgewicht = 80 kg min. Flügelbreite = 490 mm max. Flügelbreite = 1300 mm min. Flügelhöhe = 600 mm max. Flügelhöhe = 1700 mm	
	1	Sonderfarbe			
	1	RAL9016			
	1	anodized			
	1	Special colour			
	1	RAL9016			
6940318	1	E6/C0	L	Rundbogen-Beschlag: max. Flügelgewicht = 80 kg min. Flügelbreite = 700 mm max. Flügelbreite = 1300 mm min. Flügelhöhe = 600 mm max. Flügelhöhe = 1900 mm Oblique and semi-circular arch basic fitting <i>Oblique fitting</i> max. sash weight = 80 kg min. sash width = 490 mm max. sash width = 1300 mm min. sash height = 600 mm max. sash height = 1700 mm <i>semi-circular arch fitting</i> max. sash weight = 80 kg min. sash width = 700 mm max. sash width = 1300 mm min. sash height = 600 mm max. sash height = 1900 mm	
	1	Sonderfarbe			
	1	RAL9016			
	1	anodized			
	1	Special colour			
	1	RAL9016			



Artikel Article	VE PU	Farbe Colour	DIN DIN	Bezeichnung / Hinweise Designation / Indications	Abbildung Figure
6940260	1	E6/C0	R	Tilt-First-Grundbeschlag Schere Gr. 1 FG max.: bis 100 kg: ohne Zusatzschrauben > 100-130 kg: mit Zusatzschrauben 6940258 oder bei Kämpfer-Stoßverbindung 6940259 > 130-160 kg: mit Zusatzschrauben 6940258 + 4070115 oder bei Kämpfer-Stoßverbindung 6940259 + 4070115 FAB min. = 425 mm FAB max. = 700 mm FAH min. = 600 mm (FAB/FAH max. = siehe zulässige Flügelgrößen)	
	5	E6/C0			
	1	Sonderfarbe			
	1	Niro-Design			
	1	RAL9016			
	5	RAL9016			
	1	anodized			
	5	anodized			
	1	Special colour			
	1	Niro design			
	1	RAL9016			
	5	RAL9016			
	6940261	1			
5		E6/C0			
1		Sonderfarbe			
1		Niro-Design			
1		RAL9016			
5		RAL9016			
1		anodized			
5		anodized			
1		Special colour			
1		Niro design			
1		RAL9016			
5		RAL9016			



Artikel Article	VE PU	Farbe Colour	DIN DIN	Bezeichnung / Hinweise Designation / Indications	Abbildung Figure
6940262	1	E6/C0	R	Tilt-First-Grundbeschlag Schere Gr. 2 FG max.: bis 100 kg: ohne Zusatzschrauben > 100-130 kg: mit Zusatzschrauben 6940258 oder bei Kämpfer-Stoßverbindung 6940259 > 130-160 kg: mit Zusatzschrauben 6940258 + 4070115 oder bei Kämpfer-Stoßverbindung 6940259 + 4070115 FAB min. = 700 mm FAB ≥ 1400 mm: mit Zweitschere 6940266 FAH min. = 600 mm (FAB/FAH max. = siehe zulässige Flügelgrößen)	
	5	E6/C0			
	1	Sonderfarbe			
	1	Niro-Design			
	1	RAL9016			
	5	RAL9016			
	1	anodized			
	5	anodized			
	1	Special colour			
	1	Niro design			
	1	RAL9016			
	5	RAL9016			
	6940263	1			
5		E6/C0			
1		Sonderfarbe			
1		Niro-Design			
1		RAL9016			
5		RAL9016			
1		anodized			
5		anodized			
1		Special colour			
1		Niro design			
1		RAL9016			
5		RAL9016			

WICLINE 75

Dreh-Beschlag
Turn fitting

Beschläge
Fittings



Artikel Article	VE PU	Farbe Colour	DIN DIN	Bezeichnung / Hinweise Designation / Indications	Abbildung Figure
6940267	1	E6/C0	R	Dreh-Grundbeschlag FG max.: bis 100 kg: ohne Zusatzschrauben > 100-130 kg: mit Zusatzschrauben 6940258 oder bei Kämpfer-Stoßverbindung 6940259 > 130-160 kg: mit Zusatzschrauben 6940258 + 4070115 oder bei Kämpfer-Stoßverbindung 6940259 + 4070115 FAB min. = 425 mm FAH min. = 600 mm (FAB/FAH max. = siehe zulässige Flügelgrößen) Turn basic fitting <i>max. sash weight:</i> <i>up to 100 kg: without additional screws</i> <i>> 100-130 kg: with additional screw 6940258 or</i> <i>for transom butt-joint connections</i> 6940259 <i>> 130-160 kg: with additional screws 6940258 +</i> <i>4070115 or</i> <i>for transom butt-joint connections</i> 6940259 + 4070115 <i>min. sash width = 425 mm</i> <i>min. sash height = 600 mm</i> <i>(max. sash width / height = see admissible sash</i> <i>sizes)</i>	
	5	E6/C0			
	20	E6/C0			
	1	Sonderfarbe			
	1	Niro-Design			
	1	RAL9016			
	5	RAL9016			
	20	RAL9016			
	1	<i>anodized</i>			
	5	<i>anodized</i>			
	20	<i>anodized</i>			
	1	<i>Special colour</i>			
	1	<i>Niro design</i>			
	1	<i>RAL9016</i>			
5	<i>RAL9016</i>				
20	<i>RAL9016</i>				
6940268	1	E6/C0	L	Dreh-Grundbeschlag FG max.: bis 100 kg: ohne Zusatzschrauben > 100-130 kg: mit Zusatzschrauben 6940258 oder bei Kämpfer-Stoßverbindung 6940259 > 130-160 kg: mit Zusatzschrauben 6940258 + 4070115 oder bei Kämpfer-Stoßverbindung 6940259 + 4070115 FAB min. = 425 mm FAH min. = 600 mm (FAB/FAH max. = siehe zulässige Flügelgrößen) Turn basic fitting <i>max. sash weight:</i> <i>up to 100 kg: without additional screws</i> <i>> 100-130 kg: with additional screw 6940258 or</i> <i>for transom butt-joint connections</i> 6940259 <i>> 130-160 kg: with additional screws 6940258 +</i> <i>4070115 or</i> <i>for transom butt-joint connections</i> 6940259 + 4070115 <i>min. sash width = 425 mm</i> <i>min. sash height = 600 mm</i> <i>(max. sash width / height = see admissible sash</i> <i>sizes)</i>	
	5	E6/C0			
	20	E6/C0			
	1	Sonderfarbe			
	1	Niro-Design			
	1	RAL9016			
	5	RAL9016			
	20	RAL9016			
	1	<i>anodized</i>			
	5	<i>anodized</i>			
	20	<i>anodized</i>			
	1	<i>Special colour</i>			
	1	<i>Niro design</i>			
	1	<i>RAL9016</i>			
5	<i>RAL9016</i>				
20	<i>RAL9016</i>				

WICLINE 75

Dreh-Beschlag
Turn fitting

Beschläge
Fittings



Artikel Article	VE PU	Farbe Colour	DIN DIN	Bezeichnung / Hinweise Designation / Indications	Abbildung Figure
6940269	1 1 1 1 1 1 1 1	E6/C0 Sonderfarbe Niro-Design RAL9016 <i>anodized</i> <i>Special colour</i> <i>Niro design</i> <i>RAL9016</i>	R	Dreh-Grundbeschlag, verstellbar FG max.: bis 100 kg: ohne Zusatzschrauben > 100-130 kg: mit Zusatzschrauben 6940258 oder bei Kämpfer-Stoßverbindung 6940259 > 130-160 kg: mit Zusatzschrauben 6940258 + 4070115 oder bei Kämpfer-Stoßverbindung 6940259 + 4070115	
6940270	1 1 1 1 1 1 1 1	E6/C0 Sonderfarbe Niro-Design RAL9016 <i>anodized</i> <i>Special colour</i> <i>Niro design</i> <i>RAL9016</i>	L	FAB min. = 425 mm FAH min. = 600 mm (FAB/FAH max. = siehe zulässige Flügelgrößen) Turn basic fitting, adjustable <i>max. sash weight:</i> <i>up to 100 kg: without additional screws</i> <i>> 100-130 kg: with additional screw 6940258 or</i> <i>for transom butt-joint connections</i> 6940259 <i>> 130-160 kg: with additional screws 6940258 +</i> <i>4070115 or</i> <i>for transom butt-joint connections</i> 6940259 + 4070115 <i>min. sash width = 425 mm</i> <i>min. sash height = 600 mm</i> <i>(max. sash width / height = see admissible sash</i> <i>sizes)</i>	
6940341	1 1 1 1	E6/C0 Sonderfarbe <i>anodized</i> <i>Special colour</i>	R	Dreh-Grundbeschlag FG max.: 200 kg FAB min. = 425 mm FAH min. = 600 mm (FAB/FAH max. = siehe zulässige Flügelgrößen)	
6940342	1 1 1 1	E6/C0 Sonderfarbe <i>anodized</i> <i>Special colour</i>	L	Turn basic fitting <i>max. sash weight: 200 kg</i> <i>min. sash width = 425 mm</i> <i>min. sash height = 600 mm</i> <i>(max. sash width / height = see admissible sash</i> <i>sizes)</i>	

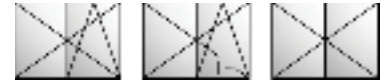

Artikel Article	VE PU	Farbe Colour	DIN DIN	Bezeichnung / Hinweise Designation / Indications	Abbildung Figure
6940275	1	E6/C0	R	Stulp-Grundbeschlag Standard Ausführung mit Kniehebel FG max.: bis 100 kg: ohne Zusatzschrauben > 100-130 kg: mit Zusatzschrauben 6940258 oder bei Kämpfer-Stoßverbindung 6940259 > 130-160 kg: mit Zusatzschrauben 6940258 + 4070115 oder bei Kämpfer-Stoßverbindung 6940259 + 4070115 FAB min. = 425 mm FAH min. = 720 mm (FAB/FAH max. = siehe zulässige Flügelgrößen)	
	5	E6/C0			
	1	Sonderfarbe			
	1	Niro-Design			
	1	RAL9016			
	5	RAL9016			
	1	anodized			
	5	anodized			
	1	Special colour			
	1	Niro design			
	1	RAL9016			
	5	RAL9016			
6940276	1	E6/C0	L	Double casement basic fitting, Standard Version with toggle lever max. sash weight: up to 100 kg: without additional screws: > 100-130 kg: with additional screw 6940258 or for transom butt-joint connections 6940259 > 130-160 kg: with additional screws 6940258 + 4070115 or for transom butt-joint connections 6940259 + 4070115 min. sash width = 425 mm min. sash height = 720 mm (max. sash width / height = see admissible sash sizes)	
	5	E6/C0			
	1	Sonderfarbe			
	1	Niro-Design			
	1	RAL9016			
	5	RAL9016			
	1	anodized			
	5	anodized			
	1	Special colour			
	1	Niro design			
	1	RAL9016			
	5	RAL9016			

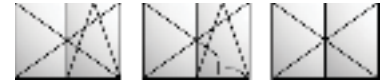

Artikel Article	VE PU	Farbe Colour	DIN DIN	Bezeichnung / Hinweise Designation / Indications	Abbildung Figure
6940277	1 1 1 1 1 1 1 1	E6/C0 Sonderfarbe Niro-Design RAL9016 <i>anodized</i> <i>Special colour</i> <i>Niro design</i> <i>RAL9016</i>	R	Stulp-Grundbeschlag, verstellbar Ausführung mit Kniehebel FG max.: bis 100 kg: ohne Zusatzschrauben > 100-130 kg: mit Zusatzschraube 6940258 oder bei Kämpfer-Stoßverbindung 6940259 > 130-160 kg: mit Zusatzschrauben 6940258 + 4070115 oder bei Kämpfer-Stoßverbindung 6940259 + 4070115	
6940278	1 1 1 1 1 1 1 1	E6/C0 Sonderfarbe Niro-Design RAL9016 <i>anodized</i> <i>Special colour</i> <i>Niro design</i> <i>RAL9016</i>	L	FAB min. = 425 mm FAH min. = 720 mm (FAB/FAH max. = siehe zulässige Flügelgrößen) Double casement basic fitting, adjustable <i>Version with toggle lever</i> <i>max. sash weight:</i> <i>up to 100 kg: without additional screws:</i> <i>> 100-130 kg: with additional screw 6940258 or</i> <i>for transom butt-joint connections</i> <i>6940259</i> <i>> 130-160 kg: with additional screws 6940258 +</i> <i>4070115 or</i> <i>for transom butt-joint connections</i> <i>6940259 + 4070115</i> <i>min. sash width = 425 mm</i> <i>min. sash height = 720 mm</i> <i>(max. sash width / height = see admissible sash</i> <i>sizes)</i>	

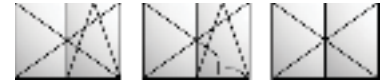



Artikel Article	VE PU	Farbe Colour	DIN DIN	Bezeichnung / Hinweise Designation / Indications	Abbildung Figure
6940308	1 1 1 1 1 1 1 1	E6/C0 Sonderfarbe Niro-Design RAL9016 <i>anodized</i> <i>Special colour</i> <i>Niro design</i> RAL9016	R	Stulp-Grundbeschlag Standard Ausführung mit Stulpgetriebe FG max.: bis 100 kg: ohne Zusatzschrauben > 100-130 kg: mit Zusatzschraube 6940258 oder bei Kämpfer-Stoßverbindung 6940259 > 130-160 kg: mit Zusatzschrauben 6940258 + 4070115 oder bei Kämpfer-Stoßverbindung 6940259 + 4070115	
6940309	1 1 1 1 1 1 1 1	E6/C0 Sonderfarbe Niro-Design RAL9016 <i>anodized</i> <i>Special colour</i> <i>Niro design</i> RAL9016	L	FAB min. = 425 mm FAH min. = 680 mm (FAB/FAH max. = siehe zulässige Flügelgrößen) Double casement basic fitting, Standard Version with double casement gear max. sash weight: up to 100 kg: without additional screws: > 100-130 kg: with additional screw 6940258 or for transom butt-joint connections 6940259 > 130-160 kg: with additional screws 6940258 + 4070115 or for transom butt-joint connections 6940259 + 4070115 min. sash width = 425 mm min. sash height = 680 mm (max. sash width / height = see admissible sash sizes)	

WICLINE 75

Stulp-Beschlag
Double casement fitting

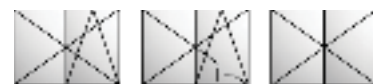
Beschläge
Fittings



Artikel Article	VE PU	Farbe Colour	DIN DIN	Bezeichnung / Hinweise Designation / Indications	Abbildung Figure
6940310	1 1 1 1 1 1 1 1	E6/C0 Sonderfarbe Niro-Design RAL9016 <i>anodized</i> <i>Special colour</i> <i>Niro design</i> <i>RAL9016</i>	R	Stulp-Grundbeschlag, verstellbar Ausführung mit Stulpgetriebe FG max.: bis 100 kg: ohne Zusatzschrauben > 100-130 kg: mit Zusatzschraube 6940258 oder bei Kämpfer-Stoßverbindung 6940259 > 130-160 kg: mit Zusatzschrauben 6940258 + 4070115 oder bei Kämpfer-Stoßverbindung 6940259 + 4070115	
6940311	1 1 1 1 1 1 1 1	E6/C0 Sonderfarbe Niro-Design RAL9016 <i>anodized</i> <i>Special colour</i> <i>Niro design</i> <i>RAL9016</i>	L	FAB min. = 425 mm FAH min. = 680 mm (FAB/FAH max. = siehe zulässige Flügelgrößen) Double casement basic fitting, adjustable <i>Version with double casement gear</i> <i>max. sash weight:</i> <i>up to 100 kg: without additional screws:</i> <i>> 100-130 kg: with additional screw 6940258 or</i> <i>for transom butt-joint connections</i> <i>6940259</i> <i>> 130-160 kg: with additional screws 6940258 +</i> <i>4070115 or</i> <i>for transom butt-joint connections</i> <i>6940259 + 4070115</i> <i>min. sash width = 425 mm</i> <i>min. sash height = 680 mm</i> <i>(max. sash width / height = see admissible sash</i> <i>sizes)</i>	



Artikel Article	VE PU	Farbe Colour	DIN DIN	Bezeichnung / Hinweise Designation / Indications	Abbildung Figure
6940285	1 5 1 1 1 5 1 5 1 1 1 5	E6/C0 E6/C0 Sonderfarbe Niro-Design RAL9016 RAL9016 <i>anodized</i> <i>anodized</i> <i>Special colour</i> <i>Niro design</i> RAL9016 RAL9016	R+L	<p>Kipp-Grundbeschlag FG max.: 130 kg Kippflügel Hochformat: FAB min. = 425 mm FAH min. = 700 mm (FAB/FAH max. = siehe zulässige Flügelgrößen) Kippflügel Querformat: FAB min. = 600 mm FAH min. = 425 mm (FAB/FAH max. = siehe zulässige Flügelgrößen)</p> <p>Tilt basic fitting <i>max. sash weight: 130 kg</i> <i>Tilt sash portrait format:</i> <i>min. sash width = 425 mm</i> <i>min. sash height = 700 mm</i> <i>(max. sash width / height = see admissible sash sizes)</i> <i>Tilt sash landscape format:</i> <i>min. sash width = 600 mm</i> <i>min. sash height = 425 mm</i> <i>(max. sash width / height = see admissible sash sizes)</i></p>	

Lüftungsklappenbeschlag

(Grundbeschläge/Zusatzbeschläge/Antriebe)

Fittings for ventilation flap

(basic fittings/additional fittings/window drives)



Artikel Article	VE PU	Farbe Colour	DIN DIN	Bezeichnung / Hinweise Designation / Indications	Abbildung Figure
6050359	1 1 1 1 1 1 1 1	E6/C0 Sonderfarbe Niro-Design RAL9016 <i>anodized</i> <i>Special colour</i> <i>Niro design</i> <i>RAL9016</i>	R+L	Dreh-Band-Grundbeschlag für Lüftungsklappe max. Flügelgewicht = 80 kg max. Flügelhöhe = 3000 mm Turn basic fitting for ventilation flap max. sash weight = 80 kg max. sash height = 3000 mm	
6050352	1 1	roh <i>untreated</i>	R	Grundbeschlag verdeckt für Lüftungsklappe max. Flügelgewicht = 80 kg max. Flügelhöhe = 3000 mm	
6050353	1 1	roh <i>untreated</i>	L	Basic fitting concealed for ventilation flap max. sash weight = 80 kg max. sash height = 3000 mm	
6050356	1 1	roh <i>untreated</i>	R+L	Verriegelungs-Set für Lüftungsklappe senkrecht Lock set for ventilation flap vertical	
6050351	1 1	roh <i>untreated</i>	R+L	Mittelverriegelung im Falz für Lüftungsklappe > 1600 mm 1x > 2750 mm 2x Centre lock in rebate for ventilation flap > 1600 mm 1x > 2750 mm 2x	
6050358	1 1	roh <i>untreated</i>	R+L	Drehbegrenzer für Lüftungsklappe 250 mm Öffnungsweite = 90° Nur bei Beschlag aufliegend verwendbar Turn limiter for ventilation flap 250 mm opening width = 90° Applicable only in combination with top mounted fittings	

Lüftungsklappenbeschlag
(Grundbeschläge/Zusatzbeschläge/Antriebe)
Fittings for ventilation flap
(basic fittings/additional fittings/window drives)



Artikel Article	VE PU	Farbe Colour	DIN DIN	Bezeichnung / Hinweise Designation / Indications	Abbildung Figure
6050238	1 1	roh <i>untreated</i>	R	<p>Lüftungsklappenantrieb Komplett verdeckt liegendes Antriebssystem zur 90° Drehöffnung max. Flügelgewicht = 80 kg Flügelbreite = 250 mm max. Flügelhöhe = 3000 mm Vormontierte Moduleinheiten auf einem Profilkopfstück bestehend aus:</p> <ul style="list-style-type: none"> - Antriebseinheit m. integrierter Antriebselektronik - Verriegelungseinheit - zerstörungsfreie Beschlags-Notentriegelung - Stirnseitiger Schwenkhebel mit Gleitstücken - Magnetschalter zur genauen Endlagepositionierung beim Schließen - verdeckt liegender trennbarer Kabelübergang <p>Technische Daten: Spannung: 24 V DC Restwelligkeit: max. 2 Vss Abschaltstrom: (einstellbar): max. 0,7 A Einschaltdauer: ED 30 % (10 Min.) Öffnungswinkel: (einstellbar): max. 90 Grad Öffnungsdauer: (einstellbar): ca. 15 s Schließdauer: (einstellbar): ca. 35 s Lebensdauer: min. 20.000 Zyklen Umgebungstemperatur: -5 °C....75 °C Kabel: 6-adrig (2 x 0,34 mm², 4 x 0,14 mm²) Ø ca. 5mm; Länge ca. 2000 mm</p>	
6050239	1 1	roh <i>untreated</i>	L		

WICLINE 75

Lüftungsklappenbeschlag

(Grundbeschläge/Zusatzbeschläge/Antriebe)

Fittings for ventilation flap

(basic fittings/additional fittings/window drives)



Artikel Article	VE PU	Farbe Colour	DIN DIN	Bezeichnung / Hinweise Designation / Indications	Abbildung Figure
6050238	1 1	roh <i>untreated</i>	R	<p>Ventilation flap drive Completely concealed drive system for 90° turn opening max. sash weight = 80 kg Sash width = 250 mm max. sash height = 3000 mm</p>	
6050239	1 1	roh <i>untreated</i>	L	<p>Premounted modular units on a profile head piece consisting of:</p> <ul style="list-style-type: none"> - drive unit with integrated drive electronics - locking unit - damage-free emergency unlocking device - front sided swing lever with gliding parts - Magnet switch for precise end positioning during closure - concealed unpluggable cable transition <p>Technical data: Tension: 24 V DC Ripple: max. 2 Vss Cut-off current: (adjustable): max. 0,7 A Switch-on time: ED 30 % (10 Min.) Opening angle: (adjustable): max. 90 Degrees Opening time: (adjustable): approx. 15 s Closing time: (adjustable): approx. 35 s Working life: min. 20.000 cycles Ambient temperature: -5 °C....75 °C Cable: 6 wires (2 x 0,34 mm², 4 x 0,14 mm²), Ø approx. 5mm; Length approx. 2000 mm</p>	



Artikel Article	VE PU	Farbe Colour	DIN DIN	Bezeichnung / Hinweise Designation / Indications	Abbildung Figure
6950104	1 25 1 1 1 25 1 25 1 1 1 25	E6/C0 E6/C0 Sonderfarbe Niro-Design RAL9016 RAL9016 <i>anodized</i> <i>anodized</i> <i>Special colour</i> <i>Niro design</i> RAL9016 RAL9016	R+L	<p>OL 80 Grundbeschlag, aufliegend mit Handhebel für Kippflügel einwärts max. Flügelgewicht = 80 kg (Sonderanwendung bis max. 120 kg möglich) Öffnungsweite ca. 190 mm Flügelbreite 425 - 1300 mm (mit 2. Schere) 1301 - 2250 mm Platzbedarf Blendrahmen 22,5 mm ACHTUNG! Sicherheitsscheren zwingend erforderlich Schablone: 5910030</p> <p>OL 80 Fanlight basic fitting, surface mounted <i>with hand lever</i> <i>for tilt sash inwards</i> <i>max. sash weight = 80 kg</i> <i>(special application up to</i> <i>max. 120 kg is possible)</i> <i>Opening width: approx. 190 mm</i> <i>Sash width 425 - 1300 mm</i> <i>(with 2 retainer arms) 1301 - 2250 mm</i> <i>Space required on frame: 22,5 mm</i> ATTENTION! <i>Use of safety retainer arms is mandatory</i> <i>Template: 5910030</i></p>	
6950105	1 25 1 1 1 25 1 25 1 1 1 25	E6/C0 E6/C0 Sonderfarbe Niro-Design RAL9016 RAL9016 <i>anodized</i> <i>anodized</i> <i>Special colour</i> <i>Niro design</i> RAL9016 RAL9016	R+L	<p>OL Zweitschere, aufliegend für Kippflügel einwärts max. Flügelgewicht = 80 kg (Sonderanwendung bis max. 120 kg möglich) Öffnungsweite ca. 190 mm Flügelbreite ab 1301 mm Platzbedarf Blendrahmen 22,5 mm ACHTUNG! Sicherheitsscheren zwingend erforderlich Schablone: 5910030</p> <p>Fanlight second retainer arm, surface mounted <i>for tilt sash inward</i> <i>max. sash weight = 80 kg</i> <i>(special application up to</i> <i>max. 120 kg is possible)</i> <i>Opening width: approx. 190 mm</i> <i>Sash width from 1301 mm</i> <i>Space required on frame: 22,5 mm</i> ATTENTION! <i>Use of safety retainer arms is mandatory</i> <i>Template: 5910030</i></p>	

WICLINE 75

Oberlicht-Beschlag
Fanlight fitting

Beschläge
Fittings



Artikel Article	VE PU	Farbe Colour	DIN DIN	Bezeichnung / Hinweise Designation / Indications	Abbildung Figure
6940519	1 1	roh <i>untreated</i>		Kippband Garnitur, verdeckt, max. Flügelgewicht 130 kg <i>Tilt hinge set, concealed, max. sash weight 130 kg</i>	
6940314	1 5 20 1 1 1 5 20 1 5 20 1 1 1 5 20	E6/C0 E6/C0 E6/C0 Sonderfarbe Niro-Design RAL9016 RAL9016 RAL9016 <i>anodized</i> <i>anodized</i> <i>anodized</i> <i>Special colour</i> <i>Niro design</i> <i>RAL9016</i> <i>RAL9016</i> <i>RAL9016</i>	R+L	Kippband Garnitur, aufliegend <i>Tilt hinge set, surface mounted</i>	
6940315	1 1	roh <i>untreated</i>	R+L	Kippscheren- Set, aufliegender Beschlag <i>Tilt retainer arm set, surface mounted fitting</i>	



Artikel Article	VE PU	Farbe Colour	DIN DIN	Bezeichnung / Hinweise Designation / Indications	Abbildung Figure
6051029	1 1	roh <i>untreated</i>	R+L	<p>OL Kipp-Sicherungs- und Putzschere (KSP-Schere) Größe 1 Flügel und Rahmen klemmbar Öffnungsweite in Sicherheitsstellung ca. 220 - 350 mm Öffnungswinkel in Putzstellung ca. 60° - 90° max. Flügelgewicht = 40 kg max. Flügelhöhe = 500 mm</p> <p>Fanlight tilt safe-guard and detachable retainer arm (KSP- retainer arm) size 1 sash and frame can be clamped opening width in safety position approx. 220 - 350 mm opening width in cleaning position approx. 60° - 90° max. sash weight = 40 kg max. sash height = 500 mm</p>	
6051030	1 1	roh <i>untreated</i>	R+L	<p>OL Kipp-Sicherungs- und Putzschere (KSP-Schere) Größe 2 Flügel und Rahmen klemmbar Öffnungsweite in Sicherheitsstellung: ca. 220 - 350 mm Öffnungswinkel in Putzstellung: ca. 60° - 90° max. Flügelgewicht = 40 kg max. Flügelhöhe = 1200 mm</p> <p>Fanlight tilt safe-guard and detachable retainer arm (KSP- retainer arm) size 2 sash and frame can be clamped opening width in safety position: approx. 220 - 350 mm in cleaning position: approx. 60° - 90° max. sash weight = 40 kg max. sash height = 1200 mm</p>	



Artikel Article	VE PU	Farbe Colour	DIN DIN	Bezeichnung / Hinweise Designation / Indications	Abbildung Figure
6051068	1 1	roh <i>untreated</i>	R+L	<p>OL Falzschere Spannweite 150 mm Flügel und Rahmen klemmbar max. Flügelgewicht = 80 kg (Sonderanwendung bis 120 kg) max. Flügelhöhe = 1700 mm</p> <p>Fanlight tilt rebate retainer arm <i>span width 150 mm</i> <i>sash and frame can be clamped</i> <i>max. sash weight = 80 kg</i> <i>(Special application up to 120 kg)</i> <i>max. sash height = 1700 mm</i></p>	
6051062	1 1	roh <i>untreated</i>	R+L	<p>OL Falzschere Spannweite 250 mm Flügel und Rahmen klemmbar max. Flügelgewicht = 80 kg (Sonderanwendung bis 120 kg) max. Flügelhöhe = 1700 mm</p> <p>Fanlight tilt rebate retainer arm <i>span width 250 mm</i> <i>sash and frame can be clamped</i> <i>max. sash weight = 80 kg</i> <i>(Special application up to 120 kg)</i> <i>max. sash height = 1700 mm</i></p>	
6051066	1 1	roh <i>untreated</i>	R+L	<p>OL Falzschere Spannweite 400 mm Flügel und Rahmen klemmbar max. Flügelgewicht = 80 kg max. Flügelhöhe = 1700 mm</p> <p>Anwendung bei Kipfenster einwärts und elektromotorischem Antrieb für Direktausstellung (Ketten- oder Spindeltrieb) Achtung: Hubweg beachten !</p> <p>Fanlight tilt rebate retainer arm <i>span width 400 mm</i> <i>sash and frame can be clamped</i> <i>max. sash weight = 80 kg</i> <i>max. sash height = 1700 mm</i></p> <p><i>application for tilt window,</i> <i>inwards and electromotive drive</i> <i>for direct opening</i> <i>(chain or spindle drive)</i> <i>pay attention to throw!</i></p>	

WICLINE 75

Oberlicht-Beschlag
Fanlight fitting

Beschläge
Fittings



Artikel Article	VE PU	Farbe Colour	DIN DIN	Bezeichnung / Hinweise Designation / Indications	Abbildung Figure
6051067	1 1	roh <i>untreated</i>	R+L	<p>OL Falzschere Spannweite 600 mm Flügel und Rahmen klemmbar max. Flügelgewicht = 80 kg max. Flügelhöhe = 1700 mm</p> <p>Anwendung bei Kippfenster einwärts und elektromotorischem Antrieb für Direktausstellung (Ketten- oder Spindeltrieb) Achtung: Hubweg beachten !</p> <p>Fanlight tilt rebate retainer arm <i>span width 600 mm</i> <i>sash and frame can be clamped</i> <i>max. sash weight = 80 kg</i> <i>max. sash height = 1700 mm</i></p> <p><i>application for tilt window,</i> <i>inwards and electromotive drive</i> <i>for direct opening</i> <i>(chain or spindle drive)</i> <i>pay attention to throw!</i></p>	
6051070	1 1 1 1 1 1 1 1	E6/C0 Sonderfarbe Niro-Design RAL9016 <i>anodized</i> <i>Special colour</i> <i>Niro design</i> <i>RAL9016</i>	R+L	<p>OL Mitnehmergarnitur ZV/F In Verbindung mit einer verdeckt im Falz liegenden Zusatzverriegelung min. Flügelbreite = 550 mm</p> <p>Fanlight driving dog set ZV/F <i>in connection with concealed additional</i> <i>lock in rebate</i> <i>min. sash width = 550 mm</i></p>	
6950106	1 1 1 1	weiß schwarz <i>white</i> <i>black</i>	R+L	<p>BZ Eckumlenkung in Verbindung mit 6950105 Zweitschere</p> <p>Bag Corner transmission <i>in connection with second retainer arm 6950105</i></p>	
6051014	1 1 1 1 1 1 1 1	E6/C0 Sonderfarbe Niro-Design RAL9016 <i>anodized</i> <i>Special colour</i> <i>Niro design</i> <i>RAL9016</i>	R+L	<p>OL Handhebel schwenkbar Hebelhub 58 mm Schablone: 5910030</p> <p>Fanlight hand lever, swivable <i>Lever stroke 58 mm</i> <i>Template: 5910030</i></p>	

WICLINE 75

Oberlicht-Beschlag
Fanlight fitting

Beschläge
Fittings



Artikel Article	VE PU	Farbe Colour	DIN DIN	Bezeichnung / Hinweise Designation / Indications	Abbildung Figure
6051016	1 1	roh <i>untreated</i>	R+L	<p>OL Getriebe Typ 1 Getriebe Einsatz vertikal mit Getriebe 200 A Anlenkung SPGE/PFL 135 mm bei Getriebe Einsatz horizontal als Eckwinkelgetriebe zusätzlich Zubehör 6051018 erforderlich Schablone: 5910032</p> <p>Fanlight gear Type 1 <i>for vertical application with gear 200 A stroke SPGE/PFL 135 mm Additional necessary accessory 6051018 for horizontal application as corner angle gear Template: 5910032</i></p>	
6051018	1 1 1 1 1 1	grau weiß schwarz <i>grey white black</i>	R+L	<p>OL Zubehör für Getriebe Typ 1</p> <p>Fanlight accessory for gear Type 1</p>	
6950108	1 1 1 1	weiß schwarz <i>white black</i>	R	<p>OL Spindelgetriebe Typ 201 E Eckwinkelgetriebe einsetzbar für Winkel von 60° - 135° biegsam Schablone: 5910031</p> <p>Fanlight Spindle gear Typ 201 E <i>Corner angle gear applicable for angle from 60° - 135° flexible Template: 5910031</i></p>	
6950109	1 1 1 1	weiß schwarz <i>white black</i>	L	<p>OL Spindelgetriebe Typ 201 E Eckwinkelgetriebe einsetzbar für Winkel von 60° - 135° biegsam Schablone: 5910031</p> <p>Fanlight Spindle gear Typ 201 E <i>Corner angle gear applicable for angle from 60° - 135° flexible Template: 5910031</i></p>	
6051186	1 1 1 1 1 1	grau weiß schwarz <i>grey white black</i>	R+L	<p>OL 80 Flügelbock für Schräg-Oberlichtfenster</p> <p>OL 80 Fanlight sash bracket <i>for sloped fanlight window</i></p>	



Artikel Article	VE PU	Farbe Colour	DIN DIN	Bezeichnung / Hinweise Designation / Indications	Abbildung Figure
6051028	1 1	roh <i>untreated</i>	R+L	OL Kettenführung für 2-flg. Fenster Für 2-flg. Fenster neben- oder übereinander nur mit einer Betätigung in Verbindung mit OL Zugstange zum Einhängen sowie OL Zugstangenführungen Fanlight chain guide for double leaf windows <i>For 2 sashes adjacent to one another for over one another only with one actuation in conjunction with Fanlight pull rod and Fanlight pull rod guides</i>	
6051021	1 1 1 1 1 1	grau weiß schwarz <i>grey white black</i>	R+L	OL Zubehör für Kurbelstange, abnehmbar für Getriebe Typ 1 und Typ 2 Fanlight accessory for cranked connecting rod, detachable <i>for gear Type 1 and Type 2</i>	
6051022	1 1 1 1 1 1	grau weiß schwarz <i>grey white black</i>	R+L	OL Zubehör für Kurbelstange, fest für Getriebe Typ 1 und Typ 2 Fanlight accessory for cranked connecting rod, fixed <i>for gear Type 1 and Type 2</i>	
6051023	1 1 1 1 1 1	grau weiß schwarz <i>grey white black</i>	R+L	OL Zubehör für Kurbelstange abnehmbar, mit Gelenkübertragung für Getriebe Typ 1 und Typ 2 Fanlight accessory for cranked connecting rod detachable, with cardan transmission <i>for gear Type 1 and Type 2</i>	
6051024	1 1 1 1 1 1	grau weiß schwarz <i>grey white black</i>	R+L	OL Zubehör für Kurbelstange fest, mit Gelenkübertragung für Getriebe Typ 1 und Typ 2 Fanlight accessory for cranked connecting rod, fixed with cardan transmission <i>for gear Type 1 and Type 2</i>	

WICLINE 75

Oberlicht-Beschlag
Fanlight fitting

Beschläge
Fittings



Artikel Article	VE PU	Farbe Colour	DIN DIN	Bezeichnung / Hinweise Designation / Indications	Abbildung Figure
6051039	1 1 1 1 1 1 1 1	E6/C0 Sonderfarbe Niro-Design RAL9016 <i>anodized</i> <i>Special colour</i> <i>Niro design</i> <i>RAL9016</i>	R+L	OL Kurbelstange, abnehmbar, fertig vormontiert gestreckte Länge = 1500 mm Fanlight cranked connecting rod, detachable, pre-assembled stretched length = 1500 mm	
6051040	1 1 1 1 1 1 1 1	E6/C0 Sonderfarbe Niro-Design RAL9016 <i>anodized</i> <i>Special colour</i> <i>Niro design</i> <i>RAL9016</i>	R+L	OL Kurbelstange, fest, fertig vormontiert gestreckte Länge = 1500 mm Fanlight cranked connecting rod, fix, pre-assembled stretched length = 1500 mm	
6051041	1 1 1 1 1 1 1 1	E6/C0 Sonderfarbe Niro-Design RAL9016 <i>anodized</i> <i>Special colour</i> <i>Niro design</i> <i>RAL9016</i>	R+L	OL LM-Rohr lose, für Selbstmontage Länge = 2000 mm Fanlight aluminium tube <i>lots,</i> <i>for self-assembly</i> <i>length = 2000 mm</i>	
6051042	1 1 1 1 1 1 1 1	E6/C0 Sonderfarbe Niro-Design RAL9016 <i>anodized</i> <i>Special colour</i> <i>Niro design</i> <i>RAL9016</i>	R+L	OL LM-Rohr lose, für Selbstmontage Länge = 3000 mm Fanlight aluminium tube <i>lots,</i> <i>for self-assembly</i> <i>length = 3000 mm</i>	
6051044	1 1 1 1 1 1	grau weiß schwarz <i>grey</i> <i>white</i> <i>black</i>	R+L	OL Gelenkkurbel lose für Selbstmontage Fanlight articulated crank <i>lots</i> <i>for self assembly</i>	

WICLINE 75

Oberlicht-Beschlag
Fanlight fitting

Beschläge
Fittings







Artikel Article	VE PU	Farbe Colour	DIN DIN	Bezeichnung / Hinweise Designation / Indications	Abbildung Figure
6051045	1 1 1 1	roh schwarz <i>untreated</i> <i>black</i>	R+L	OL Kupplungstrichter lose, für Selbstmontage Fanlight coupling funnel <i>lots,</i> <i>for self-assembly</i>	
6051031	1 1	roh <i>untreated</i>	R+L	OL Zugstange Zum Einhängen, Ø 8 mm Länge = 1000 mm Fanlight pull rod <i>to hook in, Ø 8 mm</i> <i>length = 1000 mm</i>	
6051032	1 1	roh <i>untreated</i>	R+L	OL Zugstange zum Einhängen Ø 8 mm Länge = 2000 mm Fanlight operation rod <i>to hook in</i> <i>Ø 8 mm</i> <i>length = 2000 mm</i>	
6051033	1 1	roh <i>untreated</i>	R+L	OL Zugstange zum Einhängen Ø 8 mm Länge = 2500 mm Fanlight operating rod <i>to hook in</i> <i>Ø 8 mm</i> <i>length = 2500 mm</i>	
6051034	1 1	roh <i>untreated</i>	R+L	OL Zugstange Zum Einhängen, Ø 8 mm Länge = 3000 mm Fanlight pull rod <i>to hook in, Ø 8 mm</i> <i>length = 3000 mm</i>	
6051036	1 1 1 1 1 1 1 1	E6/C0 Sonderfarbe Niro-Design RAL9016 <i>anodized</i> <i>Special colour</i> <i>Niro design</i> <i>RAL9016</i>	R+L	OL LM-Abdeckprofil Länge = 2000 mm Fanlight aluminium cover profile <i>length = 2000 mm</i>	

WICLINE 75

Oberlicht-Beschlag
Fanlight fitting

Beschläge
Fittings



Artikel Article	VE PU	Farbe Colour	DIN DIN	Bezeichnung / Hinweise Designation / Indications	Abbildung Figure
6051037	1 1 1 1 1 1 1 1	E6/C0 Sonderfarbe Niro-Design RAL9016 <i>anodized</i> <i>Special colour</i> <i>Niro design</i> <i>RAL9016</i>	R+L	OL LM-Abdeckprofil Länge = 3000 mm Fanlight aluminium cover profile <i>length = 3000 mm</i>	
6051038	1 1 1 1 1 1 1 1 1	roh E6/C0 Sonderfarbe Niro-Design RAL9016 <i>untreated</i> <i>anodized</i> <i>Special colour</i> <i>Niro design</i> <i>RAL9016</i>	R+L	OL LM-Abdeckprofil Länge = 6000 mm Fanlight aluminium cover profile <i>length = 6000 mm</i>	
6051069	25 25	roh <i>untreated</i>	R+L	OL Zugstangenführung Fanlight pull rod guide	
6051209	1 1	roh <i>untreated</i>	R+L	OL Verbindungsmuffe 8/8 Fanlight connecting sleeve 8/8	
6051047	1 1 1 1 1 1	grau weiß schwarz <i>grey</i> <i>white</i> <i>black</i>	R+L	OL Flexibles Gestänge Länge = 700 mm Brüstungsübertragung, Leibungstiefe: 0 - 400 mm Fanlight flexible rods <i>length = 700 mm</i> <i>parapet transmissions,</i> <i>soffit depth: 0 - 400 mm</i>	

WICLINE 75

Oberlicht-Beschlag
Fanlight fitting

Beschläge
Fittings





Artikel Article	VE PU	Farbe Colour	DIN DIN	Bezeichnung / Hinweise Designation / Indications	Abbildung Figure
6051048	1 1 1 1 1 1	grau weiß schwarz grey white black	R+L	OL Flexibles Gestänge Länge = 1000 mm Brüstungsübertragung, Leibungstiefe: 0 - 700 mm Fanlight flexible rods length = 1000 mm parapet transmission, soffit depth: 0 - 700 mm	
6051049	1 1 1 1 1 1	grau weiß schwarz grey white black	R+L	OL Flexibles Gestänge Länge = 1250 mm Brüstungsübertragung, Leibungstiefe: 0 - 950 mm Fanlight flexible rods length = 1250 mm parapet transmission, soffit depth: 0 - 950 mm	
6051050	1 1 1 1 1 1	grau weiß schwarz grey white black	R+L	OL Zubehör für Flexibles Gestänge bei Brüstungsübertragung Fanlight accessory for flexible rods for parapet transmission	
6051063	1 1 1 1 1 1 1 1	E6/C0 Sonderfarbe Niro-Design RAL9016 anodized Special colour Niro design RAL9016	R+L	OL Pfosten- / Riegelübertragung Gr. 1 für Pfostentiefe (T) 0 - 120 mm Platzbedarf Blendrahmen: 22,5 mm Platzbedarf bis Oberkante Eckumlenkung: min. 310 mm für Betätigung mit Handhebel, Getriebe oder Elektroantrieb Schablone: 5010119 Fanlight mullion / transom transmission, size 1 for mullion depth (T) 0 - 120 mm Space required on frame for fitting: 22.5 mm Space required up to top edge corner transmission: min. 310 mm for operating with hand lever, gear or electric drive Template: 5010119	

WICLINE 75

Oberlicht-Beschlag
Fanlight fitting

Beschläge
Fittings



Artikel Article	VE PU	Farbe Colour	DIN DIN	Bezeichnung / Hinweise Designation / Indications	Abbildung Figure
6051064	1 1 1 1 1 1 1 1	E6/C0 Sonderfarbe Niro-Design RAL9016 <i>anodized</i> <i>Special colour</i> <i>Niro design</i> <i>RAL9016</i>	R+L	OL Pfosten- / Riegelübertragung Gr. 2 für Pfostentiefe (T) 120 - 200 mm Platzbedarf Blendrahmen: 22,5 mm Platzbedarf bis Oberkante Eckumlenkung: min. 310 mm für Betätigung mit Handhebel, Getriebe oder Elektroantrieb Schablone: 5010119 Fanlight mullion / transom transmission, size 2 <i>for mullion depth (T) 120 - 200 mm</i> <i>Space required on frame for fitting: 22.5 mm,</i> <i>Space required up to top edge</i> <i>corner transmission: min. 310 mm</i> <i>for operating with hand lever,</i> <i>gear or electric drive</i> <i>Template: 5010119</i>	
6051065	1 1	roh <i>untreated</i>	R+L	OL Kupplung zu E-Antrieb FA 121 / FA 121R Fanlight coupler for electric drive FA 121 / FA 121R	



Artikel Article	VE PU	Farbe Colour	DIN DIN	Bezeichnung / Hinweise Designation / Indications	Abbildung Figure
6081001	1 1 1 1 1 1	E6/C0 Sonderfarbe RAL9016 <i>anodized</i> <i>Special colour</i> RAL9016	R+L	<p>OL Elektroantrieb Typ FA 121 Nennspannung: 24 V/DC Zug-/Druckkraft: 1200 N (über Schubstange) Nennstrom bei 1200 N: 1.2 A Leistungsaufnahme: 29 Watt Kurzzeitbetrieb: S3 ED 25% SD 6 min. Laufzeit: Ca. 0.8 mm / sec. Hubweg: max. 66 mm Max. Flügelgewicht: 80 kg Anzahl Scheren: max. 3 Stück Flügelbreite: max. 2500 mm Schutzart: IP50 (trockene Räume) Anschlusskabel: 2-5x 0.75² - 1.5² (je nach Anforderung, siehe Schaltplan) max. Anzahl Antriebe auf einen Schalter 10 A: 8 Stück Abmessung (H/B/L): 38 x 77 x 218 mm ohne Befestigungsmaterial, zusätzlich Kupplung erforderlich</p> <p>Fanlight electric drive, Type FA 121 <i>Rated voltage: 24 V/DC</i> <i>Tensile/Compr. Force: 1200 N</i> <i>(over push rod)</i> <i>Current consumption for 1200 N: 1.2 A</i> <i>Current required: 29 Watt</i> <i>Only short duty S3 ED 25% SD 6 min.</i> <i>Actuation time: Approx. 0.8 mm / sec.</i> <i>Height of lift (stroke): max. 66 mm</i> <i>Max. sash weight: 80 kg</i> <i>Number of retainer arms: max. 3 pieces</i> <i>Sash width: max. 2500 mm</i> <i>Protection type: IP50 (dry rooms)</i> <i>Connecting wire: 2-5x 0.75² up to 1.5²</i> <i>(on request, see wiring scheme)</i> <i>max. number of drives connected</i> <i>to one switch 10 A: 8 pieces</i> <i>Dimension (W/H/L): 38 x 77 x 218 mm</i> <i>without fixing material,</i> <i>additional coupling is necessary</i></p>	



Artikel Article	VE PU	Farbe Colour	DIN DIN	Bezeichnung / Hinweise Designation / Indications	Abbildung Figure
6081003	1 1 1 1 1 1	E6/C0 Sonderfarbe RAL9016 <i>anodized</i> <i>Special colour</i> RAL9016	R+L	<p>OL Elektroantrieb Typ FA 121 R Nennspannung: 230 V/DC Zug-/Druckkraft: 1500 N (über Schubstange) Nennstrom bei 1500 N: 0.25 A Leistungsaufnahme: 60 Watt Kurzzeitbetrieb: S3 ED 25% SD 6 min. Laufzeit: Ca. 0.9 mm / sec. Hubweg: max. 66 mm Max. Flügelgewicht: 120 kg Anzahl Scheren: max. 3 Stück Flügelbreite: max. 2500 mm Schutzart: IP50 (trockene Räume) Anschlusskabel: 4-5x 0.75² - 1.5² (je nach Anforderung, siehe Schaltplan) max. Anzahl Antriebe auf einen Schalter 5 A: 10 Stück Abmessung (H/B/L): 38 x 77 x 218 mm ohne Befestigungsmaterial, zusätzlich Kupplung erforderlich</p> <p>Fanlight electric drive, Type FA 121 R Rated voltage: 230 V/DC Tensile/Compr. Force: 1500 N (over push rod) Current consumption for 1500 N: 0.25 A Current required: 60 Watt Only short duty S3 ED 25% SD 6 min. Actuation time: Approx. 0.9 mm / sec. Height of lift (stroke): max. 66 mm Max. sash weight: 120 kg Number of retainer arms: max. 3 pieces Sash width: max. 2500 mm Protection type: IP50 (dry rooms) Connecting wire: 4-5x 0.75² up to 1.5² (on request, see wiring scheme) max. number of drives connected to one switch 5 A: 10 pieces Dimension (W/H/L): 38 x 77 x 218 mm without fixing material, additional coupling is necessary</p>	
6081005	1 1	weiß <i>white</i>	R+L	<p>Drehschalter 2- polig, 10 Ampere, 250 Volt Unterputz, Kunststoff für E-Antriebe mit 24 V/DC</p> <p>Turn switch 2 Poles, 10 Amperes, 250 Volt, recessed switch, plastic for electric drive with 24 V/DC</p>	



Artikel Article	VE PU	Farbe Colour	DIN DIN	Bezeichnung / Hinweise Designation / Indications	Abbildung Figure
6081006	1 1	weiß white	R+L	<p>Drehschalter 2- polig, 10 Ampere, 250 Volt Aufputz, Kunststoff für E-Antriebe mit 24 V/DC</p> <p>Turn switch 2 Poles, 10 Amperes, 250 Volt, surface mounted switch, plastic for electric drive with 24 V/DC</p>	
6081007	1 1	weiß white	R+L	<p>Stellschalter Auf/Zu, nur für trockene Räume 10 Ampere Unterputz, Kunststoff für E- Antrieb mit 230 V/AC</p> <p>Non-return switch Open/Close, only for dry rooms, 10 Amperes, recessed switch, plastic for electric drive with 230 V/AC</p>	
6081008	1 1	weiß white	R+L	<p>Stellschalter Auf/Zu, nur für trockene Räume 10 Ampere Aufputz, Kunststoff für E-Antriebe mit 230 V/AC</p> <p>Non-return switch Open/Close, only for dry rooms, 10 Amperes, surface mounted switch, plastic for electric drive with 230 V/AC</p>	
6081009	1 1	roh untreated	R+L	<p>Prüfkabel für E-Antrieb FA 121 mit integriertem Netzteil und Kontrollleuchte für Rückmeldung für E-Antriebe mit 24 V</p> <p>Test cable for electric drive FA 121 with integrated mains unit and telltale lamp for feed back for electric drive with 24 V</p>	
6081010	1 1	roh untreated	R+L	<p>Prüfkabel für E-Antrieb FA 121 R Länge = 5 m für E-Antriebe mit 230 V/AC</p> <p>Test cable for electric drive FA 121 R length = 5 m for electric drive with 230 V/AC</p>	

WICLINE 75

Parallelschiebekipp-Beschlag
 (Grundbeschläge/Zusatzbeschläge/Griffe)
Tilt and slide fitting
 (basic fittings/additional fittings/handles)

Beschläge
Fittings



Artikel Article	VE PU	Farbe Colour	DIN DIN	Attribut Attribute	Bezeichnung / Hinweise Designation / Indications	Abbildung Figure
6950186	1 1	roh <i>untreated</i>	R		Parallelschiebekipp-Grundbeschlag Schema: A mit Zwangssteuerung max. Flügelgewicht: 200 kg mit Befestigungszubehör	
6950187	1 1	roh <i>untreated</i>	L		Achtung! Die Flügelhöhe darf die 2-fache Flügelbreite nicht überschreiten ! Parallel sliding tilt basic fitting scheme: A with force control max. sash weight: 200 kg with fixing accessories attention! the width/heigth ratio should not be smaller than 1:2 !	
6950189	1 1	roh <i>untreated</i>	R		Parallelschiebekipp-Grundbeschlag Schema: A ohne Zwangssteuerung max. Flügelgewicht: 160 kg mit Befestigungszubehör	
6950190	1 1	roh <i>untreated</i>	L		Achtung! Die Flügelhöhe darf die 2-fache Flügelbreite nicht überschreiten ! Parallel sliding tilt basic fitting scheme: A without force control max. sash weight: 160 kg with fixing accessories attention! The width/heigth ratio should not be smaller than 1:2 !	

WICLINE 75

Parallelschiebekipp-Beschlag
(Grundbeschläge/Zusatzbeschläge/Griffe)
Tilt and slide fitting
(basic fittings/additional fittings/handles)

Beschläge
Fittings

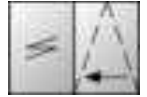

Artikel <i>Article</i>	VE <i>PU</i>	Farbe <i>Colour</i>	DIN <i>DIN</i>	Attribut <i>Attribute</i>	Bezeichnung / Hinweise <i>Designation / Indications</i>	Abbildung <i>Figure</i>
6950180	1 1	roh <i>untreated</i>	R		Laufwagen Set Typ 1 max. Flügelgewicht 160 kg mit Befestigungszubehör Bohrschablone: 5910101	
6950181	1 1	roh <i>untreated</i>	L		Carriage set type 1 max. sash weight 160 kg with fixing accessories drill template: 5910101	
6950182	1 1	roh <i>untreated</i>	R		Laufwagen Set Typ 2 max. Flügelgewicht: 200 kg mit Befestigungszubehör Bohrschablone: 2 x 5910101	
6950183	1 1	roh <i>untreated</i>	L		Carriage set type 2 max. sash weight 200 kg with fixing accessories drill template: 2 x 5910101	
6950184	1 1 1 1	silber RAL9016 silver RAL9016	R+L		Abdeckkappen Set 100 Cover cap set 100	
6950185	1 1 1 1	silber RAL9016 silver RAL9016	R+L		Abdeckkappen Set 160/200 mit Befestigungszubehör Cover cap set 160/200 with fixing accessories	

WICLINE 75

Parallelschiebekipp-Beschlag
 (Grundbeschläge/Zusatzbeschläge/Griffe)
Tilt and slide fitting
 (basic fittings/additional fittings/handles)

Beschläge
 Fittings

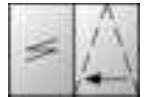

Artikel Article	VE PU	Farbe Colour	DIN DIN	Attribut Attribute	Bezeichnung / Hinweise Designation / Indications	Abbildung Figure
6950192	1	E6/C0	R		Aufsatzgetriebegriff mit Mitnehmer mit Befestigungszubehör Bohrschablone: 5910107	
	1	RAL9016				
	1	anodized			Surface mounted gear handle with driving dog with fixing accessories drill template: 5910107	
	1	RAL9016				
6950193	1	E6/C0	L			
	1	RAL9016				
	1	anodized				
	1	RAL9016				
6950194	1	E6/C0	R		Aufsatzgetriebegriff, abschließbar mit Mitnehmer mit Befestigungszubehör Bohrschablone: 5910107	
	1	RAL9016				
	1	anodized			Surface mounted gear handle, lockable with driving dog with fixing accessories drill template: 5910107	
	1	RAL9016				
6950195	1	E6/C0	L			
	1	RAL9016				
	1	anodized				
	1	RAL9016				
6950196	1	E6/C0	R+L		Fenstergriff einseitig innen mit Befestigungszubehör Bohrschablone: 5910104	
	1	RAL9016				
	1	anodized			Window handle one sided, inside with fixing accessories drill template: 5910104	
	1	RAL9016				
6950197	1	E6/C0	R+L		Fenstergriff, abschließbar einseitig innen mit Befestigungszubehör Bohrschablone: 5910104	
	1	RAL9016				
	1	anodized			Window handle, lockable one sided, inside with fixing accessories drill template: 5910104	
	1	RAL9016				

WICLINE 75

Parallelschiebekipp-Beschlag
(Grundbeschläge/Zusatzbeschläge/Griffe)
Tilt and slide fitting
(basic fittings/additional fittings/handles)

Beschläge
Fittings

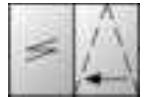



Artikel <i>Article</i>	VE <i>PU</i>	Farbe <i>Colour</i>	DIN <i>DIN</i>	Attribut <i>Attribute</i>	Bezeichnung / Hinweise <i>Designation / Indications</i>	Abbildung <i>Figure</i>
6950198	1 1 1 1	E6/C0 RAL9016 <i>anodized</i> <i>RAL9016</i>	R+L	PZ	Fenstergriff - Set einseitig innen mit Befestigungszubehör Bohrschablone: 5910104 Window handle set <i>one sided, inside</i> <i>with fixing accessories</i> <i>drill template: 5910104</i>	
6950199	1 1 1 1	E6/C0 RAL9016 <i>anodized</i> <i>RAL9016</i>	R+L	PZ	Fenstergriff - Set einseitig aussen mit Befestigungszubehör Verwendung in Kombination mit Fenstergriff - Set 6950198 Bohrschablone: 5910104 Window handle set <i>one sided, outside</i> <i>with fixing accessories</i> <i>use in combination</i> <i>with window handle set 6950198</i> <i>drill template: 5910104</i>	
6960261	1 1 1 1 1 1 1 1	E6/C0 Sonderfarbe Niro-Design RAL9016 <i>anodized</i> <i>Special colour</i> <i>Niro design</i> <i>RAL9016</i>	R+L		Fenstergriff mit ovaler Rosette normal ohne Schrauben Vierkantlänge 30 mm Window handle <i>with oval rosette</i> <i>normal without screws</i> <i>square length 30 mm</i>	

WICLINE 75

Parallelschiebekipp-Beschlag
(Grundbeschläge/Zusatzbeschläge/Griffe)
Tilt and slide fitting
(basic fittings/additional fittings/handles)

Beschläge
Fittings





Artikel <i>Article</i>	VE <i>PU</i>	Farbe <i>Colour</i>	DIN <i>DIN</i>	Attribut <i>Attribute</i>	Bezeichnung / Hinweise <i>Designation / Indications</i>	Abbildung <i>Figure</i>
6960262	1 1 1 1 1 1 1 1	E6/C0 Sonderfarbe Niro-Design RAL9016 <i>anodized</i> <i>Special colour</i> <i>Niro design</i> <i>RAL9016</i>	R+L		Fenstergriff mit ovaler Rosette abschließbar ohne Schrauben Vierkantlänge 30 mm erfüllt Anforderung 100 Nm gem. DIN EN 1627 einsetzbar bei RC1N/RC2N/RC2/ RC3 Window handle <i>with oval rosette</i> <i>lockable without screws</i> <i>square length 30 mm</i> <i>fulfils requirement: 100 Nm</i> <i>acc. to DIN EN 1627</i> <i>applicable for RC1N/RC2N/RC2/ RC3</i>	
6041192	100 100	roh <i>untreated</i>			Senkschraube M5x40 T25 für Fenstergriff mit Einlassgetriebe Countersunk screw M5x40 T25 <i>for window handle with mortise gear</i>	
4070443	100 100	roh <i>untreated</i>			Senkblechschraube DIN 7982 ST4,8 x 60 A2 Countersunk screw DIN 7982 ST4.8 x 60 A2	
6950278	1 1	roh <i>untreated</i>	R+L		Getriebeabstützung für Einlassgetriebe DM 15 Gear support <i>for mortise gear DM 15</i>	

WICLINE 75

Parallelschiebekipp-Beschlag
(Grundbeschläge/Zusatzbeschläge/Griffe)
Tilt and slide fitting
(*basic fittings/additional fittings/handles*)

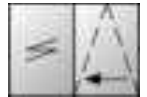
Beschläge
Fittings



Artikel <i>Article</i>	VE <i>PU</i>	Farbe <i>Colour</i>	DIN <i>DIN</i>	Attribut <i>Attribute</i>	Bezeichnung / Hinweise <i>Designation / Indications</i>	Abbildung <i>Figure</i>
6950200	1	silber RAL9016	R+L	FAB 754 - 934	Zusatz-Set Profile für Parallelschiebekipp- Grundbeschlag mit bzw. ohne Zwangssteuerung max. Flügelgewicht = 200 kg mit Befestigungszubehör	
	1	<i>silver</i> <i>RAL9016</i>				
6950201	1	silber RAL9016	R+L	FAB 935 - 1084	Bohrschablone: 5910105	
	1	<i>silver</i> <i>RAL9016</i>			Additional profile set <i>for parallel sliding tilt basic fitting</i> <i>with or without force control</i> <i>max. sash weight 200 kg</i> <i>with fixing accessories</i>	
6950202	1	silber RAL9016	R+L	FAB 1085 - 1284	drill template: 5910105	
	1	<i>silver</i> <i>RAL9016</i>				
6950203	1	silber RAL9016	R+L	FAB 1285 - 1484		
	1	<i>silver</i> <i>RAL9016</i>				
6950204	1	silber RAL9016	R+L	FAB 1485 - 1684		
	1	<i>silver</i> <i>RAL9016</i>				
6950205	1	silber RAL9016	R+L	FAB 1685 - 2034		
	1	<i>silver</i> <i>RAL9016</i>				

WICLINE 75

Parallelschiebekipp-Beschlag
(Grundbeschläge/Zusatzbeschläge/Griffe)
Tilt and slide fitting
(basic fittings/additional fittings/handles)

Beschläge
Fittings



Artikel <i>Article</i>	VE <i>PU</i>	Farbe <i>Colour</i>	DIN <i>DIN</i>	Attribut <i>Attribute</i>	Bezeichnung / Hinweise <i>Designation / Indications</i>	Abbildung <i>Figure</i>
6950216	1 1	roh <i>untreated</i>	R+L	OZ FAH 2385 - 2534 MZ FAH 2435 - 2734	Verlängerung 400 mm für Parallelschiebekipp- Grundbeschlag mit bzw. ohne Zwangssteuerung Extension piece 400 mm <i>for parallel sliding tilt basic fitting</i> <i>with or without force control</i>	
6950217	1 1	roh <i>untreated</i>	R+L	DM 15 FAH 684 - 1134	Höhengestänge mit Einlassge- triebe für Parallelschiebekipp- Grundbeschlag ohne Zwangssteuerung Griffsitz mittig Befestigung mit Senkschraube M5x40 (6041192)	
6950218	1 1	roh <i>untreated</i>	R+L	DM 15 FAH 1135 - 1484	Vertical connecting rod with mortise gear <i>for parallel sliding tilt basic fitting</i> <i>without force control</i> <i>handle hub in centre</i> <i>fixing with countersunk screw</i> <i>M5x40 (6041192)</i>	
6950219	1 1	roh <i>untreated</i>	R+L	DM 15 FAH 1485 - 1934	Höhengestänge mit Einlassge- triebe für Parallelschiebekipp- Grundbeschlag ohne Zwangssteuerung Griffsitz mittig Befestigung mit Senkschraube M5x40 (6041192)	
6950220	1 1	roh <i>untreated</i>	R+L	DM 15 FAH 1935 - 2384 *	Höhengestänge mit Einlassge- triebe für Parallelschiebekipp- Grundbeschlag ohne Zwangssteuerung Griffsitz mittig Befestigung mit Senkschraube M5x40 (6041192) *mit Verlängerung 6950216: FAH 2385 - 2534 Vertical connecting rod with mortise gear <i>for parallel sliding tilt basic fitting</i> <i>without force control</i> <i>handle hub in centre</i> <i>fixing with countersunk screw</i> <i>M5x40 (6041192)</i> *with extension piece 6950216: FAH 2385 - 2534	

WICLINE 75

Parallelschiebekipp-Beschlag
(Grundbeschläge/Zusatzbeschläge/Griffe)
Tilt and slide fitting
(basic fittings/additional fittings/handles)

Beschläge
Fittings

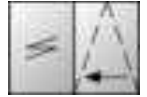

Artikel <i>Article</i>	VE <i>PU</i>	Farbe <i>Colour</i>	DIN <i>DIN</i>	Attribut <i>Attribute</i>	Bezeichnung / Hinweise <i>Designation / Indications</i>	Abbildung <i>Figure</i>
6950221	1 1	roh <i>untreated</i>	R+L	FAH 934 - 1134	Höhengestänge für Aufsatzge- triebe Vertical connecting rod for sur- face mounted gear	
6950222	1 1	roh <i>untreated</i>	R+L	FAH 1135 - 1334		
6950223	1 1	roh <i>untreated</i>	R+L	FAH 1335 - 1534		
6950224	1 1	roh <i>untreated</i>	R+L	FAH 1535 - 1734		
6950225	1 1	roh <i>untreated</i>	R+L	FAH 1735 - 1934		
6950226	1 1	roh <i>untreated</i>	R+L	FAH 1935 - 2134		
6950227	1 1	roh <i>untreated</i>	R+L	FAH 2135 - 2334 *	Höhengestänge für Aufsatzge- triebe *mit Verlängerung 6950216: FAH 2435 - 2734 Vertical connecting rod for sur- face mounted gear *with extension piece 6950216: FAH 2435 - 2734	
6950228	1 1	roh <i>untreated</i>	R+L	FAH 2335 - 2434	Höhengestänge für Aufsatzge- triebe Vertical connecting rod for sur- face mounted gear	

WICLINE 75

Parallelschiebekipp-Beschlag
(Grundbeschläge/Zusatzbeschläge/Griffe)
Tilt and slide fitting
(basic fittings/additional fittings/handles)

Beschläge
Fittings



Artikel <i>Article</i>	VE <i>PU</i>	Farbe <i>Colour</i>	DIN <i>DIN</i>	Attribut <i>Attribute</i>	Bezeichnung / Hinweise <i>Designation / Indications</i>	Abbildung <i>Figure</i>
6950251	1 1	roh <i>untreated</i>	R+L	PZ DM 40 FAH 1735 - 1934	Höhengestänge mit Einlassge- triebe abschließbar für Parallelschiebekipp- Grundbeschlag mit Zwangssteuerung	
6950252	1 1	roh <i>untreated</i>	R+L	PZ DM 40 FAH 1935 - 2134	Vertical connecting rod with mortise gear <i>lockable</i> <i>for parallel sliding tilt basic fitting</i> <i>with force control</i>	
6950253	1 1	roh <i>untreated</i>	R+L	PZ DM 40 FAH 2135 - 2334		
6950254	1 1	roh <i>untreated</i>	R+L	PZ DM 40 FAH 2335 - 2434		
6950255	1 1	roh <i>untreated</i>	R+L	DM 30 FAH 684 - 1134	Höhengestänge mit Einlassge- triebe für Parallelschiebekipp- Grundbeschlag ohne Zwangssteuerung	
6950256	1 1	roh <i>untreated</i>	R+L	DM 30 FAH 1135 - 1484	Griffsitz mittig Befestigung mit Senkblechschraube St4,8 x 60 (4070443)	
6950257	1 1	roh <i>untreated</i>	R+L	DM 30 FAH 1485 - 1934	Vertical connecting rod with mortise gear <i>for parallel sliding tilt basic fitting</i> <i>without force control</i> <i>handle hub in centre</i> <i>self-tapping countersunk screw</i> <i>St4.8 x 60 (4070443)</i>	
6950258	1 1	roh <i>untreated</i>	R+L	DM 30 FAH 1935 - 2384		

WICLINE 75

Parallelschiebekipp-Beschlag
(Grundbeschläge/Zusatzbeschläge/Griffe)

Tilt and slide fitting

(basic fittings/additional fittings/handles)

Beschläge
Fittings

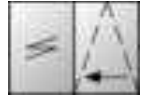

Artikel <i>Article</i>	VE <i>PU</i>	Farbe <i>Colour</i>	DIN <i>DIN</i>	Attribut <i>Attribute</i>	Bezeichnung / Hinweise <i>Designation / Indications</i>	Abbildung <i>Figure</i>
6950262	1 1	roh <i>untreated</i>	R+L	L 930	Gleitschere für Parallelschiebekipp- Grundbeschlag ohne Zwangssteuerung max. Flügelgewicht: 160 kg	
6950263	1 1	roh <i>untreated</i>	R+L	L 1280	Guiding stay <i>for parallel sliding tilt basic fitting without force control max. sash weight: 160 kg</i>	
6950264	1 1	roh <i>untreated</i>	R+L	L 1680		
6950265	1 1	roh <i>untreated</i>	R+L	FAB 654 - 934	Breitengestänge für Parallelschiebekipp- Grundbeschlag ohne Zwangssteuerung	
6950266	1 1	roh <i>untreated</i>	R+L	FAB 935 - 1284	Horizontal connecting rod <i>for parallel sliding tilt basic fitting without force control</i>	
6950267	1 1	roh <i>untreated</i>	R+L	FAB 1285 - 1684		

WICLINE 75

Parallelschiebekipp-Beschlag
(Grundbeschläge/Zusatzbeschläge/Griffe)
Tilt and slide fitting
(basic fittings/additional fittings/handles)

Beschläge
Fittings



Artikel <i>Article</i>	VE <i>PU</i>	Farbe <i>Colour</i>	DIN <i>DIN</i>	Attribut <i>Attribute</i>	Bezeichnung / Hinweise <i>Designation / Indications</i>	Abbildung <i>Figure</i>
6950268	1 1	roh <i>untreated</i>	R+L	FAB 754 - 1084	Breitengestänge für Parallelschiebekipp- Grundbeschlag mit Zwangssteuerung	
6950269	1 1	roh <i>untreated</i>	R+L	FAB 1085 - 1284	Horizontal connecting rod <i>for parallel sliding tilt basic fitting with force control</i>	
6950270	1 1	roh <i>untreated</i>	R+L	FAB 1285 - 1484		
6950271	1 1	roh <i>untreated</i>	R+L	FAB 1485 - 1684		
6950272	1 1	roh <i>untreated</i>	R+L	FAB 1685 - 1884		
6950273	1 1	roh <i>untreated</i>	R+L	FAB 1885 - 2034		
6950274	1 1	roh <i>untreated</i>	R+L		Verriegelungsset Typ 1 für Parallelschiebekipp- Grundbeschlag mit Zwangssteuerung Locking piece set type 1 <i>for parallel sliding tilt basic fitting with force control</i>	
6950275	1 1	roh <i>untreated</i>	R+L		Verriegelungsset Typ 2 für Parallelschiebekipp- Grundbeschlag ohne Zwangssteuerung Locking piece set type 2 <i>for parallel sliding tilt basic fitting without force control</i>	

WICLINE 75

Parallelschiebekipp-Beschlag
(Grundbeschläge/Zusatzbeschläge/Griffe)
Tilt and slide fitting
(*basic fittings/additional fittings/handles*)

Beschläge
Fittings

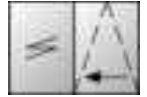

Artikel <i>Article</i>	VE <i>PU</i>	Farbe <i>Colour</i>	DIN <i>DIN</i>	Attribut <i>Attribute</i>	Bezeichnung / Hinweise <i>Designation / Indications</i>	Abbildung <i>Figure</i>
6950276	1 1	roh <i>untreated</i>	R+L	FAB > 1680	Verriegelungsset Typ 3 für Parallelschiebekipp- Grundbeschlag mit und ohne Zwangssteuerung Locking piece set type 3 <i>for parallel sliding tilt basic fitting</i> <i>with and without force control</i>	

WICLINE 75

Zubehör einbruchhemmend (einwärts)
Accessory, burglar resistant (inwards)

Beschläge
Fittings



Artikel Article	VE PU	Farbe Colour	DIN DIN	Bezeichnung / Hinweise Designation / Indications	Abbildung Figure
6940325	1 1	roh <i>untreated</i>		Anbohrschutz RC1N/RC2N/RC2/RC3 für Falzgetriebe Drilling protection RC1N/RC2N/RC2/RC3 for rebate gear	
6940326	1 1	roh <i>untreated</i>		EH Stulpgetriebe RC1N/RC2N/RC2/RC3 Burglar resistant double casement gear RC1N/RC2N/RC2/RC3	
6940334	1 1	roh <i>untreated</i>	R+L	Falzschutz Länge 250 mm. Anwendung bei Einbruchhemmung als EH Falzschutz RC1N/RC2N/RC2/RC3. Anwendung bei Brandschutzfenster als Falzschutz für Außenschale Rebate safeguard Length 250 mm. Application at burglar resistance as Burglar resistance rebate safeguard RC1N/RC2N/RC2/RC3. Application at fire protection windows as rebate safeguard for outer shell	
6940319	1 1	roh <i>untreated</i>		EH Garnitur Typ 1, RC1N/RC2N/RC2 für Dreh-Kipp-, Tilt-First- und Dreh-Beschlag Burglar resistant set, type 1, RC1N/RC2N/RC2 for Turn/tilt, Tilt-First and Turn fitting	
6940320	1 1	roh <i>untreated</i>		EH Garnitur Typ 1, RC3 für Dreh-Kipp-, Tilt-First- und Dreh-Beschlag Burglar resistant set, type 1, RC3 for Turn/tilt, Tilt-First and Turn fitting	





WICLINE 75





Zubehör einbruchhemmend (einwärts)
Accessory, burglar resistant (inwards)





Beschläge
Fittings















Artikel Article	VE PU	Farbe Colour	DIN DIN	Bezeichnung / Hinweise Designation / Indications	Abbildung Figure
6940321	1 1	roh <i>untreated</i>	R+L	<p>EH Garnitur Typ 2, RC1N/RC2N/RC2 bzw. Verschlussgarnitur bei Brandschutzfenstern Anwendung bei Einbruchhemmung als EH-Garnitur Typ 2, RC1N/RC2N/RC2 für Dreh-Kipp-, Tilt-First-, Dreh- und Kipp-Beschlag Anwendung bei Brandschutzfenster als Verschlussgarnitur</p> <p>Burglar resistant set type 2, RC1N/RC2N/RC2 or lock set for fire protection windows Application at burglar resistance as Burglar resistant set type 2, RC1N/RC2N/RC2 for Turn/tilt, Tilt-First, Turn and Tilt fitting Application at fire protection windows as lock set</p>	
6940322	1 1	roh <i>untreated</i>		<p>EH Garnitur Typ 2, RC3 für Dreh-Kipp-, Tilt-First-, Dreh- und Kipp-Beschlag</p> <p>Burglar resistant set type 2, RC3 for Turn/Tilt, Tilt-First, Turn and Tilt fitting</p>	
6940323	1 1	roh <i>untreated</i>	R+L	<p>Bandverriegelung Anwendung bei Einbruchhemmung als EH-Bandverriegelung RC1N/RC2N/RC2/RC3 für Dreh- und Kipp-Beschlag. Anwendung bei Brandschutzfenster als Bandsicherung</p> <p>Hinge sided interlock Application at burglar resistance as Burglar resistant hinge sided interlock for Turn and Tilt fitting. Application as fire protection windows as hinge security</p>	

Artikel Article	VE PU	Farbe Colour	DIN DIN	Bezeichnung / Hinweise Designation / Indications	Abbildung Figure
6960257	1 30 1 30	roh roh <i>untreated</i> <i>untreated</i>	R+L	Falzgetriebe komplett mit Fehlbediensicherung, für 7 mm Vkt.-Stift, Stiftvorstand 30 -1 mm, benötigte Schraube für Fenstergriffe: 6940095 Rebate gear, complete <i>with faulty operation safeguard, for 7 mm square</i> <i>pin, pin protrusion 30 -1 mm, required screws for</i> <i>window handles: 6940095</i>	
6940258	100 100	roh <i>untreated</i>	R+L	Zusatzschraube ,130 kg', T25 Additional screw for 130 kg fitting, T25	
6940259	20 20	roh <i>untreated</i>	R+L	Zusatzbefestigung „130 kg“ T10 bei Kämpfer-Stoßverbindungen Additional fixing „130 kg“ T10 <i>for transom butt-joint connections</i>	
6940257	1 1	roh <i>untreated</i>	R+L	DK-Zweitschere erforderlich ab Flügelbreite (FAB) = 1400 mm Turn/Tilt second retainer arm <i>necessary from 1400 mm sash width onwards</i>	
6940335	1 1	roh <i>untreated</i>	R	DK-Zweitschere 200 kg erforderlich ab Flügelbreite (FAB) = 1400 mm Turn/Tilt second retainer arm 200 kg <i>necessary from 1400 mm sash width onwards</i>	
6940336	1 1	roh <i>untreated</i>	L		

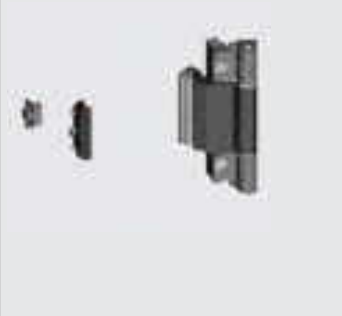
Artikel Article	VE PU	Farbe Colour	DIN DIN	Bezeichnung / Hinweise Designation / Indications	Abbildung Figure
6940266	1 1	roh <i>untreated</i>	R+L	TF-Zweitschere erforderlich ab Flügelbreite (FAB) = 1400 mm beim verdeckten Beschlag ab FAB = 1400 mm empfohlen Tilt-First second retainer arm <i>necessary from 1400 mm sash width onwards</i> <i>in the concealed fittings recommended from 1400 mm sash onwards</i>	
6940297	1 1	roh <i>untreated</i>	R+L	Kippweitenbegrenzer für DK-, TF-Beschlag Schere Gr. 2 für Kippweite 120/100/80 mm einstellbar Tilt opening restrictor <i>for Turn/tilt and Tilt-First fitting</i> <i>retainer arm size 2</i> <i>for tilt distances 120/100/80 mm, adjustable</i>	
6940299	1 1	roh <i>untreated</i>	R+L	Spaltlüfter für DK-, TF-Beschlag Einsetzbar bei Schere Gr. 1 ab 600 mm FAB Schere Gr. 2 ab 700 mm FAB Gap ventilator <i>for Turn/tilt and Tilt-First fitting</i> <i>Applicable for</i> <i>retainer arm size 1 from 600 mm FAB</i> <i>retainer arm size 2 from 700 mm FAB</i> <i>(FAB = Sash outer dimension width)</i>	
6041165	1 1	roh <i>untreated</i>	R+L	Verstärkte Kipparretierung für Dreh-Kipp bzw. Tilt-First-Zweitschere Reinforced tilt detent <i>for turn/tilt or Tilt-first second retainer arm</i>	
6940296	1 1 1 1 1 1 1 1	silber Sonderfarbe Niro-Design RAL9016 silver Special colour Niro design RAL9016	R+L	Dreh Sperre Turn lock	

Artikel Article	VE PU	Farbe Colour	DIN DIN	Bezeichnung / Hinweise Designation / Indications	Abbildung Figure
6940292	1 1	roh <i>untreated</i>	R+L	Drehbegrenzer gedämpft Für Scheren Gr. 1, Aufliegender Beschlag: FAB = 425 - 700 mm Verdeckter Beschlag: FAB = 500 - 700 mm bei 70° Öffnungswinkel Turn limiter attenuated <i>for retainer arm size 1,</i> <i>top mounted fitting: FAB = 425 - 700 mm</i> <i>concealed fitting: FAB = 500 - 700 mm with</i> <i>70° opening angle</i>	
6940293	1 1	roh <i>untreated</i>	R+L	Drehbegrenzer gedämpft Für Scheren Gr. 2, FAB = 701 - 1700 mm Turn limiter, attenuated <i>for retainer arm size 2, FAB = 701 - 1700 mm</i>	
6940294	1 1	roh <i>untreated</i>	R+L	Drehbegrenzer gebremst Für Scheren Gr. 1, FAB = 425 - 700 mm Nur bei Beschlag aufliegend verwendbar. Turn limiter with brake <i>for retainer arm size 1,</i> <i>FAB = 425 - 700 mm,</i> <i>Applicable only in combination</i> <i>with top mounted fittings</i>	
6940295	1 1	roh <i>untreated</i>	R+L	Drehbegrenzer gebremst Für Scheren Gr. 2, FAB = 701 - 1700 mm. Nur bei Beschlag aufliegend verwendbar. Turn limiter with brake <i>for retainer arm size 2, FAB = 701 - 1700 mm.</i> <i>Applicable only in combination</i> <i>with top mounted fittings.</i>	
6940286	1 1	roh <i>untreated</i>	R	Verriegelung-Eckumlenkung senkrecht oder waagrecht Lock corner transmission <i>vertical or horizontal</i>	
6940287	1 1	roh <i>untreated</i>	L		

Artikel Article	VE PU	Farbe Colour	DIN DIN	Bezeichnung / Hinweise Designation / Indications	Abbildung Figure
6940256	1 1	roh <i>untreated</i>	R+L	Mittelverriegelung mit Eckumlenkung senkrecht oder waagrecht Centre lock with corner transmission <i>vertical or horizontal</i>	
6940517	1 1	roh <i>untreated</i>	R+L	Verriegelung im Falz, bandseitig senkrecht oder waagrecht Lock in rebate, hinge side <i>vertical or horizontal</i>	
6940518	1 1	roh <i>untreated</i>	R+L	Mittelverriegelung im Falz senkrecht oder waagrecht Centre lock in rebate <i>vertical or horizontal</i>	
6940347	1 1	roh <i>untreated</i>	R+L	Verriegelungsteile senkrecht oder waagrecht Locking parts <i>vertical or horizontal</i>	
6940283	1 1 1 1 1 1 1 1	E6/C0 Sonderfarbe Niro-Design RAL9016 <i>anodized</i> <i>Special colour</i> <i>Niro design</i> <i>RAL9016</i>	R+L	Mittelband senkrecht oder waagrecht Centre hinge <i>vertical or horizontal</i>	
6940288	1 1	roh <i>untreated</i>	R+L	Mittelverriegelung senkrecht oder waagrecht Centre lock <i>vertical or horizontal</i>	

Artikel Article	VE PU	Farbe Colour	DIN DIN	Bezeichnung / Hinweise Designation / Indications	Abbildung Figure
6940273	1 1 1 1 1 1 1 1	E6/C0 Sonderfarbe Niro-Design RAL9016 <i>anodized</i> <i>Special colour</i> <i>Niro design</i> <i>RAL9016</i>	R+L	Mittelveriegelung mit Band (senkrecht oder waagrecht) Nur für Dreh-Beschlag oder Kipp-Beschlag Centre lock with hinge (vertical or horizontal) Only for turn sash fitting or tilt sash fitting	
6940328	1 1	roh <i>untreated</i>	R	Kipplager Tilt bearing	
6940329	1 1	roh <i>untreated</i>	L		
6940330	1 1	roh <i>untreated</i>	R	Kippriegelteil Tilt bolt part	
6940331	1 1	roh <i>untreated</i>	L		
6940333	1 1	roh <i>untreated</i>	R+L	Stulpgetriebe Double casement gear	
6940326	1 1	roh <i>untreated</i>		EH Stulpgetriebe RC1N/RC2N/RC2/RC3 Burglar resistant double casement gear RC1N/RC2N/RC2/RC3	

Artikel Article	VE PU	Farbe Colour	DIN DIN	Bezeichnung / Hinweise Designation / Indications	Abbildung Figure
6940281	1 1	roh <i>untreated</i>	R	Zusatzgarnitur Verschlusssteile Stulp Bei Anwendung Stulpflügel in Kombination mit Tilt-First-Beschlag	
6940282	1 1	roh <i>untreated</i>	L	Additional set of lock parts for double casement <i>For application double casement sash in combination with Tilt-First fitting</i>	
6940300	1 1	roh <i>untreated</i>	R+L	Schnäpper-Set für Fenstertür Catch set <i>for casement door</i>	
6040548	10 10	roh <i>untreated</i>	R+L	Stulp-Schließstück Double casement locking piece	
6940289	1 1	roh <i>untreated</i>	R+L	Verschiebesicherung Einsatz bei Dreh- und Kippflügel Hochformat ohne waagerechte Mittelverriegelung in Verbindung mit Steckgriff-Rosette und Steckgriff Shift safeguard <i>Applicable for turn, tilt sash upright format without horizontal centre lock in connection with rosette for removable plug handle and removable plug handle</i>	
6041073	1 1	roh <i>untreated</i>	R+L	Schieberstangensicherung erforderlich wenn der Abstand zwischen zwei Bauteilen größer/gleich 700 mm ist. Push rod safeguard <i>necessary if the distance between two components is larger/equal 700 mm.</i>	
6940302	10 10	roh <i>untreated</i>	R+L	Arretierung für Griff-Drehbewegung auf 90° Detent <i>for handle turn handling to 90°</i>	

Artikel Article	VE PU	Farbe Colour	DIN DIN	Bezeichnung / Hinweise Designation / Indications	Abbildung Figure
6980250	1 1	roh <i>untreated</i>	R+L	<p>Fensterkontakt VdS-Klasse B für Alarm- und Überwachungsanlagen komplett mit Kontaktsensor und Magneteinheit universell einsetzbar zur Verschlussüberwachung Technische Daten: Kontaktart: Schließler Spannung: $U_{max} = 48 \text{ V DC}$ Schaltstrom: $I_{max} = 0,5 \text{ A}$ Rein ohmsche Last Schaltleistung: $P_{max} = 5 \text{ W (Uxl)}$ Schutzart: IP 67 nach DIN 40050 Umweltklasse 3 nach VdS 2110 Gehäusefarbe RAL 7035 (Lichtgrau) Kabel: 6 m, LIYY 4 x 0,14 mm², weiss ZGL VdS Zulassungen: kombinierte Verschluss- u. Öffnungsüberwachung VdS-Klasse B (G 102512) Verschlussüberwachung VdS-Klasse C (G 102038) Öffnungsüberwachung VdS-Klasse B (G 102512)</p> <p>Window contact VdS-Class B for alarm and monitoring systems complete with contact sensor and magnet unit applicable universally for lock surveillance Technical data: Contact type: Closing contact Voltage: $U_{max} = 48 \text{ V DC}$ Switch current: $I_{max} = 0,5 \text{ A}$ Real DC power switch current: $P_{max} = 5 \text{ W (Uxl)}$ Protection type: IP 67 acc. to DIN 40050 Environmental class 3 acc. to VdS 2110 Colour of casing RAL 7035 (light grey) Cable: 6 m, LIYY 4 x 0,14 mm², white ZGL VdS approvals: combined lock and opening surveillance VdS-Class B (G 102512) Lock surveillance VdS-Class C (G 102038) Opening surveillance VdS-Class B (G 102512)</p>	





Artikel Article	VE PU	Farbe Colour	DIN DIN	Bezeichnung / Hinweise Designation / Indications	Abbildung Figure
6980251	1 1	roh <i>untreated</i>	R+L	<p>Fensterkontakt für Klima- und Heizungssteuerung zur energiesparenden Fensterlüftung komplett mit Kontaktsensor und Magneteinheit universell einsetzbar Kontaktart: Wechsler Spannung: $U_{max} = 30 \text{ V DC}$ Schaltstrom: $I_{max} = 0,2 \text{ A}$ Rein ohmsche Last Schaltleistung: $P_{max} = 3 \text{ W (Uxl)}$ Schutzart: IP 67 nach DIN 40050 Umweltklasse 3 nach VdS 2110 Gehäusefarbe RAL 7035 (lichtgrau) Kabel: 6 m, LIYY 3 x 0,14 mm², weiss ZGL Adernfarben weiss, braun, grün</p> <p>Window contact <i>for air conditioning and heater control for energy-saving window ventilation complete with contact sensor and magnet unit Universal use for lock monitoring Technical data: Contact type: Change contact Voltage: $U_{max} 30 \text{ V DC}$ Switch current: $I_{max} = 0,2 \text{ A}$ Real DC power switch current: $P_{max}. 3 \text{ W (=Uxl)}$ Protection type: IP 67 acc. to DIN 40050 Environmental class 3 acc. to VdS 2110 Colour of casing RAL 7035 (light grey) Cable: 6 m, LIYY 3 x 0,14 mm², white ZGL Colour of wires: white, brown, green</i></p>	





Artikel Article	VE PU	Farbe Colour	DIN DIN	Bezeichnung / Hinweise Designation / Indications	Abbildung Figure
6980252	1 1	roh <i>untreated</i>	R+L	<p>Fensterkontakt VdS-Klasse C für Alarm- und Überwachungsanlagen komplett mit Kontaktsensor und Magneteinheit universell einsetzbar zur Verschlussüberwachung Technische Daten: Kontaktart: Schließler Spannung: $U_{max} = 30 \text{ V DC}$ Schaltstrom: $I_{max} = 0,2 \text{ A}$ Rein ohmsche Last Schaltleistung: $P_{max} = 3 \text{ W (Uxl)}$ Schutzart: IP 67 nach DIN 40050 Umweltklasse 3 nach VdS 2110 Gehäusefarbe RAL 7035 (lichtgrau) Kabel: 6 m, LIYY 4 x 0,14 mm², weiss ZGL VdS Zulassungen: kombinierte Verschluss- u. Öffnungsüberwachung VdS-Klasse C (G 102039) Verschlussüberwachung VdS-Klasse C (G 102039) Öffnungsüberwachung VdS-Klasse C (G 102039)</p> <p>Window contact VdS-Class C for alarm and monitoring systems complete with contact sensor and magnet unit applicable universally for lock surveillance Technical data: Contact type: Closing contact Voltage: $U_{max} = 30 \text{ V DC}$ Switch current: $I_{max} 0,2 \text{ A}$ Real DC power switch current: $P_{max} = 3 \text{ W (Uxl)}$ Protection type: IP 67 acc. to DIN 40050 Environmental class 3 acc. to VdS 2110 Colour of casing RAL 7035 (light grey) Cable: 6 m, LIYY 4 x 0,14 mm², white ZGL VdS approvals: combined lock and opening surveillance VdS-Class C (G 102039) Lock surveillance VdS-Class C (G 102039) Opening surveillance VdS-Class C (G 102039)</p>	

WICLINE 75





Zusatzbeschläge und Griffe (einwärts)
Additional hardware and handles (inwards)

Beschläge
Fittings



Artikel Article	VE PU	Farbe Colour	DIN DIN	Bezeichnung / Hinweise Designation / Indications	Abbildung Figure
6060328	25 25	weiß white		Fensterfalzlüfter weiß Nur für WICLINE 75 anwendbar Window ventilator white Usage only for WICLINE 75	
6060329	25 25 25 25	silber weiß silver white		Drehverschluss für Fensterfalzlüfter weiß silber Nur für WICLINE 75 anwendbar Turn lock for window ventilator white silver Usage only for WICLINE 75	
6060330	1 1	roh untreated		Lüftereinheit A100 Länge L 0,6 m - 3 m x B 0,14 m x H 0,1 m Ventilator unit A100 Length L 0,6 m - 3 m x W 0,14 m x H 0,1 m	
6060331	1 1	roh untreated		Lüftereinheit VT Ausführungsvarianten auf Anfrage! Ventilator unit VT Design variants on request!	
6960259	1 1 1 1 1 1 1 1	E6/C0 Sonderfarbe Niro-Design RAL9016 anodized Special colour Niro design RAL9016	R+L	Fenstergriff rosettenlos, Vierkantlänge 30 mm, mit 2 Sonderschrauben M4 x 18 T10 Window handle without rosette, square length 30 mm, with 2 special screws M4 x 18 T10	

Artikel Article	VE PU	Farbe Colour	DIN DIN	Bezeichnung / Hinweise Designation / Indications	Abbildung Figure
6960260	1 1 1 1 1 1 1 1	E6/C0 Sonderfarbe Niro-Design RAL9016 <i>anodized</i> <i>Special colour</i> <i>Niro design</i> <i>RAL9016</i>	R+L	Fenstergriff rosettenlos, Vierkantlänge 30 mm, abschließbar, mit 2 Sonderschrauben M4 x 18 T10 erfüllt Anforderung 100 Nm, gem. DIN EN 1627: 2011 einsetzbar bei RC1N/RC2N/RC2/RC3 Window handle <i>without rosette, square length 30 mm, lockable,</i> <i>with 2 special screws M4 x 18 T10 fulfils</i> <i>requirement: 100 Nm, acc. to DIN EN 1627: 2011</i> <i>applicable for RC1N/RC2N/RC2/RC3</i>	
6960261	1 1 1 1 1 1 1 1	E6/C0 Sonderfarbe Niro-Design RAL9016 <i>anodized</i> <i>Special colour</i> <i>Niro design</i> <i>RAL9016</i>	R+L	Fenstergriff mit ovaler Rosette normal ohne Schrauben Vierkantlänge 30 mm Window handle <i>with oval rosette</i> <i>normal without screws</i> <i>square length 30 mm</i>	
6960262	1 1 1 1 1 1 1 1	E6/C0 Sonderfarbe Niro-Design RAL9016 <i>anodized</i> <i>Special colour</i> <i>Niro design</i> <i>RAL9016</i>	R+L	Fenstergriff mit ovaler Rosette abschließbar ohne Schrauben Vierkantlänge 30 mm erfüllt Anforderung 100 Nm gem. DIN EN 1627 einsetzbar bei RC1N/RC2N/RC2/RC3 Window handle <i>with oval rosette</i> <i>lockable without screws</i> <i>square length 30 mm</i> <i>fulfils requirement: 100 Nm</i> <i>acc. to DIN EN 1627</i> <i>applicable for RC1N/RC2N/RC2/RC3</i>	
6960263	1 1 1 1 1 1 1 1	E6/C0 Sonderfarbe Niro-Design RAL9016 <i>anodized</i> <i>Special colour</i> <i>Niro design</i> <i>RAL9016</i>	R+L	Fenstergriff mit ovaler Rosette, Druckknopf ohne Schrauben Vierkantlänge 30 mm Window handle <i>with oval rosette, press button</i> <i>without screws</i> <i>square length 30 mm</i>	

Zusatzbeschläge und Griffe (einwärts)
Additional hardware and handles (inwards)

Artikel Article	VE PU	Farbe Colour	DIN DIN	Bezeichnung / Hinweise Designation / Indications	Abbildung Figure
6960264	1 1 1 1 1 1 1 1	E6/C0 Sonderfarbe Niro-Design RAL9016 <i>anodized</i> <i>Special colour</i> <i>Niro design</i> <i>RAL9016</i>	R+L	Tilt-First Fenstergriff mit ovaler Rosette, Tilt-First abschließbar Mit Zusatzfunktion Drehstellung abschließbar ohne Schrauben Vierkantlänge 30 mm Tilt-First window handle <i>with oval rosette, Tilt-First, lockable</i> <i>With additional function, lockable in turn position</i> <i>without screws</i> <i>square length 30 mm</i>	
6960265	1 1	roh <i>untreated</i>	R+L	Fenstergriff U-Form mit ovaler Rosette, Edelstahl ohne Schrauben Vierkantlänge 30 mm Window handle, U-shape <i>with oval rosette, stainless steel</i> <i>without screws</i> <i>square length 30 mm</i>	
6960266	1 1	roh <i>untreated</i>	R+L	Fenstergriff L-Form mit ovaler Rosette, Edelstahl ohne Schrauben Vierkantlänge 30 mm Window handle, L-shape <i>with oval rosette, stainless steel</i> <i>without screws</i> <i>square length 30 mm</i>	
6960282	1 1	E6/C0 <i>anodized</i>	R+L	Fenstergriff U-Form mit ovaler Rosette, ohne Schrauben, Vierkantlänge 30 mm Window handle, U-shape <i>with oval rosette, without screws, square length</i> <i>30 mm</i>	
6960283	1 1	E6/C0 <i>anodized</i>	R+L	Fenstergriff L-Form mit ovaler Rosette, ohne Schrauben, Vierkantlänge 30 mm Window handle, L-shape <i>with oval rosette, without screws, square length</i> <i>30 mm</i>	

Artikel Article	VE PU	Farbe Colour	DIN DIN	Bezeichnung / Hinweise Designation / Indications	Abbildung Figure
6960284	1 1	E6/C0 <i>anodized</i>	R+L	<p>Fenstergriff Tilt-First (TBT4), U-Form mit ovaler Rosette Tilt-First abschließbar mit Zusatzfunktion Drehstellung abschließbar ohne Schrauben Vierkantlänge 30 mm</p> <p>erfüllt Anforderung 100 Nm, gem. DIN EN 1627: 2011 einsetzbar bei RC1N/RC2N/RC2/RC3</p> <p>Window handle Tilt-First (TBT4), U-shape <i>with oval rosette</i> <i>Tilt-First lockable</i> <i>with additional function turn</i> <i>position lockable</i> <i>without screws</i> <i>square length 30 mm</i></p> <p><i>fulfils requirement: 100 Nm,</i> <i>acc. to DIN EN 1627: 2011</i> <i>applicable for RC1N/RC2N/RC2/RC3</i></p>	
6960285	1 1	E6/C0 <i>anodized</i>	R+L	<p>Fenstergriff Tilt-First (TBT4), L-Form mit ovaler Rosette Tilt-First abschließbar mit Zusatzfunktion Drehstellung abschließbar ohne Schrauben Vierkantlänge 30 mm</p> <p>erfüllt Anforderung 100 Nm, gem. DIN EN 1627: 2011 einsetzbar bei RC1N/RC2N/RC2/RC3</p> <p>Window handle Tilt-First (TBT4), L-shape <i>with oval rosette</i> <i>Tilt-First lockable</i> <i>with additional function turn</i> <i>position lockable</i> <i>without screws</i> <i>square length 30 mm</i></p> <p><i>fulfils requirement: 100 Nm,</i> <i>acc. to DIN EN 1627: 2011</i> <i>applicable for RC1N/RC2N/RC2/RC3</i></p>	

Artikel Article	VE PU	Farbe Colour	DIN DIN	Bezeichnung / Hinweise Designation / Indications	Abbildung Figure
6960277	1 1	roh <i>untreated</i>	R+L	<p>Fenstergriff Tilt-First (TBT4), U-Form, Edelstahl mit ovaler Rosette Tilt-First abschließbar mit Zusatzfunktion Drehstellung abschließbar ohne Schrauben Vierkantlänge 30 mm</p> <p>erfüllt Anforderung 100 Nm gem. DIN EN 1627 einsetzbar bei RC1N/RC2N/RC2/RC3</p> <p>Window handle Tilt-First (TBT4), U-shape, stainless steel <i>with oval rosette</i> <i>Tilt-First lockable</i> <i>with additional function turn</i> <i>position lockable</i> <i>without screws</i> <i>square length 30 mm</i></p> <p><i>fulfils requirement: 100 Nm</i> <i>acc. to DIN EN 1627</i> <i>applicable for RC1N/RC2N/RC2/RC3</i></p>	
6960279	1 1	roh <i>untreated</i>	R+L	<p>Fenstergriff Tilt-First (TBT4), L-Form, Edelstahl mit ovaler Rosette Tilt-First abschließbar mit Zusatzfunktion Drehstellung abschließbar ohne Schrauben Vierkantlänge 30 mm</p> <p>erfüllt Anforderung 100 Nm gem. DIN EN 1627 einsetzbar bei RC1N/RC2N/RC2/RC3</p> <p>Window handle Tilt-First (TBT4), L-shape, stainless steel <i>with oval rosette</i> <i>Tilt-First lockable</i> <i>with additional function turn</i> <i>position lockable</i> <i>without screws</i> <i>square length 30 mm</i></p> <p><i>fulfils requirement: 100 Nm</i> <i>acc. to DIN EN 1627</i> <i>applicable for RC1N/RC2N/RC2/RC3</i></p>	

Artikel Article	VE PU	Farbe Colour	DIN DIN	Bezeichnung / Hinweise Designation / Indications	Abbildung Figure
6960037	1 1	RAL9016 RAL9016	R+L	Steckgriff für Steckgriffrosette Removable plug handle for Rosette for removable plug handle	
6960038	1 1 1 1 1 1	silber RAL9005 RAL9010 silver RAL9005 RAL9010	R+L	Steckgriff-Rosette, verschiebbar ovale Abdeckung nach oben und unten verschiebbar, ohne Steckgriff und Schrauben Rosette for removable plug handle, slidable slidable oval cover towards top and bottom, without removable plug handle and screws	
6061030	1 1	roh untreated	R+L	Steckgriff-Rosette oval, Edelstahl, Abdeckung nach links und rechts drehbar. Bei Drehflügel ohne waagrechte Mittelveriegelung ist eine Verschiebesicherung zusätzlich erforderlich. Ohne Schrauben und Steckgriff Rosette for removable plug handle oval, stainless steel, left/right turnable cover a shift safeguard is additionally necessary for turn sash without horizontal centre lock Without screws and removable plug handle	
6940095	100 100	roh untreated	R+L	Senkschraube M5 x 35 T25 für Fenstergriff mit Vierkant bzw. Steckgriff-Rosette Countersunk screw M5 x 35 T25 for window handle with square or rosette for removable plug handle	

WICLINE 75

Drehbeschlag/Stulpbeschlag (auswärts)
Turn fitting/double casement fitting (outwards)

Beschläge
Fittings

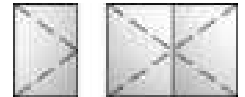

Artikel Article	VE PU	Farbe Colour	DIN DIN	Bezeichnung / Hinweise Designation / Indications	Abbildung Figure
6950073	1 1 1 1	silber RAL9016 silver RAL9016	R+L	<p>Klapp-/Dreh-Bandseite Klappflügel: max. Flügelgewicht 80 kg (bei Einsatz von 4 Bändern max. 150 kg) Drehflügel: max. Flügelgewicht 80 kg (bei Einsatz von 4 Bändern max. 100 kg) Bohrschablone: 5910055</p> <p>Top-hung/Turn hinge set Top hung sash: max. sash weight 80 kg (in application of 4 hinges max. 150 kg) Turn sash: max. sash weight 80 kg (in application of 4 hinges max. 100 kg) drill template: 5910055</p>	
6950074	1 1 1 1	silber RAL9016 silver RAL9016	R+L	<p>Mittel-Band (senkrecht oder waagerecht) Einsatz: senkrecht bei Drehflügel auswärts, waagrecht bei Klappflügel auswärts Bohrschablone: 5910055</p> <p>Centre hinge (vertical or horizontal) Application: vertical for turn sash, outwards horizontal for top hung sash drilling jig: 5910055</p>	
6950078	1 1	roh untreated	R+L	<p>Mittelveriegelungs-Set mit Eckumlenkung mit Schaltsperre</p> <p>Centre lock set with corner transmission with faulty operation detent</p>	
6950071	1 1	roh untreated	R+L	<p>Mittelveriegelung senkrecht oder waagerecht</p> <p>Centre lock vertical or horizontal</p>	
6940100	1 1	roh untreated	R+L	<p>Griffarretierung 90°</p> <p>Handle lock 90°</p>	

WICLINE 75

Drehbeschlag/Stulpbeschlag (auswärts)
Turn fitting/double casement fitting (outwards)

Beschläge
Fittings

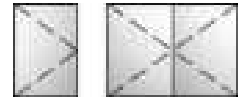

Artikel Article	VE PU	Farbe Colour	DIN DIN	Bezeichnung / Hinweise Designation / Indications	Abbildung Figure
6940027	10 10	roh <i>untreated</i>	R+L	Auflaufset Run-up-block set	
6950062	1 1	roh <i>untreated</i>	R+L	Verschluss für Fenstertür auswärts für Verriegelung waagrecht umlaufender Rahmen Lock for casement door, outwards for locking horizontal floating frame	
6940097	1 1	roh <i>untreated</i>	R+L	Stulpriegel-Verschluss mit Kniehebel Double casement bolt lock with toggle lever	
6950083	1 1	roh <i>untreated</i>	R+L	Stulp-Schließstück „Fenstertür“ Double casement locking piece „Casement door“	
6950155	1 1	roh <i>untreated</i>	R+L	Drehbegrenzer gebremst, Gr. 1 für Fenstertür auswärts individuell einstellbar FAB = 450 - 700 mm Turn restrictor with brake, size 1 for casement door outwards adjustable individually FAB = 450 - 700 mm	
6950150	1 1	roh <i>untreated</i>	R+L	Drehbegrenzer gebremst, Gr. 2 für Fenstertür auswärts individuell einstellbar FAB = 701 - 1600 mm Turn limiter with brake, size 2 for casement door outwards adjustable individually FAB = 701 - 1600 mm	

Zusatzbeschläge für Fenstertüren mit barrierefreier Schwelle
(einwärts/auswärts)

Additional hardware for casement doors with
barrier free threshold (inwards/outwards)



Artikel Article	VE PU	Farbe Colour	DIN DIN	Bezeichnung / Hinweise Designation / Indications	Abbildung Figure
6950148	1 1	roh <i>untreated</i>	R+L	Auflauf-Set für 1-flg. Fenstertür einwärts für barrierefreie Schwelle Run up block set <i>for single casement door inwards for threshold without barrier</i>	
6950149	1 1	roh <i>untreated</i>	R+L	Stulpschließbock mit Aufläufen für 2-flg. Fenstertür einwärts für barrierefreie Schwelle Double casement striker with run-up blocks <i>for double casement door inwards for threshold without barrier</i>	
6950165	1 1	roh <i>untreated</i>	R	Zusatzgarnitur Verschlusssteil DK Additional set locking part Turn/Tilt	
6950166	1 1	roh <i>untreated</i>	L		
6950168	1 1	roh <i>untreated</i>	L	Zusatzgarnitur Verschlusssteil TF Additional set locking part Tilt-First	
6950167	1 1	roh <i>untreated</i>	R		
6960278	1 1	roh <i>untreated</i>	R+L	Fehlbedienungssicherung mit Anschlag komplett Schaltsperr passend zu Fenstergetriebe abschließbar Verwendung in Kombination mit DK- und TF-Beschlag Faulty operation safeguard <i>complete with stop fail safe device fitting to window gear, lockable application in combination with Turn/Tilt and Tilt-First fitting</i>	

Zusatzbeschläge für Fenstertüren mit barrierefreier Schwelle
(einwärts/auswärts)

Additional hardware for casement doors with
barrier free threshold (inwards/outwards)



Artikel Article	VE PU	Farbe Colour	DIN DIN	Bezeichnung / Hinweise Designation / Indications	Abbildung Figure
6940300	1 1	roh <i>untreated</i>	R+L	Schnäpper-Set für Fenstertür Catch set for casement door	
6950081	1 1	roh <i>untreated</i>	R+L	Auflauf-Set für 1-flg. Fenstertür auswärts für barrierefreie Schwelle Run-up block set for version treshold for single casement door outwards for threshold without barrier	
6950082	1 1	roh <i>untreated</i>	R+L	Stulpschließbock mit Auflauf für 2-flg. Fenstertür auswärts für barrierefreie Schwelle Striker double casement with run-up block for double casement door outwards for threshold without barrier	
6940028	10 10	roh <i>untreated</i>	R+L	Schnäpper-Set für Fenstertür Catch set for casement door	
6950063	1 1	roh <i>untreated</i>	R	Verschlussriegel 2 flg. Shoot bolt rod double sash	
6950064	1 1	roh <i>untreated</i>	L		

Zusatzbeschläge für Fenstertüren mit barrierefreier Schwelle
(einwärts/auswärts)

Additional hardware for casement doors with
barrier free threshold (inwards/outwards)





Artikel Article	VE PU	Farbe Colour	DIN DIN	Bezeichnung / Hinweise Designation / Indications	Abbildung Figure
6960270	1 1	roh <i>untreated</i>	R+L	<p>Fenstergetriebe, abschließbar abschließbar in Verschluss- und in Kippstellung für 7 mm Vierkant Dornmaß 25 mm PZ-Lochung Stulp 20 x 2 mm, Niro Verwendung in Kombination mit DK-, TF- oder D-Beschlag Fenstergriff mit ovaler Rosette einseitige Betätigung nur innen für Flügelprofil 1916104 und 1917104</p> <p>Window gear, lockable lockable in locking and tilt position 7 mm square pin backset dimension 25 mm PC punch 20 x 2 mm cover, niro application in combination with Turn/Tilt, Tilt-First or Turn fittings window handles with oval rosette for one-sided operation only for sash profile 1916104 and 1917104</p>	
6960271	1 1	roh <i>untreated</i>	R+L	<p>Fenstergetriebe, abschließbar abschließbar in Verschluss- und in Kippstellung für 7 mm Vierkant Dornmaß 35 mm PZ-Lochung Stulp 20 x 2 mm, Niro Verwendung in Kombination mit DK-, TF- oder D-Beschlag Fenstergriffgarnituren oder Fenstergriffe mit ovaler Rosette für Betätigung wahlweise einseitig innen bzw. innen und außen für Flügelprofil 1916115 und 1917115</p> <p>Window gear, lockable lockable in locking and tilt position 7 mm square pin backset dimension 35 mm PC punch 20 x 2 mm cover, niro application in combination with Turn/Tilt, Tilt-First or Turn fitting window handle sets or window handles with oval rosette for one-sided operation only inside or inside and outside for sash profile 1916115 and 1917115</p>	

Zusatzbeschläge für Fenstertüren mit barrierefreier Schwelle
(einwärts/auswärts)

Additional hardware for casement doors with
barrier free threshold (inwards/outwards)



Artikel Article	VE PU	Farbe Colour	DIN DIN	Bezeichnung / Hinweise Designation / Indications	Abbildung Figure
6960272	1 1	roh <i>untreated</i>	R+L	<p>Fenstergetriebe, abschließbar abschließbar in Verschluss- und in Kippstellung für 7 mm Vierkant Dornmaß 25 mm RZ-Lochung Stulp 20 x 2 mm, Niro Verwendung in Kombination mit DK-, TF- oder D-Beschlag und Fenstergriff mit ovaler Rosette einseitige Betätigung nur innen</p> <p>Window gear, lockable <i>lockable in locking and tilt position</i> <i>7 mm square pin</i> <i>backset dimension 25 mm</i> <i>RC punch</i> <i>20 x 2 mm cover, niro</i> <i>application in combination with</i> <i>Turn/Tilt, Tilt-First or Turn fittings</i> <i>window handles with oval rosette</i> <i>for one-sided operation only inside</i></p>	
6960273	1 1	roh <i>untreated</i>	R+L	<p>Fenstergetriebe, abschließbar abschließbar in Verschluss- und in Kippstellung für 7 mm Vierkant Dornmaß 35 mm RZ-Lochung Stulp 20 x 2 mm, Niro Verwendung in Kombination mit DK-, TF- oder D-Beschlag und Fenstergriffgarnituren oder Fenstergriffe mit ovaler Rosette für Betätigung wahlweise einseitig nur innen bzw. innen und außen</p> <p>Window gear, lockable <i>lockable in locking and tilt position</i> <i>7 mm square pin</i> <i>backset dimension 35 mm</i> <i>RC punch</i> <i>20 x 2 mm cover, niro</i> <i>application in combination with</i> <i>Turn/Tilt, Tilt-First or Turn fitting</i> <i>window handle sets or</i> <i>window handles with oval rosette</i> <i>for one-sided operation</i> <i>only inside or inside and outside</i></p>	

Zusatzbeschläge für Fenstertüren mit barrierefreier Schwelle

(einwärts/auswärts)

Additional hardware for casement doors with
barrier free threshold (inwards/outwards)



Artikel Article	VE PU	Farbe Colour	DIN DIN	Bezeichnung / Hinweise Designation / Indications	Abbildung Figure
6960043	1 30 1 30	roh roh <i>untreated</i> <i>untreated</i>	R+L	<p>Fenstergetriebe, abschließbar abschließbar in Verschluss- und in Kippstellung für 7 mm Vierkant Dornmaß 30 mm PZ-Lochung Stulp 20 x 2 mm, Niro Verwendung in Kombination mit DK-, TF- oder D-Beschlag und Fenstergriff mit ovaler Rosette einseitige Betätigung nur innen</p> <p>Window gear, lockable <i>lockable in locking and tilt position</i> <i>7 mm square pin</i> <i>backset dimension 30 mm</i> <i>PC punch</i> <i>20 x 2 mm cover, niro</i> <i>application in combination with</i> <i>Turn/Tilt, Tilt-First or Turn fitting</i> <i>window handle sets or</i> <i>window handles with oval rosette</i> <i>for one-sided operation</i> <i>only inside or inside and outside</i></p>	
6960044	1 1	roh <i>untreated</i>	R+L	<p>Fenstergetriebe, abschließbar abschließbar in Verschluss- und in Kippstellung für 7 mm Vierkant Dornmaß 30 mm RZ-Lochung Stulp 20 x 2 mm, Niro Verwendung in Kombination mit DK-, TF- oder D- Beschlag und Fenstergriffgarnituren oder Fenstergriffe mit ovaler Rosette für Betätigung wahlweise einseitig nur innen bzw. innen und außen</p> <p>Window gear, lockable <i>lockable in locking and tilt position</i> <i>7 mm square pin</i> <i>backset dimension 30 mm</i> <i>RC punch</i> <i>20 x 2 mm cover, niro</i> <i>application in combination with</i> <i>Turn/Tilt, Tilt-First or Turn fitting</i> <i>window handle sets or</i> <i>window handles with oval rosette</i> <i>for one-sided operation</i> <i>only inside or inside and outside</i></p>	

Zusatzbeschläge für Fenstertüren mit barrierefreier Schwelle (einwärts/auswärts)

Additional hardware for casement doors with
barrier free threshold (inwards/outwards)



Artikel Article	VE PU	Farbe Colour	DIN DIN	Bezeichnung / Hinweise Designation / Indications	Abbildung Figure
6061038	1 1 1 1 1 1 1 1	silber RAL9005 RAL9010 RAL9016 silver RAL9005 RAL9010 RAL9016	R+L	Fenstergriff - Set mit ovalen Rosetten, Zylinderrosetten PZ-gelocht, verdeckt geschraubt, mit 7 mm Vkt.-Stift, inkl. Befestigungsschrauben WL 65 Handle set with oval rosettes, cylinder rosettes with punched hole for profile cylinder, concealed screwing, with 7 mm square pin, including fastening screws WL 65	
6061040	1 1 1 1 1 1 1 1	silber RAL9005 RAL9010 RAL9016 silver RAL9005 RAL9010 RAL9016	R+L	Fenstergriff - Set mit ovalen Rosetten, Zylinderrosetten PZ-gelocht verdeckt geschraubt, mit 7 mm Vkt.-Stift inkl. Befestigungsschrauben mit kurzem Griffhals außen für Einsatz bei Rollladen-Führungsprofilen Rollladenabstand über 25 mm WL 65 Handle set with oval rosettes with punched hole for profile cylinder, concealed screwing with 7 mm square pin including fastening screws with short handle neck outside for application of shutter guide profiles shutter distance above 25 mm WL 65	
6061045	1 1 1 1 1 1 1 1	silber RAL9005 RAL9010 RAL9016 silver RAL9005 RAL9010 RAL9016	R+L	Fenstergriff - Set mit ovalen Rosetten, verdeckt geschraubt mit 7 mm Vkt.-Stift inkl. Befestigungsschrauben WL 65 Handle set with oval rosettes concealed screwing with 7 mm square pin including fastening screws WL 65	

Zusatzbeschläge für Fenstertüren mit barrierefreier Schwelle
(einwärts/auswärts)

Additional hardware for casement doors with
barrier free threshold (inwards/outwards)







Artikel Article	VE PU	Farbe Colour	DIN DIN	Bezeichnung / Hinweise Designation / Indications	Abbildung Figure
6061047	1 1 1 1 1 1 1 1	silber RAL9005 RAL9010 RAL9016 silver RAL9005 RAL9010 RAL9016	R+L	Fenstergriff - Set mit ovalen Rosetten, verdeckt geschraubt mit 7 mm Vkt.-Stift, inkl. Befestigungsschrauben mit kurzem Griffhals außen für Einsatz bei Rollladen-Führungsprofilen Rollenabstand über 25 mm WL 65 Handle set with oval rosettes concealed screwing with 7 mm square pin including fastening screws with short handle neck outside for application of shutter guide profiles shutter distance above 25 mm WL 65	
6061042	1 1	weiß white	R+L	Fensterziehgriff Kunststoff, verdeckt geschraubt Pull handle plastic, concealed screwing	
6930010	1 1 1 1 1 1	E6/C0 RAL9005 RAL9016 anodized RAL9005 RAL9016	R+L	Schiebe-Zylinderrosette verdeckte Befestigung Cylindrical slide rosette concealed fixing	
6930035	1 1	roh untreated	R+L	Schiebe- Zylinderrosette verdeckte Befestigung Cylindrical slide rosette concealed fixing	

Zusatzbeschläge für Fenstertüren mit barrierefreier Schwelle
(einwärts/auswärts)

Additional hardware for casement doors with
barrier free threshold (inwards/outwards)



Artikel Article	VE PU	Farbe Colour	DIN DIN	Bezeichnung / Hinweise Designation / Indications	Abbildung Figure
6930094	1 1	roh <i>untreated</i>	R+L	Zylinderrosette, oval zum Aufkleben Oval cylindre rosette <i>to glue on</i>	
6930093	1 1	roh <i>untreated</i>	R+L	Zylinder-Rundrosette Cylindrical round rosette	
6920741	1 1	roh <i>untreated</i>	R+L	Profil-Doppelzylinder nach EN 1303 mit Freilauf verschiedenschließend mit 3 Schlüsseln	
6920742	1 1	roh <i>untreated</i>	R+L	Profile double cylinder <i>acc. to EN 1303</i> <i>with free wheel</i> <i>diverse closing</i> <i>with 3 keys</i>	
6960275	1 1	roh <i>untreated</i>	R+L	Profil-Doppelzylinder nach EN 1303 Maß a: 65 mm Maß i: 30 mm Zylinderbefestigungsschraube M5 verschiedenschließend mit 3 Schlüsseln WL 75 Profile double cylinder <i>acc. to EN 1303</i> <i>dimension a: 65 mm</i> <i>dimension i: 30 mm</i> <i>M5 fixing screw</i> <i>individually keyed</i> <i>with 3 keys</i> <i>WL 75</i>	

Zusatzbeschläge für Fenstertüren mit barrierefreier Schwelle
(einwärts/auswärts)

Additional hardware for casement doors with
barrier free threshold (inwards/outwards)



Artikel Article	VE PU	Farbe Colour	DIN DIN	Bezeichnung / Hinweise Designation / Indications	Abbildung Figure
6960276	1 1	roh <i>untreated</i>	R+L	<p>Profil-Halbzylinder nach EN 1303 Maß i: 30 mm Zylinderbefestigungsschraube M5 verschiedenschließend mit 3 Schlüsseln</p> <p>Profile semi-cylinder acc. to EN 1303 dimension i: 30 mm M5 fixing screw individually keyed with 3 keys</p>	
6960046	1 1	roh <i>untreated</i>	R+L	<p>Profil- Halbzylinder nach EN 1303 Maß i: 30 mm Zylinderbefestigungsschraube M5 verschiedenschließend mit 3 Schlüsseln</p> <p>Half profile cylinder acc. to EN 1303 dimension i: 30 mm M5 fixing screw diverse closing with 3 keys</p>	
6960052	1 1	roh <i>untreated</i>	R+L	<p>Profil-Doppelzylinder nach EN 1303 Maß a: 70 mm Maß i: 25 mm Zylinderbefestigungsschraube M5 verschiedenschließend mit 3 Schlüsseln WL 75</p> <p>Profile double cylinder acc. to EN 1303 dimension a: 70 mm dimension i: 25 mm M5 fixing screw diverse closing with 3 keys WL 75</p>	

Zusatzbeschläge für Fenstertüren mit barrierefreier Schwelle (einwärts/auswärts)

Additional hardware for casement doors with
barrier free threshold (inwards/outwards)



Artikel Article	VE PU	Farbe Colour	DIN DIN	Bezeichnung / Hinweise Designation / Indications	Abbildung Figure
6960047	1 1 1 1	E6/C0 RAL9016 anodized RAL9016	R+L	<p>Fenstergriff - Set mit ovalen Rosetten, Zylinderrosetten PZ-gelocht verdeckt geschraubt mit 7 mm Vkt.-Stift inkl. Befestigungsschrauben WL 75</p> <p>Handle set with oval rosettes, cylinder rosettes with punched hole for profile cylinder concealed screwing with 7 mm square pin including fastening screws WL 75</p>	
6960048	1 1 1 1	E6/C0 RAL9016 anodized RAL9016	R+L	<p>Fenstergriff - Set mit ovalen Rosetten, Zylinderrosetten PZ-gelocht verdeckt geschraubt mit 7 mm Vkt.-Stift inkl. Befestigungsschrauben mit kurzem Griffhals außen für Einsatz bei Rollladen-Führungsprofilen Rollladenenabstand über 25 mm WL 75</p> <p>Handle set with oval rosettes cylinder rosettes with punched hole for profile cylinder concealed screwing with 7 mm square pin including fastening screws with short handle neck outside for application of shutter guide profiles shutter distance above 25 mm WL 75</p>	
6960049	1 1 1 1	E6/C0 RAL9016 anodized RAL9016	R+L	<p>Fenstergriff - Set mit ovalen Rosetten verdeckt geschraubt, mit 7 mm Vkt.-Stift inkl. Befestigungsschrauben WL 75</p> <p>Handle set with oval rosettes concealed screwing, with 7 mm square pin including fastening screws WL 75</p>	

WICLINE 75

Beschläge
Fittings

Zusatzbeschläge für Fenstertüren mit barrierefreier Schwelle
(einwärts/auswärts)

Additional hardware for casement doors with
barrier free threshold (inwards/outwards)



Artikel Article	VE PU	Farbe Colour	DIN DIN	Bezeichnung / Hinweise Designation / Indications	Abbildung Figure
6960050	1 1 1 1	E6/C0 RAL9016 anodized RAL9016	R+L	<p>Fenstergriff - Set mit ovalen Rosetten verdeckt geschraubt, mit 7 mm Vkt.-Stift inkl. Befestigungsschrauben mit kurzem Griffhals außen für Einsatz bei Rollladen-Führungsprofilen Rollladenabstand über 25 mm WL 75</p> <p>Handle set with oval rosettes concealed screwing, with 7 mm square pin including fastening screws with short handle neck outside for application of shutter guide profiles shutter distance above 25 mm WL 75</p>	



Artikel Article	VE PU	Farbe Colour	DIN DIN	Bezeichnung / Hinweise Designation / Indications	Abbildung Figure
6950073	1 1 1 1	silber RAL9016 silver RAL9016	R+L	<p>Klapp-/Dreh-Bandseite Klappflügel: max. Flügelgewicht 80 kg (bei Einsatz von 4 Bändern max. 150 kg) Drehflügel: max. Flügelgewicht 80 kg (bei Einsatz von 4 Bändern max. 100 kg) Bohrschablone: 5910055</p> <p>Top-hung/Turn hinge set Top hung sash: max. sash weight 80 kg (in application of 4 hinges max. 150 kg) Turn sash: max. sash weight 80 kg (in application of 4 hinges max. 100 kg) drill template: 5910055</p>	
6950074	1 1 1 1	silber RAL9016 silver RAL9016	R+L	<p>Mittel-Band (senkrecht oder waagerecht) Einsatz: senkrecht bei Drehflügel auswärts, waagrecht bei Klappflügel auswärts Bohrschablone: 5910055</p> <p>Centre hinge (vertical or horizontal) Application: vertical for turn sash, outwards horizontal for top hung sash drilling jig: 5910055</p>	
6950072	1 1	roh untreated	R+L	<p>Klapp-/Dreh-Verschluss-Seite</p> <p>Top-hung/Turn lock set</p>	
6950076	1 1	roh untreated	R+L	<p>Auflauf-Set für Klappfenster</p> <p>Run up block set for Top hung window</p>	
6950075	1 1	roh untreated	R+L	<p>Klapp-Verschluss-Set für Klappfenster</p> <p>Top hung lock set for Top hung window</p>	

WICLINE 75

Klappbeschlag auswärts
Top hung fitting outwards

Beschläge
Fittings





Artikel <i>Article</i>	VE <i>PU</i>	Farbe <i>Colour</i>	DIN <i>DIN</i>	Bezeichnung / Hinweise <i>Designation / Indications</i>	Abbildung <i>Figure</i>
6950071	1 1	roh <i>untreated</i>	R+L	Mittelverriegelung senkrecht oder waagrecht Centre lock <i>vertical or horizontal</i>	



Artikel Article	VE PU	Farbe Colour	DIN DIN	Bezeichnung / Hinweise Designation / Indications	Abbildung Figure
6950085	1 1	roh <i>untreated</i>	R+L	<p>Senk-Klapp Grundbeschlag FG max. = Senk-Klapp-Scheren Größe FAB min. = 600 mm FAH min. = 500 mm (FAB/FAH max. = siehe zulässige Flügelgrößen)</p> <p>Italian style basic fitting <i>max. sash weight = retainer arm set size</i> <i>min. sash width = 600 mm</i> <i>min. sash height = 500 mm</i> (max. sash width / height = see admissible sash sizes)</p>	
6950102	1 1	roh <i>untreated</i>	R+L	<p>Auflauf-Set</p> <p>Run up block set</p>	
6950086	1 1	roh <i>untreated</i>	R+L	<p>Senk-Klapp Grundbeschlag mit Eckumlenkungen für senkrechte Verriegelungen FG max. = Senk-Klapp-Scherenset Größe FAB min. = 600 mm FAH min. = 500 mm (FAB/FAH max. = siehe zulässige Flügelgrößen)</p> <p>Italian style basic fitting with corner transmissions <i>max. sash weight = retainer arm set size</i> <i>min. sash width = 600 mm</i> <i>min. sash height = 500 mm</i> (max. sash width / height = see admissible sash sizes)</p>	
6950087	1 1	roh <i>untreated</i>	R+L	<p>Waagerechte Mittelverriegelung unten</p> <p>Horizontal centre lock <i>bottom</i></p>	

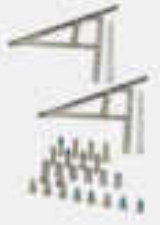

Artikel Article	VE PU	Farbe Colour	DIN DIN	Bezeichnung / Hinweise Designation / Indications	Abbildung Figure
6950088	1 1	roh <i>untreated</i>	R+L	Waagerechte Mittelverriegelung oben Horizontal centre lock <i>top</i>	
6950089	1 1	roh <i>untreated</i>		Senk-Klapp-Scherenset Gr. 1 max. Flügelgewicht = 100 kg --> Öffnungswinkel = 30° (max. Flügelgewicht = 55 kg --> Öffnungswinkel = 50°) min. Flügelhöhe = 650 mm max. Flügelhöhe = 800 mm max. Flügelbreite = 2000 mm Bohrschablone: 5910049 Retainer arm set size 1 <i>max. sash weight = 100 kg</i> <i>--> opening angle = 30°</i> <i>(max. sash weight 55 kg</i> <i>--> opening angle = 50°)</i> <i>min. sash height = 650 mm</i> <i>max. sash height = 800 mm</i> <i>max. sash width = 2000 mm</i> <i>drill template: 5910049</i>	
6950090	1 1	roh <i>untreated</i>		Senk-Klapp-Scherenset Gr. 2 max. Flügelgewicht = 100 kg --> 20° Öffnungswinkel (max. Flügelgewicht = 80 kg --> 45° Öffnungswinkel) min. Flügelhöhe = 800 mm max. Flügelhöhe = 1500 mm max. Flügelbreite = 2000 mm Bohrschablone: 5910049 Retainer arm set size 2 <i>max. sash weight = 100 kg</i> <i>--> opening angle 20°</i> <i>(max. sash weight = 80 kg</i> <i>--> opening angle 45 °)</i> <i>min. sash height = 800 mm</i> <i>max. sash height = 1500 mm</i> <i>max. sash width = 2000 mm</i> <i>drill template: 5910049</i>	

WICLINE 75

Senk-Klapp-Beschlag
Italian Style fitting

Beschläge
Fittings



Artikel Article	VE PU	Farbe Colour	DIN DIN	Bezeichnung / Hinweise Designation / Indications	Abbildung Figure
6950091	1 1	roh <i>untreated</i>	R+L	Senk-Klapp-Scherenset Gr. 3 max. Flügelgewicht = 150 kg --> Öffnungswinkel = 20° min. Flügelhöhe = 1300 mm max. Flügelhöhe = 2100 mm max. Flügelbreite = 2000 mm Bohrschablone: 5910050 Retainer arm set size 3 max. sash weight = 150 kg --> opening angle = 20° min. sash height = 1300 mm max. sash height = 2100 mm max. sash width = 2000 mm drill template: 5910050	
6950132	1 1	roh <i>untreated</i>	R+L	Höhenverstellungsset Verstellbereich ± 2 mm Height adjustment set adjustable ± 2 mm	

WICLINE 75

Schwing-Wende-Beschlag

Pivot fitting horizontal / vertical

Beschläge

Fittings

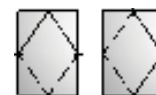

Artikel Article	VE PU	Farbe Colour	DIN DIN	Bezeichnung / Hinweise Designation / Indications	Abbildung Figure
6950065	1 1	roh <i>untreated</i>		<p>Schwing-Wende Beschlag Schwing-Beschlag min. Flügelbreite = 700 mm max. Flügelbreite = 2500 mm min. Flügelhöhe = 700 mm max. Flügelhöhe = 2200 mm Wende-Beschlag min. Flügelbreite = 700 mm max. Flügelbreite = 2000 mm min. Flügelhöhe = 700 mm max. Flügelhöhe = 2200 mm</p> <p>Pivot fitting horizontal/vertical <i>pivot fitting horizontal</i> <i>min. sash width = 700 mm</i> <i>max. sash width = 2500 mm</i> <i>min. sash height = 700 mm</i> <i>max. sash height = 2200 mm</i> <i>pivot fitting vertical</i> <i>min. sash width = 700 mm</i> <i>max. sash width = 2000 mm</i> <i>min. sash height = 700 mm</i> <i>max. sash height = 2200 mm</i></p>	
6940027	10 10	roh <i>untreated</i>	R+L	<p>Auflaufset</p> <p>Run-up-block set</p>	
6940031	10 10	roh <i>untreated</i>	R+L	<p>Dreh-Verschluss Typ 1 oder Mittelverriegelung senkrecht oder waagrecht</p> <p>Turn lock type 1 or centre lock <i>vertical or horizontal</i></p>	
6950071	1 1	roh <i>untreated</i>	R+L	<p>Mittelverriegelung senkrecht oder waagrecht</p> <p>Centre lock <i>vertical or horizontal</i></p>	

WICLINE 75

Schwing-Wende-Beschlag

Pivot fitting horizontal / vertical

Beschläge

Fittings

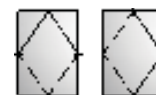

Artikel Article	VE PU	Farbe Colour	DIN DIN	Bezeichnung / Hinweise Designation / Indications	Abbildung Figure
6950139	1 1	roh <i>untreated</i>	R+L	<p>Schwing-Wendelager verdeckt für Schwingfenster: max. Flügelgewicht = 150 kg für Wendefenster: max. Flügelgewicht = 120 kg mittig montiert</p> <p>Pivot bearing concealed for horizontal pivot window max. sash weight = 150 kg for vertical pivot window max. sash weight = 120 kg</p>	
6950156	1 1	roh <i>untreated</i>	R+L	<p>Befestigungsgarnitur für Schwing-Wendelager verdeckt 6950139 Bohrschablone 5910080</p> <p>Fixing set for pivot bearing concealed 6950139 drill template 5910080</p>	
6950098	1 1 1 1	silber RAL9016 silver RAL9016	R+L	<p>Wendelager aufliegend ohne Sperre für Wendefenster max. Flügelgewicht = 100 kg außermittig montiert = max. 100 mm zusätzlich Öffnungsbegrenzer erforderlich WL 65</p> <p>Pivot vertical bearing top mounted without detent for vertical pivot window max. sash weight = 100 kg mounted off centre = max. 100 mm opening limiter is additionally necessary WL 65</p>	
6950121	1 1 1 1	silber RAL9016 silver RAL9016	R+L	<p>Wendelager aufliegend ohne Sperre für Wendefenster max. Flügelgewicht = 100 kg außermittig montiert = max. 100 mm zusätzlich Öffnungsbegrenzer erforderlich WL 75</p> <p>Pivot bearing vertical top mounted without detent for vertical pivot window max. sash weight = 100 kg mounted off centre = max. 100 mm opening limiter is additionally necessary WL 75</p>	

WICLINE 75

Schwing-Wende-Beschlag

Pivot fitting horizontal / vertical

Beschläge

Fittings

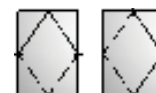

Artikel Article	VE PU	Farbe Colour	DIN DIN	Bezeichnung / Hinweise Designation / Indications	Abbildung Figure
6950099	1 1 1 1	silber RAL9016 silver RAL9016	R+L	<p>Schwinglager aufliegend mit Sperre für Schwingfenster max. Flügelgewicht = 100 kg zusätzlich Öffnungsbegrenzer und Schwing-Putzsperre erforderlich WL 65</p> <p>Pivot bearing horizontal top mounted with detent for horizontal pivot window max. sash weight = 100 kg opening limiter and safeguard for cleaning purposes are additional necessary WL 65</p>	
6950103	1 1 1 1	silber RAL9016 silver RAL9016	R+L	<p>Schwinglager aufliegend mit Sperre und 25° Öffnungsarretierung, abschließbar mit Innensechskantschlüssel 180° Putzfeststellungsarretierung für Schwingfenster max. Flügelgewicht = 100 kg zusätzlich Öffnungsbegrenzer erforderlich WL 65</p> <p>Pivot bearing horizontal top mounted with detent and 25° opening adjustment, lockable with hexagonal socket 180° locking device adjustment for cleaning for horizontal pivot window max. sash weight = 100 kg limited opener is additionally necessary WL 65</p>	
6950122	1 1 1 1	silber RAL9016 silver RAL9016	R+L	<p>Schwinglager aufliegend mit Sperre für Schwingfenster max. Flügelgewicht = 100 kg zusätzlich Öffnungsbegrenzer und Schwing-Putzsperre erforderlich WL 75</p> <p>Pivot bearing horizontal top mounted with detent for horizontal pivot window max. sash weight = 100 kg opening limiter and safeguard for cleaning purposes are additionally necessary WL 75</p>	



WICLINE 75



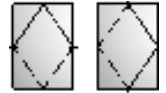

Schwing-Wende-Beschlag
Pivot fitting horizontal / vertical

Beschläge
Fittings







Artikel Article	VE PU	Farbe Colour	DIN DIN	Bezeichnung / Hinweise Designation / Indications	Abbildung Figure
6950123	1 1 1 1	silber RAL9016 silver RAL9016	R+L	<p>Schwinglager aufliegend mit Sperre und 25° Öffnungsarretierung, abschließbar mit Innensechskantschlüssel 180° Putzfeststellungsarretierung für Schwingfenster max. Flügelgewicht = 100 kg zusätzlich Öffnungsbegrenzer erforderlich WL 75</p> <p>Pivot horizontal bearing top mounted with detent and 25° opening adjustment, lockable with hexagonal socket 180° locking device adjustment for cleaning for horizontal pivot window max. sash weight = 100 kg opening limiter is additionally necessary WL 75</p>	
6950069	1 1	roh untreated	R+L	<p>Putzsperr</p> <p>Detent for cleaning</p>	
6950068	1 1	roh untreated		<p>Öffnungsbegrenzer zur Begrenzung der Öffnungsweite auf max. 200 mm</p> <p>Opening limiter to limit opening width of max. 200 mm</p>	

Artikel Article	VE PU	Farbe Colour	DIN DIN	Bezeichnung / Hinweise Designation / Indications	Abbildung Figure
6960039	1 1	roh <i>untreated</i>	R+L	Getriebe Dornmaß 30 mm für 7 mm Vierkant Mortise gear <i>backset dimension 30 mm for 7 mm square pin</i>	
6950092	1 1	roh <i>untreated</i>	R+L	Öffnungsbegrenzer mit Rastung Gr. 1 Opening limiter with catch size 1	
6950118	1 1	roh <i>untreated</i>	R+L	Öffnungsbegrenzer mit Rastung Gr. 2 Opening limiter with catch size 2	
6950119	1 1	roh <i>untreated</i>	R+L	Öffnungsbegrenzer mit Rastung Gr. 3 Opening limiter with catch size 3	
6950135	1 1	roh <i>untreated</i>	R+L	Öffnungsbegrenzer mit Rastung Gr. 4 Opening limiter with catch size 4	
6950133	1 1	roh <i>untreated</i>	R+L	Befestigungs-Set für Öffnungsbegrenzer mit Rastung Fixing set for opening limiter with catch	





Artikel Article	VE PU	Farbe Colour	DIN DIN	Bezeichnung / Hinweise Designation / Indications	Abbildung Figure
6950134	1 1	roh <i>untreated</i>	R+L	Befestigungs-Set für Öffnungsbegrenzer mit Rastung für 6950135, Einsatz bei vertikaler Zusatzverriegelung Fixing set for opening limiter with catch for 6950135, usage for vertical additional lock	
6950147	1 1	roh <i>untreated</i>		Befestigungs-Set mit Brücke für Klappfenster Fixing set with bridge for top hung window	
6960034	1 1 1 1 1 1 1 1	silber RAL9005 RAL9010 RAL9016 <i>silver</i> RAL9005 RAL9010 RAL9016	R+L	Fenstergriff Standard mit ovaler Rosette ohne Schrauben Vierkantlänge 25 mm Window handle, standard with oval rosette without screws square length 25 mm	
6960035	1 1 1 1 1 1 1 1	silber RAL9005 RAL9010 RAL9016 <i>silver</i> RAL9005 RAL9010 RAL9016	R+L	Fenstergriff, abschließbar mit ovaler Rosette ohne Schrauben Vierkantlänge 25 mm Window handle, lockable with oval rosette without screws square length 25 mm	
6950153	1 1	roh <i>untreated</i>		Griff-Befestigung für außen verglasten Flügel 1916161 und 1917161 Handnietzange 5960014 Handle fixation for sash outward glazed 1916161 and 1917161 hand-riveting tongs 5960014	

	Seite Page
Sägebeilagen <i>Sawing shims</i>	7/3
Schablonen <i>Templates</i>	7/9
Stanzwerkzeuge <i>Punching tools</i>	7/21
Presstawerkzeuge <i>Crimping tools</i>	7/37
Verschiedenes <i>Miscellaneous</i>	7/41
Hilfsstoffe <i>Auxilliary means</i>	7/52
Abdichtungen <i>Sealings</i>	7/57



Sägebeilagen
Sawing shims

Artikel Article	VE PU	Anwendung Application	Bezeichnung / Hinweise Designation / Indications	Abbildung Figure
		Material / Material Farbe / Colour	Zuordnung Assignment	
5050009	1 Paar 1 pair	WICLINE 75	Sägebeilage	
			Sawing shim	
			3910040	
5050030	1 Paar 1 pair	WICLINE 75	Sägebeilage	
			Sawing shim	
			1917163	
5050266	1 Paar 1 pair	WICLINE 75	Sägebeilage	
		Al	Sawing shim	
			1010453	
5050267	1 Paar 1 pair	WICLINE 75	Sägebeilage	
		Al	Sawing shim	
			1017124,1017125,1017126	
5050292	1 Paar 1 pair	WICLINE 75	Sägebeilage	
		Al	Sawing shim	
			1017111,1017112,1017113	





Sägebeilagen
Sawing shims

Artikel Article	VE PU	Anwendung Application	Bezeichnung / Hinweise Designation / Indications	Abbildung Figure
		Material / Material Farbe / Colour	Zuordnung Assignment	
5950004	1 Paar 1 pair	WICLINE 75	Sägebeilage	
		Al	Sawing shim	
			1010344,1010346,1010452,1010488,1010489 1010491,1010492,1010495,1017001,1017003 1017004,1017005,1017006,1017008,1017050 1017062,1017064,1017066,1017077,1017203 1017204,1017205,1017206,1017207,1017209 1017213,1017215,1017220,1910134,1910135 1910148,1910149,1910172,1917001,1917002 1917003,1917004,1917005,1917009,1917062 1917064,1917067,1917068,1917069,1917073 1917076,1917077,1917201,1917202,1917203 1917204,1917205,1917206,1917207,1917209 1917211,1917213,1917215,1917220,1917224 1917241,1917246,1917247,1917248,1917249 1917250,1917251,1917256,1917258,1917259 1917260,1917301,1917303,1917331,1917334	
5950007	1 Paar 1 pair	WICLINE 75	Sägebeilage	
		Al	Sawing shim	
			1010434,1010490,1010493,1010494,1017051 1017081,1017082,1017090,1017231,1310991 1910170,1917081,1917082,1917086,1917089 1917231,1917235	
5950008	1 Paar 1 pair	WICLINE 75	Sägebeilage	
		Al	Sawing shim	
			1017101,1017102,1017103,1017104,1017105 1017120,1910146,1910147,1917101,1917102 1917103,1917104,1917115,1917116,1917117 1917118,1917120	
5950009	1 Paar 1 pair	WICLINE 75	Sägebeilage	
		Al	Sawing shim	
			1917105,1917122	







Sägebeilagen
Sawing shims

Artikel Article	VE PU	Anwendung Application	Bezeichnung / Hinweise Designation / Indications	Abbildung Figure
		Material / Material Farbe / Colour	Zuordnung Assignment	
5950010	1 Paar 1 pair	WICLINE 75	Sägebeilage	
		Al	Sawing shim	
			1917338	
5950011	1 Paar 1 pair	WICLINE 75	Sägebeilage	
		Al	Sawing shim	
			1917336,1917339	
5950012	1 Paar 1 pair	WICLINE 75	Sägebeilage	
		Al	Sawing shim	
			1917337	
5950015	1 Paar 1 pair	WICLINE 75	Sägebeilage	
		Al	Sawing shim	
			1917089	
5950016	1 Paar 1 pair	WICLINE 75	Sägebeilage	
		Al	Sawing shim	
			1910134,1910135,1917076,1917077	
5950029	1 Paar 1 pair	WICLINE 75	Sägebeilage	
		Al	Sawing shim	
			1917110	

Sägebeilagen
Sawing shims

Artikel Article	VE PU	Anwendung Application	Bezeichnung / Hinweise Designation / Indications	Abbildung Figure
		Material / Material Farbe / Colour	Zuordnung Assignment	
5950030	1 Paar 1 pair	WICLINE 75	Sägebeilage	
		Al	Sawing shim	
			1917111	
5950031	1 Paar 1 pair	WICLINE 75	Sägebeilage	
		Al	Sawing shim	
			1017111,1017112,1017113,1917112	
5950032	1 Paar 1 pair	WICLINE 75	Sägebeilage	
		Al	Sawing shim	
			1917113	
5950033	1 Paar 1 pair	WICLINE 75	Sägebeilage	
		Al	Sawing shim	
			1917124,1917126	
5950038	1 Paar 1 pair	WICLINE 75	Sägebeilage	
		Al	Sawing shim	
			1010453,1017101,1017102,1017103,1017104 1017105,1910146,1910147,1917101,1917102 1917103,1917104,1917105,1917115	







Sägebeilagen
Sawing shims

Artikel Article	VE PU	Anwendung Application	Bezeichnung / Hinweise Designation / Indications	Abbildung Figure
		Material / Material Farbe / Colour	Zuordnung Assignment	
5950039	1 Paar 1 pair	WICLINE 75	Sägebeilage	
		Al	Sawing shim	
			1917110,1917111,1917112,1917113	
5950040	1 Paar 1 pair	WICLINE 75	Sägebeilage	
		Al	Sawing shim	
			1017120,1917120,1917122	
5950041	1 Paar 1 pair	WICLINE 75	Sägebeilage	
		Al	Sawing shim	
			1017124,1017125,1017126,1917124,1917126	
5950045	1 Paar 1 pair	WICLINE 75	Sägebeilage	
			Sawing shim	
			1917161	
5950046	1 Paar 1 pair	WICLINE 75	Sägebeilage	
			Sawing shim	
			3910040	
5950049	1 Paar 1 pair	WICLINE 75	Sägebeilage	
			Sawing shim	
			1917092,1917165	

WICLINE 75

Werkzeuge
Tools

Sägebeilagen
Sawing shims





Artikel Article	VE PU	Anwendung Application	Bezeichnung / Hinweise Designation / Indications	Abbildung Figure
		Material / Material Farbe / Colour	Zuordnung Assignment	
5950050	1 Paar 1 pair	WICLINE 75	Sägebeilage	
			Sawing shim	
			1917166	
5950051	1 Paar 1 pair	WICLINE 75	Sägebeilage	
			Sawing shim	
			1917093	
5950052	1 Paar 1 pair	WICLINE 75	Sägebeilage	
			Sawing shim	
			1917165,1917166,1917167	
5950053	1 Paar 1 pair	WICLINE 75	Sägebeilage	
			Sawing shim	
			1917092	
5950054	1 Paar 1 pair	WICLINE 75	Sägebeilage	
			Sawing shim	
			1917161,1917163	
5950056	1 Paar 1 pair	WICLINE 75	Sägebeilage	
			Sawing shim	
			1917116,1917117,1917118	





Artikel Article	VE PU	Anwendung Application	Bezeichnung / Hinweise Designation / Indications	Abbildung Figure
		Material / Material Farbe / Colour	Zuordnung Assignment	
5010034	1 St. 1 pcs	WICLINE 75	Bohrschablone für Entwässerung	
			Drill template for drainage	
			1010452,1917246,1917247,1917248,1917249 1917250,1917251,1917258,1917259,1917260	
5010035	1 St. 1 pcs	WICLINE 75	Bohrschablone für Entwässerung	
			Drill template for drainage	
			1017001,1017003,1017004,1017005,1017006 1017008,1017062,1017064,1017066,1017077 1017081,1017082,1017090,1017203,1017204 1017205,1017206,1017207,1017209,1017213 1017215,1017220,1017231,1910148,1910149 1910170,1910172,1917001,1917002,1917003 1917004,1917005,1917062,1917064,1917067 1917068,1917069,1917073,1917076,1917077 1917081,1917082,1917086,1917089,1917201 1917202,1917203,1917204,1917205,1917206 1917207,1917209,1917211,1917213,1917215 1917220,1917224,1917231,1917235,1917241 1917256,1917331	
5010115	1 St. 1 pcs	WICLINE 75	Bohrschablone für WICSTAR OL, LM- Rohr	
			Drill template for WICSTAR Fanlight, aluminium tube	
5010119	1 St. 1 pcs	WICLINE 75	Bohrschablone für WICSTAR OL, Pfosten- / Riegelübertragung	
			Drill template for WICSTAR Fanlight, mullion and transom transmission	

Artikel Article	VE PU	Anwendung Application	Bezeichnung / Hinweise Designation / Indications	Abbildung Figure
		Material / Material Farbe / Colour	Zuordnung Assignment	
5010589	1 St. 1 pcs	WICLINE 75	Bohrschablone für Senk-Klapp Scheren SK2-50, 6050216 Senk-Klapp Scheren SK3-65, 6050222 Senk-Klapp Scheren SK3-100, 6050217 Senk-Klapp Scheren SK3-150, 6050223	
			Drill template for friction stays SK2-50, 6050216 friction stays SK3-65, 6050222 friction stays SK3-100, 6050217 friction stays SK3-150, 6050223	
5010590	1 St. 1 pcs	WICLINE 75	Bohrschablone für Senk-Klapp Scheren SK4-100, 6050218 Senk-Klapp Scheren SK5-180, 6050219	
			Drill template for friction stays SK4-100, 6050218 friction stays SK5-180, 6050219	
5010611	1 St. 1 pcs	WICLINE 75	Bohrschablone Bearbeitung für Standardgriff Parallelschiebe-Kipp ohne Zwangssteuerung 160 kg Verwendung mit Tiefenanschlag 5960396, 5060397	
			Drill template Processing for standard handle Parallel sliding tilt fitting without forced control 160 kg Use with bit stop 5960396, 5060397	
			1917116	
5010628	1 St. 1 pcs	WICLINE 75	Bohrschablone Eckverbindung Flügel	
			Drill template Corner connection of sash	
			1010453	
5010629	1 St. 1 pcs	WICLINE 75	Bohrschablone Eckverbindung Einspannblendrahmen	
			Drill template Corner connection clamping frame	
			1017090	

Artikel Article	VE PU	Anwendung Application	Bezeichnung / Hinweise Designation / Indications	Abbildung Figure
		Material / Material Farbe / Colour	Zuordnung Assignment	
5010632	1 St. 1 pcs	WICLINE 75	Bohrschablone Eck- und Stoßverbindung Blendrahmen	
			Drill template Corner and frame butt-joint connection	
			1010436,1010489,1010490,1010492,1010494 1010503,1019004,1019006,1019010,1019014 1019016,1019020,1019204,1019206,1019209 1019213,1040040,1040041	
5910006	1 St. 1 pcs	WICLINE 75	Bohrschablone Eck- und Stoßverbindung Blendrahmen	
			Drill template corner and butt-joint connection of frame	
			1010344,1010346,1010434,1010452,1010488 1010491,1010493,1010495,1017001,1017003 1017004,1017005,1017006,1017008,1017050 1017051,1017062,1017064,1017066,1017081 1017082,1017203,1017204,1017205,1017206 1017207,1017209,1017213,1017215,1017220 1017231,1910148,1910149,1910170,1910172 1917001,1917002,1917003,1917004,1917005 1917055,1917056,1917057,1917058,1917059 1917060,1917062,1917064,1917067,1917068 1917069,1917073,1917081,1917082,1917086 1917201,1917202,1917203,1917204,1917205 1917206,1917207,1917209,1917211,1917213 1917215,1917220,1917224,1917231,1917235 1917241,1917244,1917246,1917247,1917248 1917249,1917250,1917251,1917256,1917258 1917259,1917260,1917270,1917271,1917272 1917273,1917334	
5910008	1 St. 1 pcs	WICLINE 75	Bohrschablone Stoßverbindung Sprosse Klassik-Design (Außenschale)	
			Drill template Butt-joint connection of Classic design glazing bar (outer profile shell)	
			1917338,1917339	
5910009	1 St. 1 pcs	WICLINE 75	Bohrschablone Bohrungen zum Setzen von Stoßverbinder Sprosse	
			Drill template Drillings for fixing butt-jointconnectors	
			1917336,1917337,1917338,1917339	





Artikel Article	VE PU	Anwendung Application	Bezeichnung / Hinweise Designation / Indications	Abbildung Figure
		Material / Material Farbe / Colour	Zuordnung Assignment	
5910010	1 St. 1 pcs	WICLINE 75	Bohrschablone Variable Eckverbindung vertikal	
			Drill template Variable vertical corner connection	
			1010344,1010346,1010452,1017001,1017003 1017004,1017064,1017081,1017082,1017203 1017204,1017231,1917001,1917002,1917003 1917004,1917055,1917056,1917057,1917058 1917064,1917068,1917069,1917073,1917081 1917082,1917086,1917201,1917202,1917203 1917204,1917231,1917241,1917244,1917246 1917247,1917248	
5910011	1 St. 1 pcs	WICLINE 75	Bohrschablone Variable Stoßverbindung	
			Drill template Variable butt-joint connection	
			1010344,1010346,1010452,1017001,1017003 1017004,1017064,1017081,1017082,1017203 1017204,1017231,1917001,1917002,1917003 1917004,1917055,1917056,1917057,1917058 1917064,1917068,1917069,1917073,1917081 1917082,1917086,1917201,1917202,1917203 1917204,1917231,1917241,1917244,1917246 1917247,1917248	
5910012	1 St. 1 pcs	WICLINE 75	Bohrschablone Variable Eckverbindung horizontal	
			Drill template Variable horizontal corner connection	
			1010344,1010346,1010452,1017001,1017003 1017004,1017062,1017064,1017081,1017082 1017203,1017204,1017231,1917001,1917002 1917003,1917004,1917055,1917056,1917057 1917058,1917062,1917064,1917068,1917069 1917073,1917081,1917082,1917086,1917201 1917202,1917203,1917204,1917231,1917241 1917244,1917246,1917247,1917248,1917256 1917258,1917259,1917260	

Artikel Article	VE PU	Anwendung Application	Bezeichnung / Hinweise Designation / Indications	Abbildung Figure
		Material / Material Farbe / Colour	Zuordnung Assignment	
5910013	1 St. 1 pcs	WICLINE 75	Bohrschablone Eckverbindung Blendrahmen Klassik-Design	
			Drill template Corner connection Classic design frame profile	
			1917009	
5910016	1 St. 1 pcs	WICLINE 75	Bohrschablone Eckverbindung Einspannblendrahmen	
			Drill template Corner connection of clamping frame profile	
			1017077,1910134,1910135,1917076,1917077 1917089	
5910019	1 St. 1 pcs	WICLINE 75	Bohrschablone Stoßverbindung Kämpfer und Sprossen, Eckverbindung Türflügel als Blendrahmen	
			Drill template Butt-joint connection of transom and glazing bar profiles, corner connection of door leaf as frame	
			1917338	
5910020	1 St. 1 pcs	WICLINE 75	Bohrschablone Stoßverbindung Kämpfer und Sprossen, Eckverbindung Türflügel als Blendrahmen	
			Drill template Butt-joint connection of transom and glazing bar profiles, corner connection of door leaf as frame	
			1917336,1917339	
5910021	1 St. 1 pcs	WICLINE 75	Bohrschablone Stoßverbindung Kämpfer und Sprossen	
			Drill template Butt-joint connection transom and glazing bar	
			1310991,1917331,1917337	





Artikel Article	VE PU	Anwendung Application	Bezeichnung / Hinweise Designation / Indications	Abbildung Figure
		Material / Material Farbe / Colour	Zuordnung Assignment	
5910022	1 St. 1 pcs	WICLINE 75	Bohrschablone Direktverschraubung und Entwässerung Stützenprofil geteilt	
			Drill template Direct screwing and drainage of split mullion profile	
			1917256,1917258,1917259,1917260	
5910025	1 St. 1 pcs	WICLINE 75	Bohrschablone Bearbeitung für Standardgriff und rosettenlosem Griff. Verwendung mit Tiefenanschlag 5960396, 5060397.	
			Drill template Processing for standard handle and handle without rosette. Use with bit stop 5960396, 5060397.	
			1010453,1017101,1017102,1017103,1017104 1017105,1017111,1017112,1017113,1910146 1910147,1917101,1917102,1917103,1917104 1917105,1917110,1917111,1917112,1917113 1917115	
5910027	1 St. 1 pcs	WICLINE 75	Bohrschablone Eckverbindung Stulpprofile für Überschlagflügel und verdeckter Flügel	
			Drill template Corner connection of double casement profiles for overlap sash and concealed sash	
			1017120,1017124,1017125,1017126,1917120 1917122,1917124,1917126	
5910029	1 St. 1 pcs	WICLINE 75	Bohrschablone Variable Eckverbindung mit Flügel vertikal	
			Drill template Variable vertical corner connection of sash profiles	
			1017101,1017102,1017103,1917101,1917102 1917103,1917105	



Artikel Article	VE PU	Anwendung Application	Bezeichnung / Hinweise Designation / Indications	Abbildung Figure
		Material / Material Farbe / Colour	Zuordnung Assignment	
5910030	1 St. 1 pcs	WICLINE 75	Bohrschablone für WICSTAR OL 80 für Scherenhalter, Standardflügelbock, Eckumlenkung sowie Handhebel	
		PVC	Drill template for WICSTAR Fanlight OL 80 for stay holder, fanlight sash bracket, corner transmission plus hand lever	
5910031	1 St. 1 pcs	WICLINE 75	Bohrschablone für WICSTAR OL, Spindelgetriebe 201 E	
			Drill template for WICSTAR Fanlight, Gear 201 E	
5910032	1 St. 1 pcs	WICLINE 75	Bohrschablone für WICSTAR OL, Getriebe 200 A	
			Drill template for WICSTAR Fanlight, Gear 200 A	
5910037	1 St. 1 pcs	WICLINE 75	Bohrschablone Eckverbindung Einspannblendrahmen für Senkklapplügel	
			Drill template Corner connection of clamping frame profile for lowering and projecting top-hung sash	
			1917092	
5910038	1 St. 1 pcs	WICLINE 75	Bohrschablone Eckverbindung Blendrahmen für Klappflügel, Drehflügel nach außen	
			Drill template Corner connection of frame for top-hung sash, turn sash outwards	
			1917093	

Artikel Article	VE PU	Anwendung Application	Bezeichnung / Hinweise Designation / Indications	Abbildung Figure
		Material / Material Farbe / Colour	Zuordnung Assignment	
5910040	1 St. 1 pcs	WICLINE 75	Bohrschablone Eckverbindung Schwing-Wende-Wechselprofil, Aufsatzprofil Senk-Klappfenster	
			Drill template Corner connection of horizontal/vertical pivot reversible profile, supplementary profile for lowering and projecting top-hung sash	
			1917165,1917166	
5910042	1 St. 1 pcs	WICLINE 75	Bohrschablone Eckverbindung Schwing-Wende-Wechselprofil	
			Drill template Corner connection of horizontal/vertical pivot reversible profile	
			3910040	
5910043	1 St. 1 pcs	WICLINE 75	Bohrschablone für Schieberstangenbearbeitung und Dreh Sperre	
			Drill template for machining slide rod and turn lock	
			3011015,3011022	
5910044	1 St. 1 pcs	WICLINE 75	Bohrschablone Eckverbindung Schwing-Wendeflügel, Senk- Klappflügel, Klappflügel, Drehflügel nach außen	
			Drill template Corner connection of horizontal/vertical sash, top hung sash, turn sash outwards	
			1917161,1917163	
5910045	1 St. 1 pcs	WICLINE 75	Bohrschablone und Montagelehre Bohrschablone für Zusatzschraube Beschlag. Montagelehre für Schließstück.	
			Drill and assembling template Drill template for additional screw fitting. Assembling template for locking piece.	
			1017003,1017004,1017005,1017066,1910148 1917002,1917003,1917004,1917005,1917069 1917073	

Artikel Article	VE PU	Anwendung Application	Bezeichnung / Hinweise Designation / Indications	Abbildung Figure
		Material / Material Farbe / Colour	Zuordnung Assignment	
5910046	1 St. 1 pcs	WICLINE 75	Montagelehre für DK-Scheren und Zweitschere	
			Assembling template for tilt-and -turn scissor and second scissor	
			1017101,1017102,1017103,1017104,1017105 1910146,1910147,1917101,1917102,1917103 1917104,1917105,1917115	
5910049	1 St. 1 pcs	WICLINE 75	Bohrschablone für Senk-Klapp-Schere Größe 1 und 2 (6950089 und 6950090)	
			Drill template for top hung retainer arm size 1 and 2 (6950089 and 6950090)	
			1917092,1917165	
5910050	1 St. 1 pcs	WICLINE 75	Bohrschablone für Senk-Klapp-Schere Größe 3 (6950091)	
			Drill template for top hung retainer arm size 3 (6950091)	
			1917092,1917165	
5910053	1 St. 1 pcs	WICLINE 75	Bohrschablone Bearbeitung für Standardgriff Sonderöffnungsarten (inklusive Stufenbohrer 5960021)	
			Drill template Processing for standard handle special opening types (inclusive step drill 5960021)	
		roh untreated	1917161,1917163	
5910054	1 St. 1 pcs	WICLINE 75	Bohrschablone Eckverbindung Flügel (Parallel-Schiebe- Kippflügel)	
			Drill template Corner connection of sash (parallel sliding tilt sash)	
			1917116,1917117,1917118	

Artikel Article	VE PU	Anwendung Application	Bezeichnung / Hinweise Designation / Indications	Abbildung Figure
		Material / Material Farbe / Colour	Zuordnung Assignment	
5910055	1 St. 1 pcs	WICLINE 75	Bohrschablone Bearbeitung für Klapp-/Drehband 6950073 und 6950074	
			Drill template Processing for top-hung/turn hinge set 6950073 and 6950074	
		roh untreated	1917093,1917161,1917163	
5910061	1 St. 1 pcs	WICLINE 75	Bohrschablone Eckverbindung Flügel	
			Drill template Corner connection of sash	
			1017101,1017102,1017103,1017104,1017105 1910146,1910147,1917101,1917102,1917103 1917104,1917105,1917115	
5910071	1 St. 1 pcs	WICLINE 75	Bohrschablone Eckverbindung verdeckter Flügel	
			Drill template Corner connection of concealed sash	
			1017111,1017112,1017113,1917110,1917111 1917112,1917113	
5910079	1 St. 1 pcs	WICLINE 75	Bohrschablone für aufliegendes Schwing-Wende-Drehlager	
			Drill template for protruding pivot bearing of pivot window	
		roh untreated	1017004,1917004,1917163	
5910080	1 St. 1 pcs	WICLINE 75	Bohrschablone für verdecktes Schwing-Wende-Drehlager	
			Drill template for concealed pivot bearing of pivot window	
		roh untreated	1917163	







Artikel Article	VE PU	Anwendung Application	Bezeichnung / Hinweise Designation / Indications	Abbildung Figure
		Material / Material Farbe / Colour	Zuordnung Assignment	
5910081	1 St. 1 pcs	WICLINE 75	Bohrschablone für Befestigung Klemmprofil 4980067 Durchschusshemmung	
			Drill template for fixing clamping profile 4980067 Bullet-resistance	
5910101	1 St. 1 pcs	WICLINE 75	Bohrschablone Befestigung Laufwagen 6950180, 6950181, 6950182, 6950183 (Parallel-Schiebe-Kippflügel)! Für Laufwagen Set Typ 2 2x Schablone erforderlich (Schwalbenschwanzverbindung)	
			Drill template Attachement carriages 6950180, 6950181, 6950182, 6950183 (parallel sliding tilt sash). For carriage set type 2 two templates needed	
			1917116,1917117,1917118	
5910102	1 Paar 1 pair	WICLINE 75	Montagehilfe Befestigung Laufschiene aus Set 6950200 bis 6950205 (Parallel-Schiebe-Kippflügel)	
			Mounting aid Attachement running rail from set 6950200 to 6950205 (parallel sliding tilt sash)	
		Sonder- farbe	Special colour	
5910104	1 St. 1 pcs	WICLINE 75	Bohrschablone Einlassgetriebe (EG) 6950251, 6950252, 6950253, 6950254, Dornmaß 40, mit Zwangssteuerung (Parallel-Schiebe-Kippflügel)	
			Drill template Inlet gear 6950251, 6950252, 6950253, 6950254, backset dimension 40, with force control (parallel sliding tilt sash)	
			1917118	
5910105	1 St. 1 pcs	WICLINE 75	Montageschablone für Steuerklotz aus Set 6950200 bis 6950205 (Parallel-Schiebe-Kippflügel)	
			Mounting template for control part from set 6950200 to 6950205 (parallel sliding tilt sash)	

Artikel Article	VE PU	Anwendung Application	Bezeichnung / Hinweise Designation / Indications	Abbildung Figure
		Material / Material Farbe / Colour	Zuordnung Assignment	
5910107	1 St. 1 pcs	WICLINE 75	Bohrschablone Aufsatzgetriebe 6950192, 6950193, 6950194, 6950195 mit Zwangssteuerung. Halteschiene oben aus Set 6950200 bis 6950205. (Parallel-Schiebe-Kippflügel)	
			Drill template Top mounted surface gear 6950192, 6950193, 6950194, 6950195 with force control. Retaining rail on top from set 6950200 to 6950205. (parallel sliding tilt sash)	
			1917116,1917117,1917118	
5910109	1 St. 1 pcs	WICLINE 75	Bohrschablone Bohrung für verdeckte Entwässerung mit Entwässerungsschlauch 188413 und Entwässerungsteil 4940187 Hinweis: Gemeinsame Verwendung mit Wechselwerkzeug 5940075	
			Drill template Hole for concealed drainage with drainage tube 188413 and drainage part 4940187 Note: Combined usage with interchangeable tool 5940075	
			1017203,1017204,1017205,1017206,1017207 1017209,1910149,1917201,1917202,1917203 1917204,1917205,1917206,1917207,1917209	
5910110	1 St. 1 pcs	WICLINE 75	Bohrschablone für Schieberstangenbearbeitung	
			Drill template for machining of slide rods	
			3011021,3011022	

WICLINE 75



Stanzwerkzeuge
Punching tools

Werkzeuge
Tools

Artikel Article	VE PU	Anwendung Application	Bezeichnung / Hinweise Designation / Indications	Abbildung Figure
		Material / Material Farbe / Colour	Zuordnung Assignment	
5040000	1 St. 1 pcs	WICLINE 75	Multifunktionsstanzwerkzeug bestehend aus Pneumatikpresse und Werkzeugaufnahme	
			Multi-functional punching tool consisting of pneumatic press and tool carrier	
5040003	1 St. 1 pcs	WICLINE 75	Arbeitsstisch für Multifunktionsstanzwerkzeug	
			Work bench for multi-functional punching tool	
5040004	1 St. 1 pcs	WICLINE 75	Längenanschlag zum Anbau an das Multifunktionsstanzwerkzeug	
			Length limiter for fitting on multi-functional punching tool	
5040005	1 St. 1 pcs	WICLINE 75	Wartungseinheit für Multifunktionsstanze	
			Maintenance unit for multi-functional punching tool	
5040024	1 St. 1 pcs	WICLINE 75	Wechselwerkzeug für 5040000 Stanzung für Schieberstange	
			Interchangeable tool for 5040000 Punching for slide rod	
			3011022	
5040025	1 St. 1 pcs	WICLINE 75	Wechselwerkzeug für 5040000 Stanzung für Schieberstange	
			Interchangeable tool for 5040000 Punching for slide rod	
			3011021	

Artikel Article	VE PU	Anwendung Application	Bezeichnung / Hinweise Designation / Indications	Abbildung Figure
		Material / Material Farbe / Colour	Zuordnung Assignment	
5040026	1 St. 1 pcs	WICLINE 75	Wechselwerkzeug für 5040000 Öffnen Schieberstangenkanal	
			Interchangeable tool for 5040000 Open slide rod channel	
			1010453,1017101,1017102,1017103,1017104 1017105,1017111,1017112,1017113,1910146 1910147,1917101,1917102,1917103,1917104 1917105,1917110,1917111,1917112,1917113 1917115	
5040027	1 St. 1 pcs	WICLINE 75	Wechselwerkzeug für 5040000 Schieberstangenkanal öffnen bei Flügel	
			Interchangeable tool for 5040000 Open slide rod channel for sash	
			1917161,1917163	
5040410	1 St. 1 pcs	WICLINE 75	Erweiterungssatz für 5940008 Dampfdruckausgleich und Entwässerung Flügel	
			Extension set for 5940008 Vapour pressure equalization and drainage of sash	
			1010374	
5040415	1 St. 1 pcs	WICLINE 75	Wechselmatrize für Wechselwerkzeug 5940019 für 5040000 Stanzung für Standardgriff	
			Interchangeable matrix of interchangeable tool 5940019 for 5040000 Punching for standard handle	
			1010375,1010383	
5040416	1 St. 1 pcs	WICLINE 75	Wechselmatrize für Wechselwerkzeug 5940021 für 5040000 Stanzung für rosettenlosen Griff	
			Interchangeable matrix of interchangeable tool 5940021 for 5040000 Punching for handle without rosette	
			1010375,1010383	

Artikel Article	VE PU	Anwendung Application	Bezeichnung / Hinweise Designation / Indications	Abbildung Figure
		Material / Material Farbe / Colour	Zuordnung Assignment	
5040426	1 St. 1 pcs	WICLINE 75	Wechselmatrize für Wechselwerkzeug 5940023 für 5040000 Eckverbindung Flügel (Innenschale)	
			Interchangeable matrix of interchangeable tool 5940023 for 5040000 Corner connection of sash profiles (inner shell)	
			1017111	
5940001	1 St. 1 pcs	WICLINE 75	Wechselwerkzeug für 5040000 Eck- und Stoßverbindung Blendrahmen	
			Interchangeable tool for 5040000 Corner and butt-joint connection of frame profile	
			1010344,1010346,1010433,1010434,1010452 1010469,1010481,1010482,1010483,1010484 1010485,1010486,1010488,1010489,1010490 1010491,1010492,1010493,1010494,1010495 1017001,1017003,1017004,1017005,1017006 1017008,1017050,1017051,1017064,1017066 1017081,1017082,1017090,1017203,1017204 1017205,1017206,1017207,1017209,1017213 1017215,1017220,1017231,1910148,1910149 1910170,1910172,1917001,1917002,1917003 1917004,1917005,1917055,1917056,1917057 1917058,1917059,1917060,1917064,1917067 1917068,1917069,1917073,1917081,1917082 1917086,1917201,1917202,1917203,1917204 1917205,1917206,1917207,1917209,1917211 1917213,1917215,1917220,1917224,1917231 1917235,1917241,1917244,1917246,1917247 1917248,1917249,1917250,1917251,1917270 1917271,1917272,1917273,1917334	
5940005	1 St. 1 pcs	WICLINE 75	Wechselwerkzeug für 5040000 Stoßverbindung Sprosse Klassik-Design (Außenschale)	
			Interchangeable tool for 5040000 Butt-joint connection of Classic design glazing bar profiles (outer profile shell)	
			1917338,1917339	

Artikel Article	VE PU	Anwendung Application	Bezeichnung / Hinweise Designation / Indications	Abbildung Figure
		Material / Material Farbe / Colour	Zuordnung Assignment	
5940006	1 St. 1 pcs	WICLINE 75	Wechselwerkzeug für 5040000 Dampfdruckausgleich und Entwässerung Blendrahmen	
			Interchangeable tool for 5040000 Vapour pressure equalization and drainage of frame	
			1017001,1017003,1017004,1017005,1017006 1017008,1017062,1017064,1017066,1017077 1017081,1017082,1017090,1017203,1017204 1017205,1017206,1017207,1017209,1017213 1017215,1017220,1017231,1910148,1910149 1910170,1910172,1917001,1917002,1917003 1917004,1917005,1917062,1917064,1917067 1917068,1917069,1917073,1917076,1917077 1917081,1917082,1917086,1917089,1917201 1917202,1917203,1917204,1917205,1917206 1917207,1917209,1917211,1917213,1917215 1917220,1917224,1917231,1917235	
5940007	1 St. 1 pcs	WICLINE 75	Umrüstsatz für Wechselwerkzeug 5040017 für 5040000 Dampfdruckausgleich und Entwässerung Blendrahmen	
			Conversion set of interchangeable tool 5040017 for 5040000 Vapour pressure equalization and drainage of frame	
			1017001,1017003,1017004,1017005,1017006 1017008,1017062,1017064,1017066,1017077 1017081,1017082,1017090,1017203,1017204 1017205,1017206,1017207,1017209,1017213 1017215,1017220,1017231,1910148,1910149 1910170,1910172,1917001,1917002,1917003 1917004,1917005,1917062,1917064,1917067 1917068,1917069,1917073,1917076,1917077 1917081,1917082,1917086,1917089,1917201 1917202,1917203,1917204,1917205,1917206 1917207,1917209,1917211,1917213,1917215 1917220,1917224,1917231,1917235	

WICLINE 75

Stanzwerkzeuge
Punching tools



Werkzeuge
Tools



Artikel Article	VE PU	Anwendung Application	Bezeichnung / Hinweise Designation / Indications	Abbildung Figure
		Material / Material Farbe / Colour	Zuordnung Assignment	
5940008	1 St. 1 pcs	WICLINE 75	Wechselwerkzeug für 5040000 Dampfdruckausgleich und Entwässerung Flügel	
			Interchangeable tool for 5040000 Vapour pressure equalization and drainage of sash	
			1017101,1017102,1017103,1017104,1017105 1910146,1910147,1917101,1917102,1917103 1917104,1917115	
5940010	1 St. 1 pcs	WICLINE 75	Wechselwerkzeug für 5040000 Eckverbindung Einspannblendrahmen	
			Interchangeable tool for 5040000 Corner connection of clamping frame profile	
			1017077,1910134,1910135,1917076,1917077 1917089	
5940019	1 St. 1 pcs	WICLINE 75	Wechselwerkzeug für 5040000 Stanzung für Standardgriff	
			Interchangeable tool for 5040000 Punching for standard handle	
			1010453,1017101,1017102,1017103,1017104 1017105,1017111,1017112,1017113,1910146 1910147,1917101,1917102,1917103,1917104 1917105,1917110,1917111,1917112,1917113 1917115	
5940021	1 St. 1 pcs	WICLINE 75	Wechselwerkzeug für 5040000 Stanzung für rosettenlosen Griff	
			Interchangeable tool for 5040000 Punching for handle without rosette	
			1010453,1017101,1017102,1017103,1017104 1017105,1017111,1017112,1017113,1910146 1910147,1917101,1917102,1917103,1917104 1917105,1917110,1917111,1917112,1917113 1917115	
5940022	1 St. 1 pcs	WICLINE 75	Wechselwerkzeug für 5040000 Eckverbindung Flügel	
			Interchangeable tool for 5040000 Corner connection of sash profiles	
			1017101,1017102,1017103,1017104,1017105 1910146,1910147,1917101,1917102,1917103 1917104,1917105,1917115,1917116,1917117 1917118	



WICLINE 75

Stanzwerkzeuge
Punching tools

Werkzeuge
Tools

Artikel Article	VE PU	Anwendung Application	Bezeichnung / Hinweise Designation / Indications	Abbildung Figure
		Material / Material Farbe / Colour	Zuordnung Assignment	
5940023	1 St. 1 pcs	WICLINE 75	Wechselwerkzeug für 5040000 Eckverbindung verdeckter Flügel	
			Interchangeable tool for 5040000 Corner connection of concealed sash	
			1017111,1017112,1017113,1917110,1917111 1917112,1917113	
5940024	1 St. 1 pcs	WICLINE 75	Umrüstsatz für Wechselwerkzeug 5040020 für 5040000 Grifflochstanzung für Standardgriff WICSTAR Plus	
			Retooling set of interchangeable tool 5040020 for 5040000 Punched hole for standard WICSTAR Plus handle	
			1010453,1017101,1017102,1017103,1017104 1017105,1017111,1017112,1017113,1910146 1910147,1917101,1917102,1917103,1917104 1917105,1917110,1917111,1917112,1917113 1917115	
5940035	1 St. 1 pcs	WICLINE 75	Wechselwerkzeug für 5040000 Stanzung für verdeckte Entwässerung Blendrahmen	
			Interchangeable tool for 5040000 Punching for concealed drainage of frame profile	
			1010433,1010434,1010469,1010481,1010482 1010483,1010484,1010485,1010486,1010488 1010489,1010490,1010491,1010492,1010493 1010494,1010495,1017050,1017051	
5940038	1 St. 1 pcs	WICLINE 75	Wechselwerkzeug für 5040000 Stanzung für Schieberstange	
			Interchangeable tool for 5040000 Punching for slide rod	
			3011015	
5040036	1 St. 1 pcs	WICLINE 75	Zusatzanschlag für Wechselwerkzeug 5940038 zum Anlochen der Schieberstange 3011015	
			Additional stop for interchangeable tool 5940038 for punching slide rod 3011015	
			3011015	



Artikel Article	VE PU	Anwendung Application	Bezeichnung / Hinweise Designation / Indications	Abbildung Figure
		Material / Material Farbe / Colour	Zuordnung Assignment	
5940039	1 St. 1 pcs	WICLINE 75	Umrüstsatz für Wechselwerkzeug 5040023 für 5040000 Stanzung für Schieberstange 3011015	
			Conversion set of interchangeable tool 5040023 for 5040000 Punching for slide rod 3011015	
			3011015	
5940040	1 St. 1 pcs	WICLINE 75	Wechselwerkzeug für 5040000 Stanzung für verdeckte Entwässerung mit Entwässerungsschlauch 188413 und Entwässerungsteil 4940187, 4940493. Hinweis: Gemeinsame Verwendung mit 5940075	
			Interchangeable tool for 5040000 Punching for concealed drainage with drainage tube 188413 and drainage part 4940187, 4940493. Note: Combined usage with 5940075	
			1017203,1017204,1017205,1017206,1017207 1017209,1017231,1910149,1917201,1917202 1917203,1917204,1917205,1917206,1917207 1917209,1917231,1917235	
5940075	1 St. 1 pcs	WICLINE 75	Wechselwerkzeug für 5040000 Freistanzung an der Dichtungsaufnahmezone für verdeckte Entwässerung mit Entwässerungsschlauch 188413 und Entwässerungsteil 4940187, 4940493. Hinweis: Gemeinsame Verwendung mit 5940040	
			Interchangeable tool for 5040000 Punching in the gasket receiving groove zone for concealed drainage with drainage tube 188413 and drainage part 4940187, 4940493. Note: Combined usage with 5940040	
			1017203,1017204,1017205,1017206,1017207 1017209,1017231,1910149,1917201,1917202 1917203,1917204,1917205,1917206,1917207 1917209,1917231,1917235	

Artikel Article	VE PU	Anwendung Application	Bezeichnung / Hinweise Designation / Indications	Abbildung Figure
		Material / Material Farbe / Colour	Zuordnung Assignment	
5040090	1 St. 1 pcs	WICLINE 75	Handstanzwerkzeug für Entwässerung für Blendrahmen- & Kämpferprofile	
			Hand punching tool for drainage for frame and transom profiles	
			1017001,1017003,1017004,1017005,1017006 1017008,1017062,1017064,1017066,1017077 1017081,1017082,1017090,1017203,1017204 1017205,1017206,1017207,1017209,1017213 1017215,1017220,1017231,1910148,1910149 1910170,1910172,1917001,1917002,1917003 1917004,1917005,1917062,1917064,1917067 1917068,1917069,1917073,1917076,1917077 1917081,1917082,1917086,1917089,1917201 1917202,1917203,1917204,1917205,1917206 1917207,1917209,1917211,1917213,1917215 1917220,1917224,1917231,1917235,1917241 1917256,1917301,1917331	
5040101	1 St. 1 pcs	WICLINE 75	Handstanzengrundkörper zur Bestückung mit Wechselwerkzeugen Pneumatische Handstanze für Wechselwerkzeuge	
			Hand punching tool For interchangeable tools	



WICLINE 75

Stanzwerkzeuge
Punching tools

Werkzeuge
Tools

Artikel Article	VE PU	Anwendung Application	Bezeichnung / Hinweise Designation / Indications	Abbildung Figure
		Material / Material Farbe / Colour	Zuordnung Assignment	
5940101	1 St. 1 pcs	WICLINE 75	Wechselwerkzeug für 5040101 Eck- und Stoßverbindung Blendrahmen	
			Interchangeable tool for 5040101 Frame and transom connection	
			1010344,1010346,1010433,1010434,1010452 1010481,1010483,1010485,1010488,1010491 1010493,1010495,1017001,1017003,1017004 1017005,1017006,1017008,1017050,1017051 1017064,1017066,1017077,1017081,1017082 1017090,1017203,1017204,1017205,1017206 1017207,1017209,1017213,1017215,1017220 1017231,1310991,1910134,1910135,1910148 1910149,1910170,1910172,1917001,1917002 1917003,1917004,1917005,1917009,1917055 1917056,1917057,1917058,1917059,1917060 1917064,1917067,1917068,1917069,1917073 1917076,1917077,1917081,1917082,1917086 1917089,1917201,1917202,1917203,1917204 1917205,1917206,1917207,1917209,1917211 1917213,1917215,1917220,1917224,1917231 1917235,1917241,1917244,1917246,1917247 1917248,1917249,1917250,1917251,1917270 1917271,1917272,1917273,1917301,1917303 1917331,1917334	
5940104	1 St. 1 pcs	WICLINE 75	Wechselwerkzeug für 5040101 Eckverbindung Flügel	
			Interchangable tool for 5040101 Corner connection of sash	
			1917161,1917163	

Artikel Article	VE PU	Anwendung Application	Bezeichnung / Hinweise Designation / Indications	Abbildung Figure
		Material / Material Farbe / Colour	Zuordnung Assignment	
5940105	1 St. 1 pcs	WICLINE 75	Wechselwerkzeug für 5040101 Stegausklinkung am Dämmsteg für Glasfalzbelüftung	
			Interchangeable tool for 5040101 Notching web of insulation strip for glazing rebate ventilation	
			1010344,1010346,1017001,1017003,1017004 1017005,1017006,1017008,1017062,1017064 1017066,1017077,1017081,1017082,1017090 1017203,1017204,1017205,1017206,1017207 1017209,1017213,1017215,1017220,1017231 1910148,1910149,1910170,1910172,1917001 1917002,1917003,1917004,1917005,1917062 1917064,1917067,1917068,1917069,1917073 1917076,1917077,1917081,1917082,1917086 1917089,1917201,1917202,1917203,1917204 1917205,1917206,1917207,1917209,1917211 1917213,1917215,1917220,1917224,1917231 1917235	
5940107	1 St. 1 pcs	WICLINE 75	Wechselwerkzeug für 5040101 inkl. 2x Adapter Eckverbindung Einspannblendrahmen ohne Adapter: Außenschale Adapter 13,3 mm: Innenschale Adapter 17,3 mm: Innenschale Einspannblendrahmen für Senk-Klapp-Flügel	
			Interchangeable tool for 5040101 incl. 2x adapter Corner connection of clamping frame without adapter: outer profile shell adapter 13,3 mm: inner profile shell adapter 17,3 mm: inner profile shell clamping frame for top hung sash	
			1017077,1910134,1910135,1917076,1917077 1917089,1917092	
5940110	1 St. 1 pcs	WICLINE 75	Wechselwerkzeug für 5040101 Eckverbindung verdeckter Flügel (Außenschale) und verdeckter Stulpflügel (Außenschale)	
			Interchangeable tool for 5040101 Corner connection of concealed sash (outer profile shell) and double casement concealed sash profile (outer profile shell)	
			1017111,1017112,1017113,1017124,1017125 1017126,1917110,1917111,1917112,1917113 1917124,1917126	

Artikel Article	VE PU	Anwendung Application	Bezeichnung / Hinweise Designation / Indications	Abbildung Figure
		Material / Material Farbe / Colour	Zuordnung Assignment	
5940116	1 St. 1 pcs	WICLINE 75	Wechselwerkzeug für 5040101 Eckverbindung Flügel (Außen-/Innenschale) und verdeckter Flügel (Innenschale)	
			Interchangeable tool for 5040101 Corner connection of sash (outer/inner profile shell) and concealed sash (inner profile shell)	
			1017102,1017103,1017104,1017105,1017111 1017112,1017113,1910146,1910147,1917102 1917103,1917104,1917110,1917111,1917112 1917113,1917115,1917116,1917117,1917118 1917163	
5940117	1 St. 1 pcs	WICLINE 75	Wechselwerkzeug für 5040101 Eckverbindung Stulpflügelprofil (Innenschale) und verdeckter Stulpflügel (Innenschale), Ø 4 mm	
			Interchangeable tool for 5040101 Corner connection of double casement sash profile (inner profile shell) and double casement concealed sash profile (inner profile shell), Ø 4 mm	
			1017120,1917120,1917122,1917124,1917126	
5940118	1 St. 1 pcs	WICLINE 75	Wechselwerkzeug für 5040101 Eckverbindung Flügel (Außen-/Innenschale) und Stulpflügelprofil (Außenschale)	
			Interchangeable tool for 5040101 Corner connection of sash (outer/inner profile shell) and double casement sash profile (outer profile shell)	
			1010453,1017101,1017120,1917101,1917105 1917120,1917122,1917161	
5040124	1 St. 1 pcs	WICLINE 75	Wechselwerkzeug für 5040101 Eckverbindung Flügel (Außenschale)	
			Interchangeable tool for 5040101 Corner connection of sash (outer profile shell)	
			1010453	



Artikel Article	VE PU	Anwendung Application	Bezeichnung / Hinweise Designation / Indications	Abbildung Figure
		Material / Material Farbe / Colour	Zuordnung Assignment	
5040132	1 St. 1 pcs	WICLINE 75	Wechselwerkzeug für 5040101 Eckverbindung verdeckter Stulpflügel (Innenschale), Ø 4 mm	
			Interchangeable tool for 5040101 Corner connection of double casement concealed sash profile (inner profile shell), Ø 4 mm	
			1017124,1017125,1017126	
5940051	1 St. 1 pcs	WICLINE 75	Einzelstanzwerkzeug Eck- und Stoßverbindung Blendrahmen	
			Single punching tool Corner and butt-joint connection of frame	
			1010344,1010346,1010433,1010434,1010452 1010481,1010483,1010485,1010488,1010491 1010493,1010495,1017001,1017003,1017004 1017005,1017006,1017008,1017050,1017051 1017062,1017064,1017066,1017081,1017082 1017090,1017203,1017204,1017205,1017206 1017207,1017209,1017213,1017215,1017220 1017231,1910148,1910149,1910170,1910172 1917001,1917002,1917003,1917004,1917005 1917055,1917056,1917057,1917058,1917059 1917060,1917062,1917064,1917067,1917068 1917069,1917073,1917081,1917082,1917086 1917201,1917202,1917203,1917204,1917205 1917206,1917207,1917209,1917211,1917213 1917215,1917220,1917224,1917231,1917235 1917241,1917244,1917246,1917247,1917248 1917249,1917250,1917251,1917256,1917258 1917259,1917260,1917270,1917271,1917272 1917273,1917334	
5940055	1 St. 1 pcs	WICLINE 75	Wechseleinsatz für 5940061 Stanzung für Standardgriff	
			Interchangeable set for 5940061 Punching for standard handle	
			1010453,1017101,1017102,1017103,1017104 1017105,1017111,1017112,1017113,1910146 1910147,1917101,1917102,1917103,1917104 1917105,1917110,1917111,1917112,1917113 1917115	

WICLINE 75

Stanzwerkzeuge
Punching tools

Werkzeuge
Tools

Artikel Article	VE PU	Anwendung Application	Bezeichnung / Hinweise Designation / Indications	Abbildung Figure
		Material / Material Farbe / Colour	Zuordnung Assignment	
5940057	1 St. 1 pcs	WICLINE 75	Wechseleinsatz für 5940061 Stanzung für rosettenlosen Griff	
			Interchangeable set for 5940061 Punching for handle without rosette	
			1010453,1017101,1017102,1017103,1017104 1017105,1017111,1017112,1017113,1910146 1910147,1917101,1917102,1917103,1917104 1917105,1917110,1917111,1917112,1917113 1917115	
5940058	1 St. 1 pcs	WICLINE 75	Einzelstanzwerkzeug Eckverbindung Flügel	
			Single punching tool Corner connection of sash	
			1017101,1017102,1017103,1017104,1017105 1910146,1910147,1917101,1917102,1917103 1917104,1917105,1917115,1917116,1917117 1917118	
5940059	1 St. 1 pcs	WICLINE 75	Einzelstanzwerkzeug Eckverbindung verdeckter Flügel	
			Single punching tool Corner connection of concealed sash	
			1017112,1017113,1917110,1917111,1917112 1917113	
5940060	1 St. 1 pcs	WICLINE 75	Einzelstanzwerkzeug Eckverbindung Einspannblendrahmen	
			Single punching tool Corner connection of clamping frame profile	
			1917076,1917077,1917089	
5940061	1 St. 1 pcs	WICLINE 75	Einzelstanzwerkzeug Basiswerkzeug für Wechseleinsätze 5940055 und 5940057, öffnen Schieberstangenkanal	
			Single punching tool Basic tool for interchangeable sets 5940055 and 5940057, open slide rod channel	
			1010453,1017101,1017102,1017103,1017104 1017105,1017111,1017112,1017113,1910146 1910147,1917101,1917102,1917103,1917104 1917105,1917110,1917111,1917112,1917113 1917115	

Artikel Article	VE PU	Anwendung Application	Bezeichnung / Hinweise Designation / Indications	Abbildung Figure
		Material / Material Farbe / Colour	Zuordnung Assignment	
5940062	1 St. 1 pcs	WICLINE 75	Umrüstsatz für Einzelstanzwerkzeug 5040052 Dampfdruckausgleich und Entwässerung Blendrahmen	
			Conversion set for single punching tool 5040052 Vapour pressure equalization and drainage of frame	
			1017001,1017003,1017004,1017005,1017006 1017008,1017062,1017064,1017066,1017077 1017081,1017082,1017090,1017203,1017204 1017205,1017206,1017207,1017209,1017213 1017215,1017220,1017231,1910148,1910149 1910170,1910172,1917001,1917002,1917003 1917004,1917005,1917062,1917064,1917067 1917068,1917069,1917073,1917076,1917077 1917081,1917082,1917086,1917089,1917201 1917202,1917203,1917204,1917205,1917206 1917207,1917209,1917211,1917213,1917215 1917220,1917224,1917231,1917235	
5940065	1 St. 1 pcs	WICLINE 75	Umrüstsatz für Einzelstanzwerkzeug 5040053 Dampfdruckausgleich und Entwässerung Flügel	
			Conversion set for single punching tool 5040053 Vapour pressure equalization and drainage of sash	
			1017101,1017102,1017103,1017104,1017105 1910146,1910147,1917101,1917102,1917103 1917104,1917105,1917115	
5940067	1 St. 1 pcs	WICLINE 75	Einzelstanzwerkzeug Stanzung für Schieberstange 3011015	
			Single punching tool Punching for slide rod 3011015	
			3011015	

Artikel Article	VE PU	Anwendung Application	Bezeichnung / Hinweise Designation / Indications	Abbildung Figure
		Material / Material Farbe / Colour	Zuordnung Assignment	
5940068	1 St. 1 pcs	WICLINE 75	Umrüstsatz für Einzelstanzwerkzeug 5040057 Stanzung für Schieberstange 3011015	
			Conversion set of single punching tool 5040057 Punching for slide rod 3011015	
			3011015	
5940069	1 St. 1 pcs	WICLINE 75	Einzelstanzwerkzeug Dampfdruckausgleich und Entwässerung Blendrahmen	
			Single punching tool Vapour pressure equalization and drainage of frame	
			1017001,1017003,1017004,1017005,1017006 1017008,1017062,1017064,1017066,1017077 1017081,1017082,1017090,1017203,1017204 1017205,1017206,1017207,1017209,1017213 1017215,1017220,1017231,1910148,1910149 1910170,1910172,1917001,1917002,1917003 1917004,1917005,1917062,1917064,1917067 1917068,1917069,1917073,1917076,1917077 1917081,1917082,1917086,1917089,1917201 1917202,1917203,1917204,1917205,1917206 1917207,1917209,1917211,1917213,1917215 1917220,1917224,1917231,1917235	
5940070	1 St. 1 pcs	WICLINE 75	Einzelstanzwerkzeug Dampfdruckausgleich und Entwässerung Flügel	
			Single punching tool Vapour pressure equalization and drainage of sash	
			1017101,1017102,1017103,1017104,1017105 1910146,1910147,1917101,1917102,1917103 1917104,1917105,1917115	
5040150	1 St. 1 pcs	WICLINE 75	Dichtungsstanze pneumatisch zum Ablängen von Dichtungsprofilen	
			Pneumatic gasket punch for cutting gasket profiles to length	

Artikel Article	VE PU	Anwendung Application	Bezeichnung / Hinweise Designation / Indications	Abbildung Figure
		Material / Material Farbe / Colour	Zuordnung Assignment	
5040151	1 St. 1 pcs	WICLINE 75	Arbeitstisch für Dichtungsstanze 5040150	
			Work bench for gasket punch 5040150	
5040152	1 St. 1 pcs	WICLINE 75	Längenanschlag für Dichtungsstanze 5040150	
			Length limiter for gasket punch 5040150	
5040154	1 St. 1 pcs	WICLINE 75	Handstanzwerkzeug zur Stegausklinkung 10 mm Für Dampfdruckausgleich und Entwässerung.	
			Hand punching tool for 10 mm web notching For air pressure equalization and drainage.	
5040166	1 St. 1 pcs	WICLINE 75	Ersatz-Schneidplatte für 90°-Schnitt für Dichtungsstanze 5040150	
			Replacement cutting plate for 90° cut for gasket punch 5040150	

WICLINE 75

Werkzeuge
Tools

Presstwerkzeuge
Crimping tools

Artikel Article	VE PU	Anwendung Application	Bezeichnung / Hinweise Designation / Indications	Abbildung Figure
		Material / Material Farbe / Colour	Zuordnung Assignment	
5030076	1 Paar 1 pair	WICLINE 75	Presstwerkzeug-Satz	
		Stahl Steel	Crimping tool set	
			1017090	
5930003	1 Paar 1 pair	WICLINE 75	Presstwerkzeug-Satz	
		Stahl Steel	Crimping tool set	
			1010344,1010346,1010434,1010452,1010488 1010491,1010493,1010495,1017001,1017003 1017004,1017005,1017006,1017050,1017051 1017062,1017064,1017066,1017081,1017082 1017203,1017204,1017205,1017206,1017207 1017231,1910148,1910149,1910170,1917001 1917002,1917003,1917004,1917005,1917055 1917056,1917057,1917058,1917059,1917060 1917062,1917064,1917067,1917068,1917069 1917073,1917081,1917082,1917086,1917201 1917202,1917203,1917204,1917205,1917206 1917207,1917231,1917235,1917241,1917244 1917246,1917247,1917248,1917249,1917250 1917251,1917256,1917258,1917259,1917260 1917301,1917303,1917334	
5930005	1 Paar 1 pair	WICLINE 75	Presstwerkzeug-Satz	
		Stahl Steel	Crimping tool set	
			1917009,1917331	
5930009	1 Paar 1 pair	WICLINE 75	Presstwerkzeug-Satz	
		Stahl Steel	Crimping tool set	
			1917089	

WICLINE 75

Werkzeuge
Tools

Presstwerkzeuge
Crimping tools

Artikel Article	VE PU	Anwendung Application	Bezeichnung / Hinweise Designation / Indications	Abbildung Figure
		Material / Material Farbe / Colour	Zuordnung Assignment	
5930010	1 Paar 1 pair	WICLINE 75	Presstwerkzeug-Satz	
		Stahl Steel	Crimping tool set	
			1017077,1910134,1910135,1917076,1917077	
5930019	1 Paar 1 pair	WICLINE 75	Presstwerkzeug-Satz	
		Stahl Steel	Crimping tool set	
			1010453,1017101,1017102,1017103,1017104 1017105,1910146,1910147,1917101,1917102 1917103,1917104,1917105,1917115,1917116 1917117,1917118	
5930020	1 Paar 1 pair	WICLINE 75	Presstwerkzeug-Satz	
		Stahl Steel	Crimping tool set	
			1017120,1917120,1917122	
5930025	1 Paar 1 pair	WICLINE 75	Presstwerkzeug-Satz	
			Crimping tool set	
			3910040	
5930026	1 Paar 1 pair	WICLINE 75	Presstwerkzeug-Satz	
			Crimping tool set	
			1917092	

WICLINE 75

Werkzeuge
Tools

Presstawerkzeuge
Crimping tools

Artikel Article	VE PU	Anwendung Application	Bezeichnung / Hinweise Designation / Indications	Abbildung Figure
		Material / Material Farbe / Colour	Zuordnung Assignment	
5930027	1 Paar 1 pair	WICLINE 75	Presstawerkzeug-Satz	
			Crimping tool set	
			1917093	
5930028	1 Paar 1 pair	WICLINE 75	Presstawerkzeug-Satz	
			Crimping tool set	
			1917161,1917163	
5930029	1 Paar 1 pair	WICLINE 75	Presstawerkzeug-Satz	
			Crimping tool set	
			1917165,1917166	
5030100	1 Paar 1 pair	WICLINE 75	Messeradapter für Pressta Eisele PV10	
		Stahl Steel	Knife adaptor for Eisele PV10 crimping tool	
5030101	1 Paar 1 pair	WICLINE 75	Messeradapter für Elumatec EP124	
		Stahl Steel	Knife adaptor for Elumatec EP124	
5030102	1 Paar 1 pair	WICLINE 75	Messeradapter für Loth Uniprä 250	
		Stahl Steel	Knife adaptor for Loth Uniprä 250	

WICLINE 75

Werkzeuge
Tools

Presstawerkzeuge
Crimping tools

Artikel Article	VE PU	Anwendung Application	Bezeichnung / Hinweise Designation / Indications	Abbildung Figure
		Material / Material Farbe / Colour	Zuordnung Assignment	
5030103	1 Paar 1 pair	WICLINE 75	Messeradapter für Rapid HP205 / HP208	
		Stahl Steel	Knife adaptor for Rapid HP 205 / HP 208	

WICLINE 75

Werkzeuge
Tools

Verschiedenes
Miscellaneous

Artikel Article	VE PU	Anwendung Application	Bezeichnung / Hinweise Designation / Indications	Abbildung Figure
		Material / Material Farbe / Colour	Zuordnung Assignment	
5060001	1 St. 1 pcs	WICLINE 75	Tiefenanschlag für Bohrer Ø8 mm	
			Bit stop for Ø8 mm drill	
5060396	1 St. 1 pcs	WICLINE 75	Tiefenanschlag für Bohrer Ø 10 mm für Bohrschablone 5010611, 5910025.	
			Bit stop for Ø 10 mm drill for drill template 5010611, 5910025.	
5060397	1 St. 1 pcs	WICLINE 75	Tiefenanschlag für Bohrer Ø 14 mm für Bohrschablone 5010611, 5910025.	
			Bit stop for Ø 14 mm drill for drill template 5010611, 5910025.	
5060002	1 St. 1 pcs	WICLINE 75	Kegelsenker 80° Ø8 mm	
			Countersink 80°, Ø8 mm	
5060003	1 St. 1 pcs	WICLINE 75	Kegelsenker 80° Ø10 mm	
			Countersink 80°, Ø10 mm	
5060004	1 St. 1 pcs	WICLINE 75	Kegelsenker 80° Ø13.4 mm	
			Countersink 80°, Ø13.4 mm	

Verschiedenes
Miscellaneous

Artikel Article	VE PU	Anwendung Application	Bezeichnung / Hinweise Designation / Indications	Abbildung Figure
		Material / Material Farbe / Colour	Zuordnung Assignment	
5060005	1 St. 1 pcs	WICLINE 75	Stufenbohrer Ø14 mm / Ø6 mm für Bohrschablone 5910025	
			Step drill Ø14 mm / Ø6 mm for drill template 5910025	
5960021	1 St. 1 pcs	WICLINE 75	Stufenbohrer Ø 10,1 mm / Ø 3,9 mm mit Anschlagring Ersatzwerkzeug zur Verwendung mit Bohrschablone 5910053	
			Step drill Ø 10,1 mm / Ø 3,9 mm with stop ring Spare tool for use with drill template 5910053	
			1917161,1917163	
5960016	1 St. 1 pcs	WICLINE 75	Dichtungsbohrer Ø 6 x 65 mm, zum Herstellen von Entwässerungsbohrungen in Dichtung 4910068	
			Gasket drill Ø 6 x 65 mm, to manufacture drainage holes in gasket 4910068	
			4910068	
5060012	1 St. 1 pcs	WICLINE 75	Bithalter Längsgriff mit Bitverriegelung	
			Bit holder with longitudinal handle with bit lock	
5060013	5 St. 5 pcs	WICLINE 75	Schraubenbit T8 Länge 70 mm	
			Screwdriver bit T8 Length 70 mm	

WICLINE 75

Werkzeuge
Tools





Verschiedenes
Miscellaneous

Artikel Article	VE PU	Anwendung Application	Bezeichnung / Hinweise Designation / Indications	Abbildung Figure
		Material / Material Farbe / Colour	Zuordnung Assignment	
5060014	5 St. 5 pcs	WICLINE 75	Schraubenbit T10 Länge 70 mm	
			Screwdriver bit T10 Length 70 mm	
5060015	5 St. 5 pcs	WICLINE 75	Schraubenbit T15 Länge 70 mm	
			Screwdriver bit T15 Length 70 mm	
5960012	5 St. 5 pcs	WICLINE 75	Schraubenbit T15 Länge 50 mm, mit Haltefunktion	
			Screwdriver bit T15 Length 50 mm, with retaining function	
5060016	5 St. 5 pcs	WICLINE 75	Schraubenbit T20 Länge 70 mm	
			Screwdriver bit T20 Length 70 mm	
5960013	5 St. 5 pcs	WICLINE 75	Schraubenbit T20 Länge 50 mm, mit Haltefunktion	
			Screwdriver bit T20 Length 50 mm, with retaining function	
5060017	5 St. 5 pcs	WICLINE 75	Schraubenbit T25 Länge 70 mm	
			Screwdriver bit T25 Length 70 mm	





Verschiedenes
Miscellaneous

Artikel Article	VE PU	Anwendung Application	Bezeichnung / Hinweise Designation / Indications	Abbildung Figure
		Material / Material Farbe / Colour	Zuordnung Assignment	
5060369	5 St. 5 pcs	WICLINE 75	Schraubenbit T25 Länge 50 mm, mit Haltefunktion	
			Screwdriver bit T25 Length 50 mm, with retaining function	
5060020	1 St. 1 pcs	WICLINE 75	Formfräser rechtsschneidend Außen Ø: 200 mm, Bohrung Ø: 40 mm, Zähnezahl: 12, Winkel: 60°	
			Form cutter, right hand cutting Outer Ø: 200 mm, inner Ø: 40 mm, no. of tooth: 12, angle: 60°	
			1917009,1917334,1917338,1917339	
5060021	1 St. 1 pcs	WICLINE 75	Formfräser linksschneidend Außen Ø: 200 mm, Bohrung Ø: 40 mm, Zähnezahl: 12, Winkel: 60°	
			Form cutter, left hand cutting Outer Ø: 200 mm, inner Ø: 40 mm, no. of tooth: 12, angle: 60°	
			1917009,1917334,1917338,1917339	
5060024	1 St. 1 pcs	WICLINE 75	Diamant-Sägeblatt zur Verarbeitung unserer Systemprofile aus Aluminium hohe Standzeit	
			Diamond saw blade for processing our system profiles made of aluminium, high operating life.	
5060025	1 St. 1 pcs	WICLINE 75	Diamant-Fräser Ø 10 mm x 100 mm, nutzbare Schneide 20 mm, zur Verarbeitung unserer Systemprofile aus Aluminium, hohe Standzeit	
			Diamond milling cutter Ø10 mm x 100 mm, usable cutting edge 20 mm, for processing our system profiles made of aluminium, high operating life	

Verschiedenes
Miscellaneous

Artikel Article	VE PU	Anwendung Application	Bezeichnung / Hinweise Designation / Indications	Abbildung Figure
		Material / Material Farbe / Colour	Zuordnung Assignment	
5960007	1 St. 1 pcs	WICLINE 75	Torx Schraubendreher T10 auf Längsgriff	
			Torx screw driver T10 with longitudinal handle	
5060031	1 St. 1 pcs	WICLINE 75	Torx Schraubendreher T25 auf Längsgriff	
			Torx screwdriver T25 with longitudinal handle	
5060032	1 St. 1 pcs	WICLINE 75	Torx Schraubendreher T25 auf Quergriff	
			Torx screwdriver T25 with cross handle	
5060051	1 St. 1 pcs	WICLINE 75	Profi-Drucklufthammer inkl. Setzdorn Eck- und Stoßverbindung	
			Professional pneumatic hammer including set mandrel for corner and butt-joint connections	
5060053	1 St. 1 pcs	WICLINE 75	Setzdorn für Hülse Ø6 mm auf Profi Drucklufthammer 5060051 Eck- und Stoßverbindung	
			Set mandrel mounted on professional pneumatic hammer 5060051 for Ø6 mm drive bush for corner and butt-joint connection	

Verschiedenes
Miscellaneous

Artikel Article	VE PU	Anwendung Application	Bezeichnung / Hinweise Designation / Indications	Abbildung Figure
		Material / Material Farbe / Colour	Zuordnung Assignment	
5060055	1 St. 1 pcs	WICLINE 75	Setzdorn für Hülse Ø6 mm manuell Eck- und Stoßverbindung	
			Set mandrel for Ø6 mm drive bush, manual for corner and butt-joint connection	
5060056	1 St. 1 pcs	WICLINE 75	Setzdorn für Ø4 mm Stift 4070004 manuell zum Setzen der Ø4 mm Schlaghülsen	
			Set mandrel for Ø4 mm pin 4070004, manual for setting Ø4 mm bushes	
5060060	1 St. 1 pcs	WICLINE 75	Roller mit Kunststoffwanne für Kleberauftrag auf Schnittfläche Eck- und Stoßverbindung	
			Roller with plastic tray for application of adhesive on cut surfaces of profiles for corner and butt-joint connections	
5060061	1 St. 1 pcs	WICLINE 75	Ersatzrolle für Roller 5060060	
			Replacement roller for roller 5060060	
5060422	1 St. 1 pcs	WICLINE 75	Schnittkanten-Abdichtungsmaschine zur Anwendung von WICPRO-Tector zum Abdichten von Profil-Schnittflächen. Ersatzfolie 5070229.	
			Cut surfaces sealing machine for application of WICPRO-Tector for sealing profile cut surfaces. Replacement foil 5070229.	

Verschiedenes
Miscellaneous

Artikel Article	VE PU	Anwendung Application	Bezeichnung / Hinweise Designation / Indications	Abbildung Figure
		Material / Material Farbe / Colour	Zuordnung Assignment	
5060424	1 Garn. 1 set	WICLINE 75	Kartuschenpresse, akkubetrieben 10,8 V / 1,5 Ah für 2K Klebstoff 2 x 310 ml, Eck- und Stoßverbindung	
			Cartridges press, rech. battery-powered 10,8 V / 1,5 Ah for 2C adhesive 2 x 310 ml, angle and butt joints	
5060425	1 St. 1 pcs	WICLINE 75	Ersatzakku 10,8 V / 1,5 Ah Li-Ion für Injektionspistole akkubetrieben	
			Replacement accu 10,8 V / 1,5 Ah Li-Ion for injection gun battery powered	
5060426	1 St. 1 pcs	WICLINE 75	Kartuschenpresse, manuell für 2K Klebstoff 2 x 310 ml, Eck- und Stoßverbindung	
			Cartridges press, manual for 2C adhesive 2 x 310 ml, angle and butt joints	
5060070	1 St. 1 pcs	WICLINE 75	Injektionspistole manuell Eck- und Stoßverbindung	
			Injection pistol, manual Corner and butt-joint connections	
5060071	1 St. 1 pcs	WICLINE 75	Injektionspistole pneumatisch Eck- und Stoßverbindung	
			Injection pistol, pneumatic Corner and butt-joint connections	
5060073	1 St. 1 pcs	WICLINE 75	Klebstoffportioniergerät	
			Adhesive portioning apparatus	

WICLINE 75

Werkzeuge
Tools







Verschiedenes
Miscellaneous

Artikel Article	VE PU	Anwendung Application	Bezeichnung / Hinweise Designation / Indications	Abbildung Figure
		Material / Material Farbe / Colour	Zuordnung Assignment	
5060075	1 St. 1 pcs	WICLINE 75	Reinigungsmittelspender als Sparanfeuchter	
			Cleaner-dispenser as economy dampener	
5060076	1 St. 1 pcs	WICLINE 75	Sprühdose pneumatisch	
			Spray can, pneumatic	
5060077	1 St. 1 pcs	WICLINE 75	Druckluft-Tankstelle für Sprühdose	
			Compressed air filling station for spray can	
5960006	1 St. 1 pcs	WICLINE 75	Dichtungseinrollwerkzeug für Mitteldichtung	
			Gasket rolling tool for centre gasket	
			4910016	
5960009	1 St. 1 pcs	WICLINE 75	Montagehilfe für Entwässerungsschlauch 188413	
			Assembly auxiliary for drainage tube 188413	
5060080	1 St. 1 pcs	WICLINE 75	Dichtungsschere	
			Gasket shear	
			4910016	

WICLINE 75

Werkzeuge
Tools

Verschiedenes
Miscellaneous

Artikel Article	VE PU	Anwendung Application	Bezeichnung / Hinweise Designation / Indications	Abbildung Figure
		Material / Material Farbe / Colour	Zuordnung Assignment	
5060089	1 St. 1 pcs	WICLINE 75	Ersatzklingen für Dichtungsschere 5060080	
			Replacement blades for gasket shear 5060080	
5060418	1 St. 1 pcs	WICLINE 75	Schnittmatrize für Dämmprofil	
		Al	Cutting die for thermal break profile	
			4090152	
5060101	1 St. 1 pcs	WICLINE 75	Abspulbock für Dichtungsprofile auf Mehrwegspule	
			Gasket reel support rack for gasket profiles on reusable reels	
5060102	1 St. 1 pcs	WICLINE 75	Abroller für Dichtungsprofile auf Mehrwegspule	
			Portable reel holder for gasket profiles on reusable reels,	
5060103	1 St. 1 pcs	WICLINE 75	Beschlagsmontagewagen klein	
			Trolley for installation of fittings, small	
5060104	1 St. 1 pcs	WICLINE 75	Beschlagsmontagewagen groß	
			Trolley for installation of fittings, large	





Verschiedenes
Miscellaneous

Artikel Article	VE PU	Anwendung Application	Bezeichnung / Hinweise Designation / Indications	Abbildung Figure
		Material / Material Farbe / Colour	Zuordnung Assignment	
5060105	1 St. 1 pcs	WICLINE 75	Arbeitstisch	
			Work-bench	
5060107	1 St. 1 pcs	WICLINE 75	Folienabroller für Folienarbeiten bis 150 mm Selbstzuschnitt aus Rolle 5070043	
			Foil dispenser for foil works up to 150 mm width, cut to size from the roll 5070043	
5060378	1 St. 1 pcs	WICLINE 75	Bohrschablone für Falzlüfter 6060328 und Drehverschluss 6060329	
			Drill template for window ventilator 6060328 and turn lock 6060329	
5960014	1 St. 1 pcs	WICLINE 75	Handnietzange zum Einsetzen von Griff-Befestigung 6950153 bei von außen verglasten Flügeln	
			Rivet pliers to set in of handle fixation 6950153 for sashes outward glazed	
			1917161	
5960024	1 St. 1 pcs	WICLINE 75	Mundstück M5 für aufliegendes Schwing-Wende-Drehlager	
			Mouth piece M5 for protruding pivot bearing of pivot window	

Verschiedenes
Miscellaneous

Artikel Article	VE PU	Anwendung Application	Bezeichnung / Hinweise Designation / Indications	Abbildung Figure
		Material / Material Farbe / Colour	Zuordnung Assignment	
5960025	1 St. 1 pcs	WICLINE 75	Mundstück M6 für verdecktes Schwing-Wende-Drehlager	
			Mouth piece M6 for concealed pivot bearing of pivot window	
5960018	1 St. 1 pcs	WICLINE 75	Montagehilfe für BAP-System 75 Blendrahmen Bautiefe 75 mm	
			Assembly help for BAP system 75 Frame construction depth 75 mm	
5960019	1 St. 1 pcs	WICLINE 75	Klinkmesser für BAP-System Zur Eckausbildung bei Montage BAP-System	
			Notching cutter for BAP system Corner formation for assembly BAP system	
5960020	1 St. 1 pcs	WICLINE 75	Ziehgriff um Achslagerstift einzuschieben bzw. herauszuziehen (Beschlagsmontage- / demontage)	
			Pull handle to push in, resp. remove the stay bearing pin (fitting mounting / demounting)	



Artikel Article	VE PU	Anwendung Application	Bezeichnung / Hinweise Designation / Indications	Abbildung Figure
		Material / Material Farbe / Colour	Zuordnung Assignment	
5070000	1 Set 1 set	WICLINE 75	2-Komponenten Polyurethan-Klebstoff in Tandemkartusche 1 Set = 6 Stück inkl. 8 Statikmischer zum Verkleben von Al-Profilen	
			2-component Polyurethane adhesive <i>in tandem cartridge 1 set = 6 pieces including 8 mixing nozzle to glue aluminium profiles</i>	
5970002	1 Set 1 set	WICLINE 75	2-Komponenten Polyurethan-Klebstoff, schwarz in Tandemkartusche 1 Set = 6 Stück inkl. 8 Statikmischer zum Verkleben von Al-Profilen	
			2-component Polyurethane adhesive, black <i>in tandem cartridge 1 set = 6 pieces including 8 mixing nozzle to glue aluminium profiles</i>	
5070001	20 St. 20 pcs	WICLINE 75	Statikmischer für Tandemkartusche	
			Mixing nozzle <i>for tandem cartridge</i>	
5070002	1 Set 1 set	WICLINE 75	2-Komponenten Epoxid-Klebstoff in Dosengebinde für Portioniergerät Komponenten A+B zum Verkleben von Al- Profilen	
			2-component epoxy adhesive <i>in tins for portioning apparatus, component A+B, to glue aluminium profiles</i>	
5070224	20 St. 20 pcs	WICLINE 75	WICPRO-Tector zum Abdichten von Schnittkanten, weiß	
			WICPRO-Tector <i>for sealing mitre cut surfaces, white</i>	

Artikel Article	VE PU	Anwendung Application	Bezeichnung / Hinweise Designation / Indications	Abbildung Figure
		Material / Material Farbe / Colour	Zuordnung Assignment	
5070225	20 St. 20 pcs	WICLINE 75	WICPRO-Tector zum Abdichten von Schnittkanten, grau	
			WICPRO-Tector for sealing mitre cut surfaces, grey	
5070227	10 St. 10 pcs	WICLINE 75	2-Komponenten Polyurethan-Klebstoff in Tandemkartusche 2 x 310 ml 1 Set = 10 Stück inkl. 10 Statikmischer zum Verkleben von Al- Profilen	
			2 components polyurethane adhesive in tandem cartridge 2 x 310ml 1 set = 10 pieces including 10 mixing nozzles to glue aluminium profiles	
5070003	1 St. 1 pcs	WICLINE 75	Farbpaste weiß zum Einfärben von Klebstoff	
			Colour paste, white for colouration of adhesive	
5070004	1 Set 1 set	WICLINE 75	Farbpalette mit 5 Grundfarben, zum Einfärben von Klebstoff	
			Colour palette with 5 basic colours, for colouration of adhesive	
5070012	1 St. 1 pcs	WICLINE 75	Dichtungskleber, schwarz	
			Gasket glue, black	

Artikel Article	VE PU	Anwendung Application	Bezeichnung / Hinweise Designation / Indications	Abbildung Figure
		Material / Material Farbe / Colour	Zuordnung Assignment	
5070015	1 St. 1 pcs	WICLINE 75	Reinigungsmittel 1 l für pulverbeschichtete und eloxierte Profile	
			Cleaning agent, 1 litre for powder coated and anodized profiles	
5070016	1 St. 1 pcs	WICLINE 75	Reinigungsmittel 10 l für pulverbeschichtete und eloxierte Profile	
			Cleaning agent, 10 litre for powder coated and anodized profiles	
5070024	1 St. 1 pcs	WICLINE 75	Gleitfett säure- und harzfrei zum Fetten der Beschläge beim Einbau	
			Grease free from acid and resin to lubricate fittings while assembling	
5070025	1 St. 1 pcs	WICLINE 75	Pflegespray für Stanzen und Beschläge säure- und harzfrei zum nachträglichen Pflegen und Fetten der Beschlagsteile und Stanzwerkzeuge	
			Maintenance spray for punching and fittings free from acid and resin for subsequent maintenance and greasing of fitting parts and punching tools	
5070229	12 St. 12 pcs	WICLINE 75	Ersatzfolie für Schnittkanten-Abdichtungsmaschine 5060422.	
			Replacement foil for cut surfaces sealing machine 5060422.	

Artikel Article	VE PU	Anwendung Application	Bezeichnung / Hinweise Designation / Indications	Abbildung Figure
		Material / Material Farbe / Colour	Zuordnung Assignment	
5070043	100 m 100 m	WICLINE 75	Schutzfolie 1250 mm für Selbstzuschnitt, selbsthaftend, Transportschutz für behandelte Profile	
			Protective foil 1250 mm for cut to size, self-adhesive, as transport protection for surface treated profiles	
5070044	20 St. 20 pcs	WICLINE 75	Dichtmasse, silikonfrei 310 ml zum Abdichten in Fällen, wo silikonhaltige Stoffe nicht zulässig sind. Farbe: schwarz	
			Sealing compound, without silicone, 310 ml to seal in cases where materials containing silicone are not permissible. Colour: black	
5370004	5 St. 5 pcs	WICLINE 75	Reinigungsmittel 1 l Sonderreiniger für die Schweiz	
			Cleaning agent, 1 litre Special cleaner for Switzerland	
5370005	1 St. 1 pcs	WICLINE 75	Reinigungsmittel 10 l Sonderreiniger für die Schweiz	
			Cleaning agent 10 litre Special cleaner for Switzerland	
5970003	20 St. 20 pcs	WICLINE 75	SILCOSEAL Silikon-Dichtmasse 310 ml, schwarz zum Abdichten von Baufugen, für Abdichtungsarbeiten bei Riegelstößen oder zur Hinterlegung auf Gehung geschnittener Glasdichtungen.	
			SILCOSEAL Silicone sealant, 310 ml, black for sealing construction joints, transom joints or backlining mitre cut glazing gaskets.	

Hilfsstoffe
Auxiliary means

Artikel Article	VE PU	Anwendung Application	Bezeichnung / Hinweise Designation / Indications	Abbildung Figure
		Material / Material Farbe / Colour	Zuordnung Assignment	
5970004	20 St. 20 pcs	WICLINE 75	SILCOSEAL Silikon-Dichtmasse 310 ml, grau zum Abdichten von Baufugen, für Abdichtungsarbeiten bei Riegelstößen oder zur Hinterlegung auf Gehrung geschnittener Glasdichtungen.	
			SILCOSEAL Silicone sealant, 310 ml, grey <i>for sealing construction joints, transom joints or backlining mitre cut glazing gaskets.</i>	
5970006	1 Flasche 1 bottle	WICLINE 75	Primer / Reiniger 1,0 l in Kombination mit SILCOSEAL Silikon-Dichtmasse zur Vorbehandlung und Haftverbesserung auf beschichteten und unbeschichteten metallischen Werkstoffen. Beschichtung vor Anwendung prüfen, Datenblatt beachten.	
			Primer / Cleaner, 1.0 litre <i>in combination with SILCOSEAL silicone sealant for pre-treatment and adhesion improvements on coated and uncoated metals. Test coating prior to application, pay attention to data specification.</i>	

WICLINE 75

Werkzeuge
Tools

Abdichtungen
Sealings

Artikel Article	VE PU	Anwendung Application	Bezeichnung / Hinweise Designation / Indications	Abbildung Figure
		Material / Material Farbe / Colour	Zuordnung Assignment	
5970008	80 m 80 m	WICLINE 75	Fugendichtband BAP-System 75 75 mm x 6-20 mm, schwarz	
		PUR, geschäumt PUR, foamed	Joint sealing strip BAP system 75 75 mm x 6-20 mm, black	

	Seite
	Page
Statik - Richtlinien	8/3
<i>Static guidelines</i>	
Statikdiagramm	8/5
<i>Static diagram</i>	
Statikdiagramm Windlast	8/6
<i>Static diagram wind load</i>	
Statikdiagramm Glaslast	8/18
<i>Static diagram glass load</i>	
EN Normen	8/20
<i>European standards</i>	
Statische Werte	8/21
<i>Statical values</i>	
Eckwinkelzuschnitt / Auswahltabellen	8/39
<i>Cutting corner angle / Selection tables</i>	
Zuordnung Gelenkeckwinkel, vertikal	8/43
<i>Assignment hinged corner angle, vertical</i>	
Zuordnung Gelenkeckwinkel, horizontal	8/45
<i>Assignment hinged corner angle, horizontal</i>	
Zuordnung Gelenkverbinder	8/47
<i>Assignment hinged connector</i>	
Sprossenstoßverbindungen	8/49
<i>Crossbar butt-joint connections</i>	
Normen Information, Fenster durchschusshemmend	8/56
<i>Information about standards, bullet resistant</i>	
Durchschusshemmende Verglasung	8/57
<i>Bullet resistant glazing</i>	
Übersicht einbruchhemmende Bauteile	8/59
<i>Survey of burglar resistance components</i>	
Zertifikate	8/60
<i>Certificates</i>	

EN 14024

Anforderungen und mechanisches Leistungsverhalten von Metallprofilen mit thermischer Trennung (Verbundprofile)

Requirements and mechanical performance of metal profiles with thermal break (Composite profiles)

Vorbemerkung

Die statischen Erfordernisse von tragenden Gliedern sind entsprechend den jeweiligen Anforderungen zu dimensionieren. In vielen Anwendungsfällen ist ein statischer Nachweis erforderlich.

Definition: Metallprofil mit thermischer Trennung

Verbundprofil, zusammengesetzt aus zwei oder mehr Metallprofilen, die miteinander durch mindestens einen wärmedämmenden Bestandteil (nichtmetallisch) verbunden sind.

Die statischen Eigenschaften von Verbundprofilen und deren Nachweis unterscheiden sich wesentlich von Traggliedern aus nur einem Grundwerkstoff.

Inhalt der Norm (Deutsche Fassung)

In dieser Norm sind die Anforderungen an die Beurteilung der mechanischen Festigkeit von Verbundprofilen festgelegt. Es legt auch die Prüfungen zur Bestimmung der charakteristischen Werte von mechanischen Eigenschaften des Verbundprofils und die Beurteilung der Eignung der als thermische Trennung verwendeten Werkstoffe fest. Dieses Dokument gilt für Verbundprofile, die hauptsächlich für Fenster, Türen, Fensterwände und Vorhangfassaden vorgesehen sind.

Kategorien für den Gebrauch

Kategorie W

Metallprofile mit thermischer Trennung hauptsächlich für Fenster, Türen und Sekundärbauteile von Vorhangfassaden.

Anmerkung

Verbundprofile für Fenster und Türen erfordern gewöhnlich keinen Nachweis für die Berechnung der mechanischen Festigkeit.

Kategorie CW

Metallprofile mit thermischer Trennung hauptsächlich für die Bauteile von Vorhangfassaden mit Spannweiten größer als 2,25 m.

Der Nachweis beinhaltet neben den üblichen Lasten (Eigengewicht, Wind, weitere Verkehrslasten) im besonderen Temperaturbelastungen (Sommer, Winter) und deren Auswirkungen auf die Biegespannungen und Schubspannungen, speziell auf die nachgewiesenen Eigenschaften des „Elastischen Verbundes“ dieser Profile.

Verformungsbemessung – Ermittlung der Trägheitsmomente

Die zul. Verformung der Profile wird im Regelfall durch die Füllung definiert.

Bsp.: Glasfüllung $f_{zul} = L/200$, max. 15 mm.

Die Ermittlung des Trägheitsmomentes erfolgt abhängig von dieser Verformung (dem stat. System), der Stützweite und der Belastung. Bedingt durch die Theorie des elastischen Verbundes ergeben sich bei Metall-Kunststoff-Verbundprofilen stützweitenabhängig unterschiedliche Trägheitsmomente. Die Ermittlung der Trägheitsmomente erfolgt mit den bekannten Methoden und Tabellen.



Wichtiger Hinweis:

Die ausreichende statische Bemessung und sichere Tragfähigkeit der verwendeten Profile obliegt der Verantwortung des Anwenders.

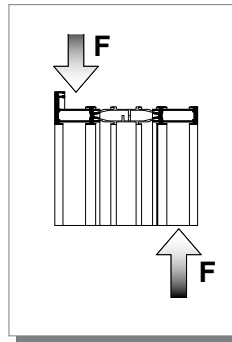

Schubfestigkeit
Shear strength

Preliminary remarks

The static requirements of supporting elements should be dimensioned according to the respective requirements. A statical evidence is necessary in many cases of application.

Definition: Metal profile with thermal break

Composite profile of two or more metal profiles connected with each other through minimum one insulating component (non-metallic).

The statical characteristics of composite profiles and their evidence differ substantially from supporting elements of only one base material.

Contents of Standard

Requirements on the evaluation of mechanical strength of composite profiles are specified in this standard. It also prescribes the tests for determining the characteristic value of mechanical properties of composite profiles and the evaluation of applicability of used material as thermal insulation. This document applies for composite profiles which are provided mainly for windows, doors, window walls and curtain walls.

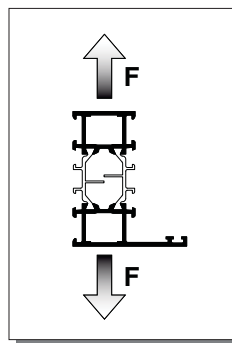

Querzugfestigkeit
Transverse tensile strength

Categories for use

Category W

Metal profiles with thermal break mainly for windows, doors and secondary structural components of curtain walls.

Annotation

Usually, composite profiles for windows and doors do not require evidence for the calculation of mechanical strength.

Category CW

Metal profiles with thermal break mainly for structural components of curtain walls with span widths larger than 2.25 m.

Next to the usual loads (own weight, wind, further live loads), the evidence includes particularly thermal loads (summer, winter) and their influence on bending stresses

and shearing stresses, especially on the proven properties of "composite elasticity" of these profiles.

Dimensioning deformation - Determination of moment of inertia

As a rule, the admissible deformation of profiles is defined through the infill.

Example: Glass infill $f_{adm} = L/200$, max. 15 mm.

The determination of moment of inertia follows depending on this deformation (static system) of bearing span and load.

Induced by the theory of composite elasticity, the different moments of inertia of metal-plastic composite profiles result from the bearing span dependent width. The determination of moment of inertia follows with the known methods and tables.



Important hints:

Adequate statical dimensioning and secured load bearing capacity of the used profiles lies in the responsibility of user.

Die benötigten Lasten wie Windlast, Eigenlast und Verkehrslast für die nachfolgenden Diagramme sind den jeweils gültigen nationalen Normen und Vorschriften zu entnehmen.

Anwendung der verschiedenen Diagramme

Rechtecklast Diagramme 1 – 3

Die Diagramme für Rechtecklast sind für eine annähernde Bestimmung des erforderlichen Trägheitsmoments in x-Richtung anwendbar, d. h. Belastung senkrecht zur Verglasung.

Dreieck- und Trapezlast Diagramme 4 – 6

Die Diagramme für Dreieck- und Trapezlast sind für eine annähernde Bestimmung des erforderlichen Trägheitsmomentes in x-Richtung anwendbar, d. h. Belastung senkrecht zur Verglasung. Bei Dreieck- und Trapezbelastung wird die Lastaufteilung nach DIN 1045 angenommen. Die Aufteilung erfolgt durch die Halbierung der Winkel. (Nach DIN 1045 für allseitig frei gelagerte Platte) (pict. 3).

Glaslast Diagramm 7

Das Diagramm für Glaslast ist für eine annähernde Bestimmung des erforderlichen Trägheitsmomentes bei Riegeln und Kämpfern in y-Richtung anwendbar, d. h. in Belastungsrichtung der Verglasung. Als zulässige Durchbiegung werden $f_{zul} = 3 \text{ mm}$ angenommen.

Lastaufteilung bei Rechtecklast
*Load distribution rectangular load
(curtain wall)*

pict. 1

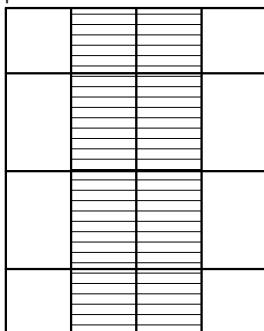

tatsächliche Aufteilung
auf die Stütze
*actual distribution on the
mullion*

pict. 2

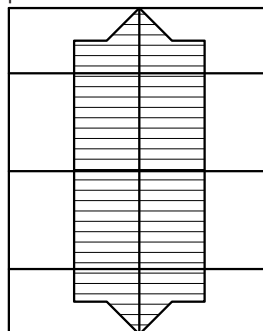

Lastaufteilung nach
DIN 1045
*Load distribution according
to DIN 1045*

pict. 3

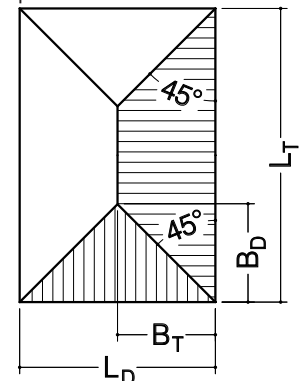

Die nachfolgenden Diagramme dienen zur überschlägigen Ermittlung der erforderlichen Trägheitsmomente. Die Diagramme sind nach bestem Wissen gefertigt. Eine Gewähr für Fehlerfreiheit kann jedoch nicht übernommen werden. Für verbindliche Festlegungen ist eine statische Nachrechnung erforderlich.



The diagrams are applicable for a rough determination of the required moment of inertia. The diagrams have been made to the best of our knowledge. However, no responsibility is taken for its correctness. In order to obtain binding results a statical check is necessary.

Rechtecklast (Einheitslast 1,0 kN/m²)
Rectangular load (Unit load 1,0 kN/m²)

$$f_{zul. / adm.} = L / 200$$

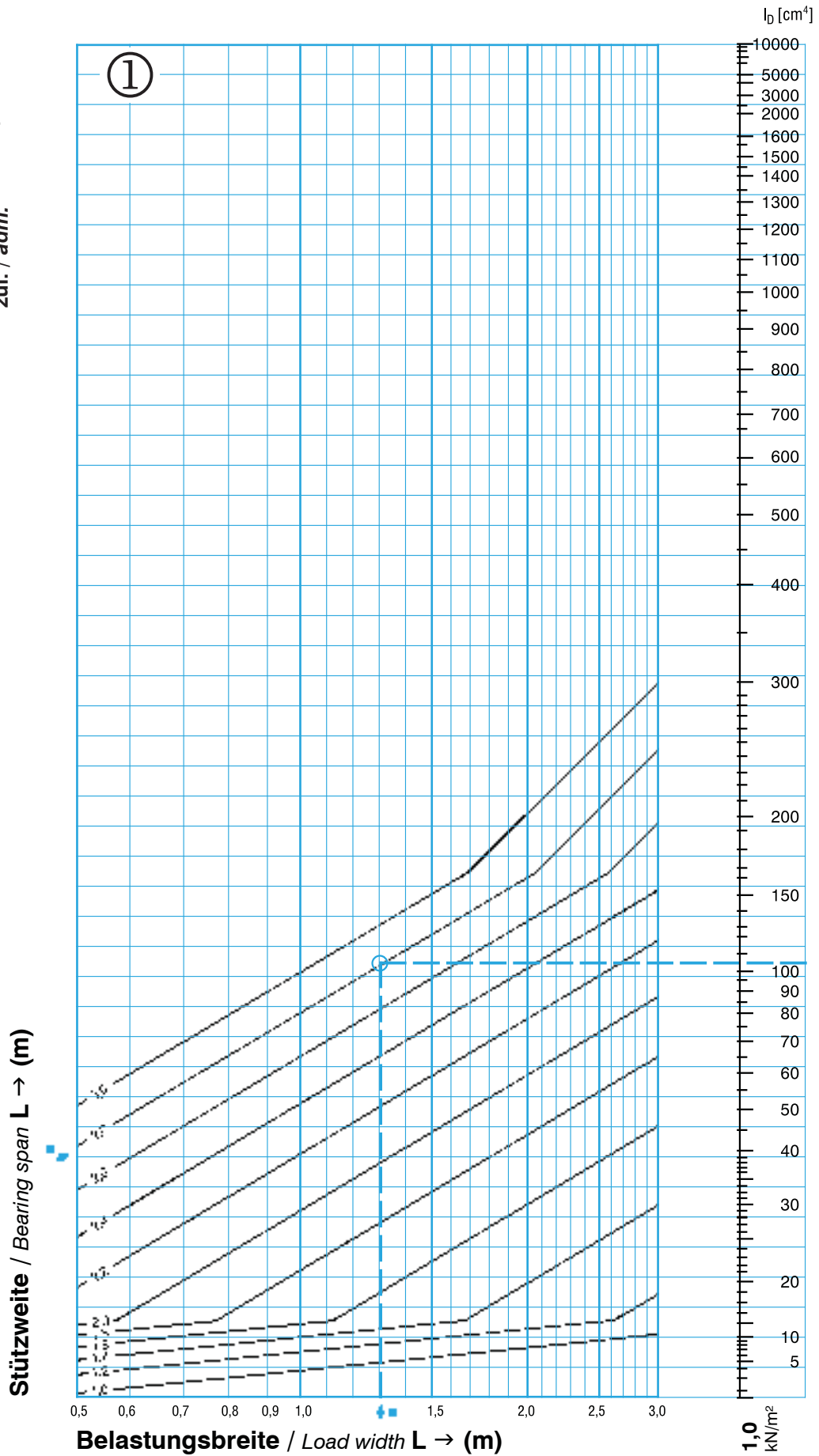

Rechtecklast (Einheitslast 1,0 kN/m²)
 Rectangular load (Unit load 1,0 kN/m²)

$$f_{zul. / adm.} = L / 200$$

System / System

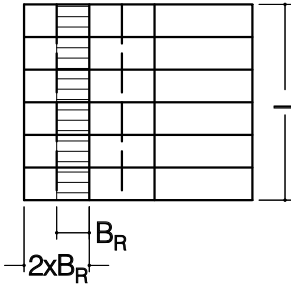

Anwendungsbeispiel Rechtecklast

Example of application rectangular load

Stützweite / Bearing span:

$$L = 2,80 \text{ m}$$

Belastungsbreite / Load width:

$$B = 1,30 \text{ m}$$

Rechtecklast / Rectangular load:

$$I_D = 106 \text{ cm}^4$$

Statisches System Rechtecklast

Statical system rectangular load

Träger auf 2 Stützen / Beam on 2 supports

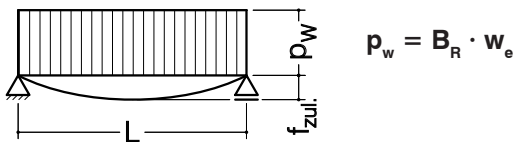

Ermittlung: erf. I_x / Determination: requ. I_x

Beispiel / Example:

Winddruck / Wind pressure

$$= 0,64 \text{ kN/m}^2$$

$$\text{erf. / requ. } I_x = w_e \cdot I_D = 0,64 \cdot 106 \text{ cm}^4$$

$$= 67,8 \text{ cm}^4$$

Windsog / Wind suction

$$= -1,12 \text{ kN/m}^2$$

$$\text{erf. / requ. } I_x = w_e \cdot I_D = (-1,12) \cdot 106 \text{ cm}^4$$

$$= 118,7 \text{ cm}^4$$

Berechnungsformel Rechtecklast

Calculation formula rectangular load

$$I_x = \frac{5 \cdot p_w \cdot L^4}{384 \cdot E \cdot f_{zul. / adm.}}$$

I_x	(cm ⁴) =	Trägheitsmoment / Moment of inertia
I_D	(cm ⁴) =	Trägheitsmoment, Rechtecklast / Moment of inertia, rectangular load
L	(cm) =	Stützweite / Bearing span
B	(cm) =	Belastungsbreite / Load width
w_e	(kN/cm ²) =	Winddruck/Windsog / Wind pressure/-depression
p_w	(kN/cm) =	Linienlast / Line load
E	(kN/cm ²) =	Elastizitätsmodul / Modulus of elasticity $7 \cdot 10^3$
$f_{zul. / adm.}$	(cm) =	zul. Durchbiegung / adm. deflection

Rechtecklast (Einheitslast 1,0 kN/m²)
Rectangular load (Unit load 1,0 kN/m²)

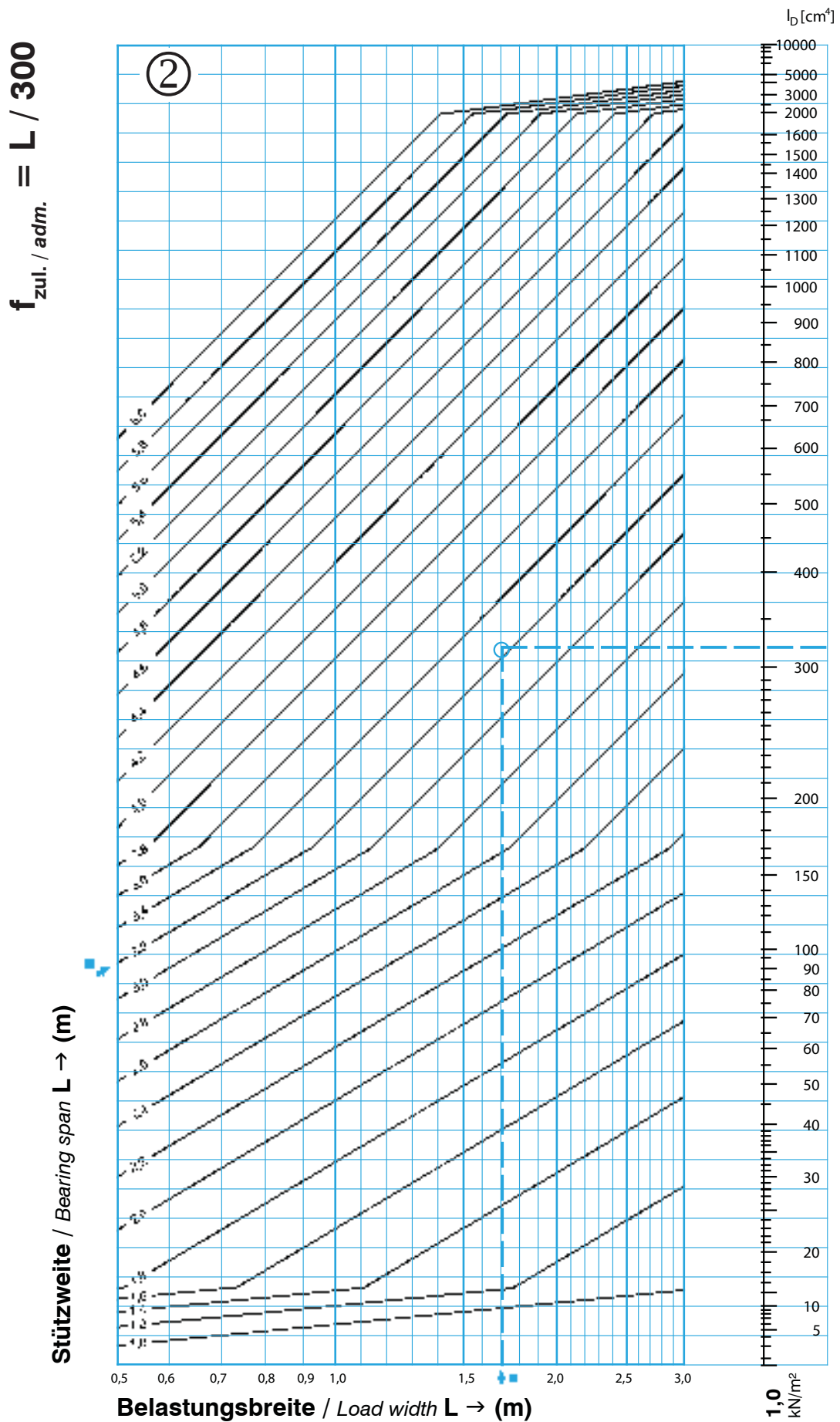

Rechtecklast (Einheitslast 1,0 kN/m²)
 Rectangular load (Unit load 1,0 kN/m²)

$$f_{zul. / adm.} = L / 300$$

System / System

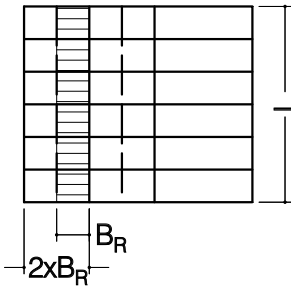

Anwendungsbeispiel Rechtecklast

Example of application rectangular load

Stützweite / Bearing span:

$$L = 3,20 \text{ m}$$

Belastungsbreite / Load width:

$$B = 1,70 \text{ m}$$

Rechtecklast / Rectangular load:

$$I_D = 311 \text{ cm}^4$$

Statisches System Rechtecklast

Statical system rectangular load

Träger auf 2 Stützen / Beam on 2 supports

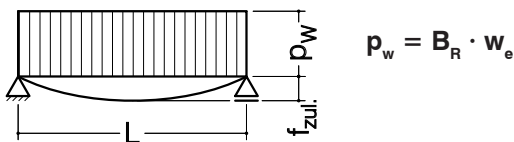

Ermittlung: erf. I_x / Determination: requ. I_x

Beispiel / Example:

Winddruck / Wind pressure

$$= 0,64 \text{ kN/m}^2$$

$$\text{erf. / requ. } I_x = w_e \cdot I_D = 0,64 \cdot 311 \text{ cm}^4$$

$$= 199 \text{ cm}^4$$

Windsog / Wind suction

$$= -1,12 \text{ kN/m}^2$$

$$\text{erf. / requ. } I_x = w_e \cdot I_D = (-1,12) \cdot 311 \text{ cm}^4$$

$$= 348,3 \text{ cm}^4$$

Berechnungsformel Rechtecklast

Calculation formula rectangular load

$$I_x = \frac{5 \cdot p_w \cdot L^4}{384 \cdot E \cdot f_{zul. / adm.}}$$

- I_x (cm⁴) = Trägheitsmoment / Moment of inertia
- I_D (cm⁴) = Trägheitsmoment, Rechtecklast / Moment of inertia, rectangular load
- L (cm) = Stützweite / Bearing span
- B (cm) = Belastungsbreite / Load width
- w_e (kN/cm²) = Winddruck/Windsog / Wind pressure/-depression
- p_w (kN/cm) = Linienlast / Line load
- E (kN/cm²) = Elastizitätsmodul / Modulus of elasticity 7 · 10³
- f_{zul. / adm.} (cm) = zul. Durchbiegung / adm. deflection

Rechtecklast (Einheitslast 1,0 kN/m²)
Rectangular load (Unit load 1,0 kN/m²)

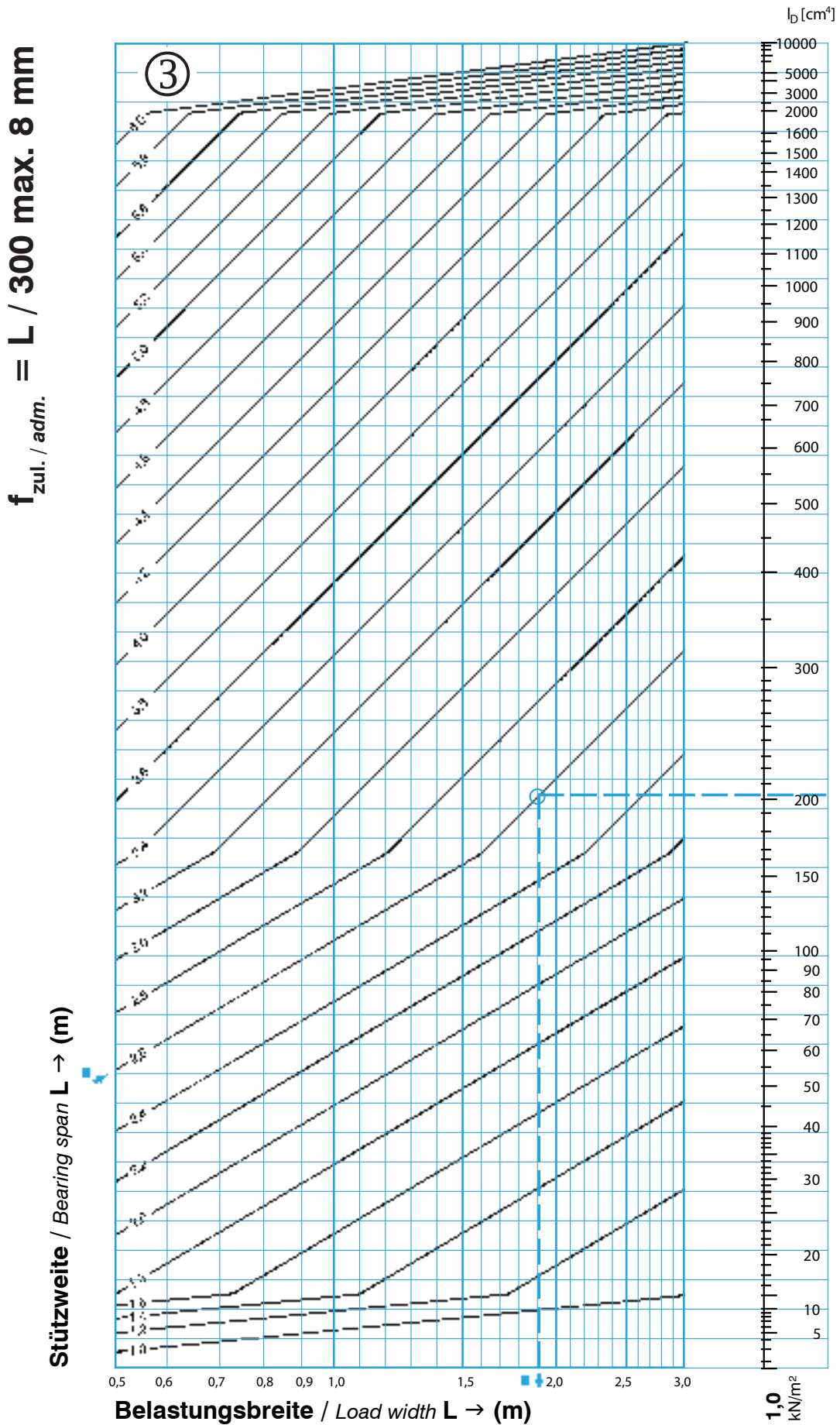

Rechtecklast (Einheitslast 1,0 kN/m²)
 Rectangular load (Unit load 1,0 kN/m²)

System / System

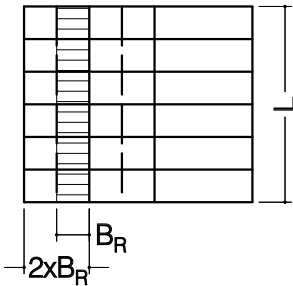

Statisches System Rechtecklast

Statische System rechtecklast
 Träger auf 2 Stützen / Beam on 2 supports

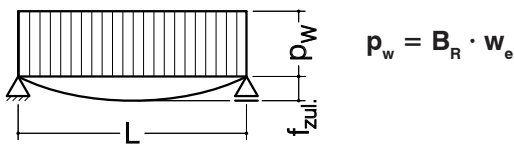

Berechnungsformel Rechtecklast

$$I_x = \frac{5 \cdot p_w \cdot L^4}{384 \cdot E \cdot f_{zul. / adm.}}$$

- I_x (cm⁴) = Trägheitsmoment / Moment of inertia
- I_D (cm⁴) = Trägheitsmoment, Rechtecklast / Moment of inertia, rectangular load
- L (cm) = Stützweite / Bearing span
- B (cm) = Belastungsbreite / Load width
- w_e (kN/cm²) = Winddruck/Windsog / Wind pressure/-depression
- p_w (kN/cm) = Linienlast / Line load
- E (kN/cm²) = Elastizitätsmodul / Modulus of elasticity $7 \cdot 10^3$
- $f_{zul. / adm.}$ (cm) = zul. Durchbiegung / adm. deflection

Statikdiagramm Windlast

Static diagram of wind load

$$f_{zul. / adm.} = L / 300 \text{ max. } 8 \text{ mm}$$

Anwendungsbeispiel Rechtecklast

Example of application rectangular load

Stützweite / Bearing span:

$$L = 2,60 \text{ m}$$

Belastungsbreite / Load width:

$$B = 1,90 \text{ m}$$

Rechtecklast / Rectangular load :

$$I_D = 202 \text{ cm}^4$$

Ermittlung: erf. I_x / Determination: requ. I_x

Beispiel / Example:

Winddruck / Wind pressure

$$= 0,64 \text{ kN/m}^2$$

$$\text{erf. / requ. } I_x = w_e \cdot I_D = 0,64 \cdot 202 \text{ cm}^4$$

$$= 129,3 \text{ cm}^4$$

Windsog / Wind suction

$$= -1,12 \text{ kN/m}^2$$

$$\text{erf. / requ. } I_x = w_e \cdot I_D = (-1,12) \cdot 202 \text{ cm}^4$$

$$= 226,2 \text{ cm}^4$$

Dreieck- und Trapezlast (Einheitslast 1,0 kN/m²)
Triangular and trapezoidal load (Unit load 1,0 kN/m²)

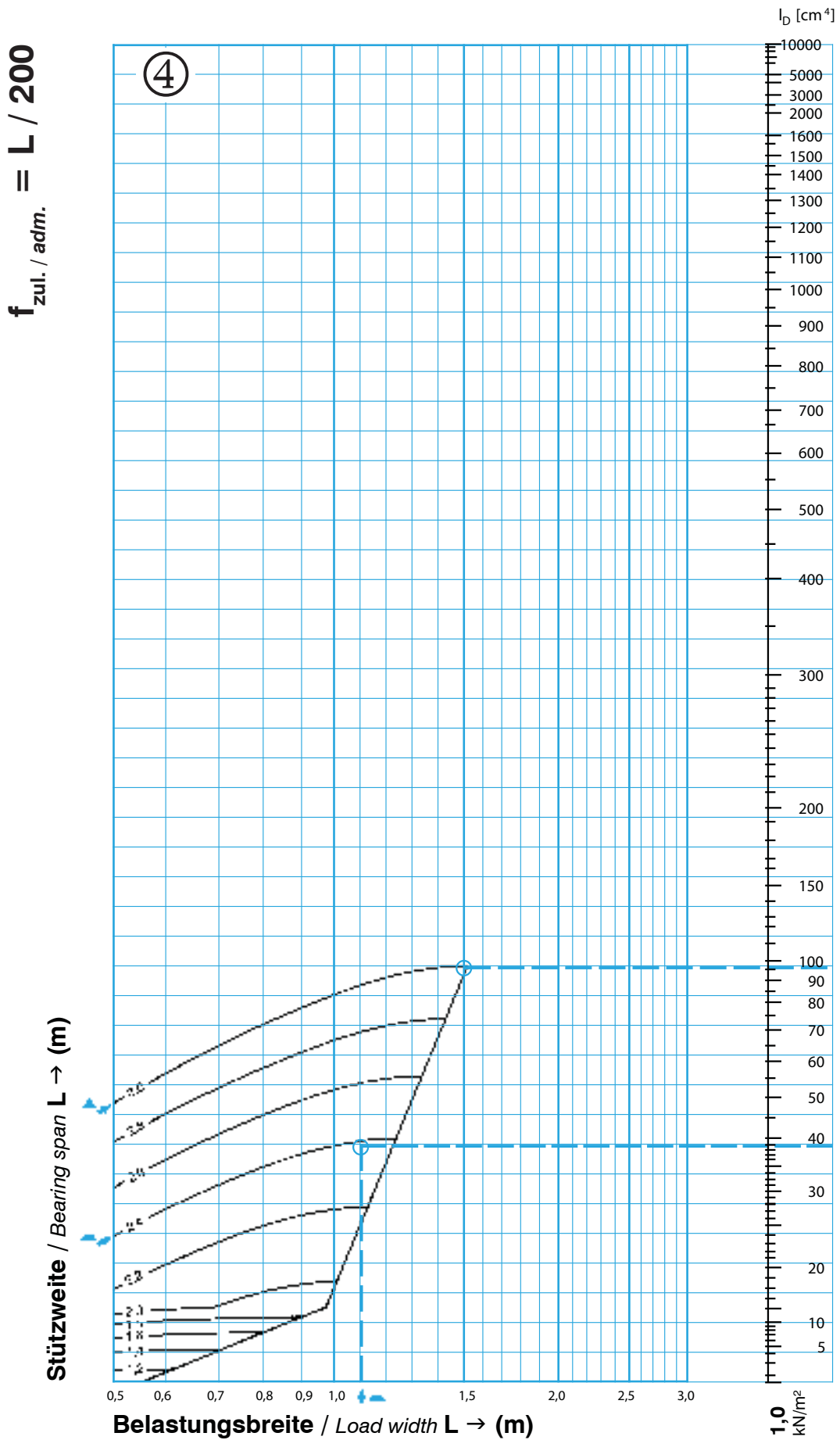

Dreieck- und Trapezlast (Einheitslast 1,0 kN/m²)
 Triangular and trapezoidal load (Unit load 1,0 kN/m²)

$$f_{zul./adm.} = L / 200$$

System / System

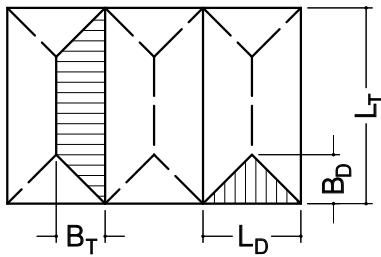

Anwendungsbeispiel Trapezlast

Example of application trapezoidal load

Stützweite / Bearing span:

$$L_T = 2,40 \text{ m}$$

Belastungsbreite / Load width:

$$B_T = 1,10 \text{ m}$$

Rechtecklast / Rectangular load:

$$I_D = 39 \text{ cm}^4$$

Statisches System Trapezlast

Statical system trapezoidal load

Träger auf 2 Stützen / Beam on 2 supports

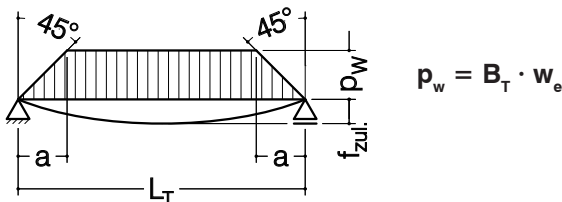

Ermittlung: erf. I_x / Determination: requ. I_x

Beispiel / Example:

Winddruck / Wind pressure

$$= 0,64 \text{ kN/m}^2$$

$$\text{erf. / requ. } I_x = w_e \cdot I_D = 0,64 \cdot 39 \text{ cm}^4$$

$$= 25,0 \text{ cm}^4$$

Windsog / Wind suction

$$= -1,12 \text{ kN/m}^2$$

$$\text{erf. / requ. } I_x = w_e \cdot I_D = (-1,12) \cdot 39 \text{ cm}^4$$

$$= 43,7 \text{ cm}^4$$

Berechnungsformel Trapezlast

Calculation formula trapezoidal load

$$I_{xT} = \frac{p_w \cdot L_T^4}{1920 \cdot E \cdot f_{zul./adm.}} \cdot \left(25 - 40 \frac{a^2}{L_T^2} + 16 \frac{a^4}{L_T^4} \right)$$

Statisches System Dreiecklast

Statical system triangular load

Träger auf 2 Stützen / Beam on 2 supports

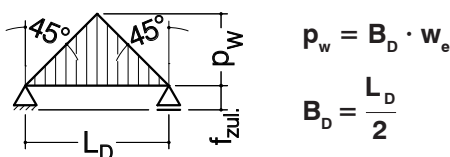

$$p_w = B_D \cdot w_e$$

$$B_D = \frac{L_D}{2}$$

Berechnungsformel Dreiecklast

Calculation formula triangular load

$$I_{xD} = \frac{p_w \cdot L^4}{120 \cdot E \cdot f_{zul./adm.}}$$

- I_x (cm⁴) = Trägheitsmoment / Moment of inertia
- L_D (cm) = Stützweite Dreiecklast / Bearing span triangular load
- L_T (cm) = Stützweite Trapezlast / Bearing span trapezoidal load
- B_D (cm) = Belastungsbreite Dreiecklast / Load width triangular load $B_D = L_D/2$
- B_T (cm) = Belastungsbreite Trapezlast / Load width trapezoidal load
- w_e (kN/cm²) = Winddruck/Windsog / Wind pressure/-depression
- p_w (kN/cm) = Linienlast / Line load
- E (kN/cm²) = Elastizitätsmodul / Modulus of elasticity $7 \cdot 10^3$
- $f_{zul./adm.}$ (cm) = zul. Durchbiegung / adm. deflection

Dreieck- und Trapezlast (Einheitslast 1,0 kN/m²)
Triangular and trapezoidal load (Unit load 1,0 kN/m²)

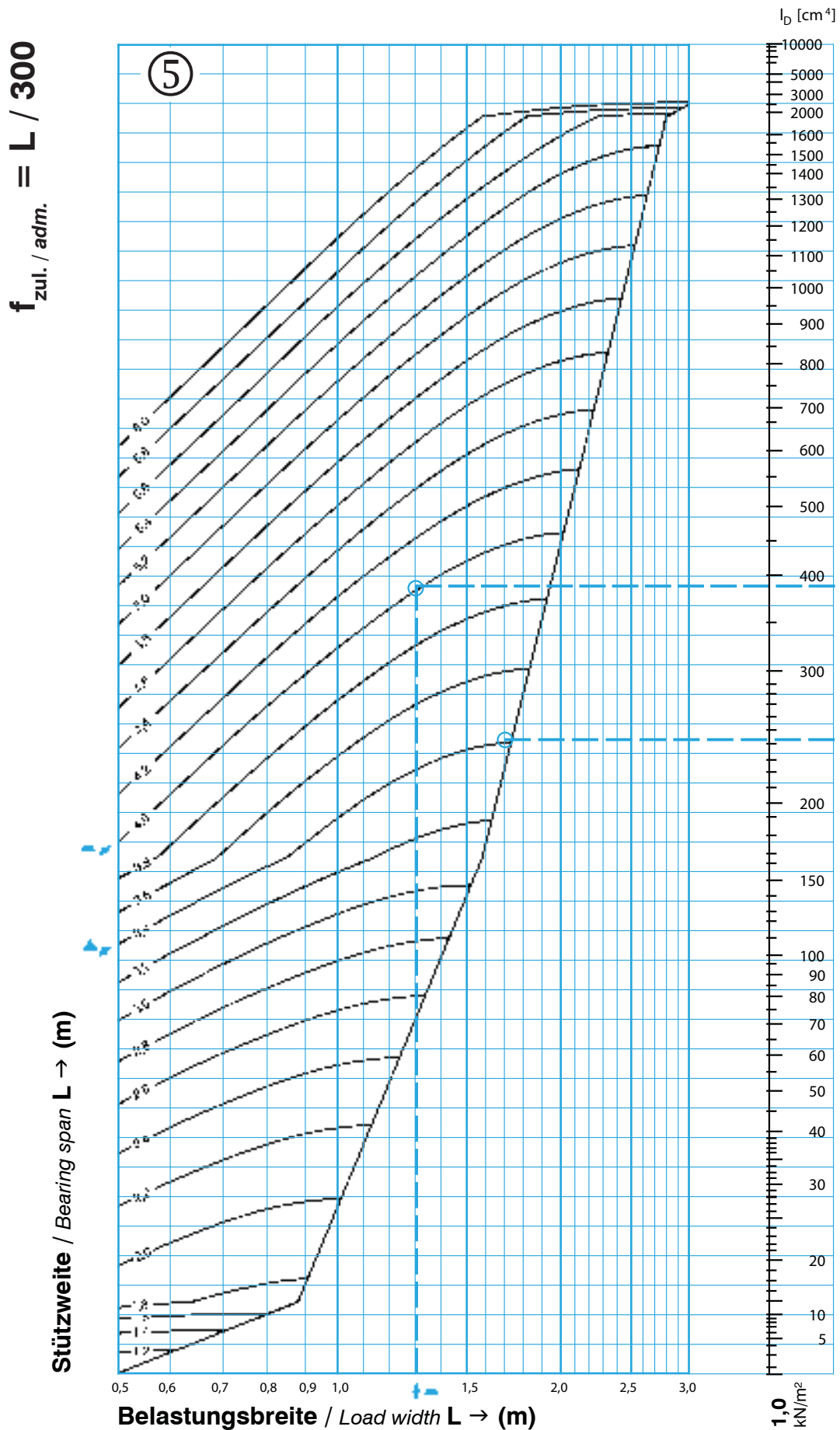

Dreieck- und Trapezlast (Einheitslast 1,0 kN/m²)
 Triangular and trapezoidal load (Unit load 1,0 kN/m²)

$$f_{zul./adm.} = L / 300$$

System / System

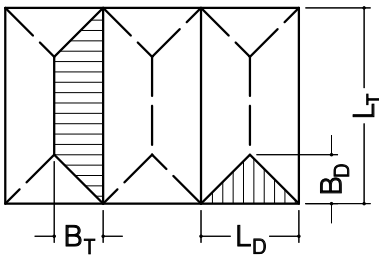

Anwendungsbeispiel Trapezlast

Example of application trapezoidal load

Stützweite / Bearing span:

$$L_T = 4,00 \text{ m}$$

Belastungsbreite / Load width:

$$B_T = 1,30 \text{ m}$$

Rechtecklast / Rectangular load:

$$I_D = 389 \text{ cm}^4$$

Statisches System Trapezlast

Statical system trapezoidal load

Träger auf 2 Stützen / Beam on 2 supports

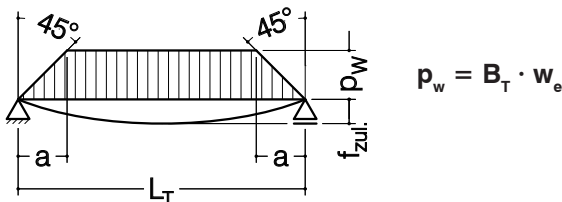

$$p_w = B_T \cdot w_e$$

Ermittlung: erf. I_x / Determination: requ. I_x

Beispiel / Example:

Winddruck / Wind pressure

$$= 0,64 \text{ kN/m}^2$$

$$\text{erf. / requ. } I_x = w_e \cdot I_D = 0,64 \cdot 389 \text{ cm}^4$$

$$= 249,0 \text{ cm}^4$$

Windsog / Wind suction

$$= -1,12 \text{ kN/m}^2$$

$$\text{erf. / requ. } I_x = w_e \cdot I_D = (-1,12) \cdot 389 \text{ cm}^4$$

$$= 435,7 \text{ cm}^4$$

Berechnungsformel Trapezlast

Calculation formula trapezoidal load

$$I_{xT} = \frac{p_w \cdot L_T^4}{1920 \cdot E \cdot f_{zul./adm.}} \cdot \left(25 - 40 \frac{a^2}{L_T^2} + 16 \frac{a^4}{L_T^4} \right)$$

Statisches System Dreiecklast

Statical system triangular load

Träger auf 2 Stützen / Beam on 2 supports

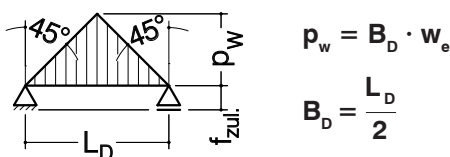

$$p_w = B_D \cdot w_e$$

$$B_D = \frac{L_D}{2}$$

Berechnungsformel Dreiecklast

Calculation formula triangular load

$$I_{xD} = \frac{p_w \cdot L^4}{120 \cdot E \cdot f_{zul./adm.}}$$

- I_x (cm⁴) = Trägheitsmoment / Moment of inertia
- I_D (cm⁴) = Trägheitsmoment, Rechtecklast / Moment of inertia, rectangular load
- L_D (cm) = Stützweite Dreiecklast / Bearing span triangular load
- L_T (cm) = Stützweite Trapezlast / Bearing span trapezoidal load
- B_D (cm) = Belastungsbreite Dreiecklast / Load width triangular load $B_D = L_D/2$
- B_T (cm) = Belastungsbreite Trapezlast / Load width trapezoidal load
- w_e (kN/cm²) = Winddruck/Windsog / Wind pressure/-depression
- p_w (kN/cm) = Linienlast / Line load
- E (kN/cm²) = Elastizitätsmodul / Modulus of elasticity $7 \cdot 10^3$
- $f_{zul./adm.}$ (cm) = zul. Durchbiegung / adm. deflection

Dreieck- und Trapezlast (Einheitslast 1,0 kN/m²)
Triangular and trapezoidal load (Unit load 1,0 kN/m²)

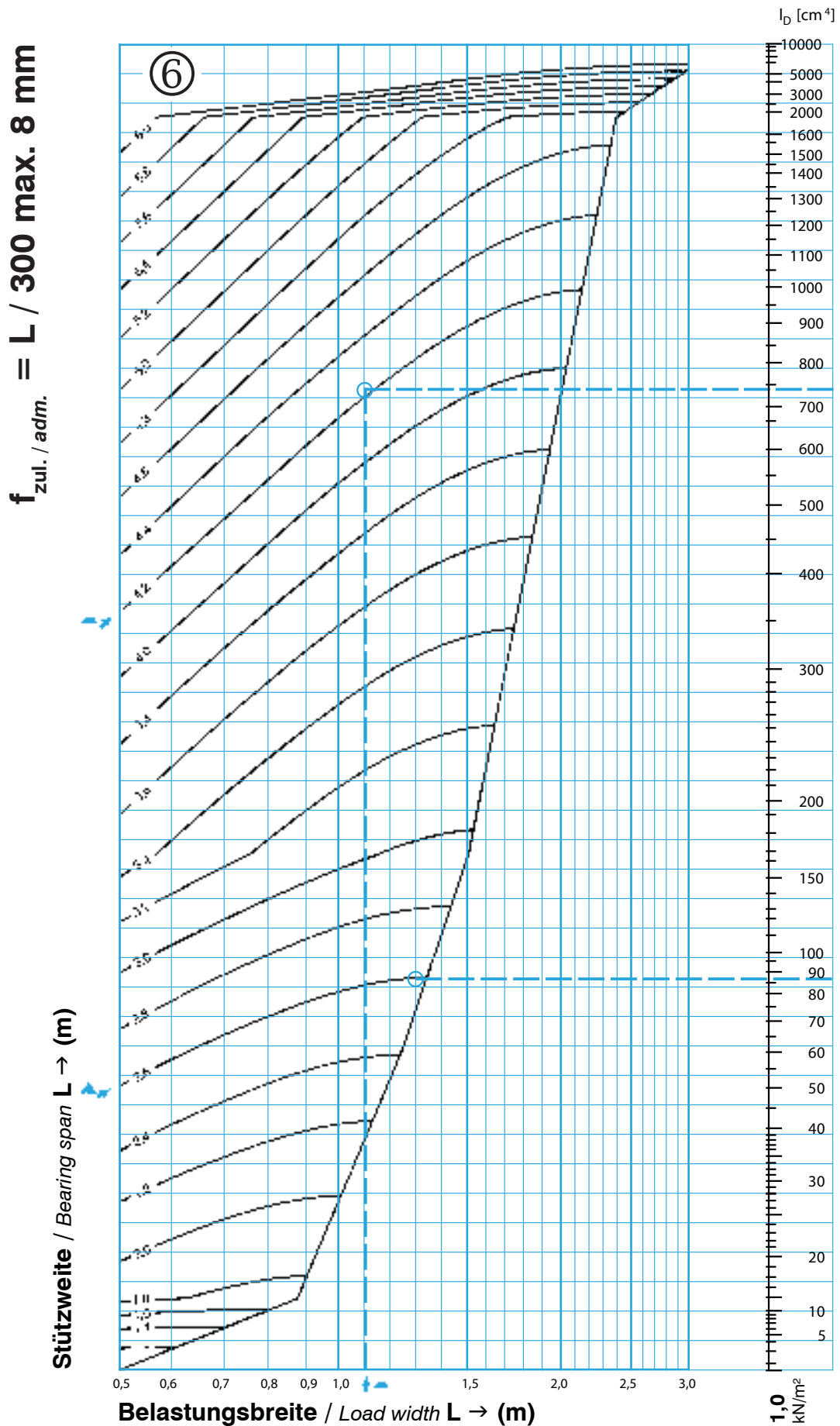

WICLINE

Dreieck- und Trapezlast (Einheitslast 1,0 kN/m²)
 Triangular and trapezoidal load (Unit load 1,0 kN/m²)

System / System

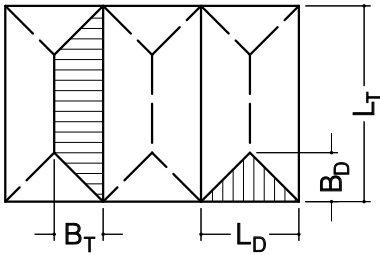

Statisches System Trapezlast

Statical system trapezoidal load

Träger auf 2 Stützen / Beam on 2 supports

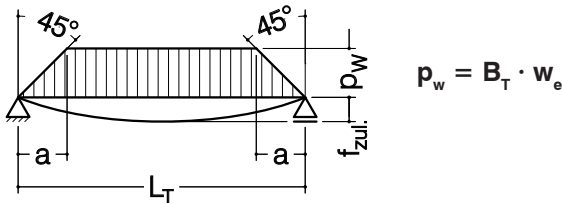

$$p_w = B_T \cdot w_e$$

Berechnungsformel Trapezlast

Calculation formula trapezoidal load

$$I_{xT} = \frac{p_w \cdot L_T^4}{1920 \cdot E \cdot f_{zul./adm.}} \cdot \left(25 - 40 \frac{a^2}{L_T^2} + 16 \frac{a^4}{L_T^4} \right)$$

Statisches System Dreiecklast

Statical system triangular load

Träger auf 2 Stützen / Beam on 2 supports

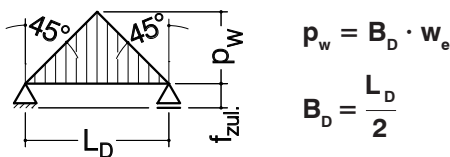

$$p_w = B_D \cdot w_e$$

$$B_D = \frac{L_D}{2}$$

Berechnungsformel Dreiecklast

Calculation formula triangular load

$$I_{xD} = \frac{p_w \cdot L^4}{120 \cdot E \cdot f_{zul./adm.}}$$

- I_x (cm⁴) = Trägheitsmoment / Moment of inertia
- I_D (cm⁴) = Trägheitsmoment, Rechtecklast / Moment of inertia, rectangular load
- L_D (cm) = Stützweite Dreiecklast / Bearing span triangular load
- L_T (cm) = Stützweite Trapezlast / Bearing span trapezoidal load
- B_D (cm) = Belastungsbreite Dreiecklast / Load width triangular load $B_D = L_D/2$
- B_T (cm) = Belastungsbreite Trapezlast / Load width trapezoidal load
- w_e (kN/cm²) = Winddruck/Windsog / Wind pressure/-depression
- p_w (kN/cm) = Linienlast / Line load
- E (kN/cm²) = Elastizitätsmodul / Modulus of elasticity $7 \cdot 10^3$
- $f_{zul./adm.}$ (cm) = zul. Durchbiegung / adm. deflection

Statikdiagramm Windlast

Static diagram of wind load

$$f_{zul./adm.} = L / 300 \text{ max. } 8 \text{ mm}$$

Anwendungsbeispiel Trapezlast

Example of application trapezoidal load

Stützweite / Bearing span:

$$L_T = 4,20 \text{ m}$$

Belastungsbreite / Load width:

$$B_T = 1,10 \text{ m}$$

Rechtecklast / Rectangular load:

$$I_D = 711 \text{ cm}^4$$

Ermittlung: erf. I_x / Determination: requ. I_x

Beispiel / Example:

Winddruck / Wind pressure

$$= 0,64 \text{ kN/m}^2$$

$$\text{erf. / requ. } I_x = w_e \cdot I_D = 0,64 \cdot 711 \text{ cm}^4$$

$$= 455,0 \text{ cm}^4$$

Windsog / Wind suction

$$= -1,12 \text{ kN/m}^2$$

$$\text{erf. / requ. } I_x = w_e \cdot I_D = (-1,12) \cdot 711 \text{ cm}^4$$

$$= 796,3 \text{ cm}^4$$

Glaslast (0,15 / 0,30 / 0,45 kN/m²)
Glass load (0,15 / 0,30 / 0,45 kN/m²)

f_{zul.} / adm. = 3 mm

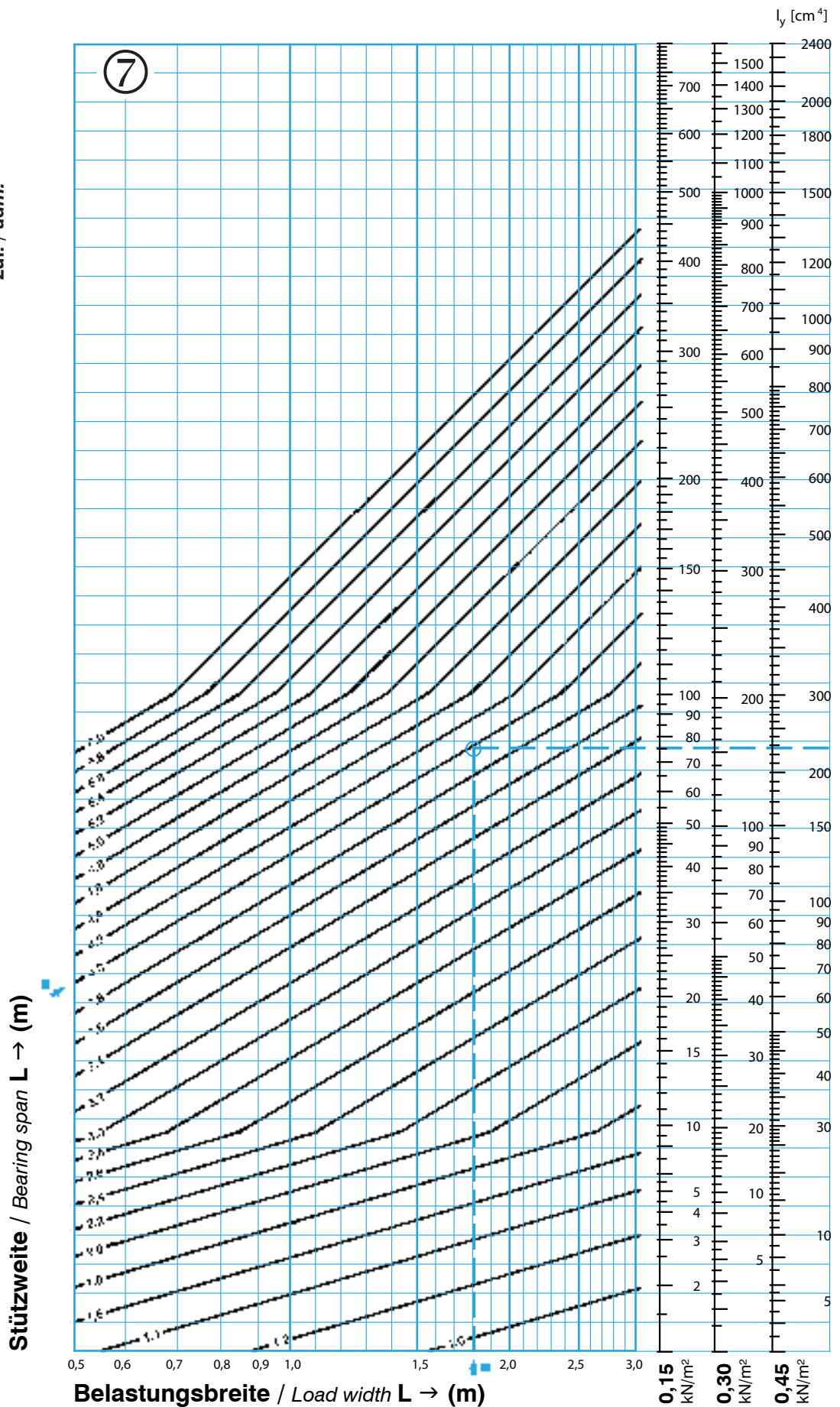

WICLINE

Statikdiagramm Glaslast

Static diagram glass load

Glaslast (0,15 / 0,30 / 0,45 kN/m²)

Glass load (0,15 / 0,30 / 0,45 kN/m²)

$$f_{zul. / adm.} = 3 \text{ mm}$$

System / System

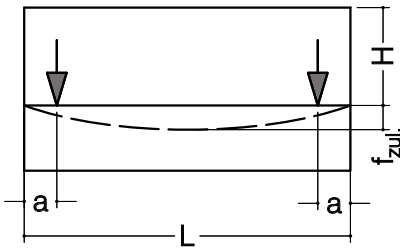

Das Eigengewicht des Profils ist nicht berücksichtigt !

The dead weight of the profile is not considered !

Statisches System

Statical system

Träger auf 2 Stützen / Beam on 2 supports

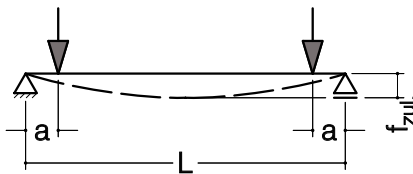

$$F = \frac{H \cdot L}{2} \cdot q_G$$

a = 150 mm festgelegt / fixed

Berechnungsformel Glaslast

Calculation formula glass load

$$I_y = \frac{F \cdot a}{24 \cdot E \cdot f_{zul. / adm.}} \cdot (3 \cdot L^2 - 4 a^2)$$

I_y	(cm ⁴)	= Trägheitsmoment / Moment of inertia
$F(P)$	(kN)	= Einzellast / Single load
a	(cm)	= Klotzungsabstand / Shimming distance
H	(cm)	= Scheibenhöhe / Pane height
L	(cm)	= Stützweite / Bearing span
q_G	(kN/cm ²)	= Glasgewicht / Glass weight
$f_{zul. / adm.}$	(cm)	= zul. Durchbiegung / adm. deflection

Regelwerke und Normen

Neben den Landesbauordnungen und Richtlinien sind die Normen und die VOB für das Metallhandwerk, Verglasungsarbeiten, Bauwesen und Bauphysik auf dem jeweils neuesten Ausgabestand entscheidend.
Es gilt die jeweils aktuelle Bauregelliste.

Eine Auflistung der zutreffenden, wichtigen Normen finden Sie in unserem digitalen technischen Informationsportal

www.wictip.de

Regulations and Standards

Besides the regional building regulations and guidelines, the latest edition of standards and German construction contract procedures (VOB) for metal working, glazing works, civil engineering and building physics are binding.
The respective, current Building Rules List applies.

A list of relevant, important standards can be found in our digital technical information portal

www.wictip.de



Glas

Planungshinweise > Normen > Anhang A - Glas

Metallbau

Planungshinweise > Normen > Anhang B - Metallbau

Statik

Planungshinweise > Normen > Anhang C - Static

Verglasungsarbeiten

Planungshinweise > Normen > Anhang D - Verglasungsarbeiten

Wärmeschutz

Planungshinweise > Normen > Anhang E - Wärmeschutz

Schallschutz

Planungshinweise > Normen > Anhang F - Schallschutz

Sonnenschutz

Planungshinweise > Normen > Anhang G - Sonnenschutz

Sicherheit

Planungshinweise > Normen > Anhang H - Sicherheit

Brandschutz

Planungshinweise > Normen > Anhang I - Brandschutz

Bauwerksabdichtungen

Planungshinweise > Normen > Anhang J - Bauwerksabdichtung

Glass

Planning hints > Standards > Appendix A - Glass

Metal construction

Planning hints > Standards > Appendix B - Metal construction

Statics

Planning hints > Standards > Appendix C - Statics

Glazing works

Planning hints > Standards > Appendix D - Glazing works

Thermal insulation

Planning hints > Standards > Appendix E - Thermal insulation

Sound insulation

Planning hints > Standards > Appendix F - Sound insulation

Solar protection

Planning hints > Standards > Appendix G - Sunshade

Safety

Planning hints > Standards > Appendix H - Safety

Fire protection

Planning hints > Standards > Appendix I - Fire protection

Structural sealing



Planning hints > Standards > Appendix J - Structural sealing

WICLINE 75

Blendrahmenprofile
Frame profiles

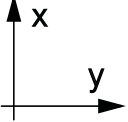
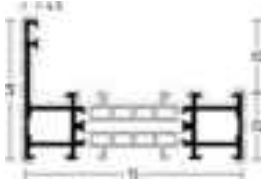
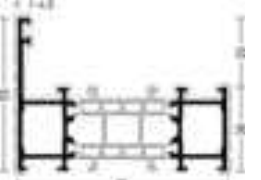
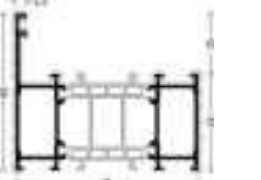
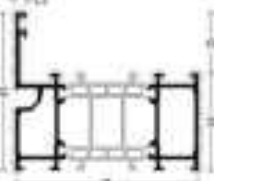
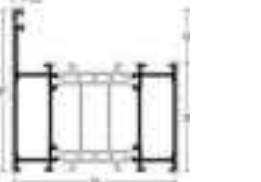
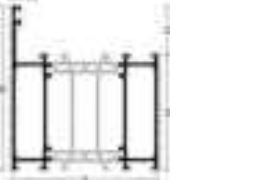
Statische Werte
Statical values

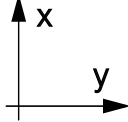
		Artikel-Nr. / Article-no.				
		lx	eff (cm ⁴) nach IfBt-Richtlinien eff (cm ⁴) acc. to IfBt guidelines			
		ly	add (cm ⁴) add (cm ⁴)			
		Stützweite L ab (cm) Bearing span L from (cm)				
			200	250	300	400
	1017001					
	lx	22.8	25	26.38	27.91	
	ly	4.22				
	1017003					
	lx	25.23	27.94	29.68	31.63	
	ly	6.76				
	1017004					
	lx	28.19	31.6	33.82	36.36	
	ly	12.11				
	1017050					
	lx	28.3	31.8	34.09	36.71	
	ly	12.12				
	1017005					
	lx	30.9	35.03	37.76	40.95	
	ly	19.77				
	1017006					
	lx	33.4	38.25	41.53	45.4	
	ly	30.08				

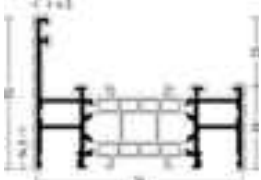
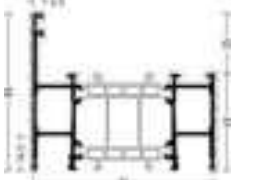
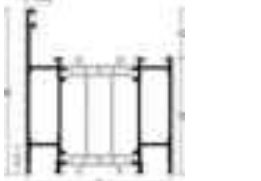
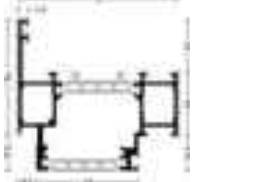
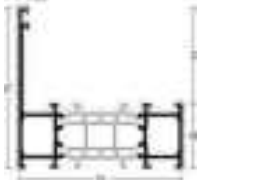
		Artikel-Nr. / Article-no.				
		lx	eff (cm ⁴) nach IfBt-Richtlinien eff (cm ⁴) acc. to IfBt guidelines			
		ly	add (cm ⁴) add (cm ⁴)			
		Stützweite L ab (cm) Bearing span L from (cm)				
			200	250	300	400
	1017008					
	lx	45.26	60.94	69.73	81.41	
	ly	213.05				
	1017062					
	lx	25.65	28.49	30.32	32.38	
	ly	6.04				
	1017064					
	lx	28.62	32.18	34.51	37.19	
	ly	11.07				
	1017066					
	lx	33.74	38.75	42.15	46.18	
	ly	28.65				
	1017077					
	lx	26.91	30.43	32.76	35.47	
	ly	14.18				
	1017081					
	lx	27.46	30.59	32.62	34.91	
	ly	13.78				

WICLINE 75

Blendrahmenprofile
Frame profiles

Statische Werte
Statical values

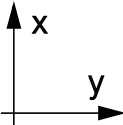
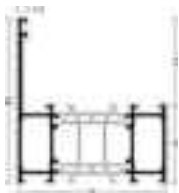
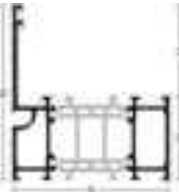
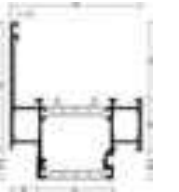
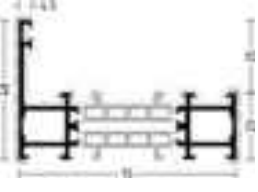
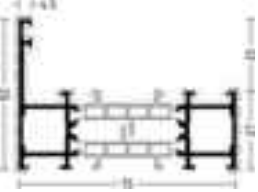
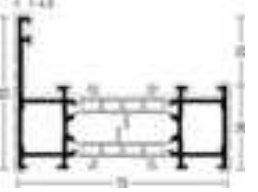
	Artikel-Nr. / Article-no.				
	lx	eff (cm ⁴) nach IfBt-Richtlinien eff (cm ⁴) acc. to IfBt guidelines			
	ly	add (cm ⁴) add (cm ⁴)			
Stützweite L ab (cm) Bearing span L from (cm)					
200 250 300 400					
	1017082				
	lx	30.39	34.26	36.8	39.74
	ly	20.85			
	1017051				
	lx	30.42	34.36	36.96	39.96
	ly	20.89			
	1017090				
	lx	28.32	32.05	34.53	37.4
	ly	22.44			
	1917001				
	lx	21.38	23.88	25.5	27.35
	ly	4.22			
	1917002				
	lx	22.53	25.35	27.19	29.31
	ly	5.56			
	1917003				
	lx	23.5	26.56	28.58	30.92
	ly	6.76			

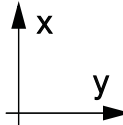
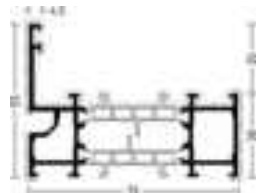
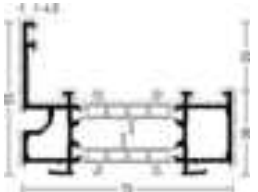
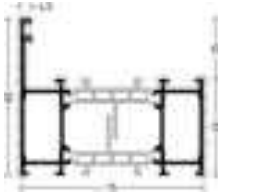
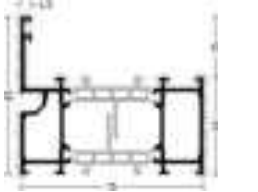
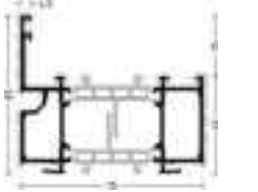
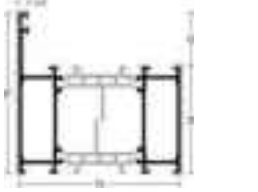
	Artikel-Nr. / Article-no.				
	lx	eff (cm ⁴) nach IfBt-Richtlinien eff (cm ⁴) acc. to IfBt guidelines			
	ly	add (cm ⁴) add (cm ⁴)			
Stützweite L ab (cm) Bearing span L from (cm)					
200 250 300 400					
	1010488				
	lx	23.58	26.72	28.8	31.22
	ly	6.8			
	1010489				
	lx	22.58	25.55	27.52	29.8
	ly	6.65			
	1917004				
	lx	26.06	29.85	32.41	35.43
	ly	12.11			
	1010491				
	lx	26.13	30	32.63	35.75
	ly	12.12			
	1010492				
	lx	25.75	29.55	32.13	35.19
	ly	11.94			
	1917005				
	lx	28.37	32.9	36.02	39.77
	ly	19.77			

WICLINE 75

Blendrahmenprofile
Frame profiles

Statische Werte
Statical values

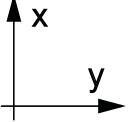
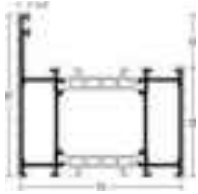
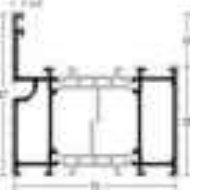
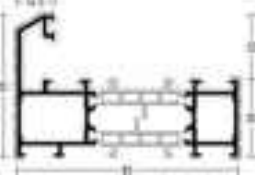
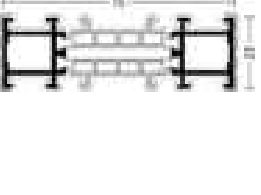
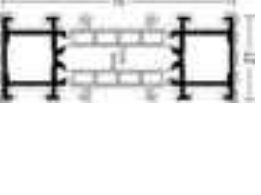
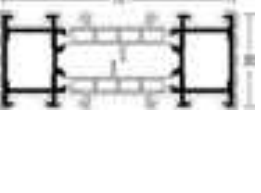

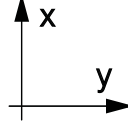
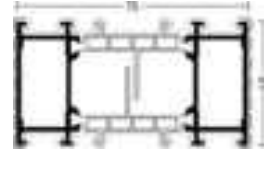
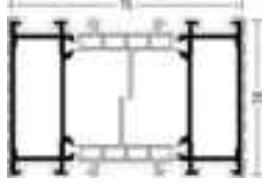
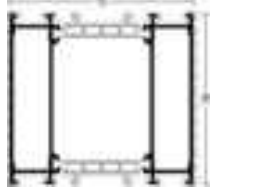
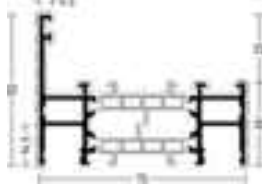
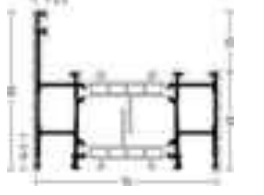
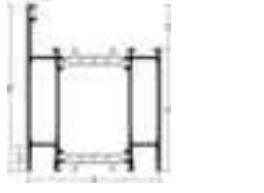

	Artikel-Nr. / Article-no.				
	lx	eff (cm ⁴) nach IfBt-Richtlinien eff (cm ⁴) acc. to IfBt guidelines			
	ly	add (cm ⁴) add (cm ⁴)			
		Stützweite L ab (cm) Bearing span L from (cm)			
		200	250	300	400
	1910148				
	lx	28.37	32.9	36.02	39.77
	ly	19.77			
	1010495				
	lx	28.43	33.04	36.24	40.09
	ly	19.82			
	1917009				
	lx	31.33	35.64	38.52	41.89
	ly	8.96			
	1917055				
	lx	17.91	19.78	20.97	22.3
	ly	1.37			
	1917056				
	lx	19.15	21.3	22.69	24.25
	ly	2.22			
	1917057				
	lx	20.18	22.57	24.11	25.87
	ly	3.03			

	Artikel-Nr. / Article-no.				
	lx	eff (cm ⁴) nach IfBt-Richtlinien eff (cm ⁴) acc. to IfBt guidelines			
	ly	add (cm ⁴) add (cm ⁴)			
		Stützweite L ab (cm) Bearing span L from (cm)			
		200	250	300	400
	1917058				
	lx	22.94	26.01	28.05	30.42
	ly	6.91			
	1917059				
	lx	25.44	29.22	31.79	34.83
	ly	12.85			
	1917060				
	lx	29.8	35.02	38.71	43.23
	ly	32.13			
	1917062				
	lx	23.85	27.04	29.16	31.63
	ly	6.04			
	1917064				
	lx	26.41	30.35	33.03	36.21
	ly	11.07			
	1917067				
	lx	32.62	38.76	43.18	48.7
	ly	41.77			

WICLINE 75

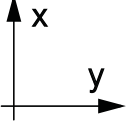
Blendrahmenprofile
Frame profiles

Statische Werte
Statical values

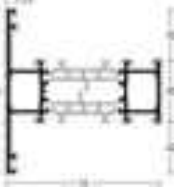
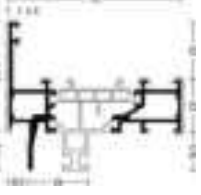
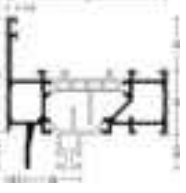
	Artikel-Nr. / Article-no.				
	lx	eff (cm ⁴) nach IfBt-Richtlinien eff (cm ⁴) acc. to IfBt guidelines			
	ly	add (cm ⁴) add (cm ⁴)			
Stützweite L ab (cm) Bearing span L from (cm)					
200 250 300 400					
	1910172				
	lx	43.29	54.78	64.01	76.89
	ly	213.05			
	1917068				
	lx	25.65	29.07	31.34	33.98
	ly	7.07			
	1917069				
	lx	27.44	31.42	34.12	37.3
	ly	10.5			
	1917073				
	lx	25.87	29.48	31.89	34.72
	ly	12.61			
	1917076				
	lx	23.62	26.36	28.12	30.14
	ly	6.69			
	1917077				
	lx	25.79	29.01	31.12	33.54
	ly	10.13			

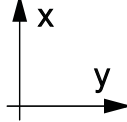
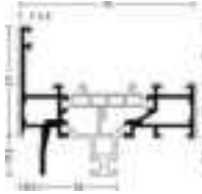
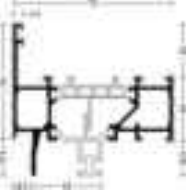
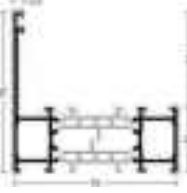
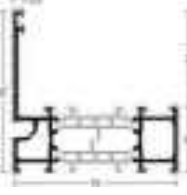
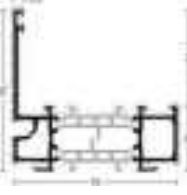
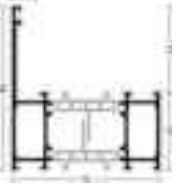
	Artikel-Nr. / Article-no.				
	lx	eff (cm ⁴) nach IfBt-Richtlinien eff (cm ⁴) acc. to IfBt guidelines			
	ly	add (cm ⁴) add (cm ⁴)			
Stützweite L ab (cm) Bearing span L from (cm)					
200 250 300 400					
	1910134				
	lx	23.62	26.36	28.12	30.14
	ly	6.69			
	1910135				
	lx	25.79	29.01	31.12	33.54
	ly	10.13			
	1917081				
	lx	27.08	30.29	32.37	34.75
	ly	13.78			
	1010434				
	lx	25.49	29.06	31.45	34.25
	ly	13.95			
	1010490				
	lx	24.51	27.9	30.17	32.82
	ly	13.71			
	1917082				
	lx	30.39	34.26	36.8	39.74
	ly	20.85			

WICLINE 75

Blendrahmenprofile
Frame profiles

Statische Werte
Statical values

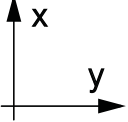
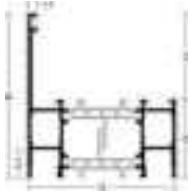
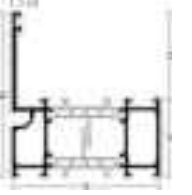
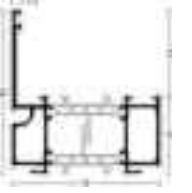
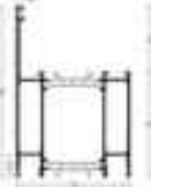
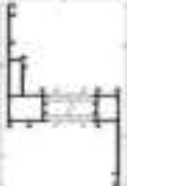
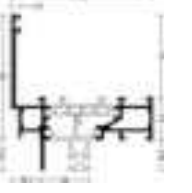

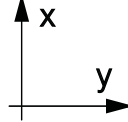
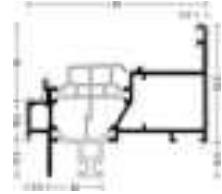
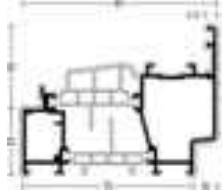
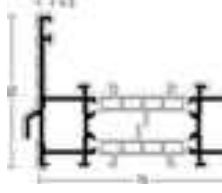
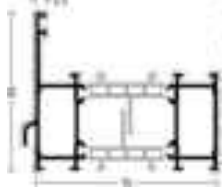
	Artikel-Nr. / Article-no.				
	lx	eff (cm ⁴) nach IfBt-Richtlinien eff (cm ⁴) acc. to IfBt guidelines			
	ly	add (cm ⁴) add (cm ⁴)			
Stützweite L ab (cm) Bearing span L from (cm)					
200 250 300 400					
	1917086				
	lx	28.33	32.76	35.81	39.45
	ly	19.69			
	1010493				
	lx	27.99	32.33	35.3	38.86
	ly	20.89			
	1010494				
	lx	27.08	31.24	34.08	37.47
	ly	20.51			
	1910170				
	lx	34.32	41.01	45.86	51.98
	ly	57.04			
	1310991				
	lx	46.63	55.4	61.7	69.57
	ly	41.82			
	1917089				
	lx	24	26.87	28.73	30.86
	ly	13.41			

	Artikel-Nr. / Article-no.				
	lx	eff (cm ⁴) nach IfBt-Richtlinien eff (cm ⁴) acc. to IfBt guidelines			
	ly	add (cm ⁴) add (cm ⁴)			
Stützweite L ab (cm) Bearing span L from (cm)					
200 250 300 400					
	1917092				
	lx	31.59	35.68	38.38	41.5
	ly	9.93			
	1917093				
	lx	31.95	36.68	39.9	43.7
	ly	13.16			
	1010344				
	lx	26.34	29.37	31.32	33.54
	ly	6.84			
	1010346				
	lx	29.19	32.94	35.41	38.27
	ly	12.35			

WICLINE 75

Flügelprofile
Sash profiles

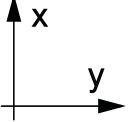
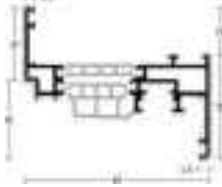
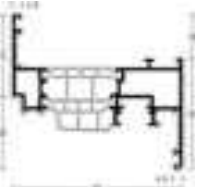
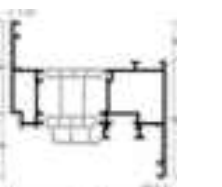
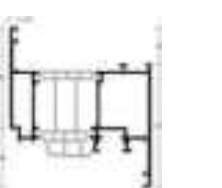
Statische Werte
Statical values

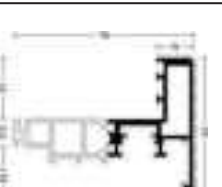
	Artikel-Nr. / Article-no.				
	lx	eff (cm ⁴) nach IfBt-Richtlinien eff (cm ⁴) acc. to IfBt guidelines			
	ly	add (cm ⁴) add (cm ⁴)			
		Stützweite L ab (cm) Bearing span L from (cm)			
		200	250	300	400
	1017101				
	lx	34.73	38.54	40.98	43.73
	ly	6.27			
	1017102				
	lx	37.46	41.97	44.9	48.26
	ly	9.53			
	1017103				
	lx	40.91	46.37	49.99	54.2
	ly	16.31			
	1017104				
	lx	44.36	50.83	55.2	60.37
	ly	26.02			
	1017105				
	lx	47.33	54.77	59.88	66.01
	ly	38.89			
	1017111				
	lx	0	0	0	0
	ly	10.35			

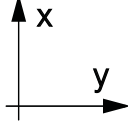
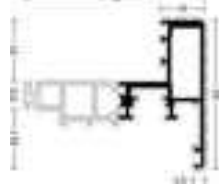
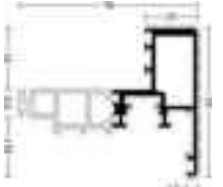
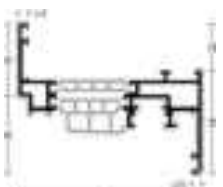
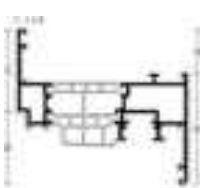
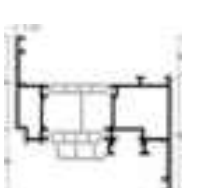
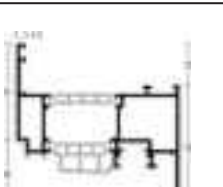
	Artikel-Nr. / Article-no.				
	lx	eff (cm ⁴) nach IfBt-Richtlinien eff (cm ⁴) acc. to IfBt guidelines			
	ly	add (cm ⁴) add (cm ⁴)			
		Stützweite L ab (cm) Bearing span L from (cm)			
		200	250	300	400
	1017112				
	lx	0	0	0	0
	ly	11.04			
	1017113				
	lx	0	0	0	0
	ly	11.85			
	1917101				
	lx	32.31	36.59	39.43	42.72
	ly	6.27			
	1917102				
	lx	34.64	39.65	43.04	47.03
	ly	9.53			
	1917103				
	lx	37.56	43.55	47.68	52.64
	ly	16.31			
	1910146				
	lx	37.56	43.55	47.68	52.64
	ly	16.31			

WICLINE 75

Flügelprofile
Sash profiles

Statische Werte
Statical values

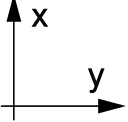
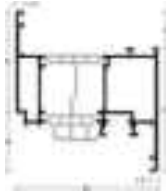
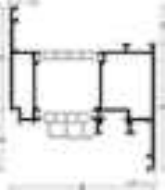
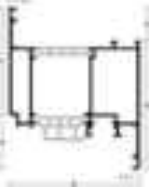
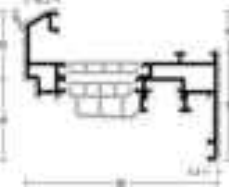
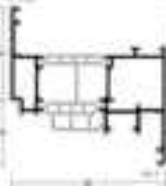
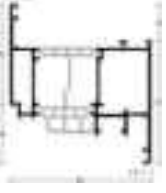

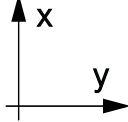
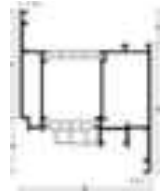
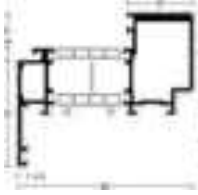
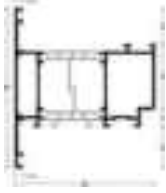
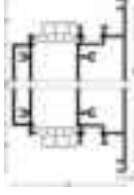
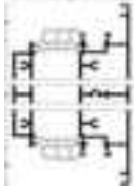
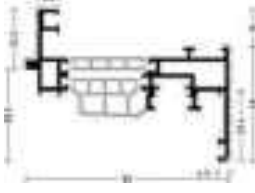
		Artikel-Nr. / Article-no.			
		lx	eff (cm ⁴) nach IfBt-Richtlinien eff (cm ⁴) acc. to IfBt guidelines		
		ly	add (cm ⁴) add (cm ⁴)		
		Stützweite L ab (cm) Bearing span L from (cm)			
		200	250	300	400
	1917104				
	lx	40.46	47.47	52.41	58.45
	ly	26.02			
	1910147				
	lx	40.46	47.47	52.41	58.45
	ly	26.02			
	1917115				
	lx	42.92	50.89	56.61	63.72
	ly	38.89			
	1917105				
	lx	31.85	36.23	39.16	42.58
	ly	6.36			
	1917116				
	lx	37.44	43.42	47.54	52.5
	ly	16.96			
	1917117				
	lx	40.34	47.34	52.27	58.3
	ly	26.99			



		Artikel-Nr. / Article-no.			
		lx	eff (cm ⁴) nach IfBt-Richtlinien eff (cm ⁴) acc. to IfBt guidelines		
		ly	add (cm ⁴) add (cm ⁴)		
		Stützweite L ab (cm) Bearing span L from (cm)			
		200	250	300	400
	1917118				
	lx	42.79	50.76	56.46	63.57
	ly	40.22			
	1917161				
	lx	37.48	42.93	46.62	50.98
	ly	16.39			
	1917163				
	lx	41.13	47.54	51.93	57.19
	ly	30.27			
	1010375				
	lx	61.95	79.51	93.99	114.75
	ly	331.51			
	1010383				
	lx	70.14	93.8	114.85	147.82
	ly	995.15			
	1010453				
	lx	30.74	34.94	37.74	41.01
	ly	5.92			

WICLINE 75

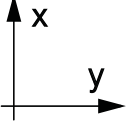
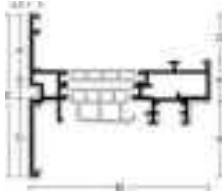
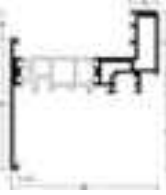
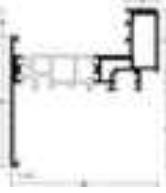
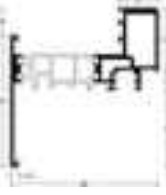
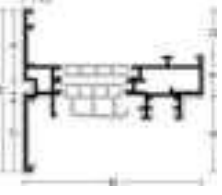
Stulpflügelprofile
Double casement sash profiles

Statische Werte
Statical values

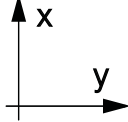
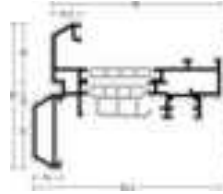
	Artikel-Nr. / Article-no.				
	lx	eff (cm ⁴) nach IfBt-Richtlinien eff (cm ⁴) acc. to IfBt guidelines			
	ly	add (cm ⁴) add (cm ⁴)			
Stützweite L ab (cm) Bearing span L from (cm)					
200 250 300 400					
	1017120				
	lx	35.81	40.54	43.67	47.3
	ly	11.18			
	1017124				
	lx	38.67	45.38	50.11	55.89
	ly	17.59			
	1017125				
	lx	38.23	44.88	49.57	55.32
	ly	18.25			
	1017126				
	lx	37.77	44.38	49.04	54.75
	ly	18.95			
	1917120				
	lx	32.91	38.1	41.68	45.96
	ly	11.18			
	1917121				
	lx	26.15	29.15	31.1	33.3
	ly	9.64			

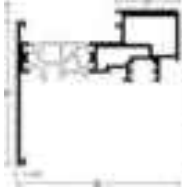
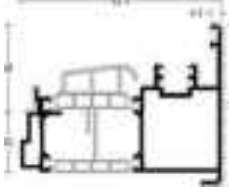
	Artikel-Nr. / Article-no.				
	lx	eff (cm ⁴) nach IfBt-Richtlinien eff (cm ⁴) acc. to IfBt guidelines			
	ly	add (cm ⁴) add (cm ⁴)			
Stützweite L ab (cm) Bearing span L from (cm)					
200 250 300 400					
	1917122				
	lx	37.42	43.81	48.29	53.76
	ly	15.18			
	1917124				
	lx	31.05	37.65	42.57	48.93
	ly	14.9			
	1917126				
	lx	30.62	37.18	42.08	48.42
	ly	15.88			
	1917167				
	lx	33.03	36.72	39.09	41.77
	ly	13.17			

WICLINE 75

Kämpfer, Sprossenprofile
Transom, glazing bar profiles

Statische Werte
Statical values

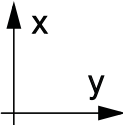
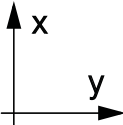
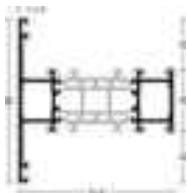
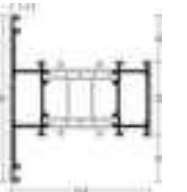
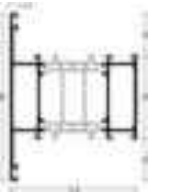
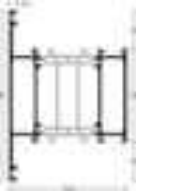
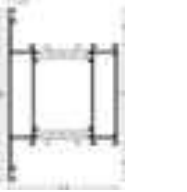
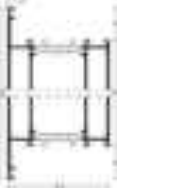
		Artikel-Nr. / Article-no.				
		lx	eff (cm ⁴) nach IfBt-Richtlinien eff (cm ⁴) acc. to IfBt guidelines			
		ly	add (cm ⁴) add (cm ⁴)			
		Stützweite L ab (cm) Bearing span L from (cm)				
			200	250	300	400
	1017203					
	lx	27.56	30.72	32.77	35.09	
	ly	12.13				
	1017204					
	lx	30.47	34.37	36.94	39.91	
	ly	19.2				
	1017205					
	lx	33.11	37.76	40.88	44.55	
	ly	28.84				
	1017206					
	lx	35.53	40.93	44.62	49.02	
	ly	41.33				
	1017207					
	lx	37.75	43.91	48.18	53.34	
	ly	57				
	1017209					
	lx	42.48	50.44	56.16	63.3	
	ly	100.21				

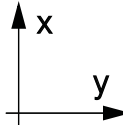
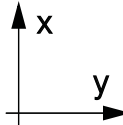
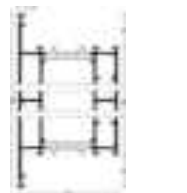
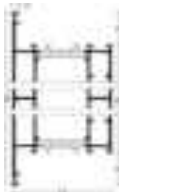
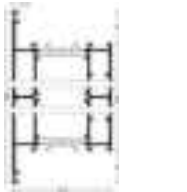
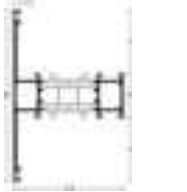
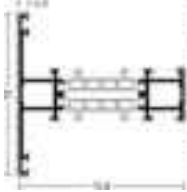
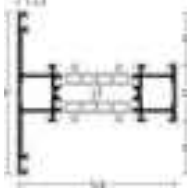
		Artikel-Nr. / Article-no.				
		lx	eff (cm ⁴) nach IfBt-Richtlinien eff (cm ⁴) acc. to IfBt guidelines			
		ly	add (cm ⁴) add (cm ⁴)			
		Stützweite L ab (cm) Bearing span L from (cm)				
			200	250	300	400
	1017213					
	lx	45.5	62.97	72.28	84.74	
	ly	246.21				
	1017215					
	lx	45.51	67.54	78.32	93.1	
	ly	353.75				
	1017220					
	lx	45.13	66.8	92.2	113.54	
	ly	769.17				
	1017231					
	lx	30.67	34.48	36.98	39.84	
	ly	33.41				
	1917201					
	lx	25.14	27.74	29.39	31.24	
	ly	8.52				
	1917202					
	lx	26.11	29.1	31.03	33.22	
	ly	10.45				

WICLINE 75

Kämpfer, Sprossenprofile
Transom, glazing bar profiles

Statische Werte
Statical values

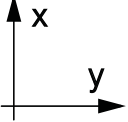
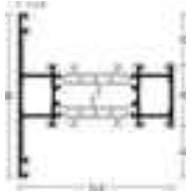
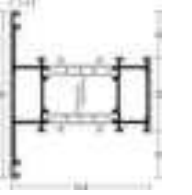
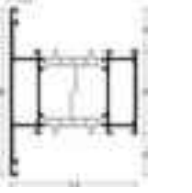
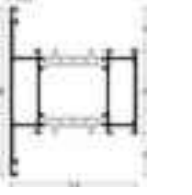
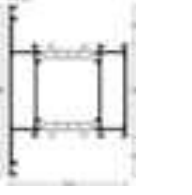
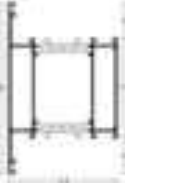
	Artikel-Nr. / Article-no.				
	lx	eff (cm ⁴) nach IfBt-Richtlinien eff (cm ⁴) acc. to IfBt guidelines			
	ly	add (cm ⁴) add (cm ⁴)			
Stützweite L ab (cm) Bearing span L from (cm)					
200 250 300 400					
	1917203				
	lx	25.56	29.1	31.47	34.24
	ly	12.13			
	1917204				
	lx	28.05	32.36	35.31	38.82
	ly	19.2			
	1917205				
	lx	30.28	35.35	38.89	43.19
	ly	28.84			
	1910149				
	lx	30.28	35.35	38.89	43.19
	ly	28.84			
	1917206				
	lx	32.3	38.12	42.26	47.38
	ly	41.33			
	1917207				
	lx	34.13	40.69	45.44	51.41
	ly	57			

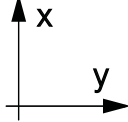
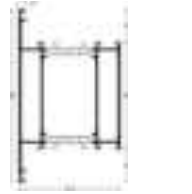
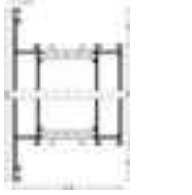
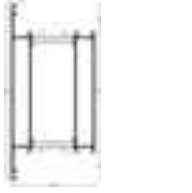
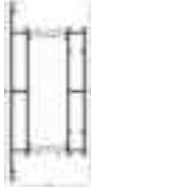
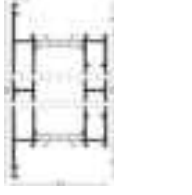
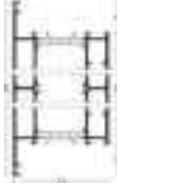
	Artikel-Nr. / Article-no.				
	lx	eff (cm ⁴) nach IfBt-Richtlinien eff (cm ⁴) acc. to IfBt guidelines			
	ly	add (cm ⁴) add (cm ⁴)			
Stützweite L ab (cm) Bearing span L from (cm)					
200 250 300 400					
	1917208				
	lx	39.68	46.96	52.15	58.6
	ly	76.91			
	1917209				
	lx	37.94	46.24	52.47	60.6
	ly	100.21			
	1917211				
	lx	40.72	50.45	57.97	68.05
	ly	160			
	1917213				
	lx	44.45	56.48	66.21	79.91
	ly	246.21			
	1917215				
	lx	46.73	60.15	71.27	87.32
	ly	353.75			
	1917220				
	lx	51.2	67.9	82.53	105.02
	ly	769.17			

WICLINE 75

Kämpfer, Sprossenprofile
Transom, glazing bar profiles

Statische Werte
Statical values

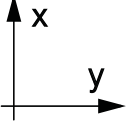
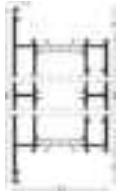
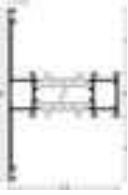
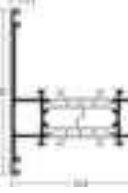
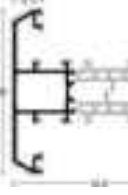
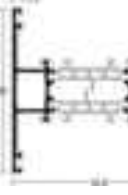
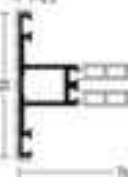

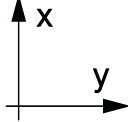
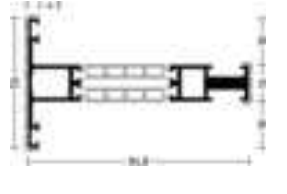
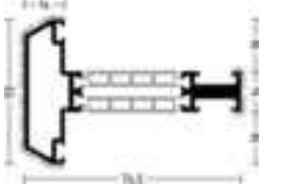
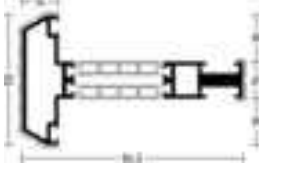
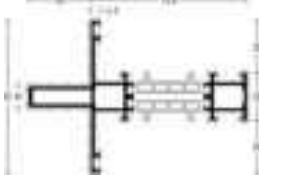
		Artikel-Nr. / Article-no.				
		lx	eff (cm ⁴) nach IfBt-Richtlinien eff (cm ⁴) acc. to IfBt guidelines			
		ly	add (cm ⁴) add (cm ⁴)			
		Stützweite L ab (cm) Bearing span L from (cm)				
			200	250	300	400
	1917224					
	lx	55.02	74.41	92.03	120.36	
	ly	1281.31				
	1917231					
	lx	30.21	34.11	36.67	39.64	
	ly	33.41				
	1917235					
	lx	28.23	31.69	33.96	36.55	
	ly	17.8				
	1917334					
	lx	34.24	39.26	42.66	46.68	
	ly	18.72				
	1917331					
	lx	33.65	38.78	42.29	46.47	
	ly	12.69				
	1917336					
	lx	22.41	24.5	25.81	27.25	
	ly	2.93				

		Artikel-Nr. / Article-no.				
		lx	eff (cm ⁴) nach IfBt-Richtlinien eff (cm ⁴) acc. to IfBt guidelines			
		ly	add (cm ⁴) add (cm ⁴)			
		Stützweite L ab (cm) Bearing span L from (cm)				
			200	250	300	400
	1917337					
	lx	28.53	32.13	34.49	37.22	
	ly	3.06				
	1917338					
	lx	21.78	23.94	25.3	26.82	
	ly	5.09				
	1917339					
	lx	30.1	33.47	35.63	38.08	
	ly	5.23				
	1010452					
	lx	35.72	40.33	43.37	46.88	
	ly	8.7				

WICLINE 75

Stützenprofile
Mullion profiles for windows

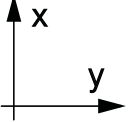
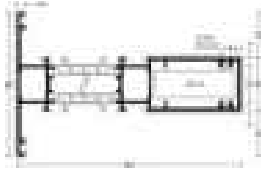
Statische Werte
Statical values

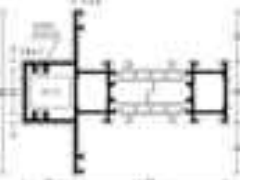
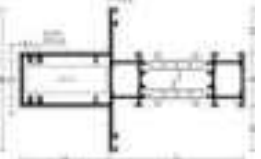
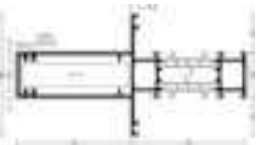
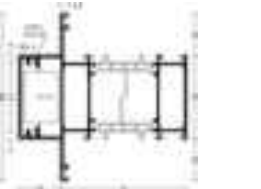
	Artikel-Nr. / Article-no.				
	lx	eff (cm ⁴) nach IfBt-Richtlinien eff (cm ⁴) acc. to IfBt guidelines			
	ly	add (cm ⁴) add (cm ⁴)			
Stützweite L ab (cm) Bearing span L from (cm)					
200 250 300 400					
	1917241				
	lx	85.63	100.87	111.66	124.95
	ly	17.1			
	1917244				
	lx	72.42	82.04	88.41	95.82
	ly	7.52			
	1917246				
	lx	42.74	49.04	53.3	58.34
	ly	15.14			
	1917247				
	lx	72.02	81.78	88.27	95.84
	ly	17.1			
	1917248				
	lx	118.83	133.3	142.74	153.55
	ly	18.89			
	1917249				
	lx	51.92	61.22	67.82	75.96
	ly	38.42			

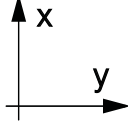
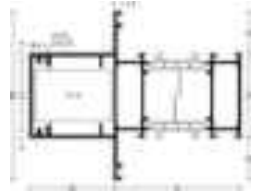
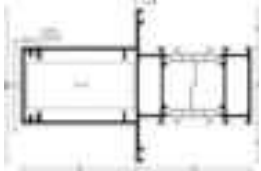
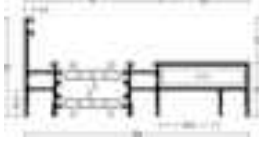
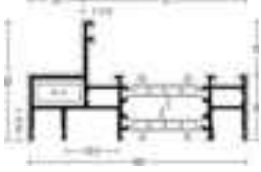
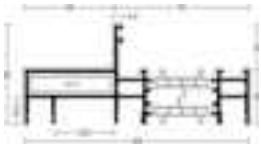
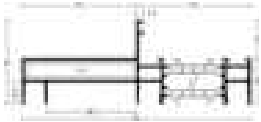
	Artikel-Nr. / Article-no.				
	lx	eff (cm ⁴) nach IfBt-Richtlinien eff (cm ⁴) acc. to IfBt guidelines			
	ly	add (cm ⁴) add (cm ⁴)			
Stützweite L ab (cm) Bearing span L from (cm)					
200 250 300 400					
	1917250				
	lx	86.92	101.38	111.45	123.66
	ly	44.46			
	1917251				
	lx	141.78	163.25	177.88	195.29
	ly	49.69			
	1917256				
	lx	77.16	89.42	97.87	108.03
	ly	8.04			
	1917258				
	lx	41.05	46.95	50.92	55.61
	ly	6.97			
	1917259				
	lx	69.81	79.39	85.79	93.26
	ly	8.09			
	1917260				
	lx	114.51	128.99	138.5	149.45
	ly	8.53			



WICLINE 75

Stützenprofile

Mullion profiles for windows

Statische Werte

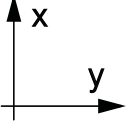
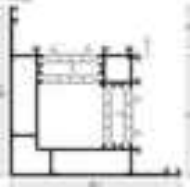
Statical values

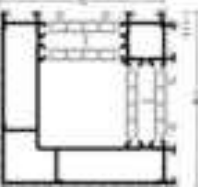
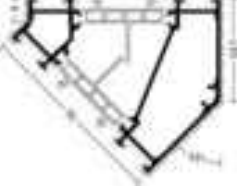

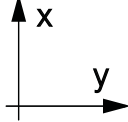
		Artikel-Nr. / Article-no.				
		lx	eff (cm ⁴) nach IfBt-Richtlinien eff (cm ⁴) acc. to IfBt guidelines			
		ly	add (cm ⁴) add (cm ⁴)			
		Stützweite L ab (cm) Bearing span L from (cm)				
			200	250	300	400
		1917270				
		lx	66.84	66.84	66.84	77.64
		ly	68.47			
		1917271				
		lx	58.39	66.52	70.88	75.82
		ly	66.63			
		1917272				
		lx	51.27	54.5	56.43	58.5
		ly	49.11			
		1917273				
		lx	24	26.46	28.02	29.77
		ly	14.25			



		Artikel-Nr. / Article-no.				
		lx	eff (cm ⁴) nach IfBt-Richtlinien eff (cm ⁴) acc. to IfBt guidelines			
		ly	add (cm ⁴) add (cm ⁴)			
		Stützweite L ab (cm) Bearing span L from (cm)				
			200	250	300	400

WICLINE 75

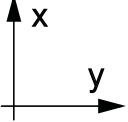
Schwellenprofile
Threshold profiles

Statische Werte
Statical values

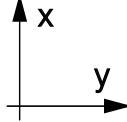
		Artikel-Nr. / Article-no.				
		lx	eff (cm ⁴) nach IfBt-Richtlinien eff (cm ⁴) acc. to IfBt guidelines			
		ly	add (cm ⁴) add (cm ⁴)			
		Stützweite L ab (cm) Bearing span L from (cm)				
			200	250	300	400
		1917304				
		lx	14.58	16.7	18.12	19.8
		ly	.57			
		1917305				
		lx	14.18	16.3	17.73	19.44
		ly	.56			

		Artikel-Nr. / Article-no.				
		lx	eff (cm ⁴) nach IfBt-Richtlinien eff (cm ⁴) acc. to IfBt guidelines			
		ly	add (cm ⁴) add (cm ⁴)			
		Stützweite L ab (cm) Bearing span L from (cm)				
			200	250	300	400

WICLINE 75

Bauanschlussprofile
Profiles for junction to structure

Statische Werte
Statical values

Artikel-Nr. / Article-no.	
lx	eff (cm ⁴) nach IfBt-Richtlinien eff (cm ⁴) acc. to IfBt guidelines
ly	add (cm ⁴) add (cm ⁴)
Stützweite L ab (cm) Bearing span L from (cm)	
200 250 300 400	

1917307	
lx	57.35 65.57 71.1 77.62
ly	19.65

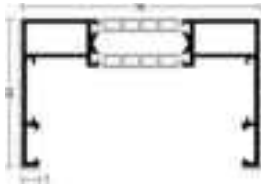



Artikel-Nr. / Article-no.	
lx	eff (cm ⁴) nach IfBt-Richtlinien eff (cm ⁴) acc. to IfBt guidelines
ly	add (cm ⁴) add (cm ⁴)
Stützweite L ab (cm) Bearing span L from (cm)	
200 250 300 400	

WICLINE 75

Aufsatzprofile
Supplementary profiles

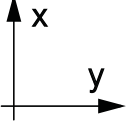
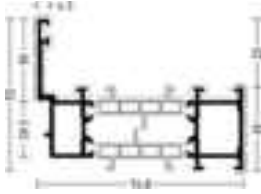
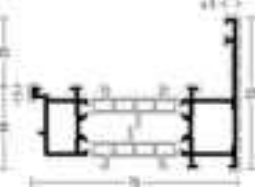
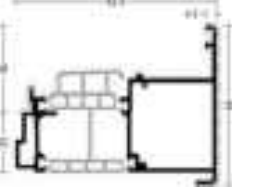
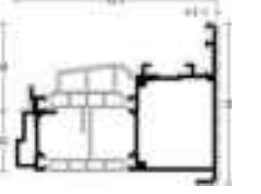
Statische Werte
Statical values

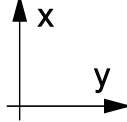
	Artikel-Nr. / Article-no.				
	lx	eff (cm ⁴) nach IfBt-Richtlinien eff (cm ⁴) acc. to IfBt guidelines			
	ly	add (cm ⁴) add (cm ⁴)			
		Stützweite L ab (cm) Bearing span L from (cm)			
		200	250	300	400
	1917301				
	lx	21.78	24.5	26.28	28.33
	ly	5.46			
	1917303				
	lx	20.76	23.27	24.91	26.78
	ly	6.26			
	1917165				
	lx	30.79	34.63	37.14	40.04
	ly	13.29			
	1917166				
	lx	32.85	36.48	38.81	41.43
	ly	14.13			

	Artikel-Nr. / Article-no.				
	lx	eff (cm ⁴) nach IfBt-Richtlinien eff (cm ⁴) acc. to IfBt guidelines			
	ly	add (cm ⁴) add (cm ⁴)			
		Stützweite L ab (cm) Bearing span L from (cm)			
		200	250	300	400
	1010463				
	lx	9.45	10.20	10.66	11.17
	ly	1.15			
	1010464				
	lx	14.02	15.40	16.27	17.23
	ly	2.25			

WICLINE 75

Zusatzprofile
Additional profiles

Statische Werte
Statical values

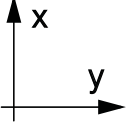
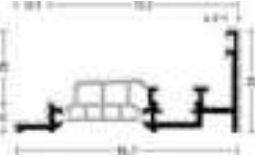
Artikel-Nr. / Article-no.																					
	<table border="1"> <tr> <td>lx</td> <td colspan="4">eff (cm⁴) nach IfBt-Richtlinien eff (cm⁴) acc. to IfBt guidelines</td> </tr> <tr> <td>ly</td> <td colspan="4">add (cm⁴) add (cm⁴)</td> </tr> <tr> <td></td> <td colspan="4">Stützweite L ab (cm) Bearing span L from (cm)</td> </tr> <tr> <td></td> <td>200</td> <td>250</td> <td>300</td> <td>400</td> </tr> </table>	lx	eff (cm ⁴) nach IfBt-Richtlinien eff (cm ⁴) acc. to IfBt guidelines				ly	add (cm ⁴) add (cm ⁴)					Stützweite L ab (cm) Bearing span L from (cm)					200	250	300	400
	lx	eff (cm ⁴) nach IfBt-Richtlinien eff (cm ⁴) acc. to IfBt guidelines																			
ly	add (cm ⁴) add (cm ⁴)																				
	Stützweite L ab (cm) Bearing span L from (cm)																				
	200	250	300	400																	
	<p>1010374</p> <table border="1"> <tr> <td>lx</td> <td>17.59</td> <td>18.71</td> <td>19.37</td> <td>20.09</td> </tr> <tr> <td>ly</td> <td colspan="4">2.38</td> </tr> </table>	lx	17.59	18.71	19.37	20.09	ly	2.38													
lx	17.59	18.71	19.37	20.09																	
ly	2.38																				

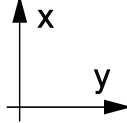
Artikel-Nr. / Article-no.																					
	<table border="1"> <tr> <td>lx</td> <td colspan="4">eff (cm⁴) nach IfBt-Richtlinien eff (cm⁴) acc. to IfBt guidelines</td> </tr> <tr> <td>ly</td> <td colspan="4">add (cm⁴) add (cm⁴)</td> </tr> <tr> <td></td> <td colspan="4">Stützweite L ab (cm) Bearing span L from (cm)</td> </tr> <tr> <td></td> <td>200</td> <td>250</td> <td>300</td> <td>400</td> </tr> </table>	lx	eff (cm ⁴) nach IfBt-Richtlinien eff (cm ⁴) acc. to IfBt guidelines				ly	add (cm ⁴) add (cm ⁴)					Stützweite L ab (cm) Bearing span L from (cm)					200	250	300	400
	lx	eff (cm ⁴) nach IfBt-Richtlinien eff (cm ⁴) acc. to IfBt guidelines																			
ly	add (cm ⁴) add (cm ⁴)																				
	Stützweite L ab (cm) Bearing span L from (cm)																				
	200	250	300	400																	

WICLINE 75

Zusatzprofile
Additional profiles

Statische Werte
Statical Values

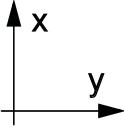
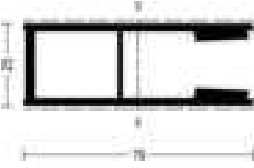
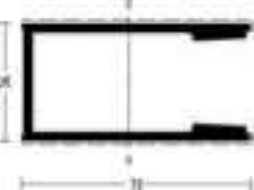

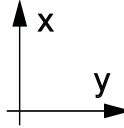

		Artikel-Nr. / Article-no.			
		lx	add (cm ⁴)	Wx	add (cm ³)
		ly	add (cm ⁴)	Wy	add (cm ³)
		3091041			
		lx	25.86	Wx	7.33
		ly	5.36	Wy	4.29
		3091058			
		lx	30.56	Wx	8.2
		ly	13.4	Wy	7.44

		Artikel-Nr. / Article-no.			
		lx	add (cm ⁴)	Wx	add (cm ³)
		ly	add (cm ⁴)	Wy	add (cm ³)

WICLINE 75

Eckwinkelzuschnitt / Auswahltabellen
Cutting corner angle / Selection tables

Profile
Profiles

			
Profil-Nr. Profil-No.			
<input checked="" type="checkbox"/> 1010344	3900049	13.2 mm	5930003
<input type="checkbox"/>	3900049	13.2 mm	5930003
1010346	3900050	13.2 mm	5930003
	3900050	13.2 mm	5930003
1010452	3000074	13.2 mm	5930003
	3000074	13.2 mm	5930003
1010453	3000074	5.9 mm	5930019
	3000074	12.1 mm	5930019
1017001	3000074	13.2 mm	5930003
	3000074	13.2 mm	5930003
1017003	3900049	13.2 mm	5930003
	3900049	13.2 mm	5930003
1017004	3900050	13.2 mm	5930003
	3900050	13.2 mm	5930003
1017005	3900051	13.2 mm	5930003
	3900051	13.2 mm	5930003
1017006	3900052	13.2 mm	5930003
	3900052	13.2 mm	5930003
1017062	3900030	13.2 mm	5930003
	3900030	13.2 mm	5930003
1017064	3900049	13.2 mm	5930003
	3900049	13.2 mm	5930003
1017066	3900051	13.2 mm	5930003
	3900051	13.2 mm	5930003
1017077	3900049	11.7 mm	5930010
	3900049	13.2 mm	5930010
1017081	3900049	13.2 mm	5930003
	3900049	13.2 mm	5930003
1017082	3900050	13.2 mm	5930003
	3900050	13.2 mm	5930003
1017090	3900049	13.2 mm	5030076
	3900049	13.2 mm	5030076
1017101	3000074	5.9 mm	5930019
	3000074	12.1 mm	5930019

			
Profil-Nr. Profil-No.			
<input checked="" type="checkbox"/> 1017102	3900049	5.9 mm	5930019
<input type="checkbox"/>	3900049	12.1 mm	5930019
1017103	3900050	5.9 mm	5930019
	3900050	12.1 mm	5930019
1017104	3900051	5.9 mm	5930019
	3900051	12.1 mm	5930019
1017105	3900052	5.9 mm	5930019
	3900052	12.1 mm	5930019
1017120	3000074	5.9 mm	5930020
	3000074	12.1 mm	5930020
1017203	3900049	13.2 mm	5930003
	3900049	13.2 mm	5930003
1017204	3900050	13.2 mm	5930003
	3900050	13.2 mm	5930003
1017205	3900051	13.2 mm	5930003
	3900051	13.2 mm	5930003
1017206	3900052	13.2 mm	5930003
	3900052	13.2 mm	5930003
1017207	3900053	13.2 mm	5930003
	3900053	13.2 mm	5930003
1017231	3900049	13.2 mm	5930003
	3900049	13.2 mm	5930003
1910134	3000074	7.7 mm	5930010
	3000074	13.2 mm	5930010
1910135	3900049	11.7 mm	5930010
	3900049	13.2 mm	5930010
1910146	3900050	5.9 mm	5930019
	3900050	12.1 mm	5930019
1910147	3900051	5.9 mm	5930019
	3900051	12.1 mm	5930019
1910148	3900051	13.2 mm	5930003
	3900051	13.2 mm	5930003
1910149	3900051	13.2 mm	5930003
	3900051	13.2 mm	5930003

WICLINE 75

Eckwinkelzuschnitt / Auswahltabellen

Cutting corner angle / Selection tables

Profile
Profiles

			
Profil-Nr. Profil-No.			
<input checked="" type="checkbox"/> 1917001	3000074	13.2 mm	5930003
<input type="checkbox"/>	3000074	13.2 mm	5930003
1917002	3900048	13.2 mm	5930003
	3900048	13.2 mm	5930003
1917003	3900049	13.2 mm	5930003
	3900049	13.2 mm	5930003
1917004	3900050	13.2 mm	5930003
	3900050	13.2 mm	5930003
1917005	3900051	13.2 mm	5930003
	3900051	13.2 mm	5930003
1917009	3900049	23.2 mm	5930005
	3900049	13.2 mm	5930005
1917055	3000074	13.2 mm	5930003
	3000074	13.2 mm	5930003
1917056	3900048	13.2 mm	5930003
	3900048	13.2 mm	5930003
1917057	3900049	13.2 mm	5930003
	3900049	13.2 mm	5930003
1917058	3900050	13.2 mm	5930003
	3900050	13.2 mm	5930003
1917059	3900051	13.2 mm	5930003
	3900051	13.2 mm	5930003
1917060	3900053	13.2 mm	5930003
	3900053	13.2 mm	5930003
1917062	3900030	13.2 mm	5930003
	3900030	13.2 mm	5930003
1917064	3900049	13.2 mm	5930003
	3900049	13.2 mm	5930003
1917067	3900052	13.2 mm	5930003
	3900052	13.2 mm	5930003
1917068	3000074	13.2 mm	5930003
	3000074	13.2 mm	5930003
1917069	3900049	13.2 mm	5930003
	3900049	13.2 mm	5930003

			
Profil-Nr. Profil-No.			
<input checked="" type="checkbox"/> 1917073	3900049	13.2 mm	5930003
<input type="checkbox"/>	3900049	13.2 mm	5930003
1917076	3000074	7.7 mm	5930010
	3000074	13.2 mm	5930010
1917077	3900049	11.7 mm	5930010
	3900049	13.2 mm	5930010
1917081	3900049	13.2 mm	5930003
	3900049	13.2 mm	5930003
1917082	3900050	13.2 mm	5930003
	3900050	13.2 mm	5930003
1917086	3900049	13.2 mm	5930003
	3900049	13.2 mm	5930003
1917089	3000074	7.7 mm	5930009
	3000074	13.2 mm	5930009
1917092	3000074	7.8 mm	5930026
	3900014	26.8 mm	5930026
1917093	3900066	11.7 mm	5930027
	3900015	13.8 mm	5930027
1917101	3000074	5.9 mm	5930019
	3000074	12.1 mm	5930019
1917102	3900049	5.9 mm	5930019
	3900049	12.1 mm	5930019
1917103	3900050	5.9 mm	5930019
	3900050	12.1 mm	5930019
1917104	3900051	5.9 mm	5930019
	3900051	12.1 mm	5930019
1917105	3000074	5.9 mm	5930019
	3000074	12.1 mm	5930019
1917115	3900052	5.9 mm	5930019
	3900052	12.1 mm	5930019
1917116	3900050	5.9 mm	5930019
	3900050	12.1 mm	5930019
1917117	3900051	5.9 mm	5930019
	3900051	12.1 mm	5930019







WICLINE 75







Eckwinkelzuschnitt / Auswahltabellen







Cutting corner angle / Selection tables

Profile
Profiles

			
Profil-Nr. Profil-No.			
<input checked="" type="checkbox"/> 1917118	3900052	5.9 mm	5930019
<input type="checkbox"/>	3900052	12.1 mm	5930019
1917120	3000074	5.9 mm	5930020
	3000074	12.1 mm	5930020
1917122	3000074	5.9 mm	5930020
	3000074	12.1 mm	5930020
1917161	4950037	--	5930028
	3900051	16.4 mm	5930028
1917163	3900051	9.8 mm	5930028
	3900051	17.8 mm	5930028
1917165	4950035	--	5930029
	3900015	26.8 mm	5930029
1917166	4950035	--	5930029
	3900015	26.8 mm	5930029
1917201	3000074	13.2 mm	5930003
	3000074	13.2 mm	5930003
1917202	3900048	13.2 mm	5930003
	3900048	13.2 mm	5930003
1917203	3900049	13.2 mm	5930003
	3900049	13.2 mm	5930003
1917204	3900050	13.2 mm	5930003
	3900050	13.2 mm	5930003
1917205	3900051	13.2 mm	5930003
	3900051	13.2 mm	5930003
1917206	3900052	13.2 mm	5930003
	3900052	13.2 mm	5930003
1917207	3900053	13.2 mm	5930003
	3900053	13.2 mm	5930003
1917231	3900049	13.2 mm	5930003
	3900049	13.2 mm	5930003
1917235	3900049	13.2 mm	5930003
	3900049	13.2 mm	5930003
1917241	3900049	13.2 mm	5930003
	3900049	13.2 mm	5930003

			
Profil-Nr. Profil-No.			
<input checked="" type="checkbox"/> 1917244	3900049	13.2 mm	5930003
<input type="checkbox"/>	3900049	13.2 mm	5930003
1917246	3900049	13.2 mm	5930003
	3900049	13.2 mm	5930003
1917247	3900049	13.2 mm	5930003
	3900049	13.2 mm	5930003
1917248	3900049	13.2 mm	5930003
	3900049	13.2 mm	5930003
1917249	3900051	13.2 mm	5930003
	3900051	13.2 mm	5930003
1917250	3900051	13.2 mm	5930003
	3900051	13.2 mm	5930003
1917251	3900051	13.2 mm	5930003
	3900051	13.2 mm	5930003
1917256	3900030	13.2 mm	5930003
	3900030	13.2 mm	5930003
1917258	3900030	13.2 mm	5930003
	3900030	13.2 mm	5930003
1917259	3900030	13.2 mm	5930003
	3900030	13.2 mm	5930003
1917260	3900030	13.2 mm	5930003
	3900030	13.2 mm	5930003

			
Profil-Nr. Profil-No.			
<input checked="" type="checkbox"/> 1917301	3900049	9.2 mm	5930003
<input checked="" type="checkbox"/>	3900049	13.2 mm	5930003
1917303	3900049	13.2 mm	5930003
	3900049	9.2 mm	5930003

			
Profil-Nr. Profil-No.			
<input checked="" type="checkbox"/> 1917331	3900049	13.2 mm	5930005
<input checked="" type="checkbox"/>	3900049	13.2 mm	5930005
1917334	3900049	23.2 mm	5930003
	3900049	13.2 mm	5930003

Hinweis:

Die ausgewiesenen Gusseckwinkel in den Datenspalten der Programm-Seiten können wie nachfolgend aufgeführt durch Al-Strangpresseckwinkel im „Selbstzuschnitt“ und Prestaverbindung (Stanzverbindung) ersetzt werden. Die konventionelle Verklebung ist mit 2-komponenten Klebstoff 5070000 oder 2-komponenten Epoxid-Klebstoff 5070002 auszuführen.

Siehe Allgemeine Verarbeitungshinweise.

Zuschnittstoleranzen nach DIN ISO 2768,

T1 fein ($\leq 30.0 \text{ mm} \pm 0.1 \text{ mm}$, $> 30.0 \text{ mm} \pm 0.15 \text{ mm}$).

Note:

The specified cast alum. corner angles in head columns of Profile Programme pages can be replaced by extruded alum. corner angles in „self-cut“ and crimping connection (punched connection) as listed. The conventional gluing should be carried out with 2-component glue 5070000 or 2-component Epoxide glue 5070002.

See general processing hints.

Cutting tolerance according to DIN ISO 2768,



T1 fine ($\leq 30.0 \text{ mm} \pm 0.1 \text{ mm}$, $> 30.0 \text{ mm} \pm 0.15 \text{ mm}$).

WICLINE 75

Zuordnung Gelenkeckwinkel, vertikal
Assignment hinged corner angle, vertical

Profile
Profiles

				
Profil-Nr. Profil-No.				
<input checked="" type="checkbox"/>	1010344	4950062	2x4070002	5910010
<input type="checkbox"/>		4950062	2x4070002	5910010
<input checked="" type="checkbox"/>	1010346	4950063	2x4070002	5910010
		4950063	2x4070002	5910010
	1010452	4950060	2x4070002	5910010
		4950060	2x4070002	5910010
	1017001	4950060	2x4070002	5910010
		4950060	2x4070002	5910010
	1017003	4950062	2x4070002	5910010
		4950062	2x4070002	5910010
	1017004	4950063	2x4070002	5910010
		4950063	2x4070002	5910010
	1017064	4950062	2x4070002	5910010
		4950062	2x4070002	5910010
	1017081	4950062	2x4070002	5910010
		4950062	2x4070002	5910010
	1017082	4950063	2x4070002	5910010
		4950063	2x4070002	5910010
	1017101	4950065	2x4070003	5910029
		4950085	2x4070002	5910029
	1017102	4950066	2x4070003	5910029
		4950086	2x4070002	5910029
	1017103	4950067	2x4070003	5910029
		4950087	2x4070002	5910029
	1017203	4950062	2x4070002	5910010
		4950062	2x4070002	5910010
	1017204	4950063	2x4070002	5910010
		4950063	2x4070002	5910010
	1017231	4950062	2x4070002	5910010
		4950062	2x4070002	5910010
	1917001	4950060	2x4070002	5910010
		4950060	2x4070002	5910010
	1917002	4950061	2x4070002	5910010
		4950061	2x4070002	5910010







				
Profil-Nr. Profil-No.				
<input checked="" type="checkbox"/>	1917003	4950062	2x4070002	5910010
<input type="checkbox"/>		4950062	2x4070002	5910010
	1917004	4950063	2x4070002	5910010
		4950063	2x4070002	5910010
	1917055	4950060	2x4070002	5910010
		4950060	2x4070002	5910010
	1917056	4950061	2x4070002	5910010
		4950061	2x4070002	5910010
	1917057	4950062	2x4070002	5910010
		4950062	2x4070002	5910010
	1917058	4950063	2x4070002	5910010
		4950063	2x4070002	5910010
	1917064	4950062	2x4070002	5910010
		4950062	2x4070002	5910010
	1917068	4950060	2x4070002	5910010
		4950060	2x4070002	5910010
	1917069	4950062	2x4070002	5910010
		4950062	2x4070002	5910010
	1917073	4950062	2x4070002	5910010
		4950062	2x4070002	5910010
	1917081	4950062	2x4070002	5910010
		4950062	2x4070002	5910010
	1917082	4950063	2x4070002	5910010
		4950063	2x4070002	5910010
	1917086	4950062	2x4070002	5910010
		4950062	2x4070002	5910010
	1917101	4950065	2x4070003	5910029
		4950085	2x4070002	5910029
	1917102	4950066	2x4070003	5910029
		4950086	2x4070002	5910029
	1917103	4950067	2x4070003	5910029
		4950087	2x4070002	5910029
	1917105	4950065	2x4070003	5910029
		4950085	2x4070002	5910029

WICLINE 75

Zuordnung Gelenkeckwinkel, vertikal
Assignement hinged corner angle, vertical

Profile
Profiles

			
Profil-Nr. Profil-No.		 	
<input checked="" type="checkbox"/> <input type="checkbox"/>	1917201	4950060	2x4070002
<input type="checkbox"/> <input checked="" type="checkbox"/>		4950060	2x4070002
	1917202	4950061	2x4070002
		4950061	2x4070002
	1917203	4950062	2x4070002
		4950062	2x4070002
	1917204	4950063	2x4070002
		4950063	2x4070002
	1917231	4950062	2x4070002
		4950062	2x4070002
	1917241	4950062	2x4070002
		4950062	2x4070002
	1917244	4950062	2x4070002
		4950062	2x4070002
	1917246	4950062	2x4070002
		4950062	2x4070002
	1917247	4950062	2x4070002
		4950062	2x4070002
	1917248	4950062	2x4070002
		4950062	2x4070002

			
Profil-Nr. Profil-No.		 	
<input checked="" type="checkbox"/> <input type="checkbox"/>			
<input type="checkbox"/> <input checked="" type="checkbox"/>			

WICLINE 75

Zuordnung Gelenkeckwinkel, horizontal
Assignment hinged corner angle, horizontal

Profile
Profiles

				
Profil-Nr. Profil-No.				
<input checked="" type="checkbox"/>	1010344	4950078	2x4070002	5910012
<input type="checkbox"/>		4950078	2x4070002	5910012
	1010346	4950079	2x4070002	5910012
		4950079	2x4070002	5910012
	1010452	4950076	2x4070002	5910012
		4950076	2x4070002	5910012
	1017001	4950076	2x4070002	5910012
		4950076	2x4070002	5910012
	1017003	4950078	2x4070002	5910012
		4950078	2x4070002	5910012
	1017004	4950079	2x4070002	5910012
		4950079	2x4070002	5910012
	1017062	4950075	2x4070002	5910012
		4950075	2x4070002	5910012
	1017064	4950078	2x4070002	5910012
		4950078	2x4070002	5910012
	1017081	4950078	2x4070002	5910012
		4950078	2x4070002	5910012
	1017082	4950079	2x4070002	5910012
		4950079	2x4070002	5910012
	1017203	4950078	2x4070002	5910012
		4950078	2x4070002	5910012
	1017204	4950079	2x4070002	5910012
		4950079	2x4070002	5910012
	1017231	4950078	2x4070002	5910012
		4950078	2x4070002	5910012
	1917001	4950076	2x4070002	5910012
		4950076	2x4070002	5910012
	1917002	4950077	2x4070002	5910012
		4950077	2x4070002	5910012
	1917003	4950078	2x4070002	5910012
		4950078	2x4070002	5910012
	1917004	4950079	2x4070002	5910012
		4950079	2x4070002	5910012







				
Profil-Nr. Profil-No.				
<input checked="" type="checkbox"/>	1917055	4950076	2x4070002	5910012
<input type="checkbox"/>		4950076	2x4070002	5910012
	1917056	4950077	2x4070002	5910012
		4950077	2x4070002	5910012
	1917057	4950078	2x4070002	5910012
		4950078	2x4070002	5910012
	1917058	4950079	2x4070002	5910012
		4950079	2x4070002	5910012
	1917062	4950075	2x4070002	5910012
		4950075	2x4070002	5910012
	1917064	4950078	2x4070002	5910012
		4950078	2x4070002	5910012
	1917068	4950076	2x4070002	5910012
		4950076	2x4070002	5910012
	1917069	4950078	2x4070002	5910012
		4950078	2x4070002	5910012
	1917073	4950078	2x4070002	5910012
		4950078	2x4070002	5910012
	1917081	4950078	2x4070002	5910012
		4950078	2x4070002	5910012
	1917082	4950079	2x4070002	5910012
		4950079	2x4070002	5910012
	1917086	4950078	2x4070002	5910012
		4950078	2x4070002	5910012
	1917201	4950076	2x4070002	5910012
		4950076	2x4070002	5910012
	1917202	4950077	2x4070002	5910012
		4950077	2x4070002	5910012
	1917203	4950078	2x4070002	5910012
		4950078	2x4070002	5910012
	1917204	4950079	2x4070002	5910012
		4950079	2x4070002	5910012
	1917231	4950078	2x4070002	5910012
		4950078	2x4070002	5910012

WICLINE 75

Zuordnung Gelenkeckwinkel, horizontal
Assignement hinged corner angle, horizontal

Profile
Profiles

				
Profil-Nr. Profil-No.				
<input checked="" type="checkbox"/>	1917241	4950078	2x4070002	5910012
<input type="checkbox"/>		4950078	2x4070002	5910012
	1917244	4950078	2x4070002	5910012
		4950078	2x4070002	5910012
	1917246	4950078	2x4070002	5910012
		4950078	2x4070002	5910012
	1917247	4950078	2x4070002	5910012
		4950078	2x4070002	5910012
	1917248	4950078	2x4070002	5910012
		4950078	2x4070002	5910012
	1917256	4950075	2x4070002	5910012
		4950075	2x4070002	5910012
	1917258	4950075	2x4070002	5910012
		4950075	2x4070002	5910012
	1917259	4950075	2x4070002	5910012
		4950075	2x4070002	5910012
	1917260	4950075	2x4070002	5910012
		4950075	2x4070002	5910012

				
Profil-Nr. Profil-No.				
<input checked="" type="checkbox"/>				
<input type="checkbox"/>				

WICLINE 75

Zuordnung Gelenkverbinder
Assignment hinged connector

Profile
Profiles





Profil-Nr. Profil-No.			
			
<input checked="" type="checkbox"/> 1010344	4960047	1x4070002	5910011
<input type="checkbox"/>	4960042	1x4070002	5910011
1010346	4960048	1x4070002	5910011
	4960043	1x4070002	5910011
1010452	4960045	1x4070002	5910011
	4960040	1x4070002	5910011
1017001	4960045	1x4070002	5910011
	4960040	1x4070002	5910011
1017003	4960047	1x4070002	5910011
	4960042	1x4070002	5910011
1017004	4960048	1x4070002	5910011
	4960043	1x4070002	5910011
1017064	4960047	1x4070002	5910011
	4960042	1x4070002	5910011
1017081	4960047	1x4070002	5910011
	4960042	1x4070002	5910011
1017082	4960048	1x4070002	5910011
	4960043	1x4070002	5910011
1017203	4960047	1x4070002	5910011
	4960042	1x4070002	5910011
1017204	4960048	1x4070002	5910011
	4960043	1x4070002	5910011
1017231	4960047	1x4070002	5910011
	4960042	1x4070002	5910011
1917001	4960045	1x4070002	5910011
	4960040	1x4070002	5910011
1917002	4960046	1x4070002	5910011
	4960041	1x4070002	5910011
1917003	4960047	1x4070002	5910011
	4960042	1x4070002	5910011
1917004	4960048	1x4070002	5910011
	4960043	1x4070002	5910011
1917055	4960045	1x4070002	5910011
	4960040	1x4070002	5910011





Profil-Nr. Profil-No.			
			
<input checked="" type="checkbox"/> 1917056	4960046	1x4070002	5910011
<input type="checkbox"/>	4960041	1x4070002	5910011
1917057	4960047	1x4070002	5910011
	4960042	1x4070002	5910011
1917058	4960048	1x4070002	5910011
	4960043	1x4070002	5910011
1917064	4960047	1x4070002	5910011
	4960042	1x4070002	5910011
1917068	4960045	1x4070002	5910011
	4960040	1x4070002	5910011
1917069	4960047	1x4070002	5910011
	4960042	1x4070002	5910011
1917073	4960047	1x4070002	5910011
	4960042	1x4070002	5910011
1917081	4960047	1x4070002	5910011
	4960042	1x4070002	5910011
1917082	4960048	1x4070002	5910011
	4960043	1x4070002	5910011
1917086	4960047	1x4070002	5910011
	4960042	1x4070002	5910011
1917201	4960045	1x4070002	5910011
	4960040	1x4070002	5910011
1917202	4960046	1x4070002	5910011
	4960041	1x4070002	5910011
1917203	4960047	1x4070002	5910011
	4960042	1x4070002	5910011
1917204	4960048	1x4070002	5910011
	4960043	1x4070002	5910011
1917231	4960047	1x4070002	5910011
	4960042	1x4070002	5910011
1917241	4960047	1x4070002	5910011
	4960042	1x4070002	5910011
1917244	4960047	1x4070002	5910011
	4960042	1x4070002	5910011

WICLINE 75

Zuordnung Gelenkverbinder
Assignment hinged connector

Profile
Profiles

			
Profil-Nr. Profil-No.			
<input checked="" type="checkbox"/> 1917246	4960047	1x4070002	5910011
<input type="checkbox"/>	4960042	1x4070002	5910011
1917247	4960047	1x4070002	5910011
	4960042	1x4070002	5910011
1917248	4960047	1x4070002	5910011
	4960042	1x4070002	5910011
1917334	4960047	1x4070002	5910011
	4960042	1x4070002	5910011

			
Profil-Nr. Profil-No.			
<input checked="" type="checkbox"/>			
<input type="checkbox"/>			

WICLINE 75

Sprossenstoßverbindung Glazing bar butt-joint connection

Sprossenprofile Glazing bar profiles

Sprosse / Sprosse
Glazing bar / glazing bar

Profil
Profile
Bohrschablone
Drill template

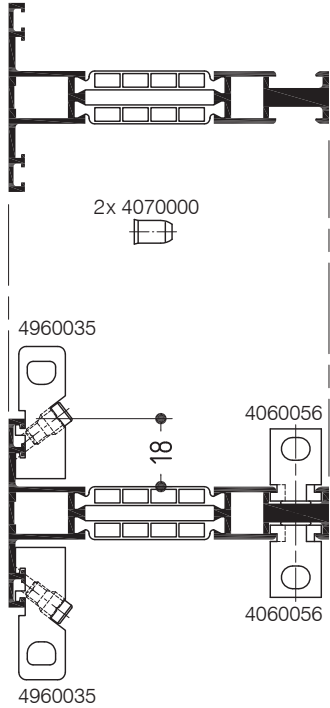

1917337 5910021

1917337 5910009

Sprosse / Sprosse
Glazing bar / glazing bar

Profil
Profile
Bohrschablone
Drill template

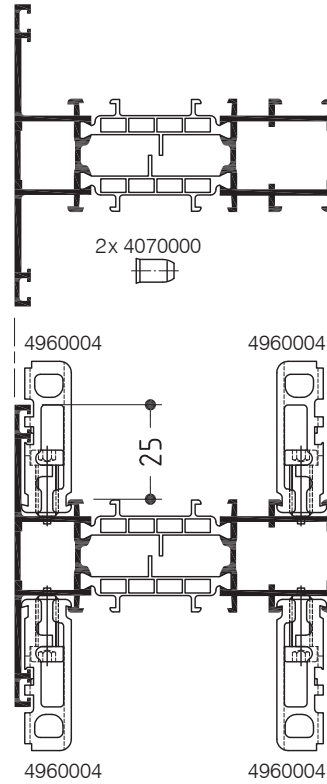

1917331 5910021

1917331 --

Sprosse / Flügel
Glazing bar / Sash

Profil
Profile
Bohrschablone
Drill template

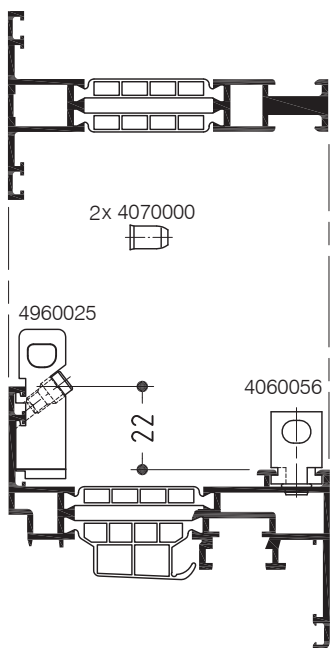

1917337 5910021

1017101
1017102
1017103
1017104
1017105
1017120
1917101
1917102
1917103
1917104
1917115
1917120
5910009

Sprosse / Flügel
Glazing bar / Sash

Profil
Profile
Bohrschablone
Drill template

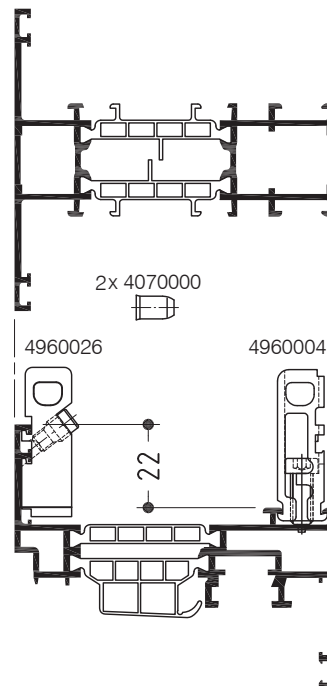

1917331 5910021

1017101
1017102
1017103
1017104
1017105
1017120
1917101
1917102
1917103
1917104
1917115
1917120
--

WICLINE 75

Sprossenstoßverbindung Glazing bar butt-joint connection

Sprossenprofile Glazing bar profiles

Sprosse / Sprosse
Glazing bar / glazing bar

Profil
Profile
Bohrschablone
Drill template

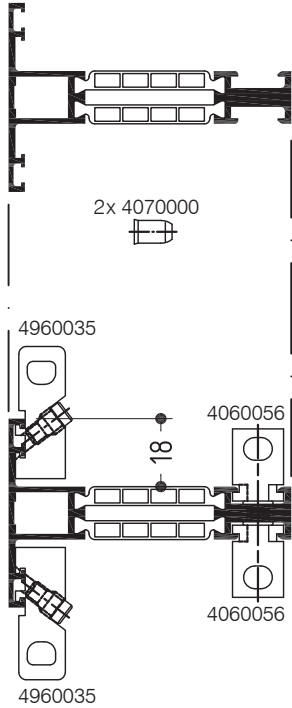

1917336 5910020

1917336 5910009

Sprosse / Sprosse
Glazing bar / glazing bar

Profil
Profile
Bohrschablone
Drill template

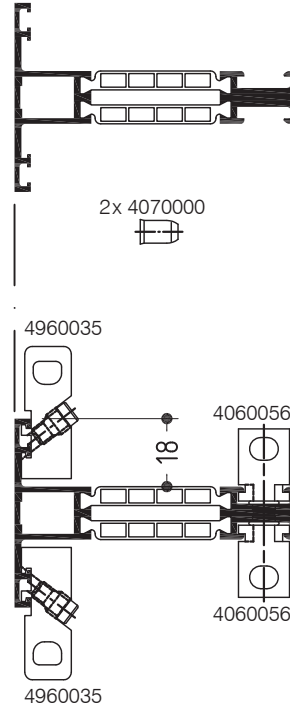

1917336 5910020

1917336 5910009

Sprosse / Blendrahmen
Glazing bar / Frame

Profil
Profile
Bohrschablone
Drill template

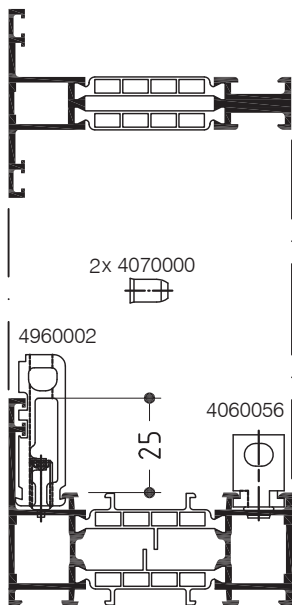

1917336 5910020

1017001
1017003
1017004
1017005
1017006
1017008
1017062
1017064
1017066
1017077
1917001
1917002
1917003
1917004
1917005
1917062
1917064
1917067
1917068
1917069
1917073
1917076
1917077

5910009

Sprosse / Kämpfer
Glazing bar / Transom

Profil
Profile
Bohrschablone
Drill template

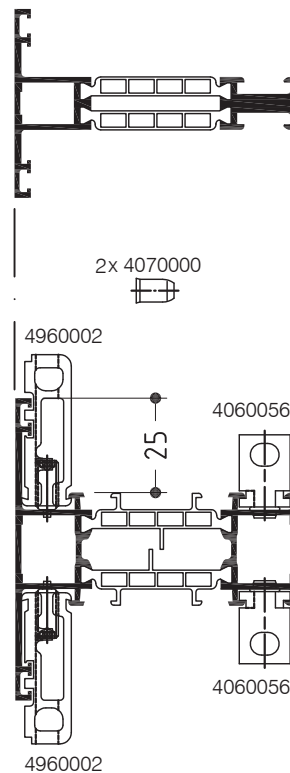

1917336 5910020

1010452
1017203
1017204
1017205
1017206
1017207
1017209
1017213
1017215
1017220
1917201
1917202
1917203
1917204
1917205
1917206
1917207
1917208
1917209
1917211
1917213
1917215
1917220
1917224

5910009

WICLINE 75

Sprossenstoßverbindung Glazing bar butt-joint connection

Sprossenprofile Glazing bar profiles

Sprosse / Sprosse
Glazing bar / glazing bar

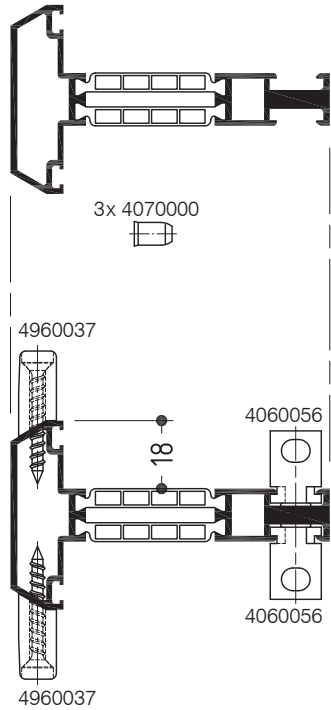

Profil Profile	Bohrschablone Drill template
-------------------	---------------------------------

1917339	5910008 5910020
---------	--------------------

1917339	5910009
---------	---------

Sprosse / Sprosse
Glazing bar / glazing bar

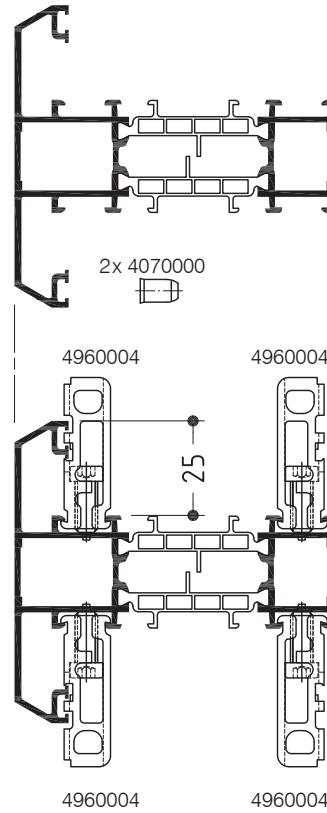

Profil Profile	Bohrschablone Drill template
-------------------	---------------------------------

1917334	5910006
---------	---------

1917334	--
---------	----

Sprosse / Flügel
Glazing bar / Sash

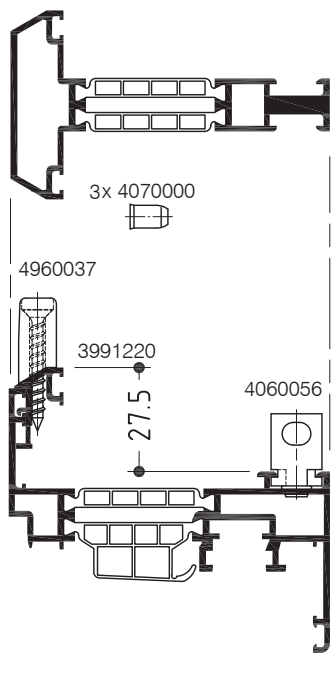

Profil Profile	Bohrschablone Drill template
-------------------	---------------------------------

1917339	5910008 5910020
---------	--------------------

1017101	5910009
1017102	
1017103	
1017104	
1017105	
1017120	
1917101	
1917102	
1917103	
1917104	
1917115	
1917120	

Sprosse / Flügel
Glazing bar / Sash

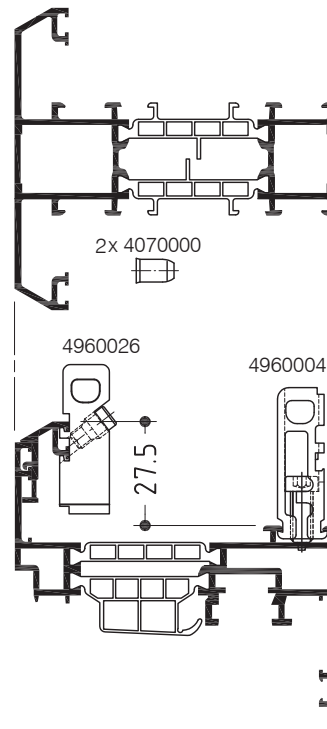

Profil Profile	Bohrschablone Drill template
-------------------	---------------------------------

1917334	5910020
---------	---------

1017101	--
1017102	
1017103	
1017104	
1017105	
1017120	
1917101	
1917102	
1917103	
1917104	
1917115	
1917120	

WICLINE 75

Sprossenstoßverbindung Glazing bar butt-joint connection

Sprossenprofile Glazing bar profiles

Sprosse / Sprosse
Glazing bar / glazing bar

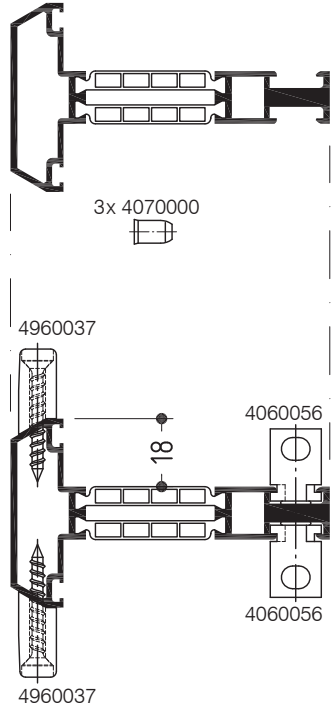

Profil Profile	Bohrschablone Drill template
-------------------	---------------------------------

1917339	5910008 5910020
---------	--------------------

1917339	5910009
---------	---------

Sprosse / Sprosse
Glazing bar / glazing bar

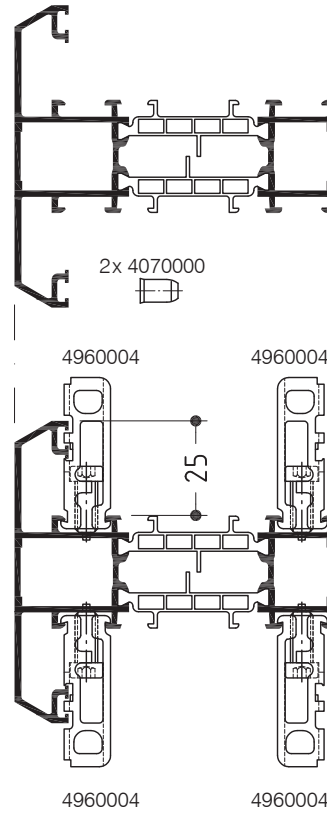

Profil Profile	Bohrschablone Drill template
-------------------	---------------------------------

1917334	5910006
---------	---------

1917334	--
---------	----

Sprosse / Flügel
Glazing bar / Sash

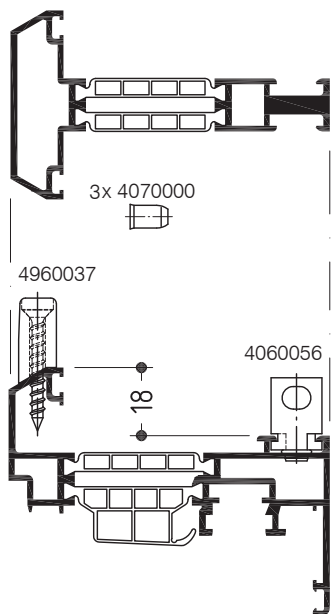

Profil Profile	Bohrschablone Drill template
-------------------	---------------------------------

1917339	5910008 5910020
---------	--------------------

1917105 1917122	5910009
--------------------	---------

Sprosse / Flügel
Glazing bar / Sash

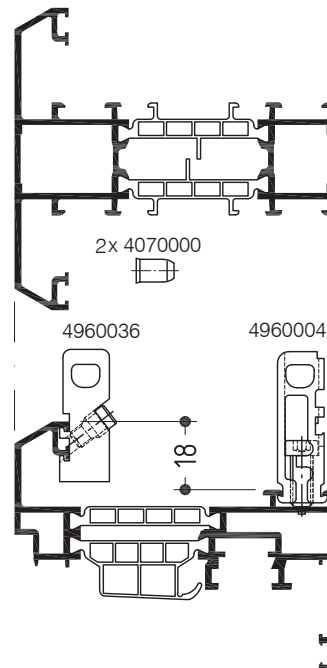

Profil Profile	Bohrschablone Drill template
-------------------	---------------------------------

1917334	5910006
---------	---------

1917105 1917122	--
--------------------	----

WICLINE 75

Sprossenstoßverbindung Glazing bar butt-joint connection

Sprossenprofile Glazing bar profiles

Sprosse / Sprosse
Glazing bar / glazing bar

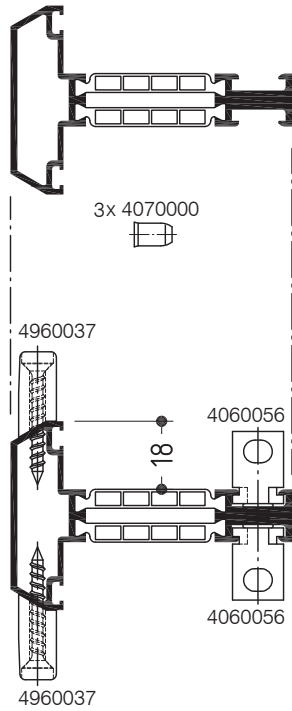

Profil
Profile
Bohrschablone
Drill template

1917338 5910008
5910019

1917338 5910009

Sprosse / Sprosse
Glazing bar / glazing bar

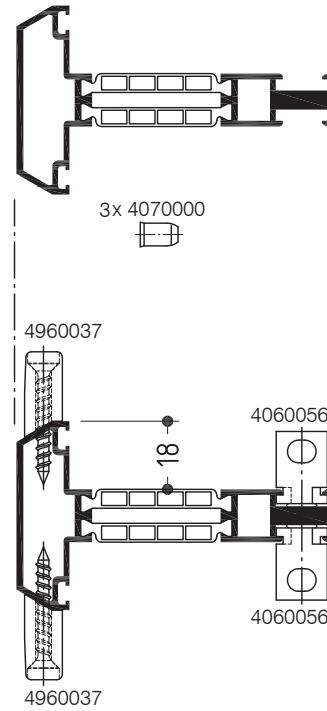

Profil
Profile
Bohrschablone
Drill template

1917339 5910008
5910020

1917339 5910009

Sprosse / Blendrahmen mit
Zusatzprofil
Glazing bar / Frame with
supplementary profile

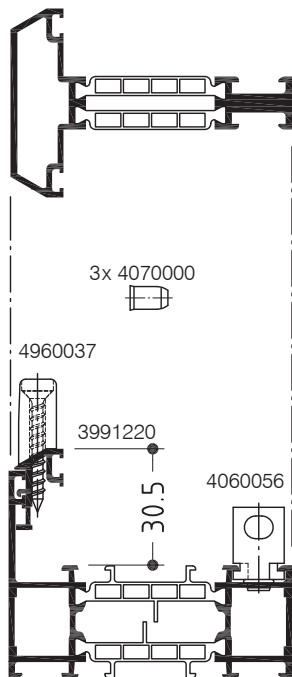

Profil
Profile
Bohrschablone
Drill template

1917338 5910008
5910019

1017001
1017003
1017004
1017005
1017006
1017008
1017050
1017062
1017064
1017066
1017077
1917001
1917002
1917003
1917004
1917005
1917062
1917064
1917067
1917068
1917069
1917073
1917076
1917077

5910009

Sprosse / Blendrahmen
Glazing bar / Frame

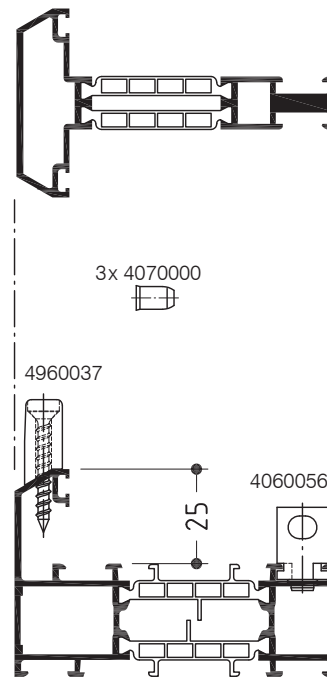

Profil
Profile
Bohrschablone
Drill template

1917339 5910008
5910020

1917009 5910009

WICLINE 75

Sprossenprofile
Glazing bar profiles

Sprossenstoßverbindung
Glazing bar butt-joint connection

Sprosse / Sprosse
Glazing bar / glazing bar

Profil Profile	Bohrschablone Drill template
-------------------	---------------------------------

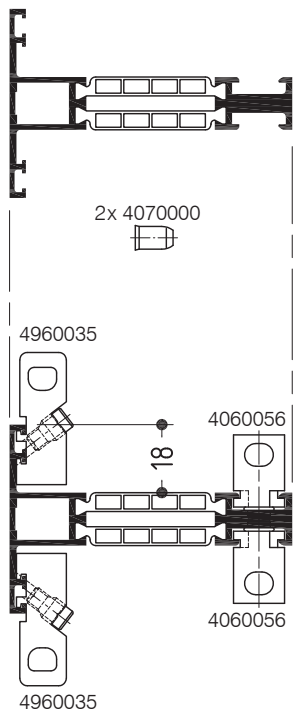

1917336	5910020
---------	---------

1917336	5910009
---------	---------

Sprosse / Blendrahmen
Glazing bar / Frame

Profil Profile	Bohrschablone Drill template
-------------------	---------------------------------

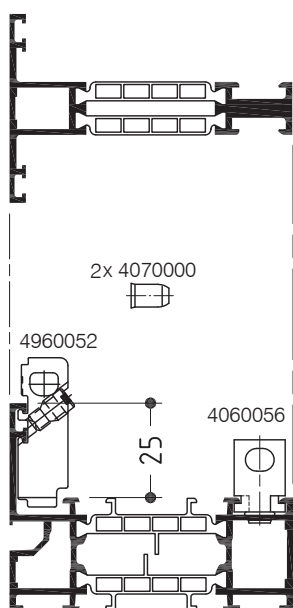

1917336	5910020
---------	---------

1010488	5910009
1010489	
1010491	
1010492	
1010495	
1017050	
1017051	

WICLINE 75

Kämpferstoßverbindung
Transom butt-joint connection

Kämpferprofile
Transom profiles

Kämpfer / Blendrahmen
Transom / Frame

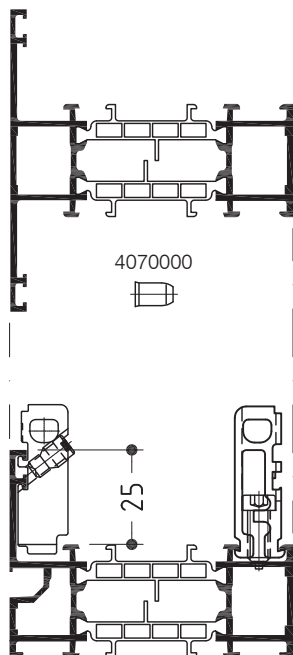

Falz 25 / Rebate 25

Profil Profile		Stoßverbinder außen Butt-joint connector outwards	Stoßverbinder innen Butt-joint connector inwards
1017203	1917203	1 x 4960054	1 x 4960004
1017204	1917204	1 x 4960055	1 x 4960005
1017205	1917205	1 x 4960056	1 x 4960006

1010488
1010489
1010491
1010492
1010495
1017050

Kämpfer / Blendrahmen
Transom / Frame

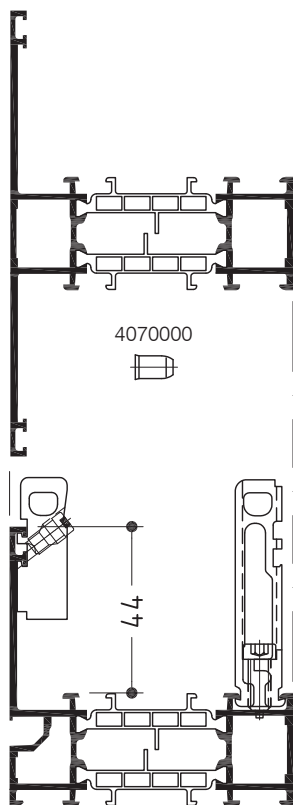

Falz 44 / Rebate 44

Profil Profile		Stoßverbinder außen Butt-joint connector outwards	Stoßverbinder innen Butt-joint connector inwards
1017231	1917231	1 x 4960229	1 x 4960020
---	1917235	1 x 4960229	1 x 4960020

1010434
1010490
1010493
1010494
1017051

Fenster / Türen, durchschusshemmend nach DIN EN 1522
Windows / doors, bullet resistant according to DIN EN 1522

Allgemeines:

Als Ergänzung zum Systemprogramm wurden die Serien WICLINE 65/75 in der durchschusshemmenden Widerstandsklasse bis FB 4 nach der aktuell gültigen europäischen Norm DIN EN 1522 geprüft.

Normen:

- DIN EN 1522
Fenster, Türen, Abschlüsse
Durchschusshemmung
Klassifizierung und Anforderungen
- DIN EN 1523
Fenster, Türen, Abschlüsse
Durchschusshemmung
Prüfverfahren
- DIN EN 1063
Sicherheitssonderverglasungen
Prüfverfahren und Klasseneinteilung für den Widerstand gegen Beschuss.

Hinweis:

Der Begriff "durchschusshemmende Verglasung" bezieht sich auf Erzeugnisse, die die eindeutigen Eigenschaften von Glas haben und die ein Verbund aus Glas und Kunststoff sind.

General:

In addition to the system program the series WICLINE 65/75 have been tested according to the current European standard DIN EN 1522 in the bullet resistance class up to FB 4.

Standards:

- DIN EN 1522
Windows, doors, closures
Bullet resistance
Classification and requirements
- DIN EN 1523
Windows, doors, closures
Bullet resistance
Testing procedures
- DIN EN 1063
Special safety glazings
Testing methods and classifications for the resistance against bullet attack.

Note:

The term "bullet resistant glazing" refers to products with the distinct properties of glass and which are a compound of glass and plastic.

Übersicht der einzelnen Widerstandsklassen und Zuordnung der Gläser:

Overview of the several classes of resistance and classification of the glasses:

Beschussklasse nach EN 1522 <i>Bullet resistant class according EN 1522</i>	Zertifizierte Gläser, geprüft nach DIN EN 1063 <i>Certified glazing, tested according DIN EN 1063</i>
FB 1	BR 1
FB 2	BR 2
FB 3	BR 3
FB 4	BR 4

Hinweise:

- Es dürfen nur die im Profilsystem geprüften und von den Glasherstellern zertifizierten Glástypen mit Nachweis eingesetzt werden.
- Unzulässig sind Veränderungen im Glasaufbau, Scheibenzwischenraum und Einbaudicke.
- Die mit Etikett gekennzeichnete Angriffsseite der Verglasung muss mit der definierten Angriffsseite des Profilsystems übereinstimmen.
- Gläser wahlweise mit zusätzlicher Kennzeichnung in Ausführung "NS" (kein Splitterabgang) oder in Ausführung "S" (mit Splitterabgang).

Notes:

- Only glass types which have been certified by the glass manufacturer with approval proof for the profile system may be used.
- Modifications to the glass design, glass interspace and infill thickness are not allowed.
- The labelled assault side of the glazing must correspond with the assault side of the profile system.
- Glazings optionally with additional marking version "NS" (no splinters) or in version "S" (with splinters).

WICLINE 75 / WICSTYLE 75

Auswahl für durchschusshemmende Verglasung nach DIN EN 1063

Klasse BR 4-NS und BR 4-S im Mono- und Isolierglasaufbau

Selection for bullet resistant glazing according DIN EN 1063

Class BR 4-NS and BR 4-S in single and insulating glazing

Durchschusshemmende Verglasung, Klasse BR 4-NS nach EN 1063 / *Bullet resistant glazing, Class BR 4-NS according EN 1063*
Prüfzertifikat S 11 0032-03 FB 4-NS, Beschussamt Ulm / *Testcertificat S 11 0032-03 FB 4-NS, Department of ballistics Ulm*

Pos. Pos.	Klasse / Class (EN 1063)	Mono/Iso Single/Ins	Masse / Weight (kg/m ²)	Dicke / Thickness (mm)	Bezeichnung / Designation	Hersteller / Manufacturer
1	BR 4-NS	Mono	112	52	BR 4-NS-21	Flachglas Markenkreis GmbH
2	BR 4-NS	Mono	82	52	SGG STADIPT CP-HN 452-NS	Saint Gobain GmbH
3	BR 4-NS	Mono	110	56	SANCO SAFE BR 4-S-ISO-0-56	Glas Trösch GmbH
4	BR 4-NS	Iso	115	48	Multistop -BR 4-NS-0-48	Glas Trösch GmbH
5	BR 4-NS	Mono	120	57	ipasafe BR 4-S Isolierglas	Interpane Sicherheitsglas GmbH & Co
6	BR 4-NS	Iso	45	24	Novalay secure BR 4 NS / 1.3.1	Schott Technical Glassolution GmbH
7	BR 4-NS	Mono	96	44	Novalay secure BR 4-NS / 1.5.4	Schott Technical Glassolution GmbH
8	BR 4-NS	Iso	93	50	Novalay secure BR 4-NS / 1.6.6	Schott Technical Glassolution GmbH
9	BR 4-NS	Iso	94	60	Novalay secure BR 4-NS / 1.6.5	Schott Technical Glassolution GmbH
10	BR 4-NS	Iso 3-fach Iso triple	100	60	Novalay secure BR 4-NS / 1.6.5	Schott Technical Glassolution GmbH
11	BR 4-NS	Mono	100	57	Multipact 55 BR 4-NS Isolierglas	Glaswerke Arnold GmbH
12	BR 4-NS	Iso	53	25	SILATEC BR 4-NS 25/52	Silatec GmbH

Hinweis:

Pos.10 siehe Prüfzertifikat S 11 0090 01 / Z vom 24.08.2011, BA Ulm

Note:

Pos.10 see Testcertificat S 11 0090 01 / Z vom 24.08.2011, BA Ulm

Durchschusshemmende Verglasung, Klasse BR 4-S nach EN 1063 / *Bullet resistant glazing, Class BR 4-S according EN 1063*
Prüfzertifikat S 11 0032-04 FB 4-S, Beschussamt Ulm / *Testcertificat S 11 0032-04 FB 4-S, Department of ballistics Ulm*

Pos. Pos.	Klasse / Class (EN 1063)	Mono/Iso Single/Ins	Masse / Weight (kg/m ²)	Dicke / Thickness (mm)	Bezeichnung / Designation	Hersteller / Manufacturer
13	BR 4-S	Mono	63	36	P8B-17	Flachglas Markenkreis GmbH
14	BR 4-S	Iso	68	36	BR 4-S-21	Flachglas Markenkreis GmbH
15	BR 4-S	Iso	78	50	P8B-27	Flachglas Markenkreis GmbH
16	BR 4-S	Iso	90	50	SGG STADIPT CP-HN 432-S	Saint Gobain GmbH
17	BR 4-S	Iso	67	39	SANCO SAFE BR 4-S-ISO-0-39	Glas Trösch GmbH
18	BR 4-S	Mono	80	33	Multistop -BR 4-S-0-33	Glas Trösch GmbH
19	BR 4-S	Iso	72	41	ipasafe BR 4-S Isolierglas	Interpane Sicherheitsglas GmbH & Co
20	BR 4-S	Iso	68	43	Multipact 41 BR 4-S Isolierglas	Glaswerke Arnold GmbH

WICLINE 75 / WICSTYLE 75

Durchschusshemmende, nicht transparente Füllung nach DIN EN 1522

Klasse FB 4-NS

Bullet resistant, opaque infill according DIN EN 1522

Class BR 4-NS

Prüfzertifikat S 11 0032-03 FB 4-NS / *Testcertificat S 11 0032-03 FB 4-NS*
Prüfzertifikat S 11 0032-04 FB 4-S / *Testcertificat S 11 0032-04 FB 4-S*
Beschussamt Ulm / *Department of ballistics Ulm*

Pos. Pos.	Klasse / Class (EN 1522)	Mono/Iso Single/Ins	Masse / Weight (kg/m ²)	Dicke / Thickness (mm)	Bezeichnung / Designation	Hersteller / Manufacturer
21	FB 4-NS	Iso	65	40	Seropal-Paneel	Pohltec GmbH

Hinweis:

Pos.21, durchschusshemmendes, 2-lagiges Paneel mit speziellem Decklagenaufbau auf der Beschussseite aussen.

Note:

Pos.21, bullet resistant double layer panel with special cover sheet compound on the assault side.



	Artikel Article	Bezeichnung Designation				
EH-Artikel Beschläge EH article fittings	6940319	EH-Garnitur Typ 1 Burglar resistant set type 1	X	X	X	
	6940320	EH-Garnitur Typ 1 Burglar resistant set type 1				X
	6940321	EH-Garnitur Typ 2 Burglar resistant set type 2	X	X	X	
	6940322	EH-Garnitur Typ 2 Burglar resistant set type 2				X
	6940323	EH-Bandverriegelung Burglar resistant hinge sided interlock	X	X	X	X
	6940325	Anbohrschutz für Falzgetriebe Drilling protection for rebate gear	X	X	X	X
	6940326	EH- Stulpgetriebe mit Anbohrschutz Double casement gear with drilling protection	X	X	X	X
	6940334	Falzschutz 250 mm Rebate safeguard		X	X	X
	6051070	OL-Mitnehmer Garnitur Fanlight driving dog set ZV/F	X	X	X	X
EH-Fenstergriffe EH window handles	6960260	Fenstergriff rosettenlos Window handle without rosette	X	X	X	X
	6960262	Fenstergriff abschließbar mit ovaler Rosette Window handle with oval rosette, lockable	X	X	X	X
	6960277	TF-Fenstergriff abschließbar mit Rosette, U-Form Window handle Tilt-First (TBT4), U-shape, stainless steel	X	X	X	X
	6960279	TF-Fenstergriff abschließbar mit Rosette, L-Form Window handle Tilt-First (TBT4), L-shape, stainless steel	X	X	X	X
EH-Zubehör EH accessories	4900187	Kennzeichnungsschild Identification marking plate	X	X	X	X
	4910074	EPDM Trockensicherung BT 65 Infill protection BT 65		X	X	
	4910075	EPDM Trockensicherung BT 65 Flügel Infill protection BT 65 sash		X	X	
	4910076	EPDM Trockensicherung BT 75 Infill protection BT 75		X	X	
	4910077	EPDM Trockensicherung BT 75 Flügel Infill protection BT 75 sash		X	X	



Lloyd's Register
LRQA

ZERTIFIKAT

Hiermit wird bescheinigt, dass das Qualitätsmanagementsystem von:

Sapa Building Systems GmbH
Einsteinstr. 61, 89077 Ulm
Deutschland

durch Lloyd's Register Quality Assurance geprüft und bewertet wurde
und den folgenden Normen zum Qualitätsmanagement entspricht:

**ISO 9001:2008, EN ISO 9001:2008,
DIN EN ISO 9001:2008, SN EN ISO 9001:2008**

Das Qualitätsmanagementsystem ist anwendbar für:

**Entwicklung, Beschaffung und Vertrieb von Aluminiumprofilen
und -systemen für die Bauindustrie.**
**Lagerung, Kommissionierung, Bearbeitung und Distribution von
Aluminiumprofilen und Zubehör für die Fassaden, Fenster
und Türen. Test- und Prüfzentrum.**
Schulungen / Weiterbildung für Metallarbeiter.

Dieses Zertifikat ist nur in Verbindung mit dem Zertifikatsanhang gültig, wobei dieser Anhang
mit den zugehörigen Niederlassungen die gleiche Referenznummer haben muss.

Zertifikat
Registrier-Nr.: KLN 0924020

Erstmalige Zulassung: 05. November 1993

Bestehendes Zertifikat: 18. Dezember 2014

Dieses Zertifikat ist gültig bis: 31. Oktober 2017

Ausgestellt von: Lloyd's Register Quality Assurance GmbH



Deutsche
Akkreditierungsstelle
D-ZM-16050-01-00

Dieses Dokument unterliegt der unten stehenden Bestimmung.

Innere Kanalstr. 15, 50823 Köln, Deutschland, Handelsregister Nr. B 34587

Diese Zertifizierung wurde gemäß den LRQA-Verfahren zur Auditierung und Zertifizierung durchgeführt. Diese Verfahren werden von LRQA überwacht.



Lloyd's Register
LRQA

CERTIFICATE OF APPROVAL

This is to certify that the Quality Management System of:

Sapa Building Systems GmbH
Einsteinstr. 61, 89077 Ulm
Germany

has been approved by Lloyd's Register Quality Assurance
to the following Quality Management System Standards:

ISO 9001:2008, EN ISO 9001:2008,
DIN EN ISO 9001:2008, SN EN ISO 9001:2008

The Quality Management System is applicable to:

**Design, procurement and sales of aluminium sections
and systems for the building and construction industry.**
**Stockholding, compiling, treatment and distribution of aluminium
sections and accessories for façades, windows and doors.**
Prototype build and Test Centre.
Training and education for metal builder.

This certificate is valid only in association with the certificate schedule bearing the
same number on which the locations applicable to this approval are listed.

Approval
Certificate No: KLN 0924020

Original Approval: 05 November 1993

Current Certificate: 18 December 2014

Certificate Expiry: 31 October 2017

Issued by: Lloyd's Register Quality Assurance GmbH



Innere Kanalstr. 15, 50823 Köln, Germany, Handelsregister Nr. B 34587
This approval is carried out in accordance with the LRQA assessment and certification procedures and monitored by LRQA.

ZERTIFIKATSANHANG

Sapa Building Systems GmbH Einsteinstr. 61, 89077 Ulm Deutschland

Hauptsitz

Sapa Building Systems GmbH
Einsteinstr. 61
D-89077 Ulm

Tätigkeiten

Entwicklung, Beschaffung und Vertrieb
von Aluminiumprofilen und -systemen für
die Bauindustrie.

Niederlassungen

Technologiezentrum Bellenberg
Am Mühlholz 2
D-89287 Bellenberg

Tätigkeiten

Test- und Prüfzentrum.

Verkaufsbüro Nord-West
Business-Kontor im Hafen
Philosophenweg 31-33
D-47051 Duisburg

Verkauf.

Verkaufsbüro Mitte
Donnersberg Str. 1
D-64646 Heppenheim

Verkauf.

Verkaufsbüro Nord-Ost
Johann-Eck-Str. 2
D-04129 Leipzig

Verkauf.

Seite 1 von 2



Dieses Dokument unterliegt der unten stehenden Bestimmung.

Innere Kanalstr. 15, 50823 Köln, Deutschland, Handelsregister Nr. B 34587

Diese Zertifizierung wurde gemäß den LRQA-Verfahren zur Ausföhrung und Zertifizierung durchgeföhrt. Diese Verfahren werden von LRQA überwacht.

Word Number: 14

CERTIFICATE SCHEDULE

Sapa Building Systems GmbH Einsteinstr. 61, 89077 Ulm Germany

Head Office

Sapa Building Systems GmbH
Einsteinstr. 61
D-89077 Ulm

Activities

Design, procurement and sales of aluminium sections and systems for the building and construction industry.

Locations

Technologiezentrum Bellenberg
Am Mühlholz 2
D-89287 Bellenberg

Activities

Prototype build and Test Centre.

Verkaufsbüro Nord-West
Business-Kontor im Hafen
Philosophenweg 31-33
D-47051 Duisburg

Sales.

Verkaufsbüro Mitte
Donnersberg Str. 1
D-64646 Heppenheim

Sales.

Verkaufsbüro Nord-Ost
Johann-Eck-Str. 2
D-04315 Leipzig

Sales.



ZERTIFIKATSANHANG

Sapa Building Systems GmbH Einsteinstr. 61, 89077 Ulm Deutschland

Niederlassungen

Verkaufsbüro Süd
Einsteinstr. 61
D-89077 Ulm

Sapa Building Systems AG
Gewerbepark
CH-5506 Mägenwil

Sapa Building Systems GmbH
Servicecenter Gerstungen
In der Flur 1
D-99834 Gerstungen

Tätigkeiten

Verkauf.

Verkauf.

Lagerung, Kommissionierung, Bearbeitung
und Distribution von Aluminiumprofilen
und Zubehör für Fassaden, Fenster und
Türen.

Zertifikat
Registrier-Nr.: KLN 0924020

Erstmalige Zulassung: 05. November 1993

Bestehendes Zertifikat: 18. Dezember 2014

Dieses Zertifikat ist gültig bis: 31. Oktober 2017

Seite 2 von 2



Dieses Dokument unterliegt der unten stehenden Bestimmung.

Innere Kanalstr. 15, 50823 Köln, Deutschland, Handelsregister Nr. B 34587

Diese Zertifizierung wurde gemäß den LRQA-Verfahren zur Auditierung und Zertifizierung durchgeführt. Diese Verfahren werden von LRQA überwacht.

CERTIFICATE SCHEDULE

Sapa Building Systems GmbH Einsteinstr. 61, 89077 Ulm Germany

Locations

Verkaufsbüro Süd
Einsteinstr. 61
D-89077 Ulm

Hydro Building Systems AG
Gewerbepark
CH-5506 Mägenwil

Hydro Building Systems GmbH
Servicecenter Gerstungen
In der Flur 1
D-99834 Gerstungen

Activities

Sales.

Sales.

Stockholding, compiling, treatment and distribution of aluminium sections and accessories for façades, windows and doors.

Approval
Certificate No: KLN 0924020

Original Approval: 05 November 1993

Current Certificate: 18 December 2014

Certificate Expiry: 31 October 2017

Page 2 of 2

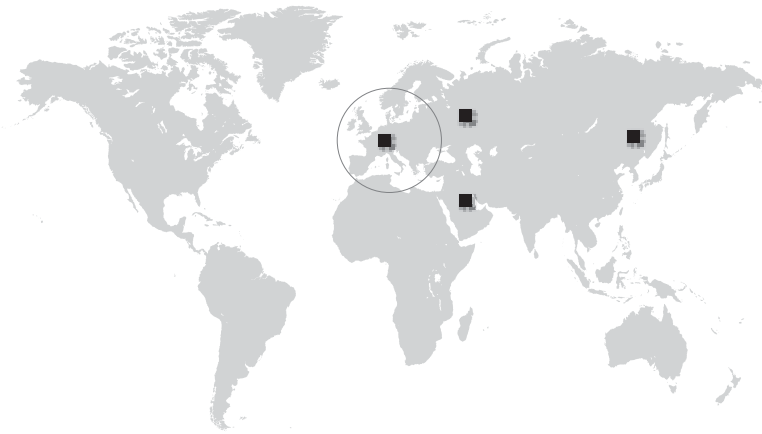

**Austria**

5201 Seekirchen
☎ +43 6212 2000
✉ info@wicona.at

Benelux

3400 Landen
☎ +32 11 690316
✉ info@wicona.be
✉ info@wicona.nl

Czech Republic

63900 Brno
☎ +420 543 422030
✉ info@wicona.cz

Denmark

7430 Ikast
☎ +45 7020 2048
✉ info@wicona.dk

España

08195 Sant Cugat del Vallès
Barcelona
☎ +34 902 222323
✉ info@wicona.es

Estonia / Latvia / Lithuania

11317, Tallinn
☎ +37 2657 6635
✉ info@wicona.lt

France

02200 Courmelles
☎ +33 3 23598200
✉ info@wicona.fr

94388 Bonneuil-sur-Marne Cedex
☎ +33 1 45138000

Germany

89077 Ulm
☎ +49 731 3984-0
✉ info@wicona.de

47051 Duisburg
☎ +49 203 45046-0

04315 Leipzig
☎ +49 341 989795-0

64646 Heppenheim
☎ +49 6252 6736-0

Hungary

1031 Budapest
☎ +36 (1) 4533457
✉ info@wicona.hu

Ireland

Dublin 22, Eire
☎ +353 1 4105766
✉ info@wicona.ie

Italia

20063 Cernusco sul Naviglio MI
☎ +39 02 924291
✉ info@wicona.it

Norway

0283 Oslo
☎ +47 22 422200
✉ info@wicona.no

Poland

03-828 Warszawa
☎ +48 22 3308170
✉ info@wicona.pl

Russia

RUS-123995, Москва
☎ +7 495 2077530
✉ info@wicona.ru

Sweden

352 45 Växjö
☎ +46 470 787400
✉ info@wicona.se

Switzerland

5506 Mägenwil
☎ +41 62 88741-41
✉ info@wicona.ch

United Kingdom

Wakefield WF5 9TG
☎ +44 845 6028799
✉ info@wicona.co.uk

Africa / Asia / America

31037 Toulouse
☎ +33 5 61312626
✉ info@wicona-int.com

China

Tongzhou District, Beijing, PRC 101102
☎ +8610 60595686
✉ info@wicona.cn

Qatar

Doha
☎ +974 44 912552
✉ info@wicona-int.com

