

WICLINE  
Fenstersysteme  
*Window systems*

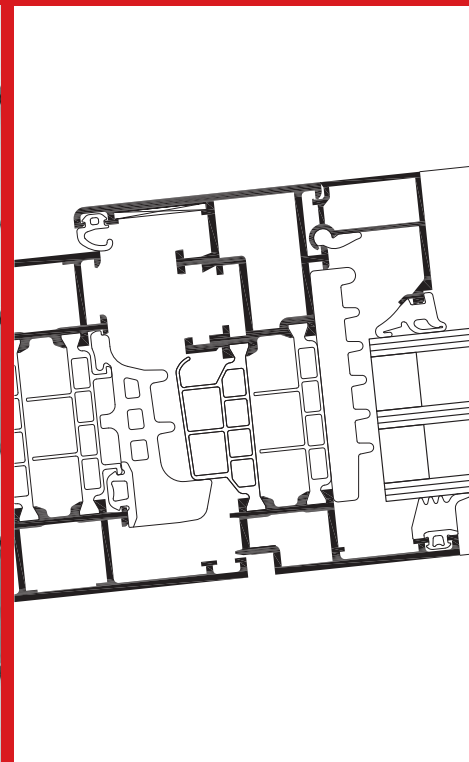

Konstruktionsschnitte 03.2015  
*Construction sections*



Die in dieser Dokumentation enthaltenen Daten und Hinweise entsprechen den uns bekannten Informationen zum Zeitpunkt der Drucklegung. Eine Haftung für die hier enthaltenen Informationen ist ausgeschlossen, es sei denn, die Fehler beruhen auf Vorsatz oder grober Fahrlässigkeit seitens unseres Unternehmens.

**Die in den Unterlagen dargestellten und beschriebenen Produkte und Anwendungen sind für Fachunternehmen ausgelegt. Sämtliche Beschreibungen erfolgen als Serviceleistung ohne Anerkennung von Rechtspflichten und entbinden nicht von eigener Prüfung bei der Verwendung für Zwecke des Anwenders. Branchenübliche Fachkenntnisse sowie Kenntnis des aktuellen gültigen Standes der Technik werden als bekannt vorausgesetzt und daher nicht gesondert beschrieben oder erläutert.**

Die Benutzung des Markenzeichens WICONA® ist nur zulässig, sofern ausschließlich die in den jeweils gültigen WICONA-Profilprogrammen aufgenommenen Konstruktionsteile (Profile, Zubehör und Beschläge) verwendet werden. Die Echtheit der Artikel bzw. Teile und die Einheit der Konstruktion ist erkennbar durch die entsprechende Kennzeichnung bei diesen Teilen. Von Sapa Building Systems entwickelte und geprüfte WICONA-Systeme für Fassaden, Fenster und Türen erhalten mit entsprechenden Prüfungen und Prüfzeugnissen durch anerkannte Institute ihre endgültige Bestätigung. Für jeden verarbeitenden Fachbetrieb sind diese Prüfzeugnisse und Dokumentationen verpflichtende Arbeitsrichtlinien. Bei festgestellten Mängeln, die an WICONA Fassaden, -Fenstern und -Türen sichtbar werden, weil systemfremde Teile verwendet wurden, wird in diesen Fällen jede Haftung durch Sapa Building Systems ausgeschlossen. Desweiteren verlieren die attestierte Prüfzeugnisse für diese Elemente ihre Gültigkeit. Bitte beachten Sie auch die „Wichtigen Hinweise“ im Vorspann unserer Profilprogramme und Verarbeitungsrichtlinien.

Sapa Building Systems

® = eingetragene Markenzeichen  
Sapa Building Systems

*The data and instructions contained in this documentation correspond to the information known to us at the time of printing. There is no liability on our part for the information contained herein, unless the errors are deliberate on our part or attributable to gross negligence by our company.*

***The products and applications shown and described in these documents are designed for specialist companies. All descriptions are provided as a service, without admitting legal responsibility, and do not release the user from the need to check that a product or application is suitable for the particular purpose envisaged. Specialist knowledge customary in this branch of business and awareness of the latest technology are assumed and consequently are not separately described or explained.***

*Use of the trademark WICONA® is permitted only if the structural parts included in the applicable WICONA profile programmes (profiles, accessories and fittings) are exclusively used. The genuineness of the items or parts and the uniformity of the design is identifiable by the corresponding markings on these parts. WICONA systems developed and tested by Sapa Building Systems for facades, windows and doors are ultimately qualified by the appropriate tests and test certificates from recognised institutes. Each processing company is subject to these test certificates and documentation as mandatory work guideline specifications. Sapa Building Systems is not liable for any defects visible on WICONA facades, windows and doors and attributable to the use of parts not belonging to the system or to a lack of maintenance of these products. The corresponding test certificates also lose their validity for these items. Please also note the "Important indications" in the opening sections of our profile programmes and processing guideline specifications.*

Sapa Building Systems





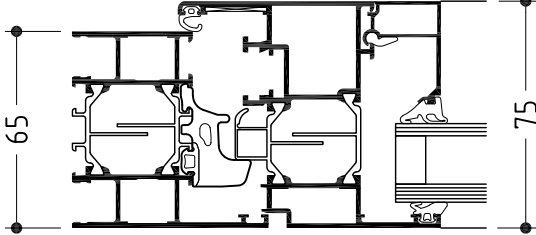
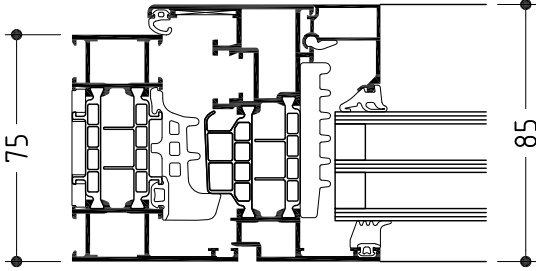
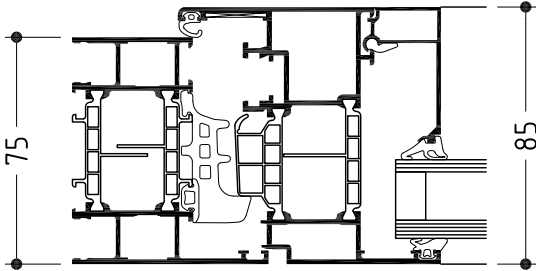
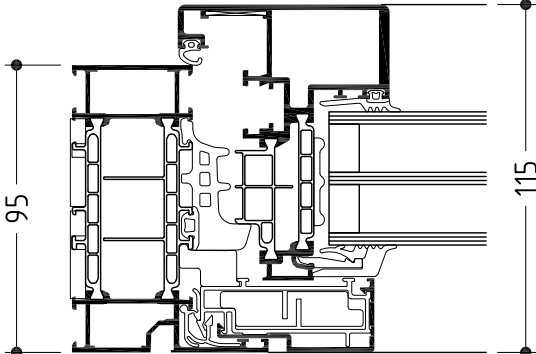

® = registered trademarks  
Sapa Building Systems



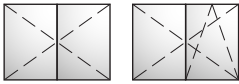
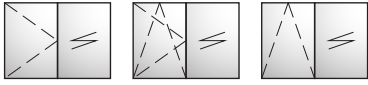



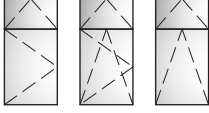
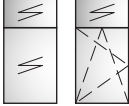
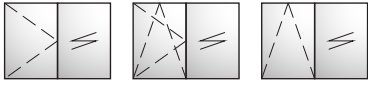
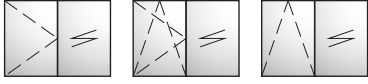

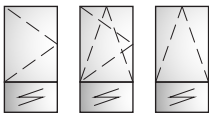

## Inhaltsverzeichnis Contents

Kapitel / Chapter

1		..... WICLINE 65
2		..... WICLINE 75 TOP
3		..... WICLINE 75
4		..... WICLINE 95

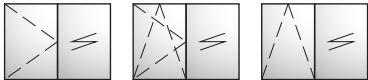

	Seite Page
<b>Symbole</b> <i>Symbols</i>	<b>6</b>
<b>Legende</b> <i>Legend</i>	<b>7</b>
<b>Übersicht der Öffnungsarten</b> <i>Survey of opening types</i>	<b>8</b>
<b>Standardflügel</b> <i>Standard sash</i>	<b>11</b>
	<b>11</b>
<b>Flügelprofil im Blendrahmen</b> <i>Sash profile in frame</i>	
	<b>14</b>
<b>Stulpfenster - Mittelstoß</b> <i>Double casement window - Meeting stiles</i>	
	<b>16</b>
<b>Flügelprofil im Blendrahmen mit Kämpfer</b> <i>Sash profile in frame with transom</i>	
	<b>17</b>
<b>Flügelprofil im Blendrahmen mit Sprossenprofil</b> <i>Sash profile in frame with crossbar profile</i>	
	<b>21</b>
<b>Festverglasung</b> <i>Fixed glazing</i>	
	<b>23</b>
<b>Flügelprofil im Dehnstoßblendrahmen</b> <i>Sash profile in expansion joint frame</i>	
	<b>27</b>
<b>Flügelprofil im Blendrahmen mit Kämpfer</b> <i>Sash profile in frame with transom</i>	
	<b>29</b>
<b>Kämpferprofil nach innen verstärkt</b> <i>Internally reinforced transom profile</i>	
	<b>31</b>
<b>Stützenprofile nach außen verstärkt</b> <i>Externally reinforced mullion profiles</i>	
	<b>35</b>
<b>Stützenprofile geteilt, nach außen verstärkt</b> <i>Externally reinforced split mullion profiles</i>	
	<b>37</b>
<b>Eckstützenprofile</b> <i>Corner mullion profiles</i>	

	Seite Page	
	<p><b>Kämpferprofil mit Plattenmontage von außen</b> <i>Transom profile with panel assembly from outside</i></p>	41
	<p><b>Flügelprofil im Blendrahmen mit Bauanschlussprofil</b> <i>Sash profile in frame with profile for junction to structure</i></p>	42
	<p><b>Flügelprofil im Einspannblendrahmen</b> <i>Sash profile in clamping frame</i></p>	43
	<p><b>Bauanschluss unten</b> <i>Bottom junction to structure</i></p>	45
	<p><b>Klassik-Design</b> <i>Classic design</i></p>	47
	<p><b>Flügelprofil im Blendrahmen</b> <i>Sash profile in frame</i></p>	47
	<p><b>Stulpfenster - Mittelstoß</b> <i>Double casement window - Meeting stiles</i></p>	51
	<p><b>Flügelprofil im Blendrahmen mit Kämpfer</b> <i>Sash profile in frame with transom</i></p>	53
	<p><b>Flügelprofil im Blendrahmen mit Sprossenprofil</b> <i>Sash profile in frame with crossbar profile</i></p>	55
	<p><b>Flügelprofil im Dehnstoßblendrahmen</b> <i>Sash profile in expansion joint frame</i></p>	58
	<p><b>Flügelprofil im Einspannblendrahmen</b> <i>Sash profile in clamping frame</i></p>	59
	<p><b>Bauanschluss unten</b> <i>Bottom junction to structure</i></p>	60

	Seite Page
	<b>61</b>
	<b>61</b>
	<b>67</b>
	<b>69</b>
	<b>74</b>
	<b>75</b>
	<b>76</b>
	<b>78</b>
	<b>79</b>
	<b>79</b>
	<b>87</b>
	<b>91</b>
	<b>99</b>
	<b>115</b>

**Verdeckter Flügel**  
*Concealed sash*



**Flügelprofil im Blendrahmen**  
*Sash profile in frame*

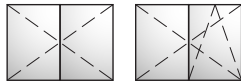

**Stulpfenster - Mittelstoß**  
*Double casement window - Meeting stiles*

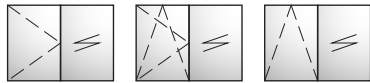

**Flügelprofil im Blendrahmen mit Kämpfer**  
*Sash profile in frame with transom*



**Festverglasung**  
*Fixed glazing*



**Flügelprofil im Dehnstoßblendrahmen**  
*Sash profile in expansion joint frame*



**Flügelprofil im Einspannblendrahmen**  
*Sash profile in clamping frame*



**Bauanschluss unten**  
*Bottom junction to structure*

**Sonderöffnungsarten**  
*Special openings*



**Senk-Klappfenster**  
*Italian style window*



**Klappfenster**  
*Top-hung window*

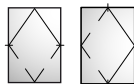

**Schwing-Wende-Fenster**  
*Horizontal/vertical pivot window*

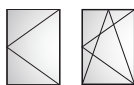

**Fenstertür**  
*Casement door*



**Parallel-Schiebe-Kipp-Fenster**  
*Parallel sliding tilt window*

	Seite Page
	<b>125</b>
	<b>125</b>
	<b>127</b>
	<b>129</b>
	<b>130</b>
	<b>133</b>
	<b>133</b>
	<b>134</b>
	<b>135</b>
	<b>136</b>
	<b>137</b>
	<b>138</b>

**Einbruchhemmung**  
*Burglar resistance*

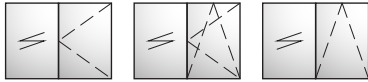

**Flügelprofil im Blendrahmen mit Kämpfer**  
*Sash profile in frame with transom*

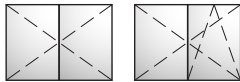

**Stulpfenster - Mittelstoß**  
*Double casement window - Meeting stiles*

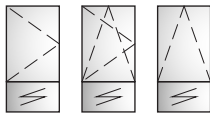

**Flügelprofil im Blendrahmen mit Kämpfer, Klassik-Design**  
*Sash profile in frame with transom, Classic design*

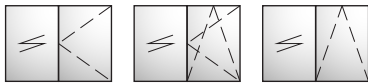

**Flügelprofil im Blendrahmen mit Kämpfer, verdeckter Flügel**  
*Concealed sash in frame with transom*

**Durchschusshemmung**  
*Bullet resistance*



**Blendrahmen Festverglasung**  
*Frame profile fixed glazing*



**Elementkopplung Festverglasung**  
*Unit coupling fixed glazing*



**Blendrahmen Fensterflügel**  
*Frame window sash*

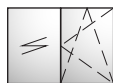

**Elementkopplung Fensterflügel / Festverglasung**  
*Unit coupling window sash / fixed glazing*

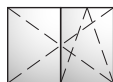

**Elementkopplung Fensterflügel**  
*Unit coupling window sash*









**Kämpferprofil Festverglasung**  
*Transom profile fixed glazing*

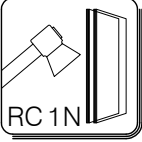

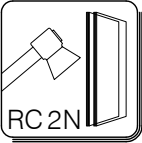
	Seite <i>Page</i>
<b>Zusatzprofile</b> <i>Additional profiles</i>	<b>141</b>
<b>3091036 / 3991215 / 3991216 / 3991217</b>	<b>141</b>
<b>3091031 / 3991234</b>	<b>142</b>
<b>160747 / 3091057</b>	<b>143</b>
<b>3091055 / 3091057</b>	<b>144</b>
<b>3091037 / 3991280</b>	<b>145</b>
<b>3091056</b>	<b>146</b>
<b>3991237</b>	<b>147</b>
<b>3091044 / 3091054</b>	<b>148</b>
<b>3091045</b>	<b>149</b>
<b>3091039 / 3091040</b>	<b>150</b>
<b>3091049 / 3091050</b>	<b>151</b>
<b>3091048 / 3091051</b>	<b>152</b>
<b>3091046 / 3091047</b>	<b>153</b>
<b>3091058 / 3091059</b>	<b>154</b>
<b>3091041 / 3091042</b>	<b>155</b>

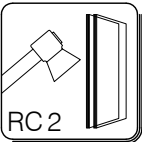
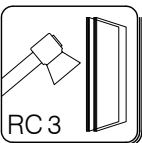





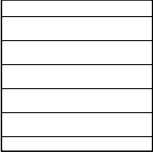
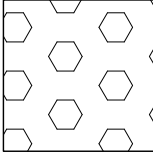
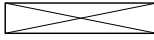
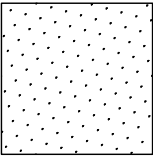
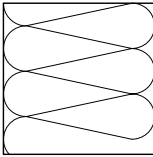
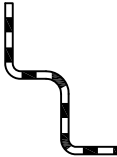
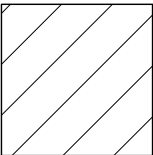
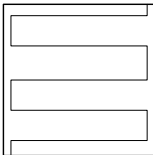
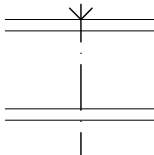
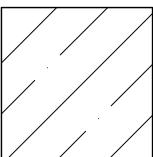
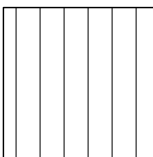
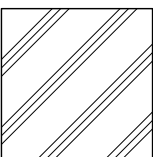
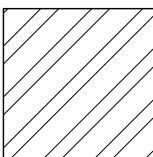
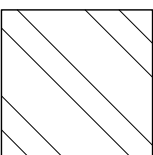
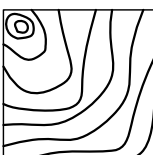
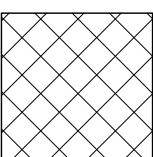
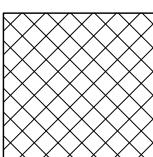
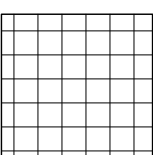
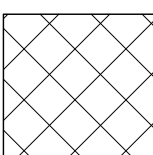





























Symbole  
Symbols

Symbol	Bezeichnung	Symbol	Bezeichnung
Symbols	Designation	Symbols	Designation
	Einbruchhemmung RC 1 N nach DIN EN 1627:2011  <i>Burglary resistance RC 1 N according to DIN EN 1627:2011</i>		barrierefrei  <i>barrier-free</i>
	Einbruchhemmung RC 2 N nach DIN EN 1627:2011  <i>Burglary resistance RC 2 N according to DIN EN 1627:2011</i>		Darstellung 90° gedreht  <i>Representation turned by 90°</i>
	Einbruchhemmung RC 2 nach DIN EN 1627:2011  <i>Burglary resistance RC 2 according to DIN EN 1627:2011</i>		
	Einbruchhemmung RC 3 nach DIN EN 1627:2011  <i>Burglary resistance RC 3 according to DIN EN 1627:2011</i>		
	Durchschusshemmung nach EN 1522  <i>Bullet resistance according to EN 1522</i>		











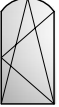







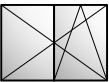
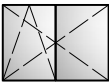
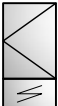
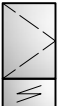
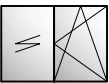
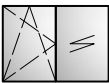
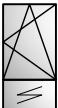

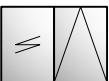
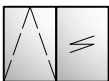

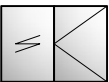
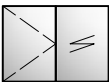

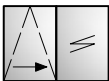

### Legende Legend

Muster <i>Swatch</i>	Bezeichnung <i>Designation</i>	Muster <i>Swatch</i>	Bezeichnung <i>Designation</i>	Muster <i>Swatch</i>	Bezeichnung <i>Designation</i>
	Streifen <i>Strip</i>		Lochblech <i>Perforated sheet</i>		Trag- bzw. Distanzklotz (Polyäthylen o. glw.) <i>Supporting or distance shim (Polyethylene or equivalent)</i>
	Putz <i>Plaster</i>		Wärmedämmung (alt) <i>Heat insulated (old)</i>		Dichtbahn (Dampfsperre, Dichtstreifen) <i>Sealing web (vapour barrier / sealing strips)</i>
	Mauerwerk <i>Wall</i>		Wärmedämmung <i>Heat insulated</i>		Verschraubung <i>Screwing</i>
	Beton <i>Concrete</i>		Keramik <i>Ceramics</i>		
	Steinplatten <i>Stone slabs</i>		Stahl <i>Steel</i>		
	Naturstein <i>Natural stone</i>		Holz <i>Wood</i>		
	Dauerelastische Dichtungsmasse <i>Permanently elastic sealing compound</i>		Imprägniertes Dichtband <i>Impregnated sealing strap</i>		
	Hinterfüllschnur <i>Back-filling cord</i>		Hartschaum Wärmedämmung <i>Hard foam Heat insulated</i>		

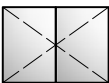
### Öffnungsarten Opening types

Ansicht von Innen <i>Inner view</i>	Bezeichnung <i>Designation</i>	Ansicht von Außen <i>Outer view</i>	Ansicht von Innen <i>Inner view</i>	Bezeichnung <i>Designation</i>	Ansicht von Außen <i>Outer view</i>
	Festverglasung <i>Fixed glazing</i>			Senk - Klapp - Fenster <i>Italian style window</i>	
	Photovoltaik <i>Photovoltaic</i>			Klapp - Fenster <i>Top-hung window</i>	
	Kipp - Fenster <i>Tilt window</i>			Schwing - Fenster <i>Horizontal pivot window</i>	
	Dreh - Fenster <i>Turn window</i>			Wende - Fenster <i>Vertical pivot window</i>	
	Drehkipp - Fenster <i>Turn/tilt window</i>			Parallel - Ausstellfenster <i>Parallel opening window</i>	
	Festverglasung mit Oberlicht <i>Fixed glazing with fanlight</i>			Rundbogen - Festverglasung <i>Semi-circular arch fixed glazing</i>	
	Drehkipp - Fenster mit Oberlicht <i>Turn/tilt window with fanlight</i>			Schräg - Festverglasung <i>Sloped fixed glazing</i>	
	Festverglasung mit Oberlicht Kippflügel <i>Fixed glazing with tilt window fanlight</i>			Rundbogen - Drehkipp - Fenster <i>Semi-circular arch turn/tilt window</i>	
	Drehkipp - Fenster mit Oberlicht Kippfenster <i>Turn/tilt window with tilt window fanlight</i>			Schräg - Drehkipp - Fenster <i>Sloped turn/tilt window</i>	

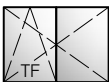
### Öffnungsarten Opening types

Ansicht von Innen <i>Inner view</i>	Bezeichnung <i>Designation</i>	Ansicht von Außen <i>Outer view</i>	Ansicht von Innen <i>Inner view</i>	Bezeichnung <i>Designation</i>	Ansicht von Außen <i>Outer view</i>
	Stichbogen - Drehkipp - Fenster <i>Segmental arch turn/tilt window</i>			Drehkipp - Fenster; Tilt-First Ausführung <i>Turn/tilt window. Type: Tilt-First</i>	
	Segment - Drehkipp - Fenster <i>Segmental turn/tilt window</i>			Kipp - Fenster mit Unterlicht <i>Tilt window with sublight</i>	
	Stulp - Fenster oder 2 - flügeliges Fenster mit Kämpfer <i>Double casement window or double sash window with transom</i>			Dreh - Fenster mit Unterlicht <i>Turn window with sublight</i>	
	Drehkipp - Fenster mit Festverglasung <i>Turn/tilt window with fixed glazing</i>			Drehkipp - Fenster mit Unterlicht <i>Turn/tilt window with sublight</i>	
	Kipp - Fenster mit Festverglasung <i>Tilt window with fixed glazing</i>			Festverglasung mit Sprosse <i>Fixed glazing with glazing bars</i>	
	Dreh - Fenster mit Festverglasung <i>Turn window with fixed glazing</i>			Kippfenster - Sprossenfenster <i>Tilt window with glazing bars</i>	
	Parallel - Schiebe - Kipp - Fenster <i>Parallel sliding tilt window</i>			Drehfenster - Sprossenfenster <i>Turn window with glazing bars</i>	
	Stulp - Fenster oder 2 - flügeliges Fenster mit Kämpfer <i>Double casement window or double sash window with transom</i>			Drehkipp - Sprossenfenster <i>Turn/tilt window with glazing bars</i>	
	Stulp - Fenster oder 2 - flügeliges Fenster mit Kämpfer; Tilt-First Ausführung <i>Double casement window or double sash window with transom. Type: Tilt-First</i>			Fenstertür, barrierefrei <i>Casement door, accessible</i>	



# WICLINE 65

Flügelprofil im Blendrahmen  
Sash profile in frame

Konstruktionsschnitt  
Construction section

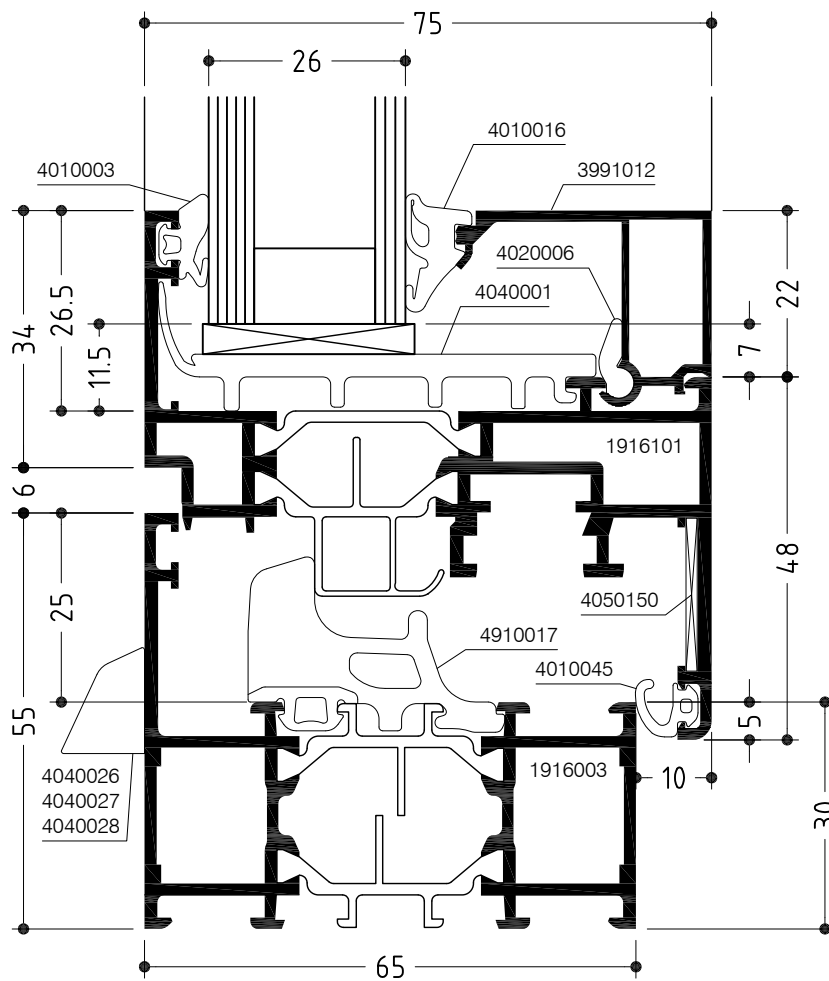

# WICLINE 65

## Konstruktionsschnitt

### Construction section

Flügelprofil im Blendrahmen mit Spezial-Dämmprofil

Sash profile in frame with special insulation profile

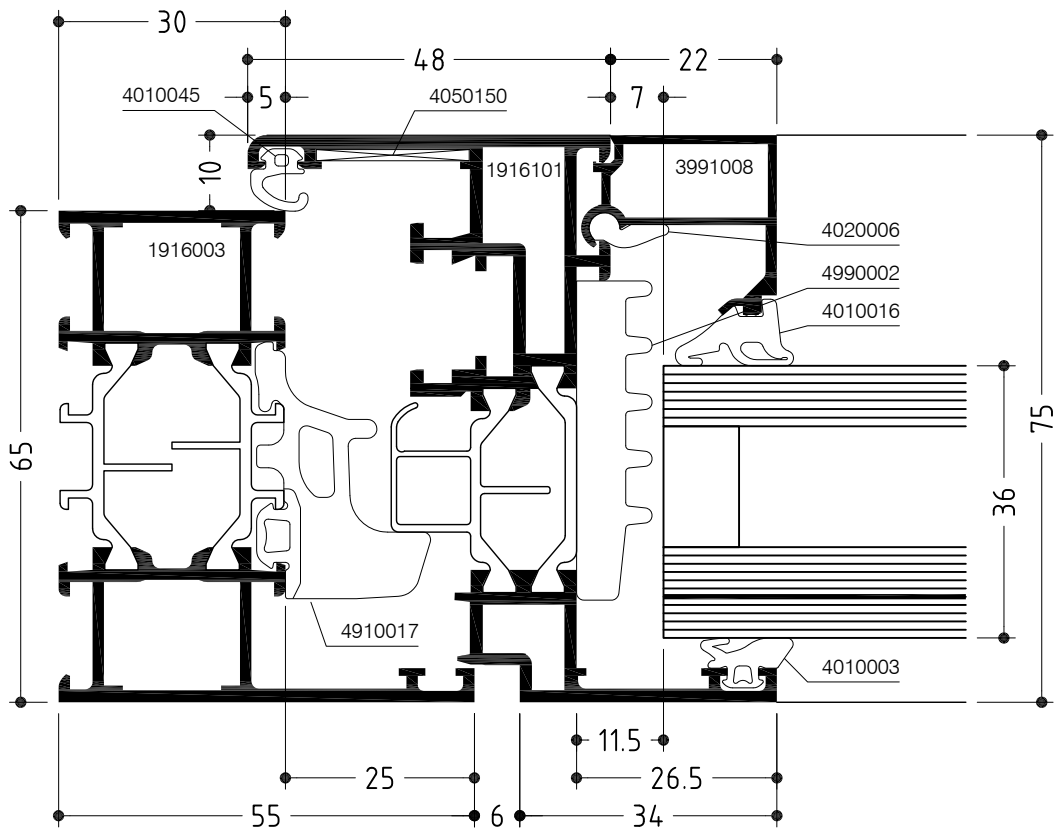



# WICLINE 65

Verdeckte Entwässerung mit Spezial-Dämmprofil  
Concealed drainage with special insulation profile

Konstruktionsschnitt  
Construction section

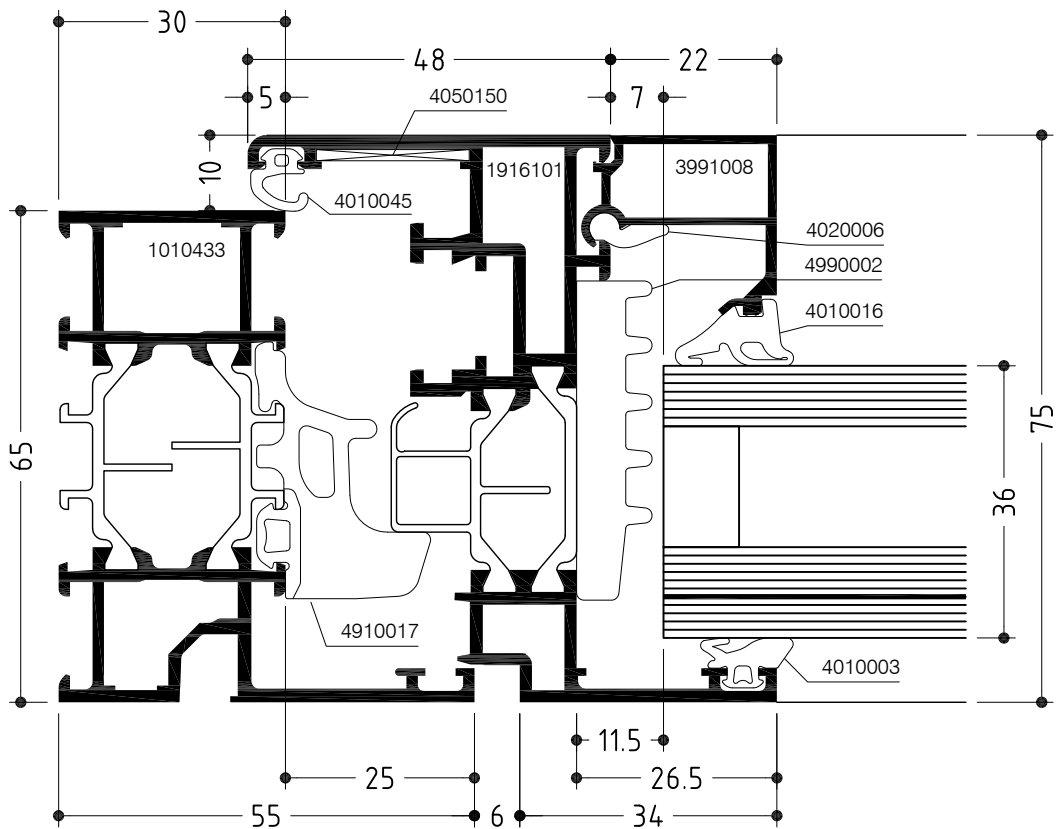

# WICLINE 65

Stulpfenster - Mittelstoß  
Double casement window - Meeting stiles

Konstruktionsschnitt  
Construction section

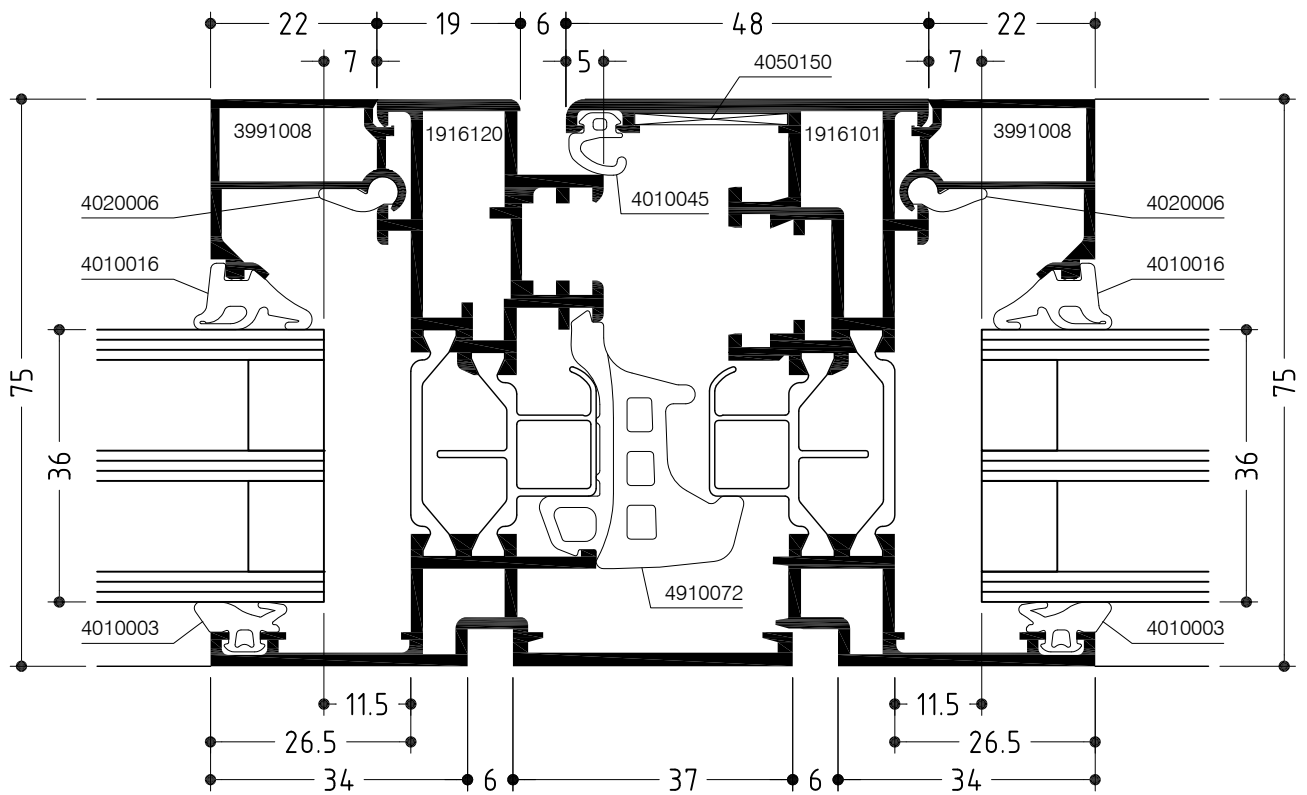
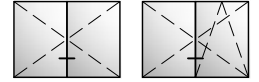

# WICLINE 65

Stulpfenster mit Aufsatzprofil - Mittelstoß  
 Double casement window with supplm. profile - Meeting stiles

Konstruktionsschnitt  
 Construction section

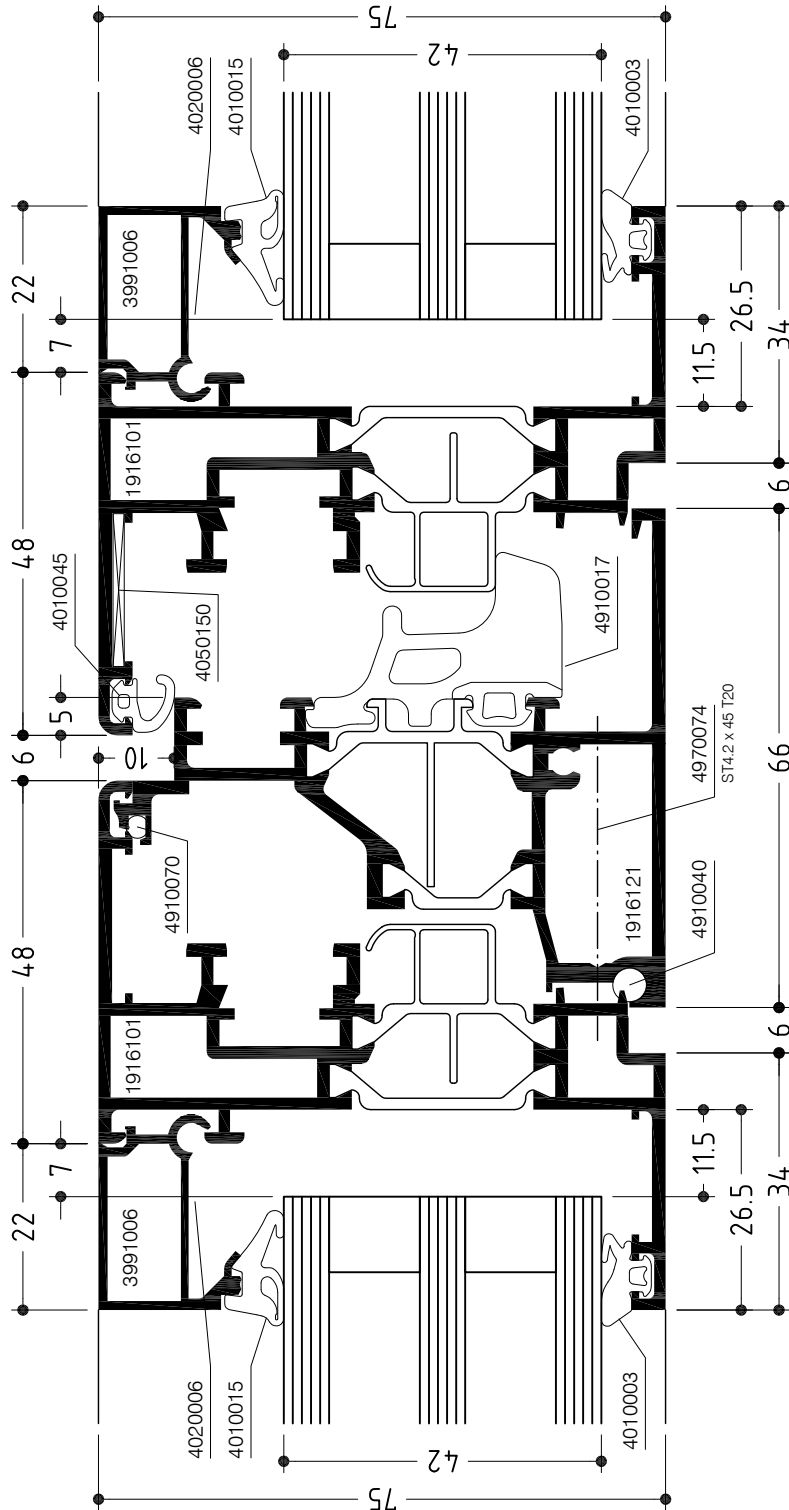
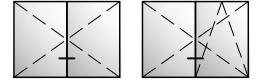

# WICLINE 65

Flügelprofil im Blendrahmen mit Kämpfer  
Sash profile in frame with transom

Konstruktionsschnitt  
Construction section

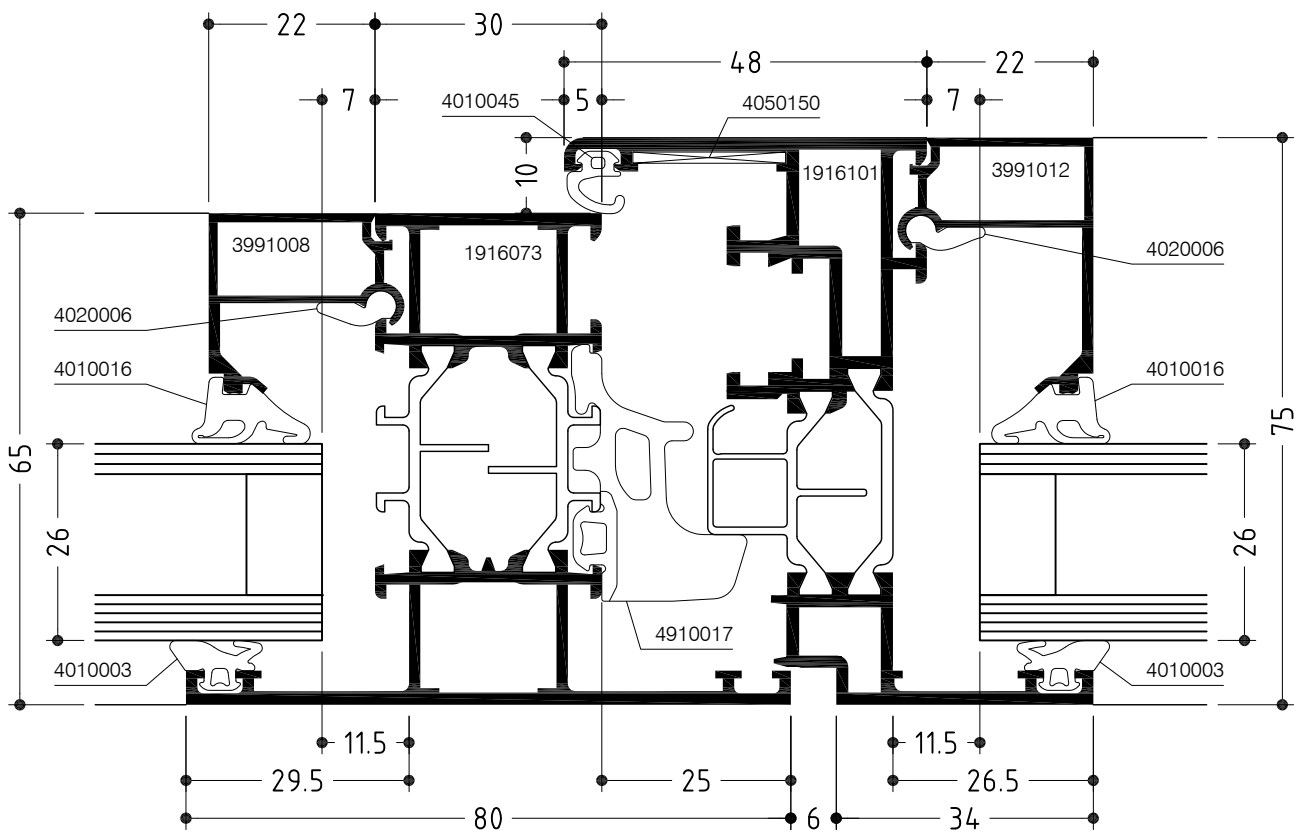
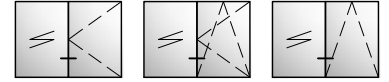

# WICLINE 65

Flügelprofil im Blendrahmen mit Sprossenprofil  
*Sash profile in frame with glazing bar profile*

Konstruktionsschnitt  
*Construction section*

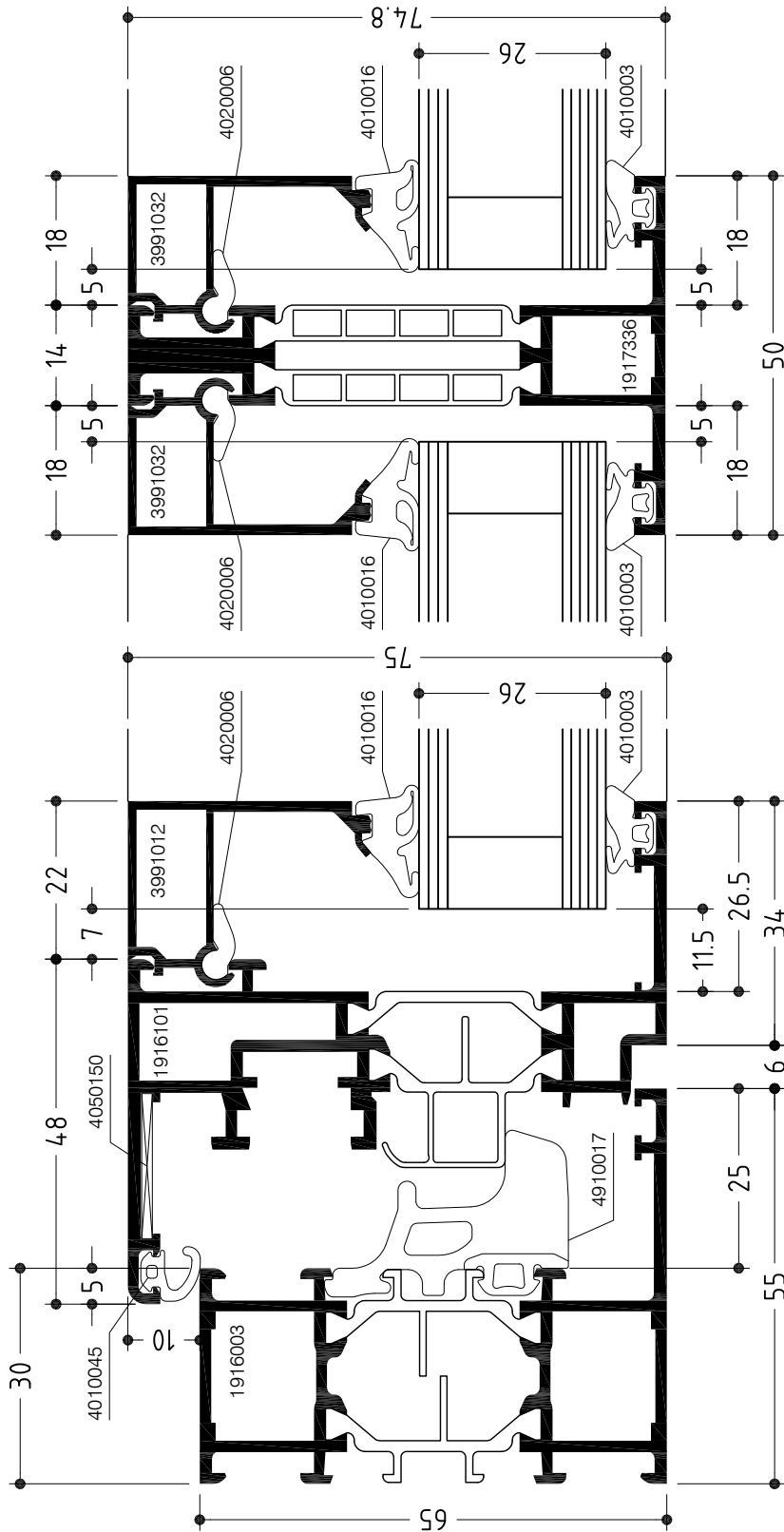



# WICLINE 65

Konstruktionsschnitt  
Construction section

Verdeckte Entwässerung, Festverglasung mit Sprossenprofil  
Concealed drainage, fixed glazing with glazing bar profile

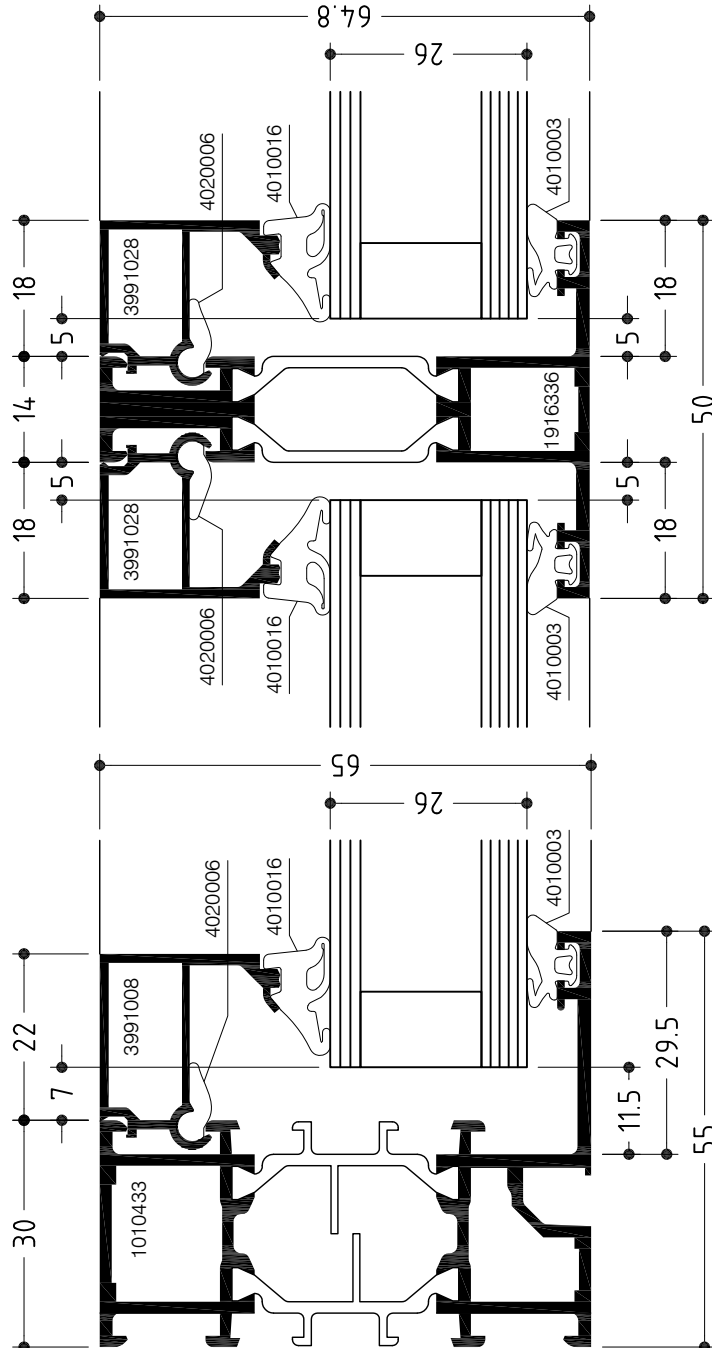

# WICLINE 65

Flügelprofil im Blendrahmen mit Ziersprossenprofil  
*Sash profile in frame with glazing bar profile*

Konstruktionsschnitt  
*Construction section*

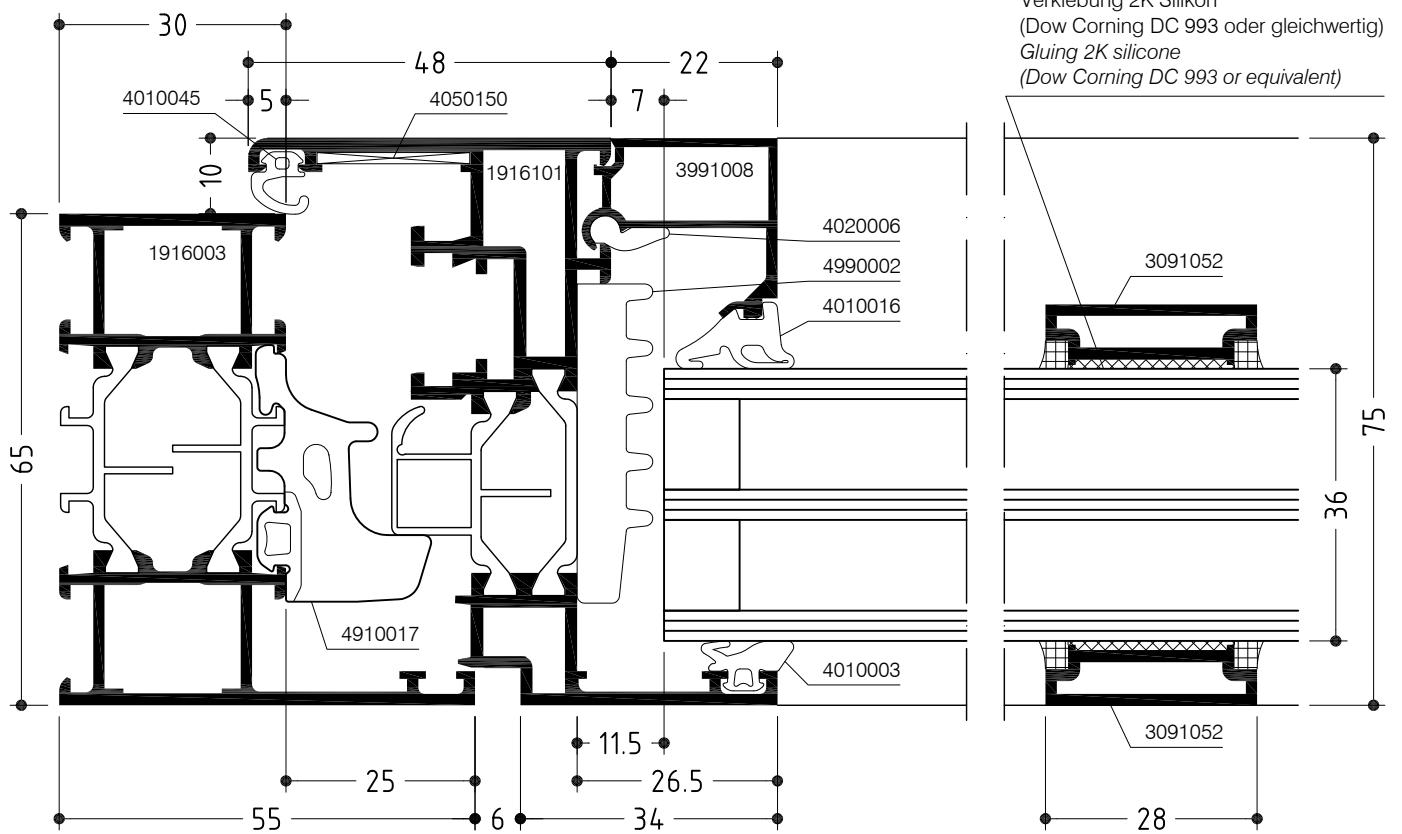



# WICLINE 65

Festverglasung  
Fixed glazing

Konstruktionsschnitt  
Construction section

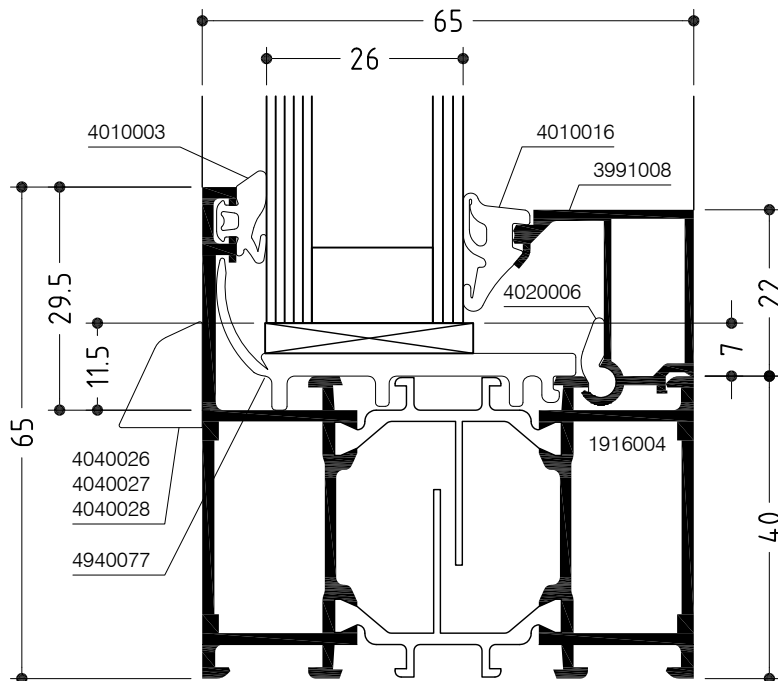

# WICLINE 65

Festverglasung mit Spezial-Dämmprofil  
Fixed glazing with special insulation profile

Konstruktionsschnitt  
Construction section

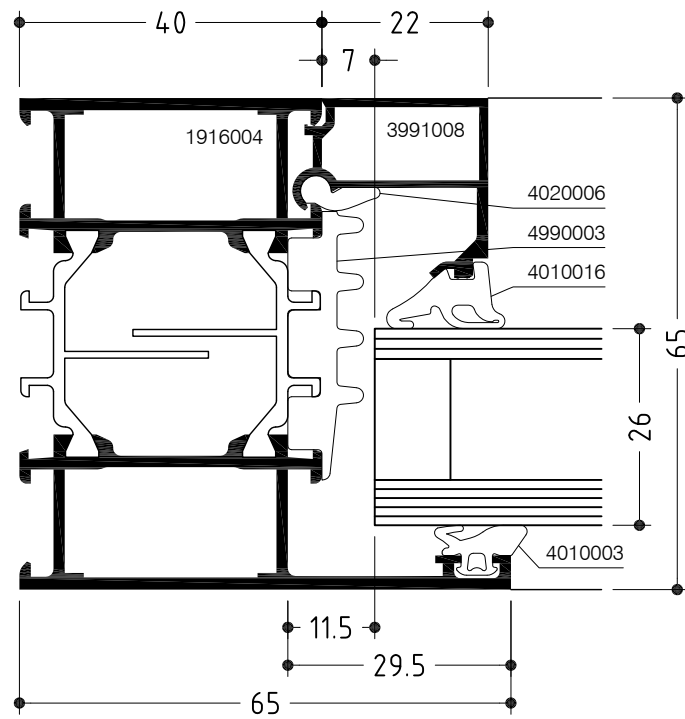

# WICLINE 65

Flügelprofil im Dehnstoßblendrahmen  
Sash profile in expansion joint frame

Konstruktionsschnitt  
Construction section

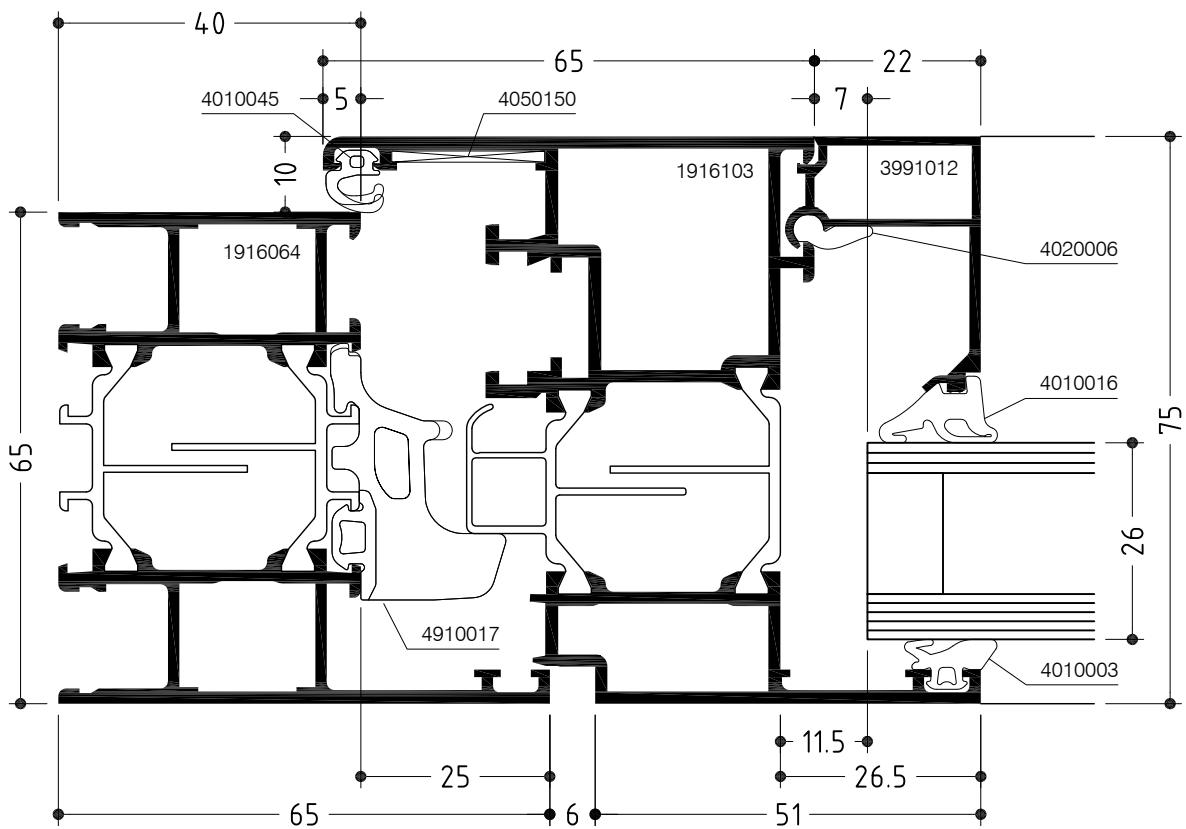

# WICLINE 65

Fenstertür, einwärts  
French window (window-door), inwards

Konstruktionsschnitt  
Construction section

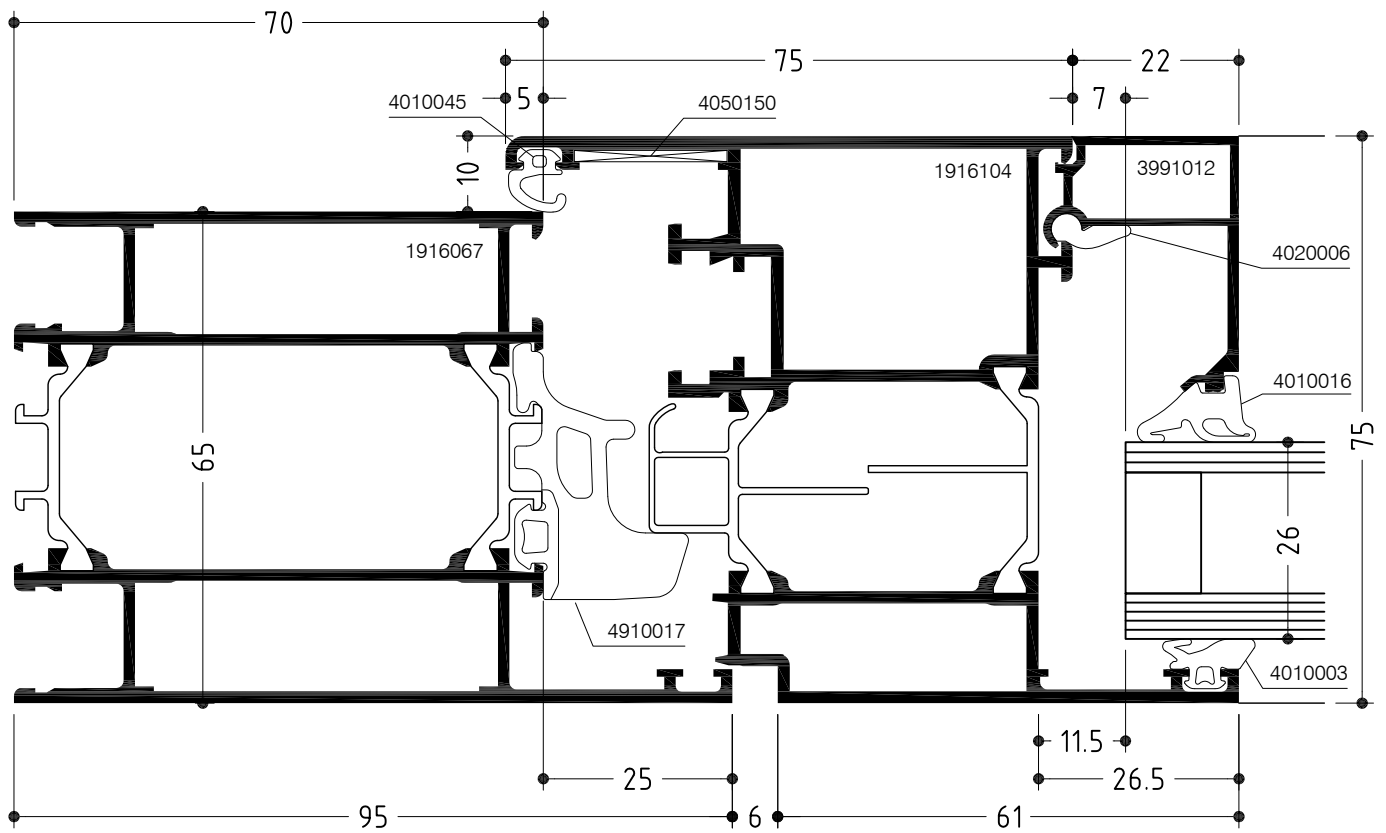
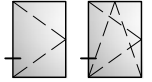

# WICLINE 65

Flügelprofil im Dehnstoßblendrahmen  
Sash profile in expansion joint frame

Konstruktionsschnitt  
Construction section

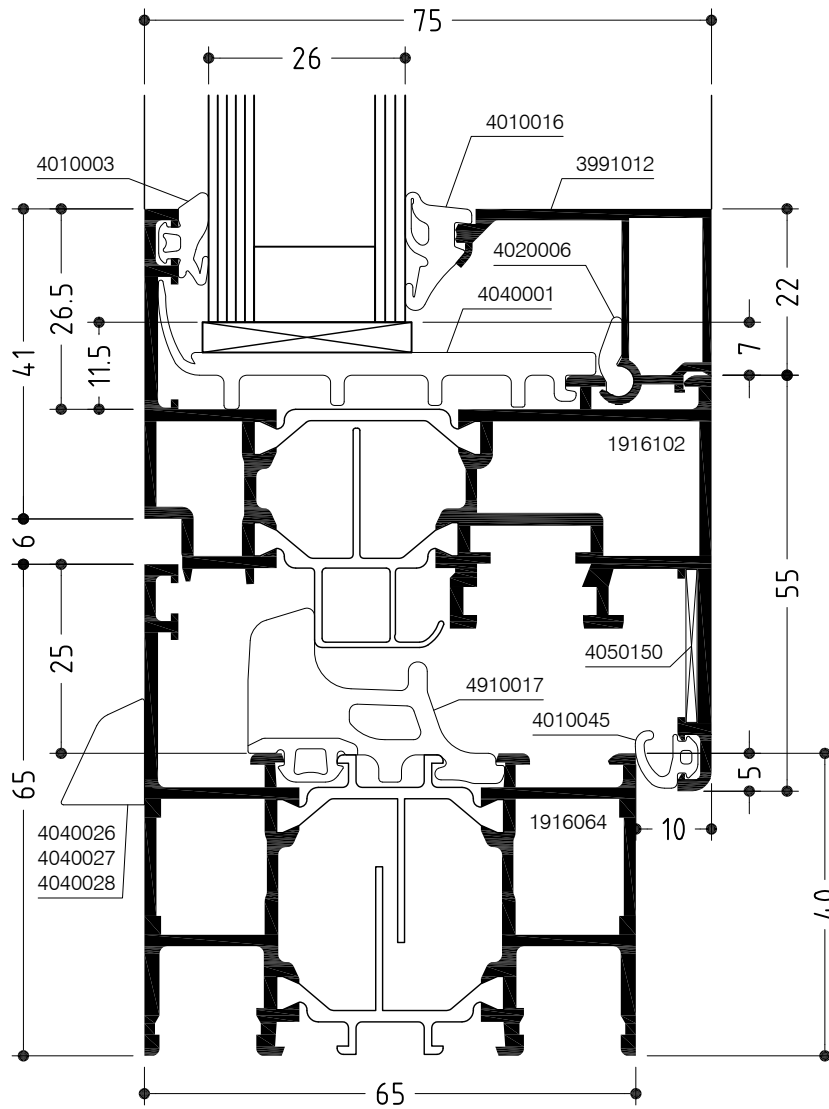

# WICLINE 65

Konstruktionsschnitt

Construction section

Blendrahmen - Dehnstoß und Festverglasung mit Spezial-Dämmprofil

Frame expansion joint and fixed glazing with special insulation profiles

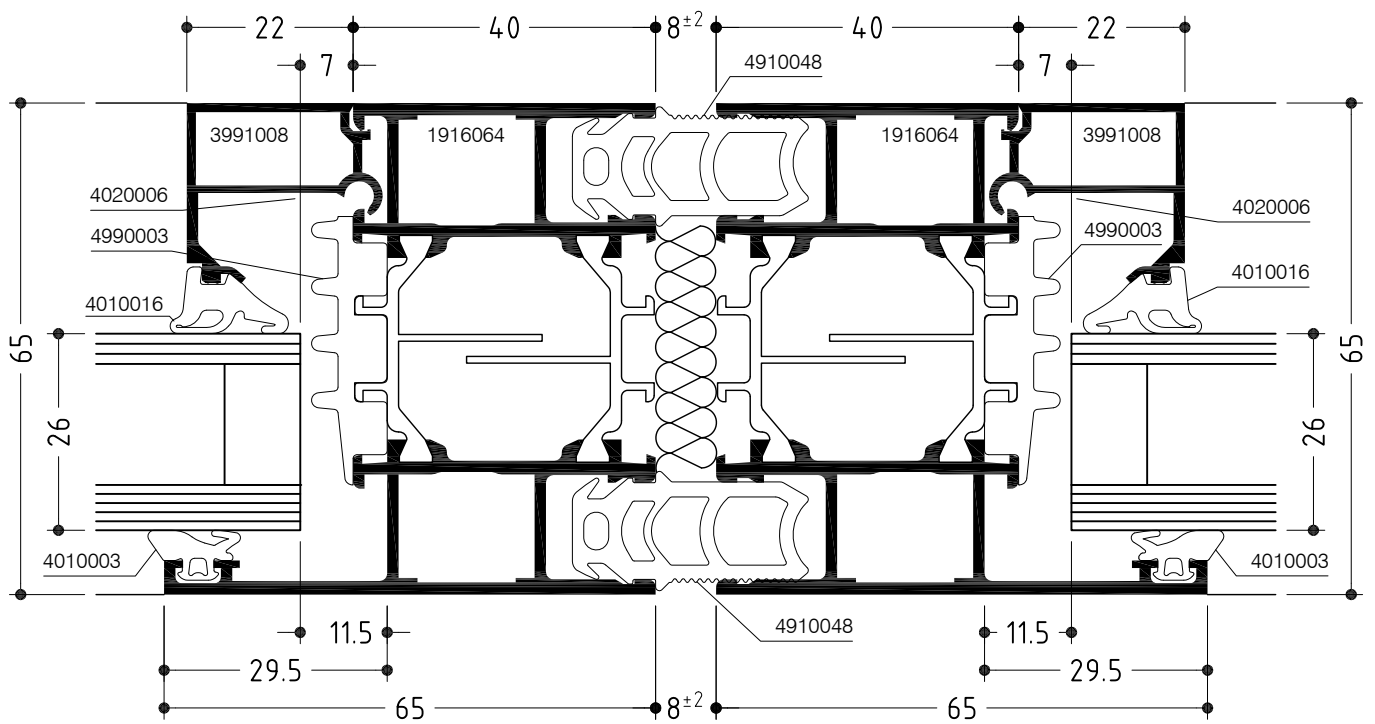
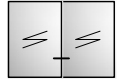

# WICLINE 65

Flügelprofil im Blendrahmen mit Kämpfer  
Sash profile in frame with transom

Konstruktionsschnitt  
Construction section

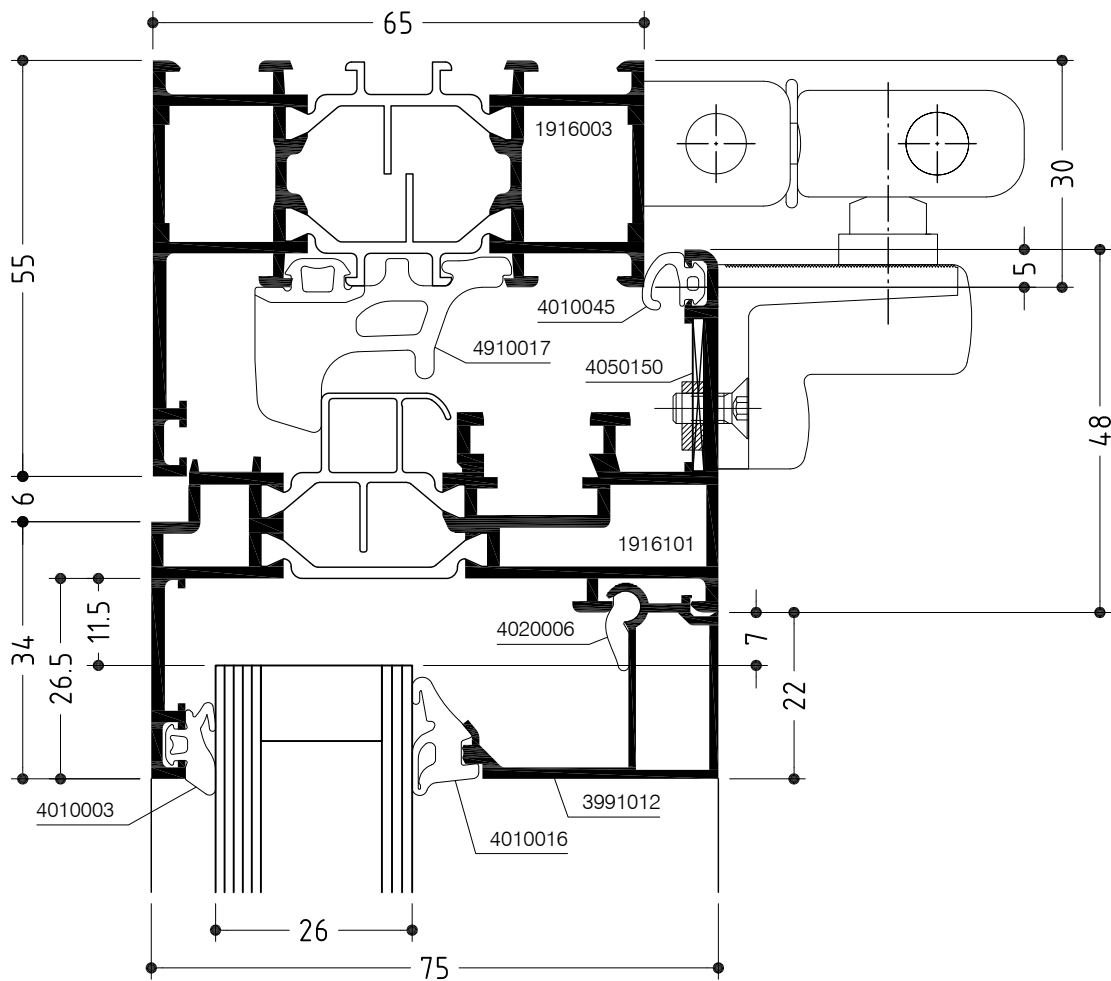
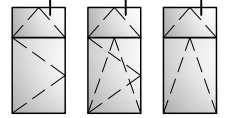

# WICLINE 65

Flügelprofil im Blendrahmen mit Kämpfer  
Sash profile in frame with transom

Konstruktionsschnitt  
Construction section

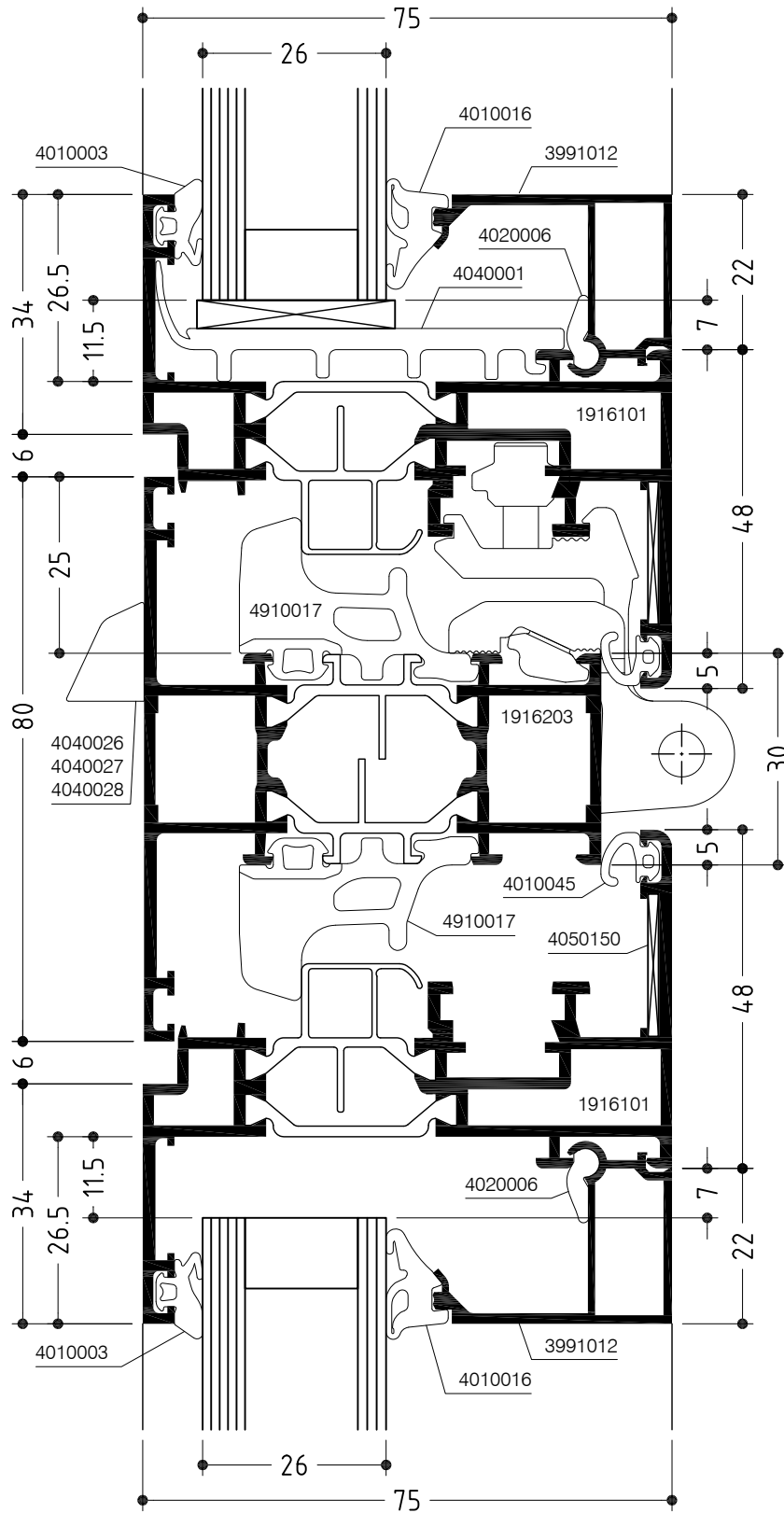
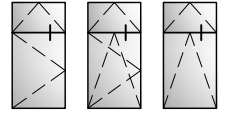



# WICLINE 65

Kämpferprofil nach innen verstärkt mit Festverglasung  
*Internally reinforced transom profile with fixed glazing*

Konstruktionsschnitt  
*Construction section*

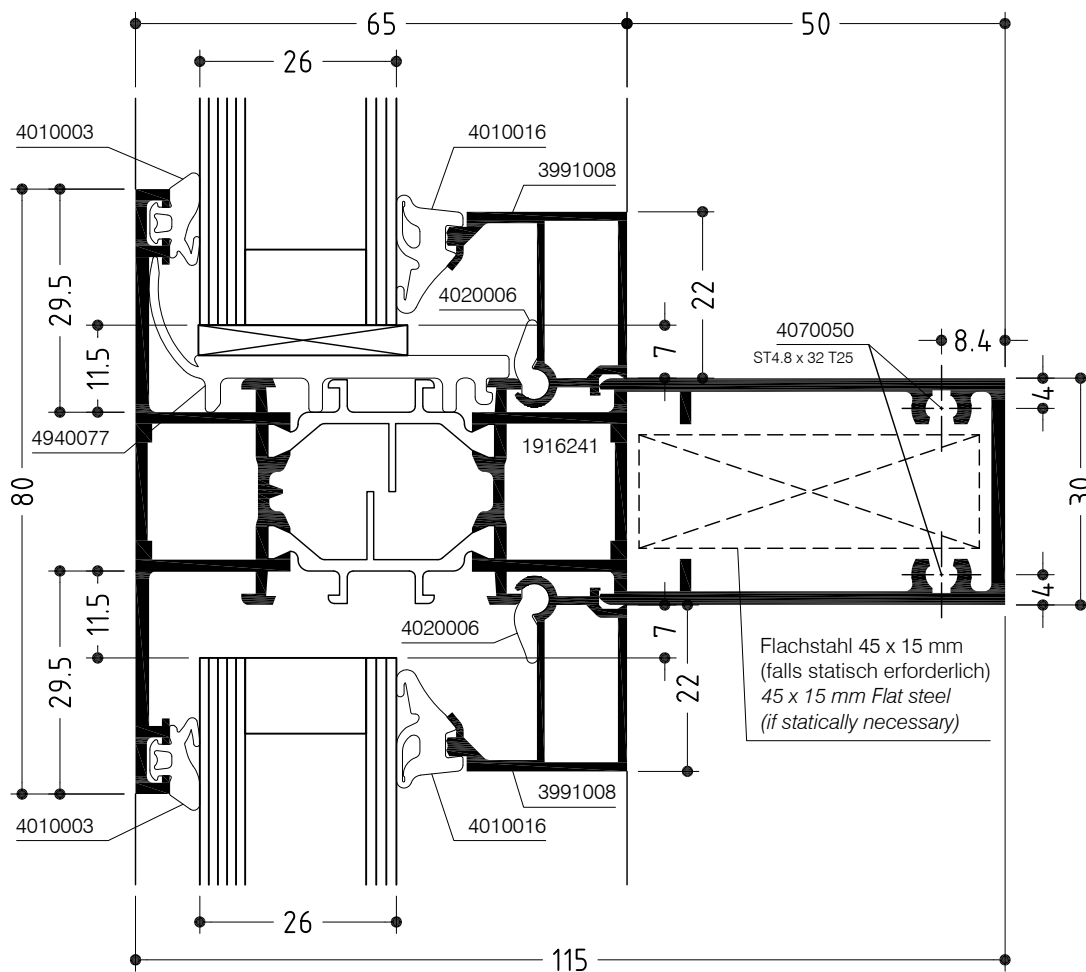
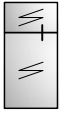

# WICLINE 65

Kämpferprofil nach innen verstärkt mit Falzverbreiterung  
*Internally reinforced transom profile with rebate widening*

Konstruktionsschnitt  
*Construction section*

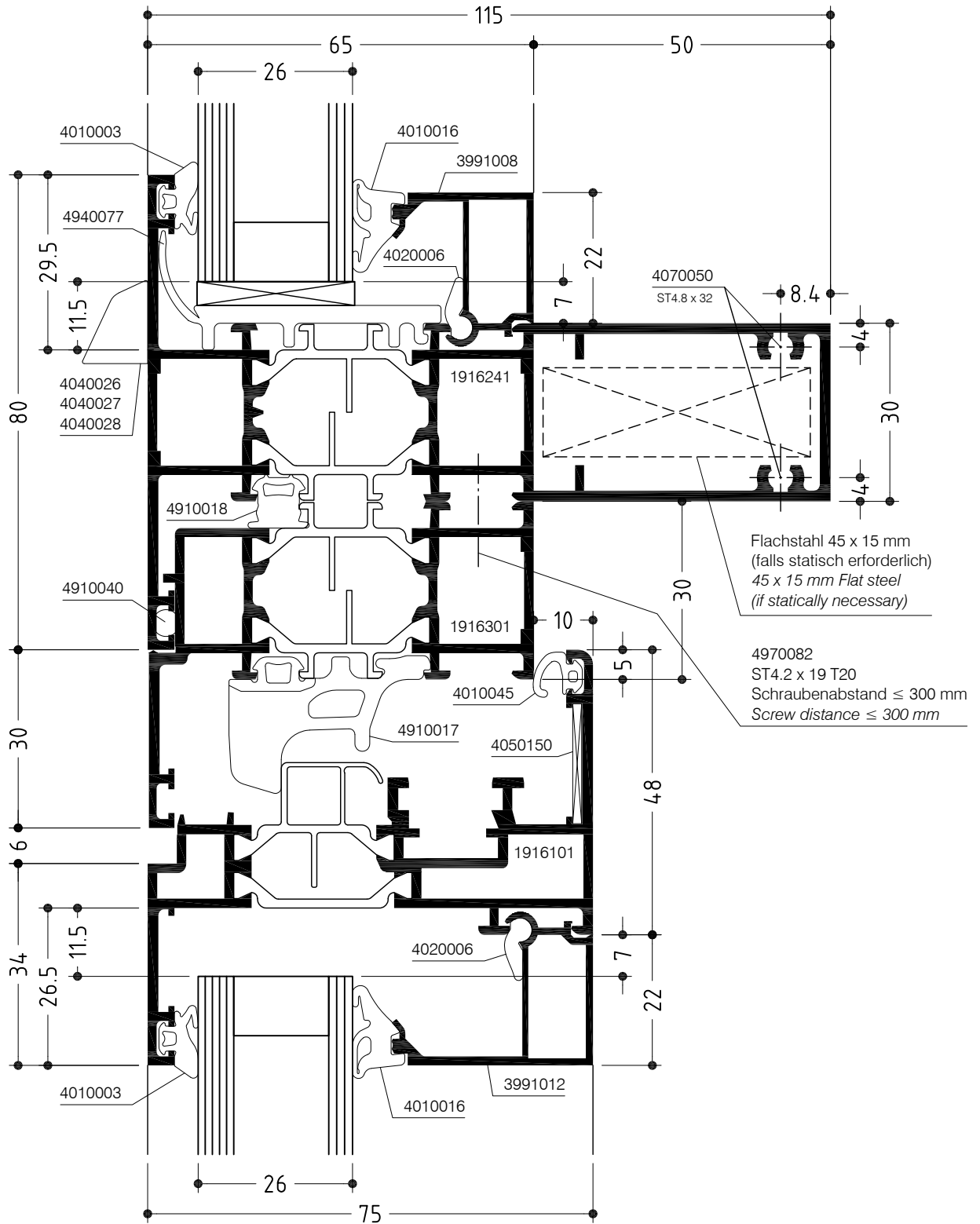
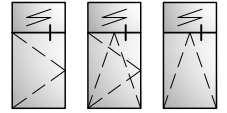

# WICLINE 65

Stützenprofile nach außen verstärkt  
Externally reinforced mullion profiles

Konstruktionsschnitt  
Construction section

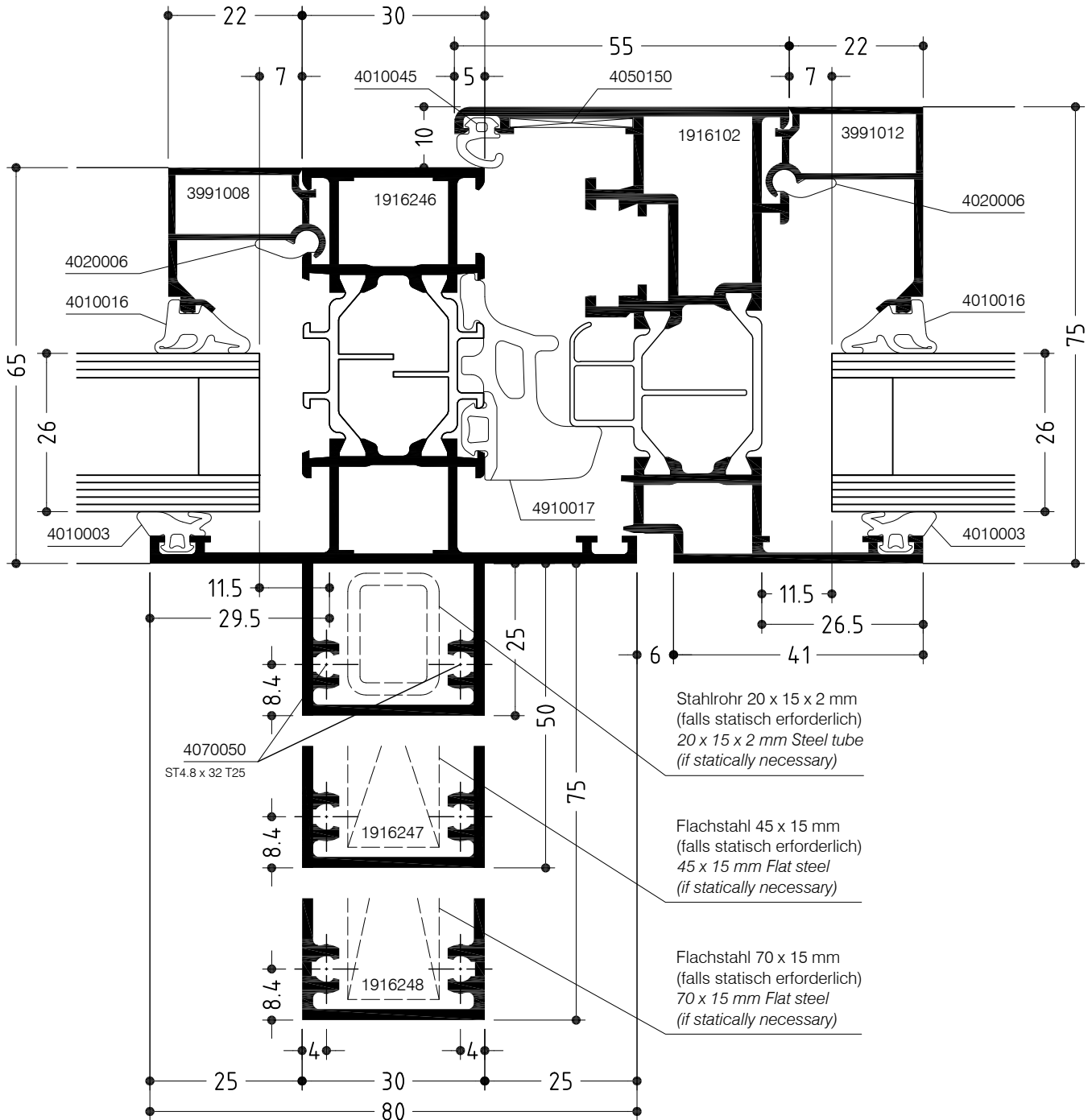
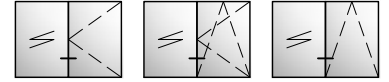

# WICLINE 65

Stützenprofile nach außen verstärkt  
Externally reinforced mullion profiles

Konstruktionsschnitt  
Construction section

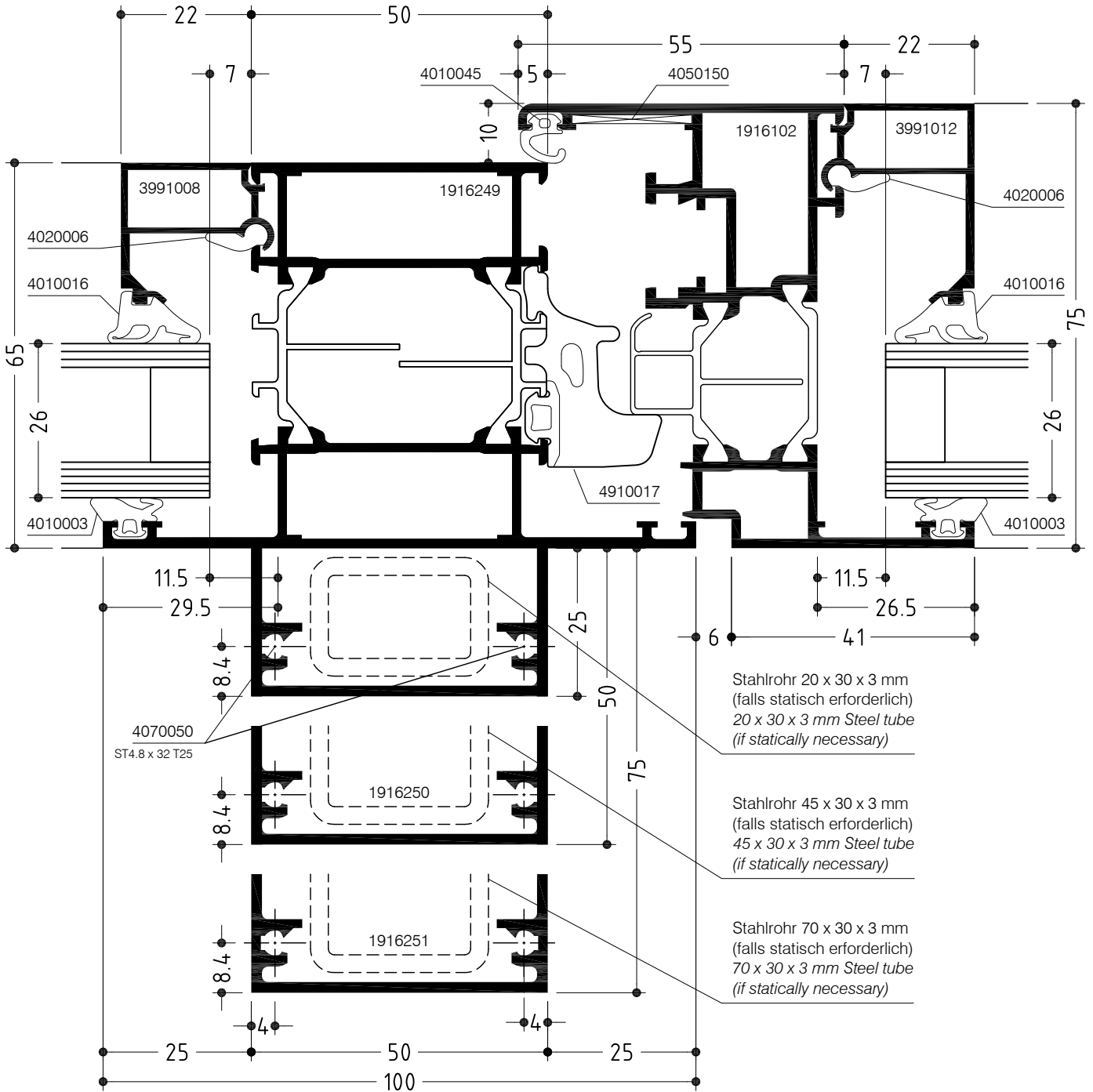
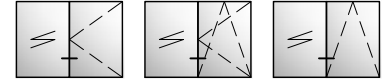

# WICLINE 65

Kämpferprofil nach außen verstärkt  
 Externally reinforced transom profile

Konstruktionsschnitt  
 Construction section

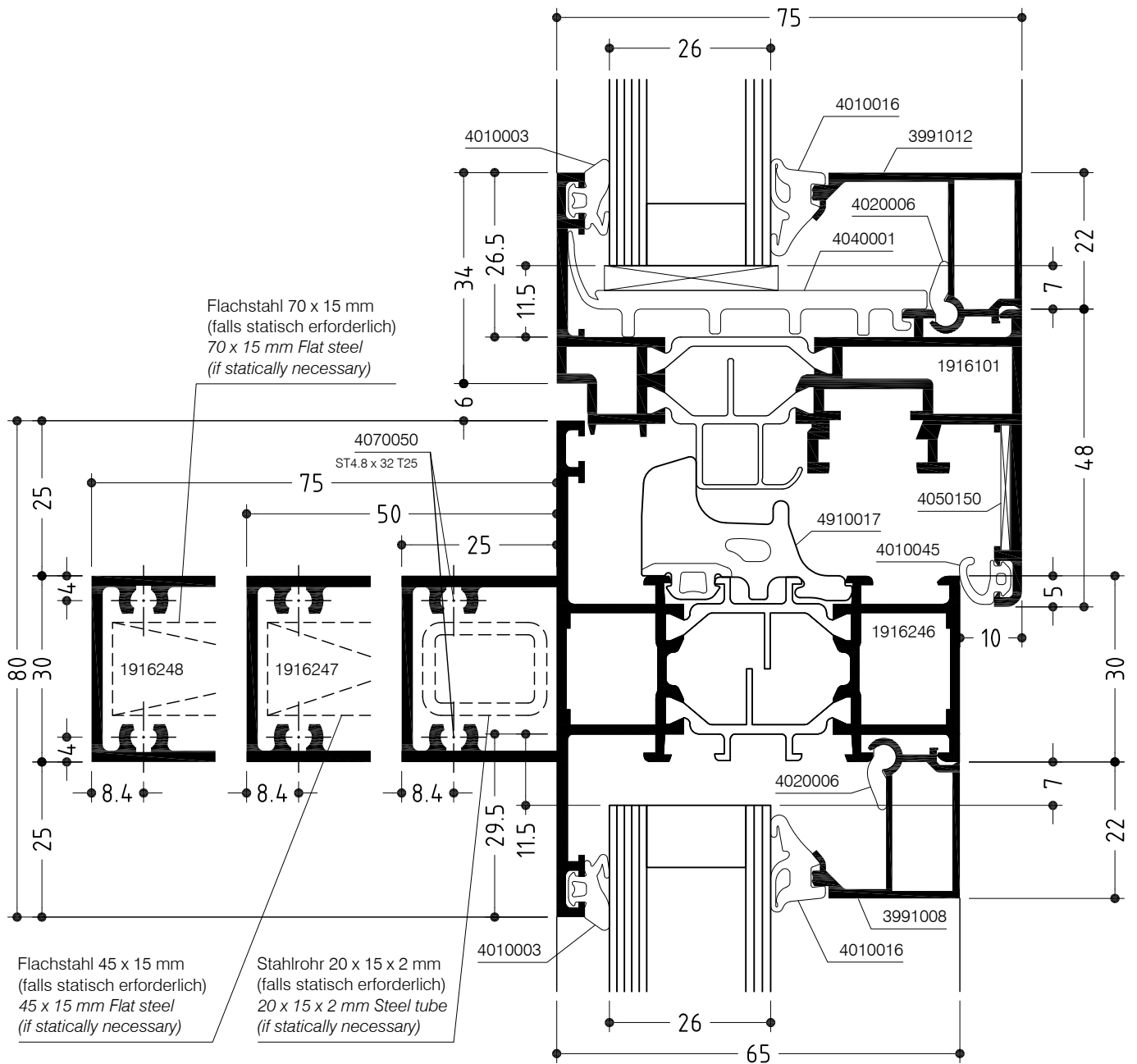
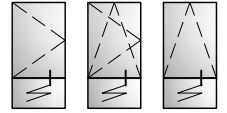

# WICLINE 65

Kämpferprofil nach außen verstärkt  
 Externally reinforced transom profile

Konstruktionsschnitt  
 Construction section

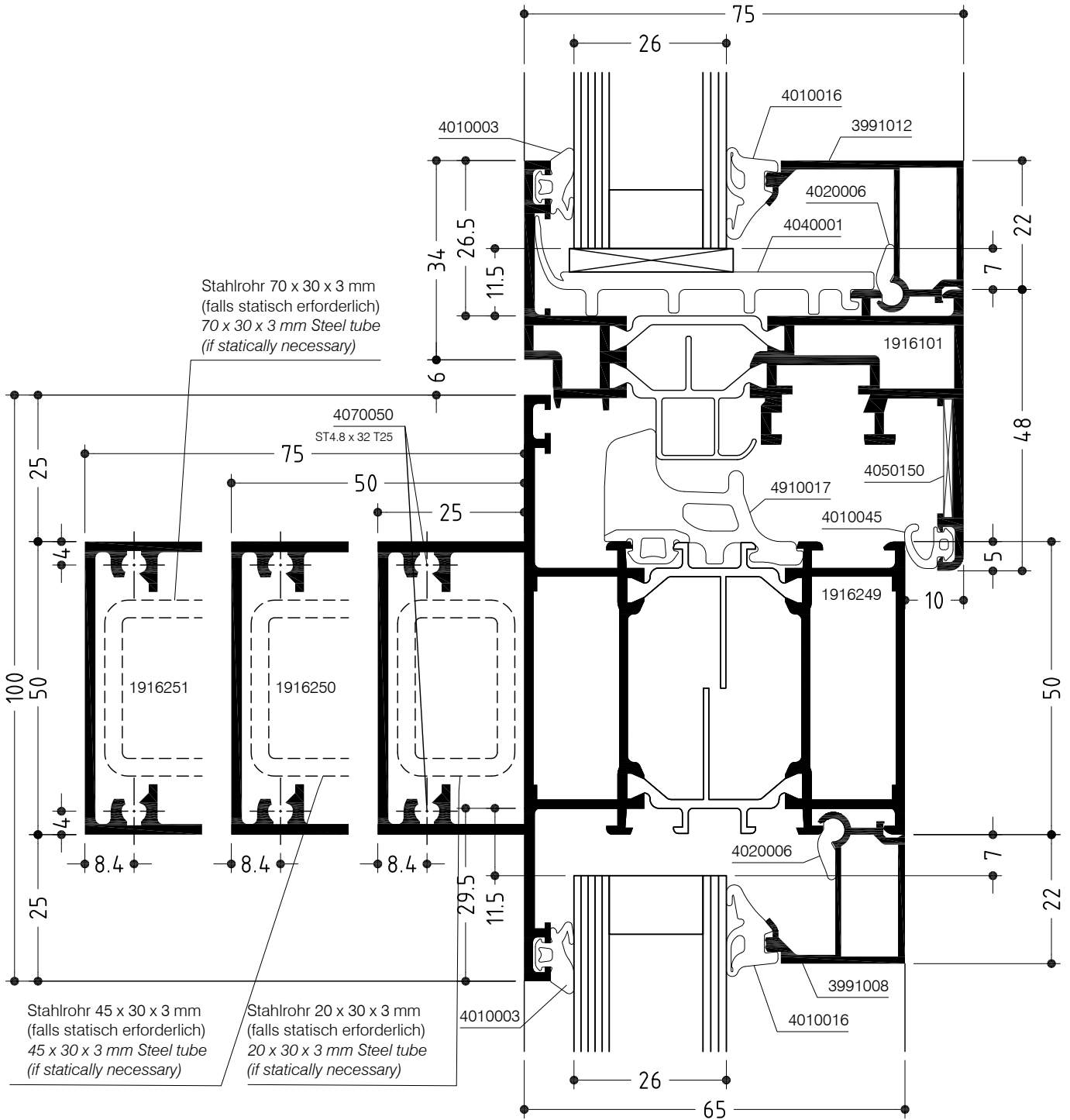
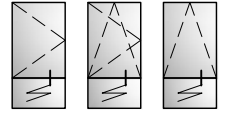

# WICLINE 65

Stützenprofile geteilt, nach außen verstärkt  
Externally reinforced split mullion profiles

Konstruktionsschnitt  
Construction section

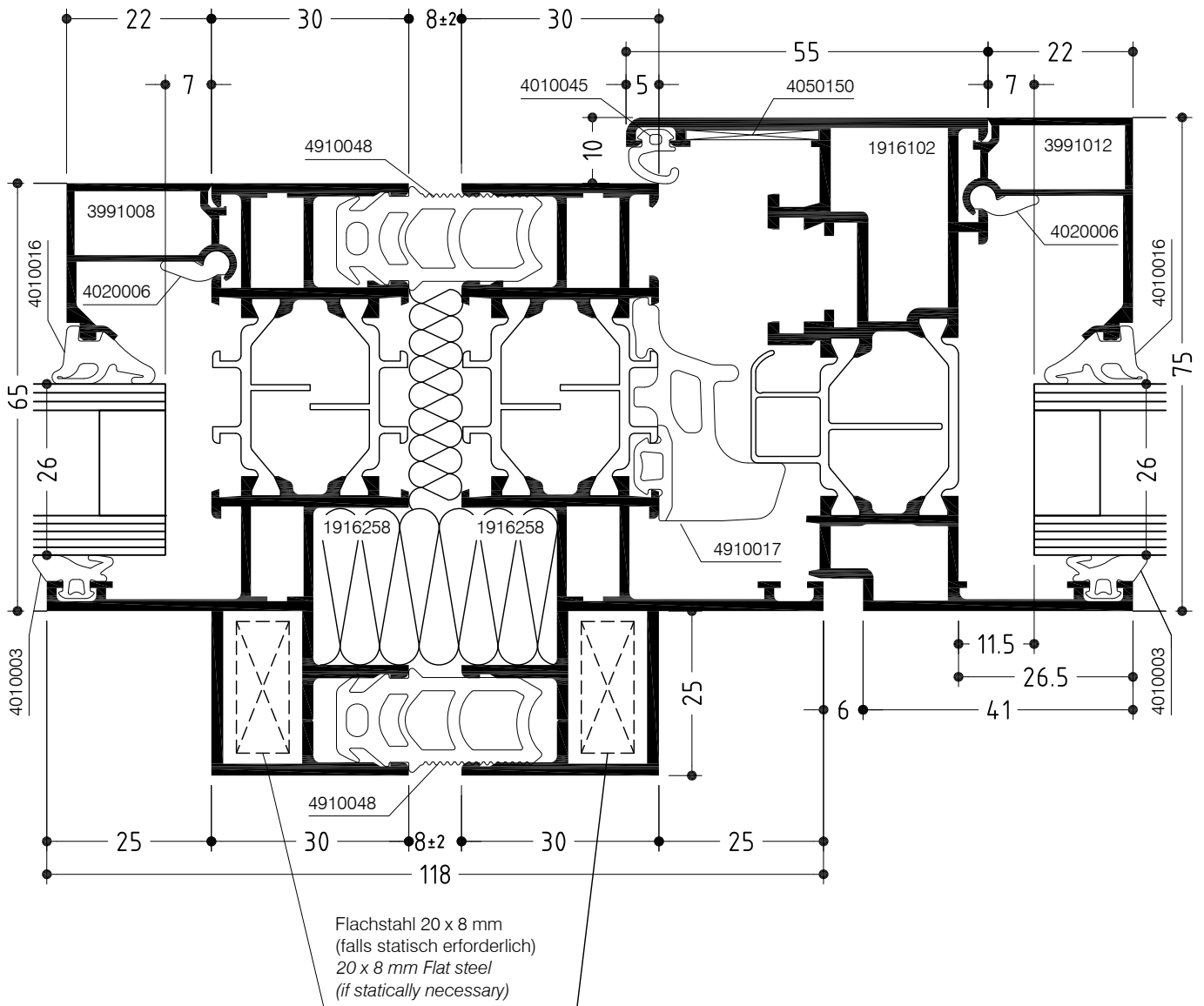
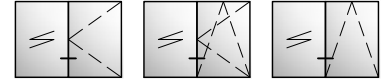





# WICLINE 65

Eckstützenprofil - Außenecke 90°  
 Corner mullion profile of 90° outer corner

Konstruktionsschnitt  
 Construction section

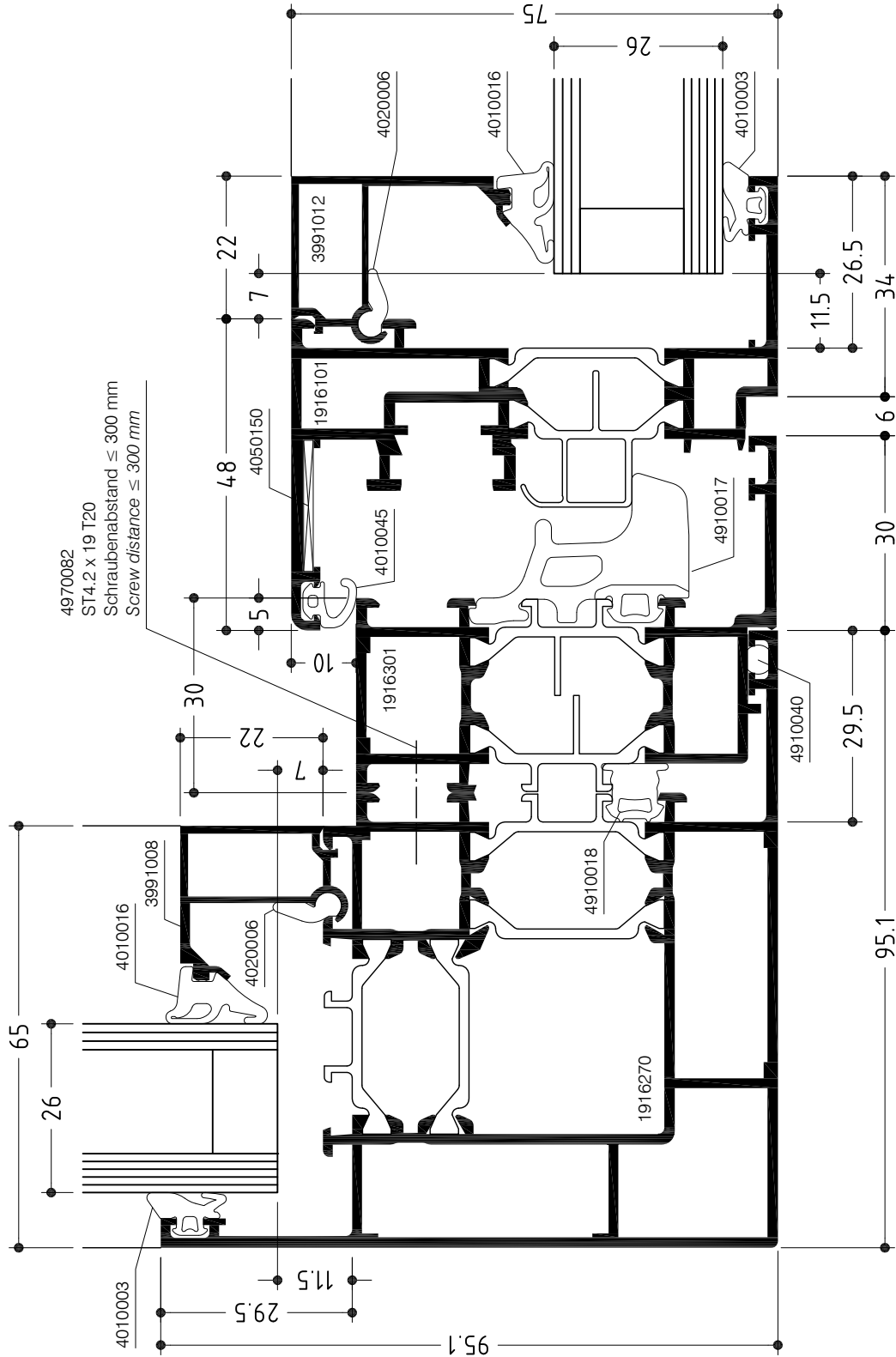
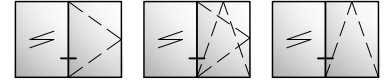

# WICLINE 65

Eckstützenprofil - Innenecke 90°  
 Corner mullion profile of 90° inner corner

Konstruktionsschnitt  
 Construction section

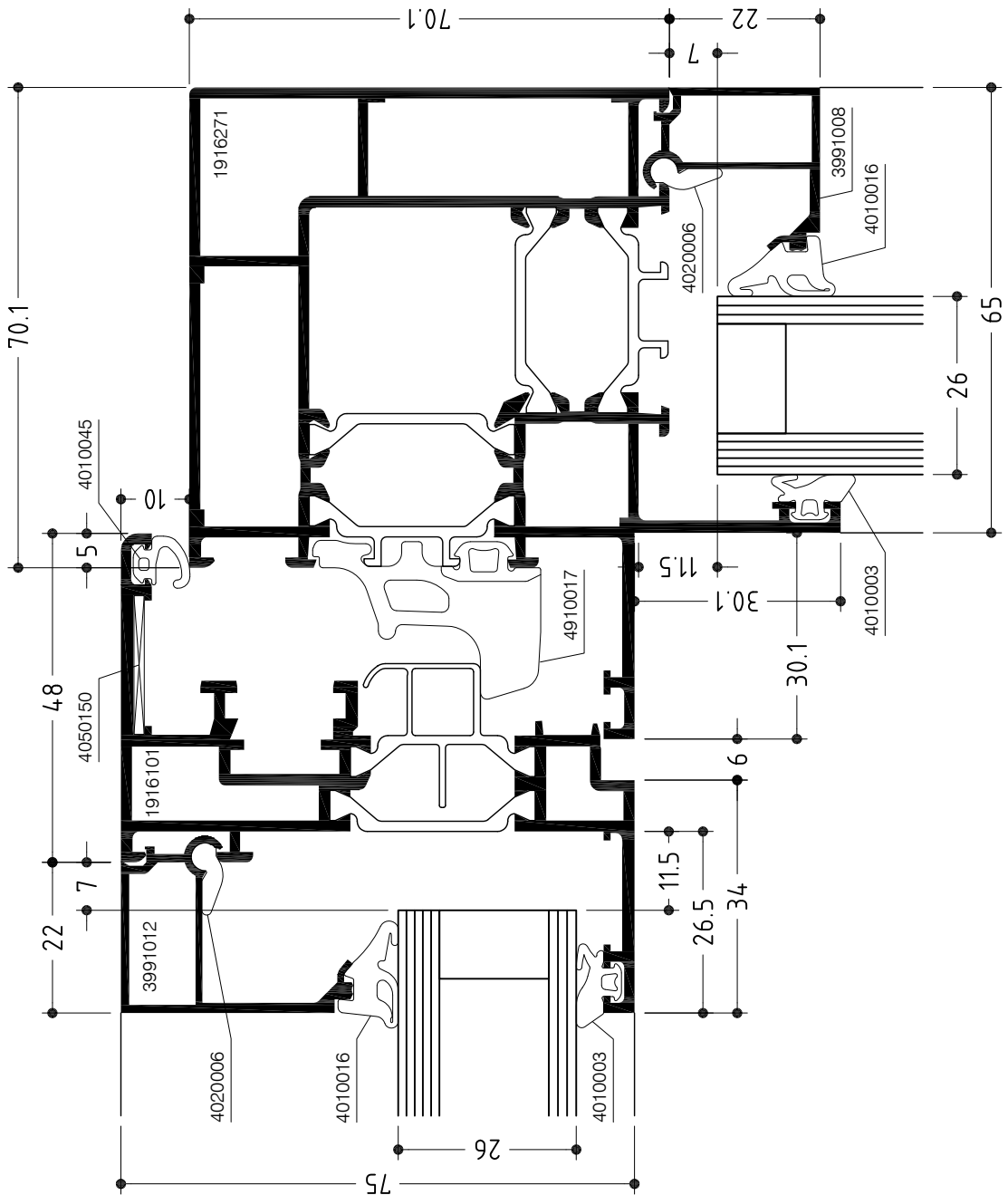
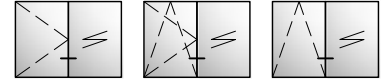



# WICLINE 65

Eckstützenprofil - Innenecke 135°  
 Corner mullion profile of 135° inner corner

Konstruktionsschnitt  
 Construction section

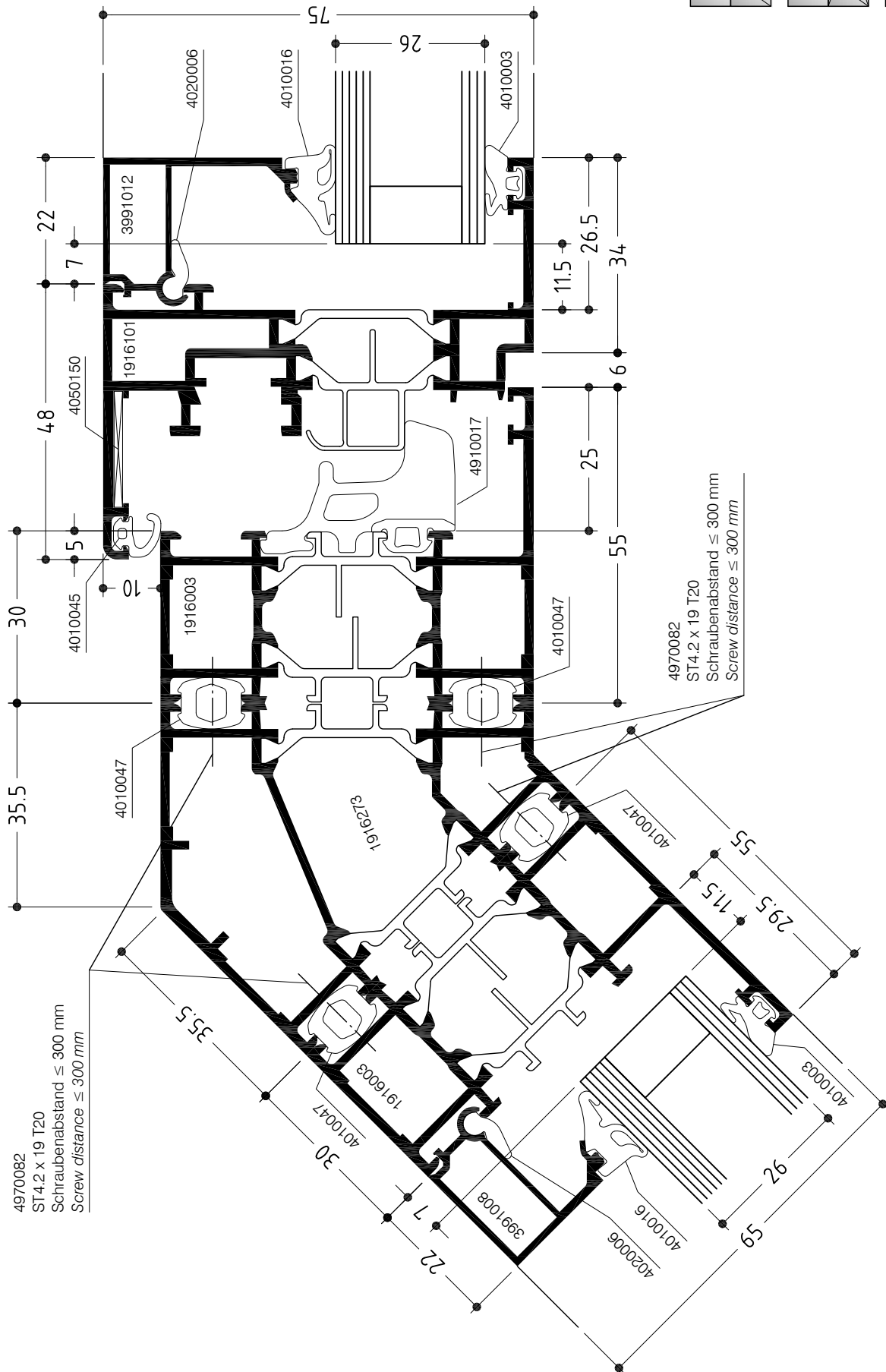
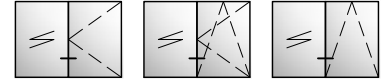

# WICLINE 65

Kämpferprofil mit Plattenmontage von außen  
*Transom profile with panel assembly from outside*

Konstruktionsschnitt  
*Construction section*

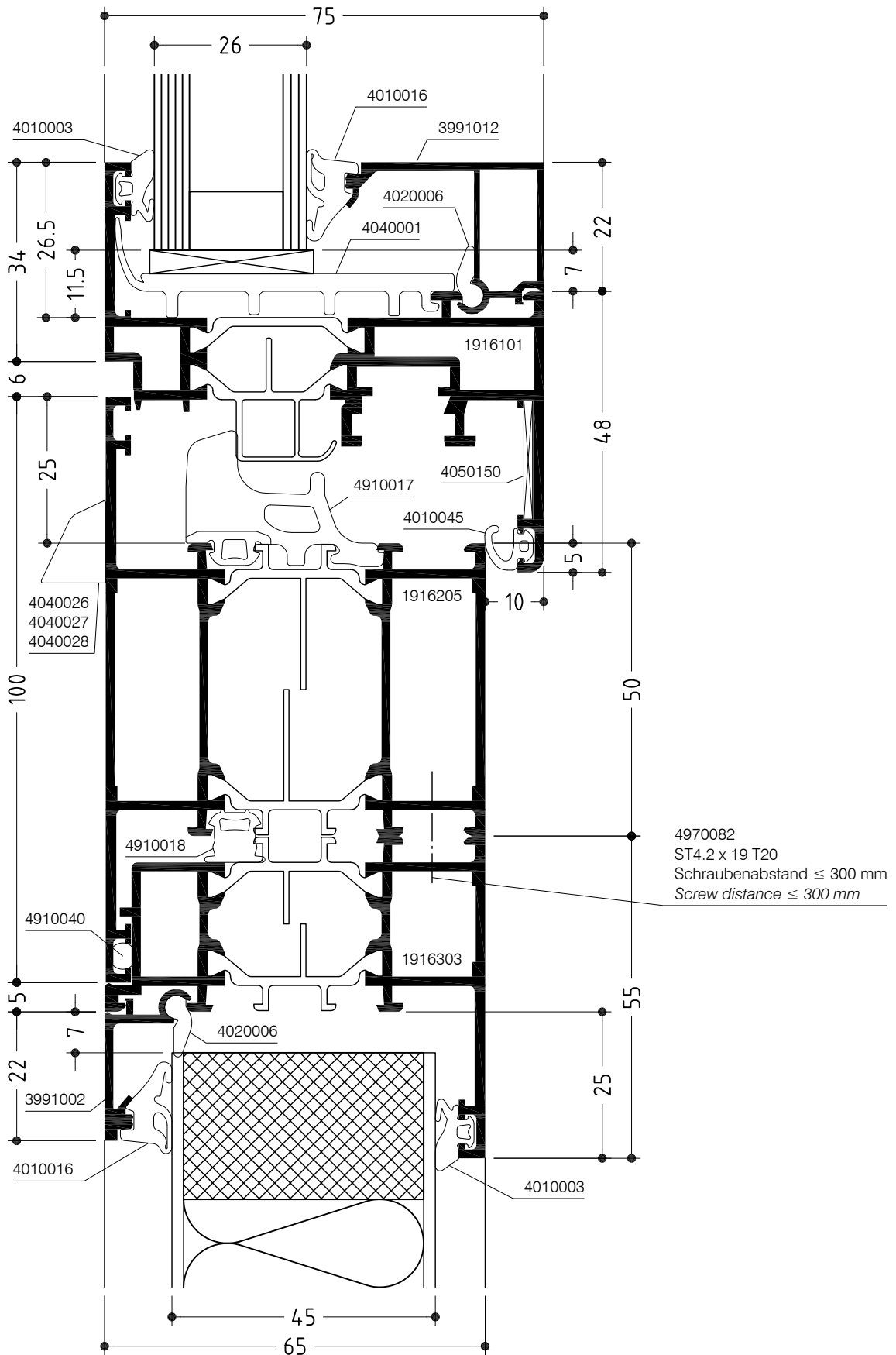
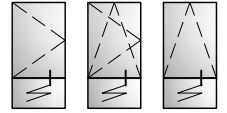

# WICLINE 65

Flügelprofil im Blendrahmen mit Bauanschlussprofil 1916307  
*Sash profile in frame with profile 1916307 for junction to structure*

Konstruktionsschnitt  
*Construction section*

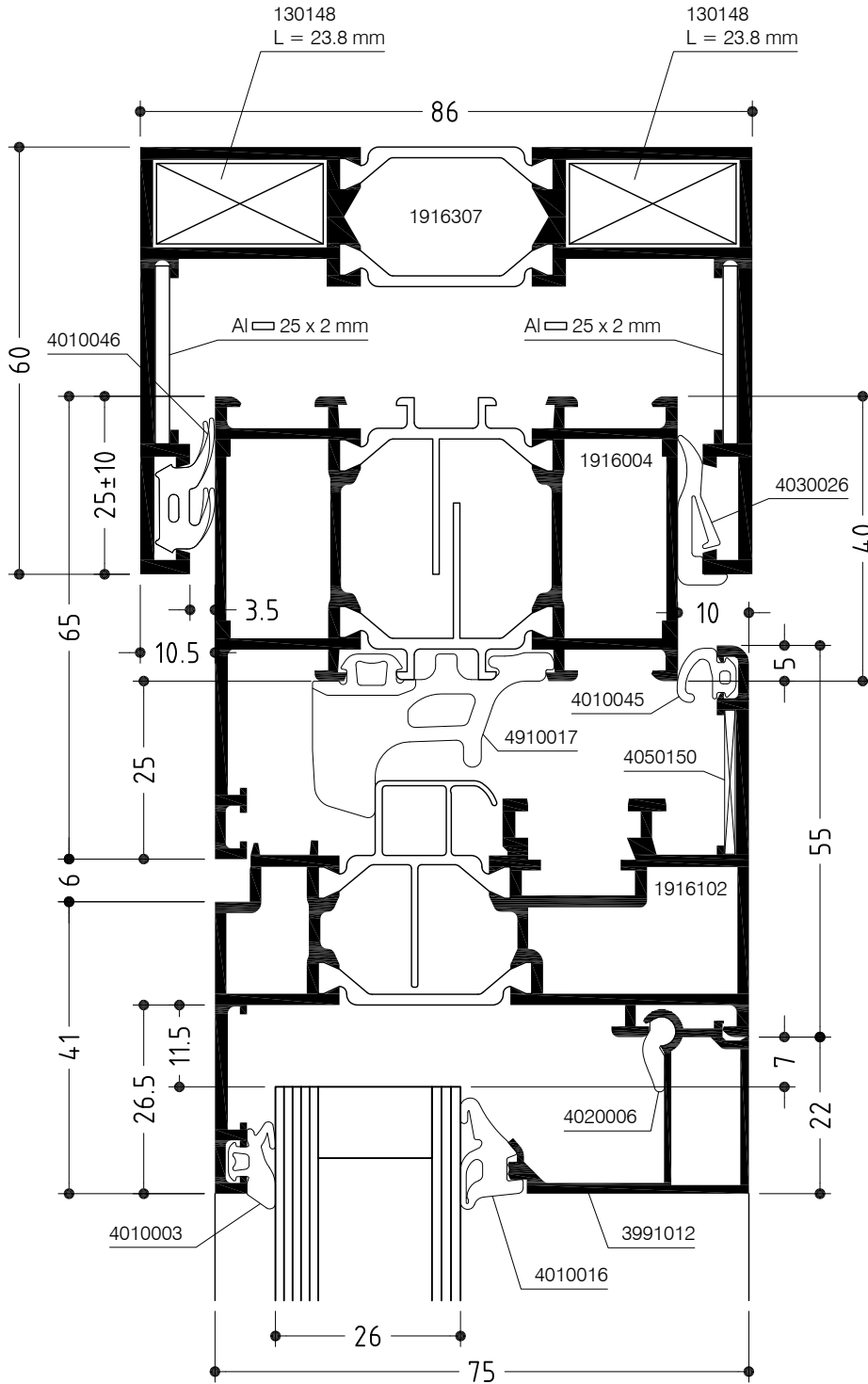

Auf Platzbedarf auftragender  
 Beschläge wie Bänder, Oberlicht-  
 öffener usw. achten.  
*Pay attention to space required for  
 fittings such as hinges, fanlight  
 opener etc.*

# WICLINE 65

Flügelprofil im Einspannblendrahmen  
Sash profile in clamping frame

Konstruktionsschnitt  
Construction section

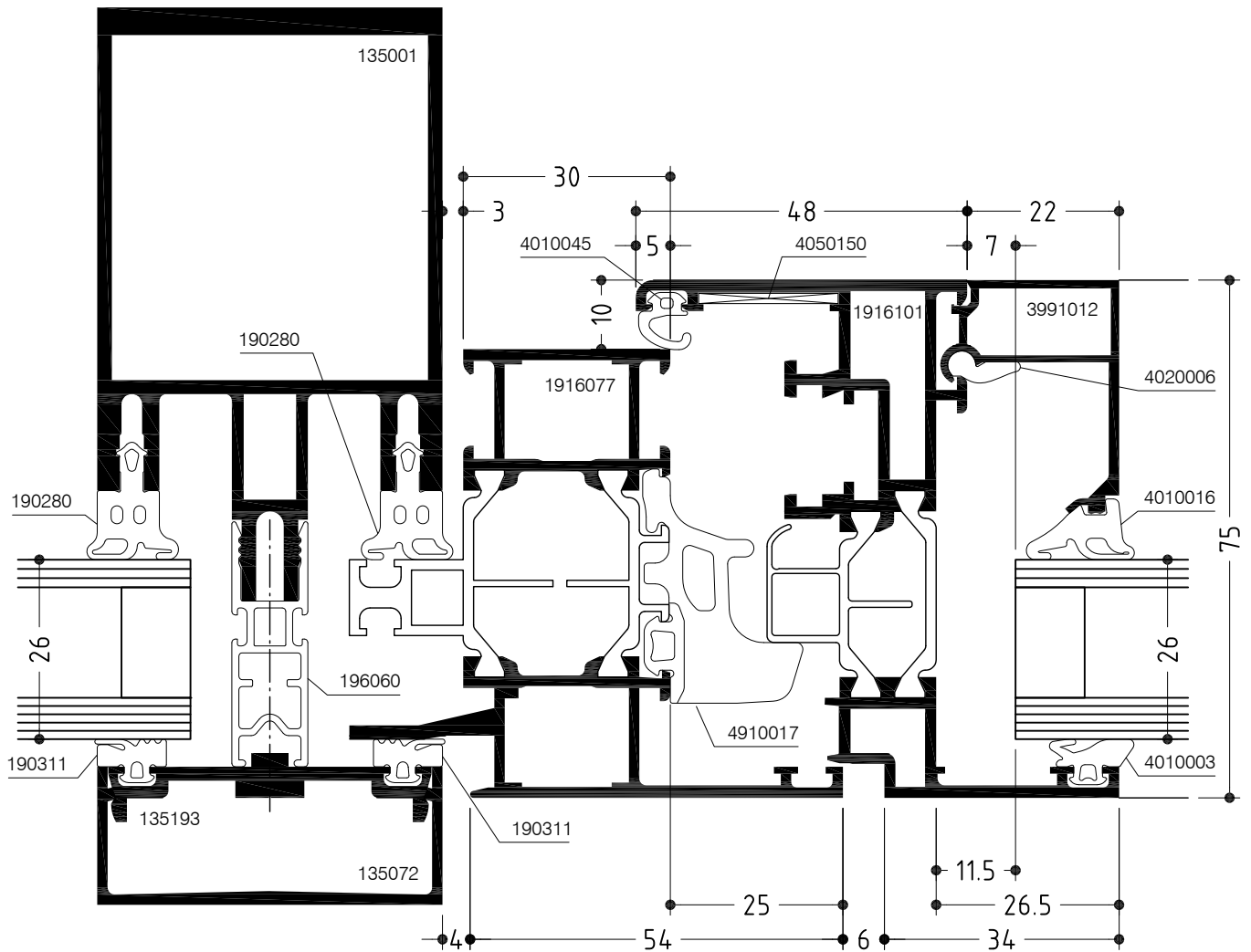

# WICLINE 65

## Konstruktionsschnitt

### Construction section

Flügelprofil im Blendrahmen mit Einspannaufsatz

Sash profile in frame with supplementary clamping profile

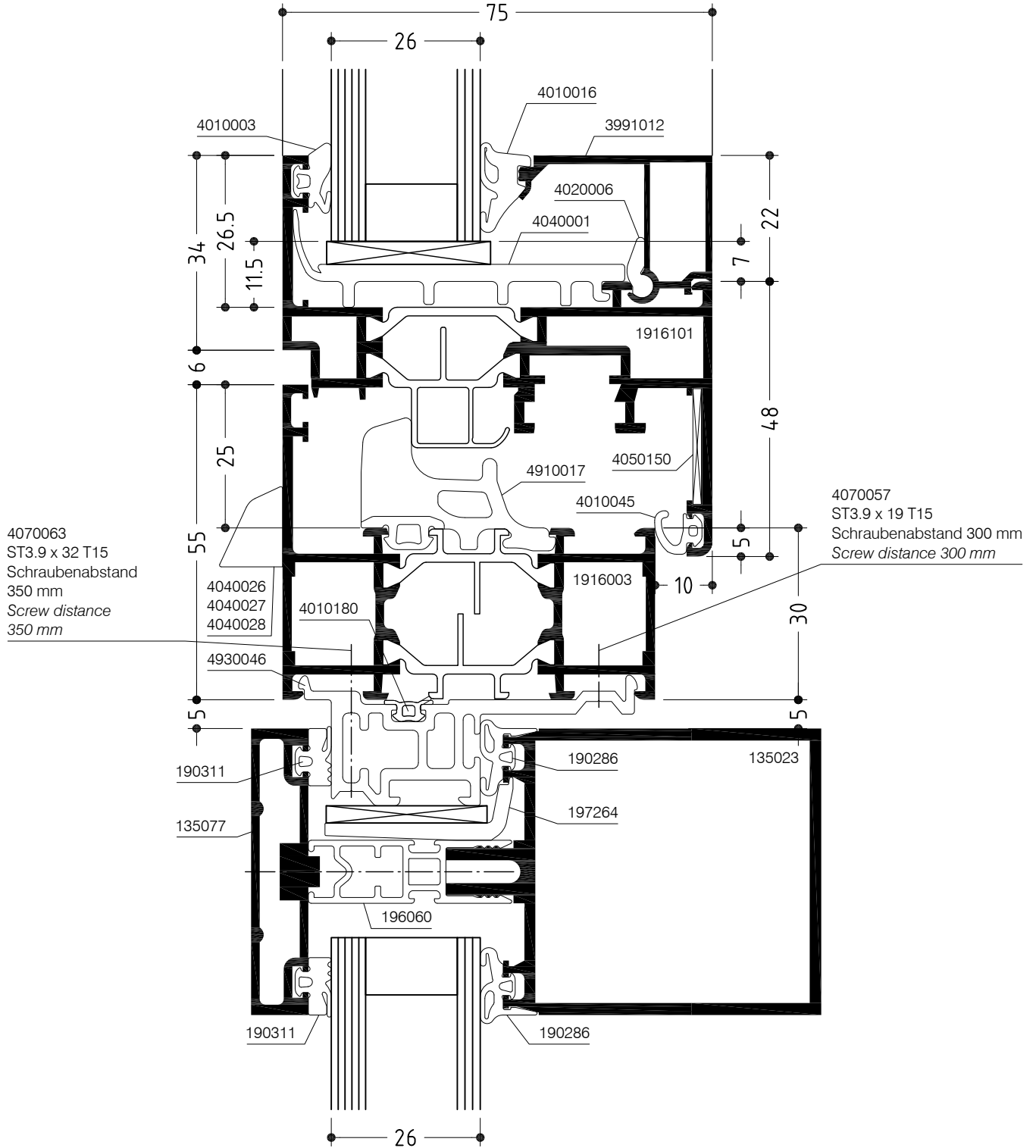
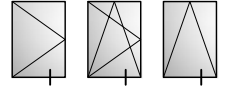



# WICLINE 65

## Konstruktionsschnitt

### Construction section

Bauanschluss unten mit Dämmauflage 4930042

Bottom junction to structure with insulation support 4930042

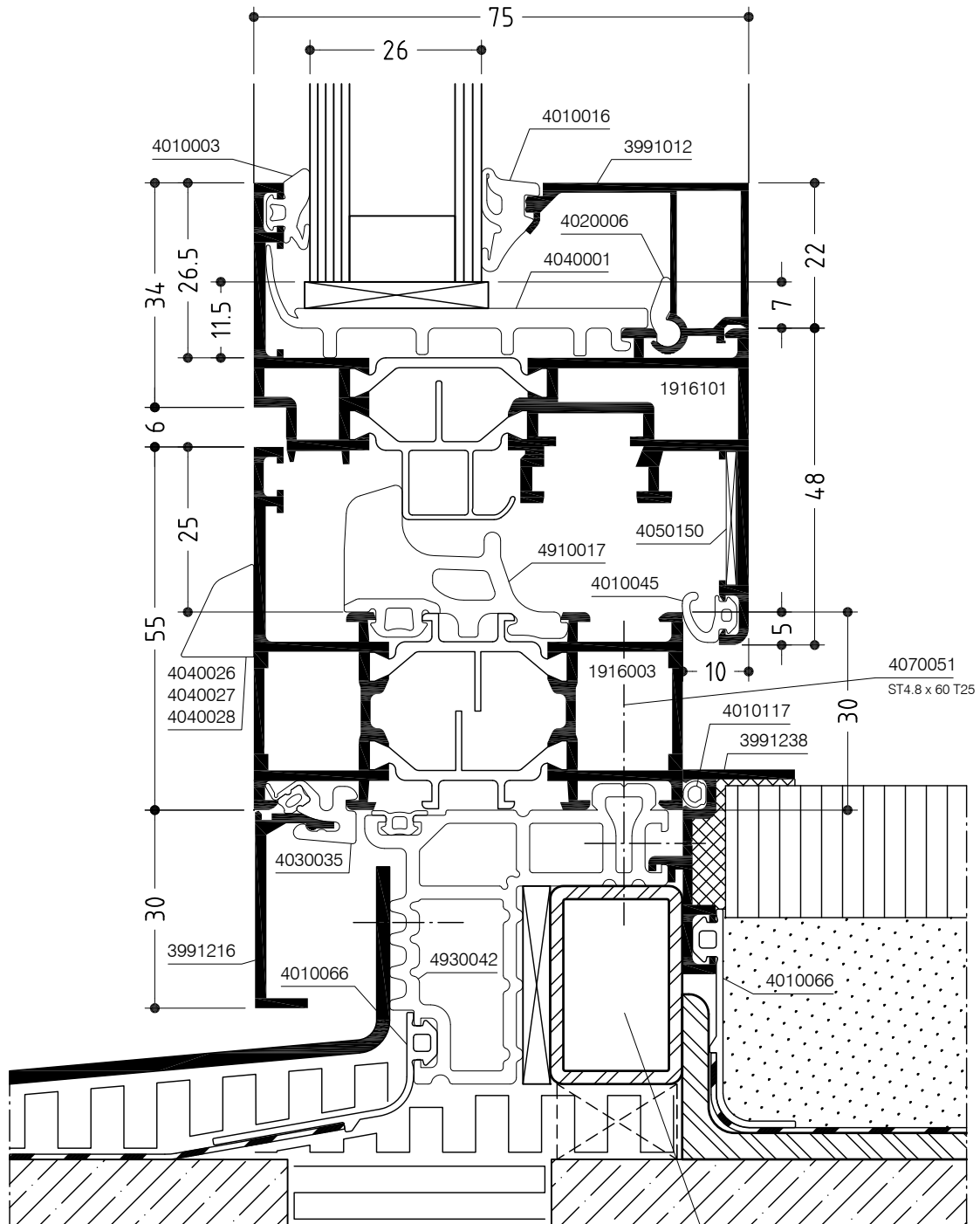

Stahlrohr 20 x 30 x 2  
 verzinkt nach DIN 55928  
 20 x 30 x 2 Steel tube,  
 galv. acc. to DIN 55928

# WICLINE 65

## Konstruktionsschnitt

### Construction section

Bauanschluss unten mit Dämmauflage 4930043

Bottom junction to structure with insulation support 4930043

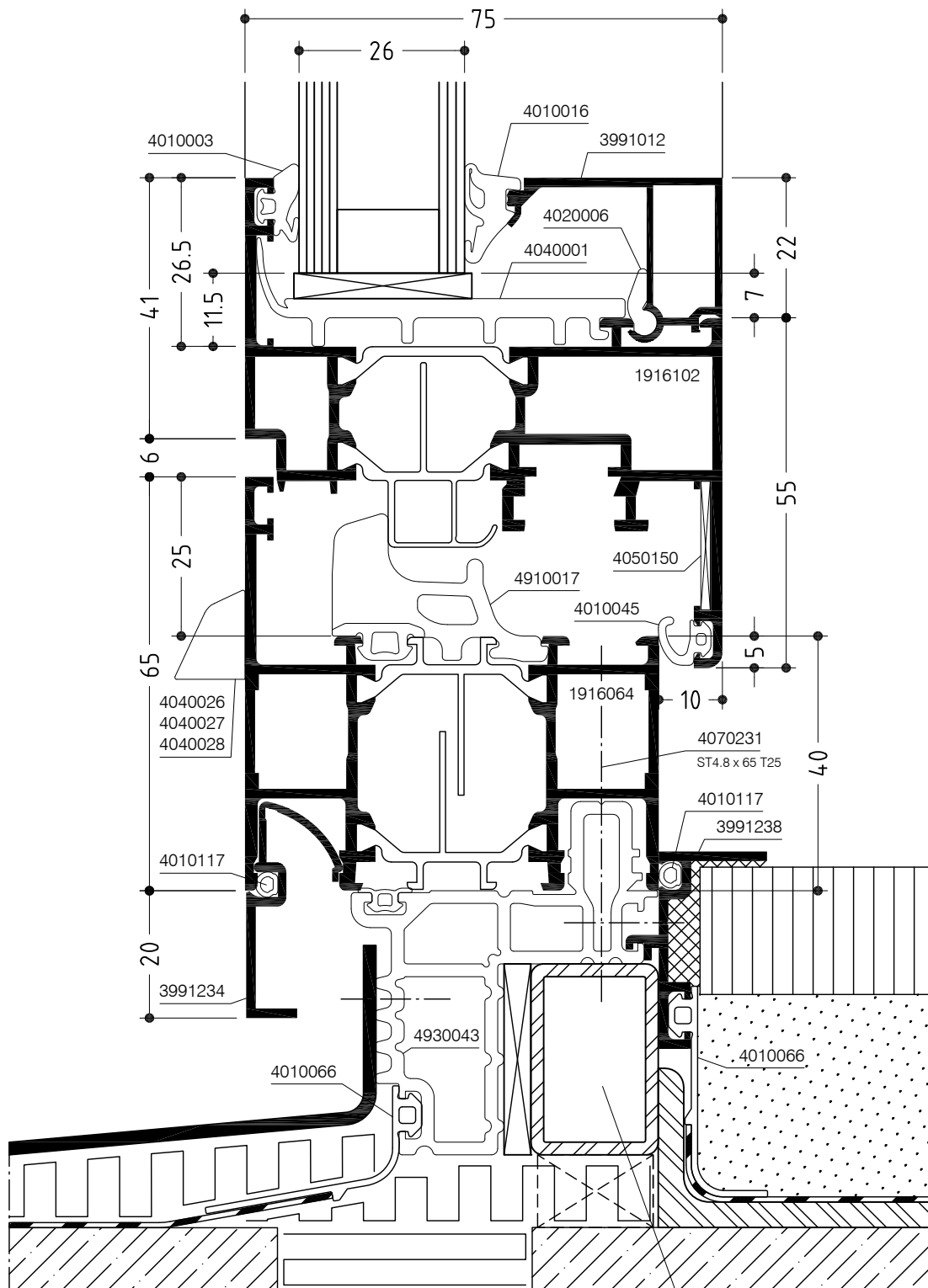

Stahlrohr 20 x 30 x 2  
verzinkt nach DIN 55928  
20 x 30 x 2 Steel tube,  
galv. acc. to DIN 55928

# WICLINE 65

Flügelprofil im Blendrahmen, Klassik-Design  
Sash profile in frame, Classic design

Konstruktionsschnitt  
Construction section

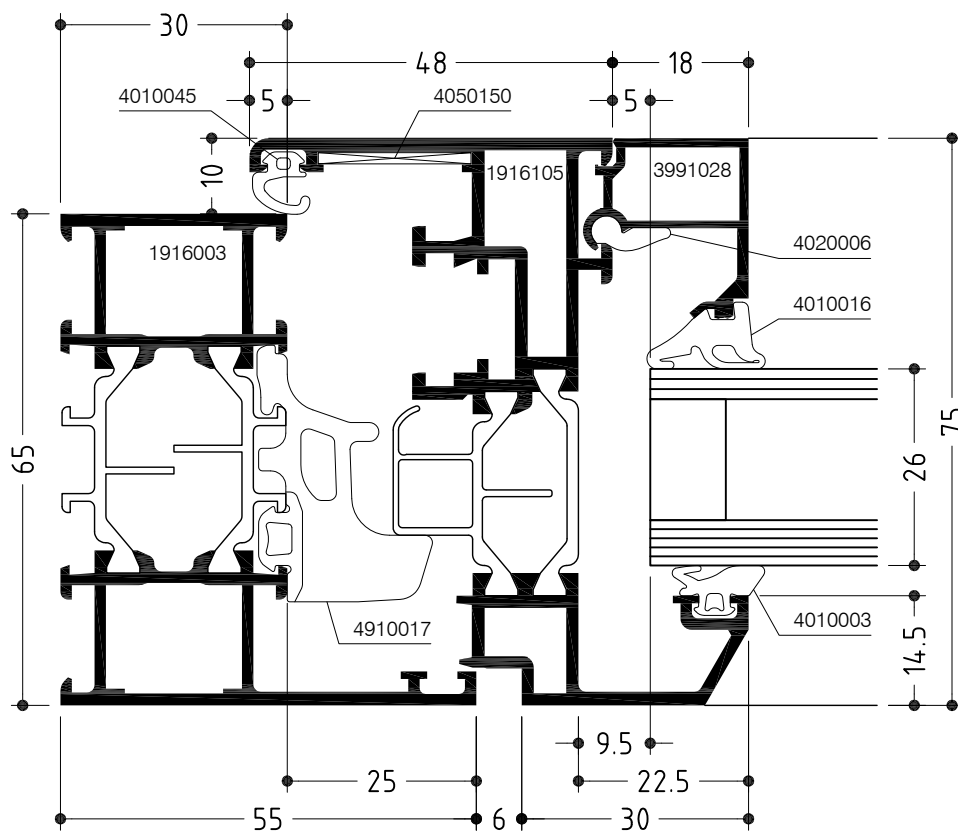

# WICLINE 65

Flügelprofil im Blendrahmen, Klassik-Design  
Sash profile in frame, Classic design

Konstruktionsschnitt  
Construction section

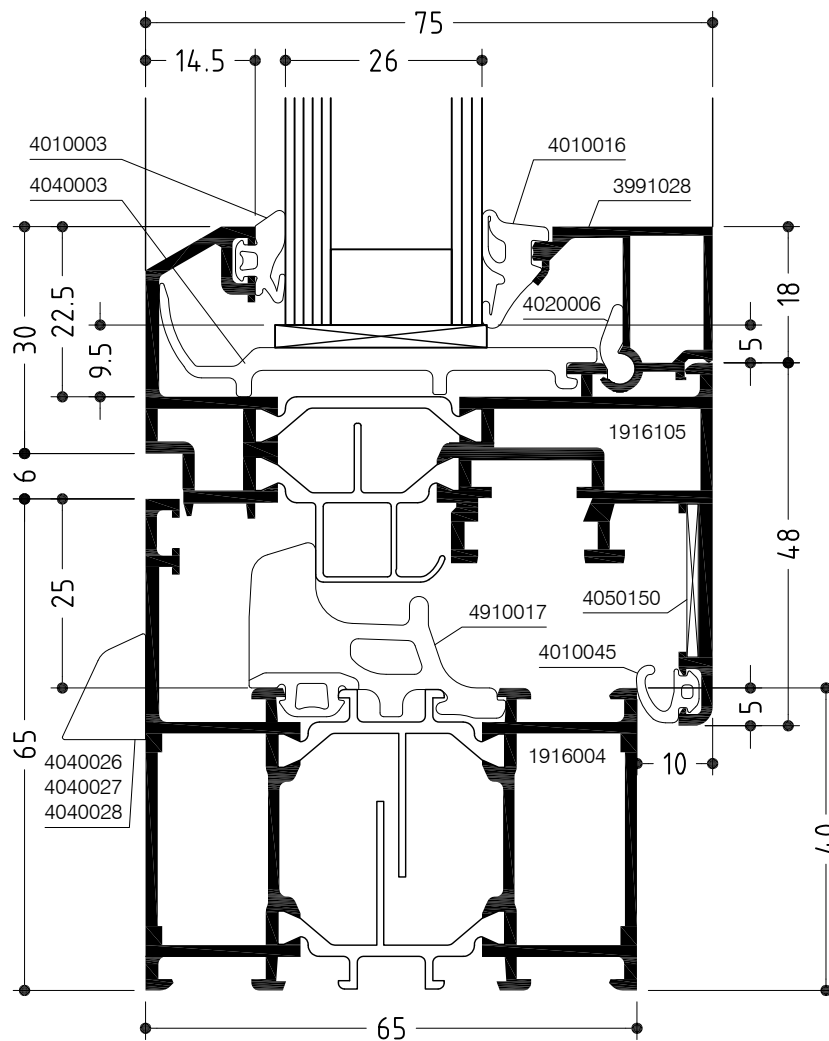

# WICLINE 65

Flügelprofil im Blendrahmen, Klassik-Design  
Sash profile in frame, Classic design

Konstruktionsschnitt  
Construction section

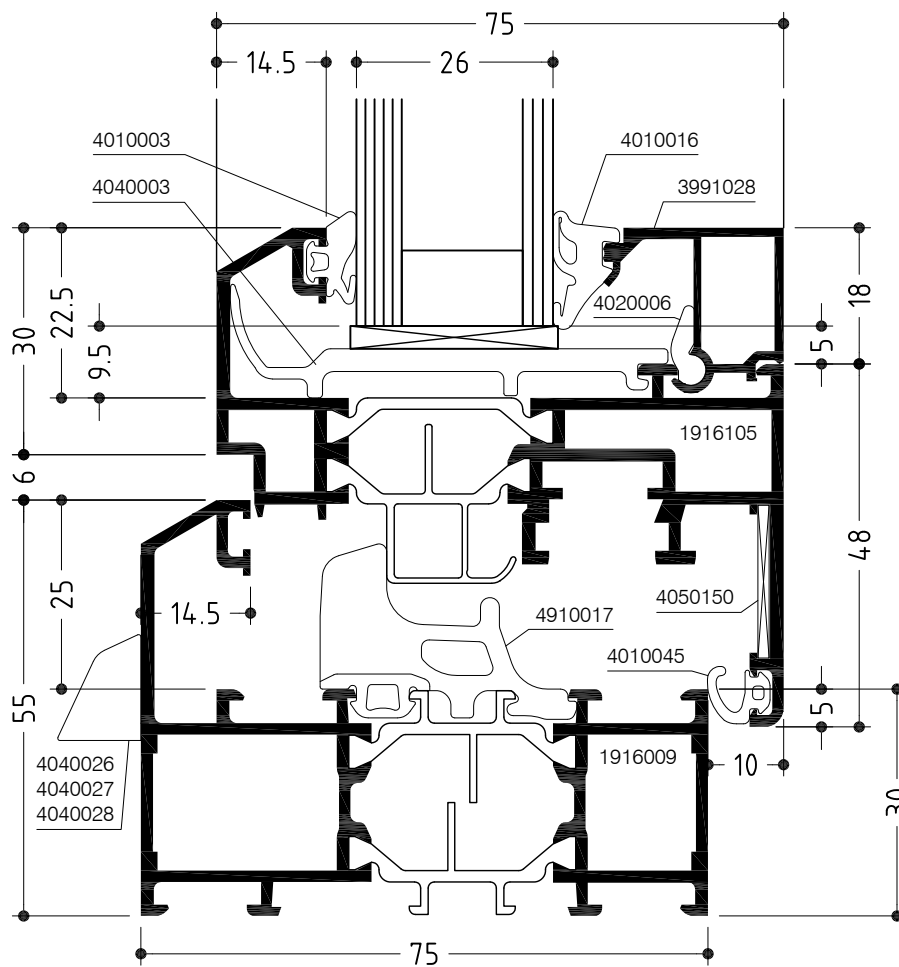

# WICLINE 65

Flügelprofil im Blendrahmen, Klassik-Design  
Sash profile in frame, Classic design

Konstruktionsschnitt  
Construction section

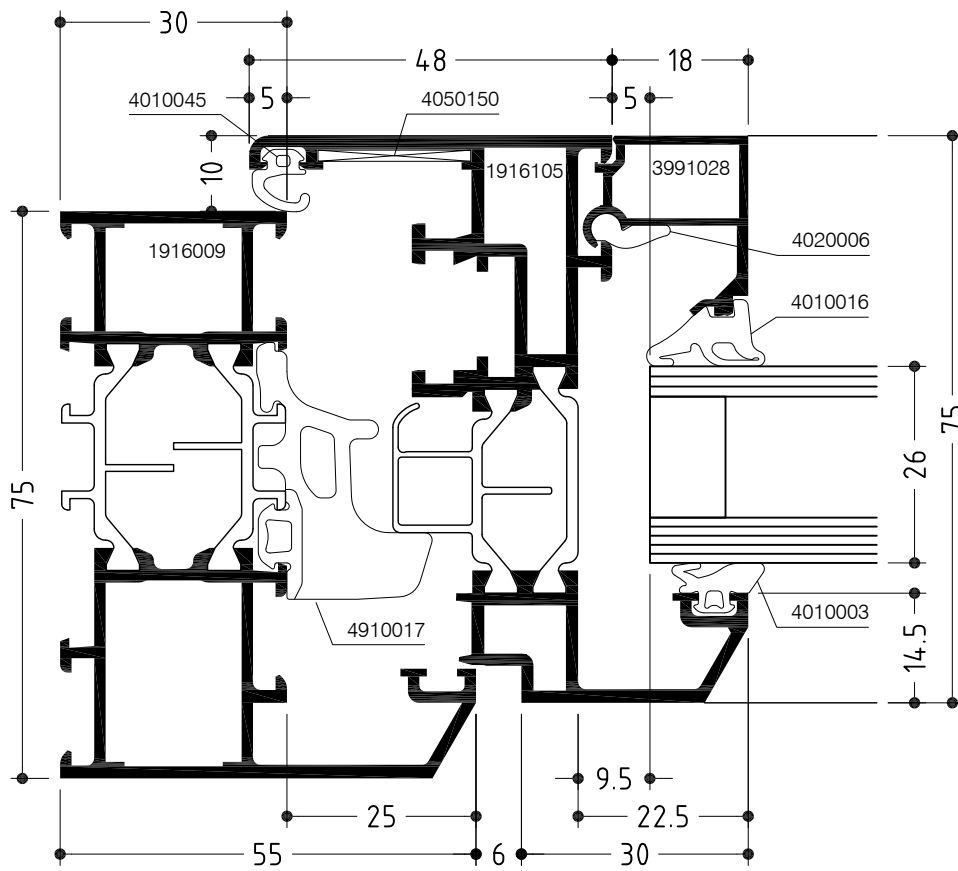

# WICLINE 65

Stulpfenster - Mittelstoß, Klassik-Design  
Double casement window - Meeting stiles, Classic design

Konstruktionsschnitt  
Construction section

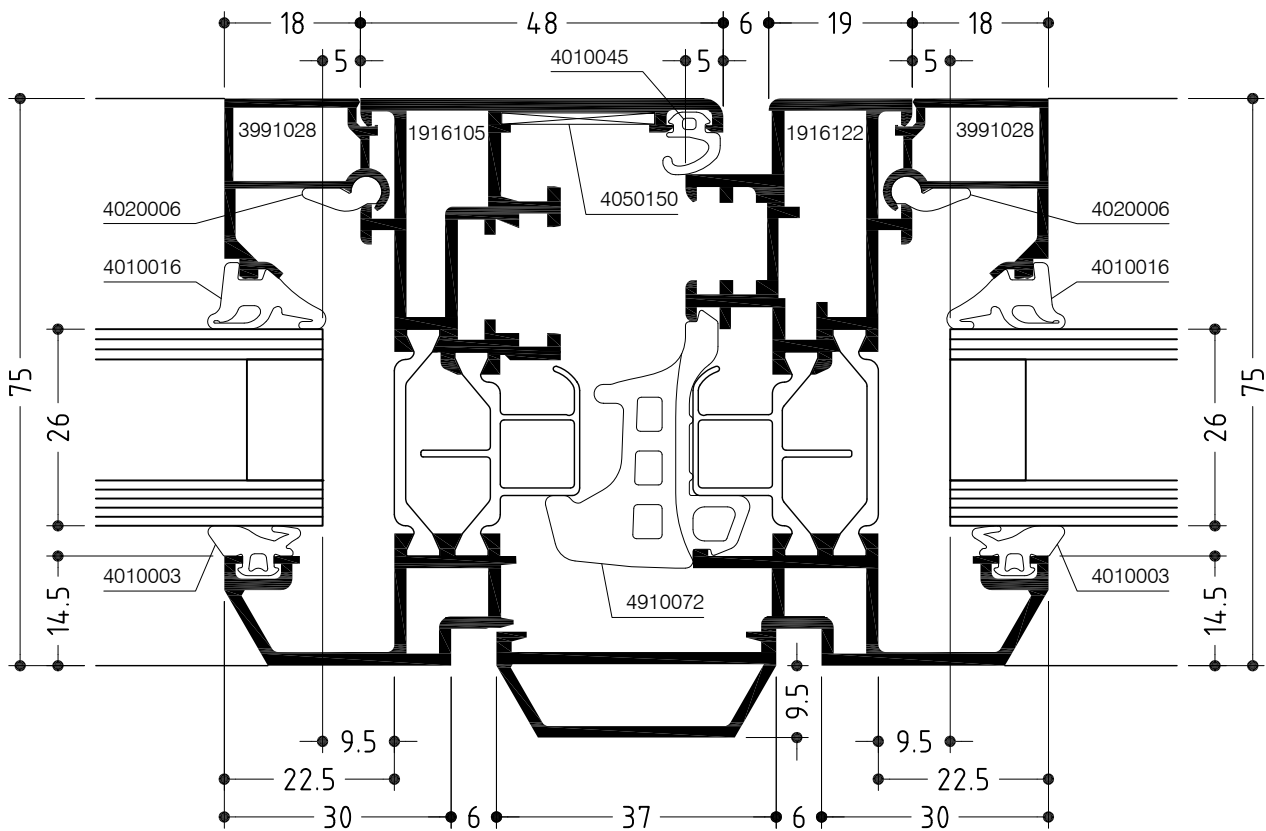
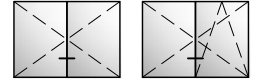

# WICLINE 65

## Konstruktionsschnitt

### Construction section

Stulpfenster mit Aufsatzprofil - Mittelstoß, Klassik-Design

Double casement window with supplm. profile - Meeting stiles, Classic design

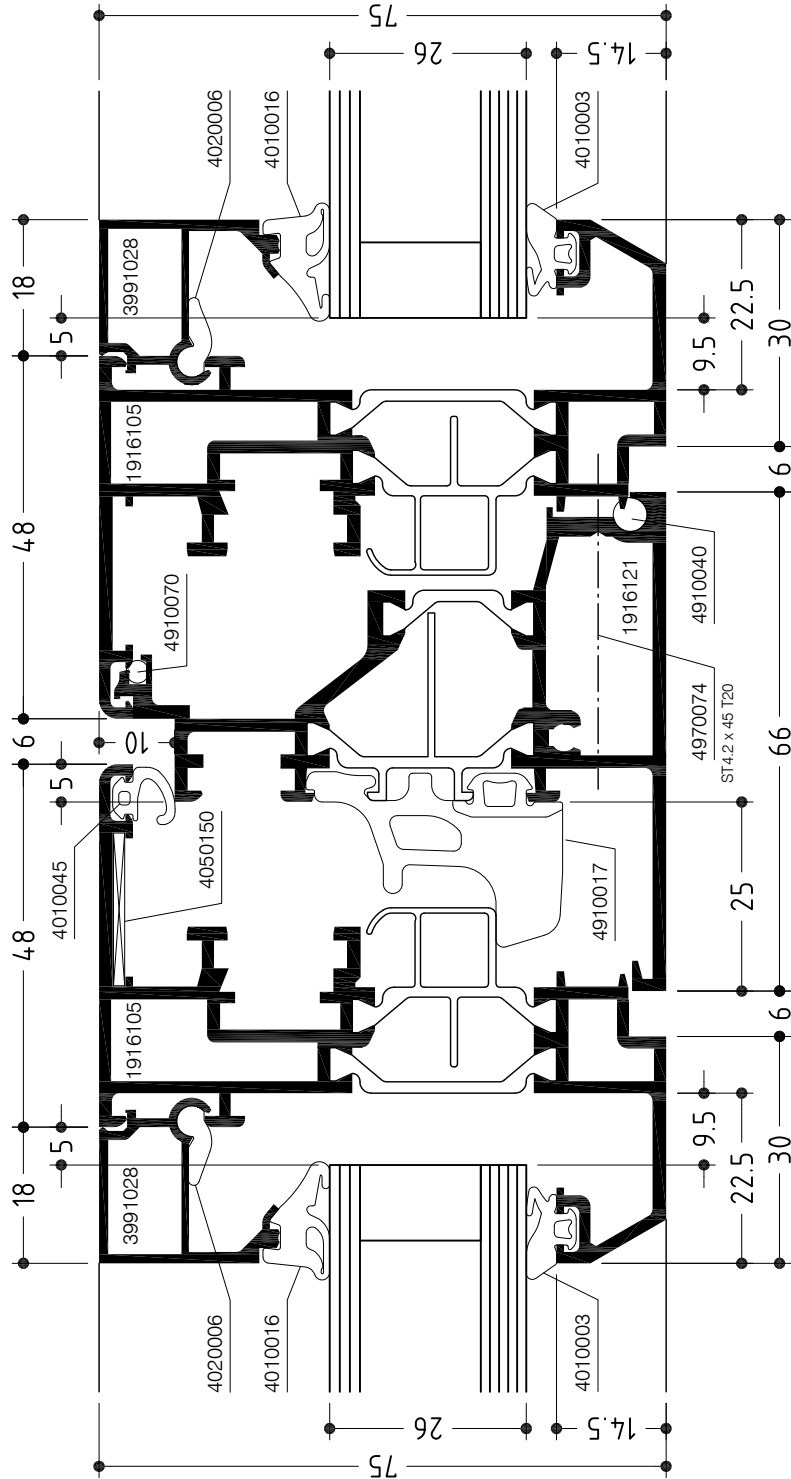
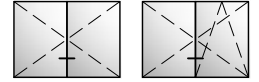



# WICLINE 65

Flügelprofil im Blendrahmen mit Kämpfer, Klassik-Design  
Sash profile in frame with transom, Classic design

Konstruktionsschnitt  
Construction section

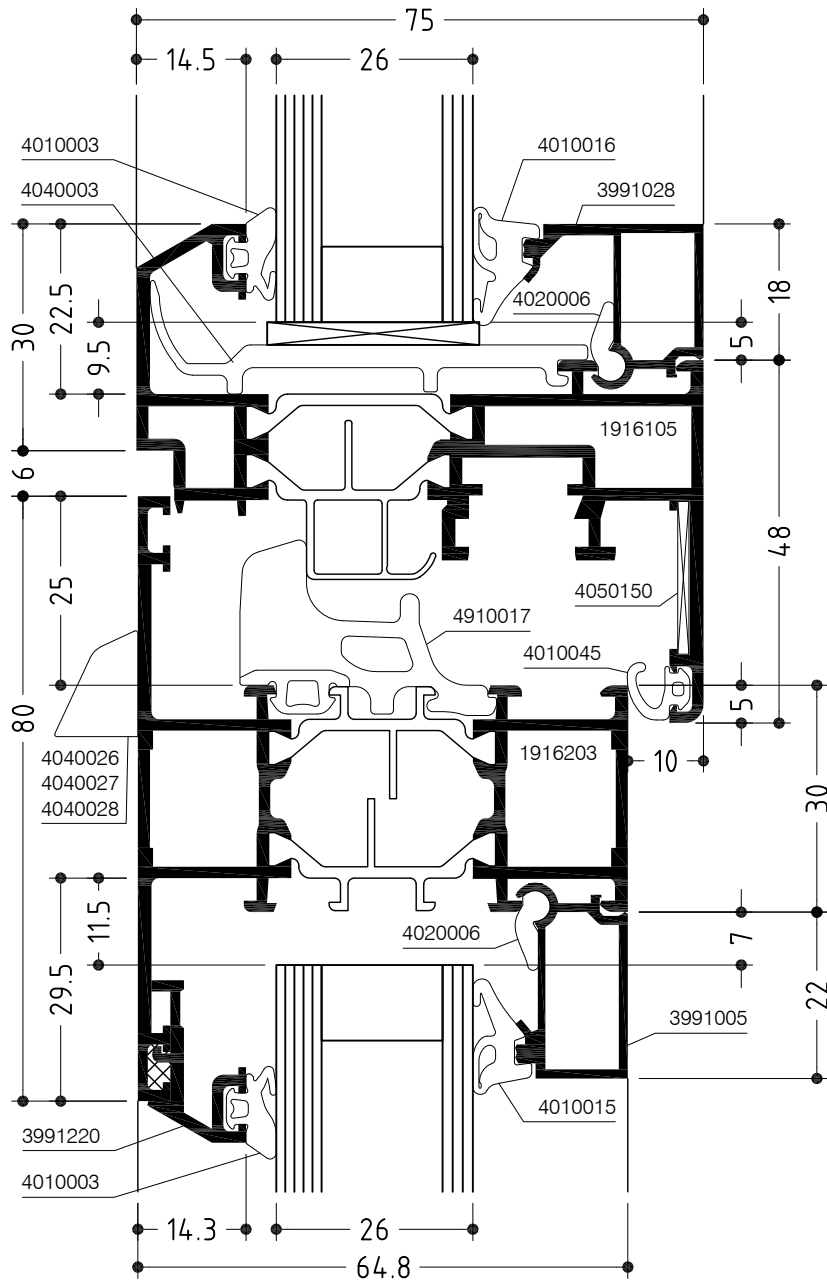
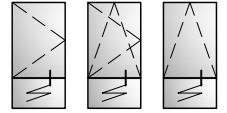

# WICLINE 65

Flügelprofil im Blendrahmen mit Kämpfer, Klassik-Design  
Sash profile in frame with transom, Classic design

Konstruktionsschnitt  
Construction section

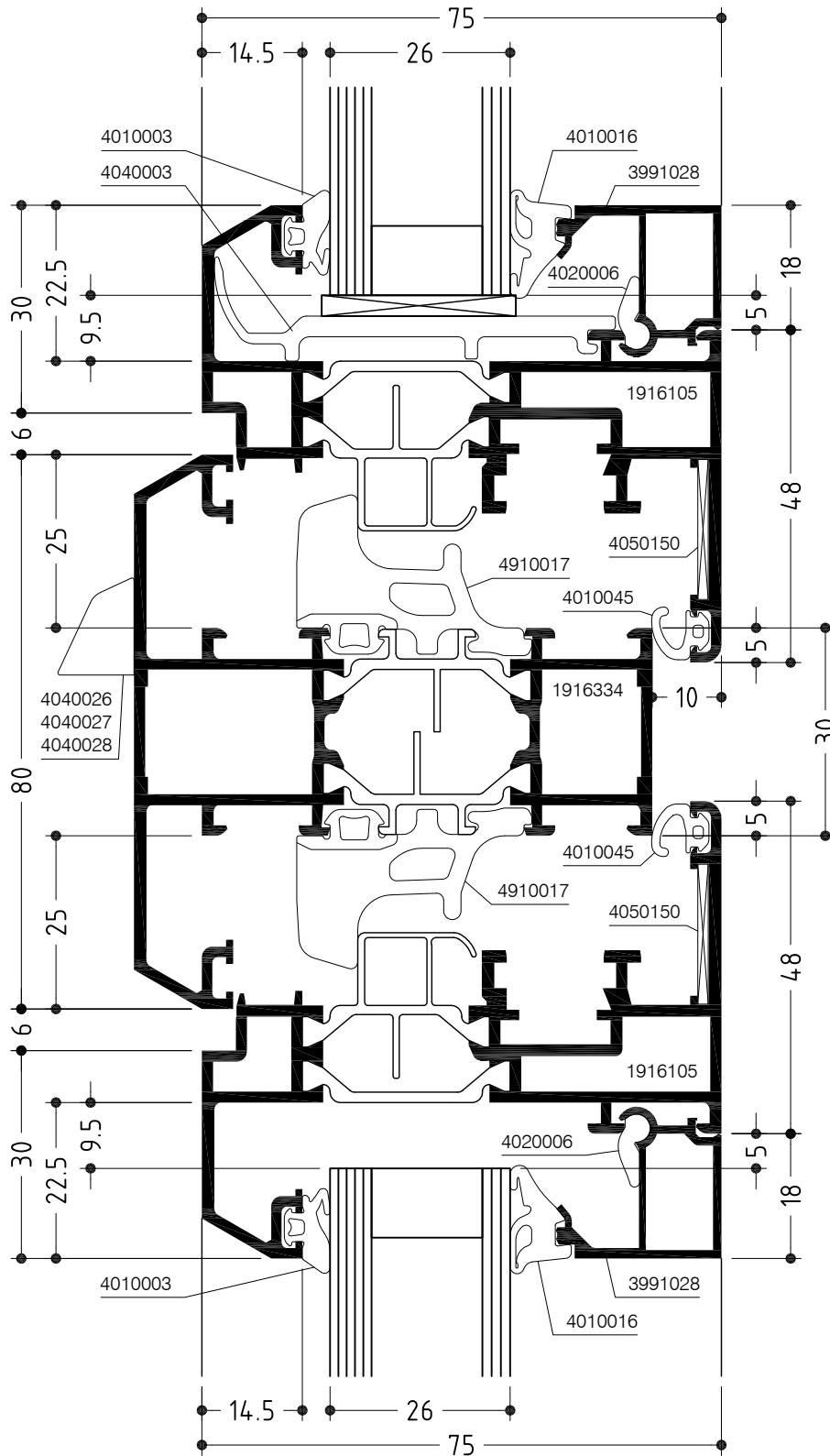
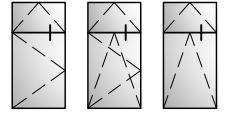

# WICLINE 65

## Konstruktionsschnitt

### Construction section

Flügelprofil im Blendrahmen mit Sprossenprofil, Klassik-Design

Sash profile in frame with glazing bar profile, Classic design

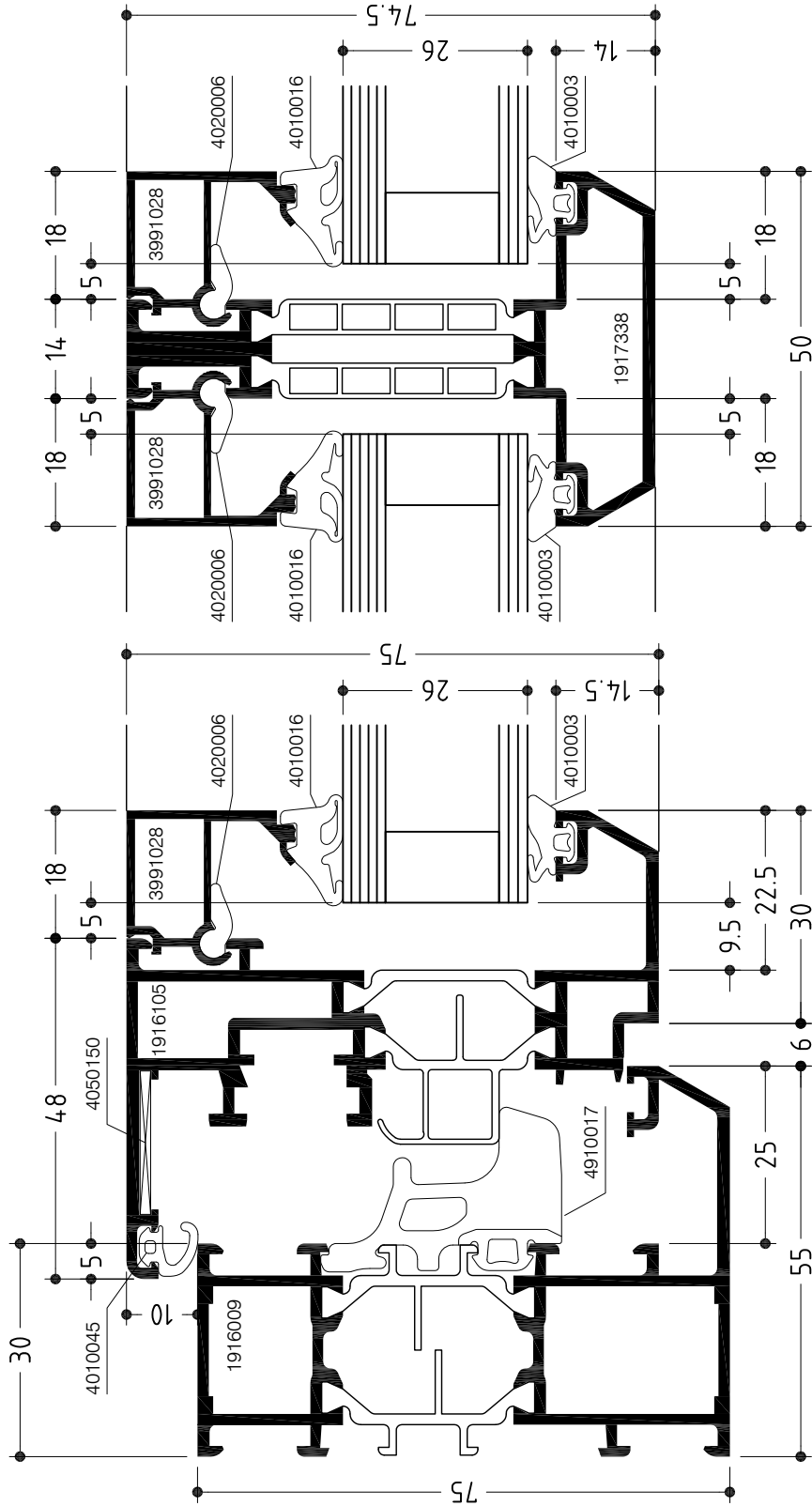

# WICLINE 65

Festverglasung mit Sprossenprofil, Klassik-Design  
 Fixed glazing with glazing bar profile, Classic design

Konstruktionsschnitt  
 Construction section

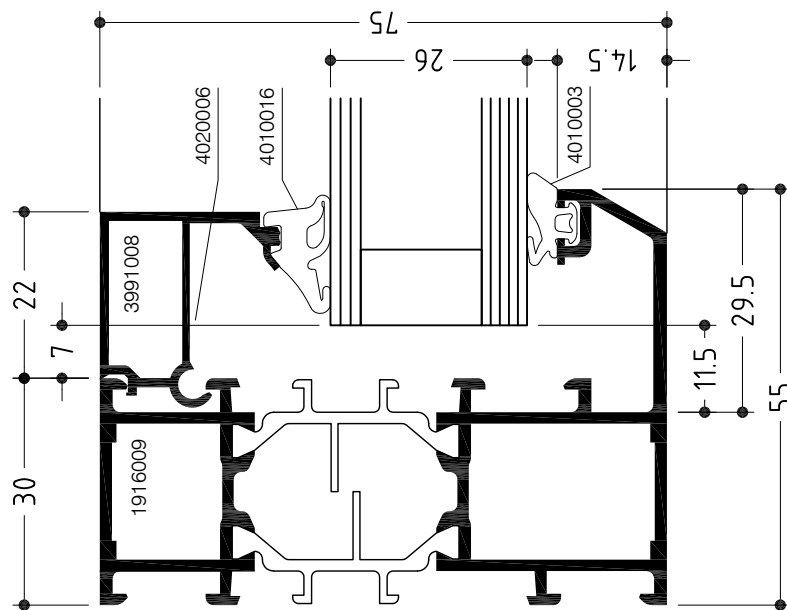
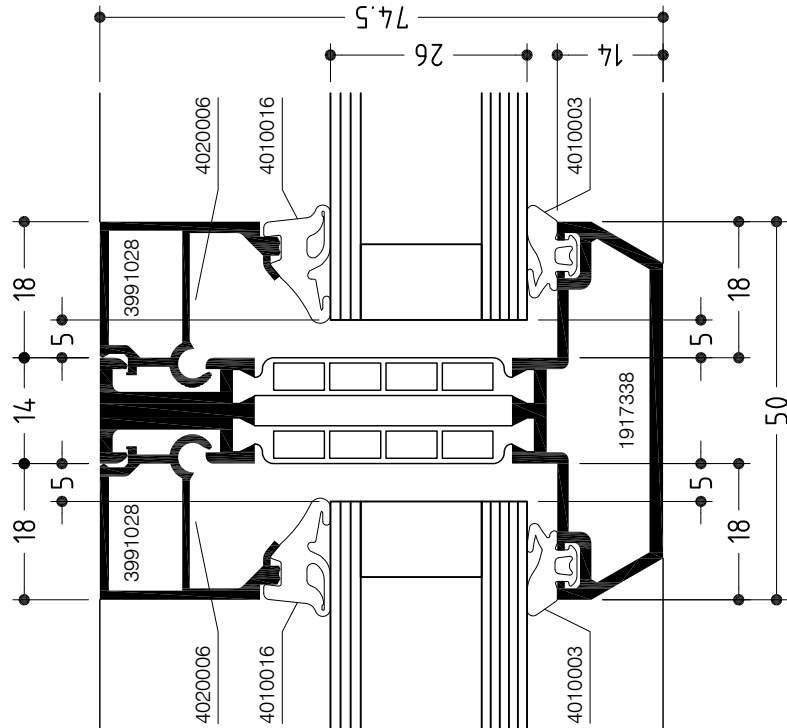

# WICLINE 65

Flügelprofil im Blendrahmen mit Ziersprossenprofil, Klassik-Design  
Sash profile in frame with glazing bar profile, Classic design

Konstruktionsschnitt  
Construction section

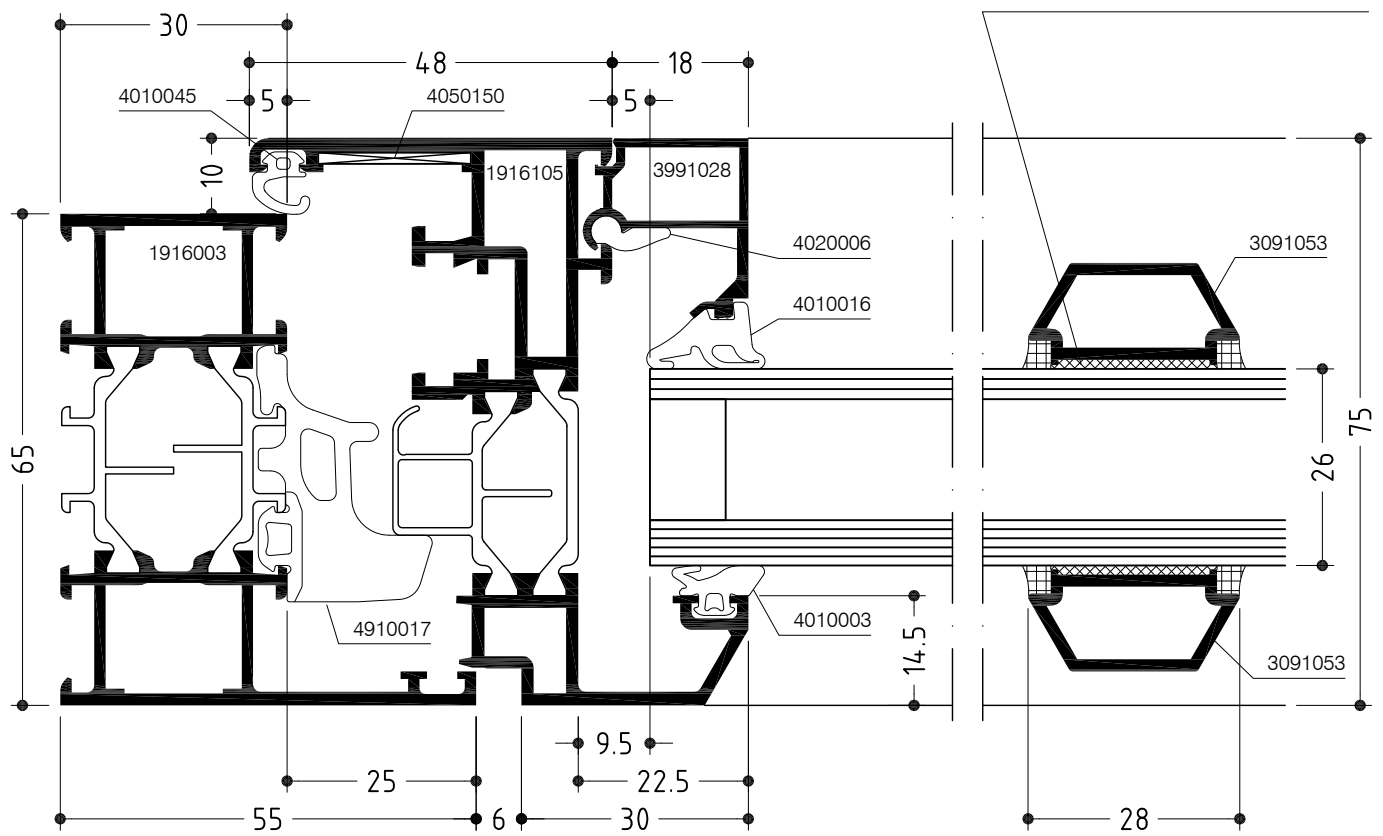

# WICLINE 65

Flügelprofil im Dehnstoßblendrahmen, Klassik-Design  
Sash profile in expansion joint frame, Classic design

Konstruktionsschnitt  
Construction section

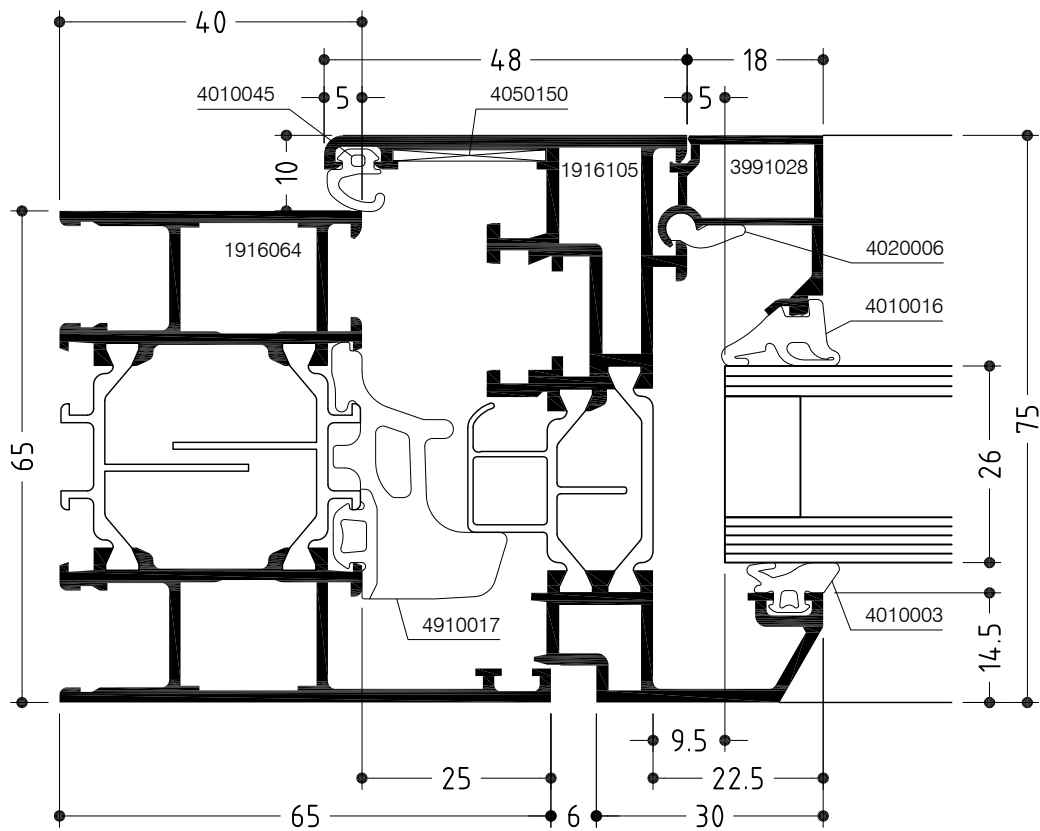

# WICLINE 65

Flügelprofil im Einspannblendrahmen, Klassik-Design  
Sash profile in clamping frame, Classic design

Konstruktionsschnitt  
Construction section

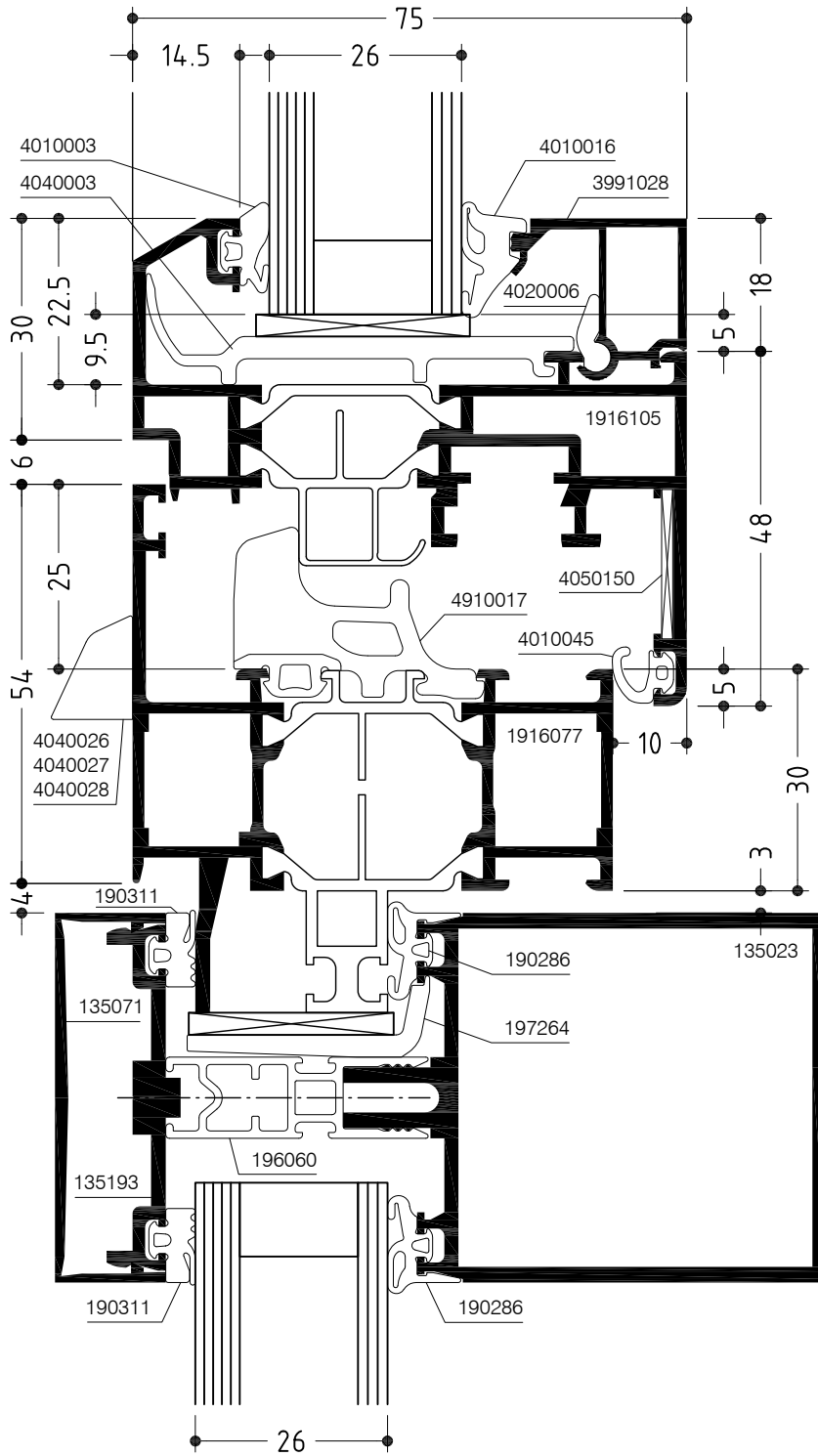

# WICLINE 65

## Konstruktionsschnitte

### Construction section

Bauanschluss unten mit Dämmauflage 4930044, Klassik-Design

Bottom junction to structure with insulation support 4930044, Classic design

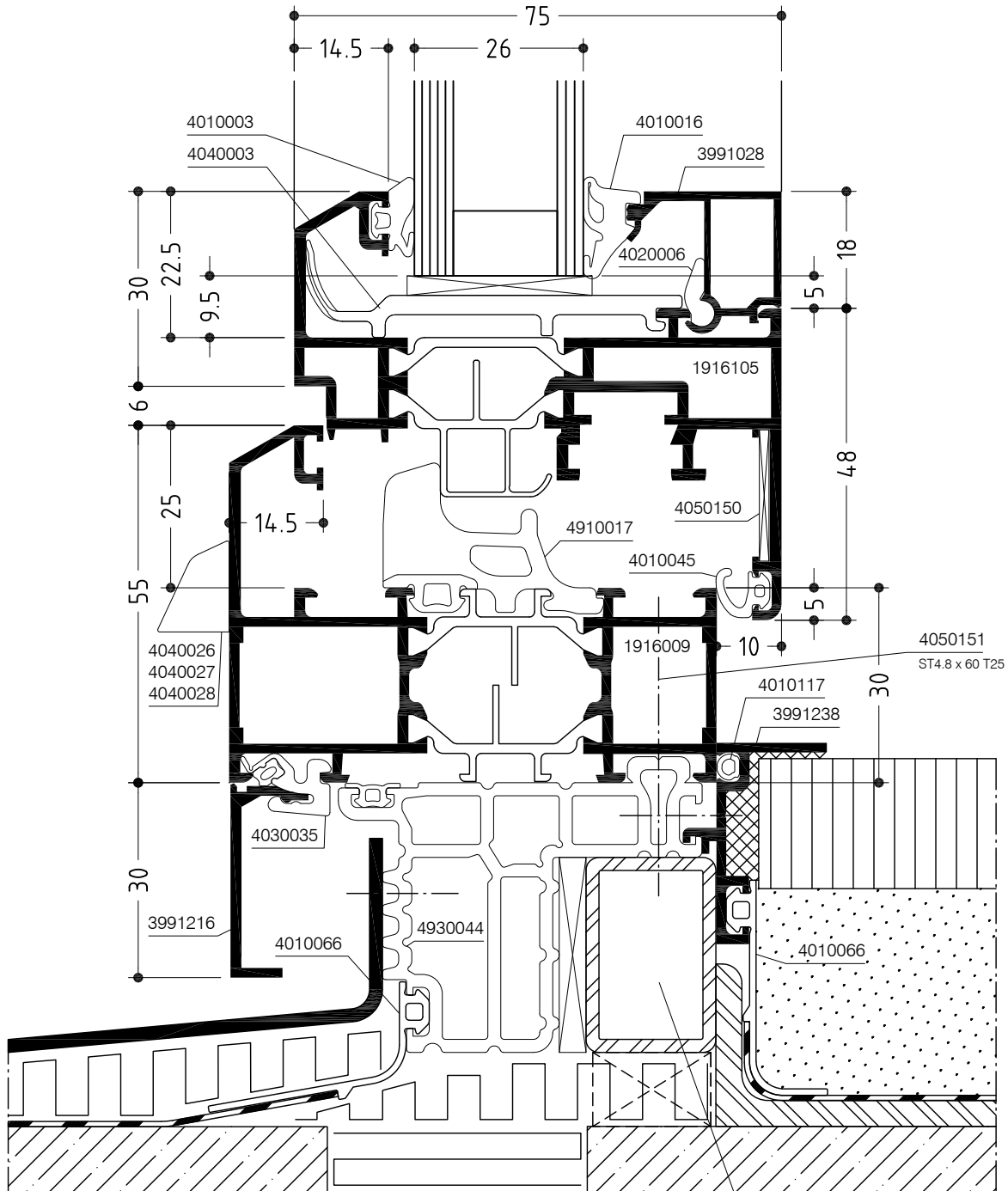

Stahlrohr 20 x 30 x 2  
verzinkt nach DIN 55928  
20 x 30 x 2 Steel tube,  
galv. acc. to DIN 55928



# WICLINE 65

Flügelprofil im Blendrahmen, verdeckter Flügel  
Concealed sash in frame

Konstruktionsschnitt  
Construction section

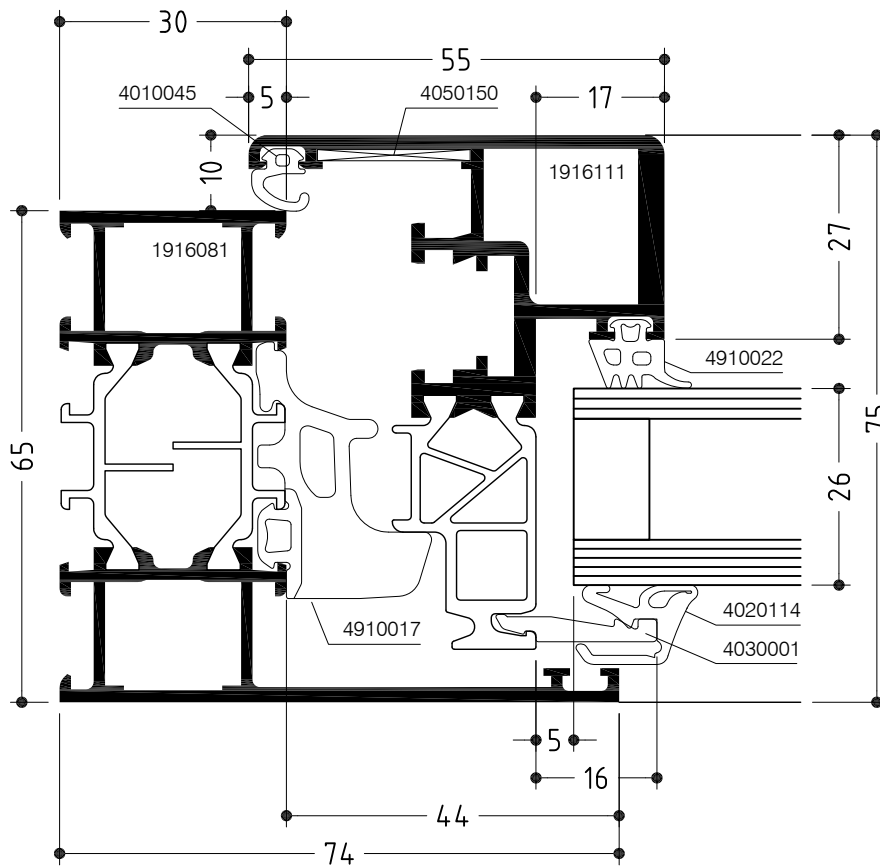

# WICLINE 65

Verdeckte Entwässerung, verdeckter Flügel  
Concealed drainage, concealed sash in frame

Konstruktionsschnitt  
Construction section

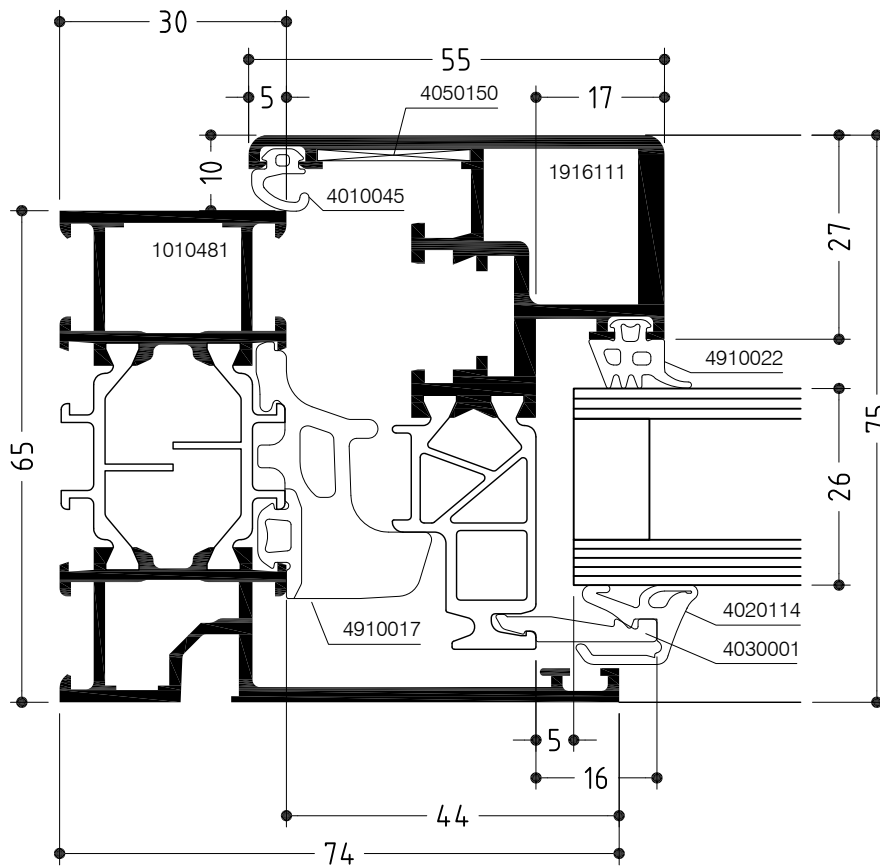

# WICLINE 65

Flügelprofil im Blendrahmen, verdeckter Flügel  
Concealed sash in frame

Konstruktionsschnitt  
Construction section

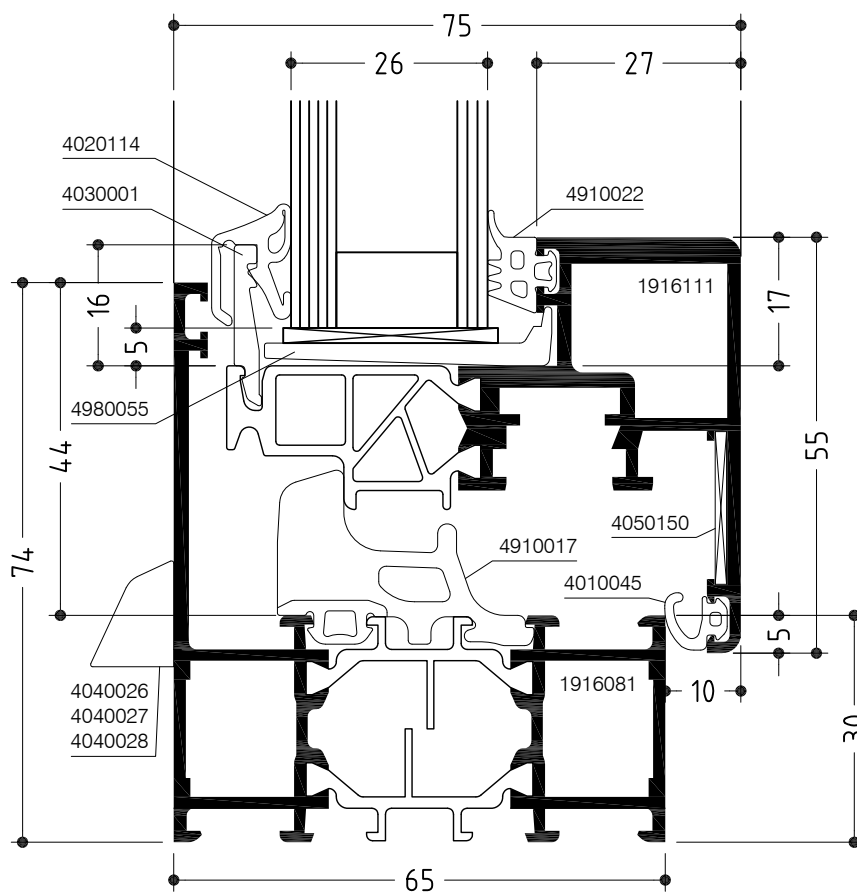

# WICLINE 65

Flügelprofil im Blendrahmen, verdeckter Flügel  
Concealed sash in frame

Konstruktionsschnitt  
Construction section

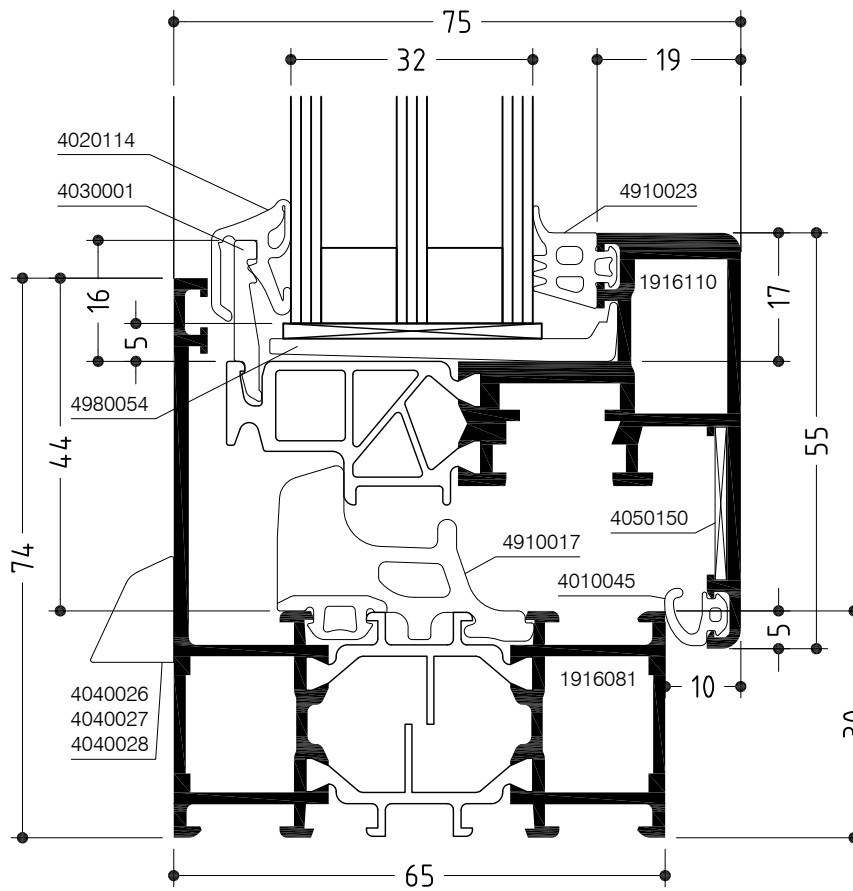

# WICLINE 65

Flügelprofil im Blendrahmen, verdeckter Flügel  
Concealed sash in frame

Konstruktionsschnitt  
Construction section

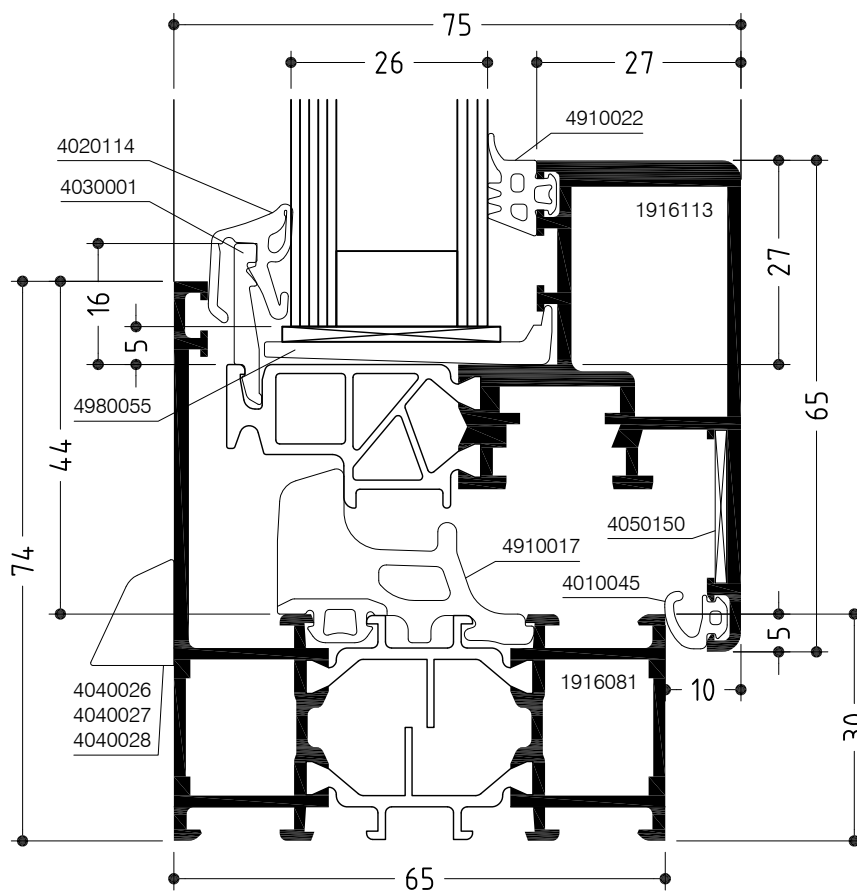

# WICLINE 65

Flügelprofil im Blendrahmen, verdeckter Flügel  
Concealed sash in frame

Konstruktionsschnitt  
Construction section

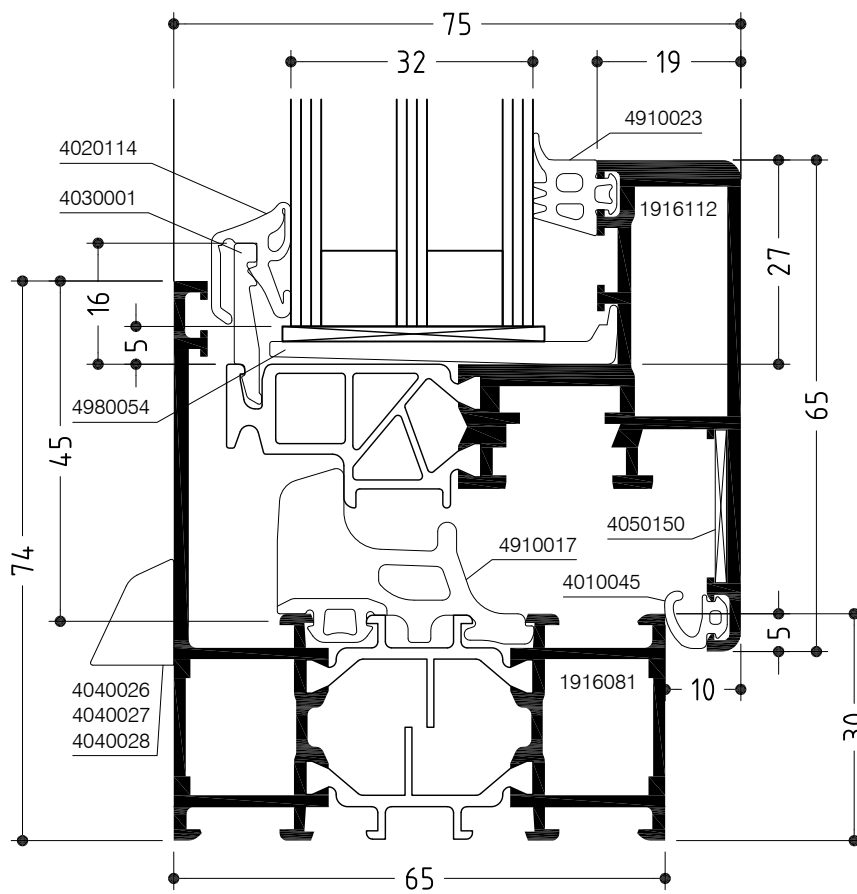

# WICLINE 65

## Konstruktionsschnitt

### Construction section

Stulpfenster - Mittelstoß, verdeckter Flügel

Double casement window with concealed sash - Meeting stiles

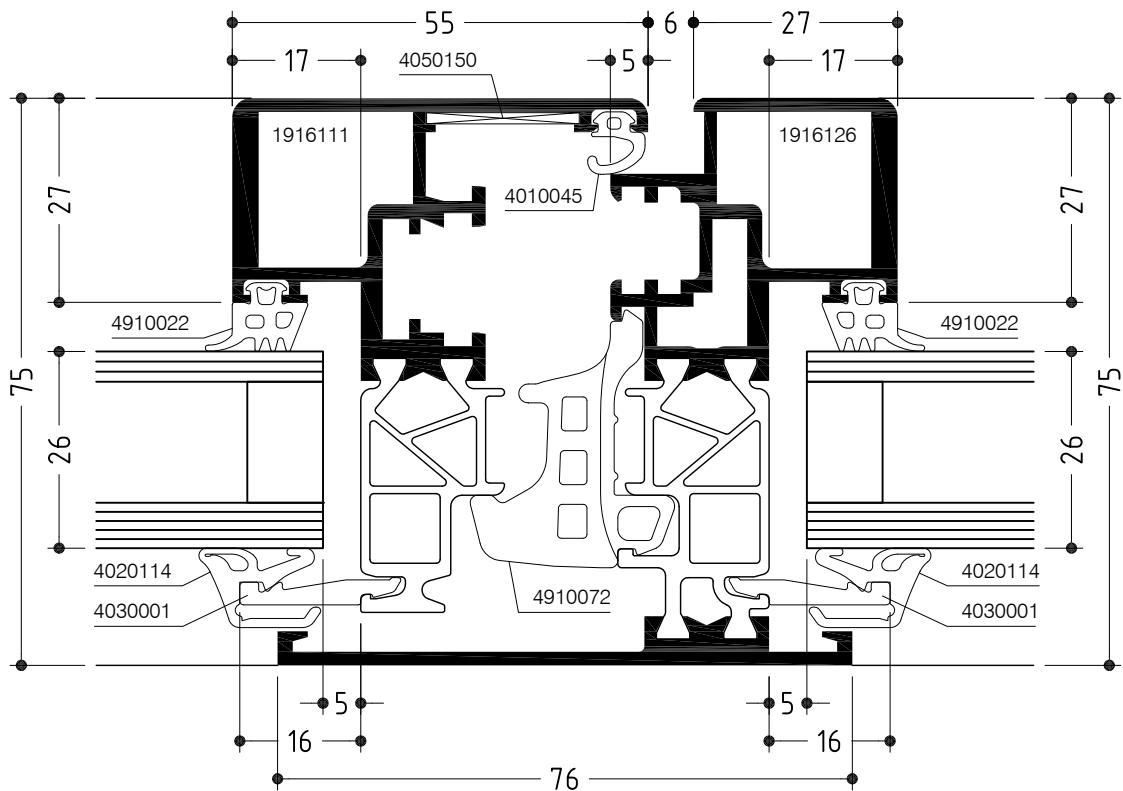
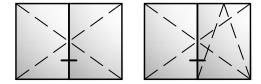

# WICLINE 65

Konstruktionsschnitt

Construction section

Stulpfenster - Mittelstoß, verdeckter Flügel

Double casement window with concealed sash - Meeting stiles

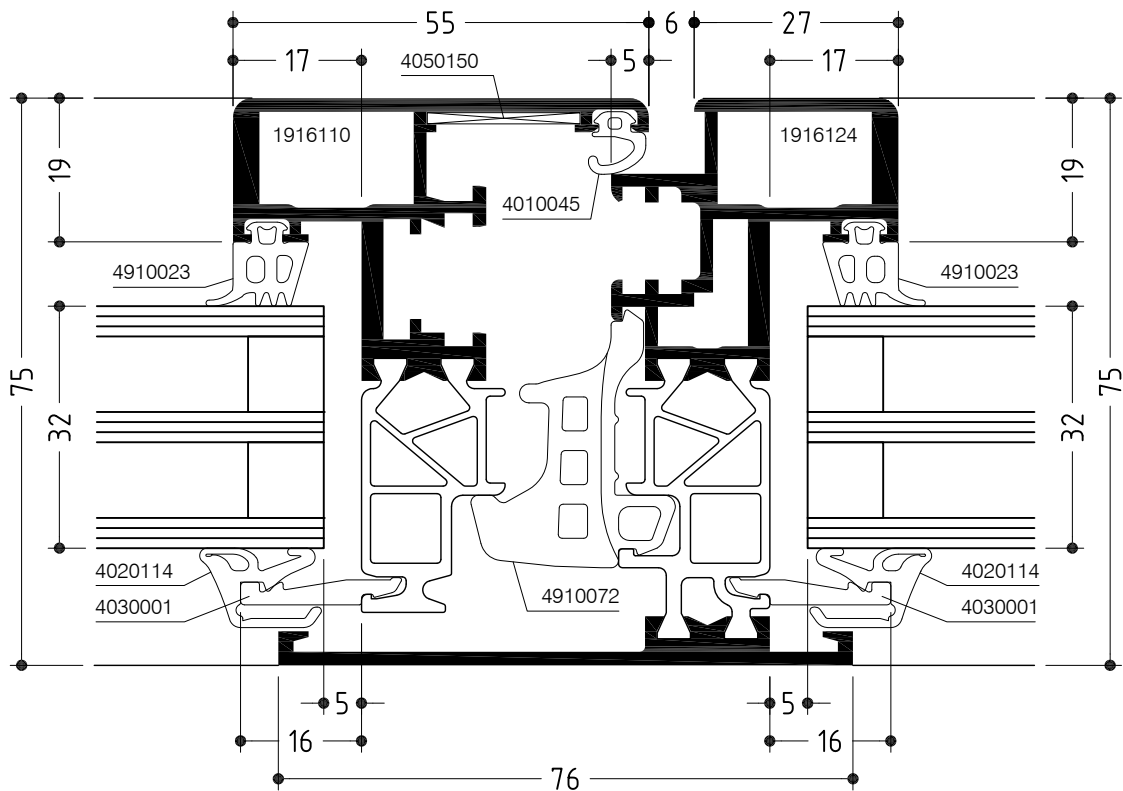
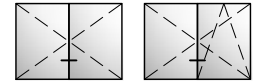







# WICLINE 65

## Konstruktionsschnitt

### Construction section

Flügelprofil im Blendrahmen mit Kämpfer, verdeckter Flügel

Concealed sash in frame with transom

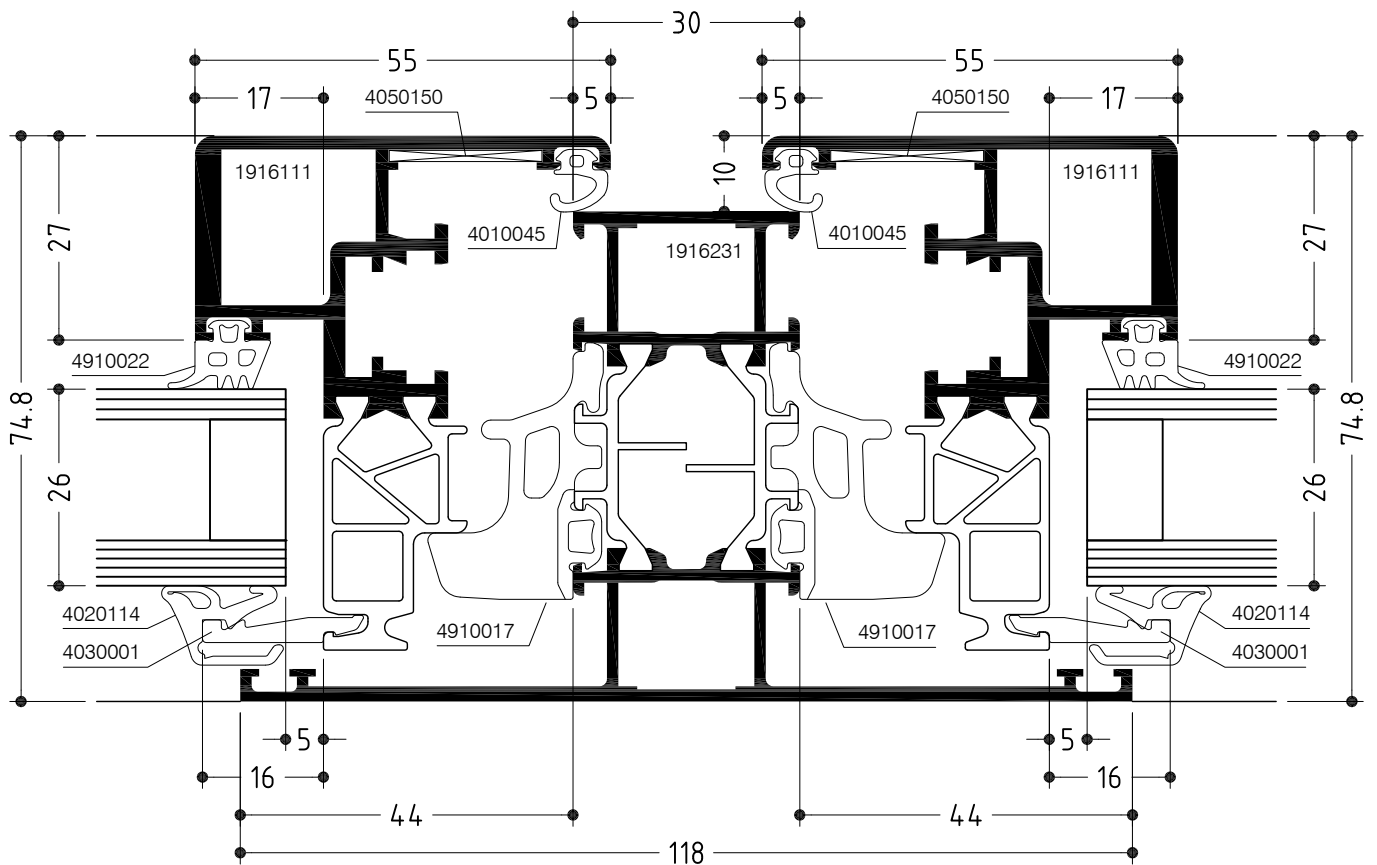
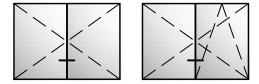



# WICLINE 65

## Konstruktionsschnitt

### Construction section

Flügelprofil im Blendrahmen mit Kämpfer, verdeckter Flügel

Concealed sash in frame with transom

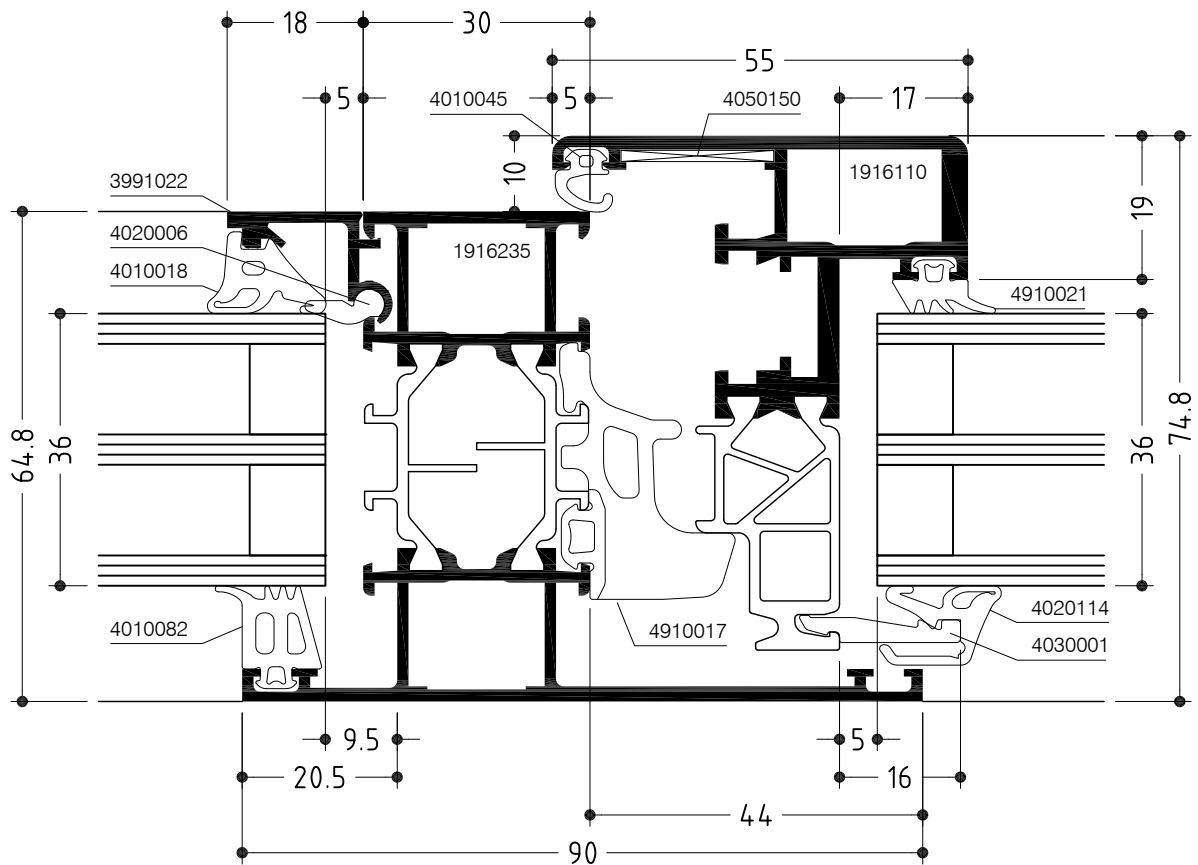
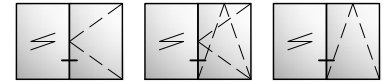

# WICLINE 65

Festverglasung, verdeckter Flügel  
Fixed glazing with frame of concealed sash

Konstruktionsschnitt  
Construction section

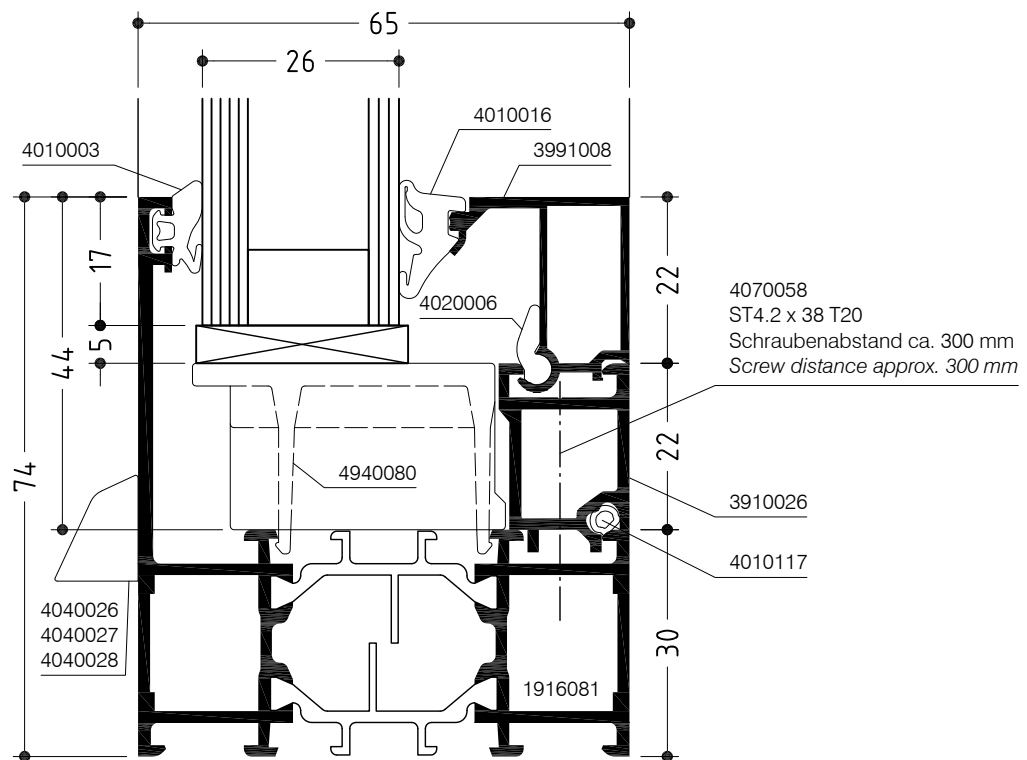







# WICLINE 65

## Konstruktionsschnitt

### Construction section

Flügelprofil im Blendrahmen mit Einspannaufsatz, verdeckter Flügel  
 Concealed sash in frame with supplementary clamping profile

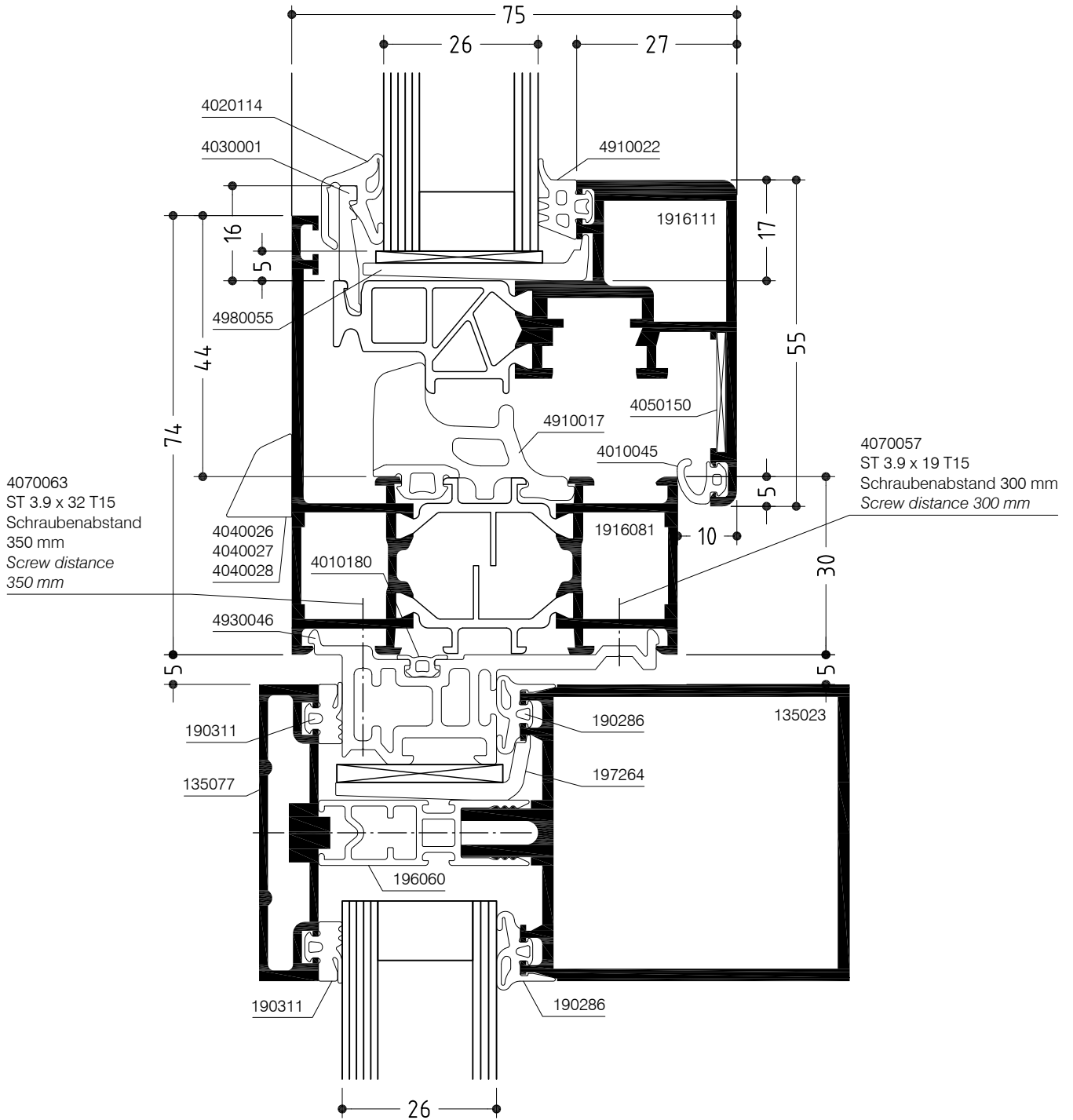

# WICLINE 65

## Konstruktionsschnitt

### Construction section

Bauanschluss unten mit Dämmauflage 4930043, verdeckter Flügel

Bottom junction to structure with insulation support 4930043 and concealed sash

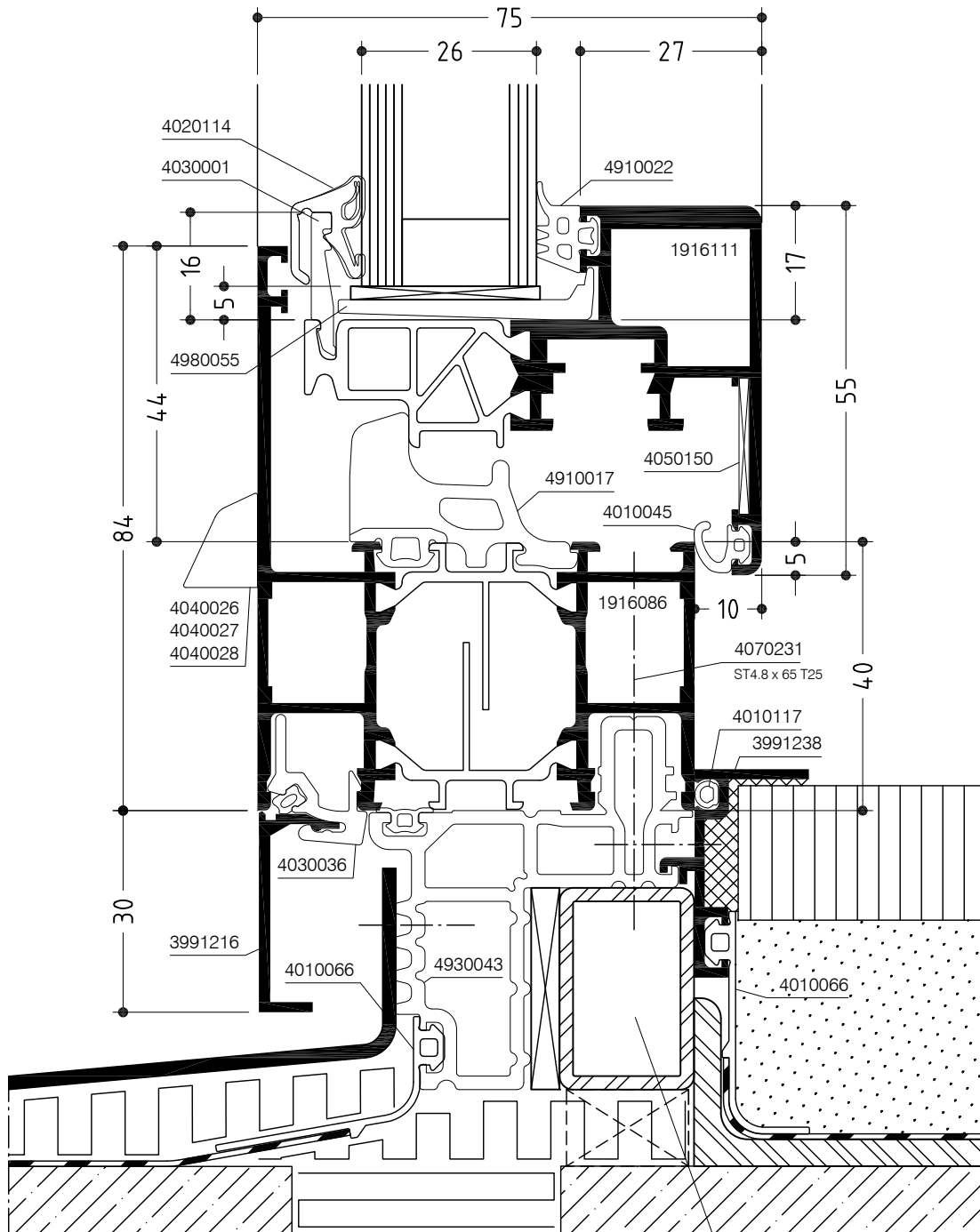

Stahlrohr 20 x 30 x 2  
 verzinkt nach DIN 55928  
 20 x 30 x 2 Steel tube,  
 galv. acc. to DIN 55928

# WICLINE 65

Senk-Klappfenster  
Italian style window

Konstruktionsschnitt  
Construction section

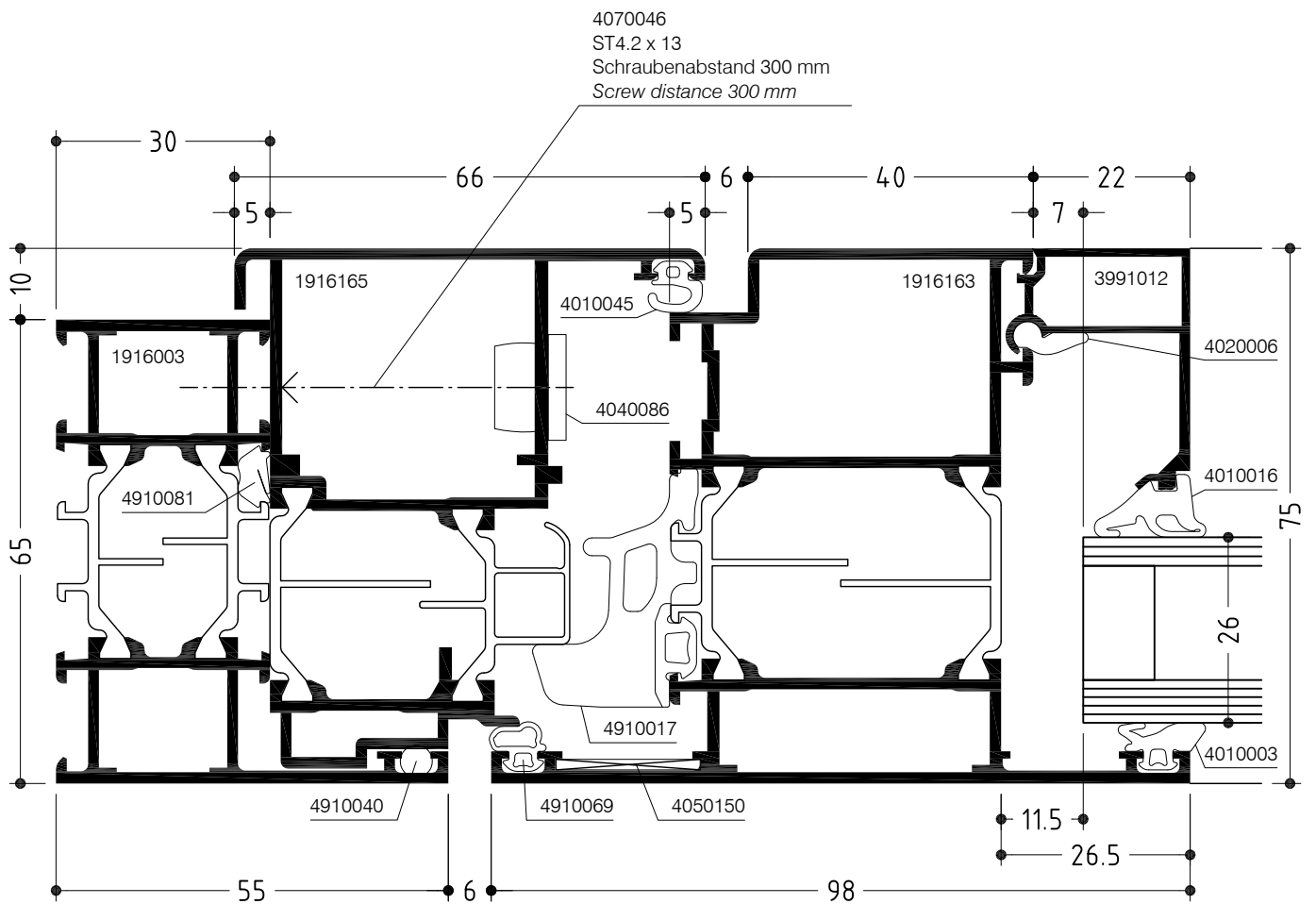



# WICLINE 65

Senk-Klappfenster  
Italian style window

Konstruktionsschnitt  
Construction section

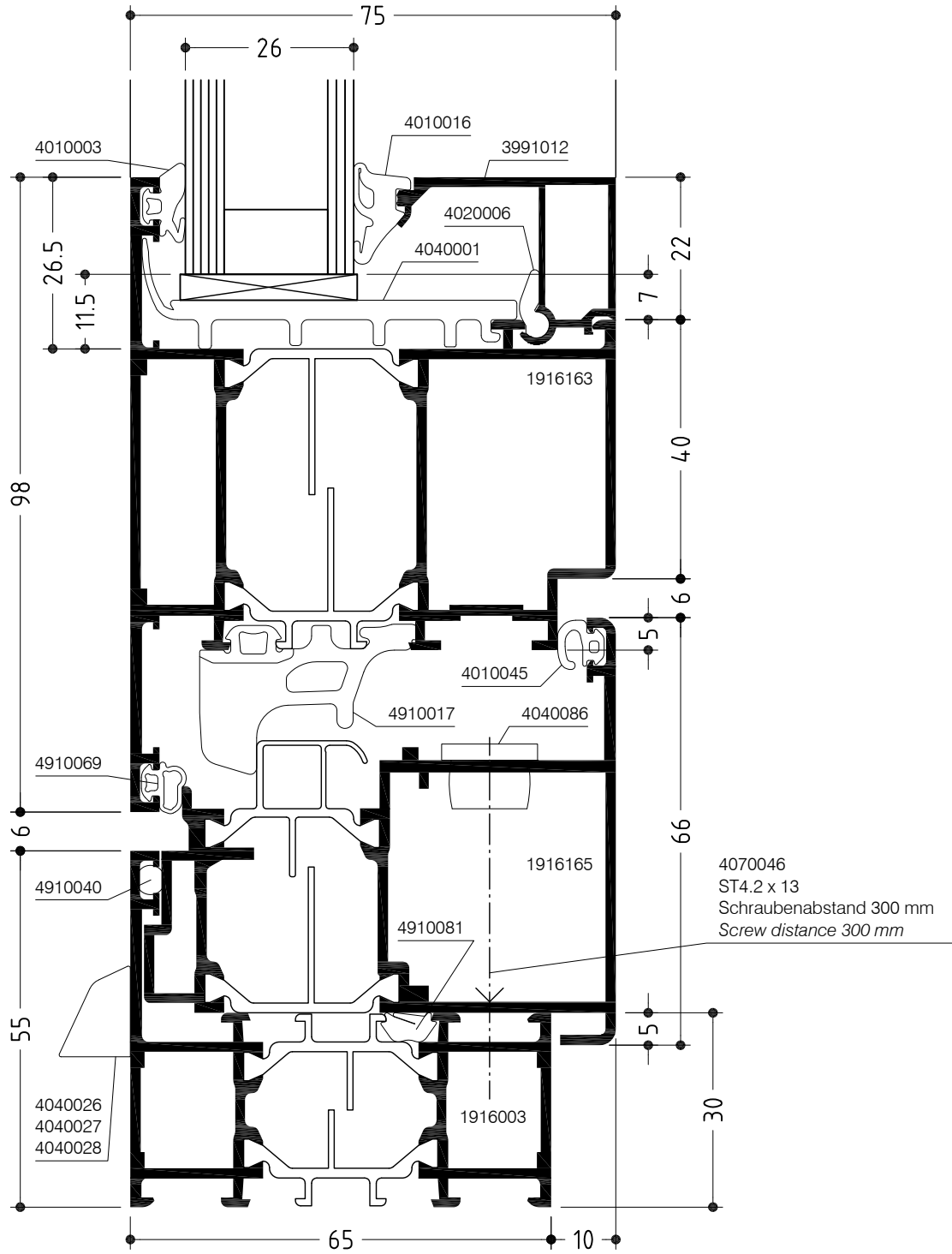

# WICLINE 65

Senk-Klappfenster  
Italian style window

Konstruktionsschnitt  
Construction section

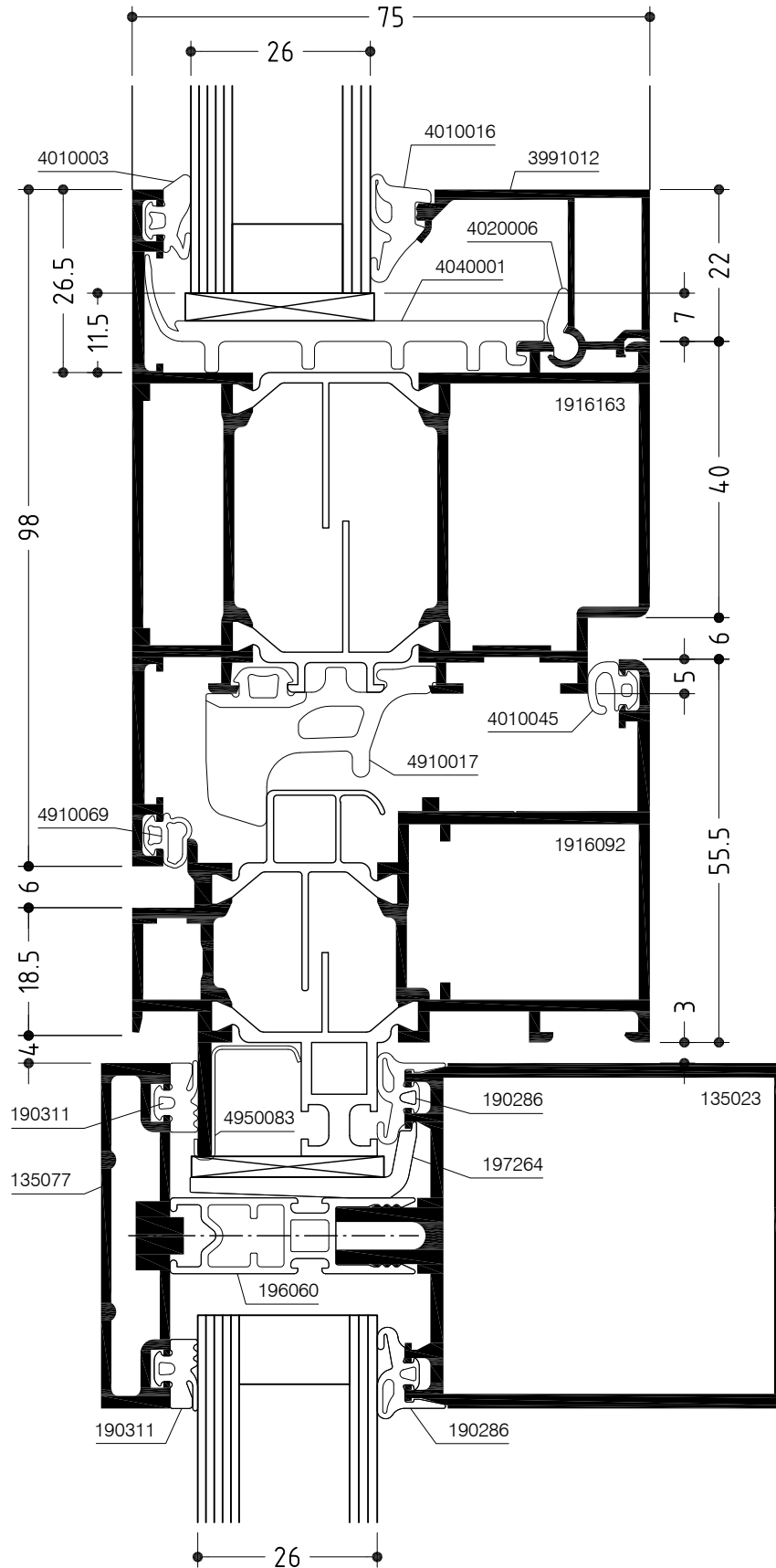

# WICLINE 65

Senk-Klappfenster  
Italian style window

Konstruktionsschnitt  
Construction section

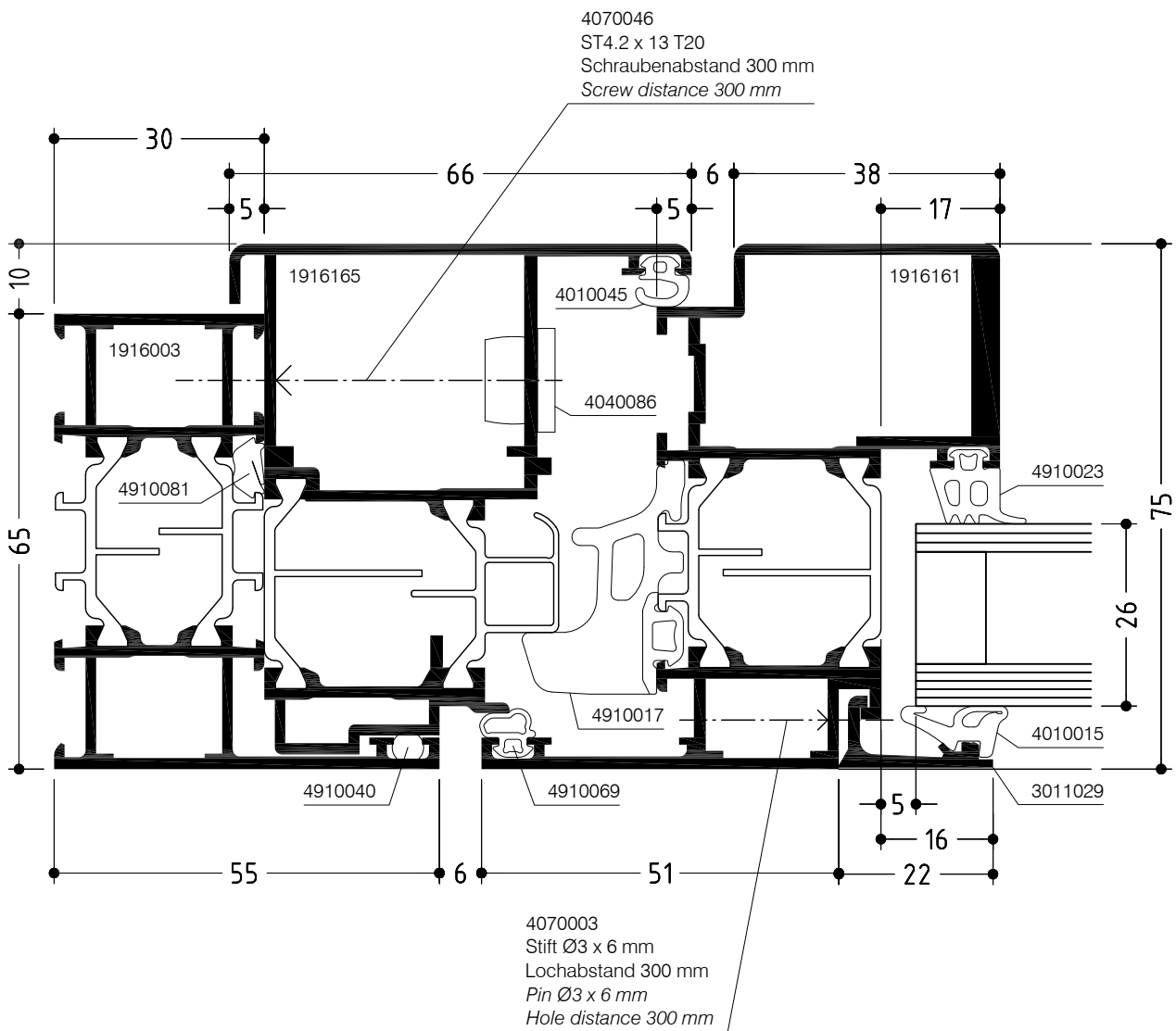

# WICLINE 65

Senk-Klappfenster  
Italian style window

Konstruktionsschnitt  
Construction section

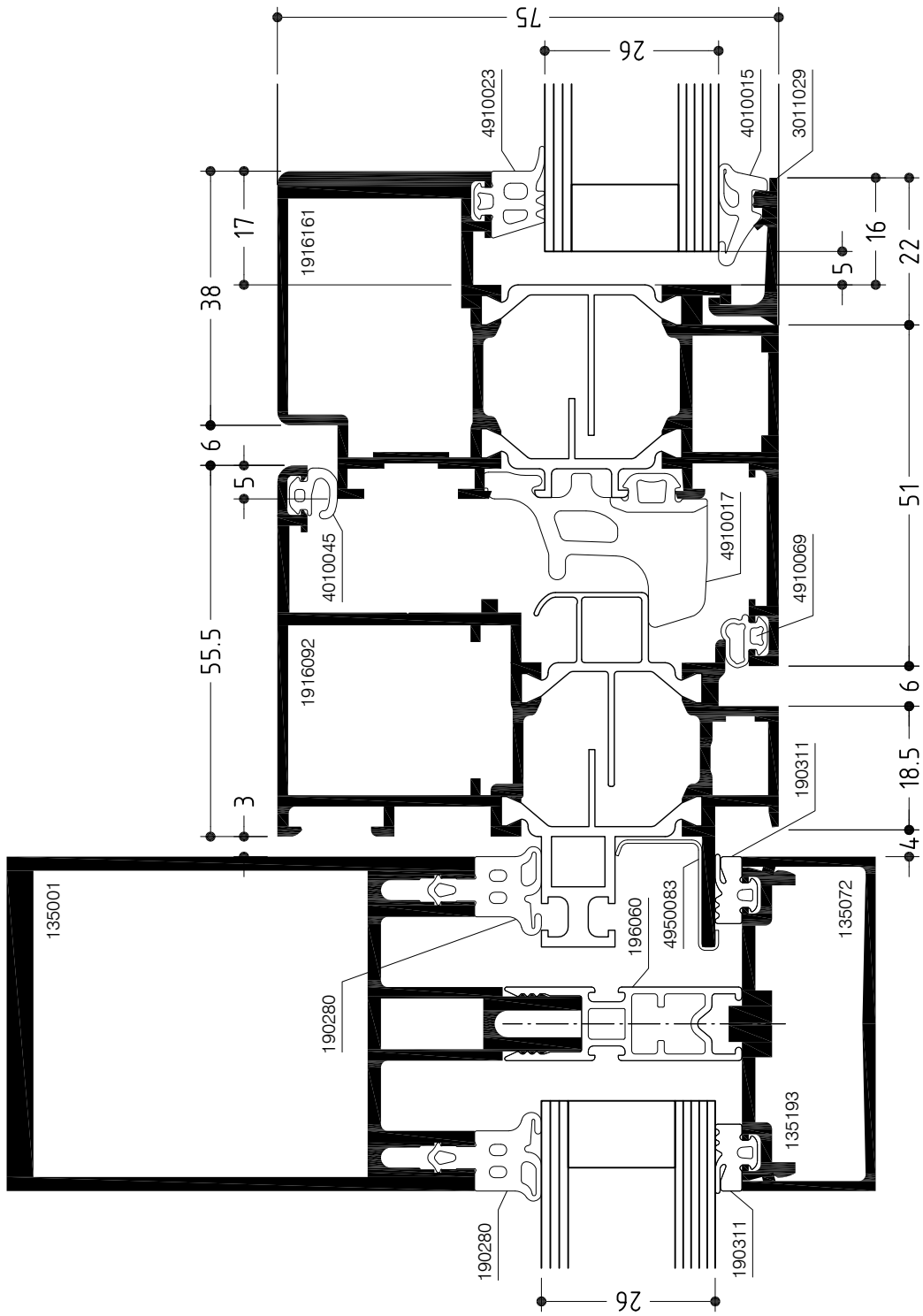



# WICLINE 65

Senk-Klappfenster  
Italian style window

Konstruktionsschnitt  
Construction section

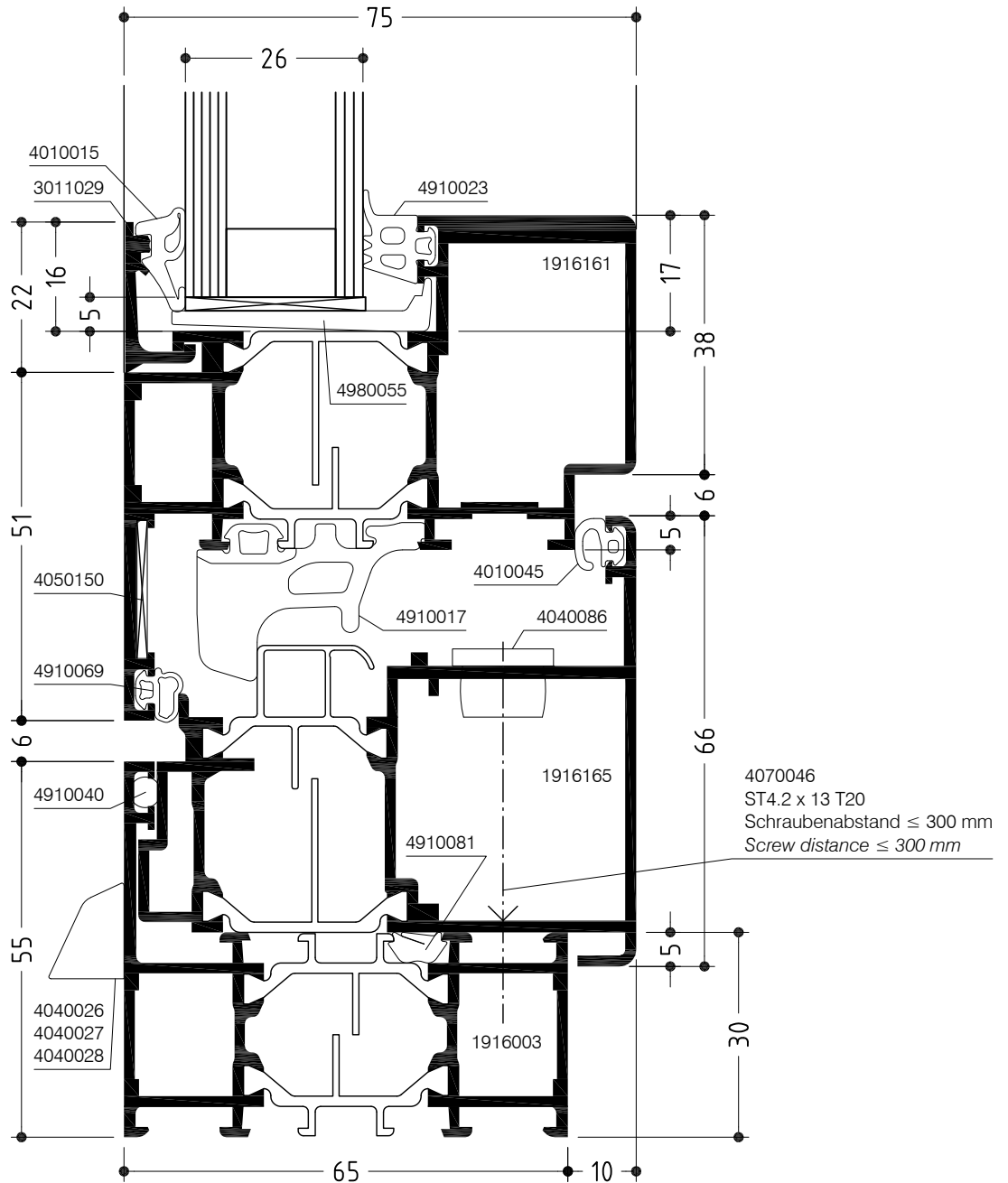

# WICLINE 65

Senk-Klappfenster  
Italian style window

Konstruktionsschnitt  
Construction section

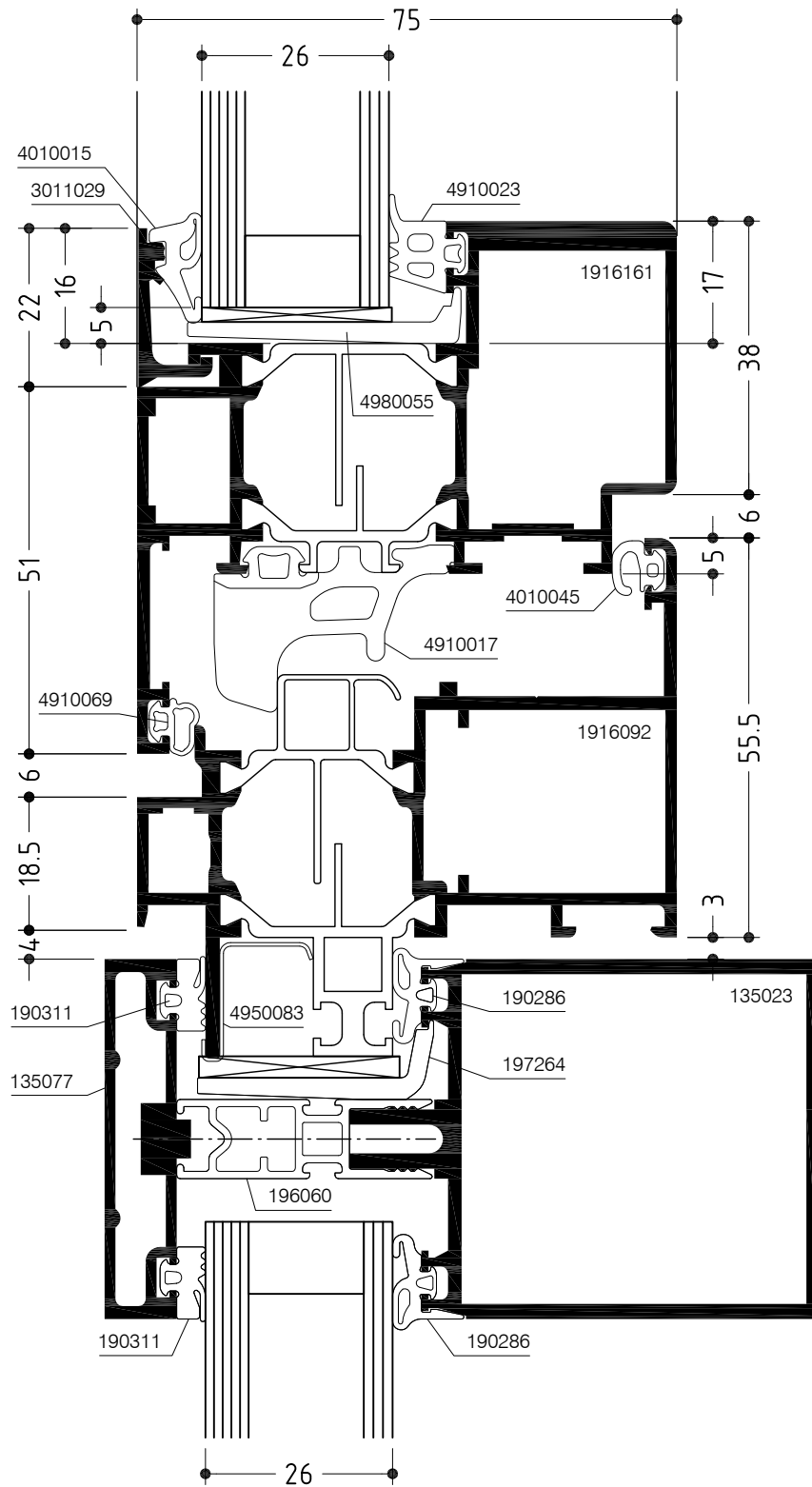

# WICLINE 65

Klappfenster  
Top-hung window

Konstruktionsschnitt  
Construction section

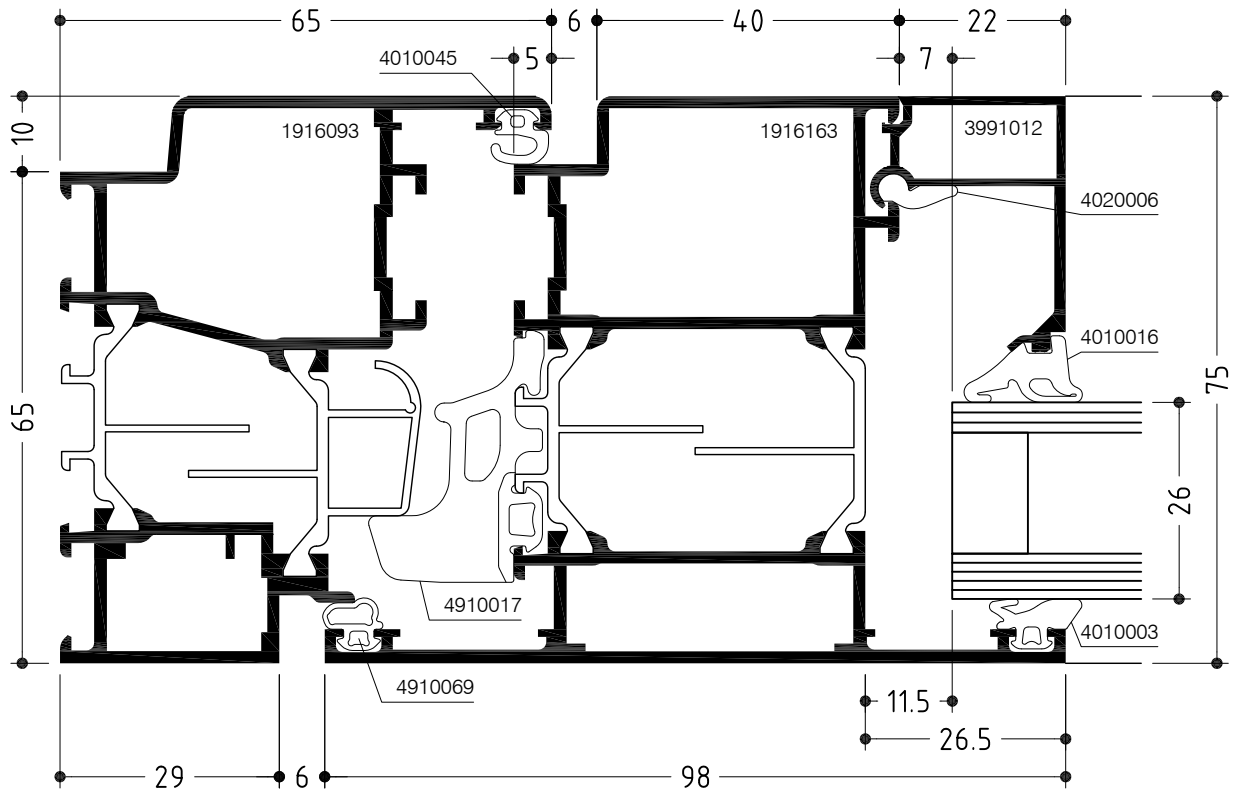

# WICLINE 65

Klappfenster  
Top-hung window

Konstruktionsschnitt  
Construction section

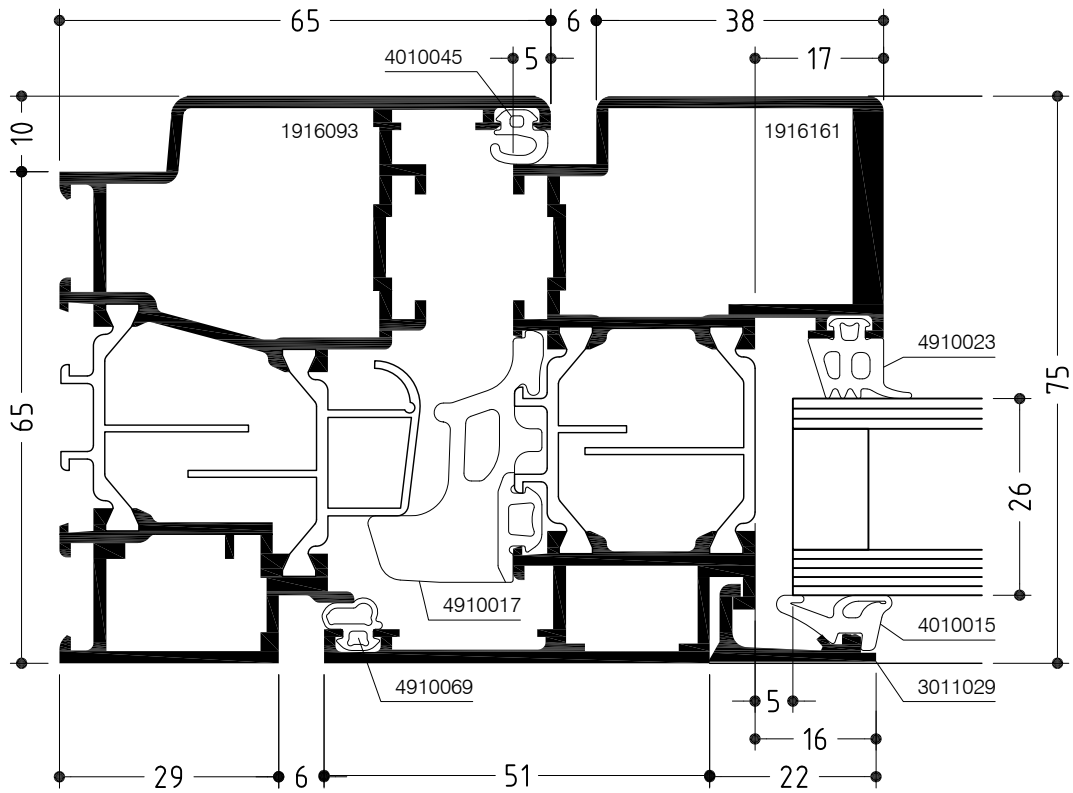

# WICLINE 65

Klappfenster  
Top-hung window

Konstruktionsschnitt  
Construction section

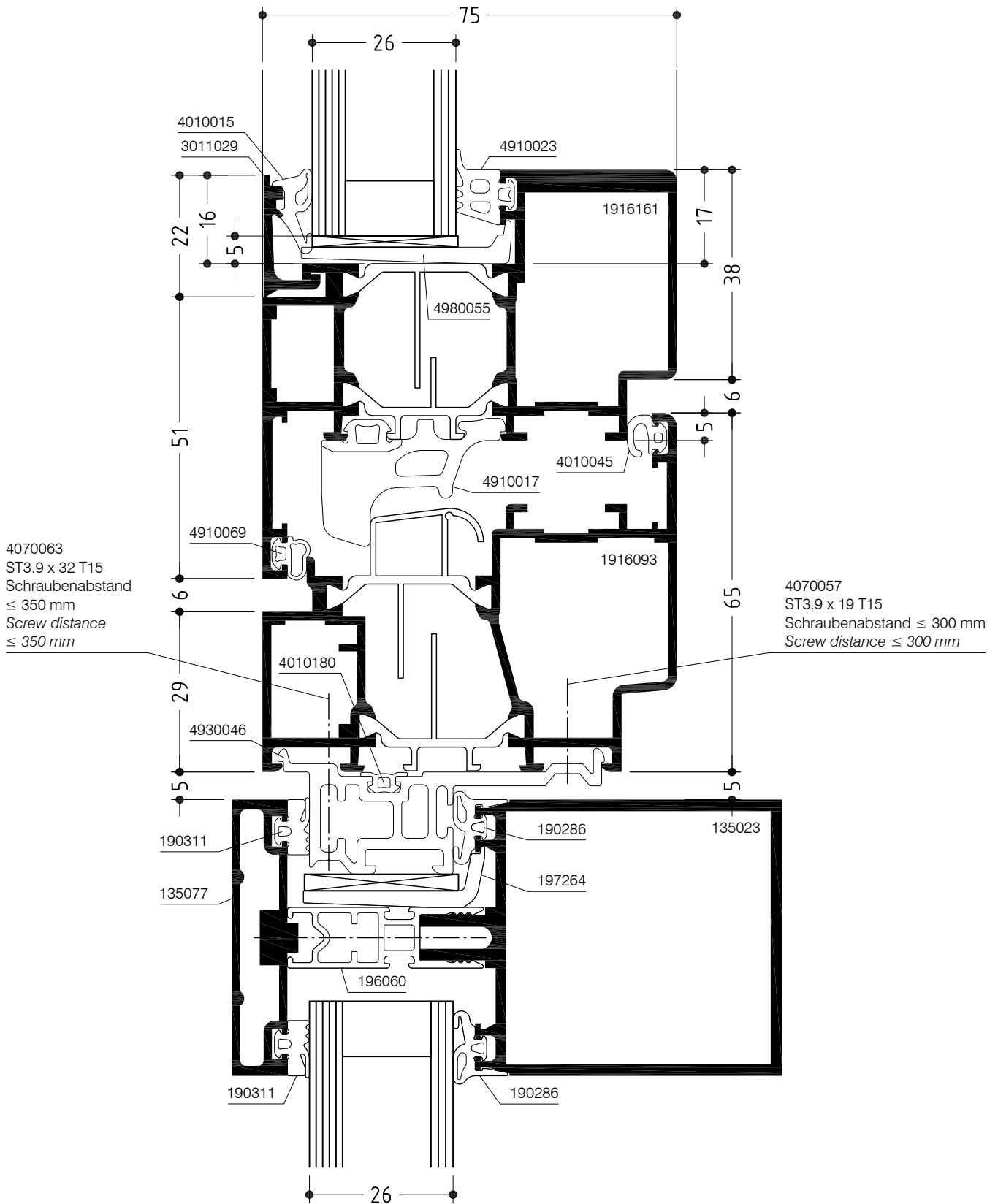

# WICLINE 65

Klappfenster  
Top-hung window

Konstruktionsschnitt  
Construction section

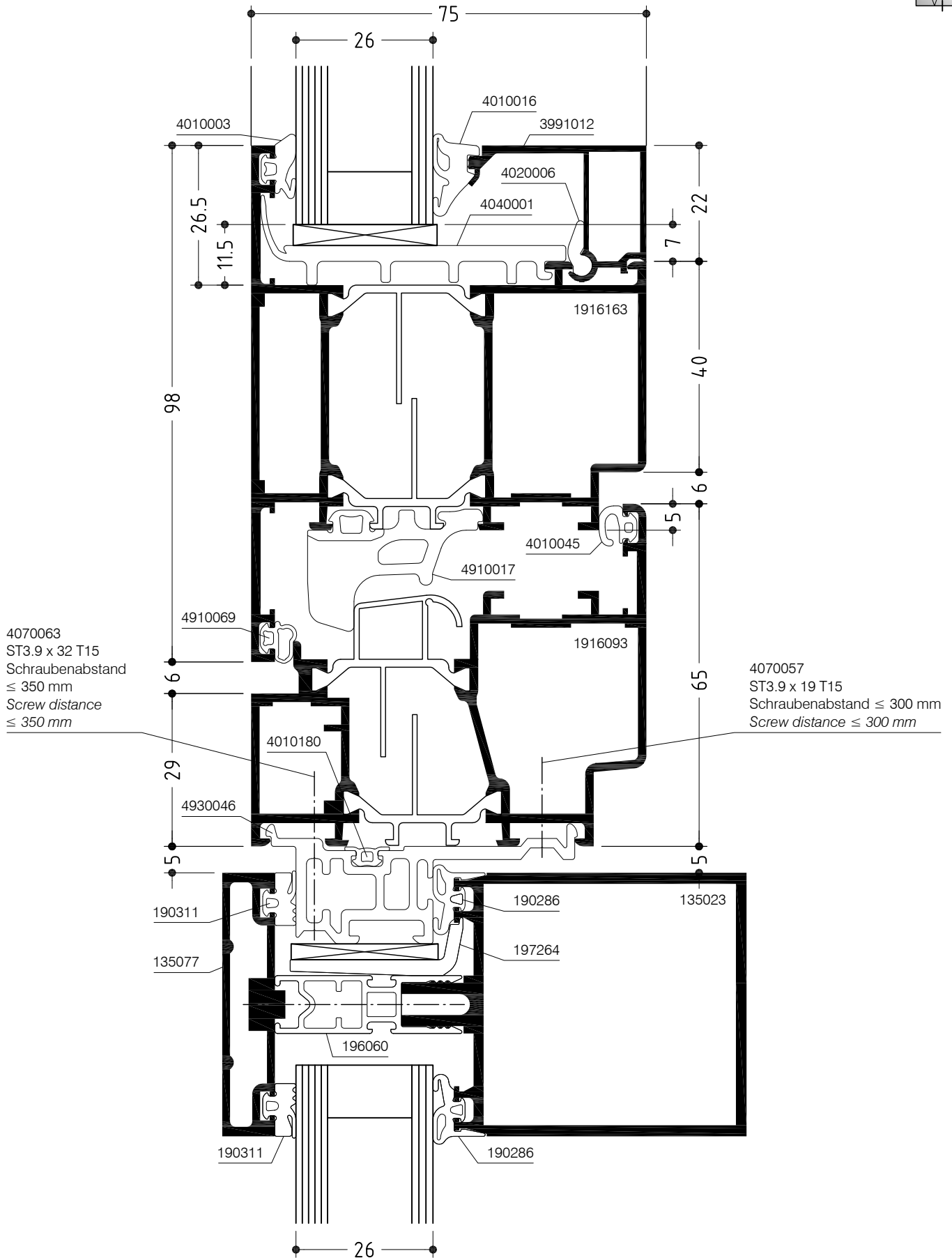

# WICLINE 65

Schwing-Wende-Fenster  
Horizontal/vertical pivot window

Konstruktionsschnitt  
Construction section

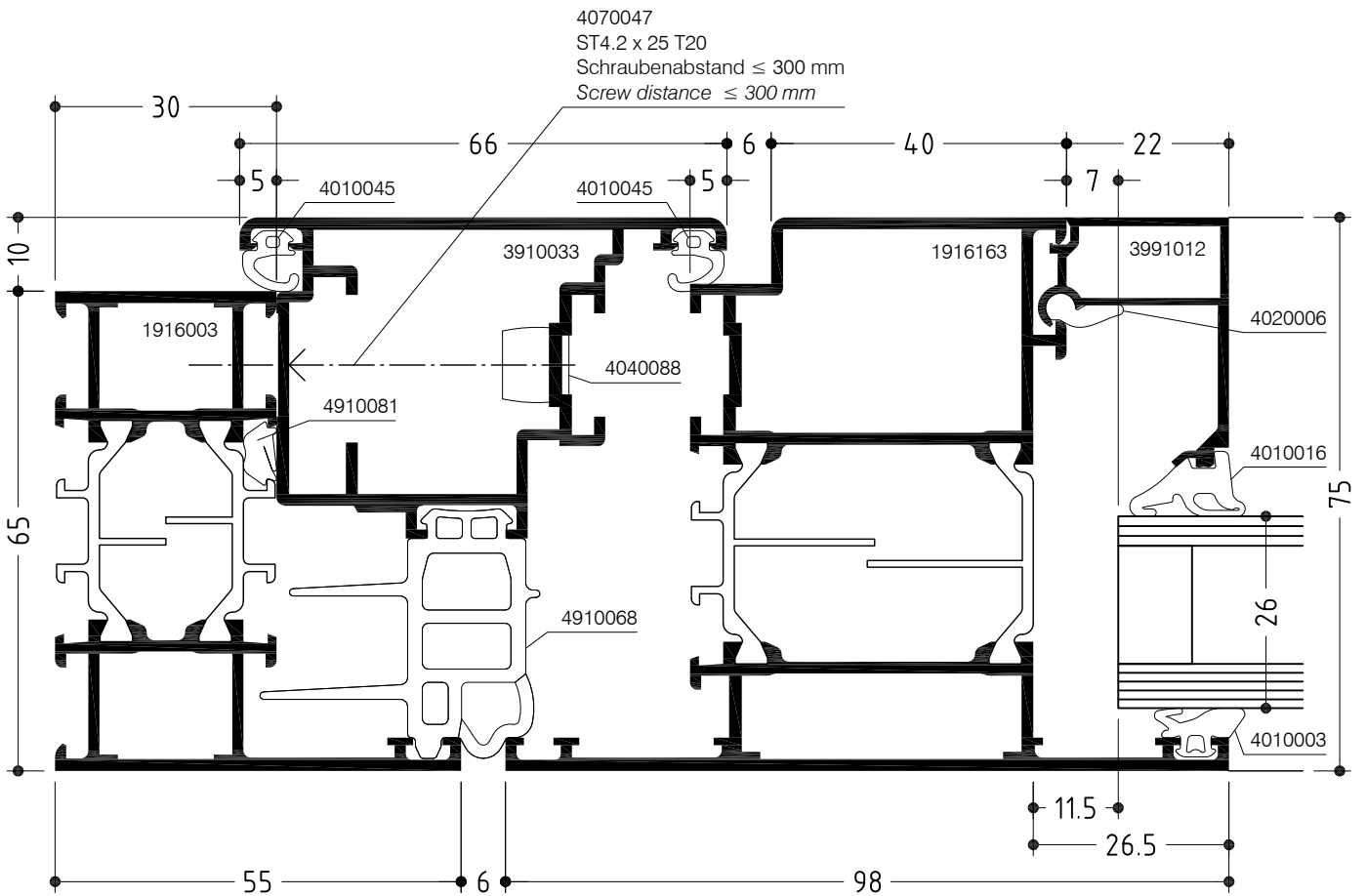
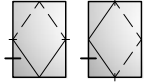

# WICLINE 65

Schwing-Wende-Fenster  
Horizontal/vertical pivot window

Konstruktionsschnitt  
Construction section

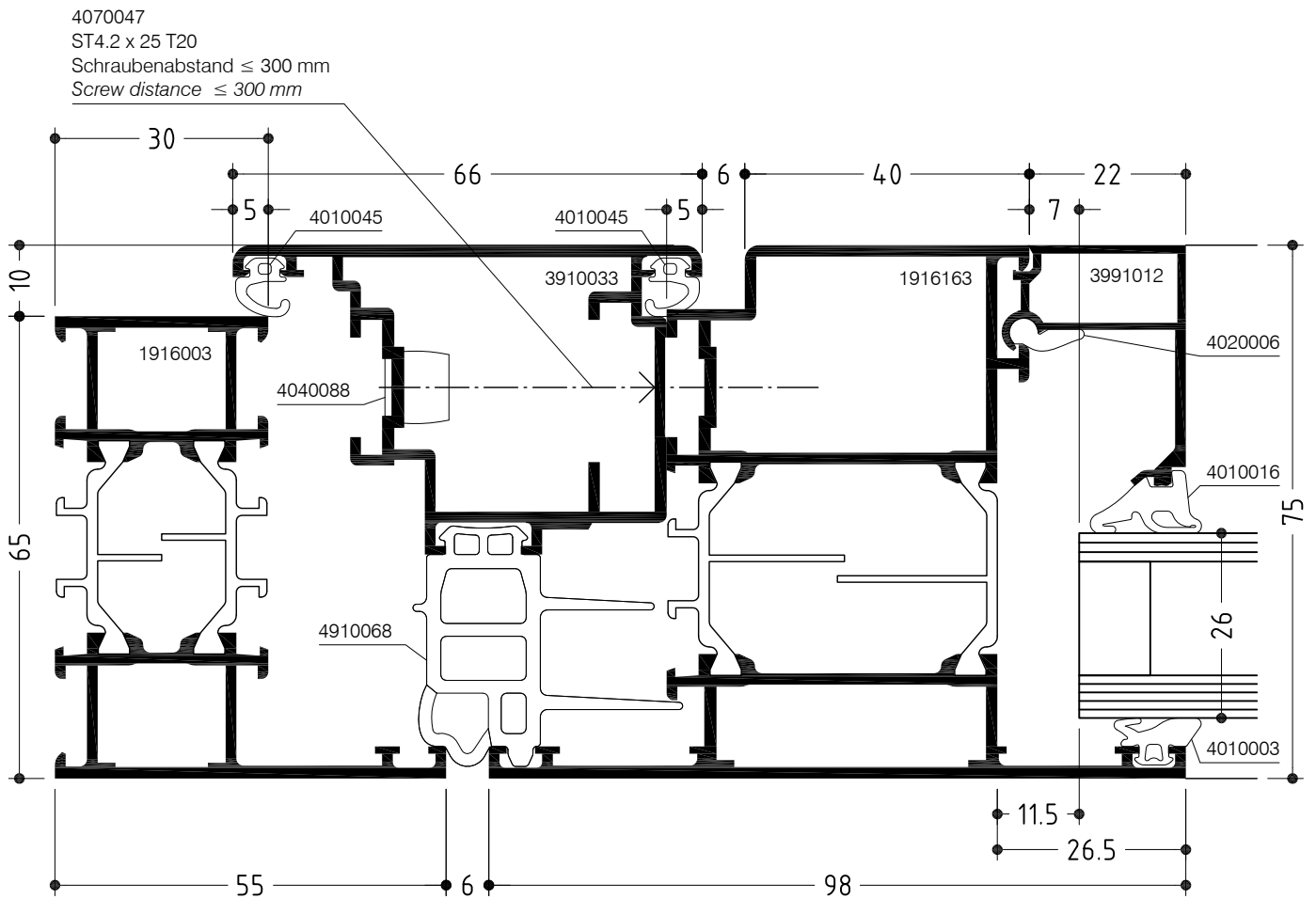
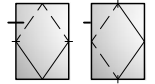



# WICLINE 65

Schwing-Wende-Fenster  
Horizontal/vertical pivot window

Konstruktionsschnitt  
Construction section

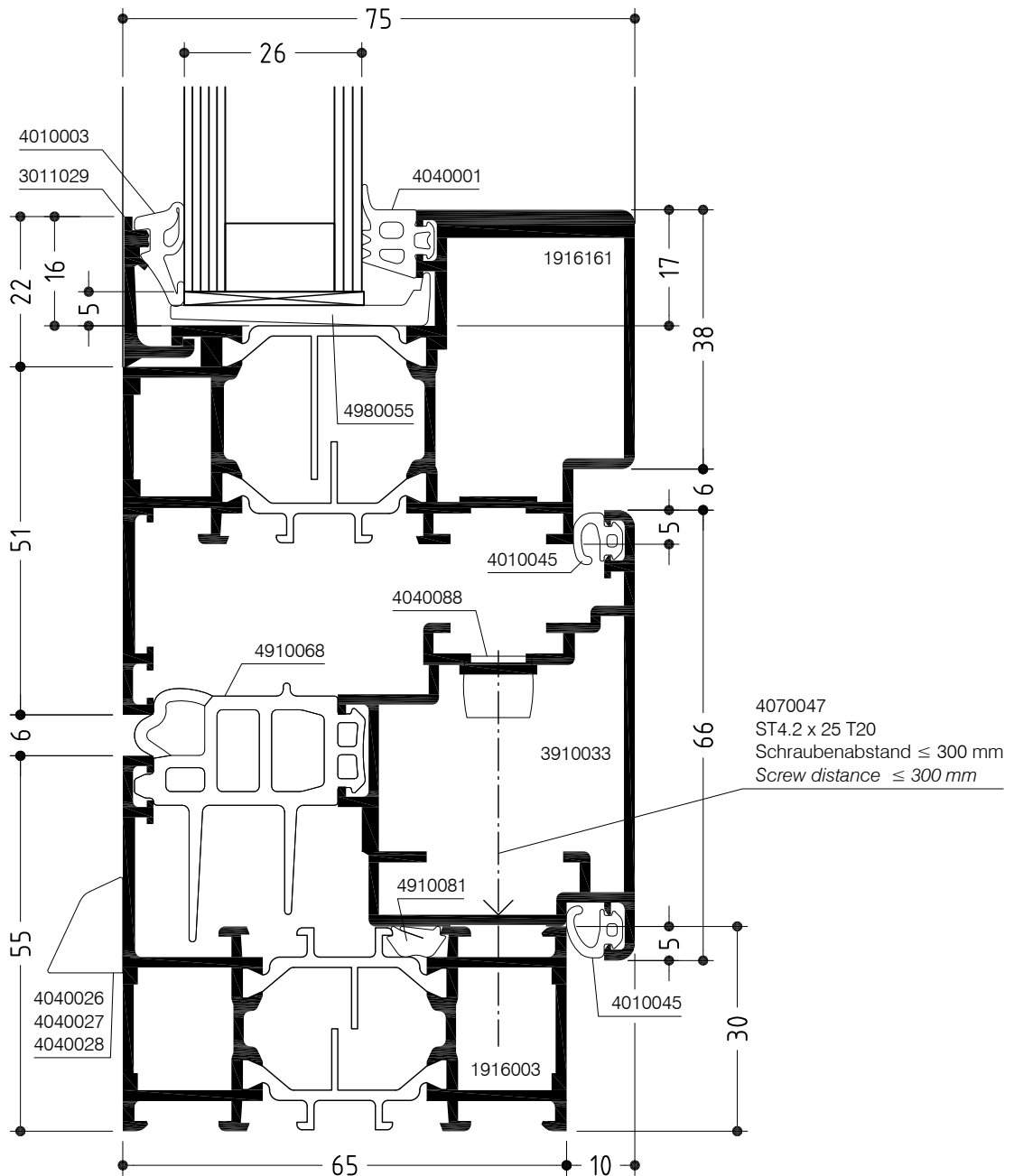
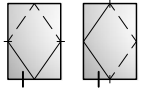

# WICLINE 65

Schwing-Wende-Fenster  
Horizontal/vertical pivot window

Konstruktionsschnitt  
Construction section

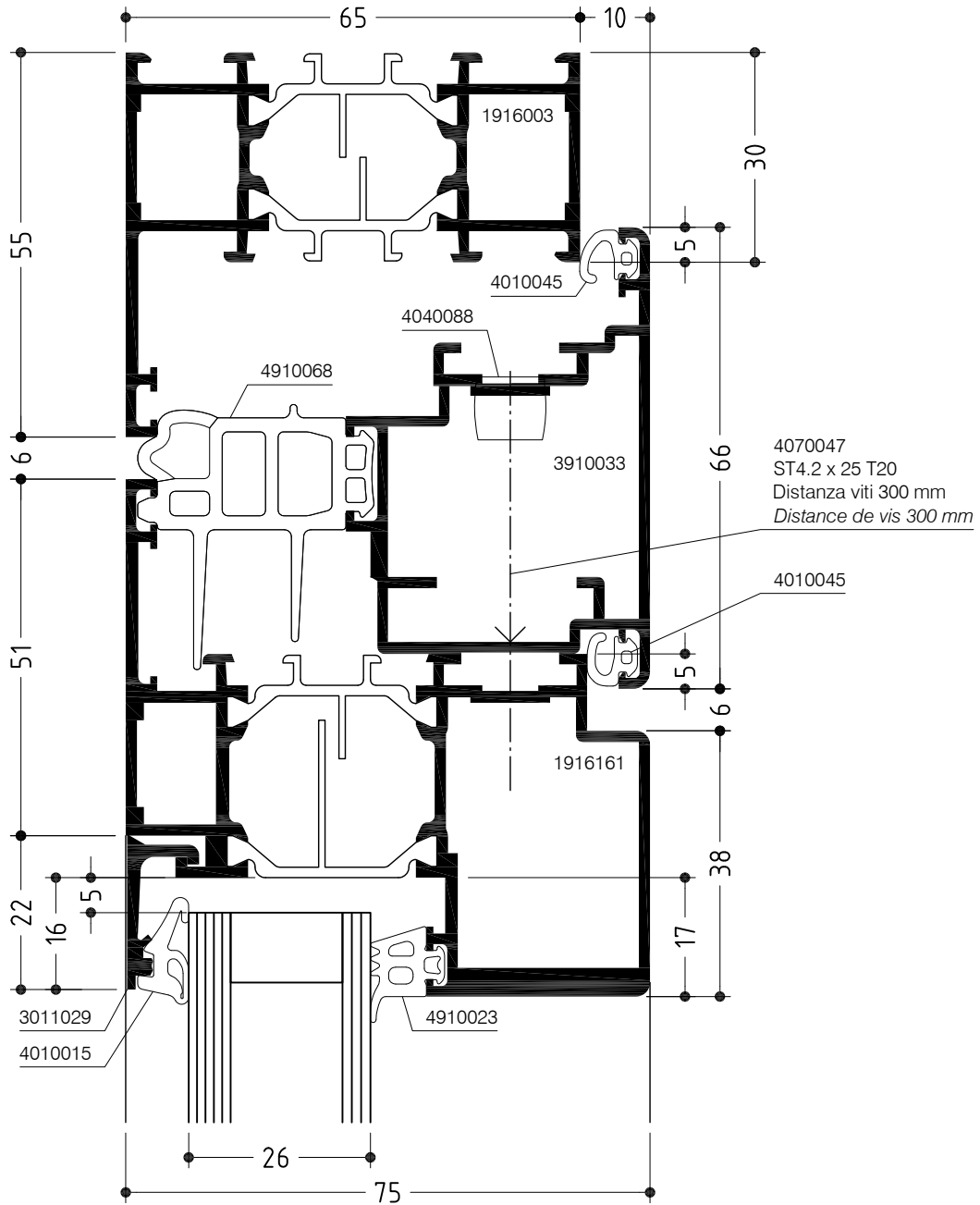
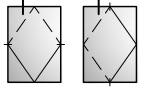

# WICLINE 65

Schwing-Wende-Fenster  
Horizontal/vertical pivot window

Konstruktionsschnitt  
Construction section

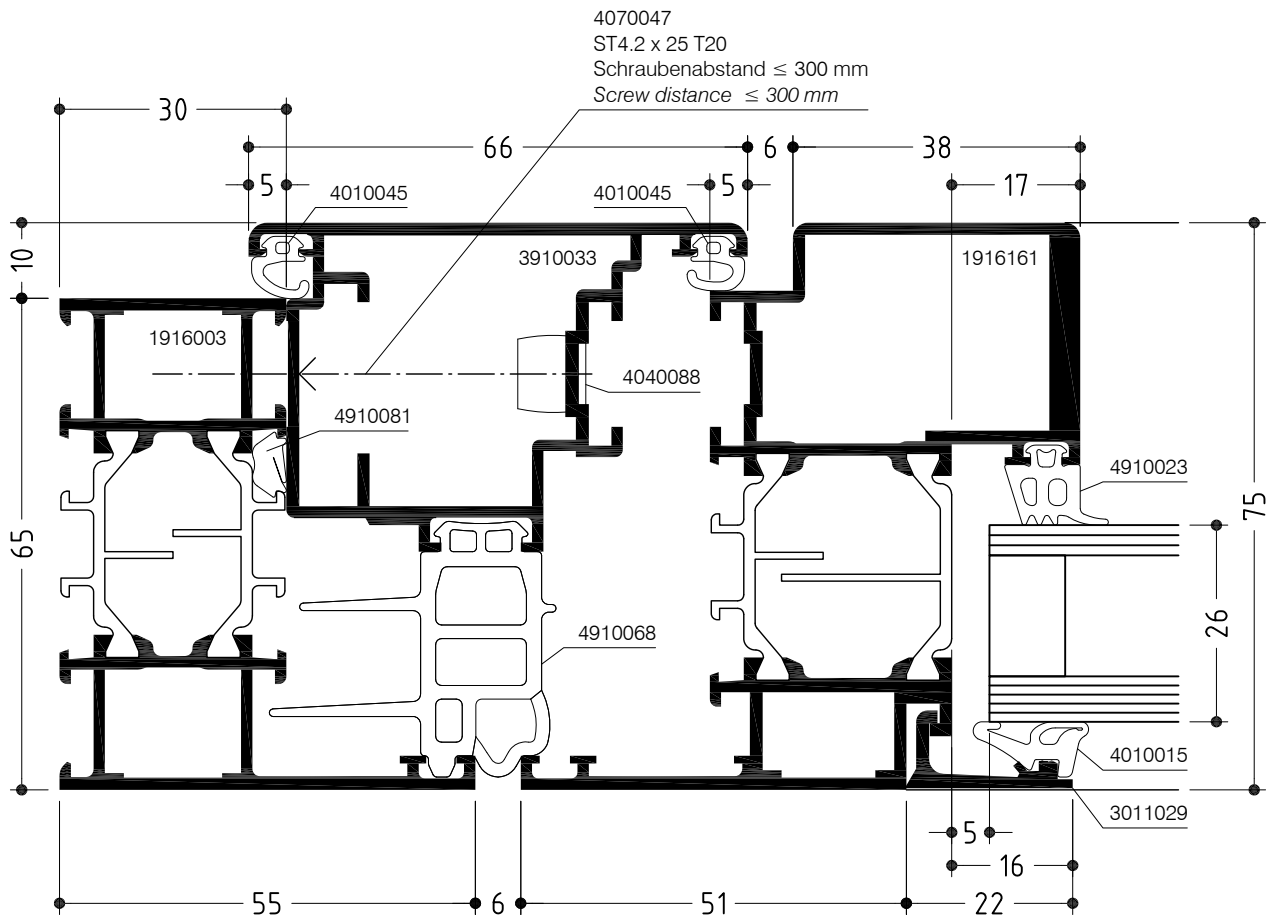
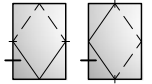

# WICLINE 65

Schwing-Wende-Fenster  
Horizontal/vertical pivot window

Konstruktionsschnitt  
Construction section

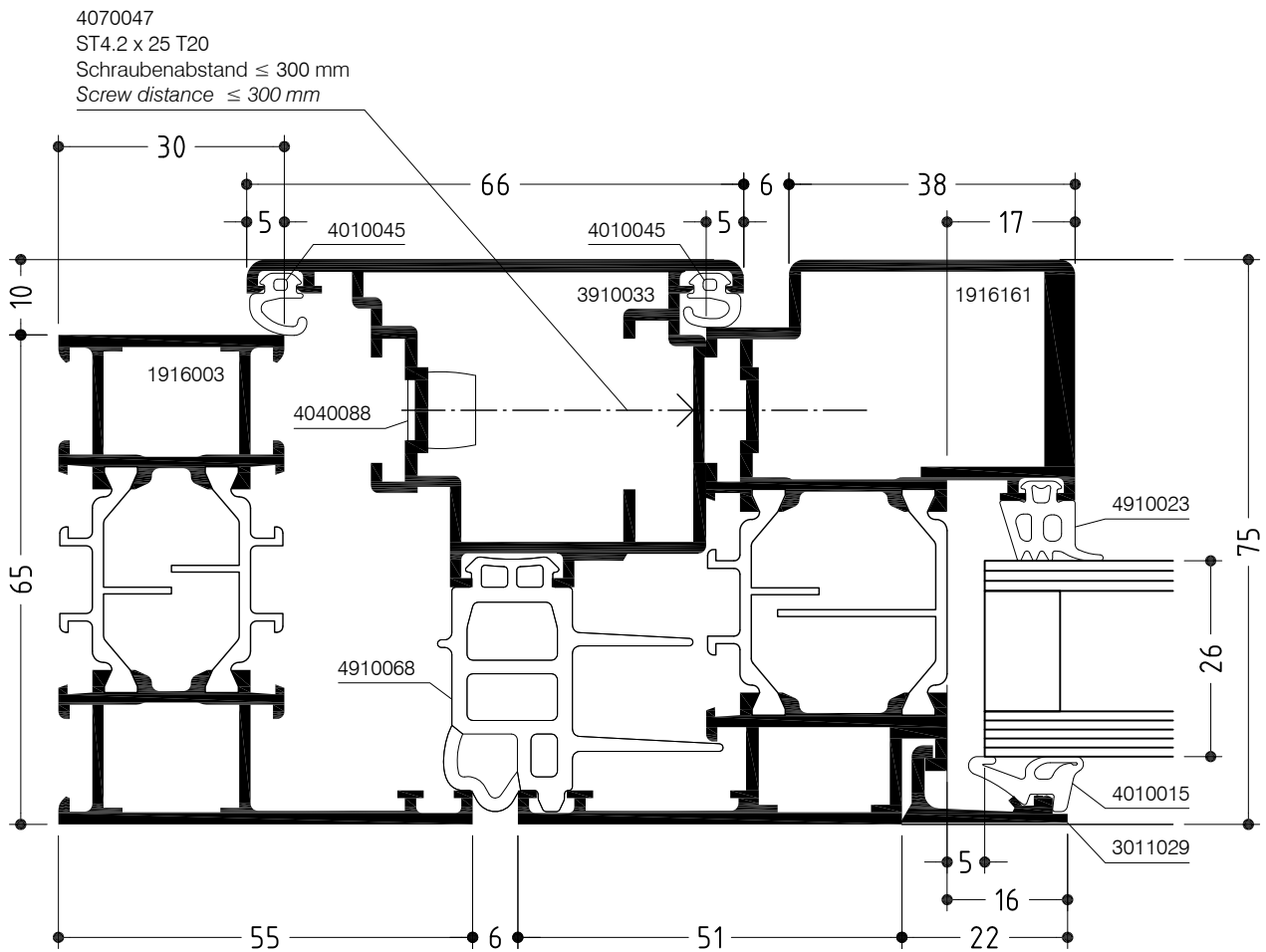
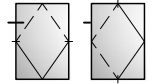

# WICLINE 65

Schwing-Wende-Fenster  
Horizontal/vertical pivot window

Konstruktionsschnitt  
Construction section

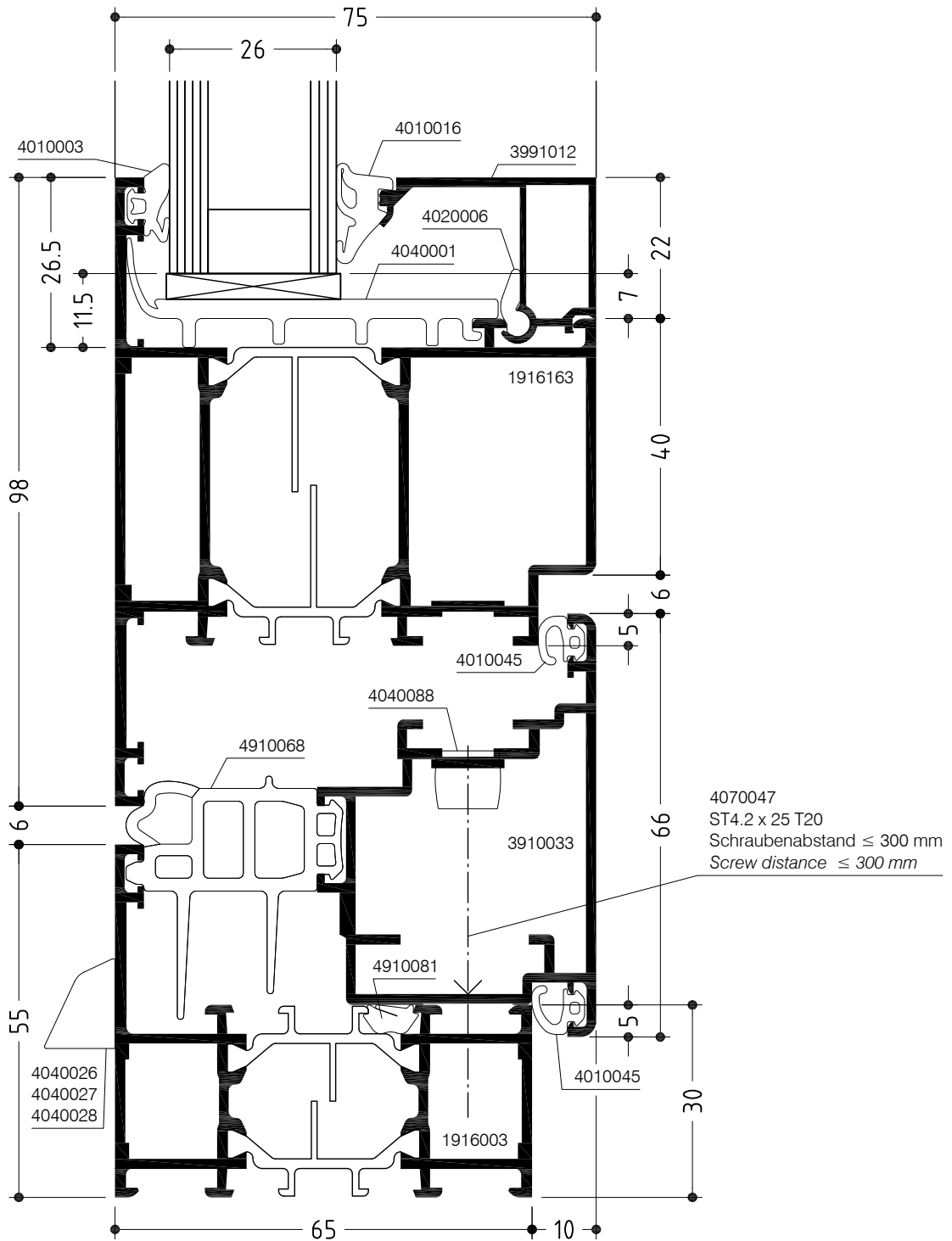
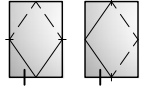

# WICLINE 65

Schwing-Wende-Fenster  
Horizontal/vertical pivot window

Konstruktionsschnitt  
Construction section

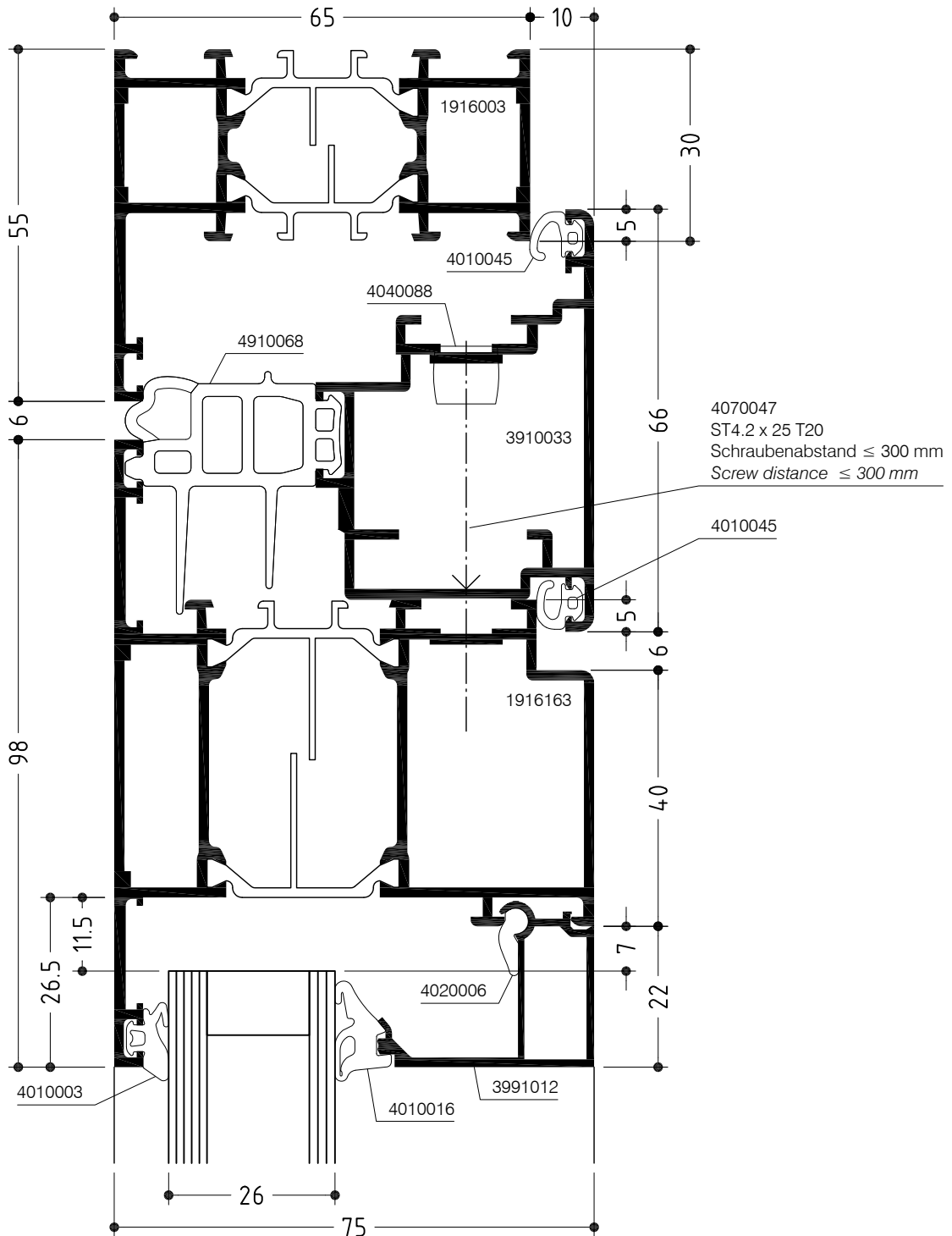
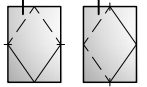

# WICLINE 65

## Konstruktionsschnitt

### Construction section

Fenstertür mit Schwellenprofil, einwärts

Casement door with threshold profile, inwards

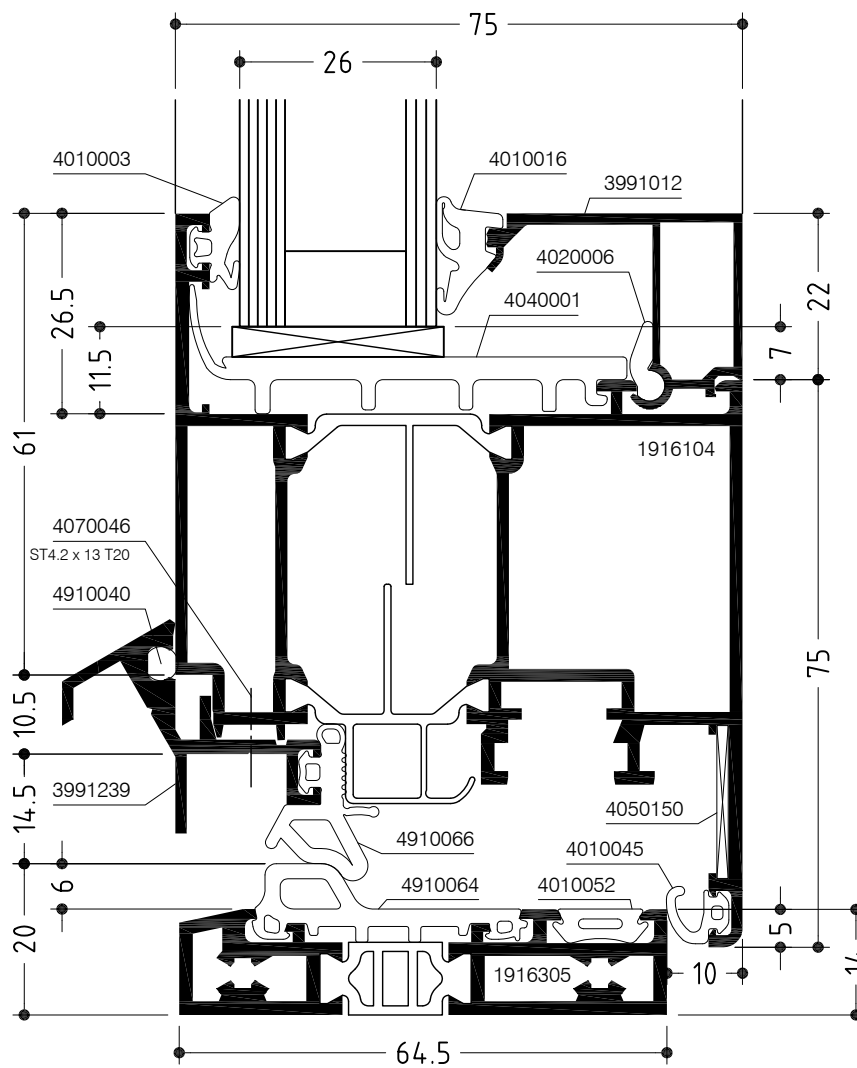
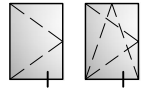

# WICLINE 65

Fenstertür mit Schwellenprofil, auswärts  
Casement door with threshold profile, outwards

Konstruktionsschnitt  
Construction section

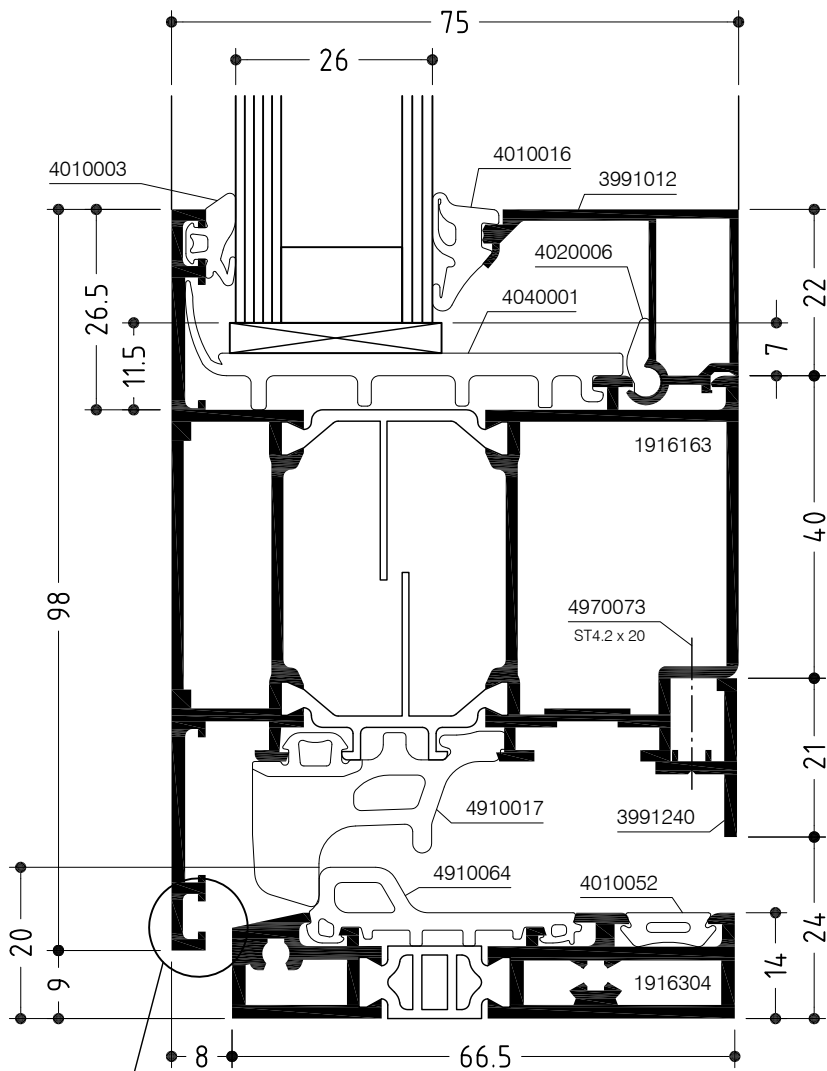

Dichtung unten entfällt über FAB.

Gasket at the bottom are not required across FAB.



# WICLINE 65

Fenstertür, einwärts  
Casement door, inwards

Konstruktionsschnitt  
Construction section

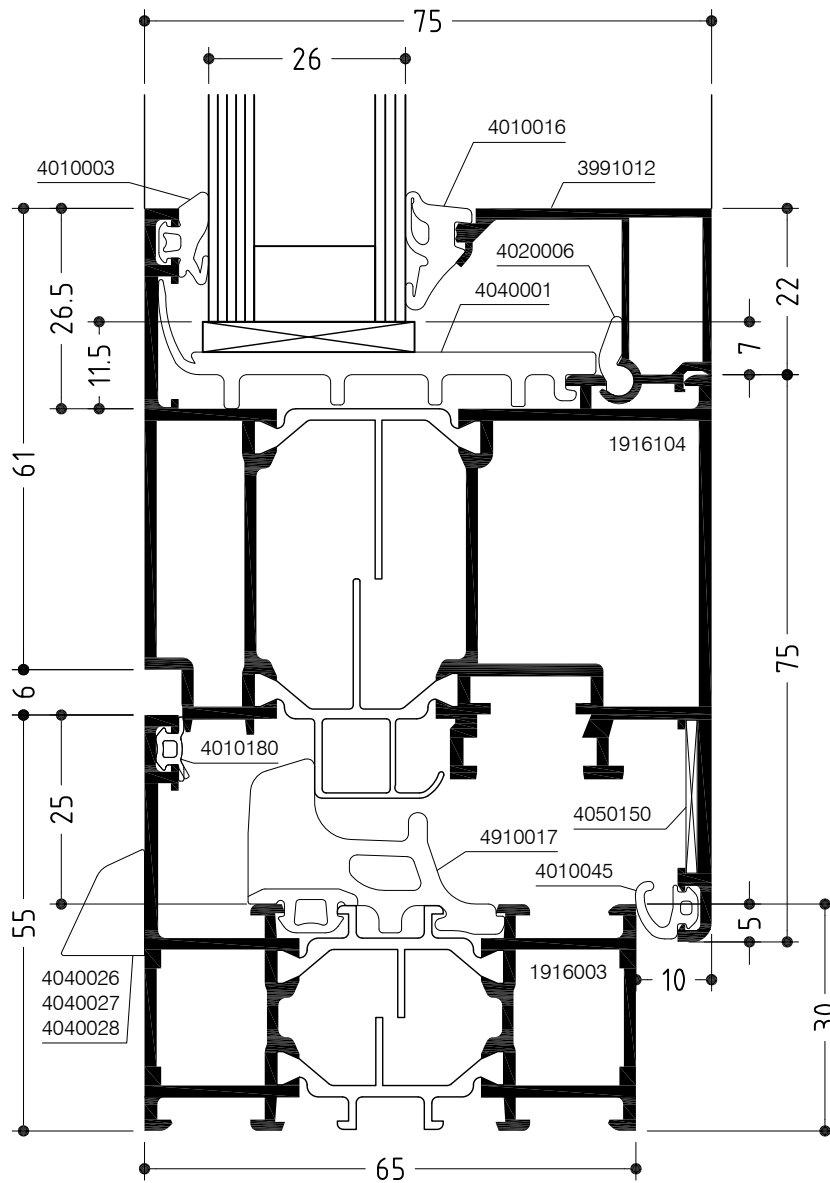
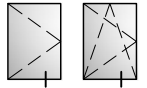

# WICLINE 65

## Konstruktionsschnitt Construction section

Fenstertür mit Aufsatzprofil, auswärts  
Casement door with supplementary profile, outwards

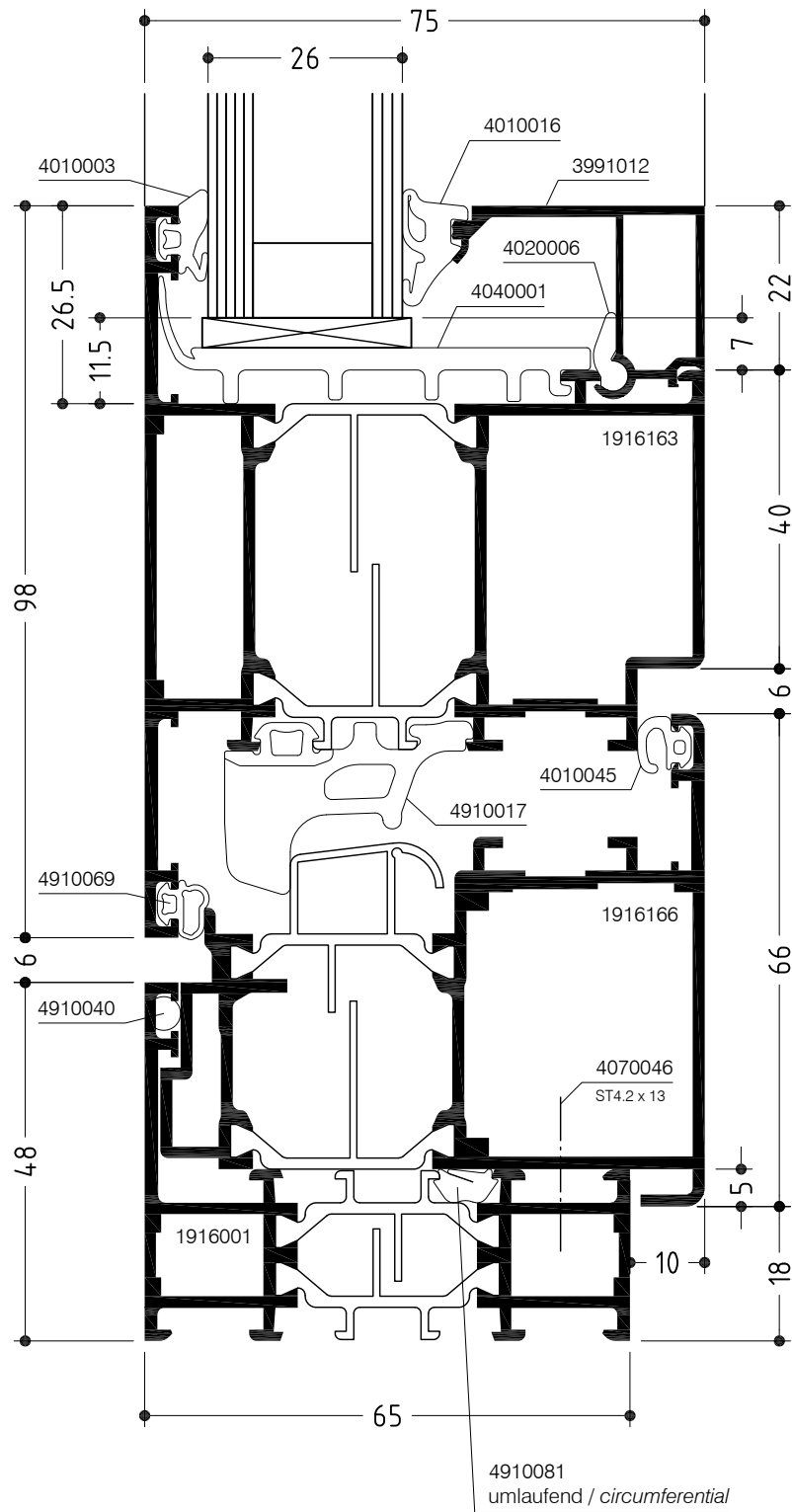

# WICLINE 65

Fenstertür, einwärts  
Casement door, inwards

Konstruktionsschnitt  
Construction section

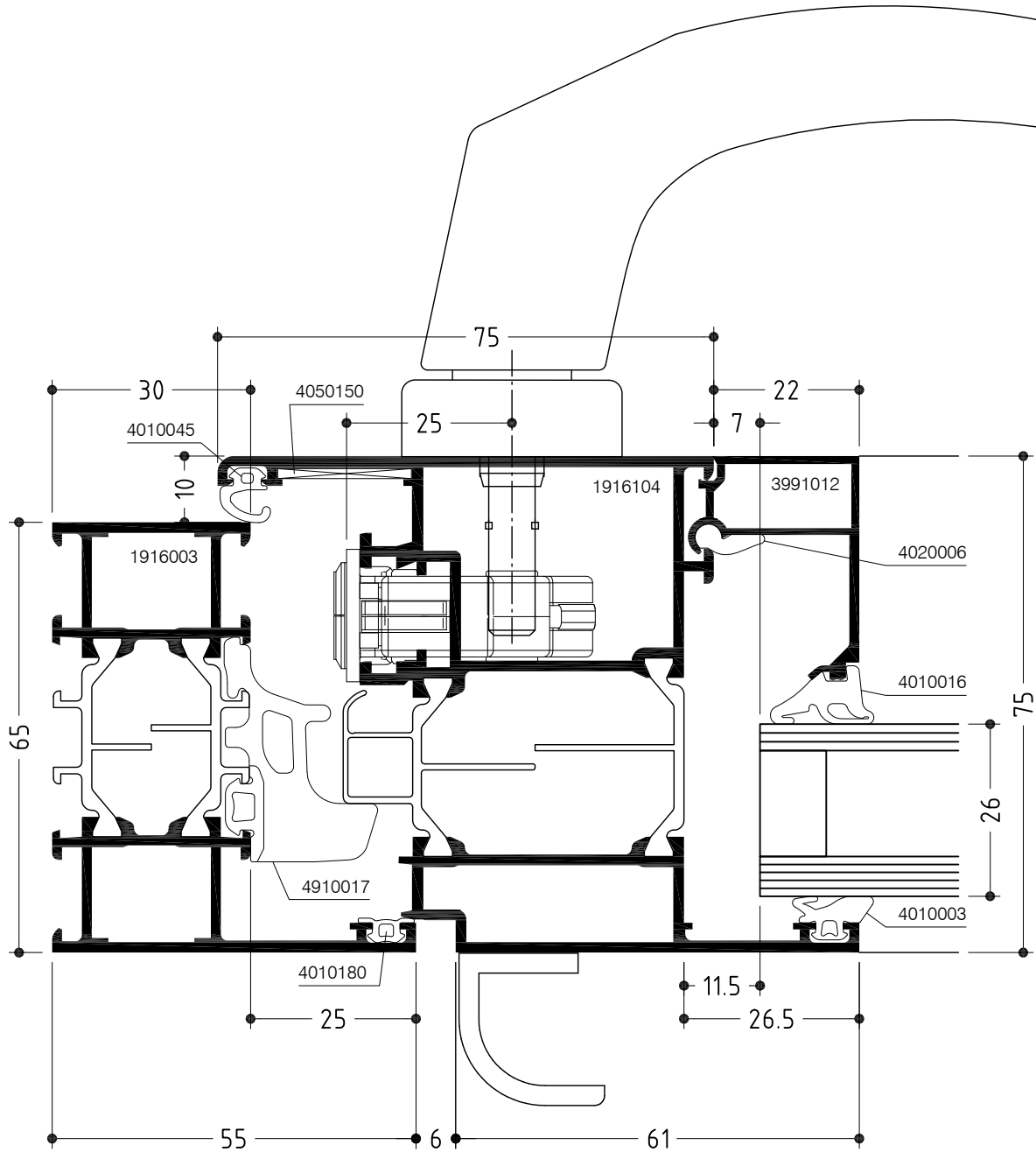
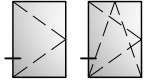

# WICLINE 65

Fenstertür, einwärts  
Casement door, inwards

Konstruktionsschnitt  
Construction section

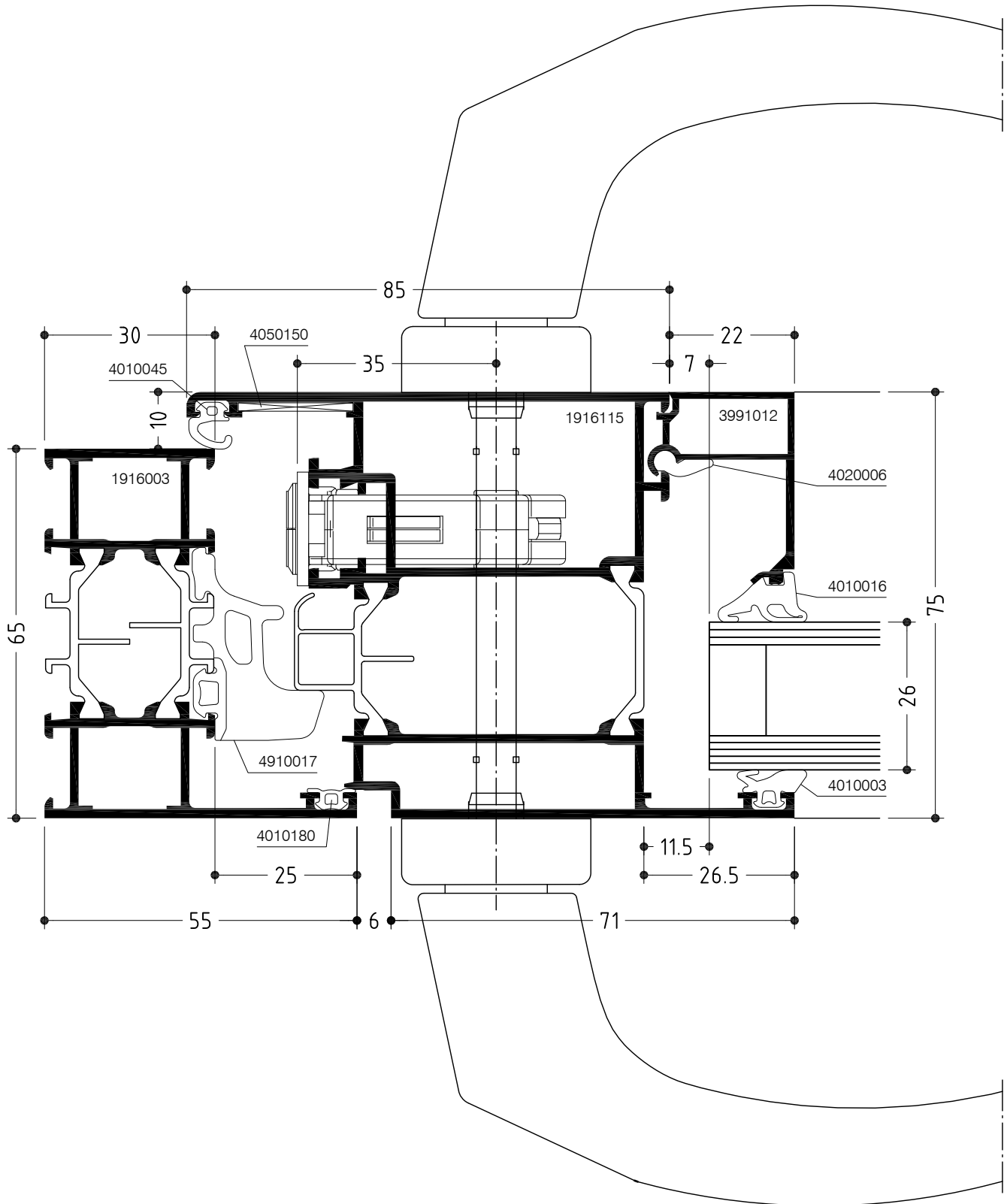
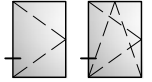

# WICLINE 65

## Konstruktionsschnitt Construction section

Fenstertür mit Aufsatzprofil, auswärts  
Casement door with supplementary profile, outwards

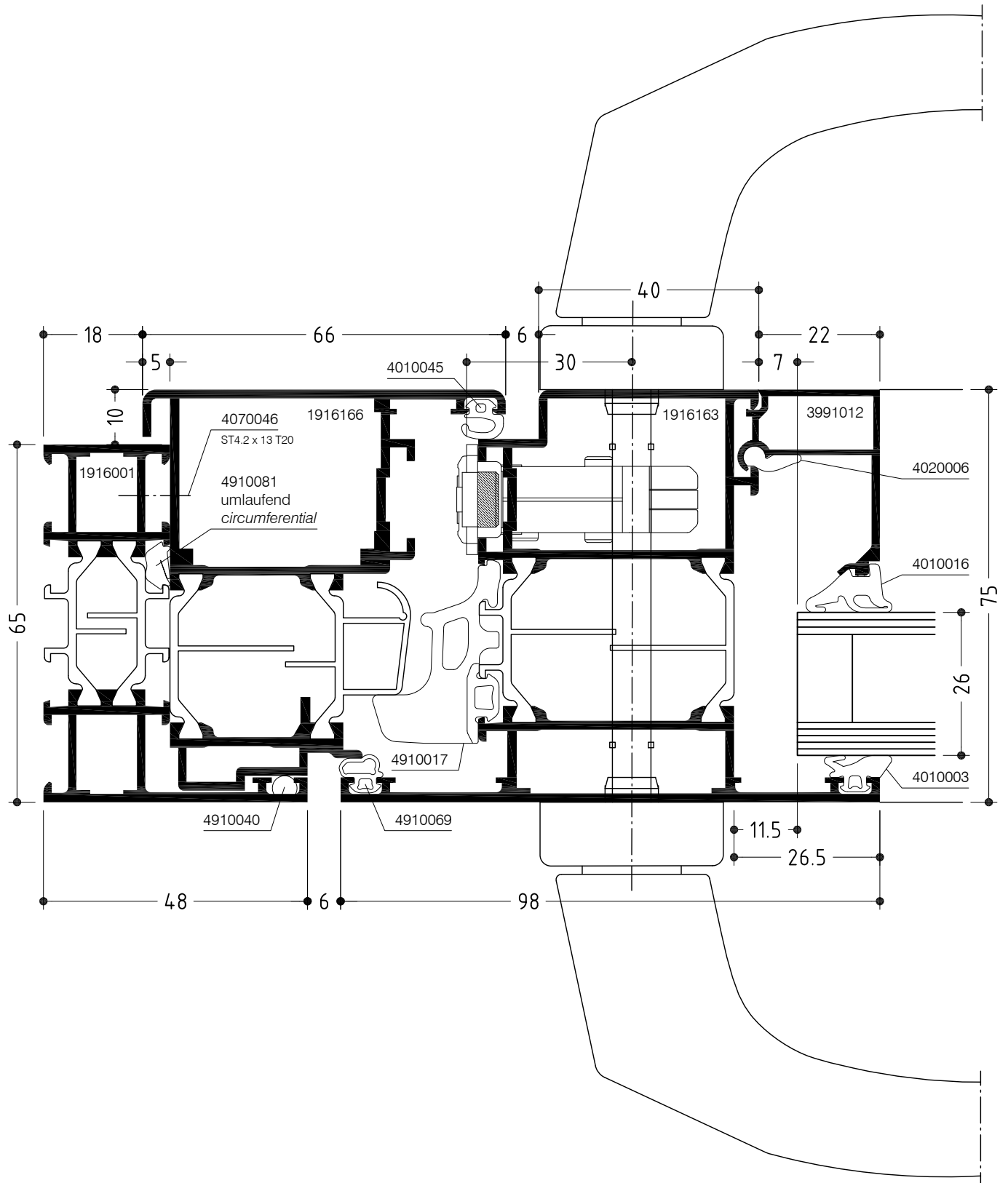



# WICLINE 65

## Konstruktionsschnitt

### Construction section

Fenstertür mit Schwellenprofil, einwärts

Casement door with threshold profile, inwards

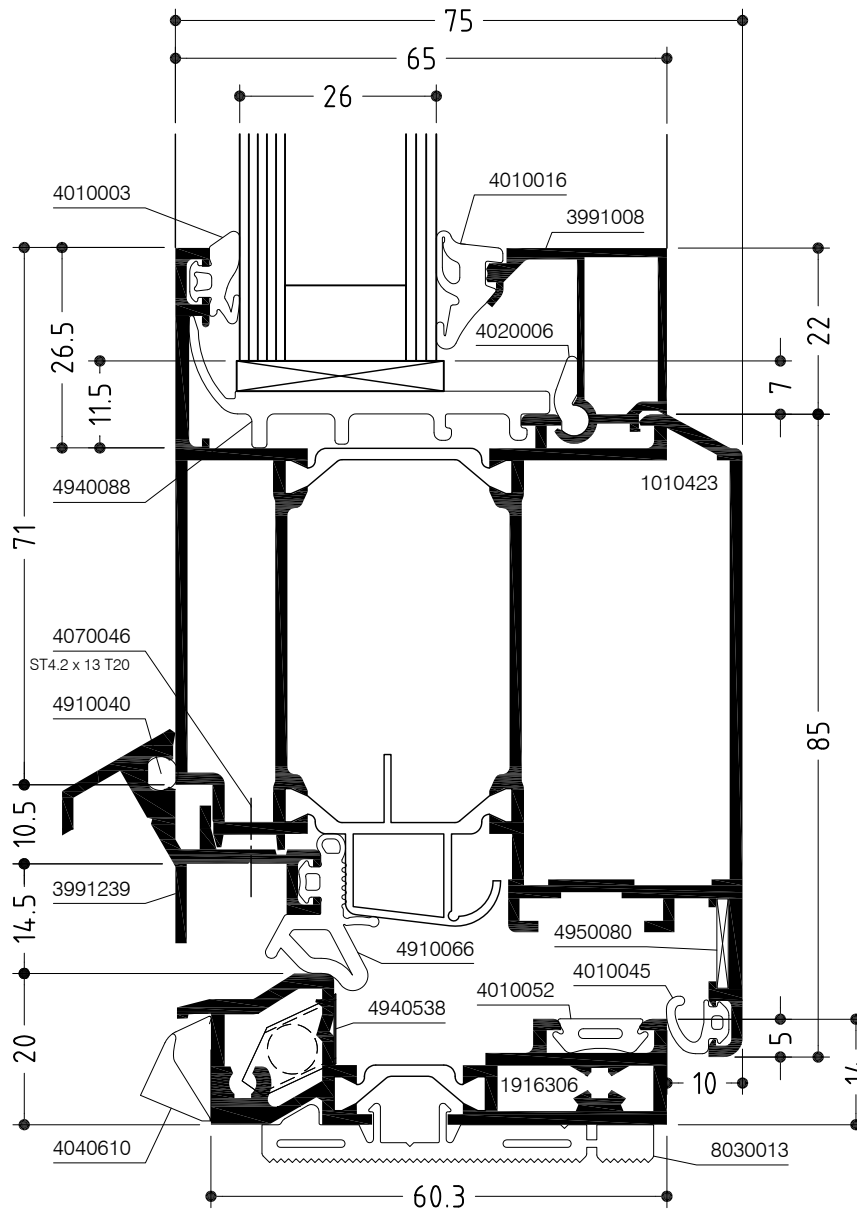

# WICLINE 65

Fenstertür mit Schwellenprofil, einwärts  
Casement door with threshold profile, inwards

Konstruktionsschnitt  
Construction section

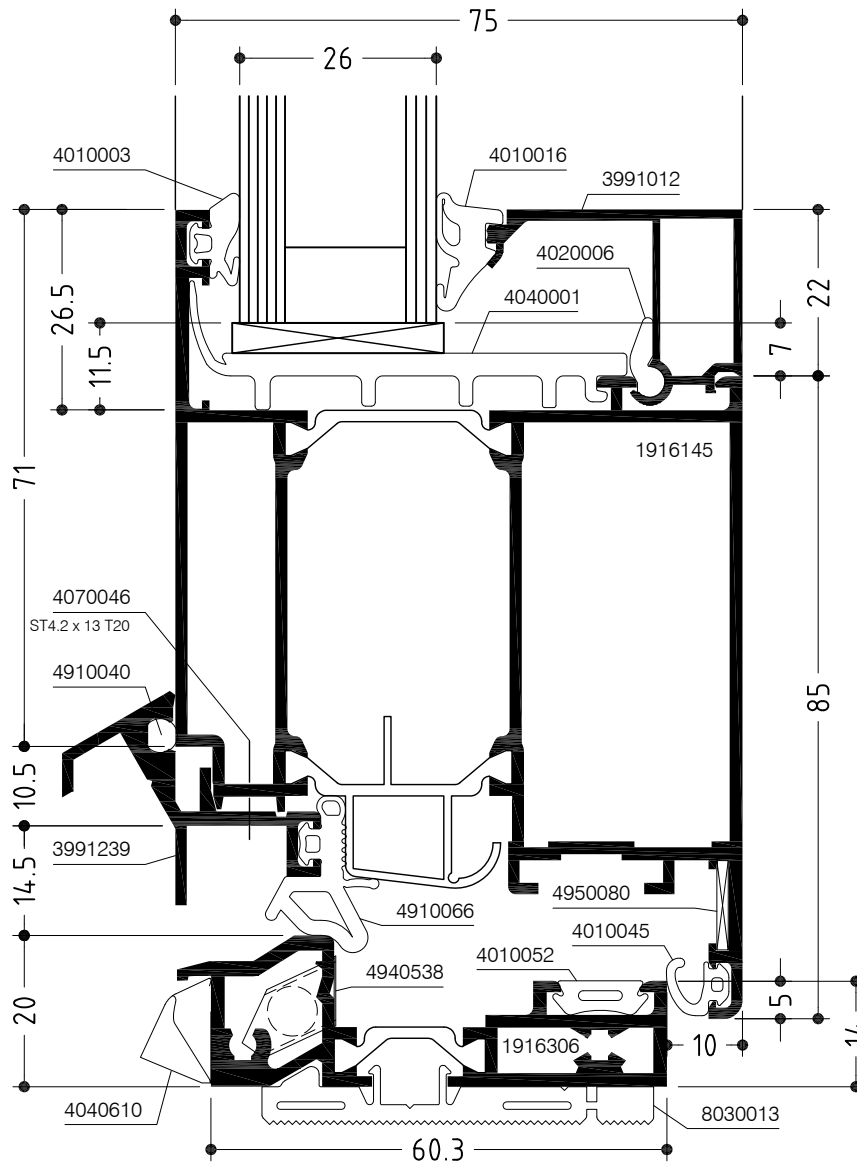



# WICLINE 65

## Konstruktionsschnitt

### Construction section

Fenstertür

Stulpfenster - Mittelstoß, verdeckter Flügel

Casement door

Double casement window with concealed sash - meeting stiles

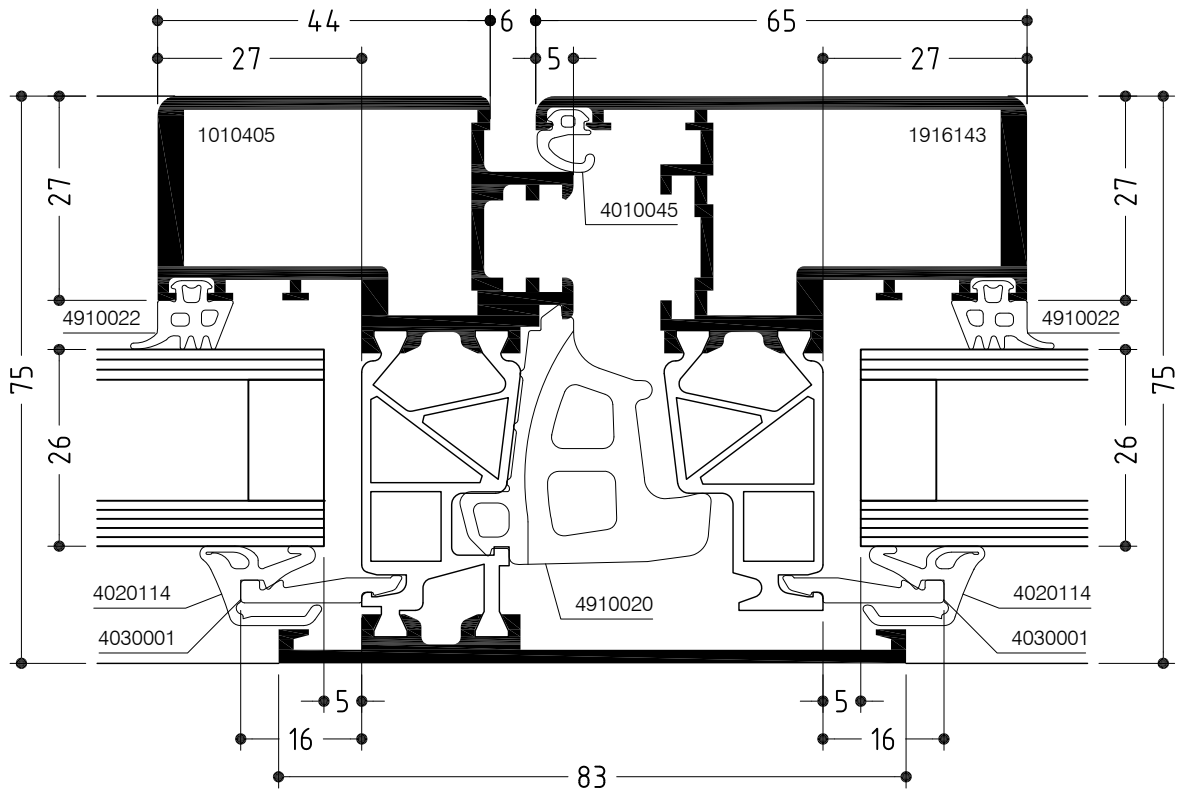
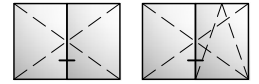

# WICLINE 65

Konstruktionsschnitt

Construction section

Fenstertür mit Schwellenprofil, verdeckter Flügel

Casement door with threshold profile, concealed sash in frame

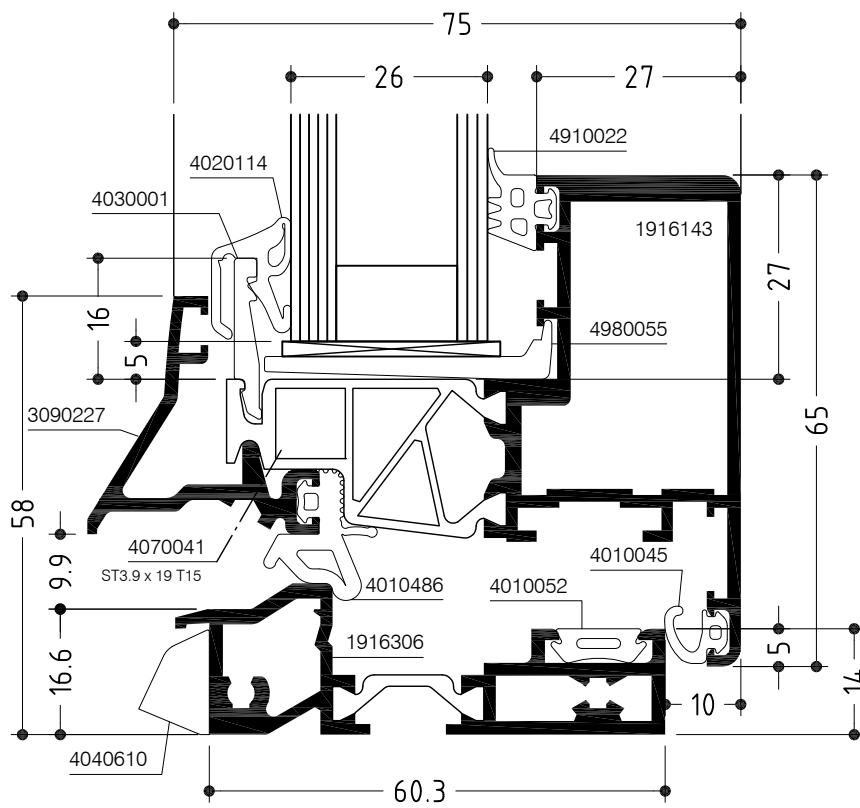

# WICLINE 65

## Konstruktionsschnitt

### Construction section

Fenstertür mit Schwellenprofil, einwärts

Casement door with threshold profile, inwards

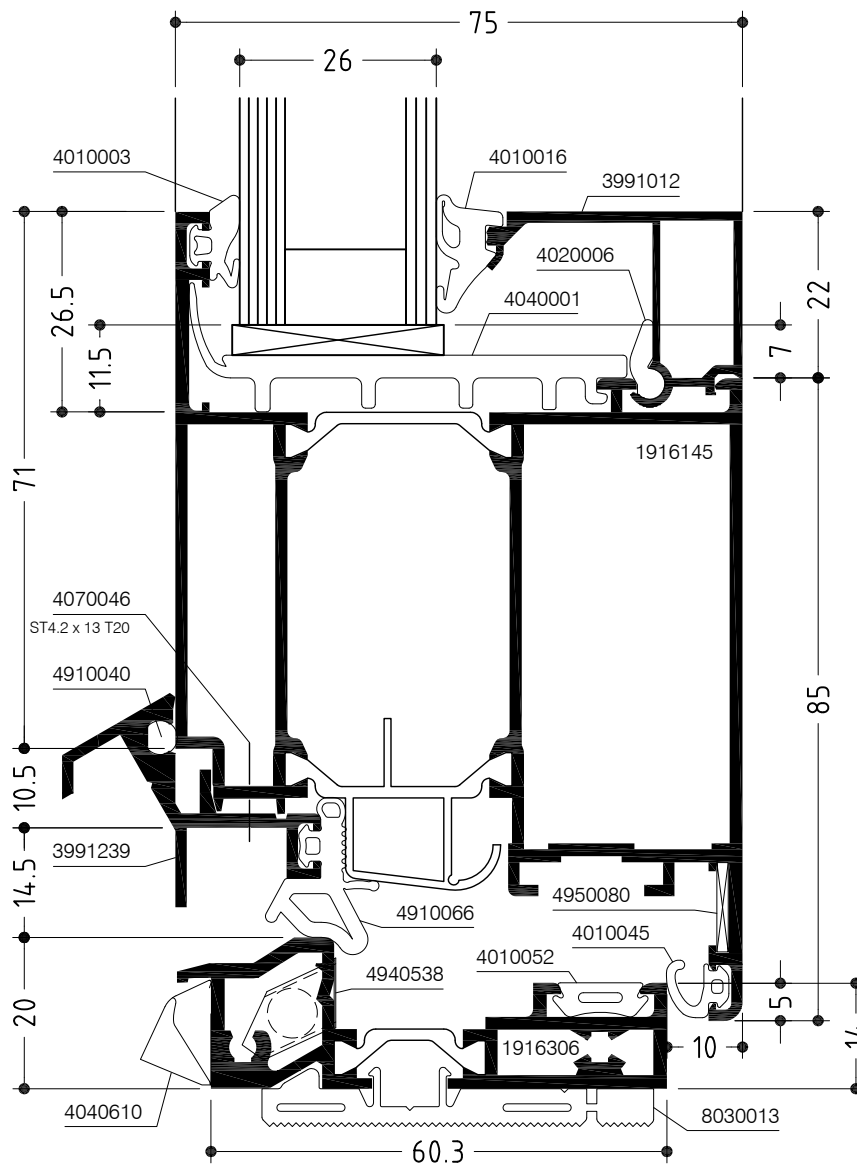

# WICLINE 65

Fenstertür mit Schwellenprofil, einwärts  
Casement door with threshold profile, inwards

Konstruktionsschnitt  
Construction section

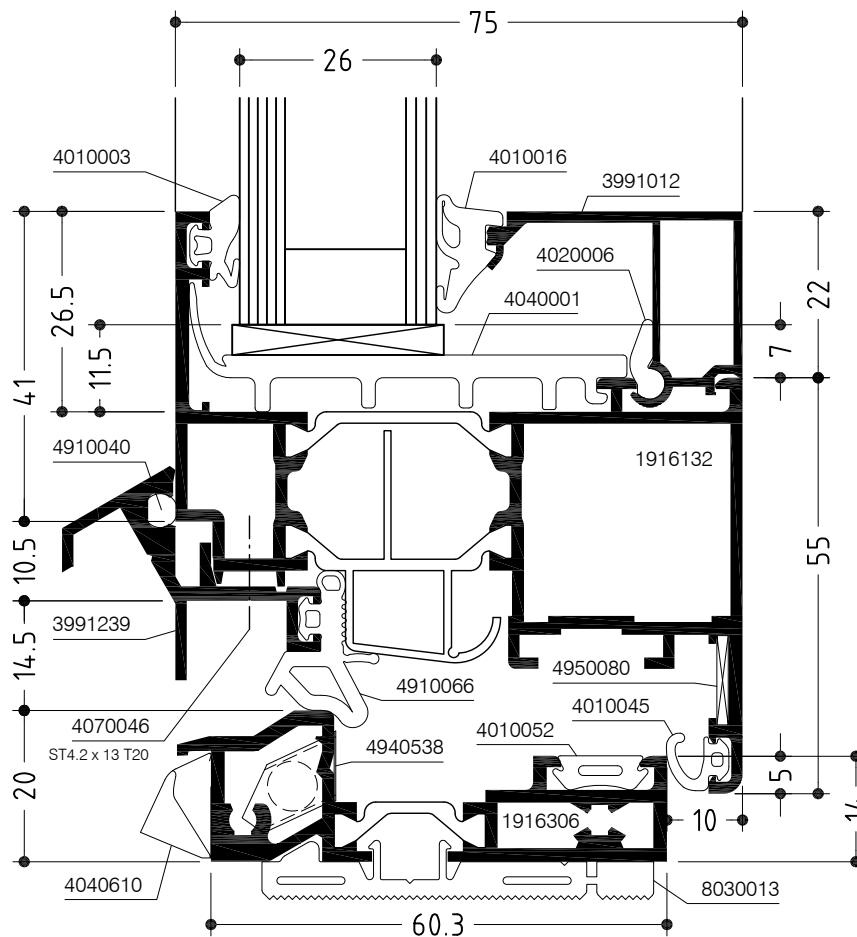

# WICLINE 65

Fenstertür, einwärts  
Casement door, inwards

Konstruktionsschnitt  
Construction section

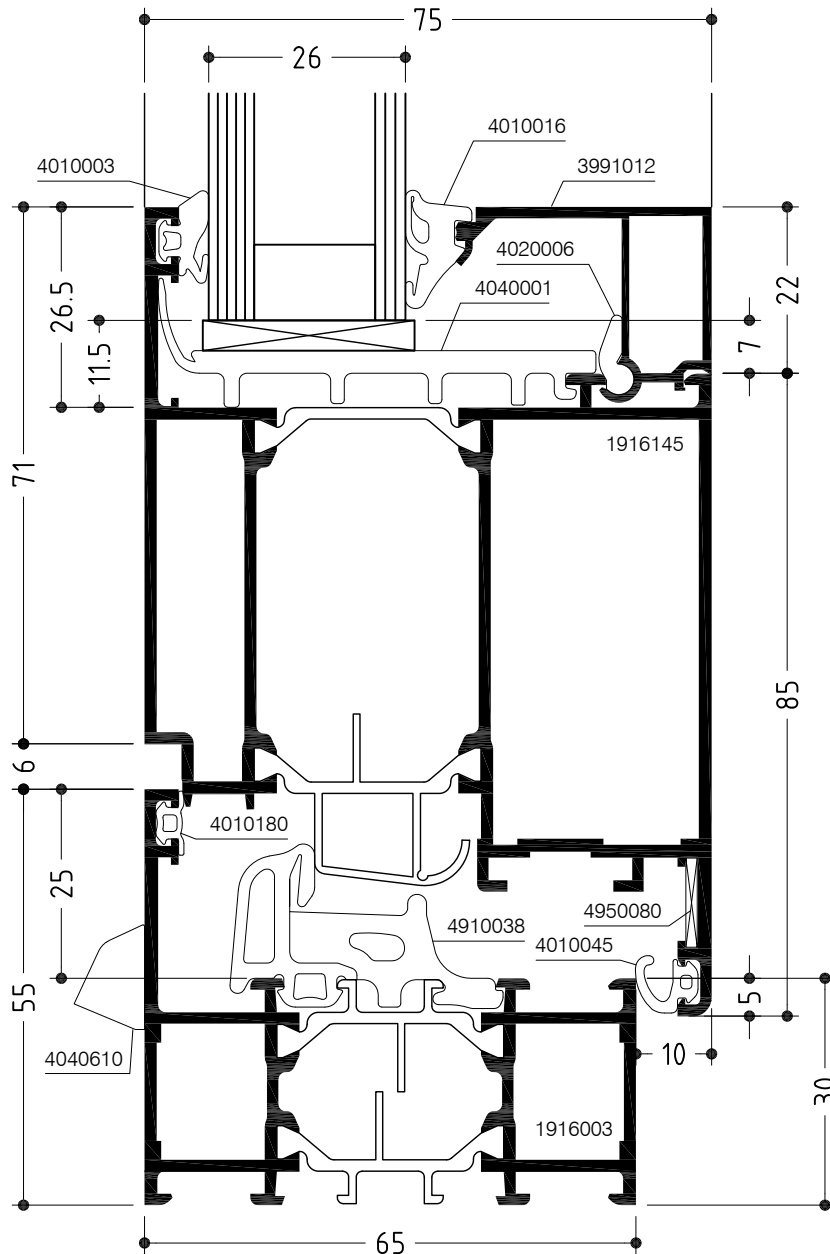
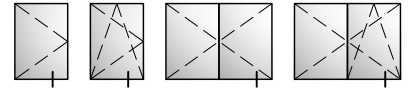



# WICLINE 65

Konstruktionsschnitt

Construction section

Parallel-Schiebe-Kipp-Fenster (ohne Zwangssteuerung)

Flügelgewicht max. 100 kg

Parallel sliding tilt window (without force operation)

Sash weight max. 100 kg

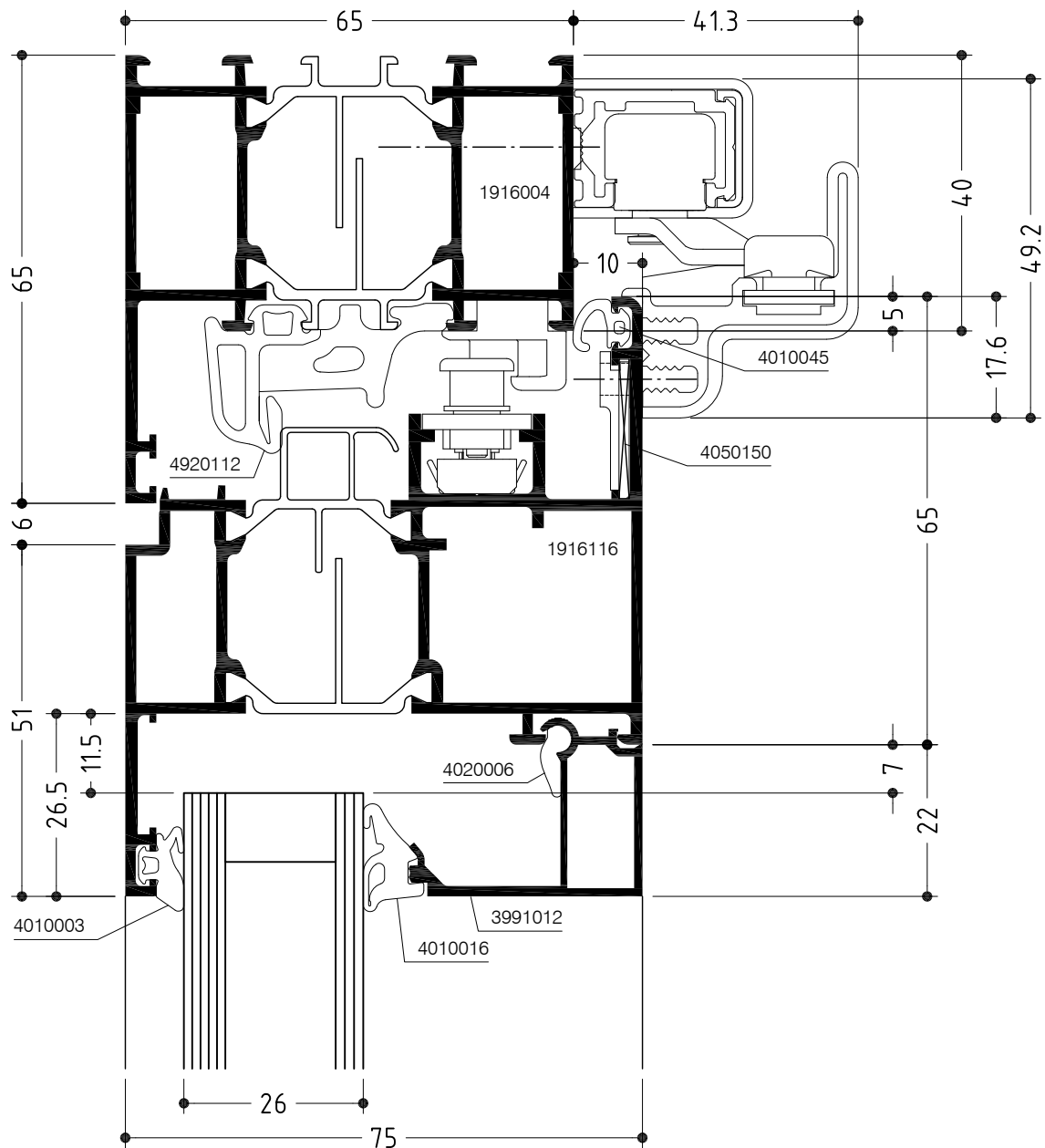
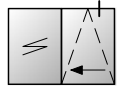

# WICLINE 65

Konstruktionsschnitt

Construction section

Parallel-Schiebe-Kipp-Fenster (ohne Zwangssteuerung)

Flügelgewicht max. 100 kg

Parallel sliding tilt window (without force operation)

Sash weight max. 100 kg

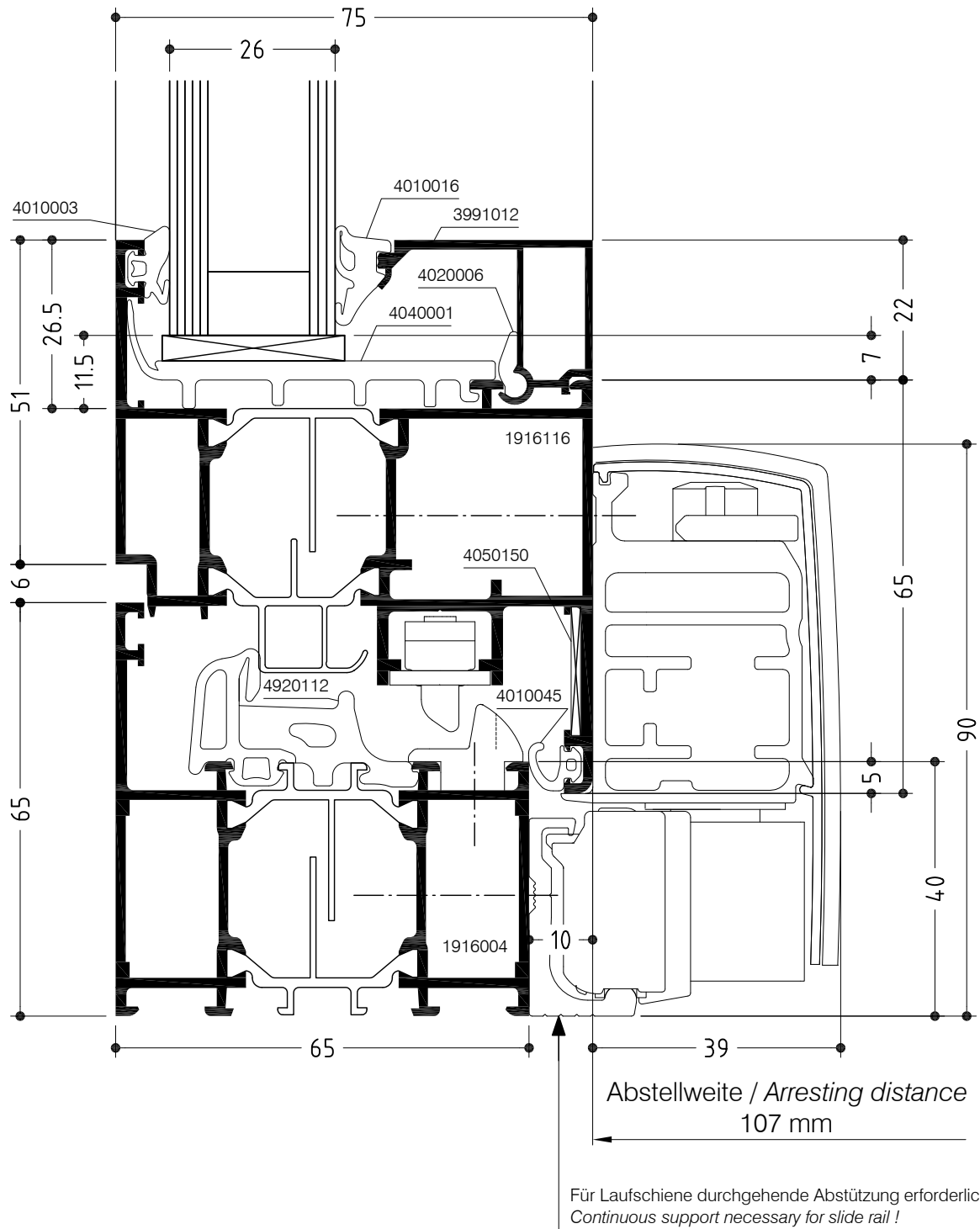
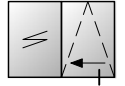



# WICLINE 65

Konstruktionsschnitt

Construction section

Parallel-Schiebe-Kipp-Fenster (ohne Zwangssteuerung)

Flügelgewicht max. 100 kg

Parallel sliding tilt window (without force operation)

Sash weight max. 100 kg

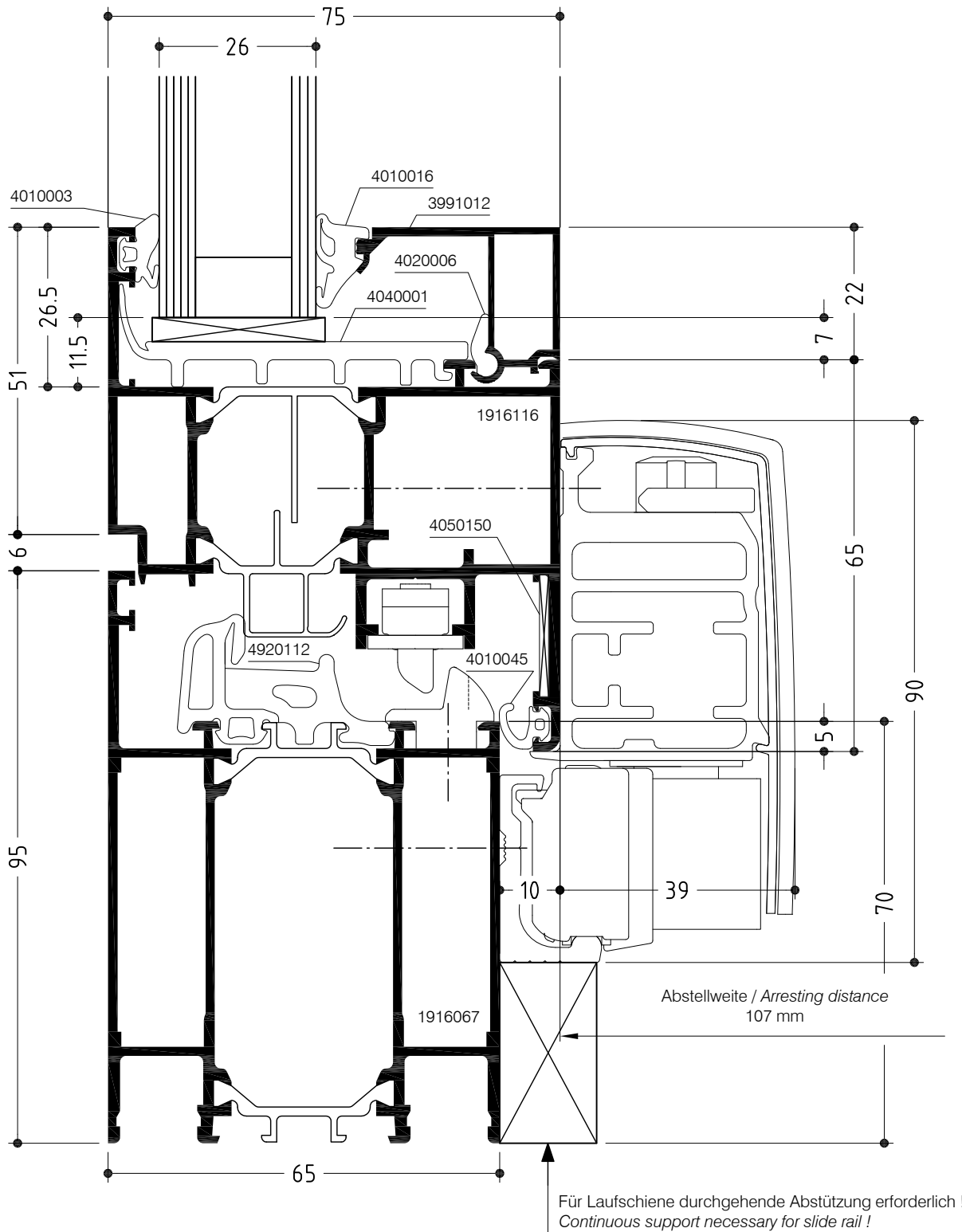
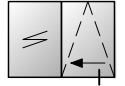

# WICLINE 65

Konstruktionsschnitt

Construction section

Parallel-Schiebe-Kipp-Fenster (ohne Zwangssteuerung)

Flügelgewicht max. 160 kg

Parallel sliding tilt window (without force operation)

Sash weight max. 160 kg

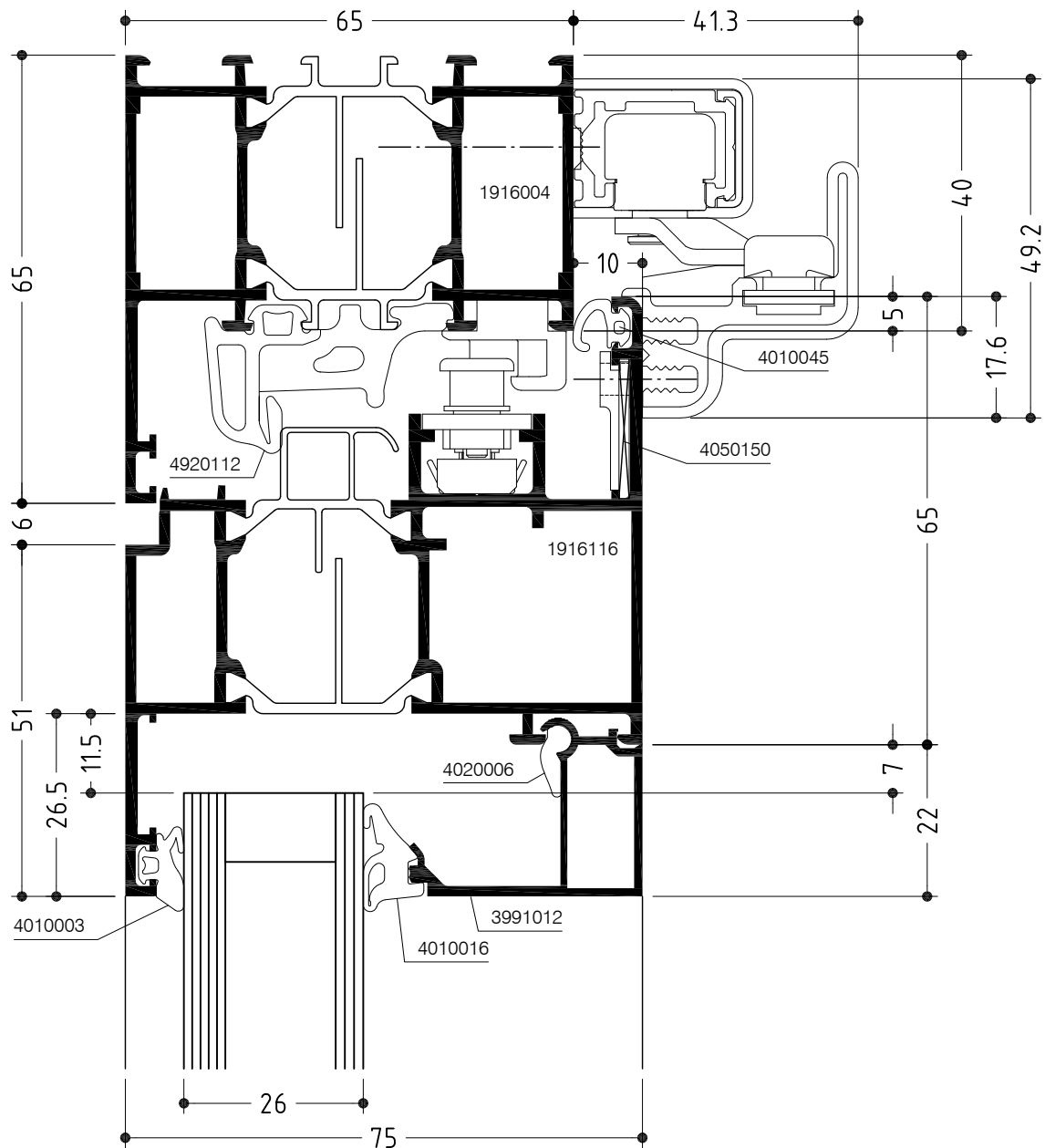
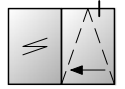

# WICLINE 65

Konstruktionsschnitt

Construction section

Parallel-Schiebe-Kipp-Fenster (ohne Zwangssteuerung)

Flügelgewicht max. 160 kg

Parallel sliding tilt window (without force operation)

Sash weight max. 160 kg

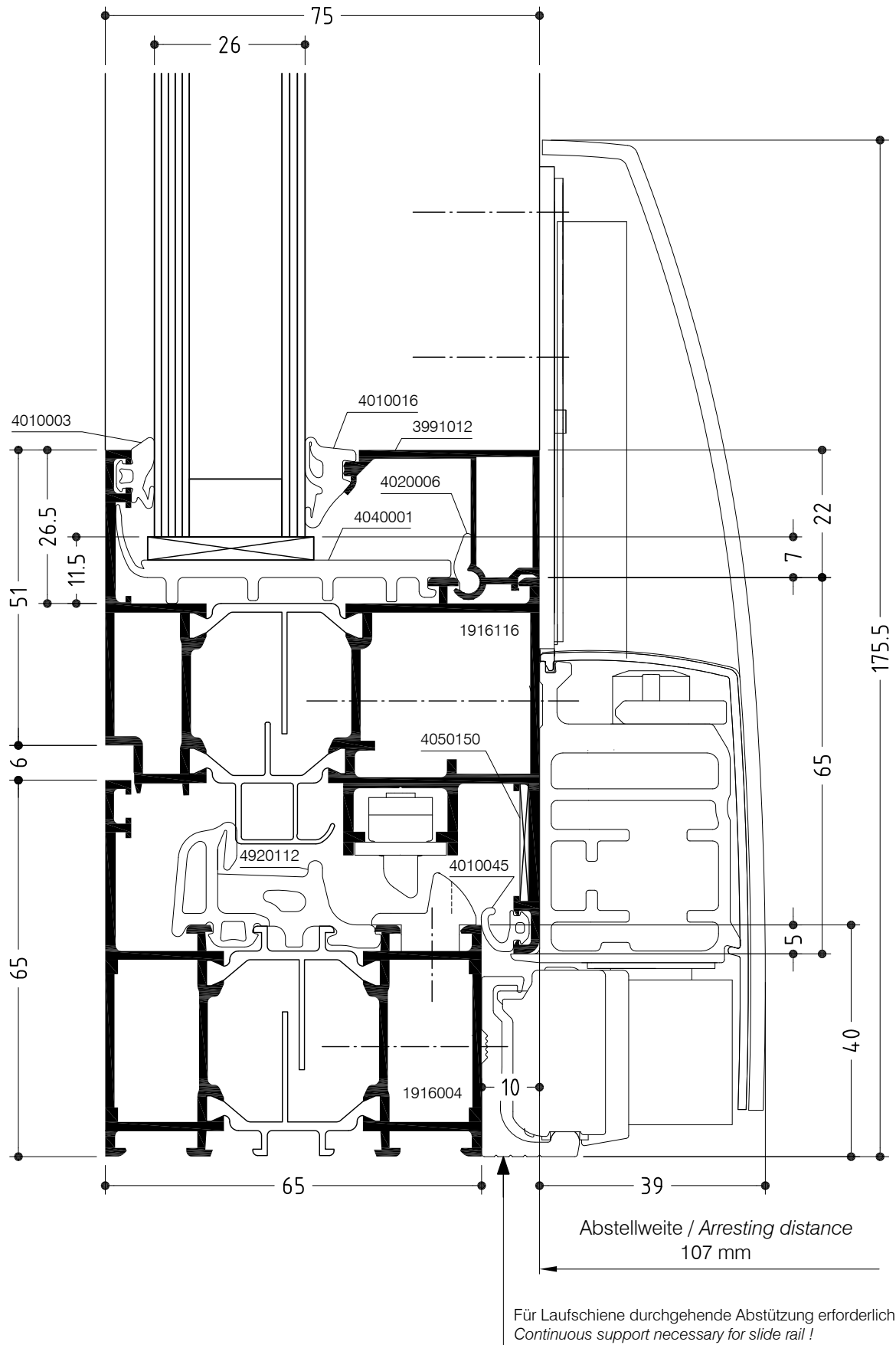
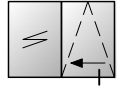

# WICLINE 65

Konstruktionsschnitt

Construction section

Parallel-Schiebe-Kipp-Fenster (mit Zwangssteuerung)

Flügelgewicht max. 100 kg

Parallel sliding tilt window (with force operation)

Sash weight max. 100 kg

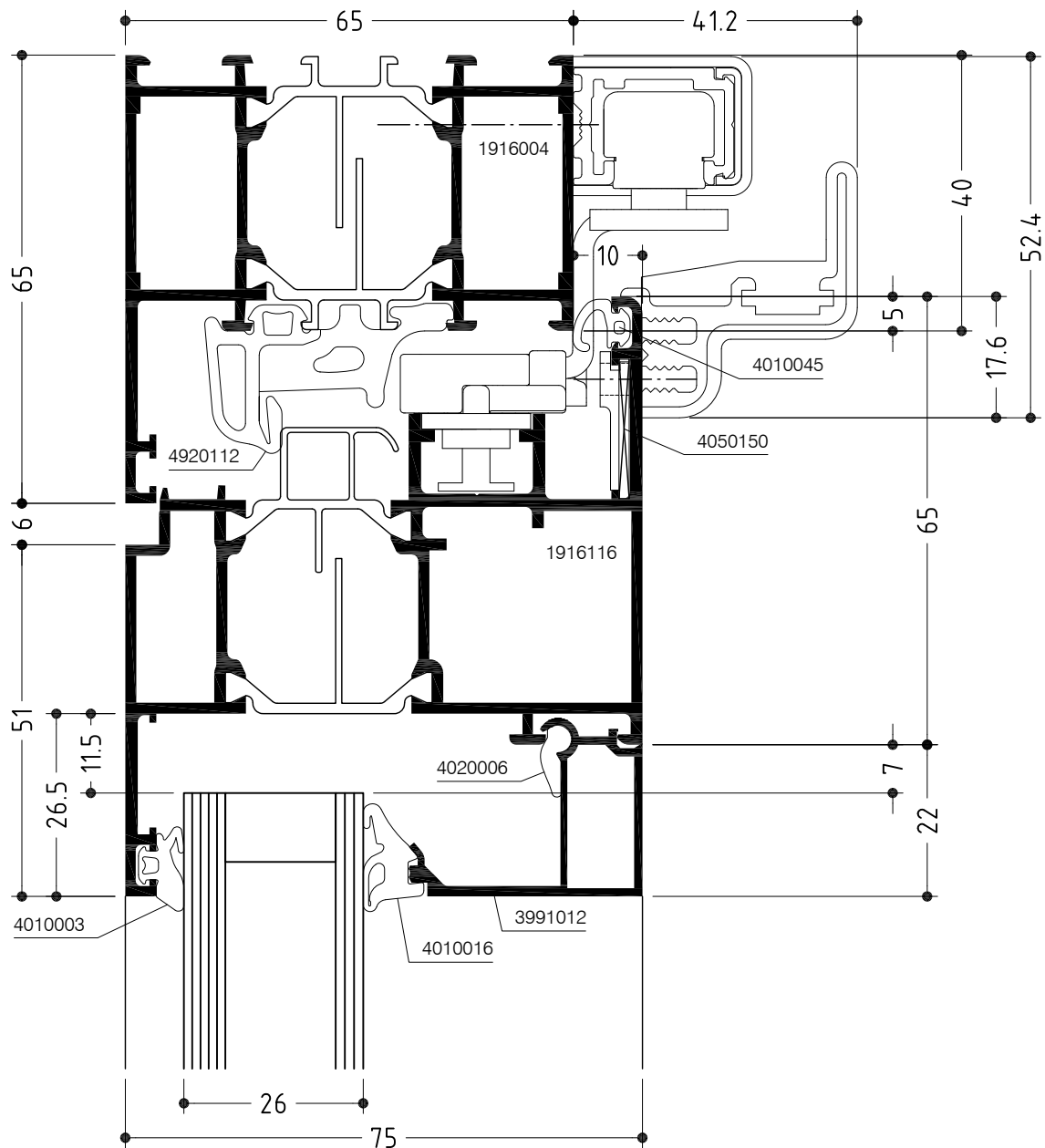
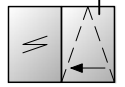

# WICLINE 65

Konstruktionsschnitt

Construction section

Parallel-Schiebe-Kipp-Fenster (mit Zwangssteuerung)

Flügelgewicht max. 100 kg

Parallel sliding tilt window (with force operation)

Sash weight max. 100 kg

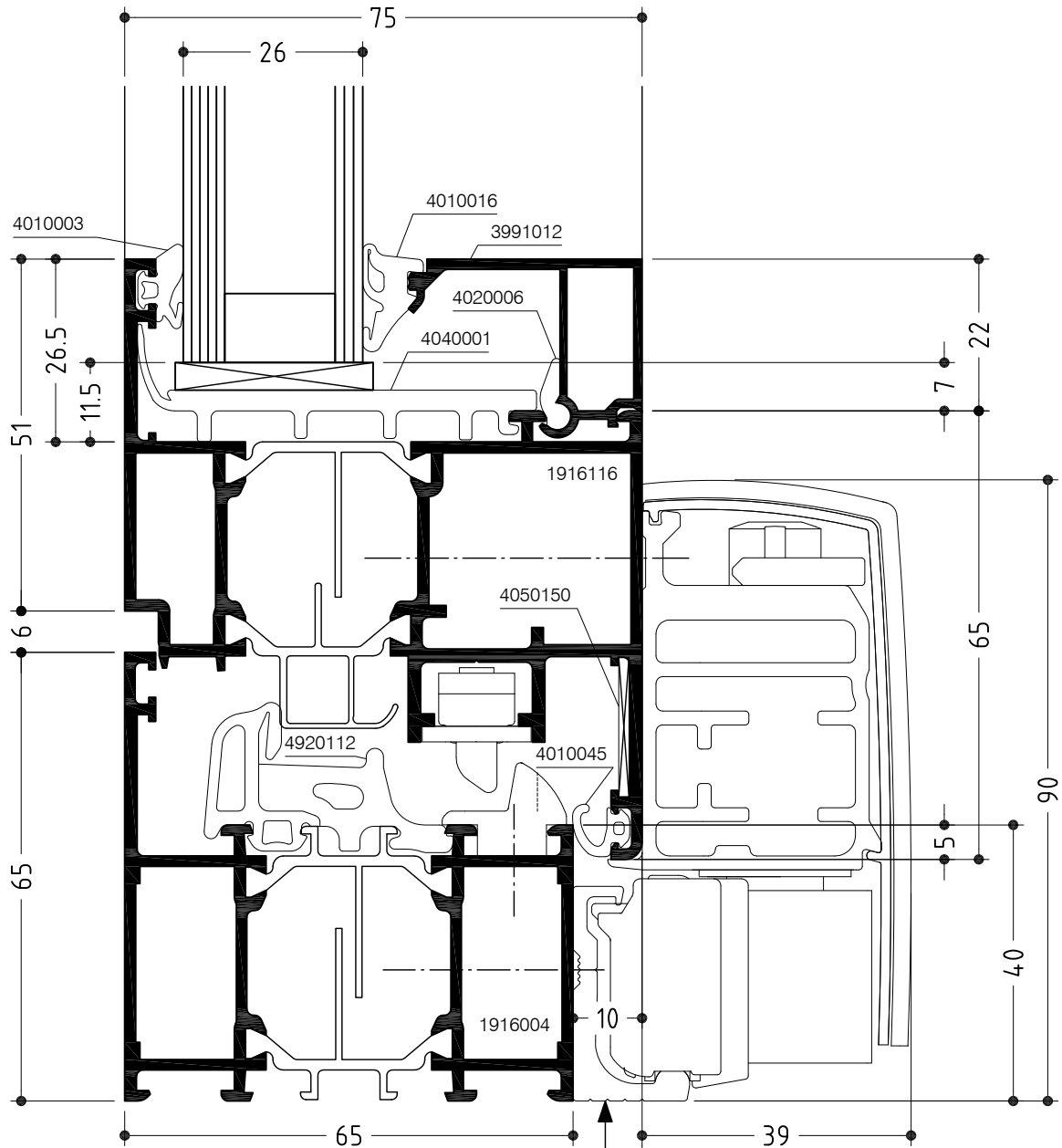
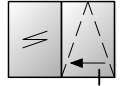

Abstellweite / Arresting distance  
107 mm

Für Laufschiene durchgehende Abstützung erforderlich!  
Continuous support necessary for slide rail!

# WICLINE 65

Konstruktionsschnitt

Construction section

Parallel-Schiebe-Kipp-Fenster (mit Zwangssteuerung)

Flügelgewicht max. 200 kg

Parallel sliding tilt window (with force operation)

Sash weight max. 200 kg

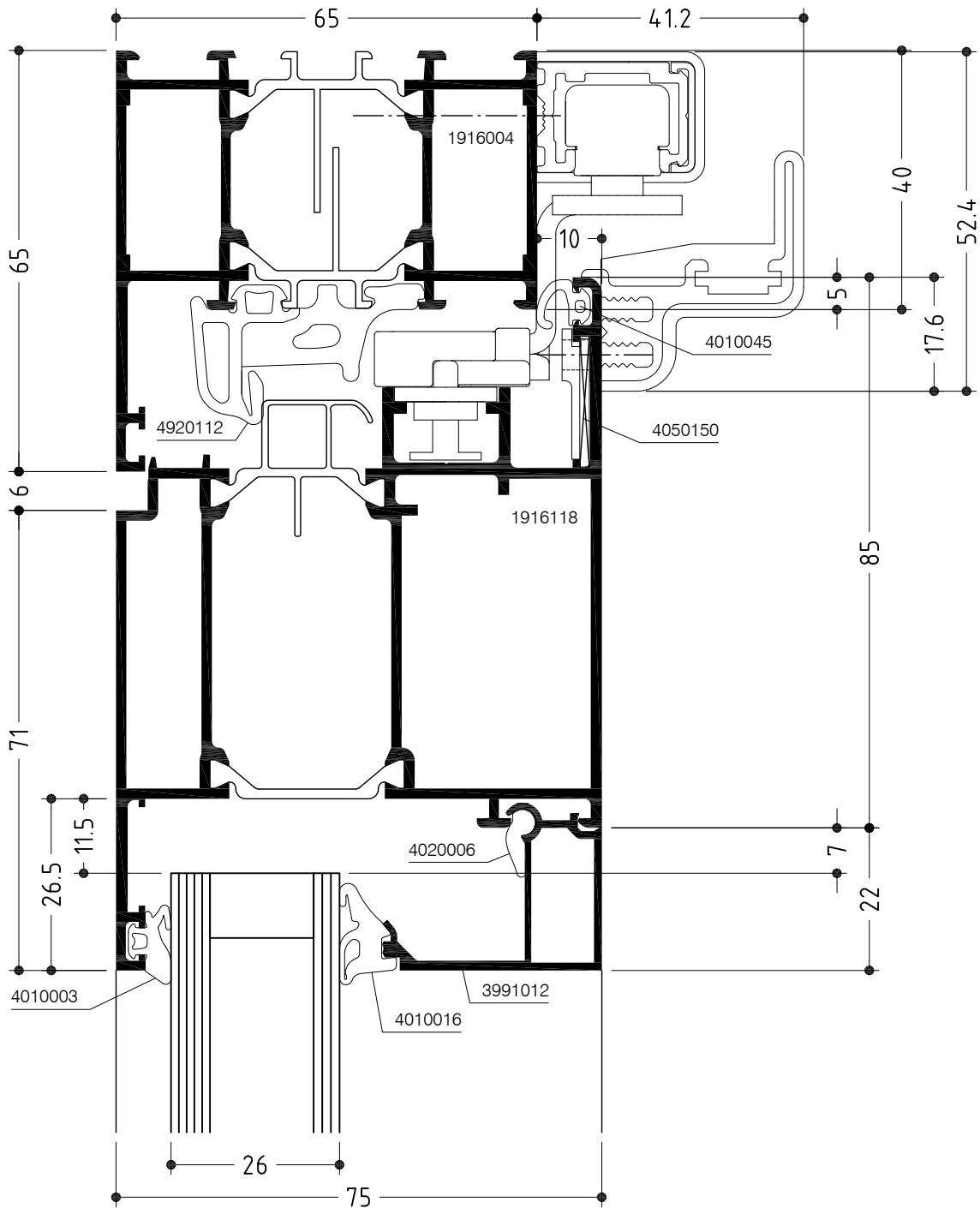
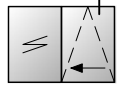

# WICLINE 65

Konstruktionsschnitt

Construction section

Parallel-Schiebe-Kipp-Fenster (mit Zwangssteuerung)

Flügelgewicht max. 200 kg

Parallel sliding tilt window (with force operation)

Sash weight max. 200 kg

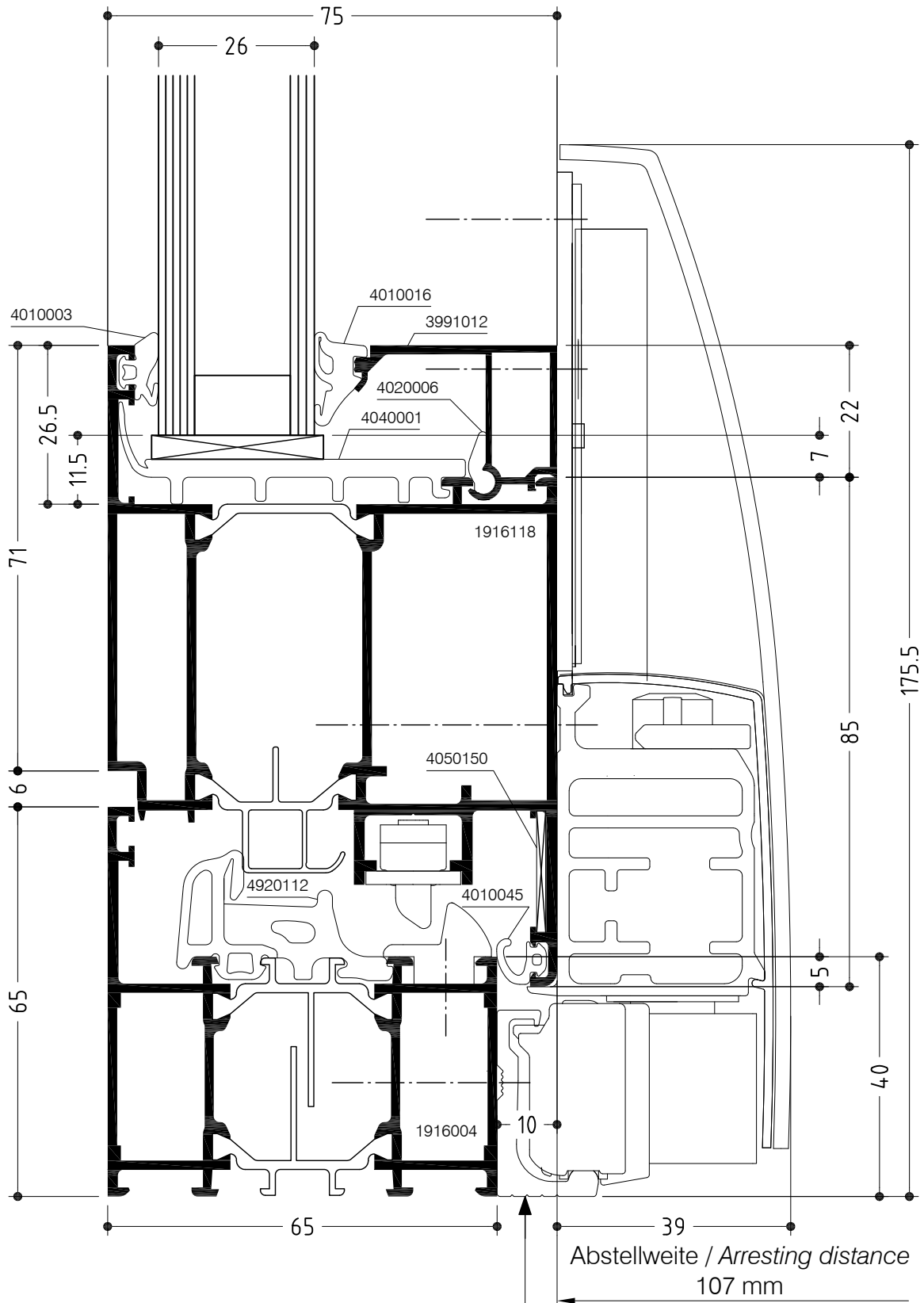
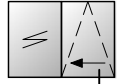

# WICLINE 65

## Konstruktionsschnitt

### Construction section

Parallel-Schiebe-Kipp-Fenster - Mittelstoß

(ohne und mit Zwangssteuerung)

Parallel sliding tilt window - Meeting stiles

(without and with force operation)

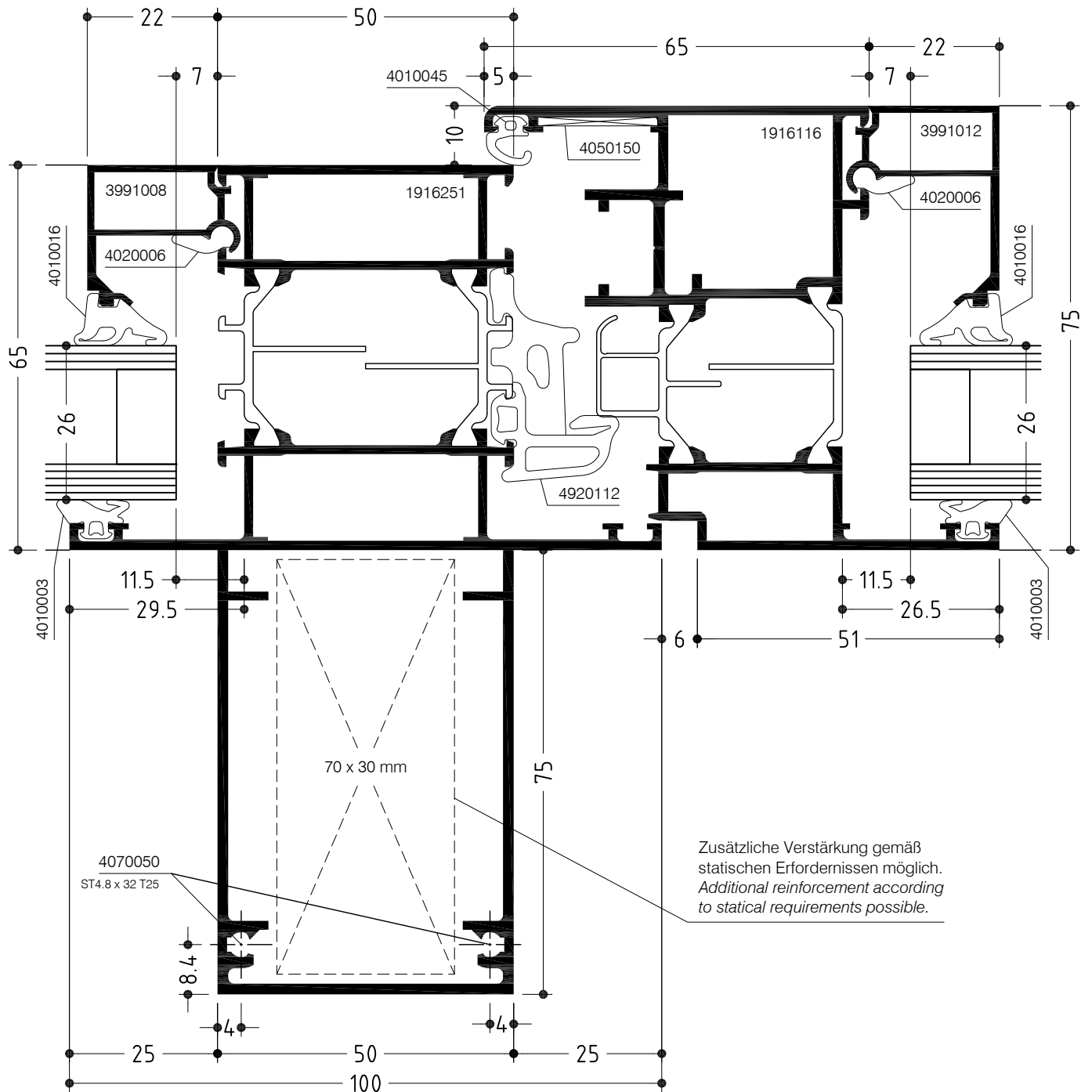
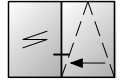



# WICLINE 65

Konstruktionsschnitt

Construction section

Flügelprofil im Blendrahmen mit Kämpfer

EH-Verriegelung / Füllungssicherung

Sash profile in frame with transom

Burglar resistant locking / Infill safeguard

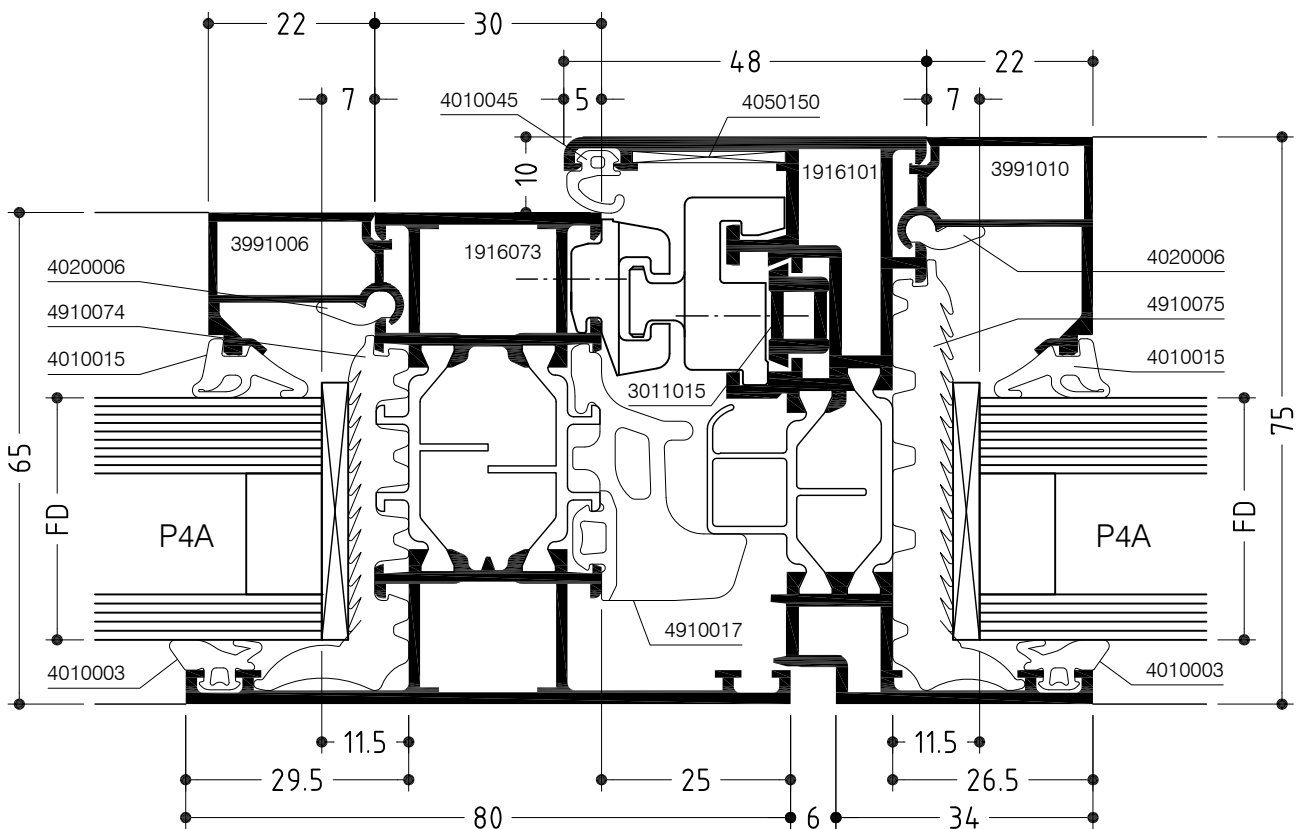
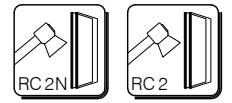
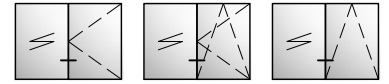

# WICLINE 65

## Konstruktionsschnitt

### Construction section

Flügelprofil im Blendrahmen mit Kämpfer

EH-Verriegelung / Füllungssicherung

Sash profile in frame with transom

Burglar resistant locking / Infill safeguard

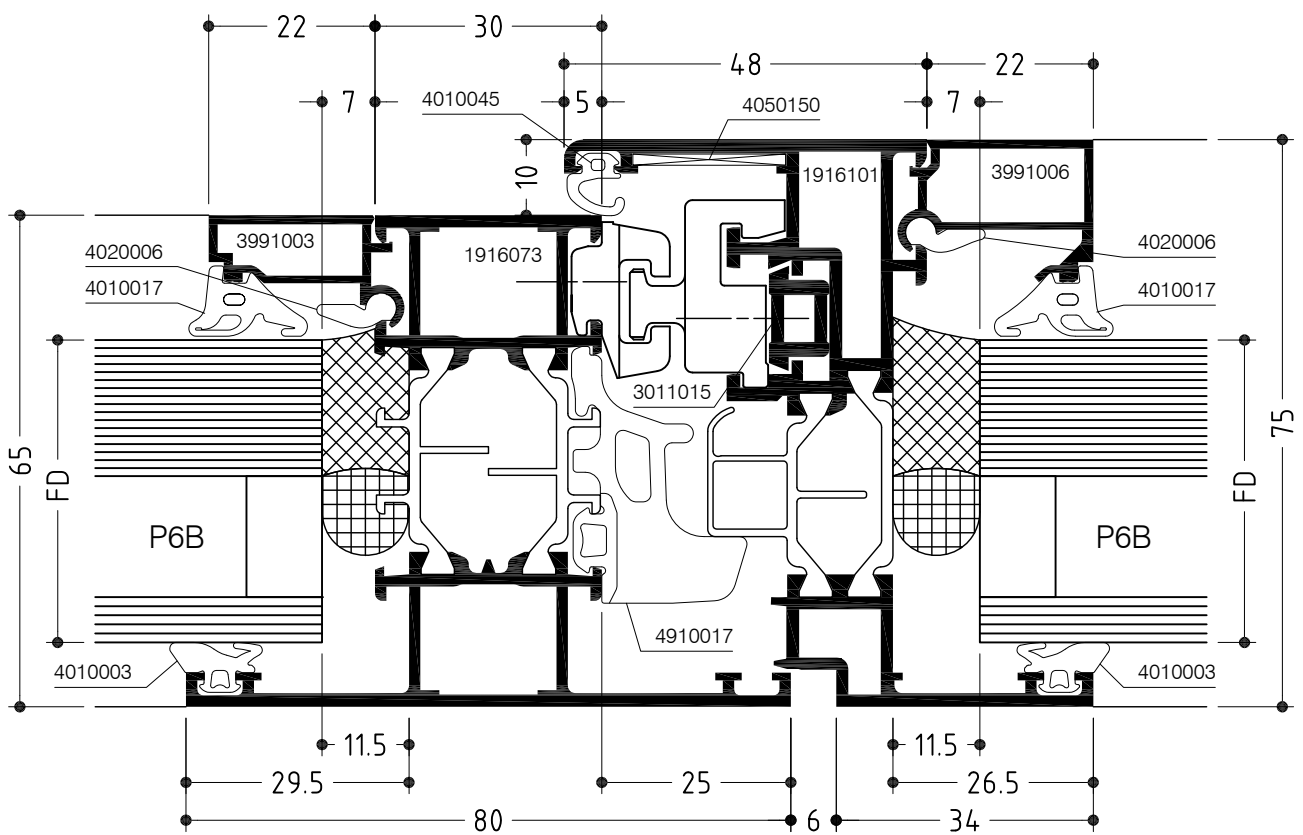
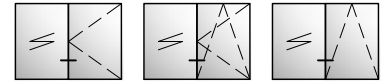

# WICLINE 65

## Konstruktionsschnitt

### Construction section

Stulpfenster mit Aufsatzprofil - Mittelstoß

EH-Verriegelung / Füllungssicherung

Double casement window with supplm. profile - Meeting stiles

Burglar resistant locking / Infill safeguard

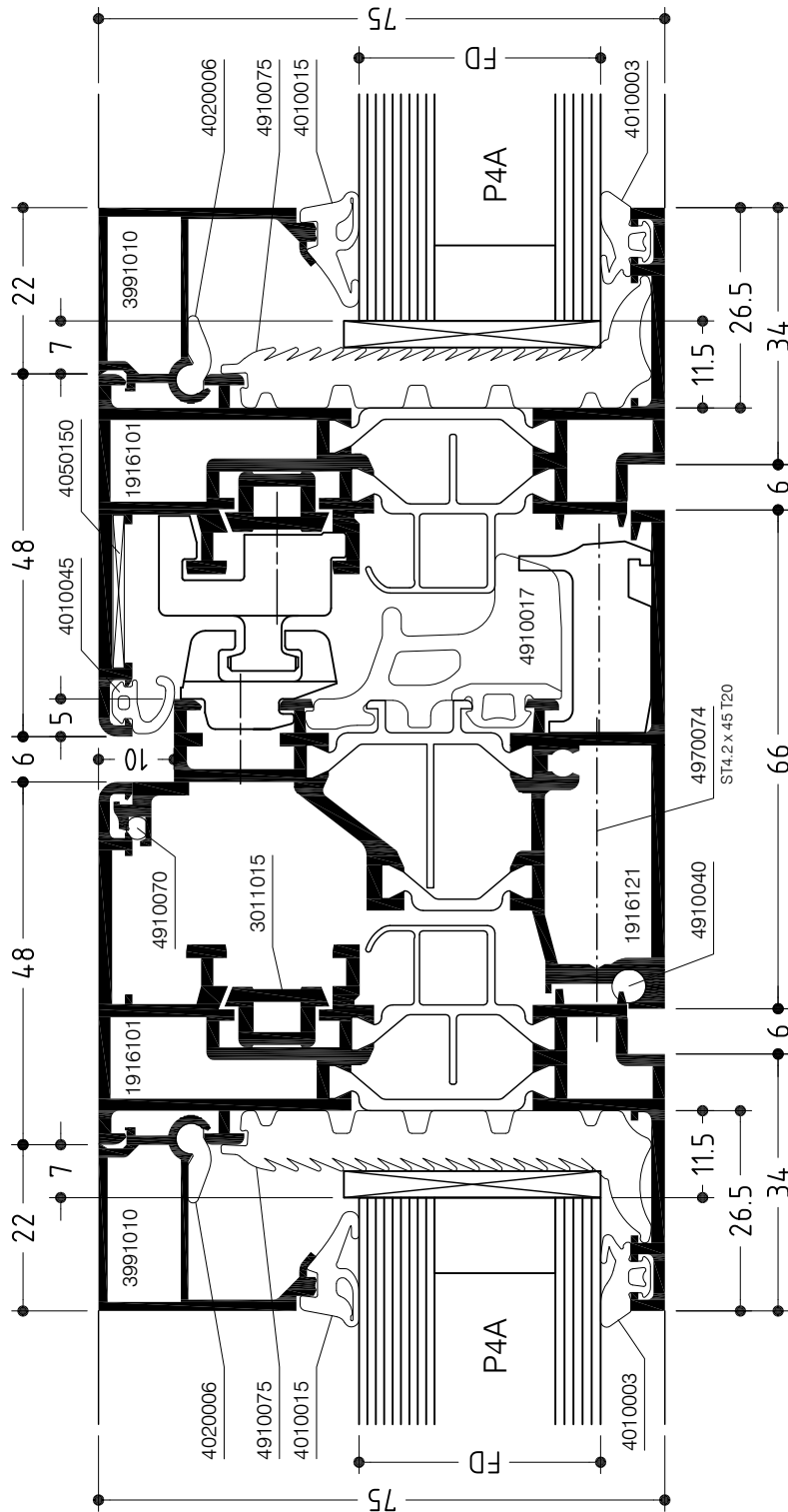
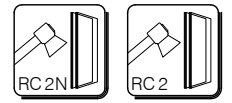
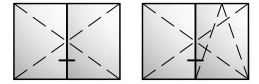

# WICLINE 65

## Konstruktionsschnitt

### Construction section

Stulpfenster mit Aufsatzprofil - Mittelstoß

EH-Verriegelung / Füllungssicherung

Double casement window with supplm. profile - Meeting stiles

Burglar resistant locking / Infill safeguard

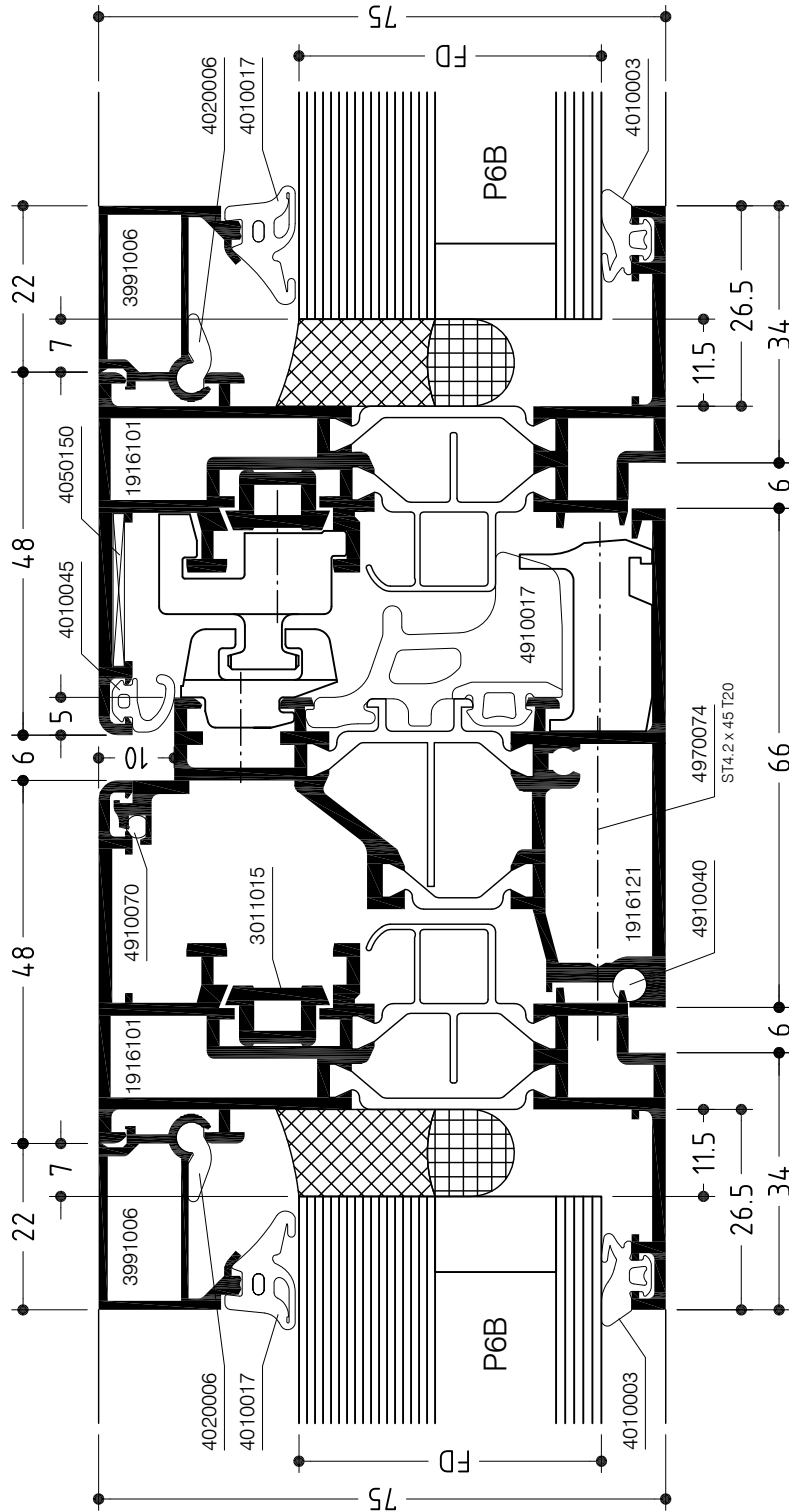
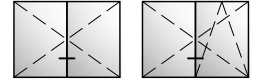

# WICLINE 65

## Konstruktionsschnitt

### Construction section

Flügelprofil im Blendrahmen mit Kämpfer, Klassik-Design

EH-Verriegelung / Füllungssicherung

Sash profile in frame with transom, Classic design

Burglar resistant locking / Infill safeguard

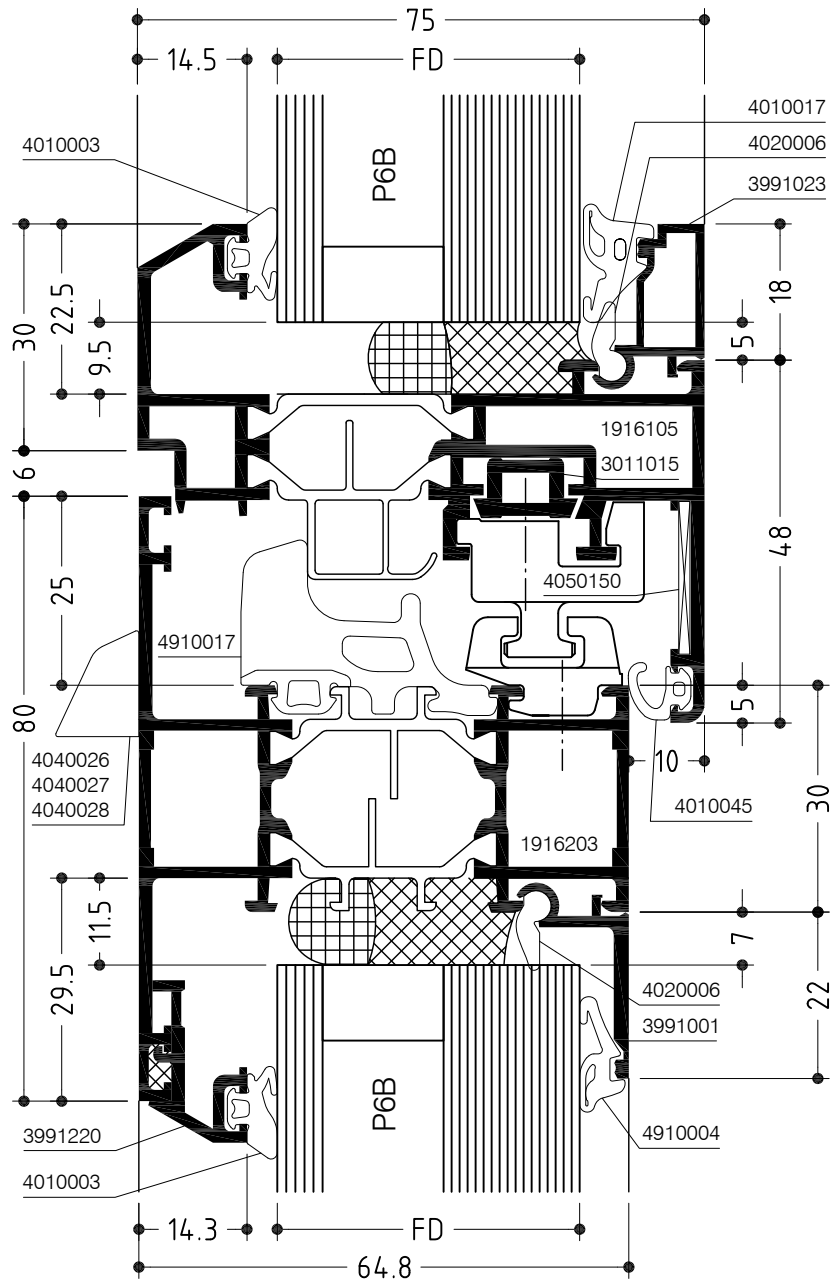
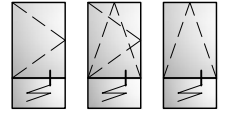

# WICLINE 65

Konstruktionsschnitt

Construction section

Flügelprofil im Blendrahmen mit Kämpfer, verdeckter Flügel

EH-Verriegelung / Füllungssicherung

Concealed sash in frame with transom

Burglar resistant locking / Infill safeguard

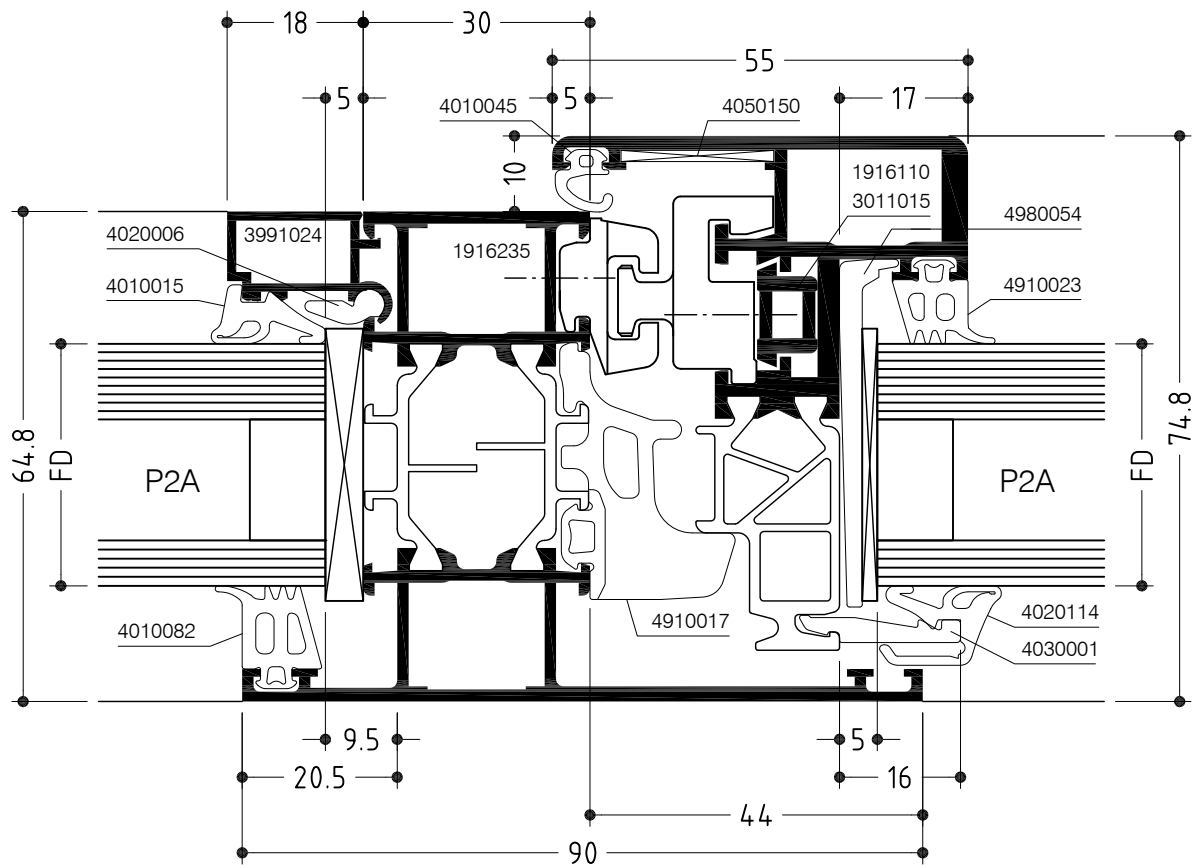
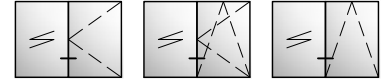

# WICLINE 65

## Konstruktionsschnitt

### Construction section

Flügelprofil im Blendrahmen mit Kämpfer, verdeckter Flügel

EH-Verriegelung / Füllungssicherung

Concealed sash in frame with transom

Burglar resistant locking / Infill safeguard

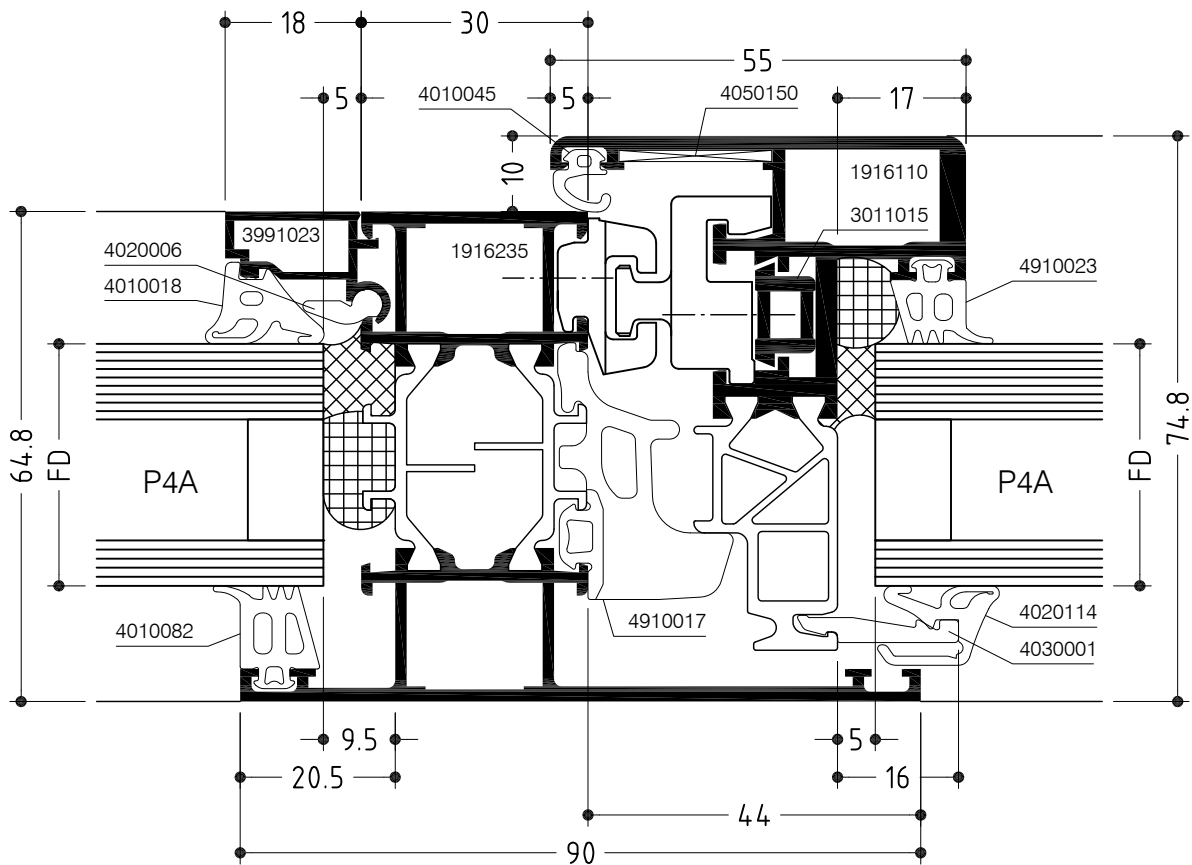
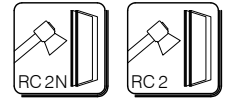
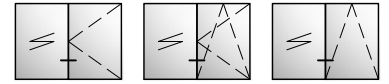

# WICLINE 65

Konstruktionsschnitt

Construction section

Flügelprofil im Blendrahmen mit Kämpfer, verdeckter Flügel

EH-Verriegelung / Füllungssicherung

Concealed sash in frame with transom

Burglar resistant locking / Infill safeguard

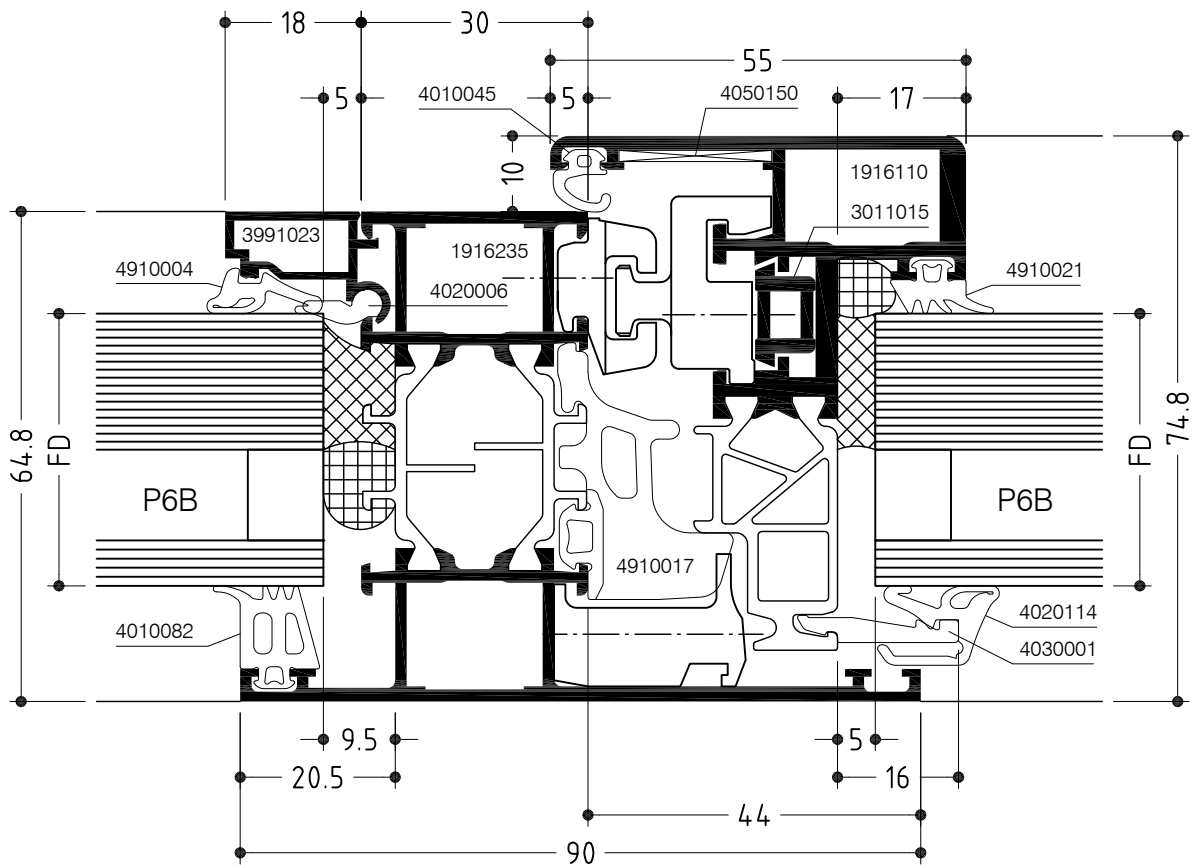
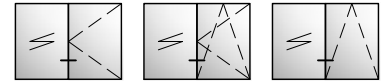



# WICLINE 65

Blendrahmen  
Festverglasung  
Frame profile  
Fixed glazing

Konstruktionsschnitt  
Construction section

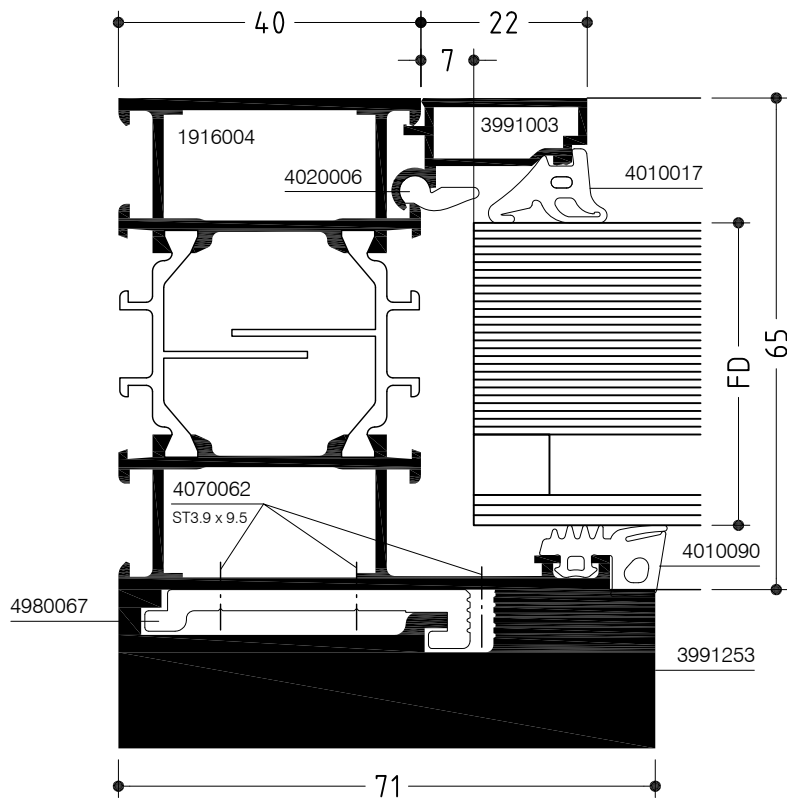

# WICLINE 65

Konstruktionsschnitt  
Construction section

Elementkopplung  
Festverglasung  
Unit coupling  
Fixed glazing

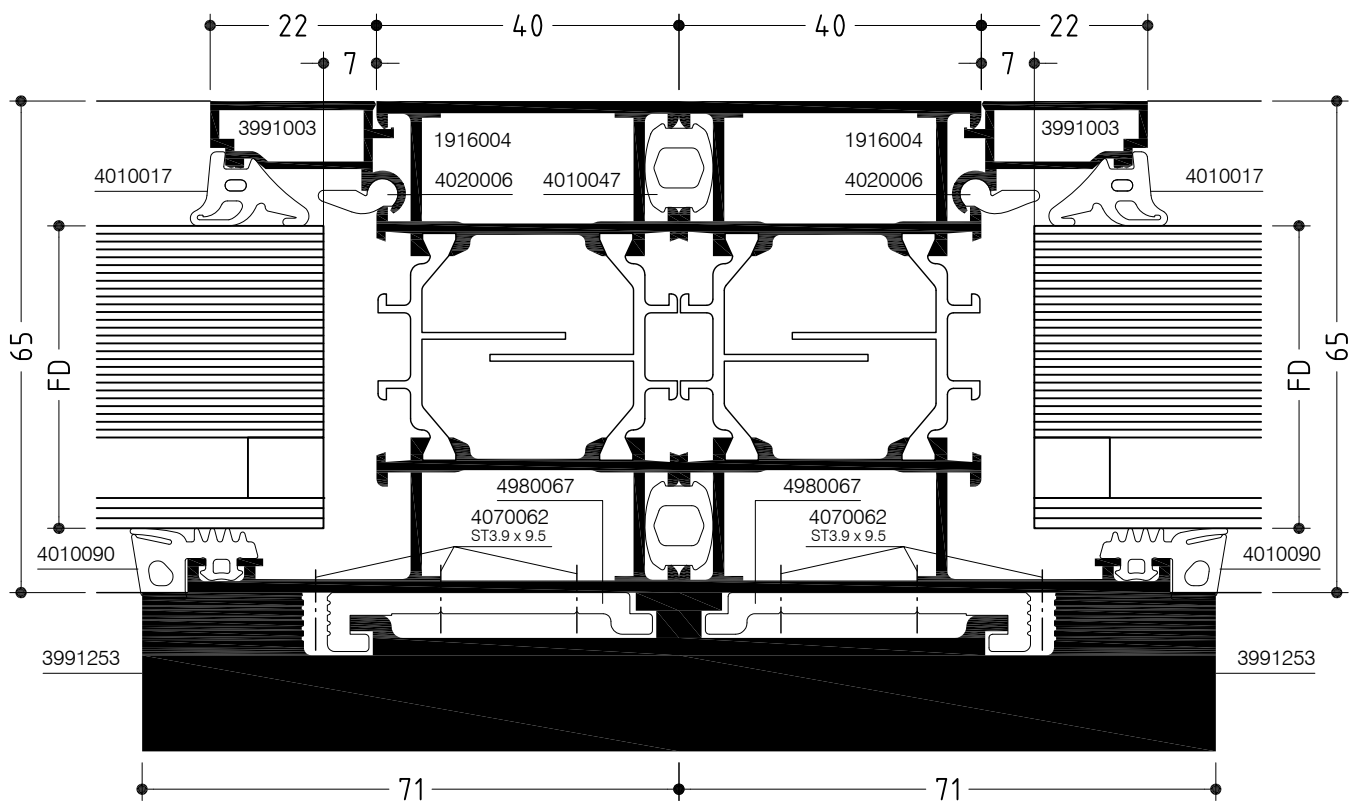
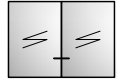

# WICLINE 65

## Konstruktionsschnitt Construction section

Blendrahmen  
Fensterflügel  
Frame  
Window sash

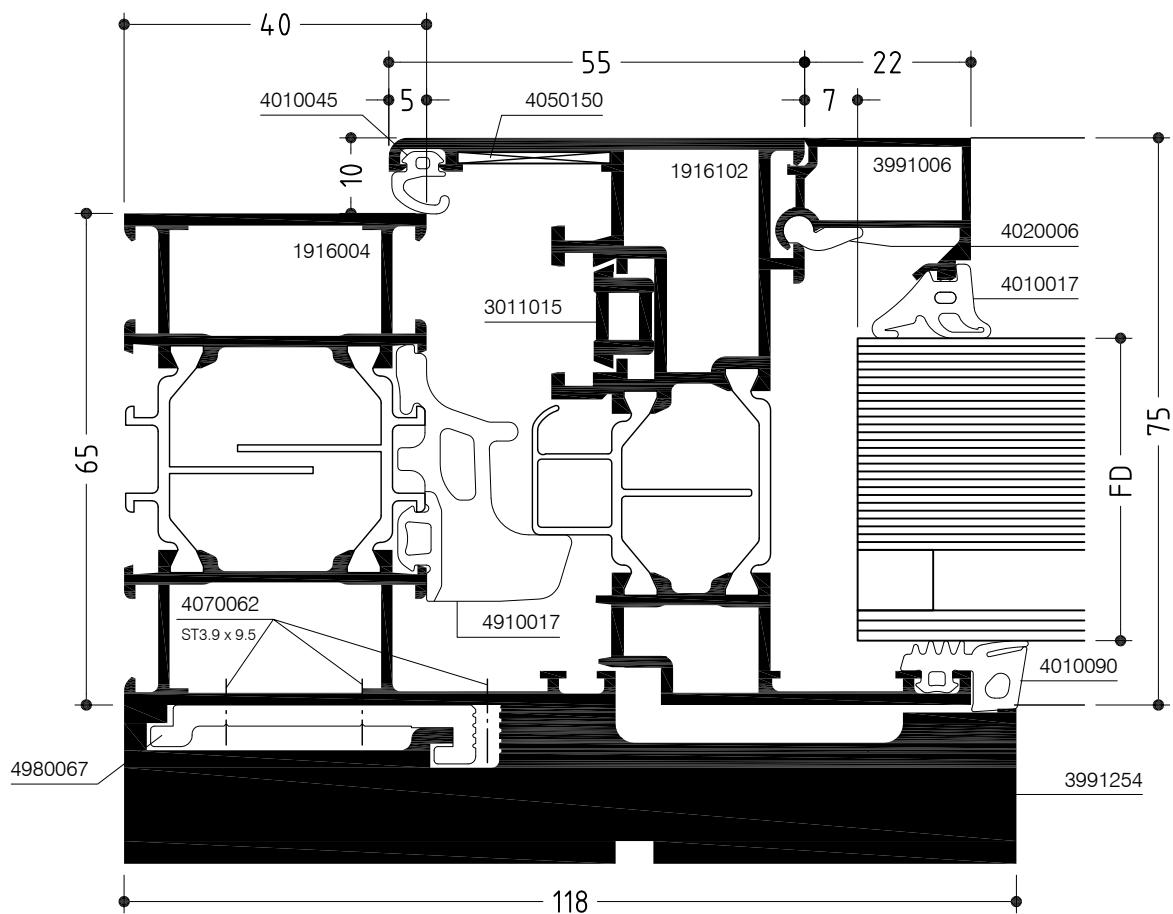

# WICLINE 65

Elementkopplung  
Fensterflügel / Festverglasung  
Unit coupling  
Window sash / Fixed glazing

Konstruktionsschnitt  
Construction section

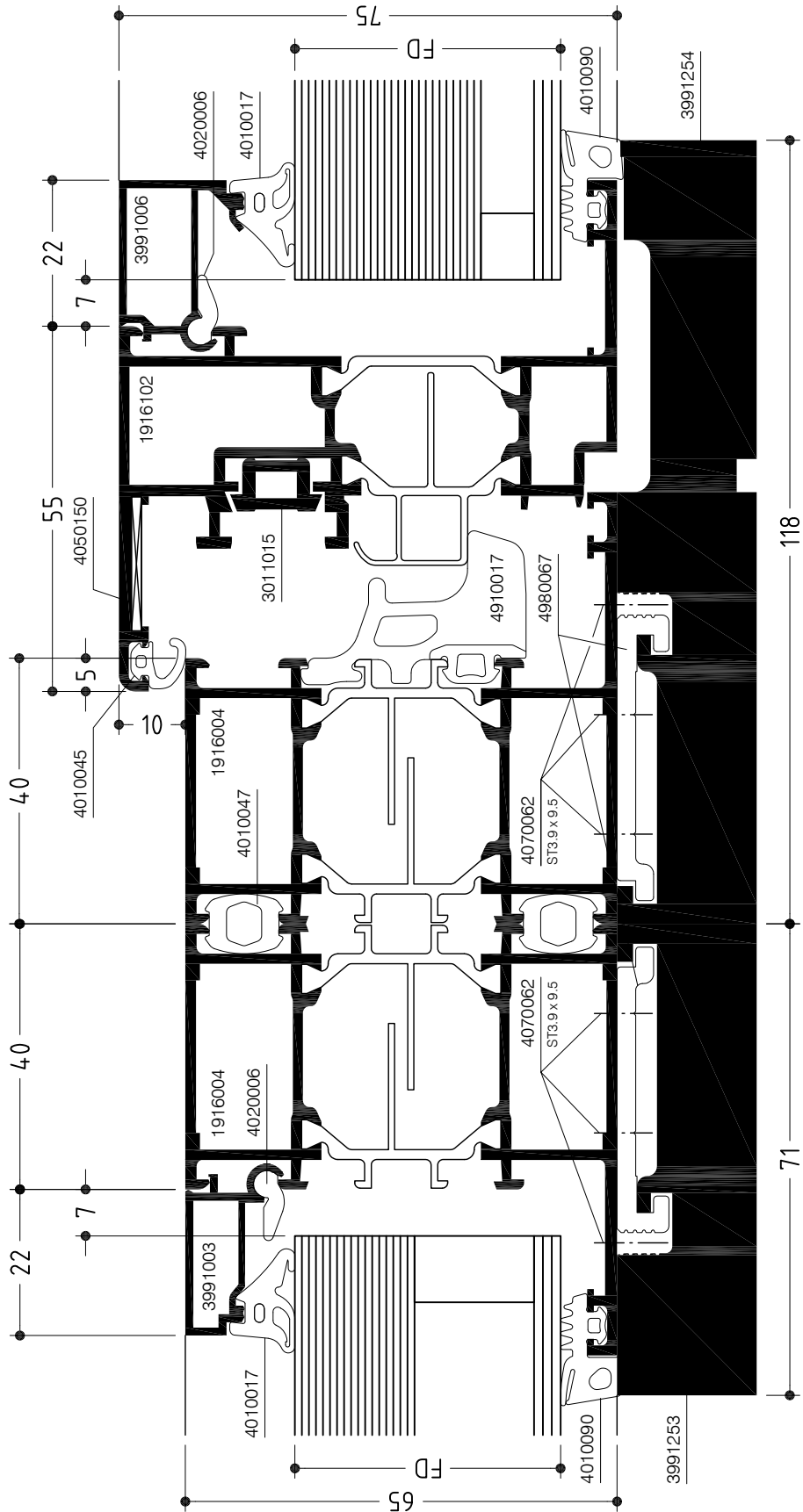
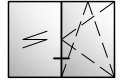

# WICLINE 65

Elementkopplung  
Fensterflügel  
Unit coupling  
Window sash

Konstruktionsschnitt  
Construction section

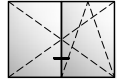
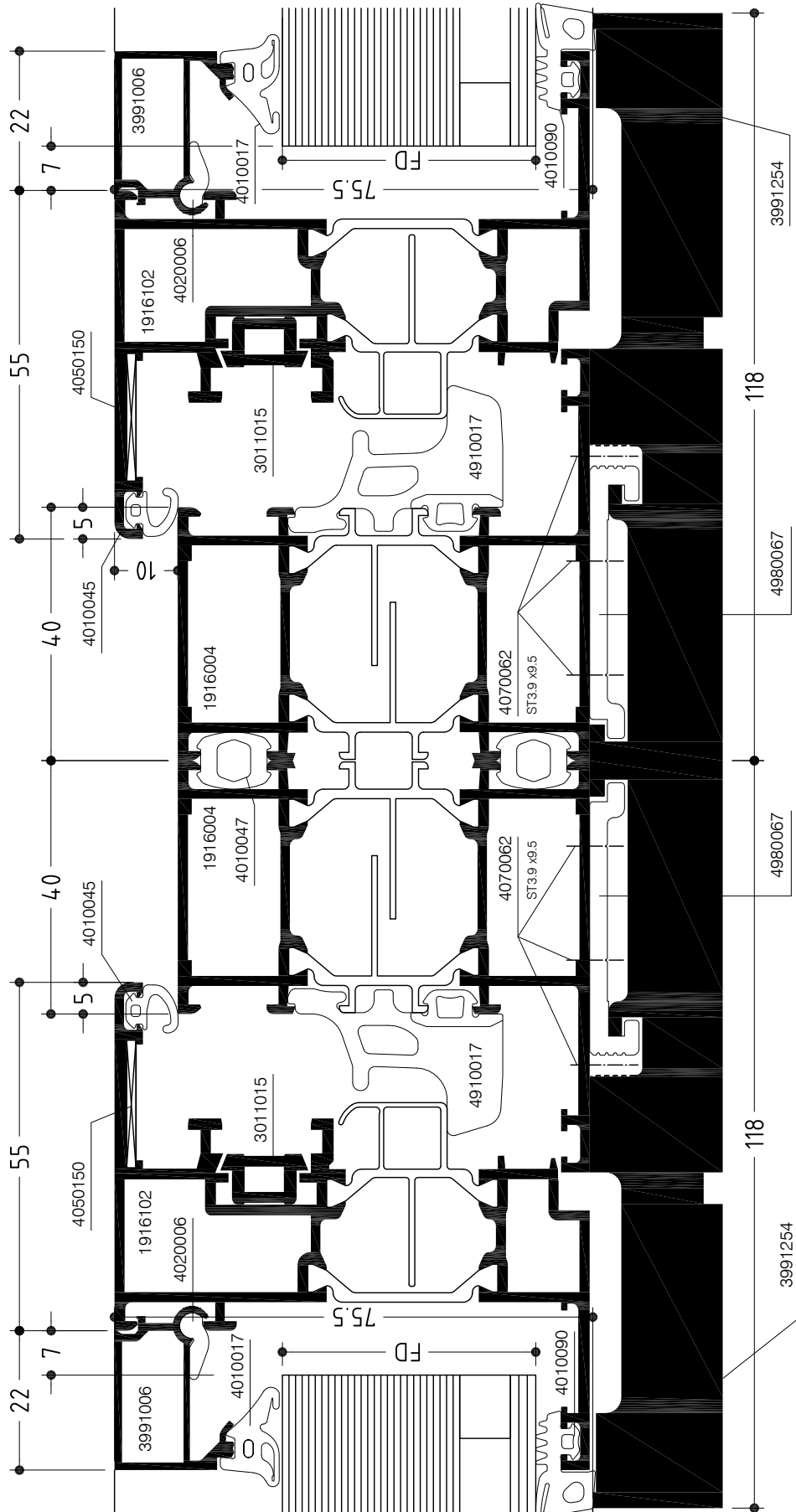

# WICLINE 65

Kämpferprofil  
Festverglasung  
Transom profile  
Fixed glazing

Konstruktionsschnitt  
Construction section

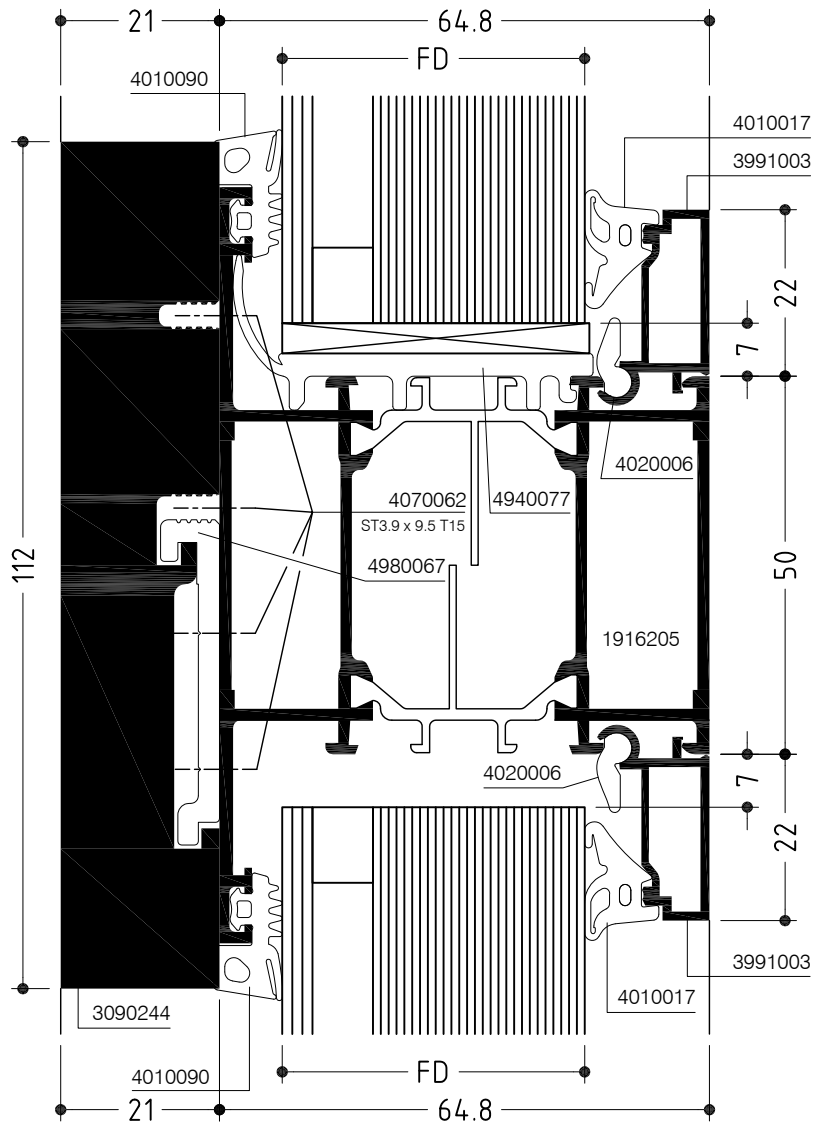

# WICLINE 65

Kämpferprofil  
Festverglasung  
Transom profile  
Fixed glazing

Konstruktionsschnitt  
Construction section

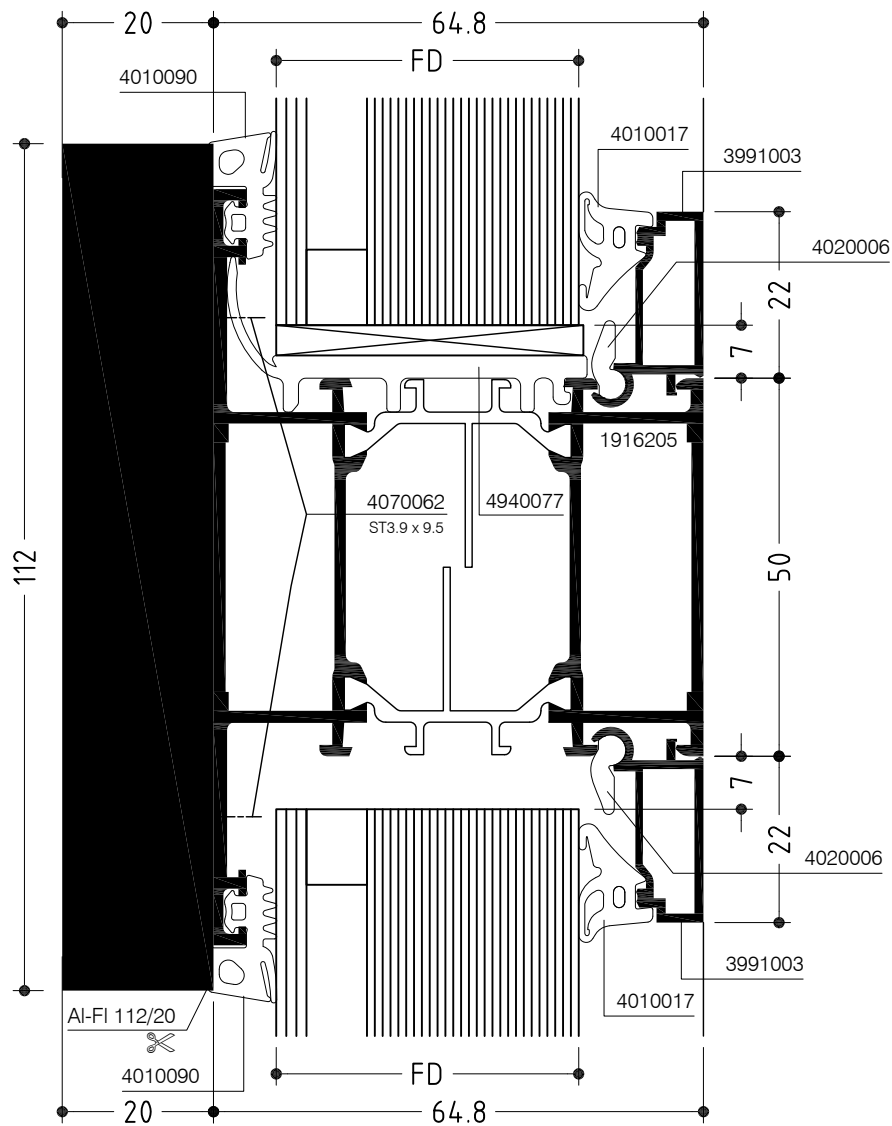





# WICLINE 65

## Konstruktionsschnitt

### Construction section

Zusatzprofil 3091036, 3991215, 3991216 und 3991217

Additional profile 3091036, 3991215, 3991216 and 3991217

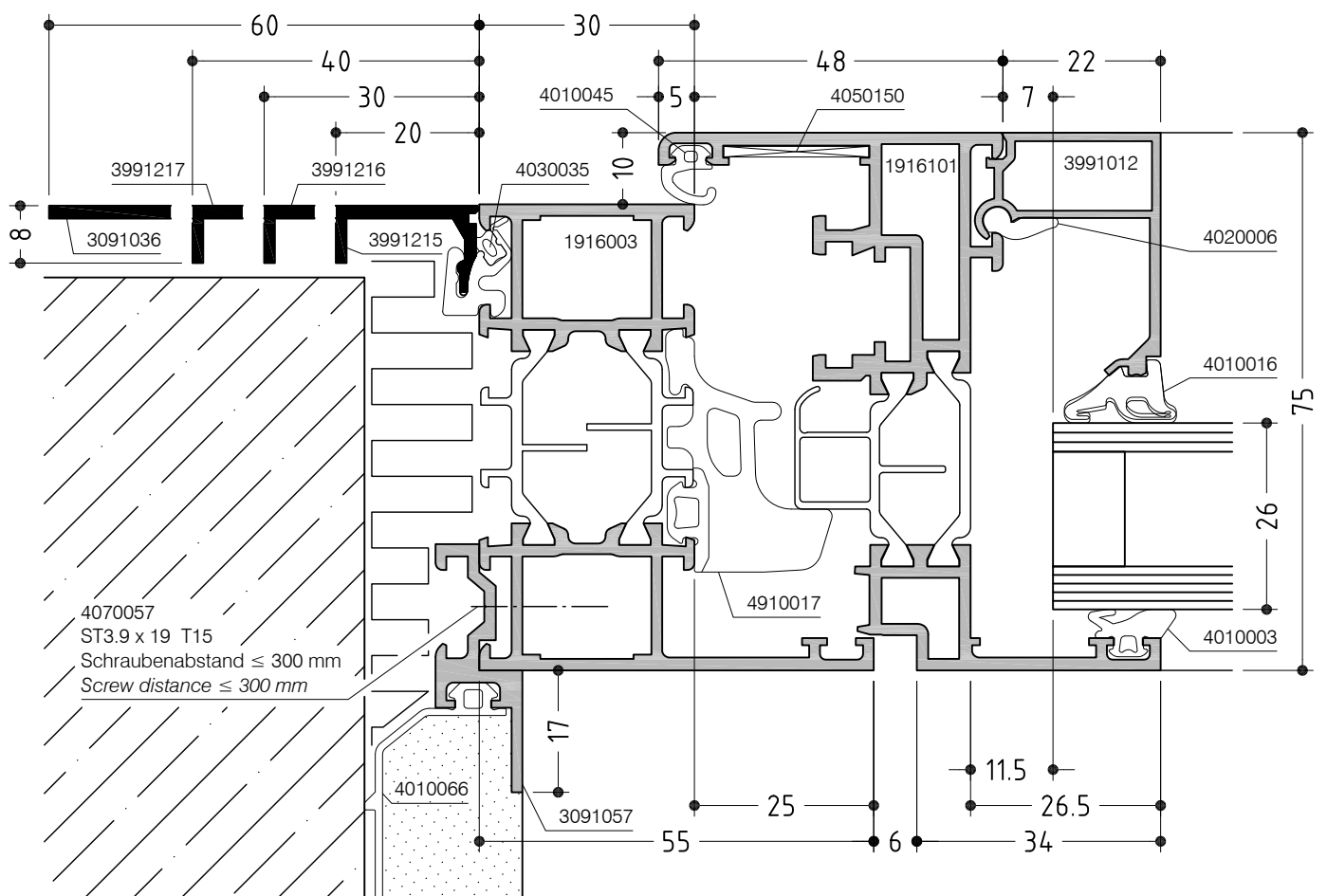

# WICLINE 65

Zusatzprofil 3091031 und 3991234  
Additional profile 3091031 and 3991234

Konstruktionsschnitt  
Construction section

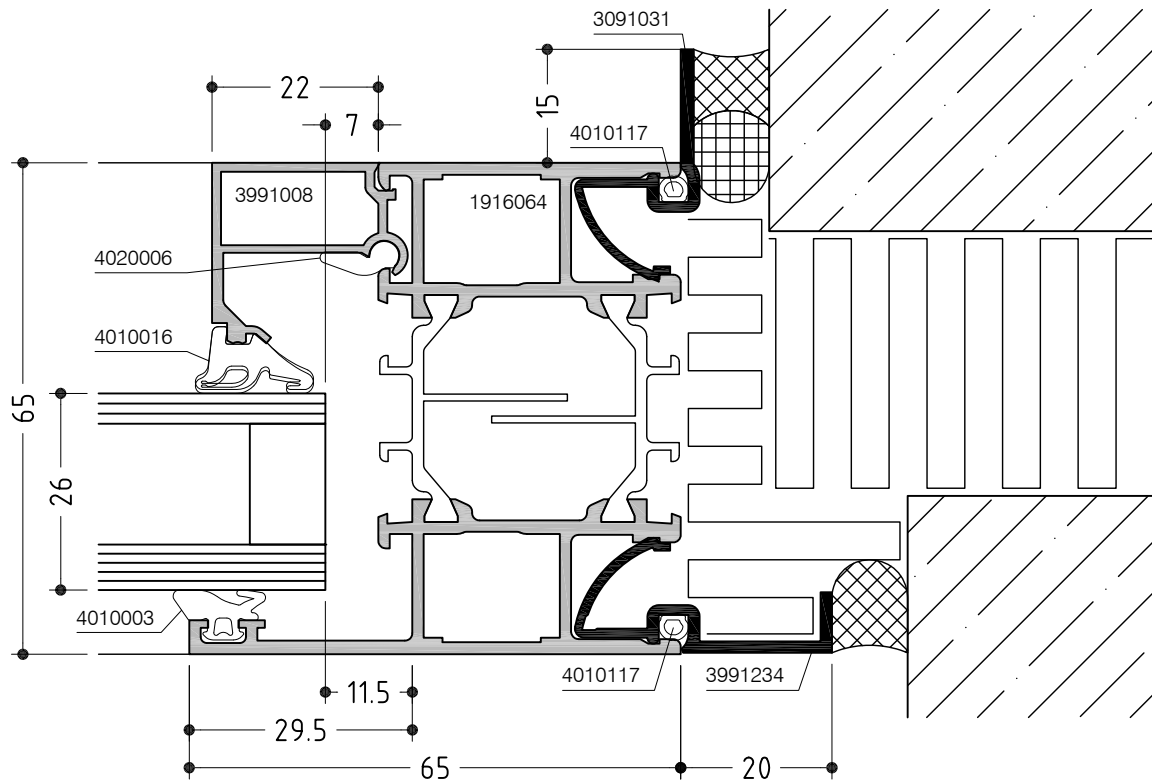

# WICLINE 65

Zusatzprofil 160747 und 3091057  
Additional profile 160747 and 3091057

Konstruktionsschnitt  
Construction section

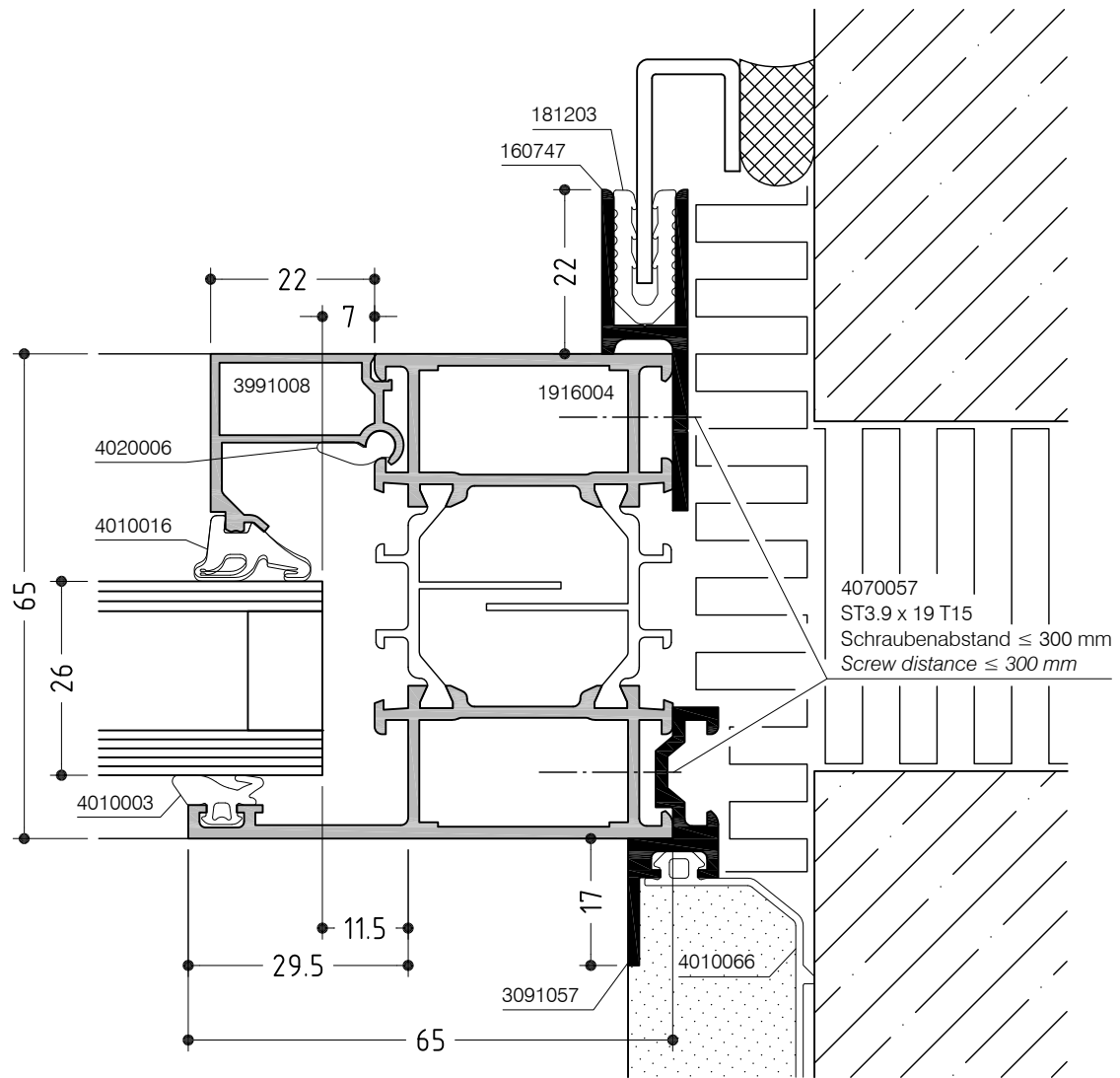

# WICLINE 65

Zusatzprofil 3091055 und 3091057  
Additional profile 3091055 and 3091057

Konstruktionsschnitt  
Construction section

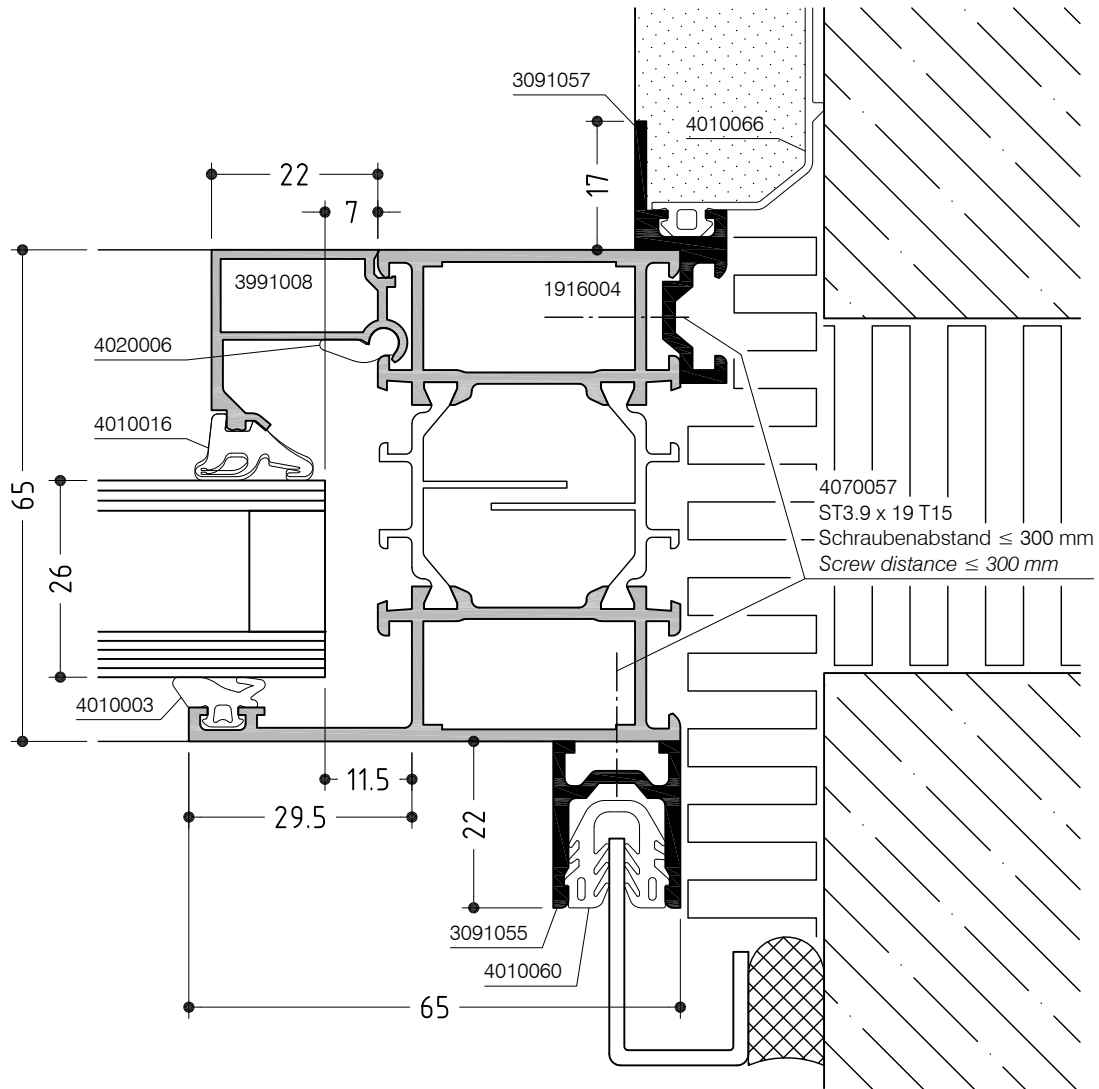

# WICLINE 65

Zusatzprofil 3091037 und 3991280  
 Additional profile 3091037 and 3991280

Konstruktionsschnitt  
 Construction section

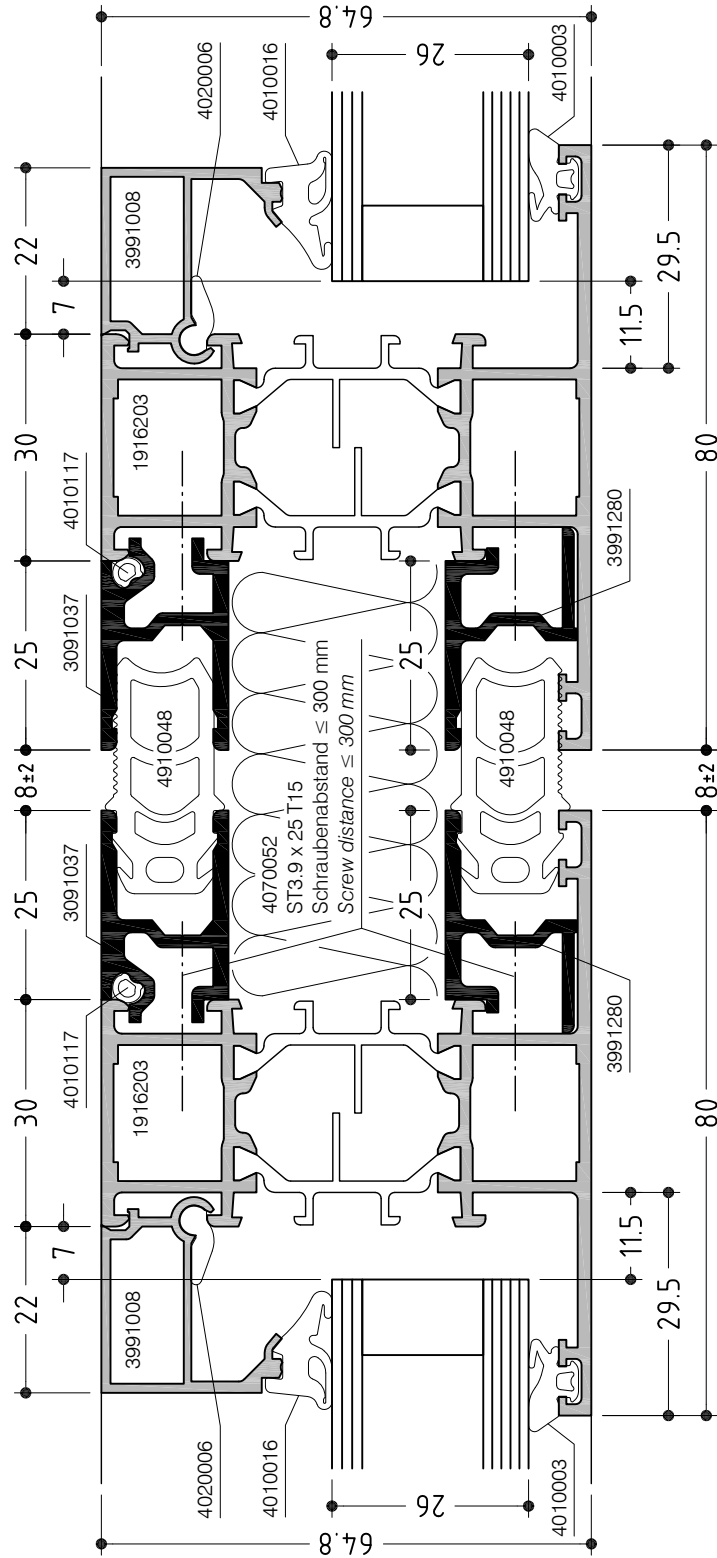
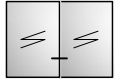

# WICLINE 65

Zusatzprofil 3091056  
Additional profile 3091056

Konstruktionsschnitt  
Construction section

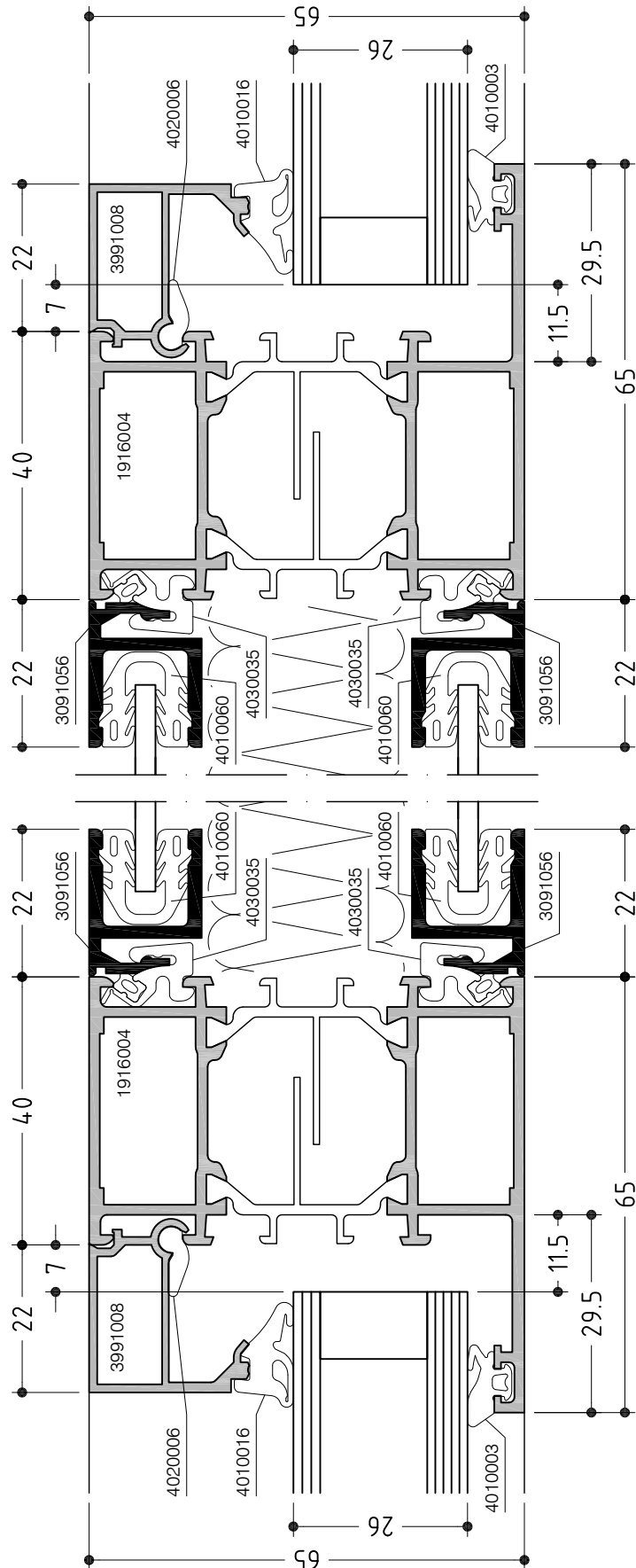
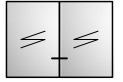

# WICLINE 65

Zusatzprofil 3991237  
Additional profile 3991237

Konstruktionsschnitt  
Construction section

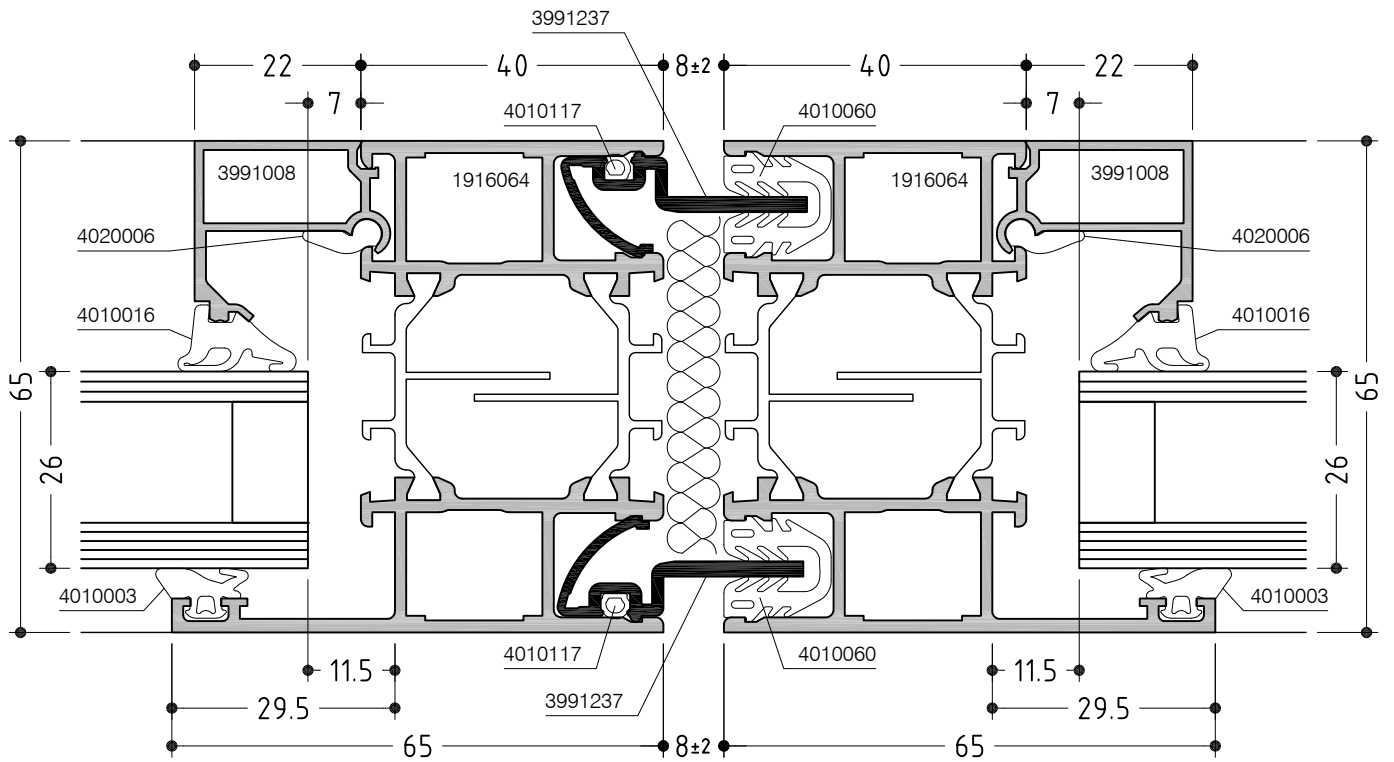
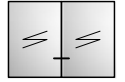

# WICLINE 65

## Konstruktionsschnitt Construction section

Zusatzprofil 3091044 und 3091054

Verstärkungsprofile Fenstertüren

Additional profiles 3091044 and 3091054

Reinforcement profile Window-doors (French windows)

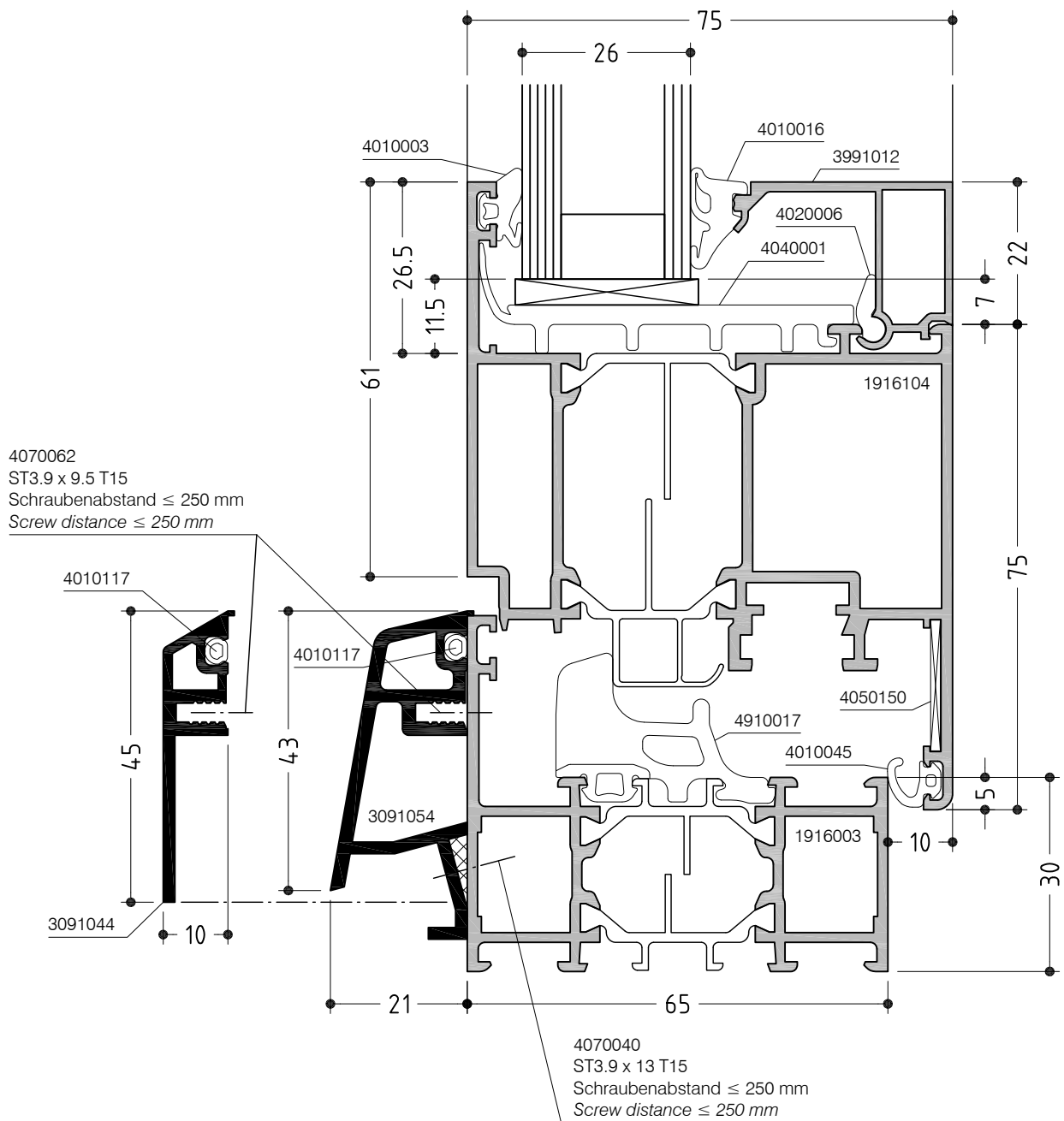



# WICLINE 65

Zusatzprofil 3091045  
Additional profile 3091045

Konstruktionsschnitt  
Construction section

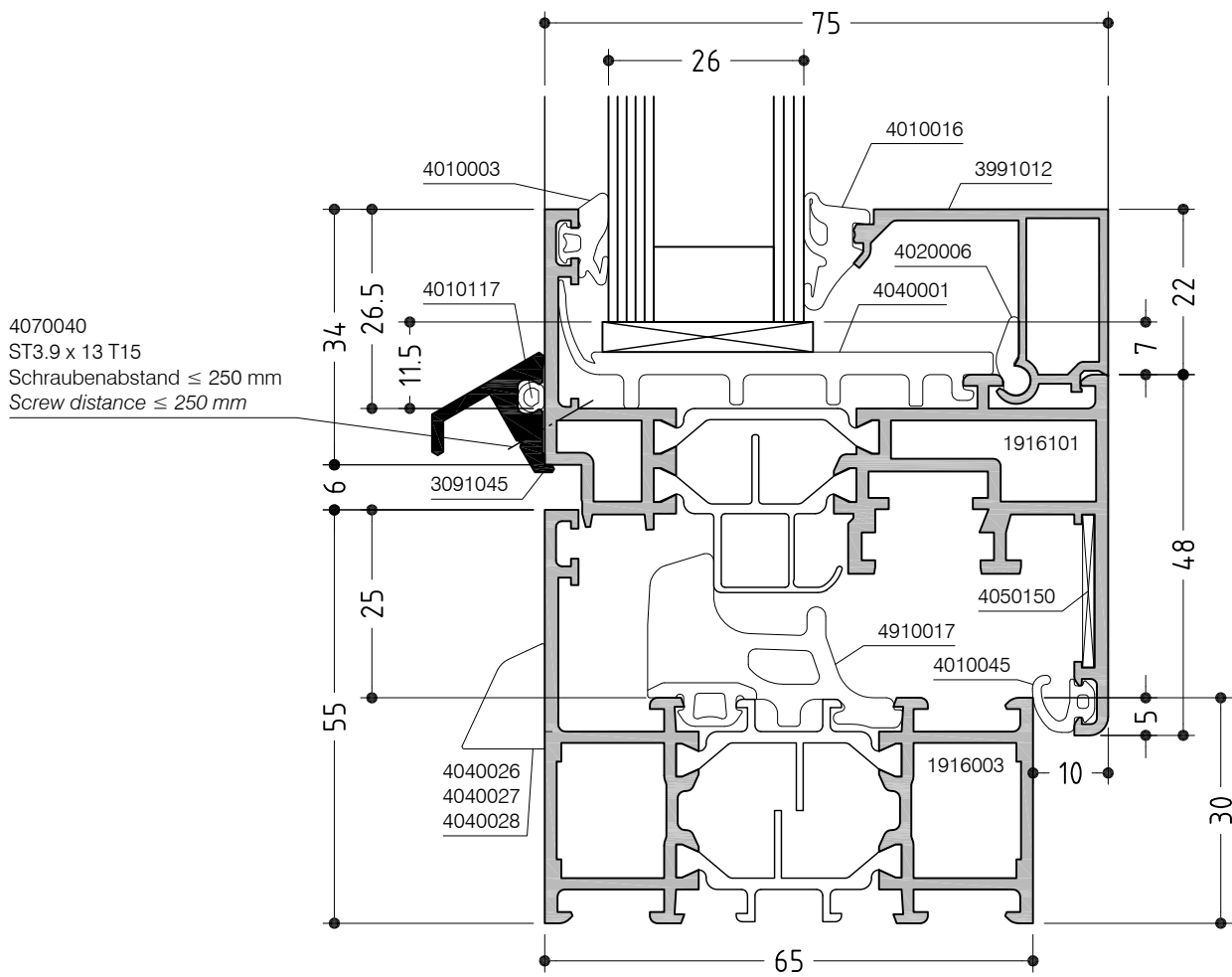

# WICLINE 65

Zusatzprofil 3091039 und 3091040  
Additional profile 3091039 and 3091040

Konstruktionsschnitt  
Construction section

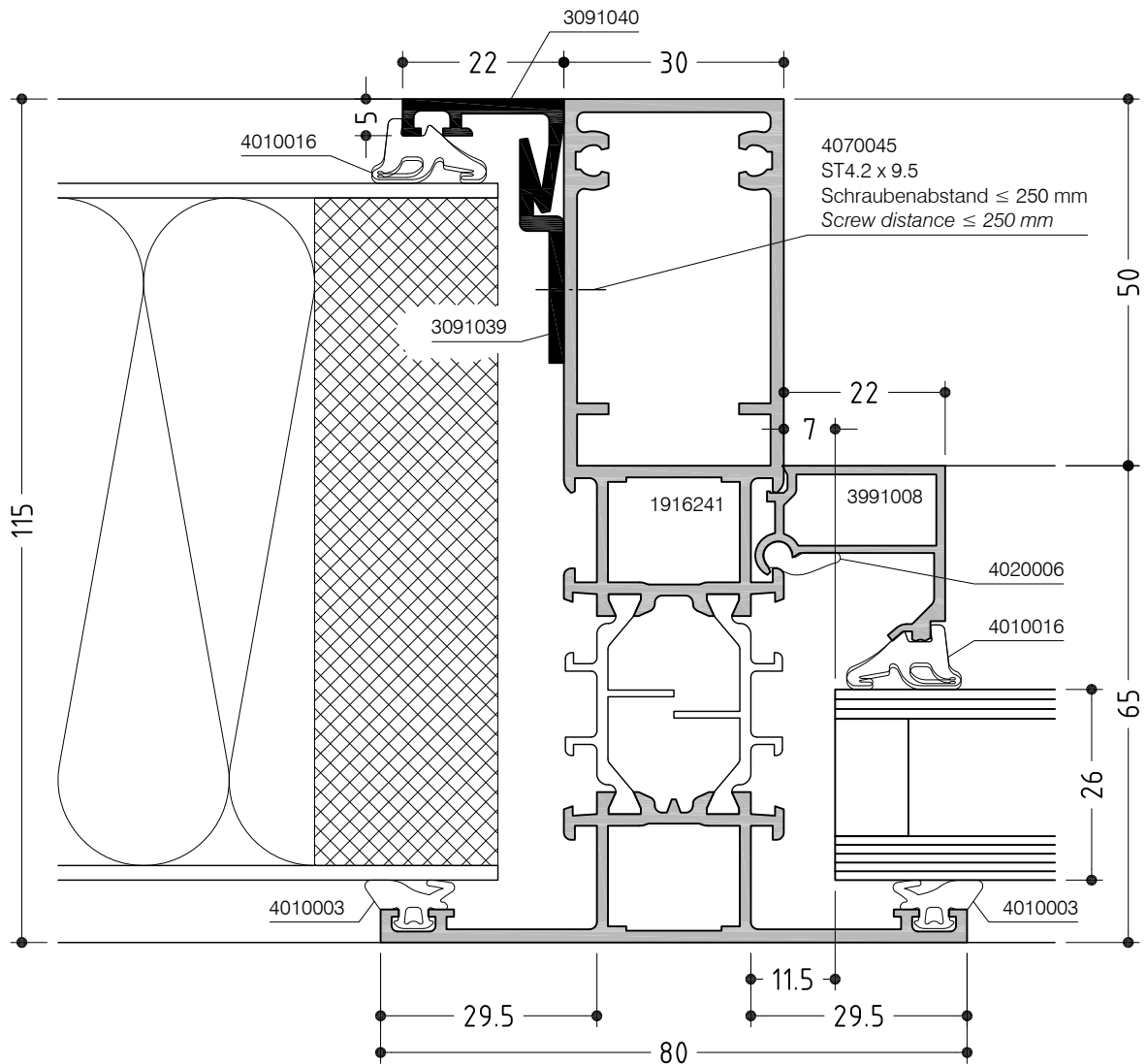
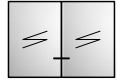

# WICLINE 65

Zusatzprofil 3091049 und 3091050  
Additional profile 3091049 and 3091050

Konstruktionsschnitt  
Construction section

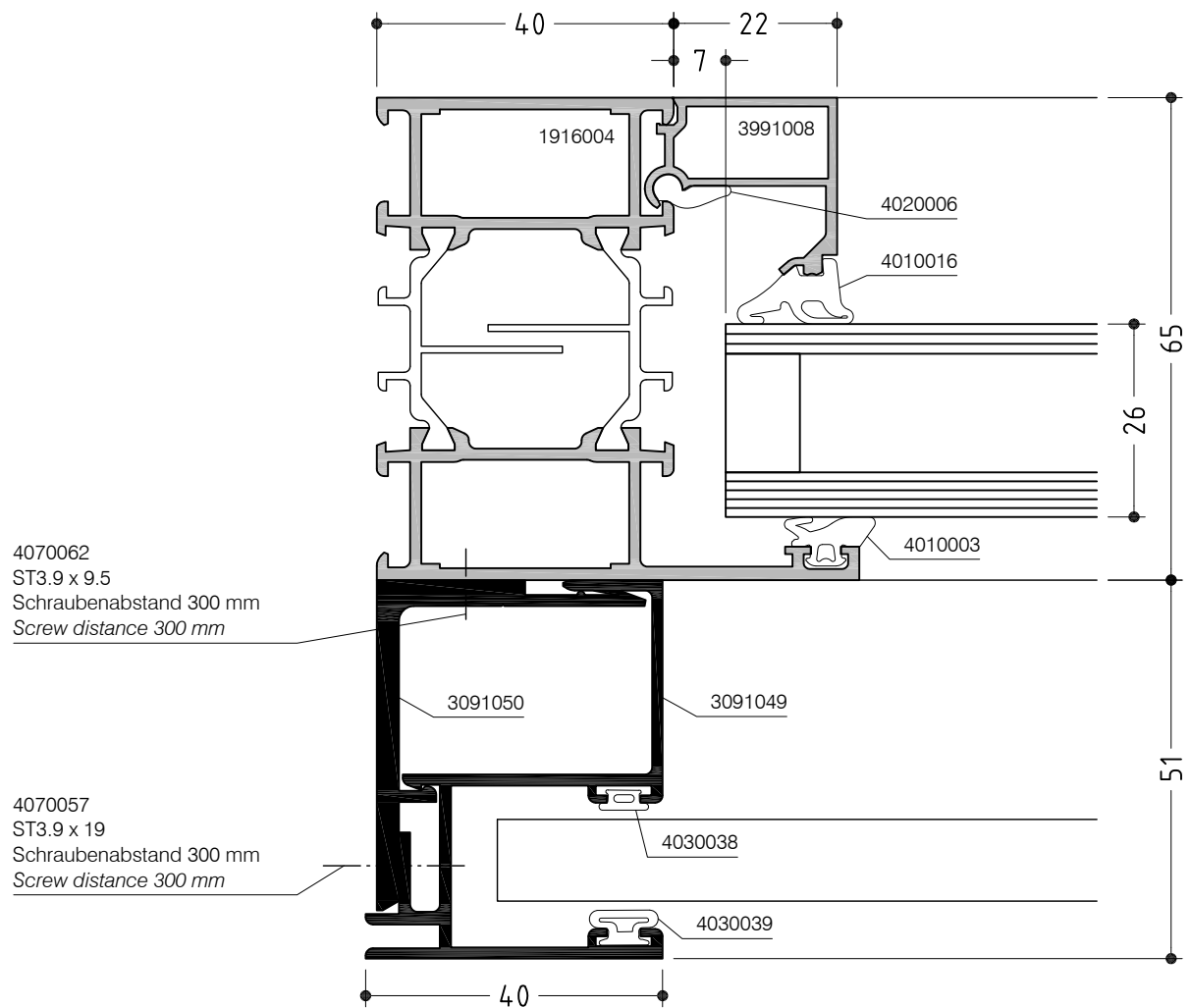

# WICLINE 65

Zusatzprofil 3091048 und 3091051  
Additional profile 3091048 and 3091051

Konstruktionsschnitt  
Construction section

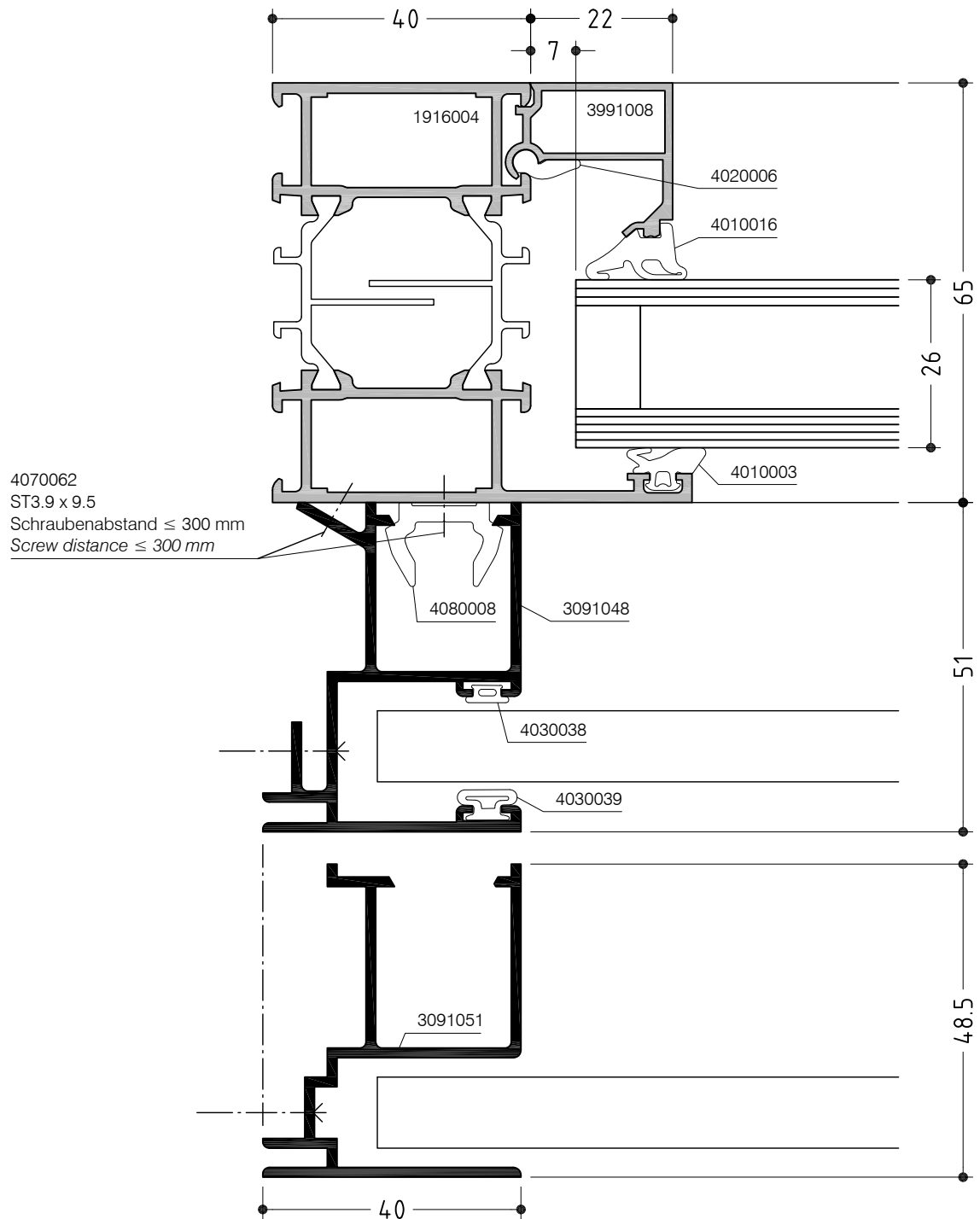

# WICLINE 65

Zusatzprofil 3091046 und 3091047  
Additional profile 3091046 and 3091047

Konstruktionsschnitt  
Construction section

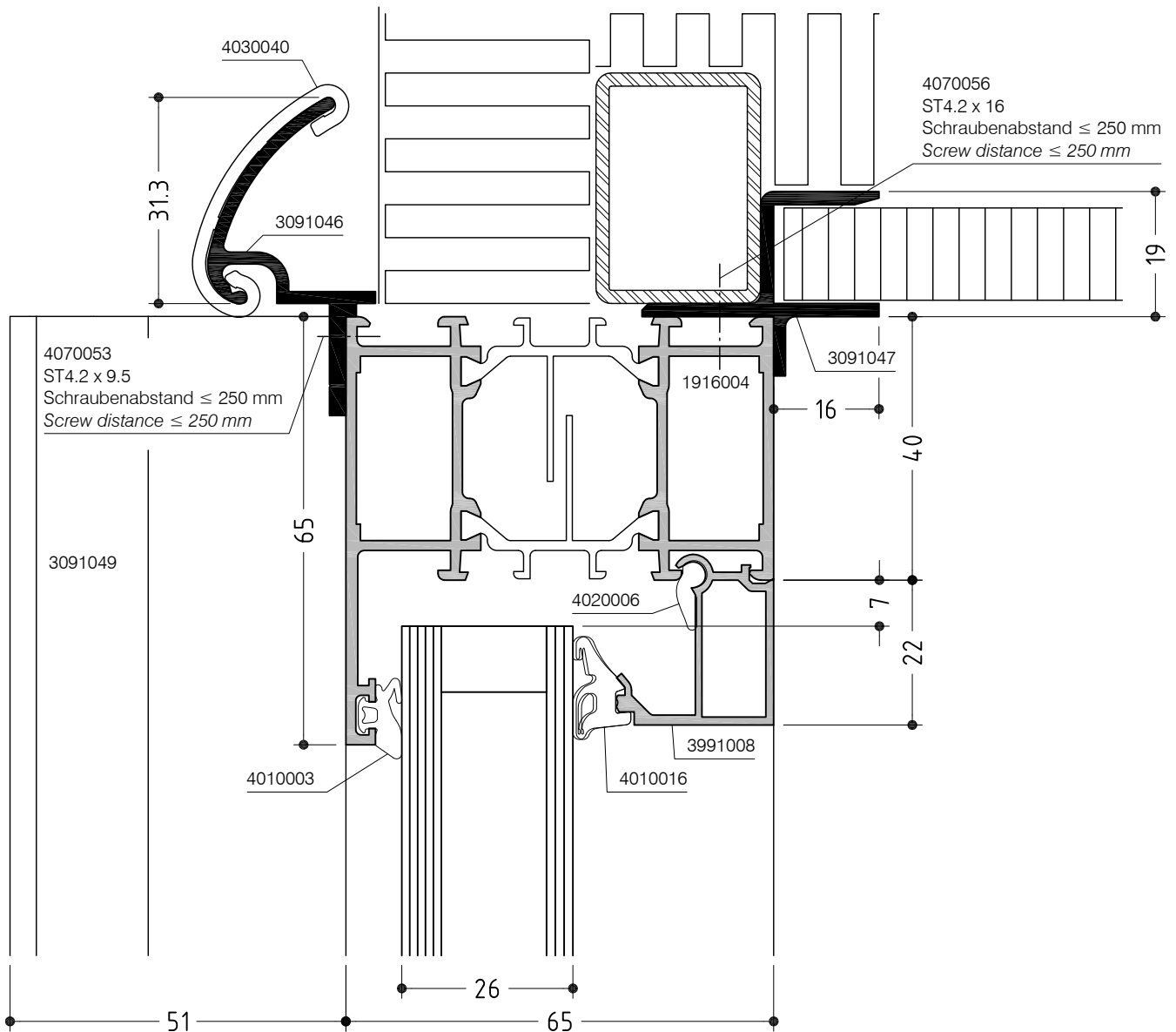

# WICLINE 65

Zusatzprofil 3091058 und 3091059  
Additional profile 3091058 and 3091059

Konstruktionsschnitt  
Construction section

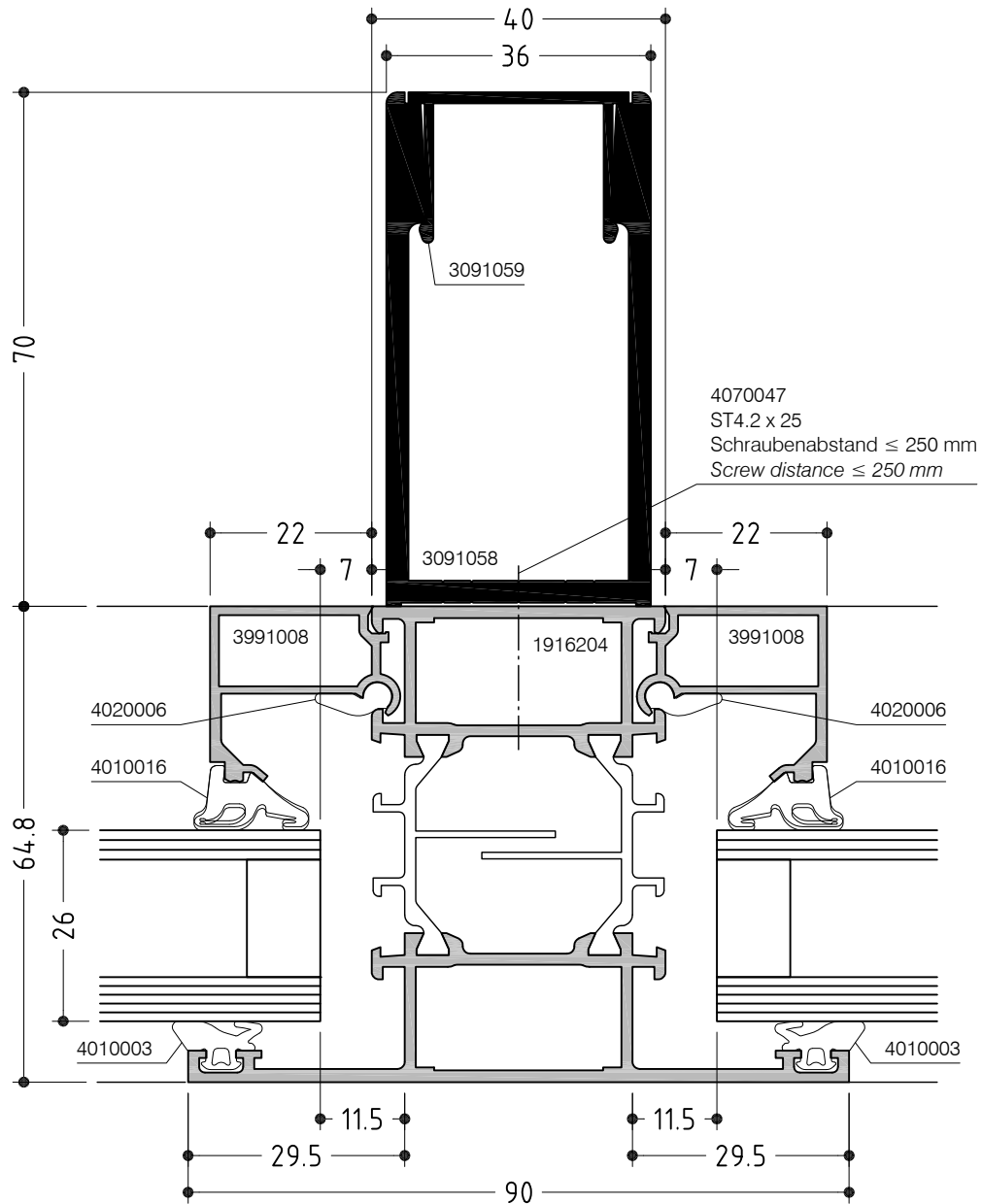
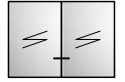

# WICLINE 65





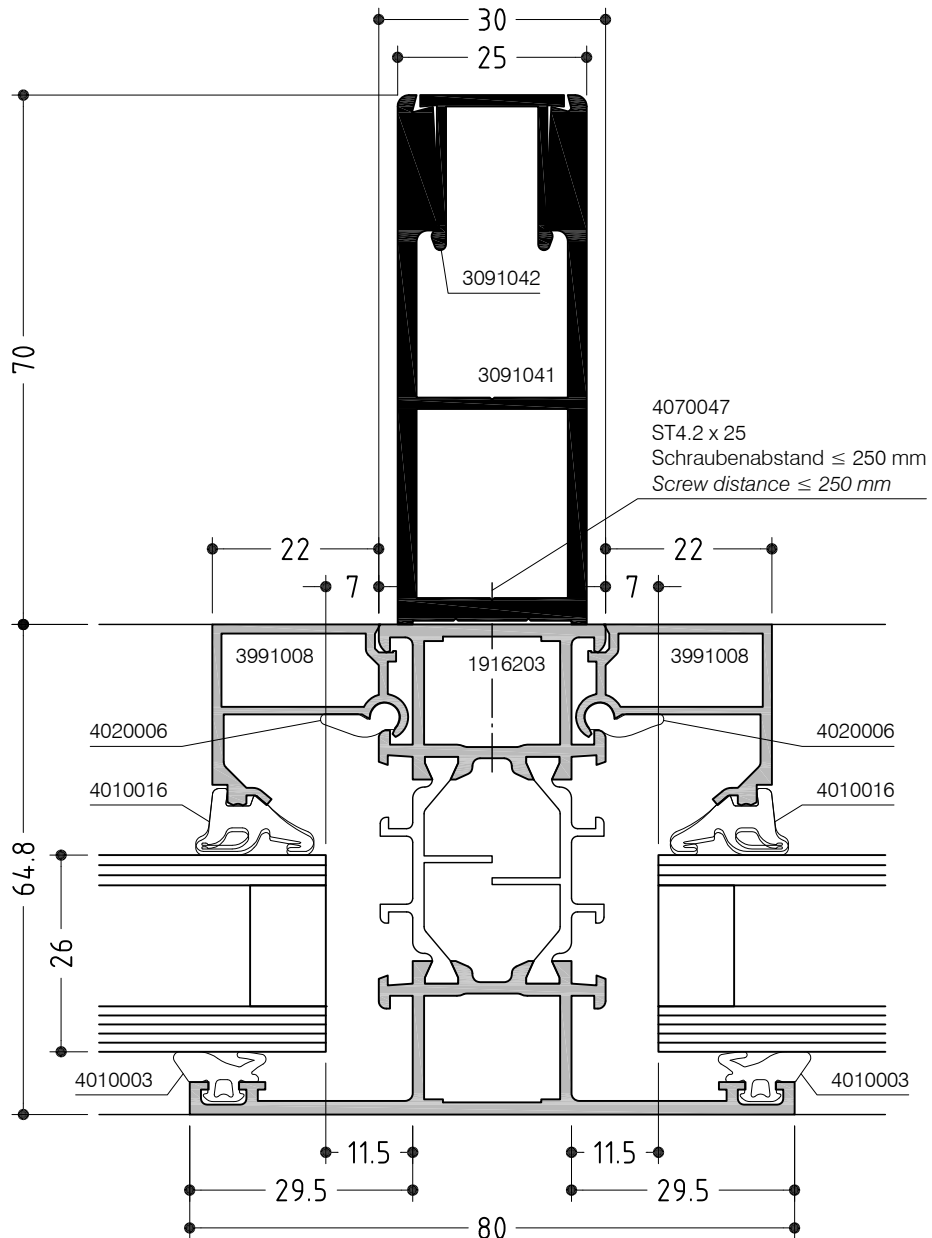
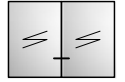

Zusatzprofil 3091041 und 3091042  
Additional profile 3091041 and 3091042



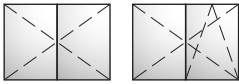
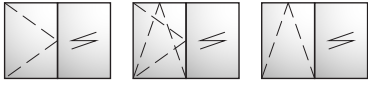



Konstruktionsschnitt  
Construction section



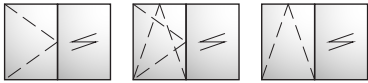

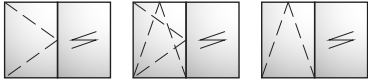
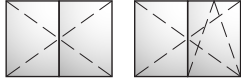
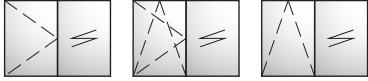

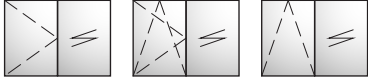



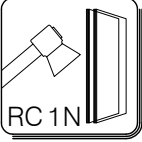

	Seite Page	
<b>Symbole</b> <i>Symbols</i>	160	
<b>Legende</b> <i>Legend</i>	161	
<b>Übersicht der Öffnungsarten</b> <i>Survey of opening types</i>	162	
<b>Standardflügel</b> <i>Standard sash</i>	165	
	<b>Flügelprofil im Blendrahmen</b> <i>Sash profile in frame</i>	165
	<b>Stulpfenster - Mittelstoß</b> <i>Double casement window - Meeting stiles</i>	166
	<b>Flügelprofil im Blendrahmen mit Kämpfer</b> <i>Sash profile in frame with transom</i>	168
	<b>Festverglasung</b> <i>Fixed glazing</i>	169
	<b>Flügelprofil im Blendrahmen mit Sprossenprofil</b> <i>Sash profile in frame with glazing bar profile</i>	171
	<b>Flügelprofil im Einspannblendrahmen</b> <i>Sash profile in clamping frame</i>	172
	<b>Bauanschluss unten</b> <i>Bottom junction to structure</i>	173
	<b>Verdeckter Flügel</b> <i>Concealed sash</i>	175
	<b>Flügelprofil im Blendrahmen</b> <i>Sash profile in frame</i>	175
	<b>Stulpfenster - Mittelstoß</b> <i>Double casement window - Meeting stiles</i>	178

	Seite Page	
	<p><b>Flügelprofil im Blendrahmen mit Kämpfer</b> <i>Sash profile in frame with transom</i></p>	179
	<p><b>Flügelprofil im Einspannblendrahmen</b> <i>Sash profile in clamping frame</i></p>	182
	<p><b>Bauanschluss unten</b> <i>Bottom junction to structure</i></p>	184
	<p><b>Einbruchhemmung</b> <i>Burglar resistance</i></p>	185
	<p><b>Flügelprofil im Blendrahmen mit Kämpfer</b> <i>Sash profile in frame with transom</i></p>	185
	<p><b>Stulpfenster - Mittelstoß</b> <i>Double casement window - Meeting stiles</i></p>	187
	<p><b>Flügelprofil im Blendrahmen mit Kämpfer, verdeckter Flügel</b> <i>Sash profile in frame with transom, concealed sash</i></p>	189
	<p><b>Durchschusshemmung</b> <i>Bullet resistance</i></p>	193
	<p><b>Blendrahmen Festverglasung</b> <i>Frame profile fixed glazing</i></p>	193
	<p><b>Blendrahmen Fensterflügel</b> <i>Frame profile window sash</i></p>	194
	<p><b>Elementkopplung Fensterflügel / Festverglasung</b> <i>Unit coupling window sash / fixed glazing</i></p>	195
	<p><b>Kämpferprofil Festverglasung</b> <i>Transom profile fixed glazing</i></p>	196

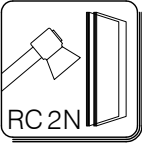
	Seite <i>Page</i>
<b>Zusatzprofile</b> <i>Additional profiles</i>	<b>197</b>
<b>3091037 / 3991280</b>	<b>197</b>

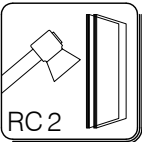
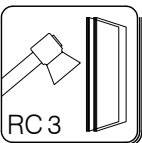
Symbole  
Symbols

Symbol	Bezeichnung	Symbol	Bezeichnung
Symbols	Designation	Symbols	Designation
	Einbruchhemmung RC 1 N nach DIN EN 1627:2011  <i>Burglary resistance RC 1 N according to DIN EN 1627:2011</i>		barrierefrei  <i>barrier-free</i>
	Einbruchhemmung RC 2 N nach DIN EN 1627:2011  <i>Burglary resistance RC 2 N according to DIN EN 1627:2011</i>		Darstellung 90° gedreht  <i>Representation turned by 90°</i>
	Einbruchhemmung RC 2 nach DIN EN 1627:2011  <i>Burglary resistance RC 2 according to DIN EN 1627:2011</i>		
	Einbruchhemmung RC 3 nach DIN EN 1627:2011  <i>Burglary resistance RC 3 according to DIN EN 1627:2011</i>		
	Durchschusshemmung nach EN 1522  <i>Bullet resistance according to EN 1522</i>		



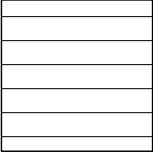
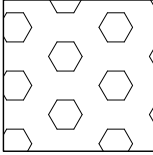
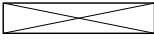
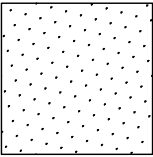
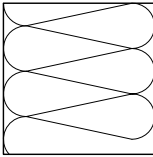
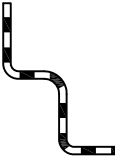
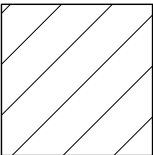
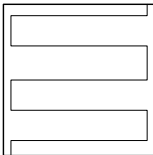
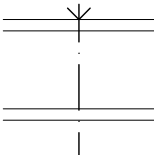
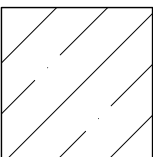
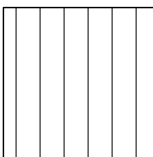
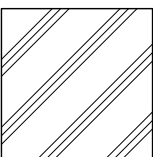
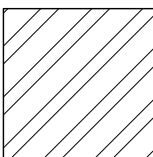
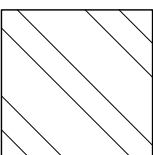
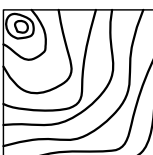
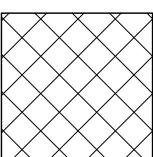
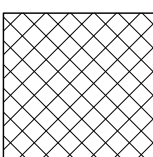
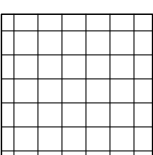
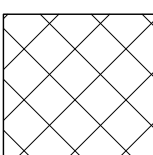













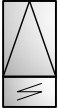

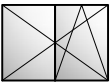
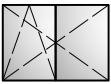
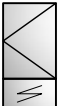
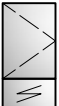
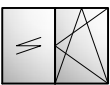
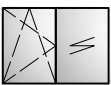

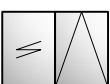
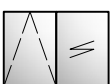

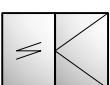
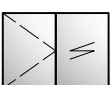

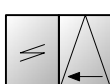
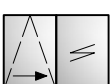
### Legende Legend

Muster <i>Swatch</i>	Bezeichnung <i>Designation</i>	Muster <i>Swatch</i>	Bezeichnung <i>Designation</i>	Muster <i>Swatch</i>	Bezeichnung <i>Designation</i>
	Streifen <i>Strip</i>		Lochblech <i>Perforated sheet</i>		Trag- bzw. Distanzklotz (Polyäthylen o. glw.) <i>Supporting or distance shim (Polyethylene or equivalent)</i>
	Putz <i>Plaster</i>		Wärmedämmung (alt) <i>Heat insulated (old)</i>		Dichtbahn (Dampfsperre, Dichtstreifen) <i>Sealing web (vapour barrier / sealing strips)</i>
	Mauerwerk <i>Wall</i>		Wärmedämmung <i>Heat insulated</i>		Verschraubung <i>Screwing</i>
	Beton <i>Concrete</i>		Keramik <i>Ceramics</i>		
	Steinplatten <i>Stone slabs</i>		Stahl <i>Steel</i>		
	Naturstein <i>Natural stone</i>		Holz <i>Wood</i>		
	Dauerelastische Dichtungsmasse <i>Permanently elastic sealing compound</i>		Imprägniertes Dichtband <i>Impregnated sealing strap</i>		
	Hinterfüllschnur <i>Back-filling cord</i>		Hartschaum Wärmedämmung <i>Hard foam Heat insulated</i>		

### Öffnungsarten Opening types

Ansicht von Innen <i>Inner view</i>	Bezeichnung <i>Designation</i>	Ansicht von Außen <i>Outer view</i>	Ansicht von Innen <i>Inner view</i>	Bezeichnung <i>Designation</i>	Ansicht von Außen <i>Outer view</i>
	Festverglasung <i>Fixed glazing</i>			Senk - Klapp - Fenster <i>Italian style window</i>	
	Photovoltaik <i>Photovoltaic</i>			Klapp - Fenster <i>Top-hung window</i>	
	Kipp - Fenster <i>Tilt window</i>			Schwing - Fenster <i>Horizontal pivot window</i>	
	Dreh - Fenster <i>Turn window</i>			Wende - Fenster <i>Vertical pivot window</i>	
	Drehkipp - Fenster <i>Turn/tilt window</i>			Parallel - Ausstellfenster <i>Parallel opening window</i>	
	Festverglasung mit Oberlicht <i>Fixed glazing with fanlight</i>			Rundbogen - Festverglasung <i>Semi-circular arch fixed glazing</i>	
	Drehkipp - Fenster mit Oberlicht <i>Turn/tilt window with fanlight</i>			Schräg - Festverglasung <i>Sloped fixed glazing</i>	
	Festverglasung mit Oberlicht Kippflügel <i>Fixed glazing with tilt window fanlight</i>			Rundbogen - Drehkipp - Fenster <i>Semi-circular arch turn/tilt window</i>	
	Drehkipp - Fenster mit Oberlicht Kippfenster <i>Turn/tilt window with tilt window fanlight</i>			Schräg - Drehkipp - Fenster <i>Sloped turn/tilt window</i>	

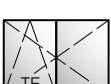
### Öffnungsarten Opening types

Ansicht von Innen <i>Inner view</i>	Bezeichnung <i>Designation</i>	Ansicht von Außen <i>Outer view</i>	Ansicht von Innen <i>Inner view</i>	Bezeichnung <i>Designation</i>	Ansicht von Außen <i>Outer view</i>
	Stichbogen - Drehkipp - Fenster <i>Segmental arch turn/tilt window</i>			Drehkipp - Fenster; Tilt-First Ausführung <i>Turn/tilt window. Type: Tilt-First</i>	
	Segment - Drehkipp - Fenster <i>Segmental turn/tilt window</i>			Kipp - Fenster mit Unterlicht <i>Tilt window with sublight</i>	
	Stulp - Fenster oder 2 - flügeliges Fenster mit Kämpfer <i>Double casement window or double sash window with transom</i>			Dreh - Fenster mit Unterlicht <i>Turn window with sublight</i>	
	Drehkipp - Fenster mit Festverglasung <i>Turn/tilt window with fixed glazing</i>			Drehkipp - Fenster mit Unterlicht <i>Turn/tilt window with sublight</i>	
	Kipp - Fenster mit Festverglasung <i>Tilt window with fixed glazing</i>			Festverglasung mit Sprosse <i>Fixed glazing with glazing bars</i>	
	Dreh - Fenster mit Festverglasung <i>Turn window with fixed glazing</i>			Kippfenster - Sprossenfenster <i>Tilt window with glazing bars</i>	
	Parallel - Schiebe - Kipp - Fenster <i>Parallel sliding tilt window</i>			Drehfenster - Sprossenfenster <i>Turn window with glazing bars</i>	
	Stulp - Fenster oder 2 - flügeliges Fenster mit Kämpfer <i>Double casement window or double sash window with transom</i>			Drehkipp - Sprossenfenster <i>Turn/tilt window with glazing bars</i>	
	Stulp - Fenster oder 2 - flügeliges Fenster mit Kämpfer; Tilt-First Ausführung <i>Double casement window or double sash window with transom. Type: Tilt-First</i>			Fenstertür, barrierefrei <i>Casement door, accessible</i>	





# WICLINE 75 TOP

Konstruktionsschnitt

Construction section

Flügelprofil im Blendrahmen mit Spezial-Dämmprofil

Sash profile in frame with special insulation profile

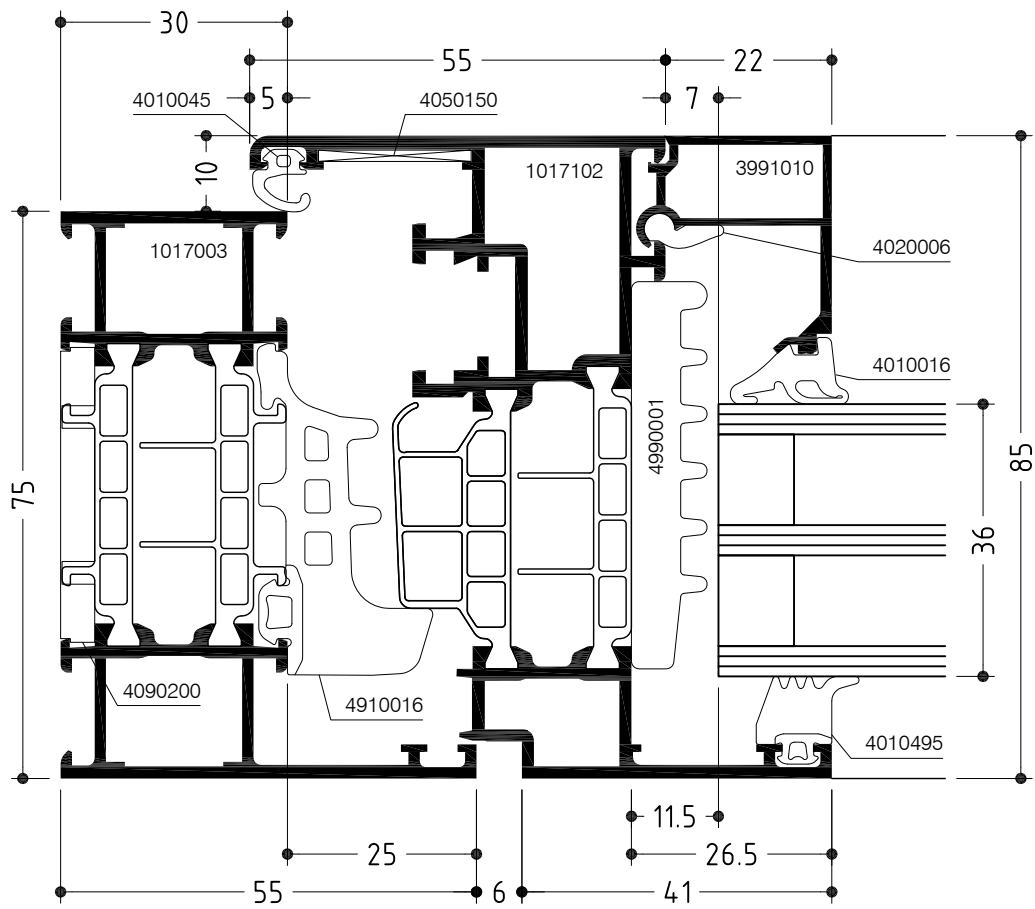

# WICLINE 75 TOP

Stulpfenster - Mittelstoß  
Double casement window - Meeting stiles

Konstruktionsschnitt  
Construction section

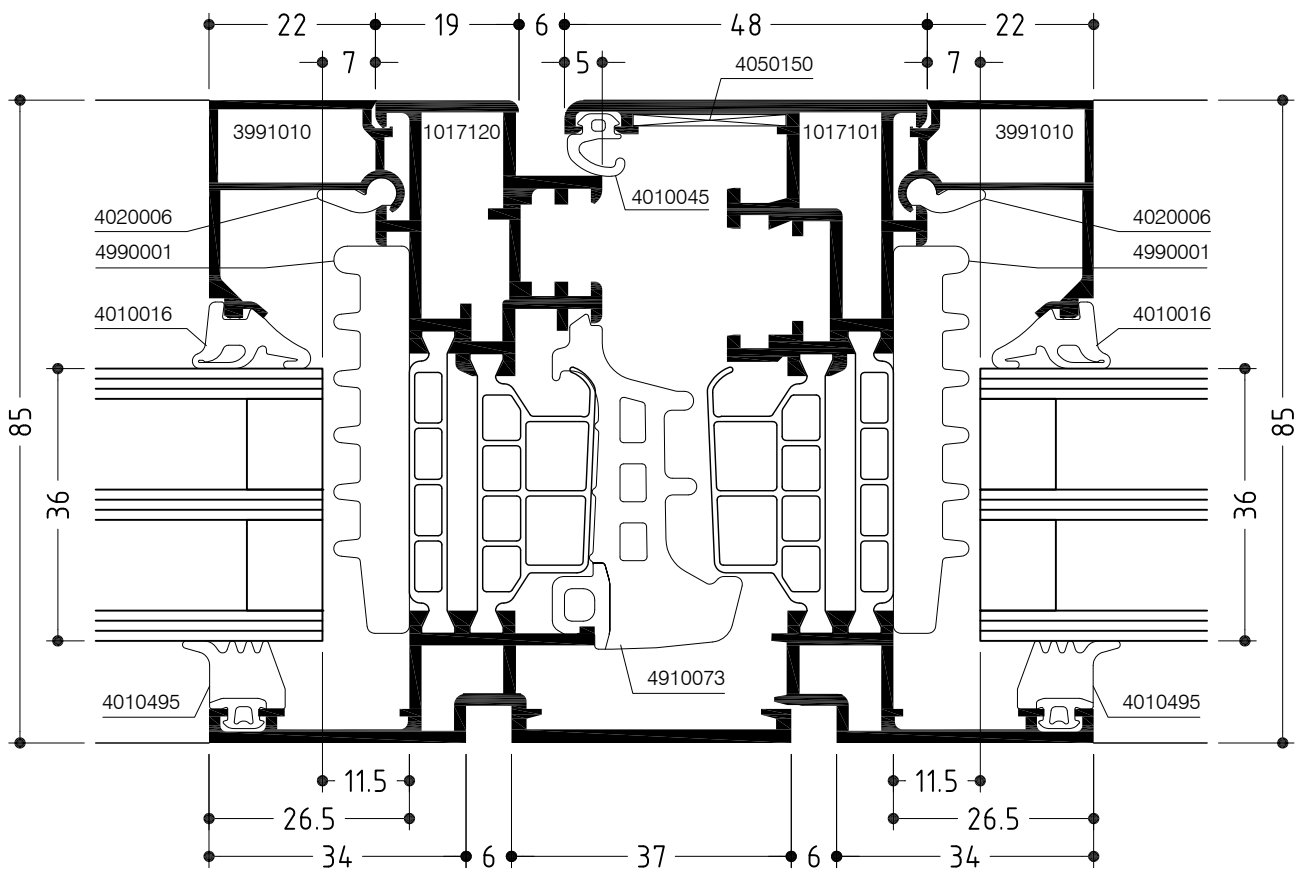
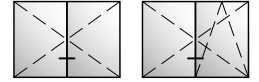

# WICLINE 75 TOP

Stulpfenster mit Aufsatzprofil - Mittelstoß  
 Double casement window with supplm. profile - Meeting stiles

Konstruktionsschnitt  
 Construction section

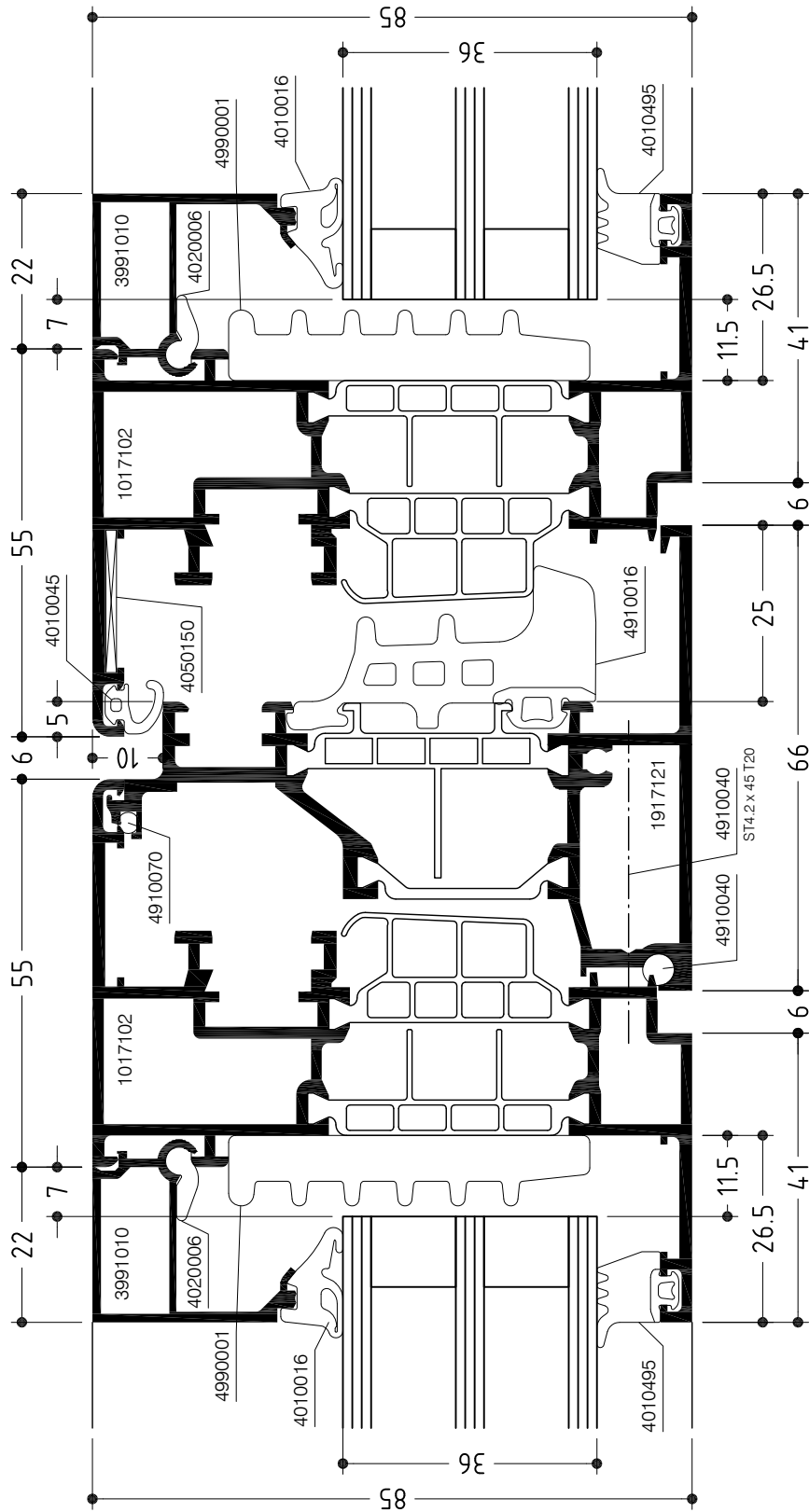
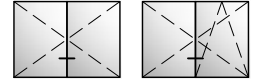

# WICLINE 75 TOP

Flügelprofil im Blendrahmen mit Kämpfer  
Sash profile in frame with transom

Konstruktionsschnitt  
Construction section

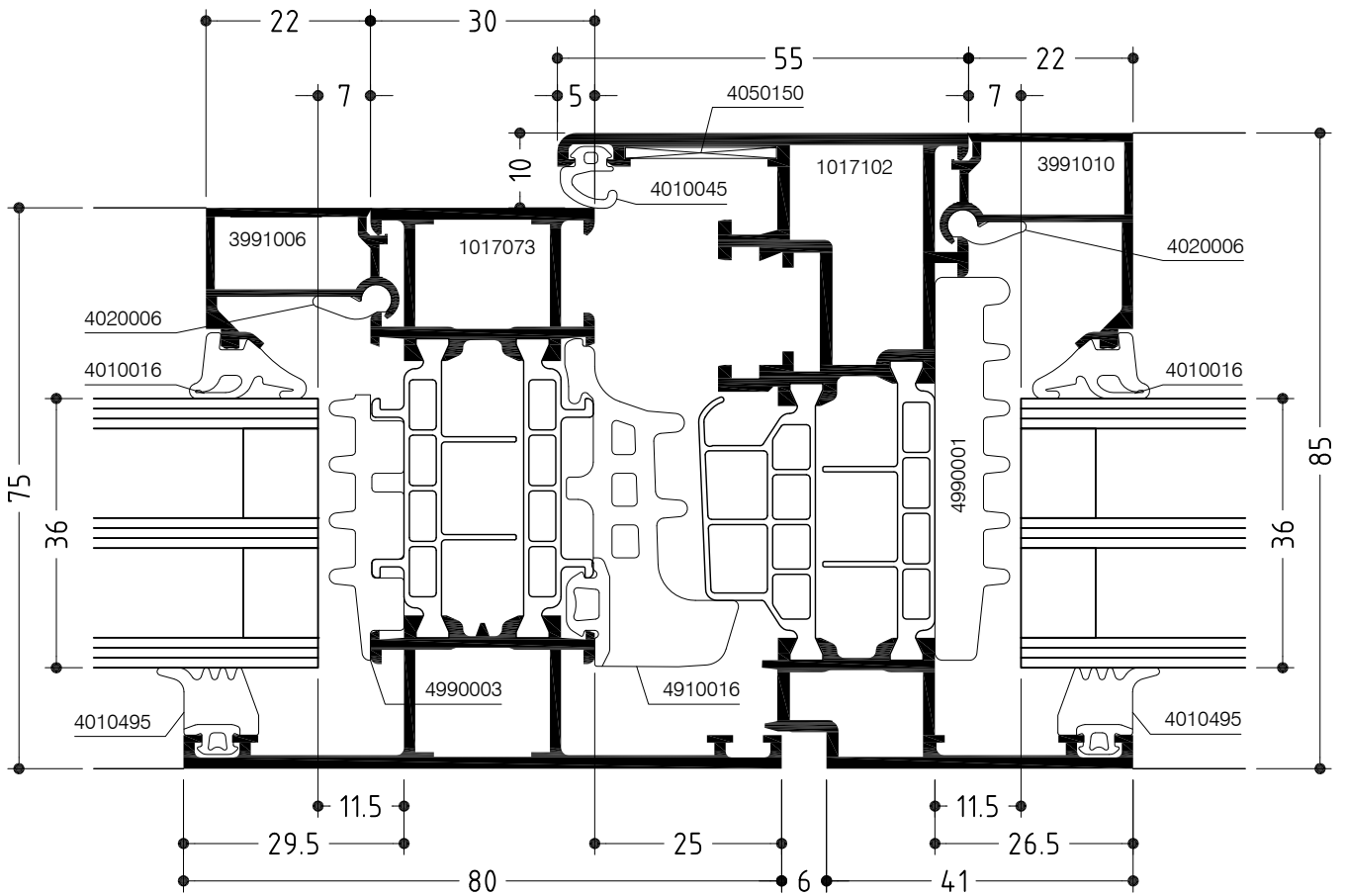
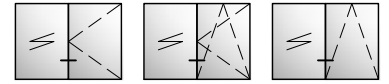

# WICLINE 75 TOP

Festverglasung  
Fixed glazing

Konstruktionsschnitt  
Construction section

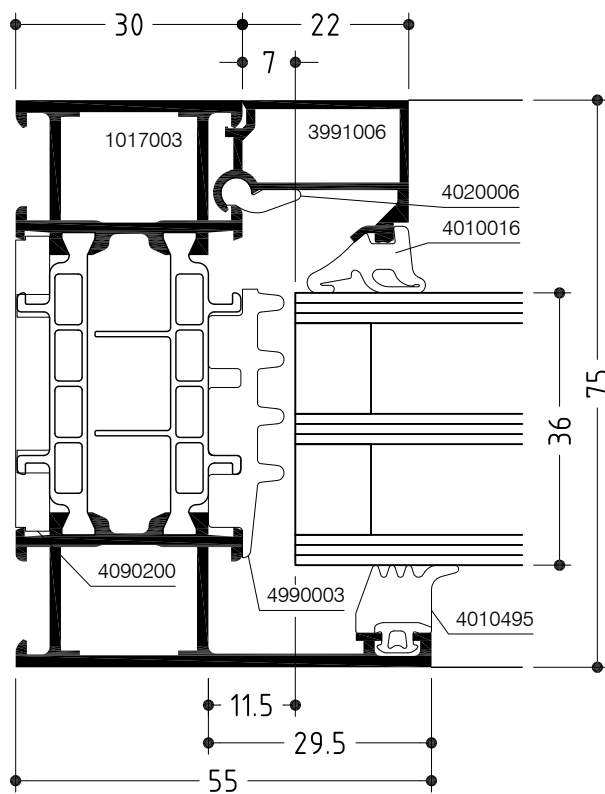

# WICLINE 75 TOP

Kämpferprofil mit Festverglasung und Spezial-Dämmprofil  
Transom profile with fixed glazing and special insulation profile

Konstruktionsschnitt  
Construction section

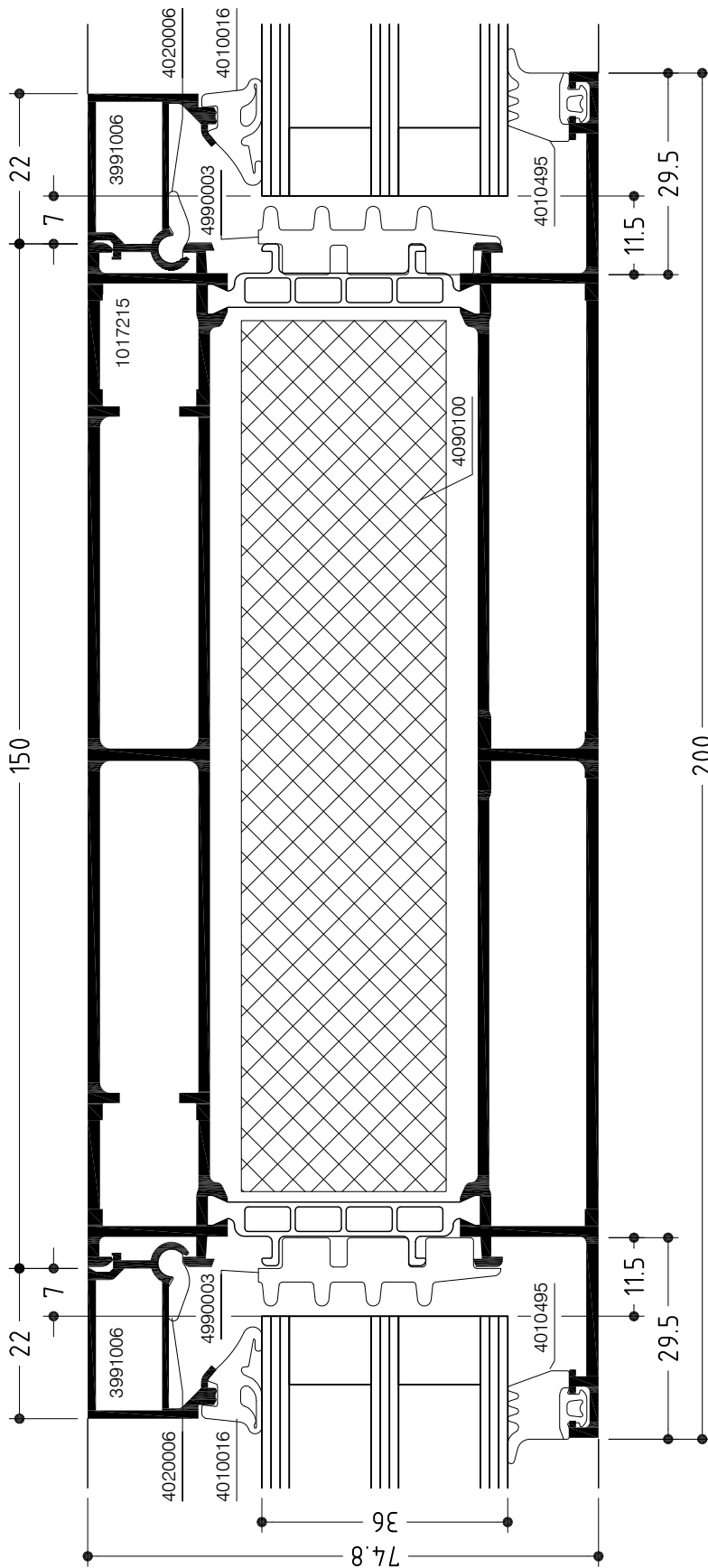
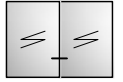

# WICLINE 75 TOP

Flügelprofil im Blendrahmen mit Ziersprossenprofil  
*Sash profile in frame with glazing bar profile*

Konstruktionsschnitt  
*Construction section*

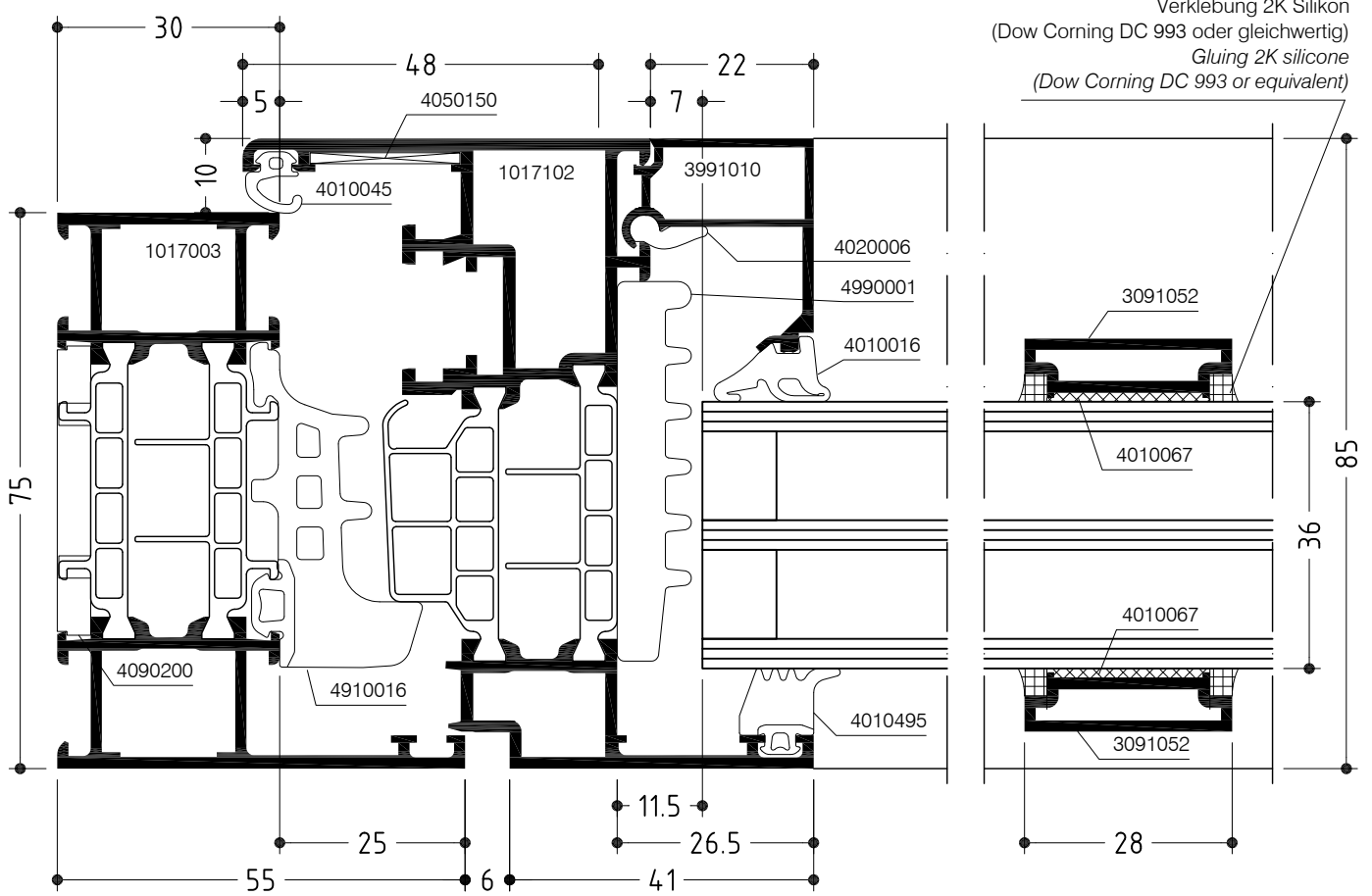

# WICLINE 75 TOP

Flügelprofil im Einspannblendrahmen  
Sash profile in clamping frame

Konstruktionsschnitt  
Construction section

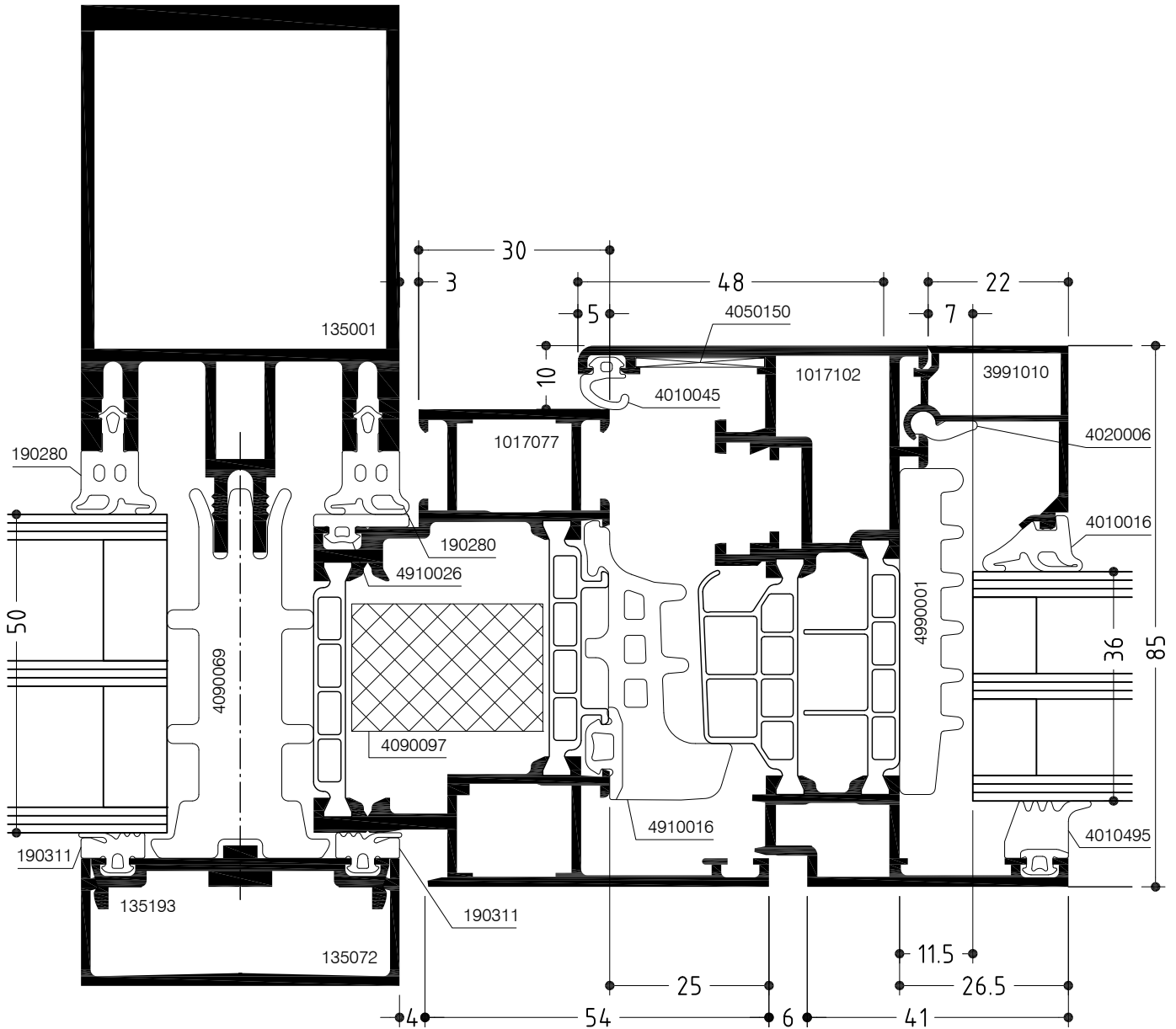



# WICLINE 75 TOP

Konstruktionsschnitt

Construction section

Bauanschluss unten mit Dämmauflage 4030365

Bottom junction to structure with insulation support 4030365

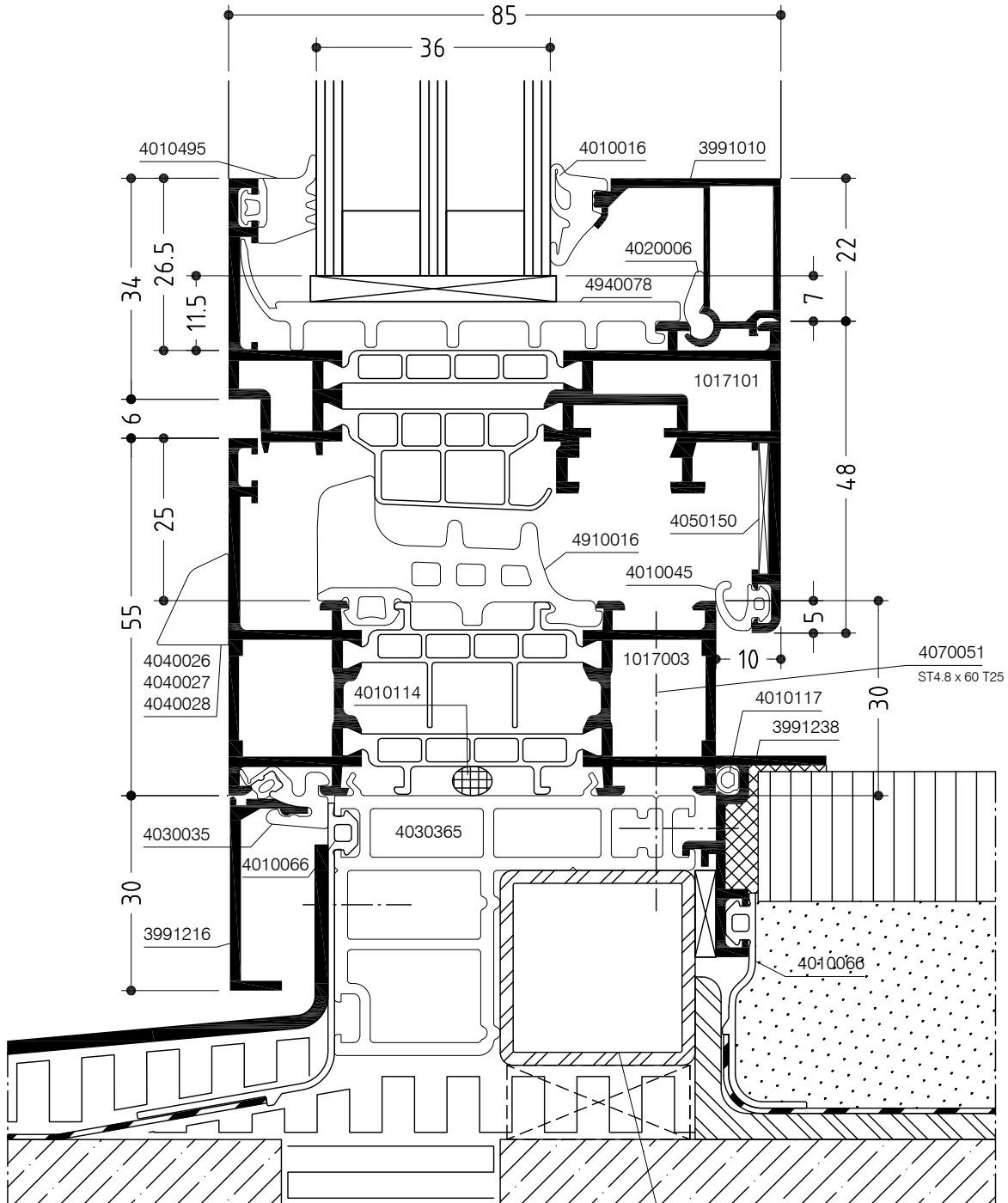

Stahlrohr 30 x 30 x 2.5  
 verzinkt nach DIN 55928  
 30 x 30 x 2.5 Steel tube,  
 galv. acc. to DIN 55928

# WICLINE 75 TOP

## Konstruktionsschnitt

### Construction section

Bauanschluss unten mit Dämmauflage 4030365

Bottom junction to structure with insulation support 4030365

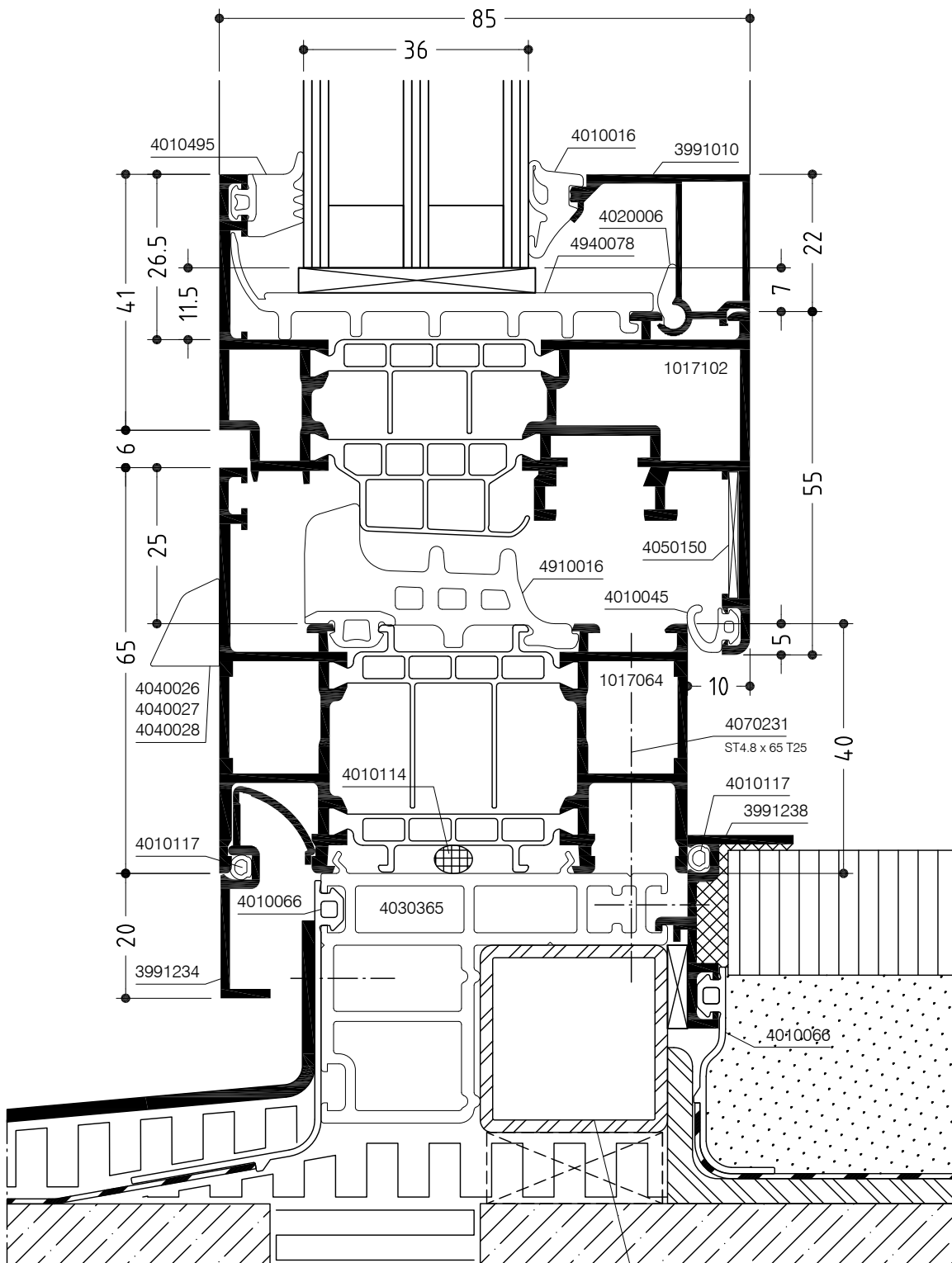

Stahlrohr 30 x 30 x 2.5  
 verzinkt nach DIN 55928  
 30 x 30 x 2.5 Steel tube,  
 galv. acc. to DIN 55928

# WICLINE 75 TOP

Flügelprofil im Blendrahmen, verdeckter Flügel  
Concealed sash in frame

Konstruktionsschnitt  
Construction section

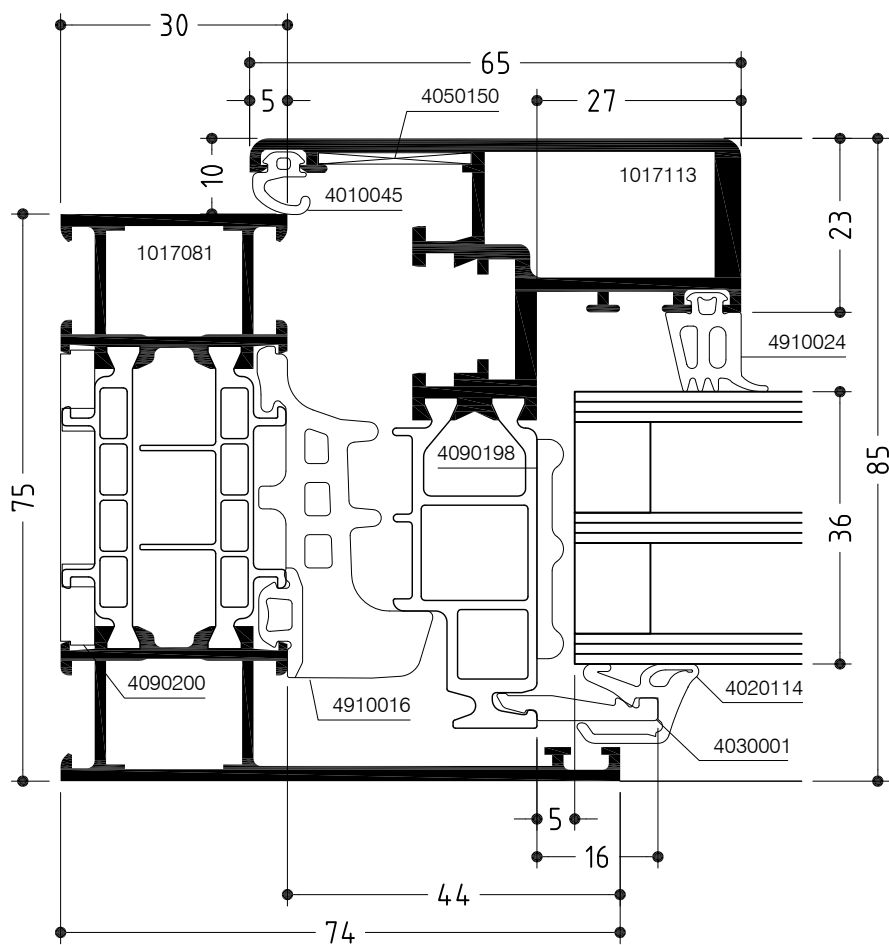

# WICLINE 75 TOP

Flügelprofil im Blendrahmen, verdeckter Flügel  
Concealed sash in frame

Konstruktionsschnitt  
Construction section

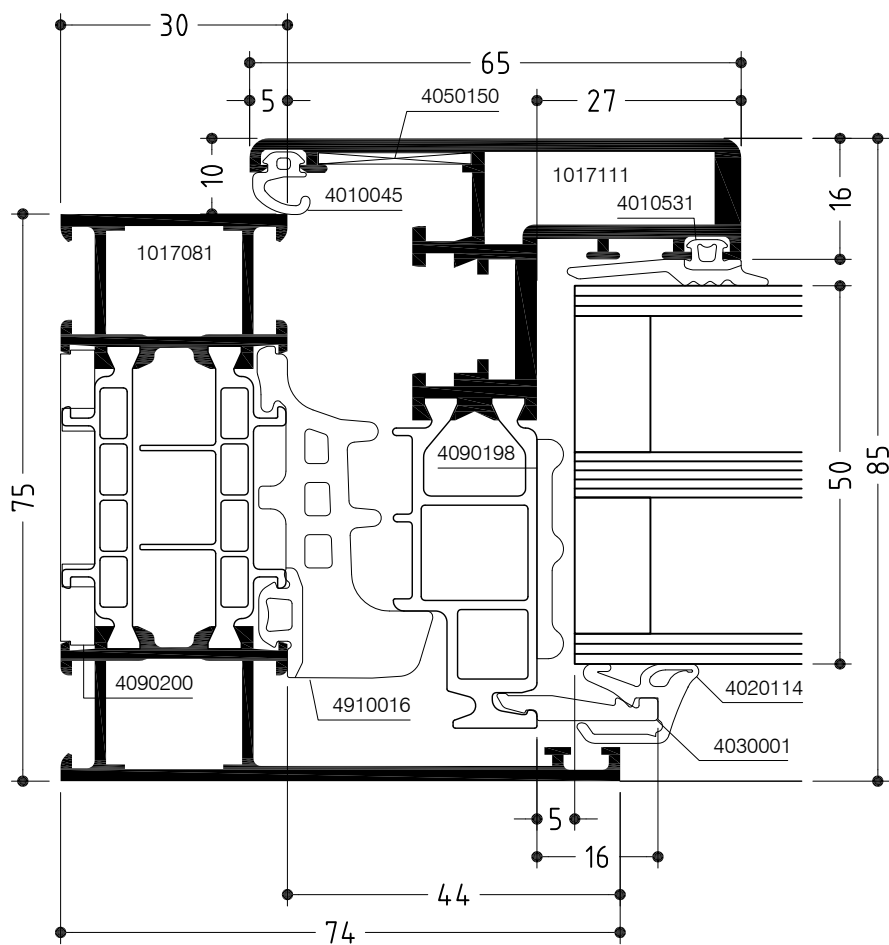

# WICLINE 75 TOP

Verdeckte Entwässerung, verdeckter Flügel  
Concealed drainage, concealed sash in frame

Konstruktionsschnitt  
Construction section

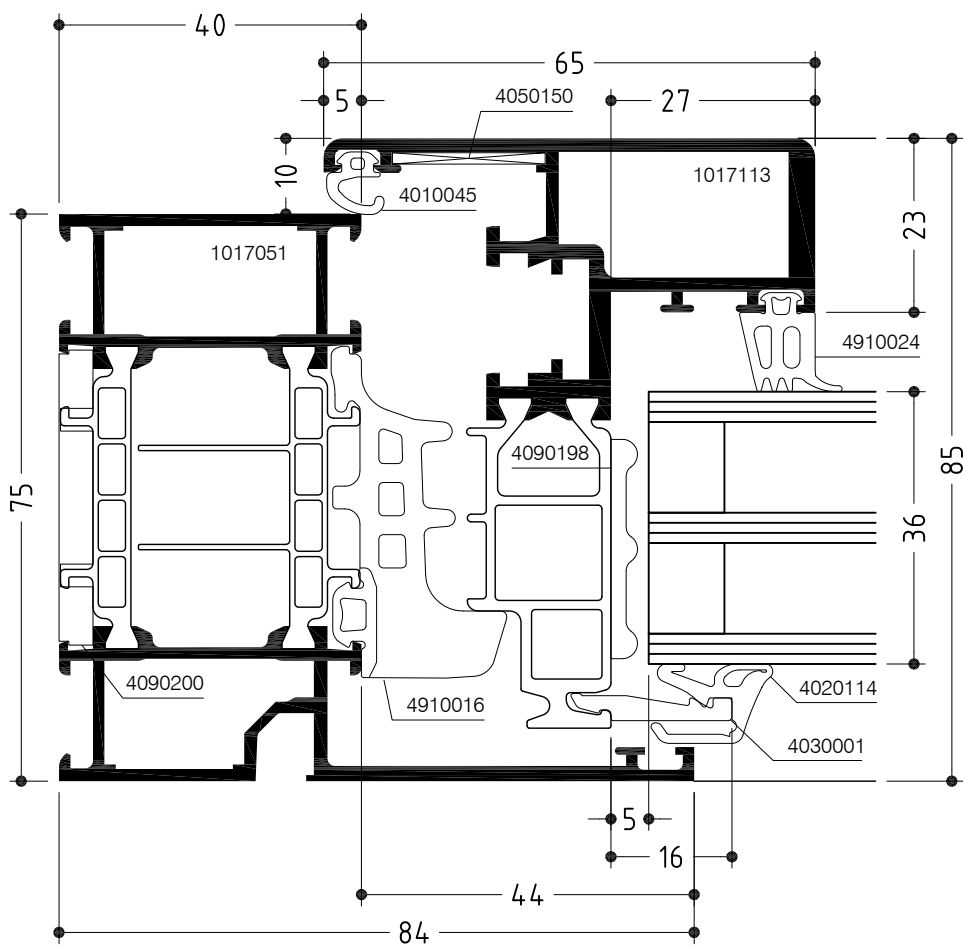

# WICLINE 75 TOP

Konstruktionsschnitt

Construction section

Stulpfenster - Mittelstoß, verdeckter Flügel

Double casement window with concealed sash - Meeting stiles

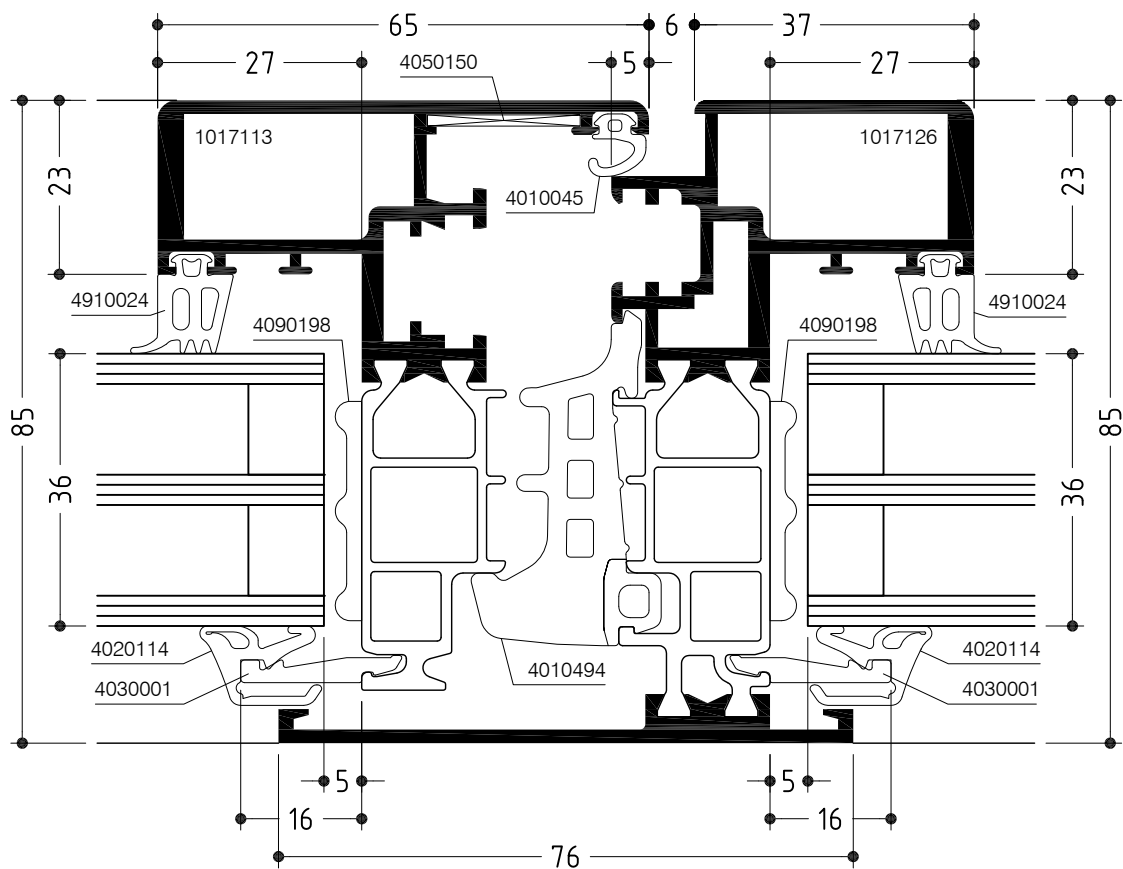
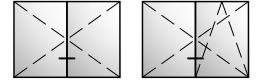

# WICLINE 75 TOP

Konstruktionsschnitt

Construction section

Flügelprofil im Blendrahmen mit Kämpfer, verdeckter Flügel

Concealed sash in frame with transom

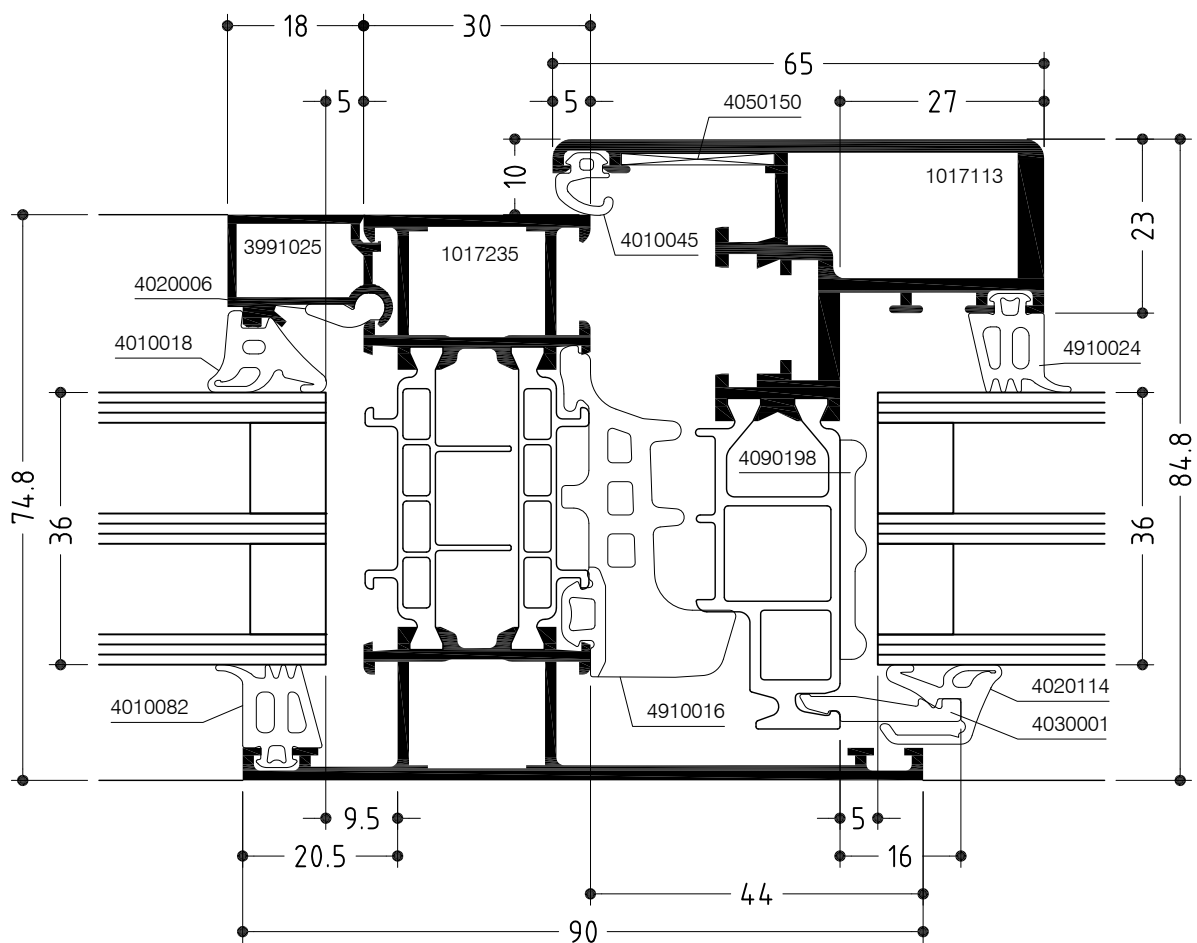
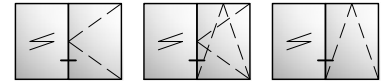

# WICLINE 75 TOP

Konstruktionsschnitt

Construction section

Flügelprofil im Blendrahmen mit Kämpfer, verdeckter Flügel

Concealed sash in frame with transom

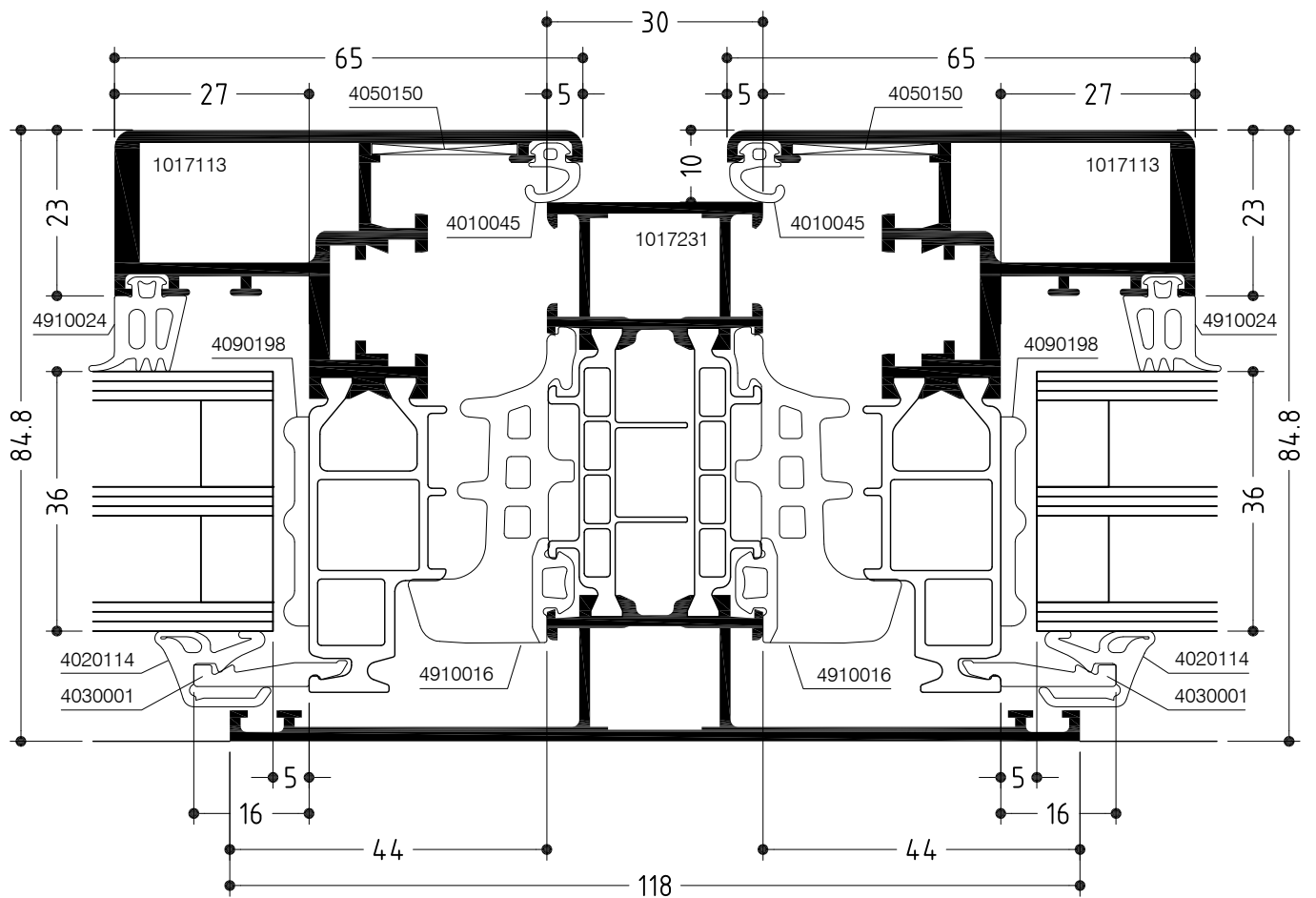
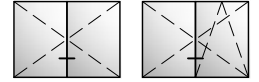



# WICLINE 75 TOP

Konstruktionsschnitt

Construction section

Flügelprofil im Blendrahmen mit Kämpfer, verdeckter Flügel

Concealed sash in frame with transom

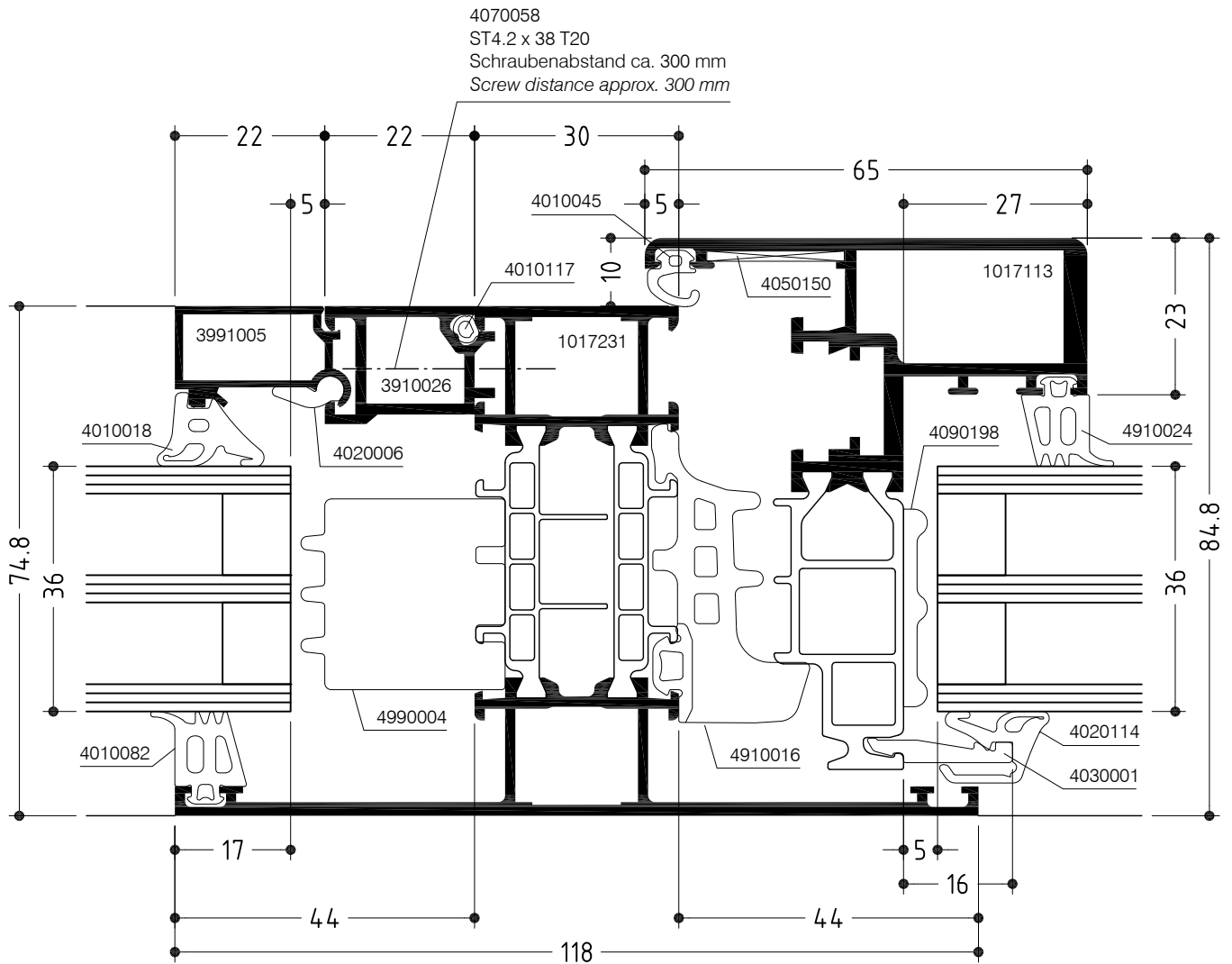
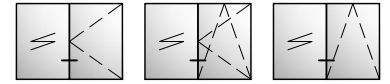

# WICLINE 75 TOP

Konstruktionsschnitt

Construction section

Flügelprofil im Einspannblendrahmen, verdeckter Flügel

Concealed sash in clamping frame

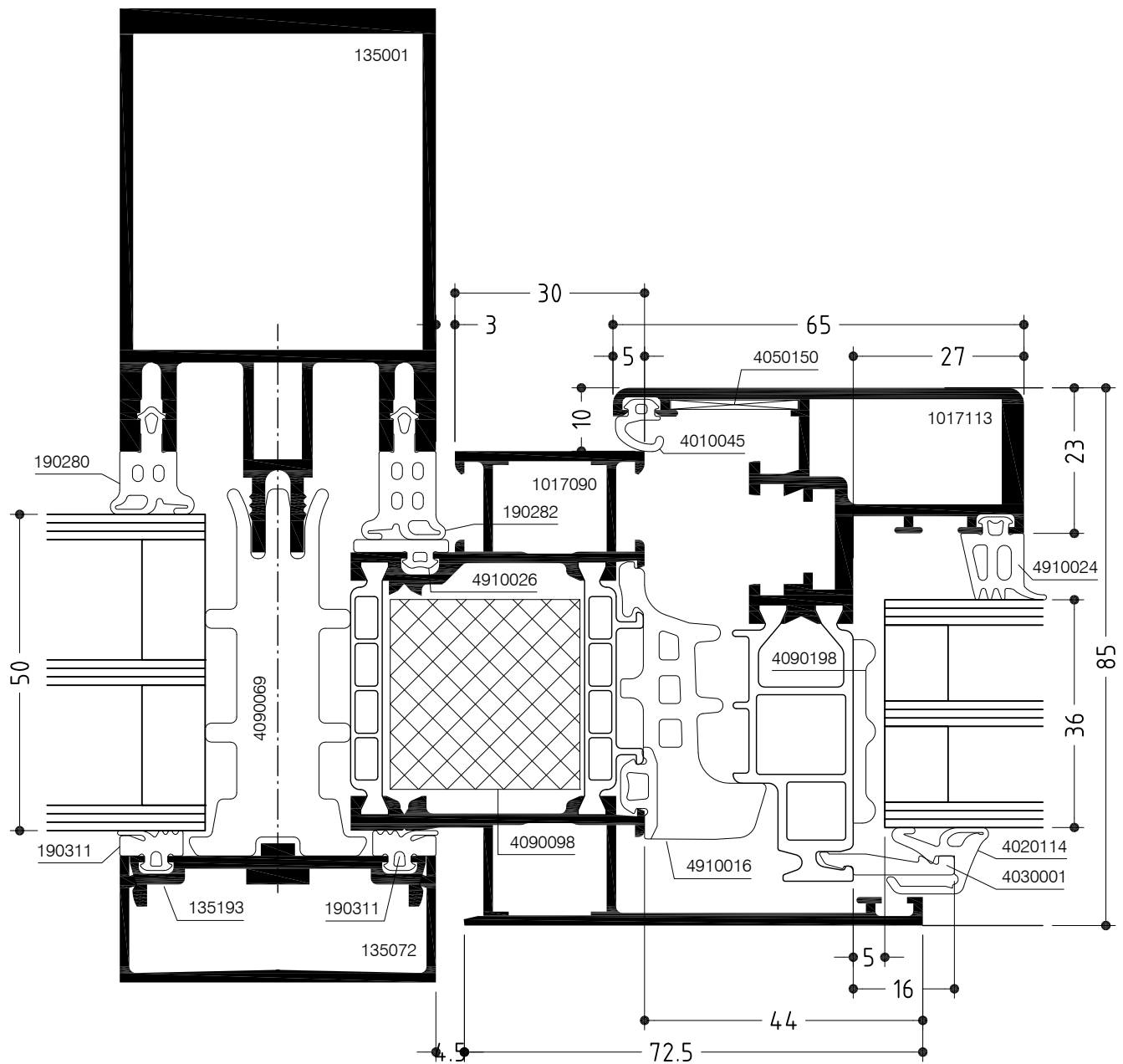

# WICLINE 75 TOP

Konstruktionsschnitt

Construction section

Flügelprofil im Blendrahmen mit Einspannaufsatz, verdeckter Flügel  
Concealed sash in frame with supplementary clamping profile

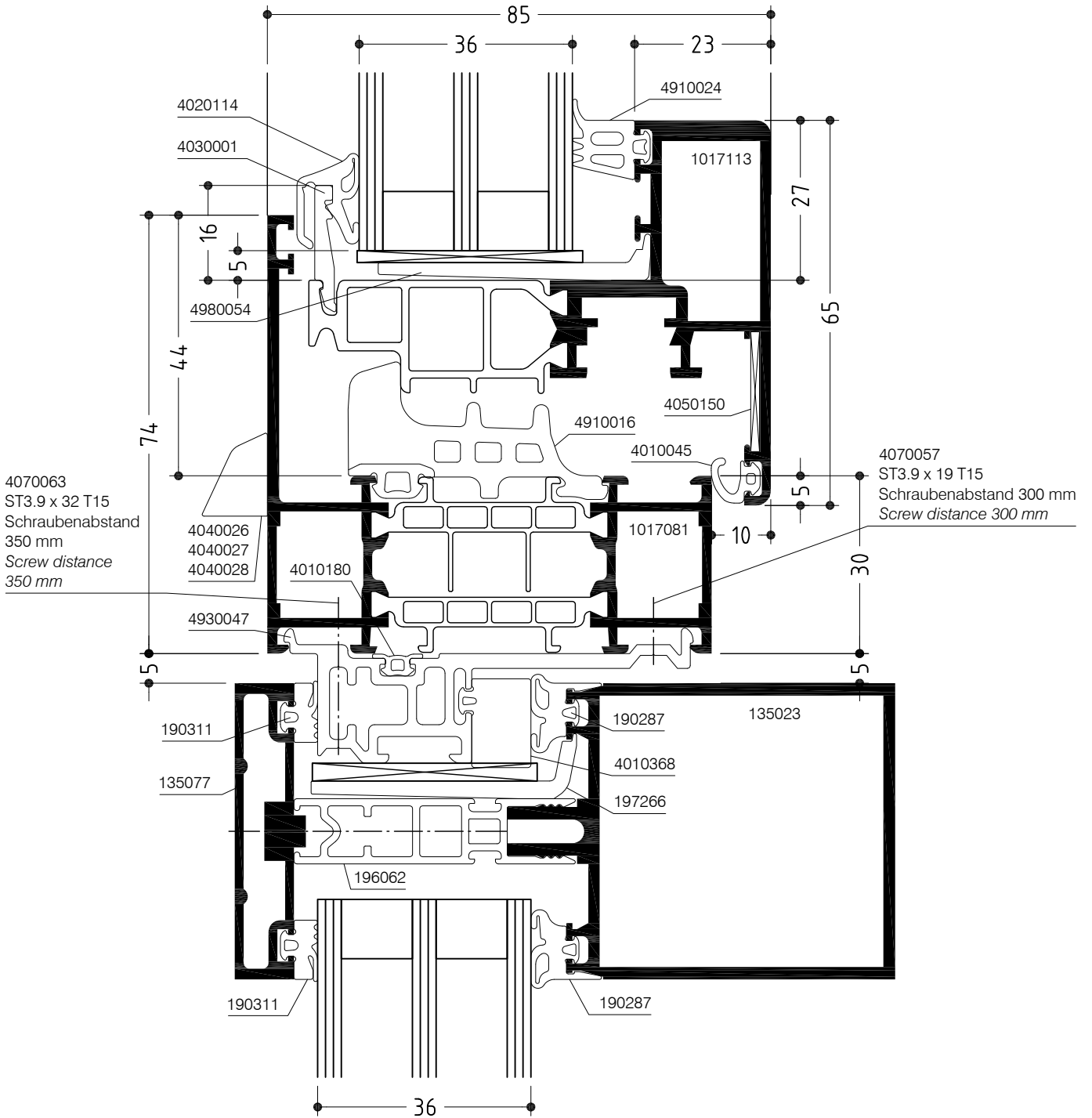

# WICLINE 75 TOP

## Konstruktionsschnitt

### Construction section

Bauanschluss unten mit Dämmauflage 4030365, verdeckter Flügel

Bottom junction to structure with insulation support 4030365 and concealed sash

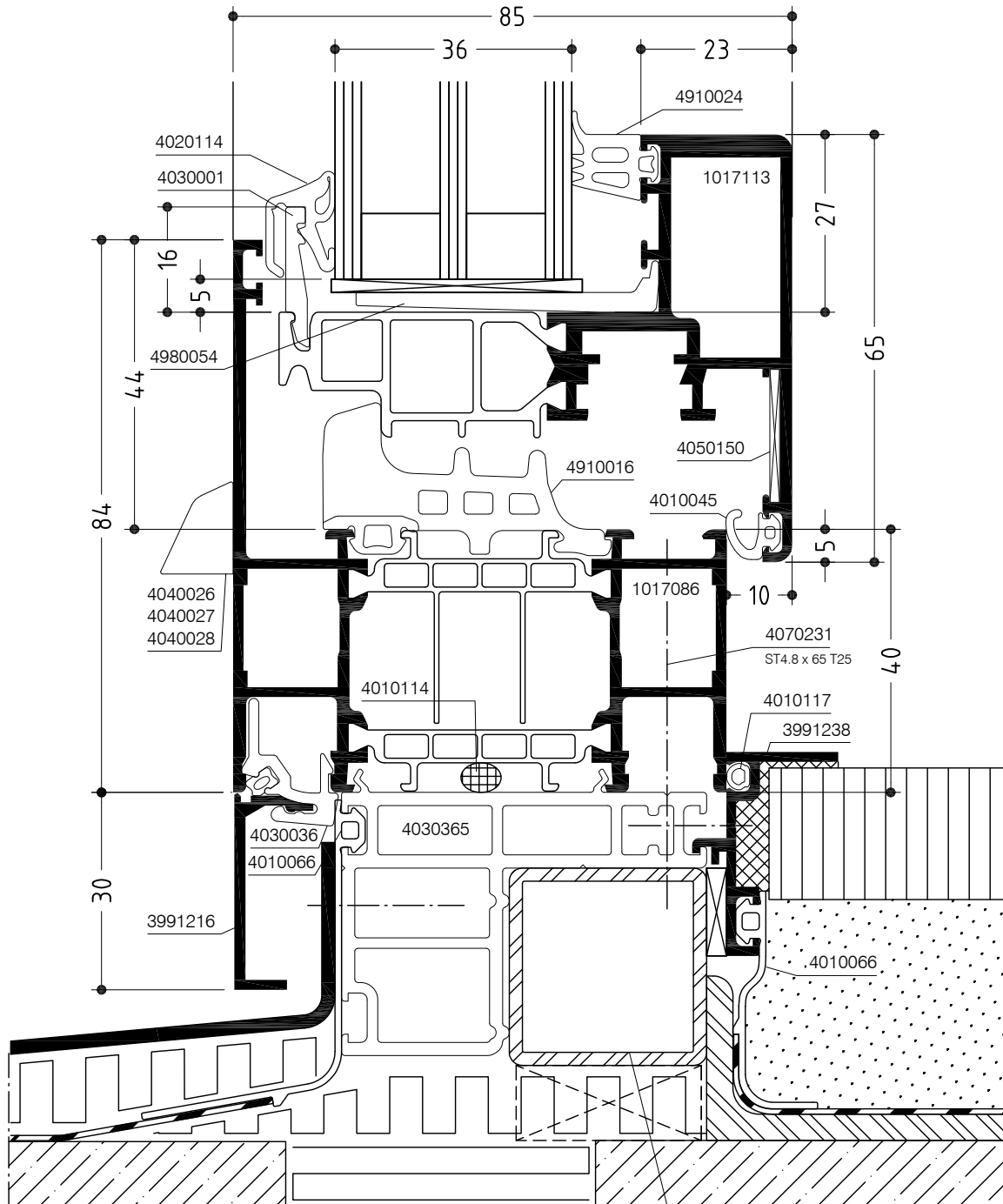

Stahlrohr 30 x 30 x 2.5  
 verzinkt nach DIN 55928  
 30 x 30 x 2.5 Steel tube,  
 galv. acc. to DIN 55928

# WICLINE 75 TOP

Konstruktionsschnitt

Construction section

Flügelprofil im Blendrahmen mit Kämpfer, EH-Verriegelung /  
Füllungssicherung

Sash profile in frame with transom, burglar resistant locking / Infill safeguard

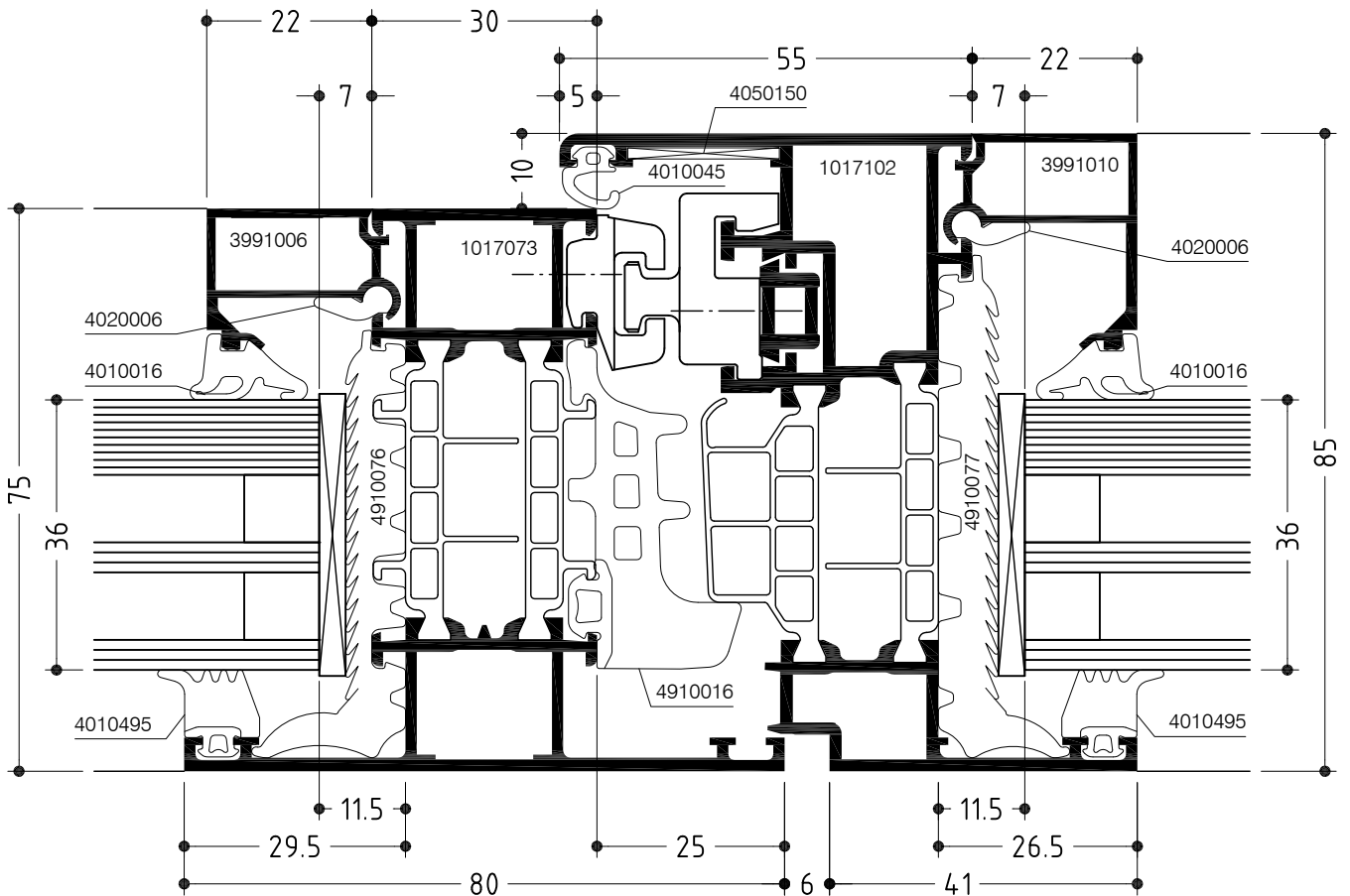
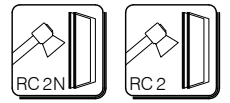
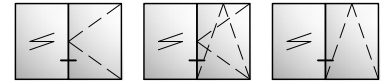

# WICLINE 75 TOP

Konstruktionsschnitt

Construction section

Flügelprofil im Blendrahmen mit Kämpfer, EH-Verriegelung /  
Füllungssicherung

Sash profile in frame with transom, burglar resistant locking / Infill safeguard

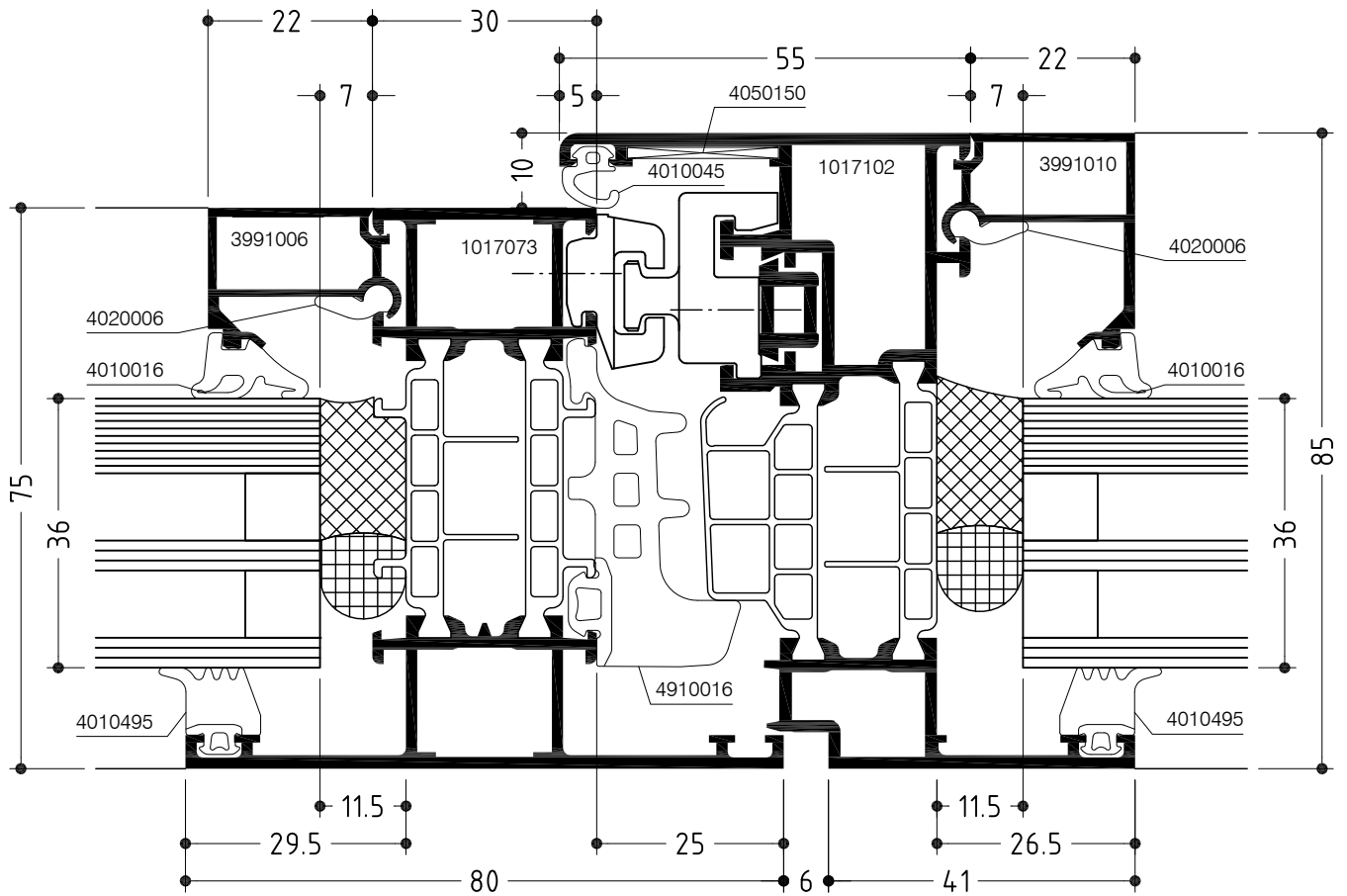
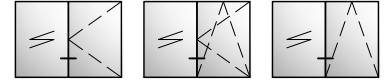

# WICLINE 75 TOP

Konstruktionsschnitt  
Construction section

Stulpfenster mit Aufsatzprofil - Mittelstoß  
EH-Verriegelung / Füllungssicherung  
Double casement window with supplm. profile - Meeting stiles  
Burglar resistant locking / Infill safeguard

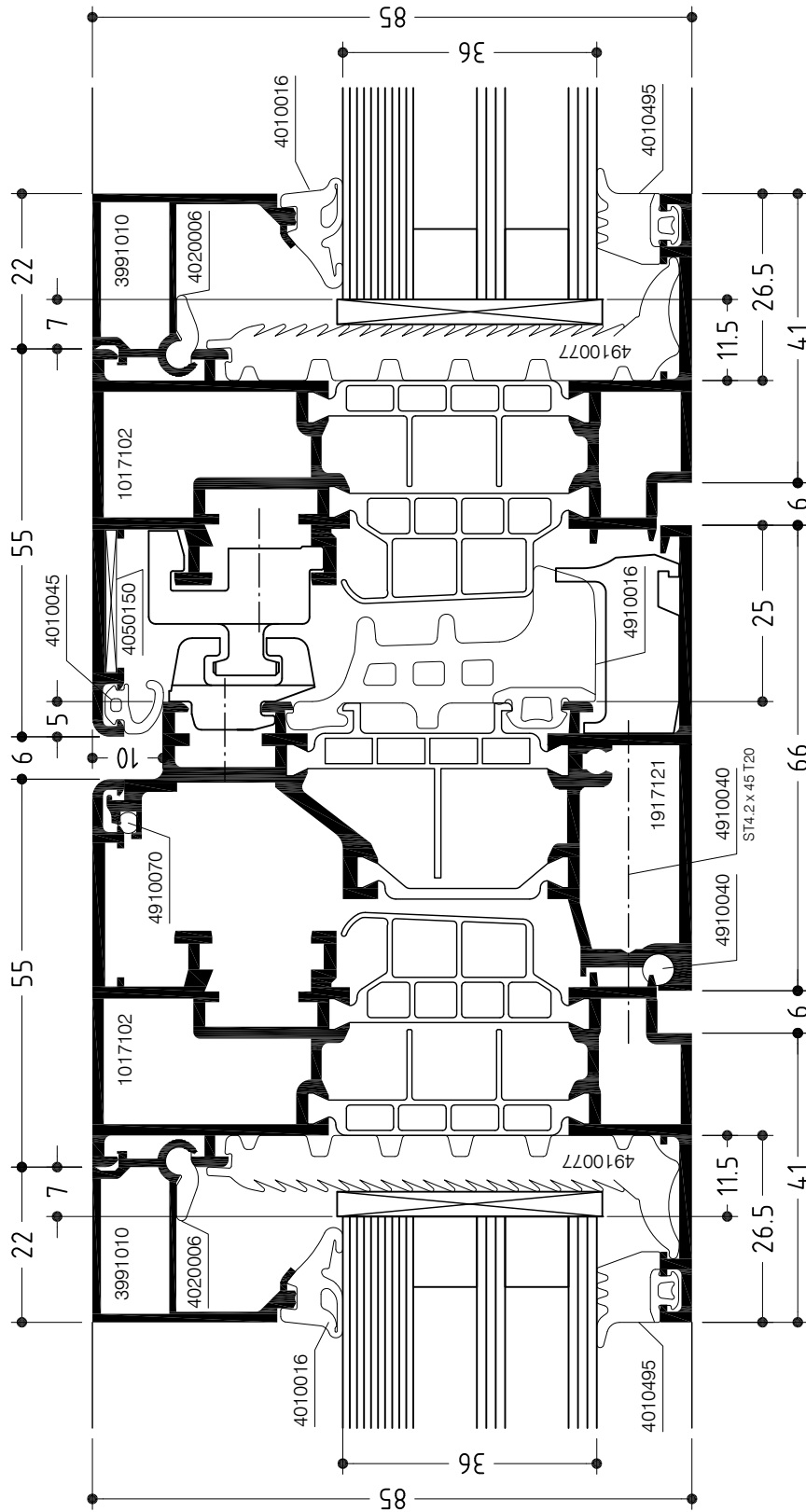
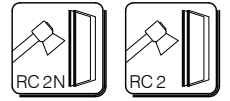
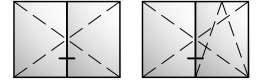

# WICLINE 75 TOP

Konstruktionsschnitt  
Construction section

Stulpfenster mit Aufsatzprofil - Mittelstoß  
EH-Verriegelung / Füllungssicherung  
Double casement window with supplm. profile - Meeting stiles  
Burglar resistant locking / Infill safeguard

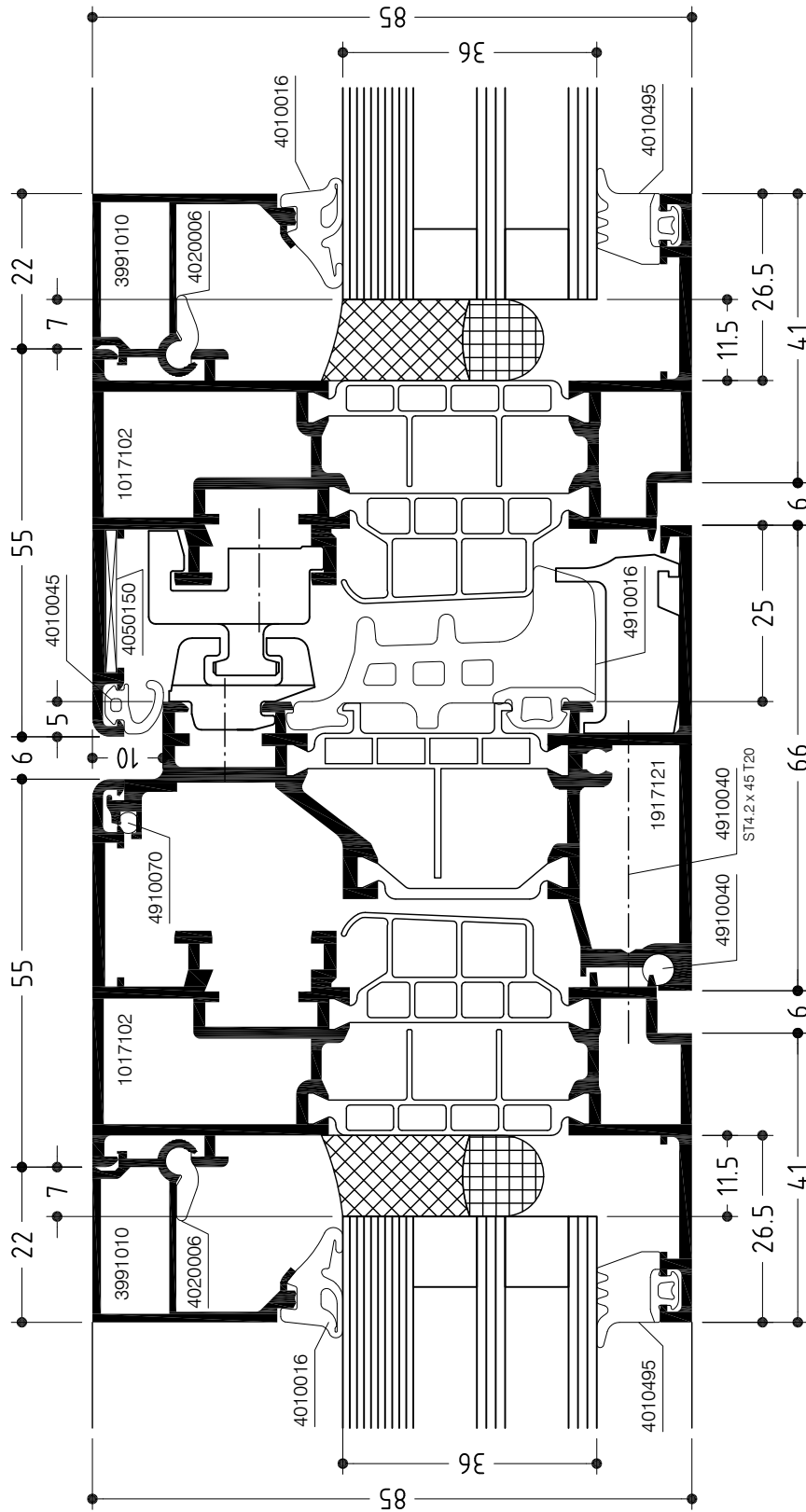
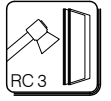
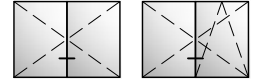



# WICLINE 75 TOP

Konstruktionsschnitt

Construction section

Flügelprofil im Blendrahmen mit Kämpfer, verdeckter Flügel

EH-Verriegelung / Füllungssicherung

Concealed sash in frame with transom

Burglar resistant locking / Infill safeguard

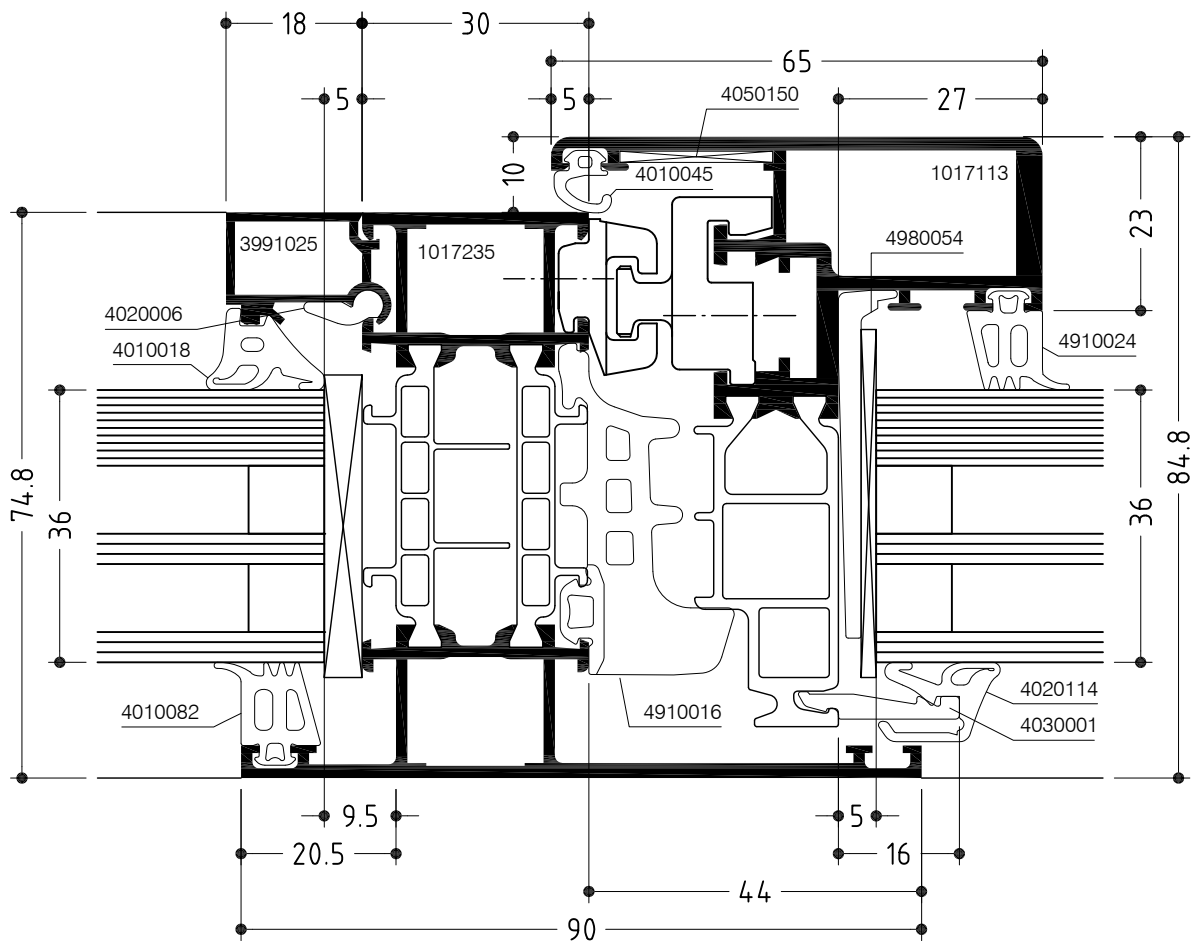
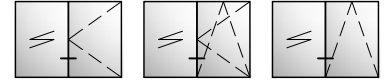

# WICLINE 75 TOP

Konstruktionsschnitt

Construction section

Flügelprofil im Blendrahmen mit Kämpfer, verdeckter Flügel

EH-Verriegelung / Füllungssicherung

Concealed sash in frame with transom

Burglar resistant locking / Infill safeguard

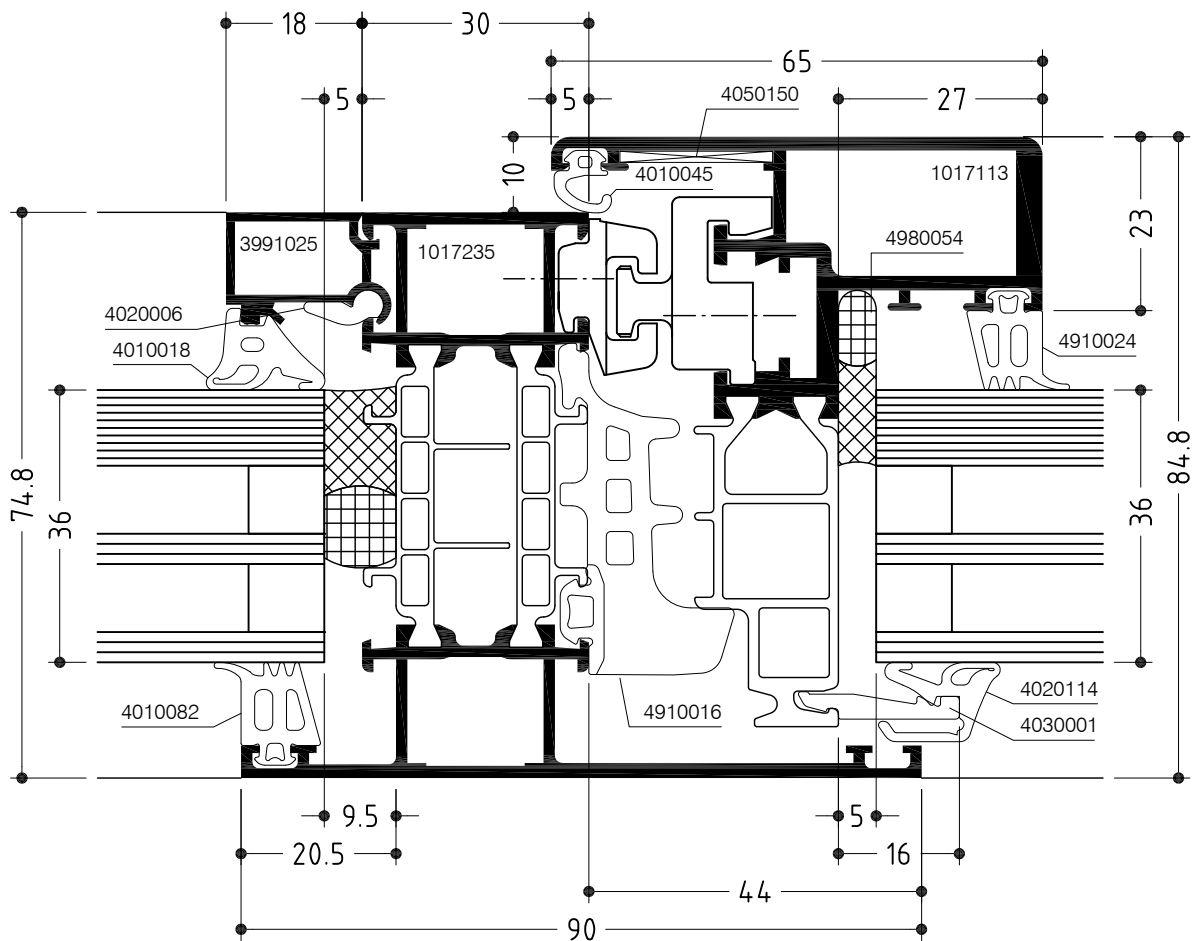
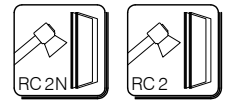
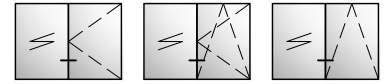

# WICLINE 75 TOP

Konstruktionsschnitt

Construction section

Flügelprofil im Blendrahmen mit Kämpfer, verdeckter Flügel

EH-Verriegelung / Füllungssicherung

Concealed sash in frame with transom

Burglar resistant locking / Infill safeguard

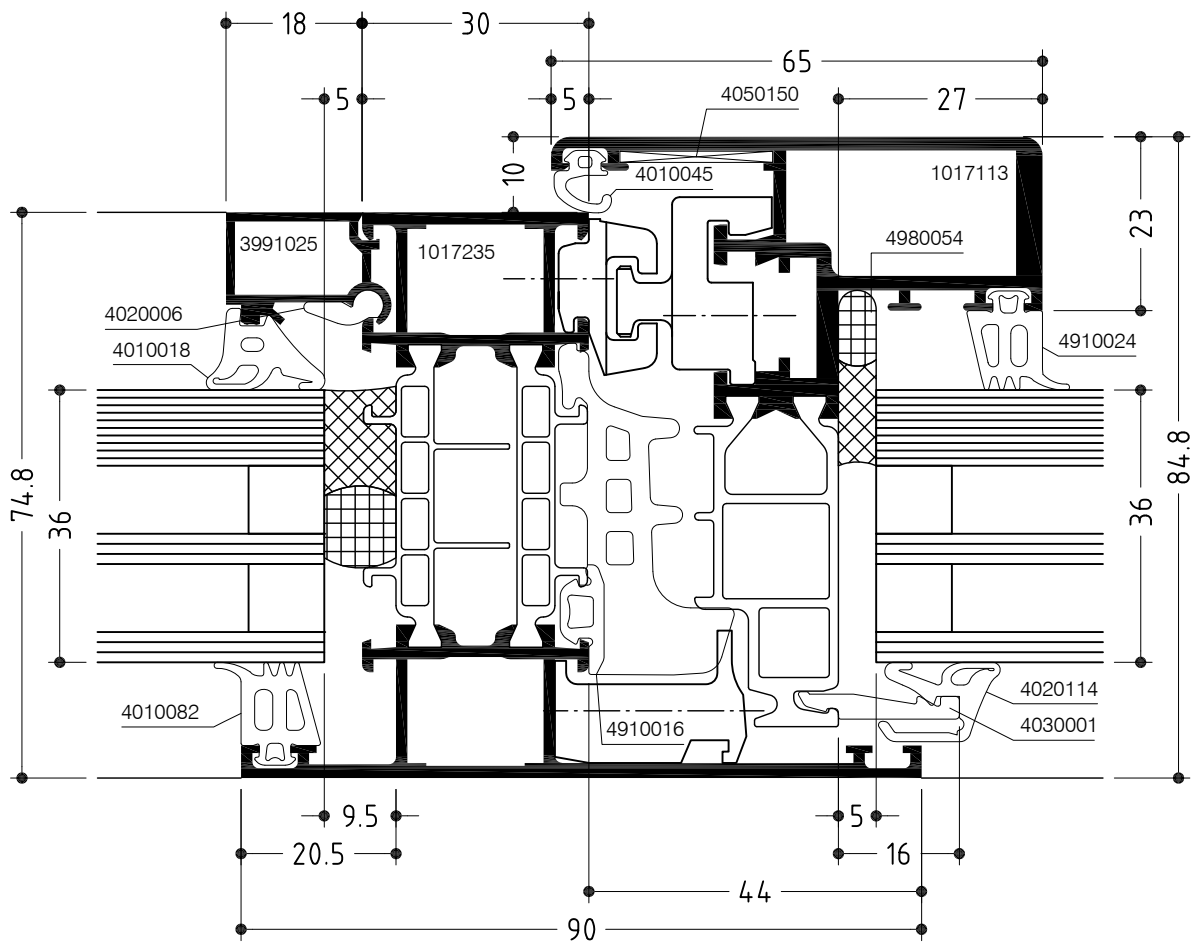
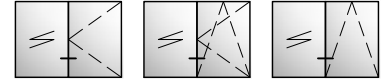



# WICLINE 75 TOP

Konstruktionsschnitt  
Construction section

Blendrahmen  
Festverglasung  
Frame profile  
Fixed glazing

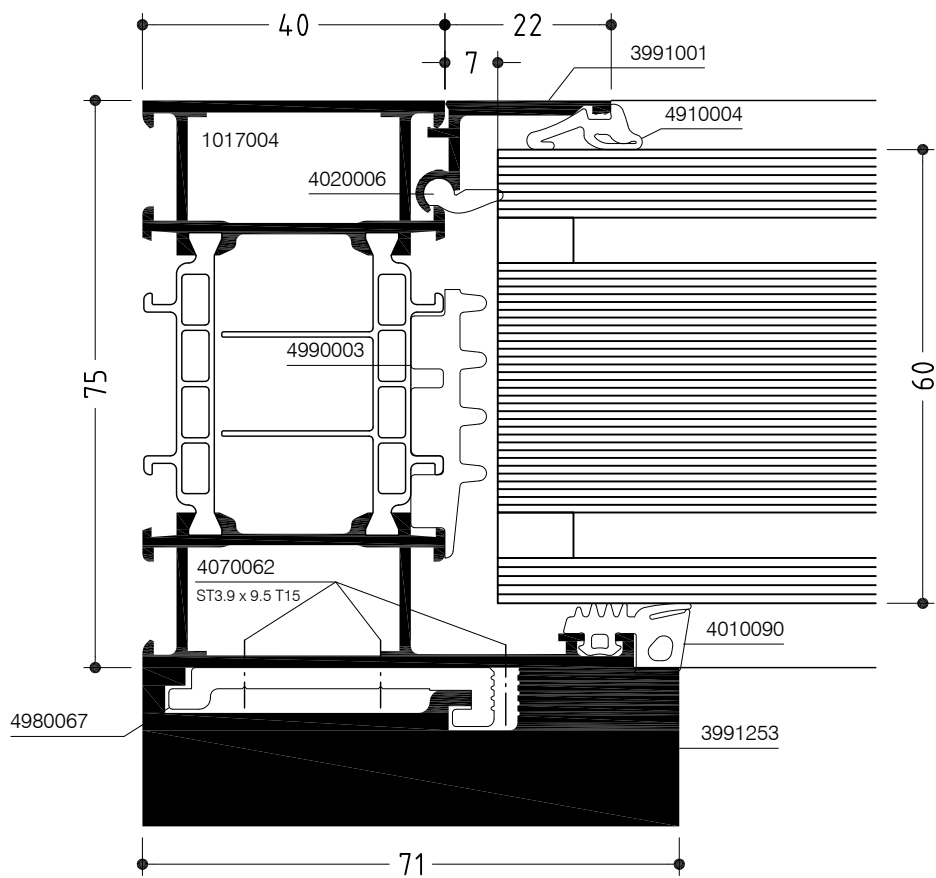

# WICLINE 75 TOP

Konstruktionsschnitt  
Construction section

Blendrahmen  
Fensterflügel  
Frame profile  
Window sash

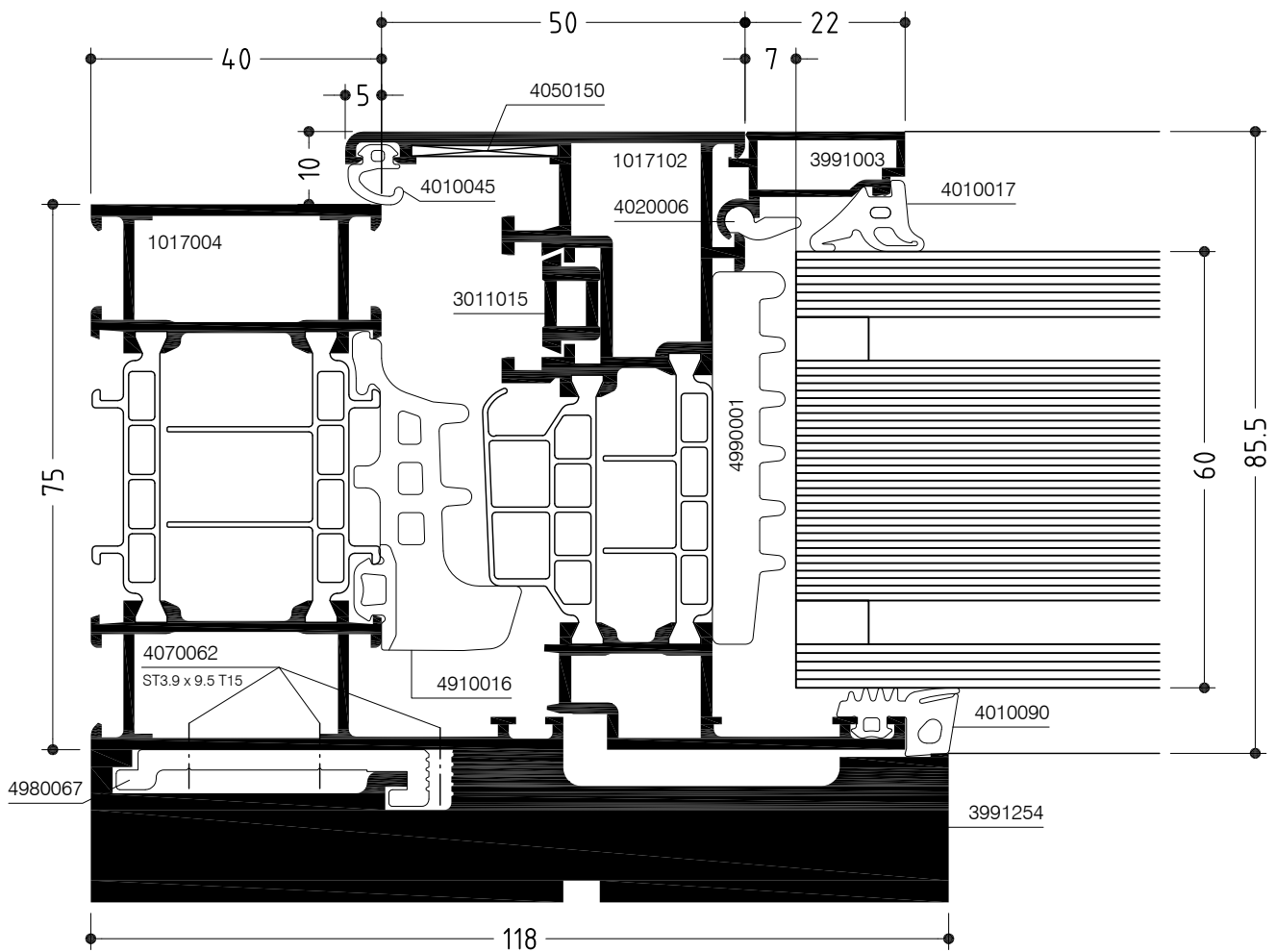

# WICLINE 75 TOP

Elementkopplung  
 Fensterflügel / Festverglasung  
 Unit coupling  
 Window sash / Fixed glazing

Konstruktionsschnitt  
 Construction section

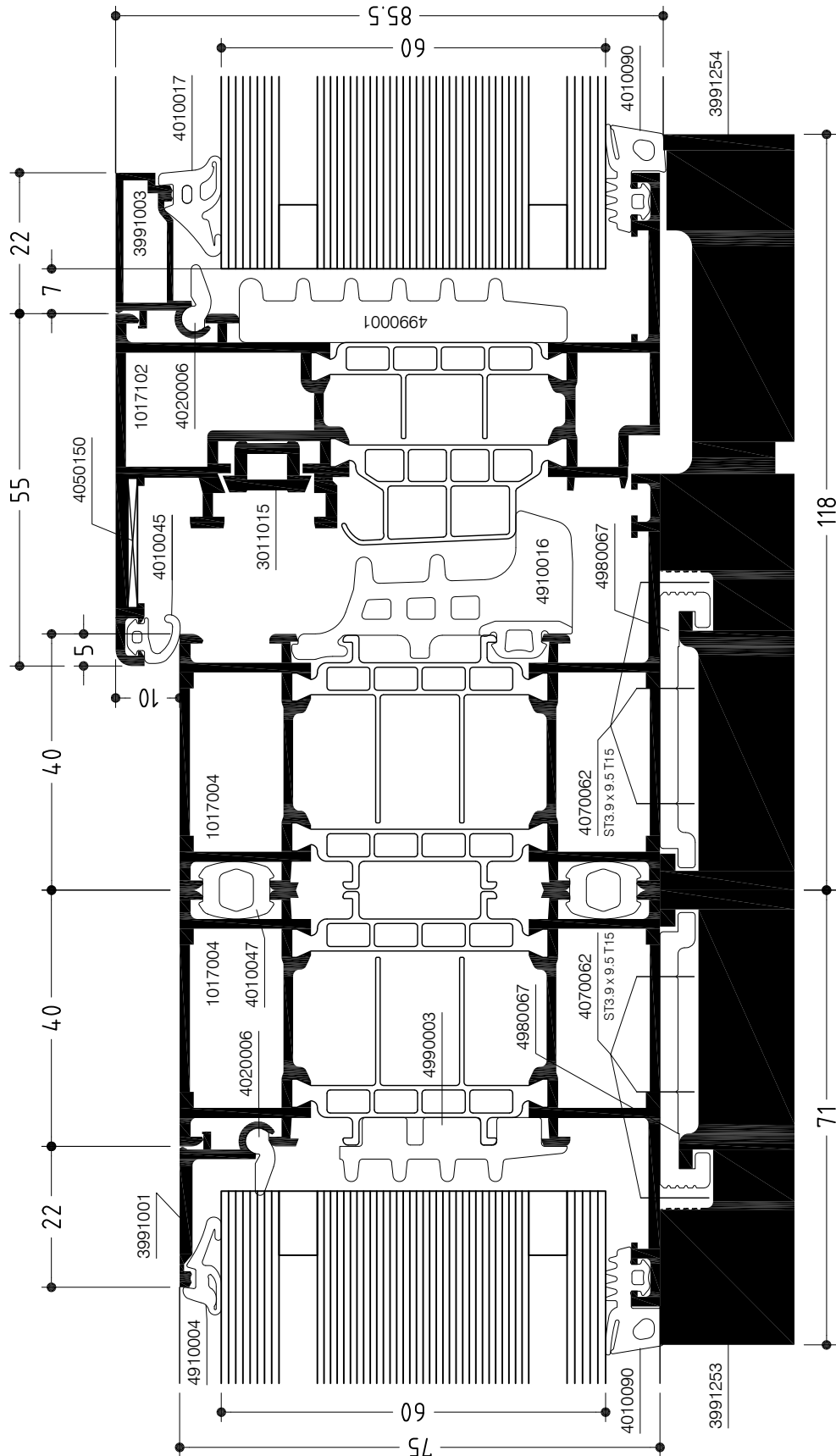
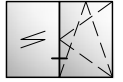

# WICLINE 75 TOP

Konstruktionsschnitt  
Construction section

Kämpferprofil  
Festverglasung  
Transom profile  
Fixed glazing

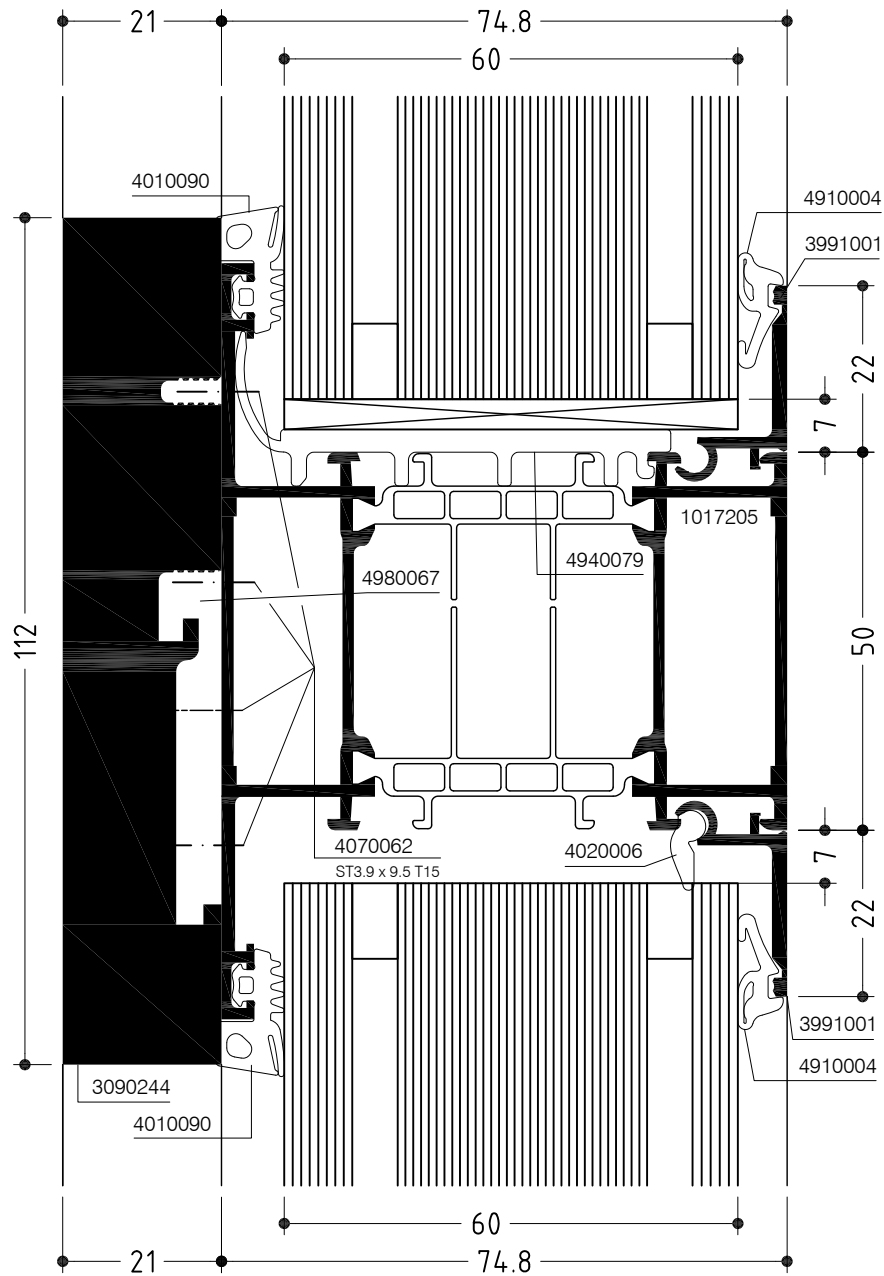
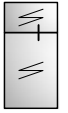







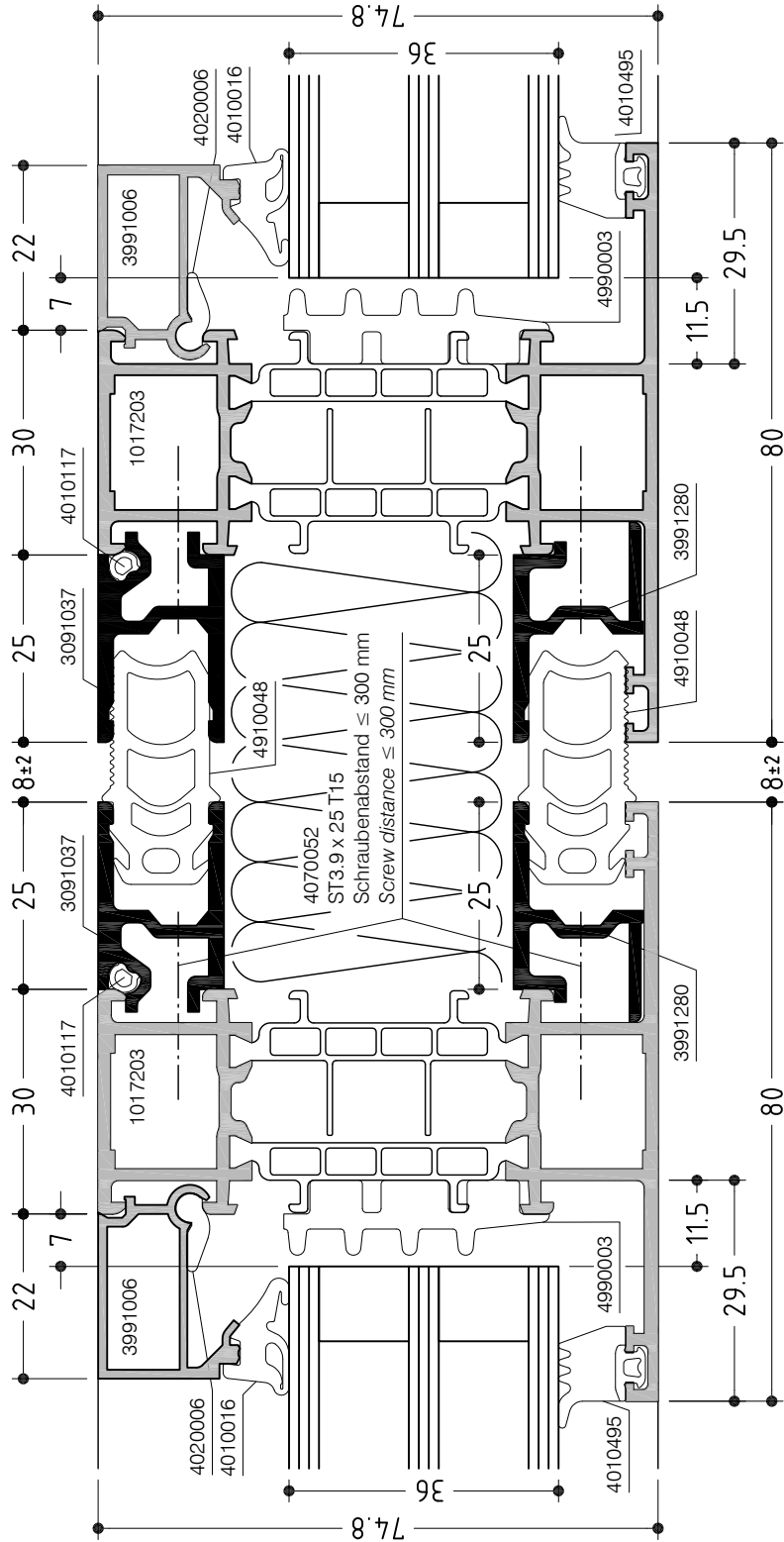
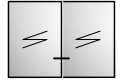

# WICLINE 75 TOP





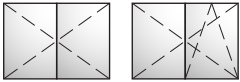
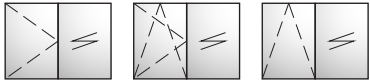

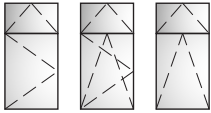
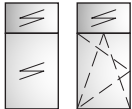
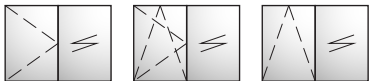
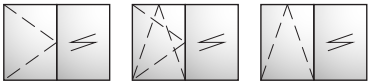
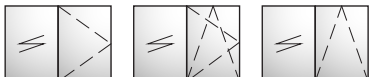

Zusatzprofil 3091037 und 3991280  
 Additional profile 3091037 and 3991280

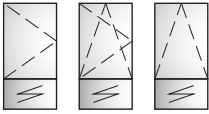
Konstruktionsschnitt  
 Construction section



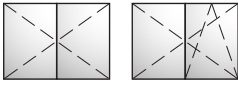
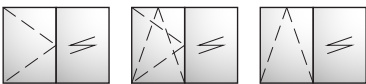

	Seite Page
<b>Symbole</b> <i>Symbols</i>	<b>204</b>
<b>Legende</b> <i>Legend</i>	<b>205</b>
<b>Übersicht der Öffnungsarten</b> <i>Survey of opening types</i>	<b>206</b>
<b>Standardflügel</b> <i>Standard sash</i>	<b>209</b>
	<b>209</b>
<b>Flügelprofil im Blendrahmen</b> <i>Sash profile in frame</i>	
	<b>213</b>
<b>Stulpfenster - Mittelstoß</b> <i>Double casement window - Meeting stiles</i>	
	<b>215</b>
<b>Flügelprofil im Blendrahmen mit Kämpfer</b> <i>Sash profile in frame with transom</i>	
	<b>216</b>
<b>Flügelprofil im Blendrahmen mit Sprossenprofil</b> <i>Sash profile in frame with crossbar profile</i>	
	<b>220</b>
<b>Festverglasung</b> <i>Fixed glazing</i>	
	<b>222</b>
<b>Flügelprofil im Dehnstoßblendrahmen</b> <i>Sash profile in expansion joint frame</i>	
	<b>226</b>
<b>Flügelprofil im Blendrahmen mit Kämpfer</b> <i>Sash profile in frame with transom</i>	
	<b>229</b>
<b>Kämpferprofil nach innen verstärkt</b> <i>Internally reinforced transom profile</i>	
	<b>231</b>
<b>Stützenprofile nach außen verstärkt</b> <i>Externally reinforced mullion profiles</i>	
	<b>235</b>
<b>Stützenprofile geteilt, nach außen verstärkt</b> <i>Externally reinforced split mullion profiles</i>	
	<b>237</b>
<b>Eckstützenprofile</b> <i>Corner mullion profiles</i>	

	Seite Page	
	<p><b>Kämpferprofil mit Plattenmontage von außen</b> <i>Transom profile with panel assembly from outside</i></p>	241
	<p><b>Flügelprofil im Blendrahmen mit Bauanschlussprofil</b> <i>Sash profile in frame with profile for junction to structure</i></p>	242
	<p><b>Flügelprofil im Einspannblendrahmen</b> <i>Sash profile in clamping frame</i></p>	243
	<p><b>Bauanschluss unten</b> <i>Bottom junction to structure</i></p>	247
	<p><b>Klassik-Design</b> <i>Classic design</i></p>	249
	<p><b>Flügelprofil im Blendrahmen</b> <i>Sash profile in frame</i></p>	249
	<p><b>Stulpfenster - Mittelstoß</b> <i>Double casement window - Meeting stiles</i></p>	253
	<p><b>Flügelprofil im Blendrahmen mit Kämpfer</b> <i>Sash profile in frame with transom</i></p>	255
	<p><b>Flügelprofil im Blendrahmen mit Sprossenprofil</b> <i>Sash profile in frame with crossbar profile</i></p>	257
	<p><b>Flügelprofil im Dehnstoßblendrahmen</b> <i>Sash profile in expansion joint frame</i></p>	260
	<p><b>Flügelprofil im Einspannblendrahmen</b> <i>Sash profile in clamping frame</i></p>	261
	<p><b>Bauanschluss unten</b> <i>Bottom junction to structure</i></p>	262

	Seite Page
	<b>263</b>
	<b>263</b>
	<b>269</b>
	<b>271</b>
	<b>276</b>
	<b>277</b>
	<b>278</b>
	<b>281</b>
	<b>283</b>
	<b>283</b>
	<b>291</b>
	<b>295</b>
	<b>307</b>
	<b>315</b>

**Verdeckter Flügel**  
*Concealed sash*



**Flügelprofil im Blendrahmen**  
*Sash profile in frame*

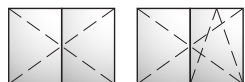

**Stulpfenster - Mittelstoß**  
*Double casement window - Meeting stiles*

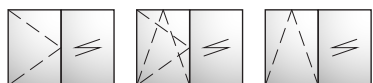

**Flügelprofil im Blendrahmen mit Kämpfer**  
*Sash profile in frame with transom*



**Festverglasung**  
*Fixed glazing*



**Flügelprofil im Dehnstoßblendrahmen**  
*Sash profile in expansion joint frame*



**Flügelprofil im Einspannblendrahmen**  
*Sash profile in clamping frame*



**Bauanschluss unten**  
*Bottom junction to structure*

**Sonderöffnungsarten**  
*Special openings*



**Senk-Klappfenster**  
*Italian style window*



**Klappfenster**  
*Top-hung window*

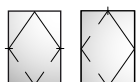

**Schwing-Wende-Fenster**  
*Horizontal/vertical pivot window*



**Fenstertür**  
*Casement door*



**Parallel-Schiebe-Kipp-Fenster**  
*Parallel sliding tilt window*

	Seite Page
	<b>325</b>
	<b>325</b>
	<b>327</b>
	<b>329</b>
	<b>330</b>
	<b>333</b>
	<b>333</b>
	<b>334</b>
	<b>335</b>
	<b>336</b>
	<b>337</b>
	<b>338</b>

**Einbruchhemmung**  
*Burglar resistance*

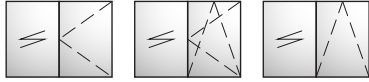

**Flügelprofil im Blendrahmen mit Kämpfer**  
*Sash profile in frame with transom*

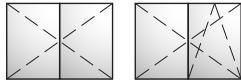

**Stulpfenster - Mittelstoß**  
*Double casement window - Meeting stiles*

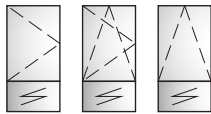

**Flügelprofil im Blendrahmen mit Kämpfer, Klassik-Design**  
*Sash profile in frame with transom, Classic design*

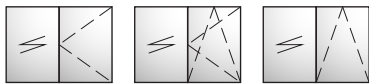

**Flügelprofil im Blendrahmen mit Kämpfer, verdeckter Flügel**  
*Concealed sash in frame with transom*

**Durchschusshemmung**  
*Bullet resistance*



**Blendrahmen Festverglasung**  
*Frame profile fixed glazing*

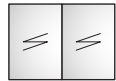

**Elementkopplung Festverglasung**  
*Unit coupling fixed glazing*



**Blendrahmen Fensterflügel**  
*Frame profile window sash*

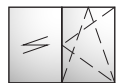



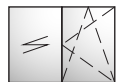

**Elementkopplung Fensterflügel / Festverglasung**  
*Unit coupling window sash / fixed glazing*









**Elementkopplung Fensterflügel**  
*Unit coupling window sash*

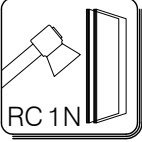

**Kämpferprofil Festverglasung**  
*Transom profile fixed glazing*

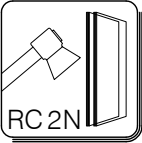
	Seite Page
<b>Hochwärmedämmend</b> <i>High insulated</i>	<b>341</b>
	
<b>Flügelprofil im Blendrahmen mit Spezial-Dämmprofil</b> <i>Sash profile in frame with special insulation profile</i>	<b>341</b>
	
<b>Kämpferprofil mit Festverglasung und Spezial-Dämmprofil</b> <i>Transom profile with fixed glazing and special insulation profile</i>	<b>344</b>
	
<b>Festverglasung mit Spezial-Dämmprofil</b> <i>Fixed glazing with special insulation profile</i>	<b>348</b>
 <b>MINERGIE-P®</b> <i>MINERGIE-P®</i>	 <b>349</b>
	
<b>Flügelprofil im Spezialblendrahmen</b> <i>Sash profile in special frame</i>	<b>349</b>
	
<b>Stulpfenster - Mittelstoß</b> <i>Double casement window - Meeting stiles</i>	<b>351</b>
 <b>Zusatzprofile</b> <i>Additional profiles</i>	 <b>353</b>
<b>3091036 / 3991215 / 3991216 / 3991217</b>	<b>353</b>
<b>3091031 / 3991234</b>	<b>354</b>
<b>160747 / 3091057</b>	<b>355</b>
<b>3091055 / 3091057</b>	<b>356</b>
<b>3091037 / 3991280</b>	<b>357</b>
<b>3091056</b>	<b>358</b>
<b>3991237</b>	<b>359</b>
<b>3091044 / 3091054</b>	<b>360</b>
<b>3091045</b>	<b>361</b>
<b>3091039 / 3091040</b>	<b>362</b>
<b>3091049 / 3091050</b>	<b>363</b>
<b>3091048 / 3091051</b>	<b>364</b>
<b>3091046 / 3091047</b>	<b>365</b>
<b>3091058 / 3091059</b>	<b>366</b>
<b>3091041 / 3091042</b>	<b>367</b>

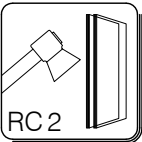
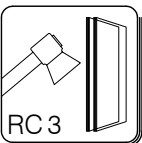
Symbole  
Symbols







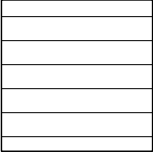
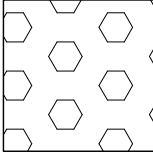
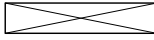
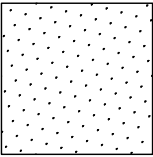
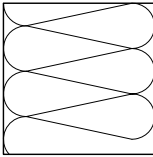
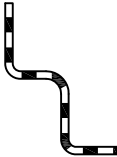
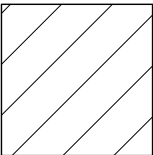
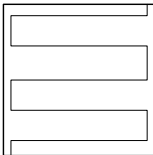
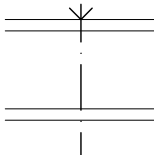
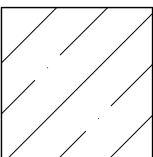
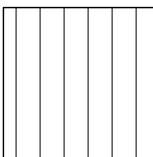
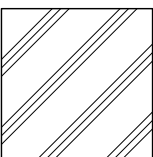
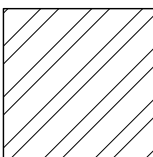
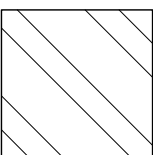
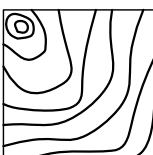
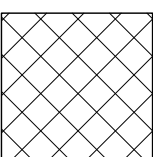
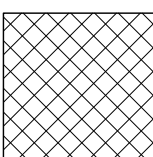
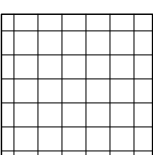
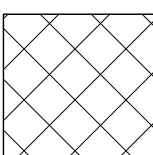



























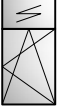

Symbol	Bezeichnung	Symbol	Bezeichnung
Symbols	Designation	Symbols	Designation
	Einbruchhemmung RC 1 N nach DIN EN 1627:2011  <i>Burglary resistance RC 1 N according to DIN EN 1627:2011</i>		barrierefrei  <i>barrier-free</i>
	Einbruchhemmung RC 2 N nach DIN EN 1627:2011  <i>Burglary resistance RC 2 N according to DIN EN 1627:2011</i>		Darstellung 90° gedreht  <i>Representation turned by 90°</i>
	Einbruchhemmung RC 2 nach DIN EN 1627:2011  <i>Burglary resistance RC 2 according to DIN EN 1627:2011</i>		
	Einbruchhemmung RC 3 nach DIN EN 1627:2011  <i>Burglary resistance RC 3 according to DIN EN 1627:2011</i>		
	Durchschusshemmung nach EN 1522  <i>Bullet resistance according to EN 1522</i>		



















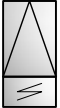

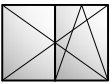
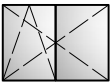
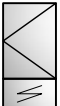
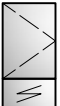
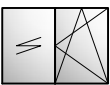
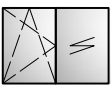

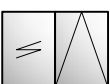
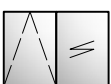

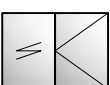
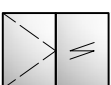

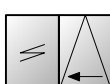
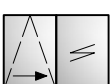
### Legende Legend

Muster <i>Swatch</i>	Bezeichnung <i>Designation</i>	Muster <i>Swatch</i>	Bezeichnung <i>Designation</i>	Muster <i>Swatch</i>	Bezeichnung <i>Designation</i>
	Streifen <i>Strip</i>		Lochblech <i>Perforated sheet</i>		Trag- bzw. Distanzklotz (Polyäthylen o. glw.) <i>Supporting or distance shim (Polyethylene or equivalent)</i>
	Putz <i>Plaster</i>		Wärmedämmung (alt) <i>Heat insulated (old)</i>		Dichtbahn (Dampfsperre, Dichtstreifen) <i>Sealing web (vapour barrier / sealing strips)</i>
	Mauerwerk <i>Wall</i>		Wärmedämmung <i>Heat insulated</i>		Verschraubung <i>Screwing</i>
	Beton <i>Concrete</i>		Keramik <i>Ceramics</i>		
	Steinplatten <i>Stone slabs</i>		Stahl <i>Steel</i>		
	Naturstein <i>Natural stone</i>		Holz <i>Wood</i>		
	Dauerelastische Dichtungsmasse <i>Permanently elastic sealing compound</i>		Imprägniertes Dichtband <i>Impregnated sealing strap</i>		
	Hinterfüllschnur <i>Back-filling cord</i>		Hartschaum Wärmedämmung <i>Hard foam Heat insulated</i>		

### Öffnungsarten Opening types

Ansicht von Innen <i>Inner view</i>	Bezeichnung <i>Designation</i>	Ansicht von Außen <i>Outer view</i>	Ansicht von Innen <i>Inner view</i>	Bezeichnung <i>Designation</i>	Ansicht von Außen <i>Outer view</i>
	Festverglasung <i>Fixed glazing</i>			Senk - Klapp - Fenster <i>Italian style window</i>	
	Photovoltaik <i>Photovoltaic</i>			Klapp - Fenster <i>Top-hung window</i>	
	Kipp - Fenster <i>Tilt window</i>			Schwing - Fenster <i>Horizontal pivot window</i>	
	Dreh - Fenster <i>Turn window</i>			Wende - Fenster <i>Vertical pivot window</i>	
	Drehkipp - Fenster <i>Turn/tilt window</i>			Parallel - Ausstellfenster <i>Parallel opening window</i>	
	Festverglasung mit Oberlicht <i>Fixed glazing with fanlight</i>			Rundbogen - Festverglasung <i>Semi-circular arch fixed glazing</i>	
	Drehkipp - Fenster mit Oberlicht <i>Turn/tilt window with fanlight</i>			Schräg - Festverglasung <i>Sloped fixed glazing</i>	
	Festverglasung mit Oberlicht Kippflügel <i>Fixed glazing with tilt window fanlight</i>			Rundbogen - Drehkipp - Fenster <i>Semi-circular arch turn/tilt window</i>	
	Drehkipp - Fenster mit Oberlicht Kippfenster <i>Turn/tilt window with tilt window fanlight</i>			Schräg - Drehkipp - Fenster <i>Sloped turn/tilt window</i>	

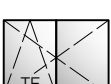
### Öffnungsarten Opening types

Ansicht von Innen <i>Inner view</i>	Bezeichnung <i>Designation</i>	Ansicht von Außen <i>Outer view</i>	Ansicht von Innen <i>Inner view</i>	Bezeichnung <i>Designation</i>	Ansicht von Außen <i>Outer view</i>
	Stichbogen - Drehkipp - Fenster <i>Segmental arch turn/tilt window</i>			Drehkipp - Fenster; Tilt-First Ausführung <i>Turn/tilt window. Type: Tilt-First</i>	
	Segment - Drehkipp - Fenster <i>Segmental turn/tilt window</i>			Kipp - Fenster mit Unterlicht <i>Tilt window with sublight</i>	
	Stulp - Fenster oder 2 - flügeliges Fenster mit Kämpfer <i>Double casement window or double sash window with transom</i>			Dreh - Fenster mit Unterlicht <i>Turn window with sublight</i>	
	Drehkipp - Fenster mit Festverglasung <i>Turn/tilt window with fixed glazing</i>			Drehkipp - Fenster mit Unterlicht <i>Turn/tilt window with sublight</i>	
	Kipp - Fenster mit Festverglasung <i>Tilt window with fixed glazing</i>			Festverglasung mit Sprosse <i>Fixed glazing with glazing bars</i>	
	Dreh - Fenster mit Festverglasung <i>Turn window with fixed glazing</i>			Kippfenster - Sprossenfenster <i>Tilt window with glazing bars</i>	
	Parallel - Schiebe - Kipp - Fenster <i>Parallel sliding tilt window</i>			Drehfenster - Sprossenfenster <i>Turn window with glazing bars</i>	
	Stulp - Fenster oder 2 - flügeliges Fenster mit Kämpfer <i>Double casement window or double sash window with transom</i>			Drehkipp - Sprossenfenster <i>Turn/tilt window with glazing bars</i>	
	Stulp - Fenster oder 2 - flügeliges Fenster mit Kämpfer; Tilt-First Ausführung <i>Double casement window or double sash window with transom. Type: Tilt-First</i>			Fenstertür, barrierefrei <i>Casement door, accessible</i>	



# WICLINE 75

Flügelprofil im Blendrahmen  
Sash profile in frame

Konstruktionsschnitt  
Construction section

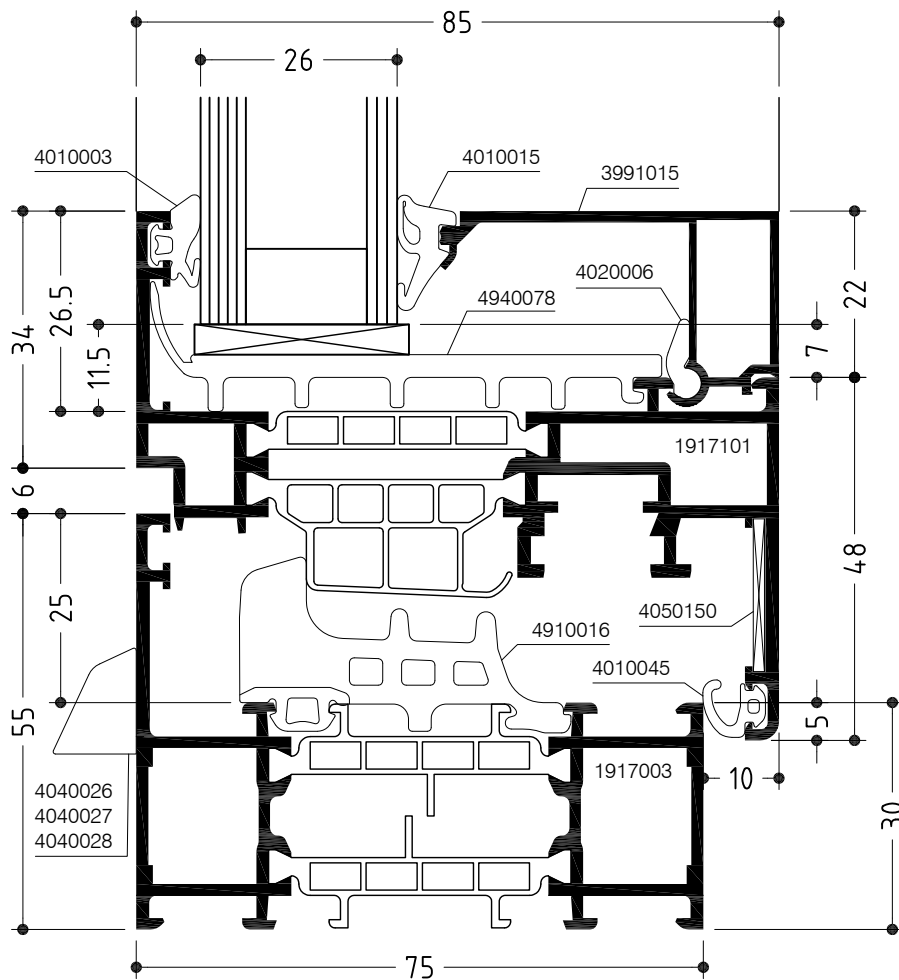



# WICLINE 75

Konstruktionsschnitt

Construction section

Flügelprofil im Blendrahmen mit Spezial-Dämmprofil

Sash profile in frame with special insulation profile

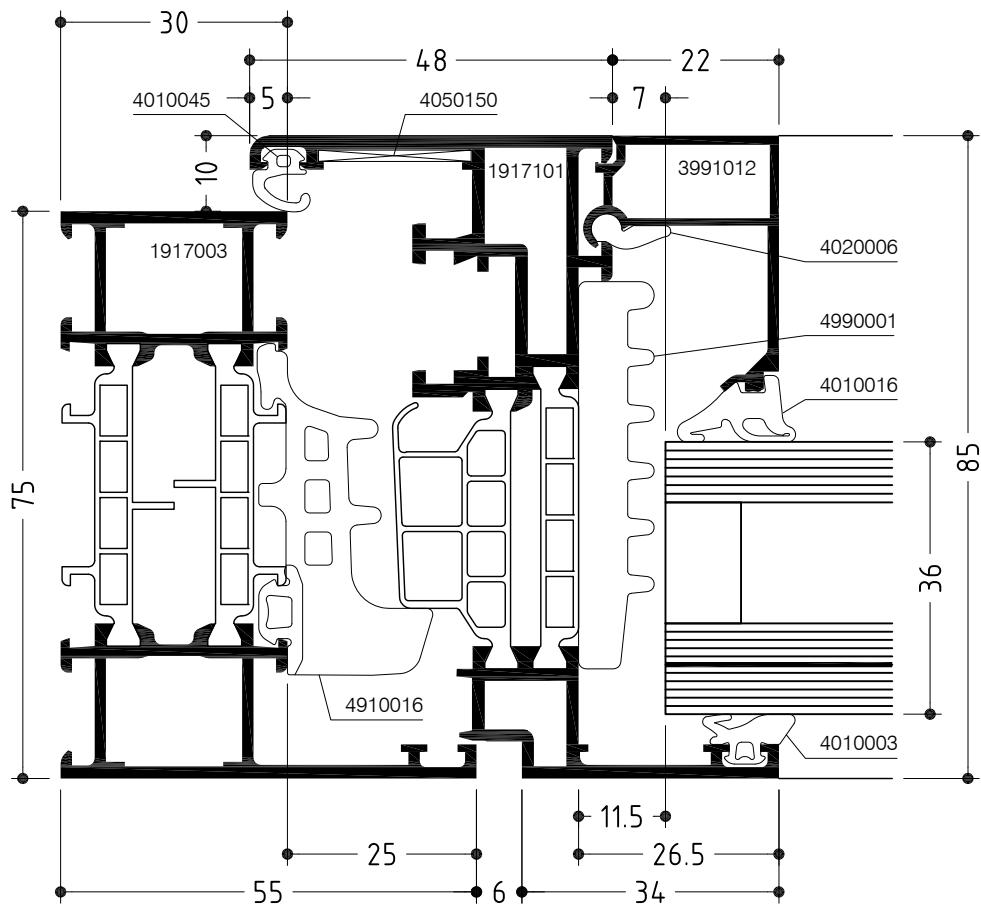

# WICLINE 75

Verdeckte Entwässerung mit Spezial-Dämmprofil  
Concealed drainage with special insulation profile

Konstruktionsschnitt  
Construction section

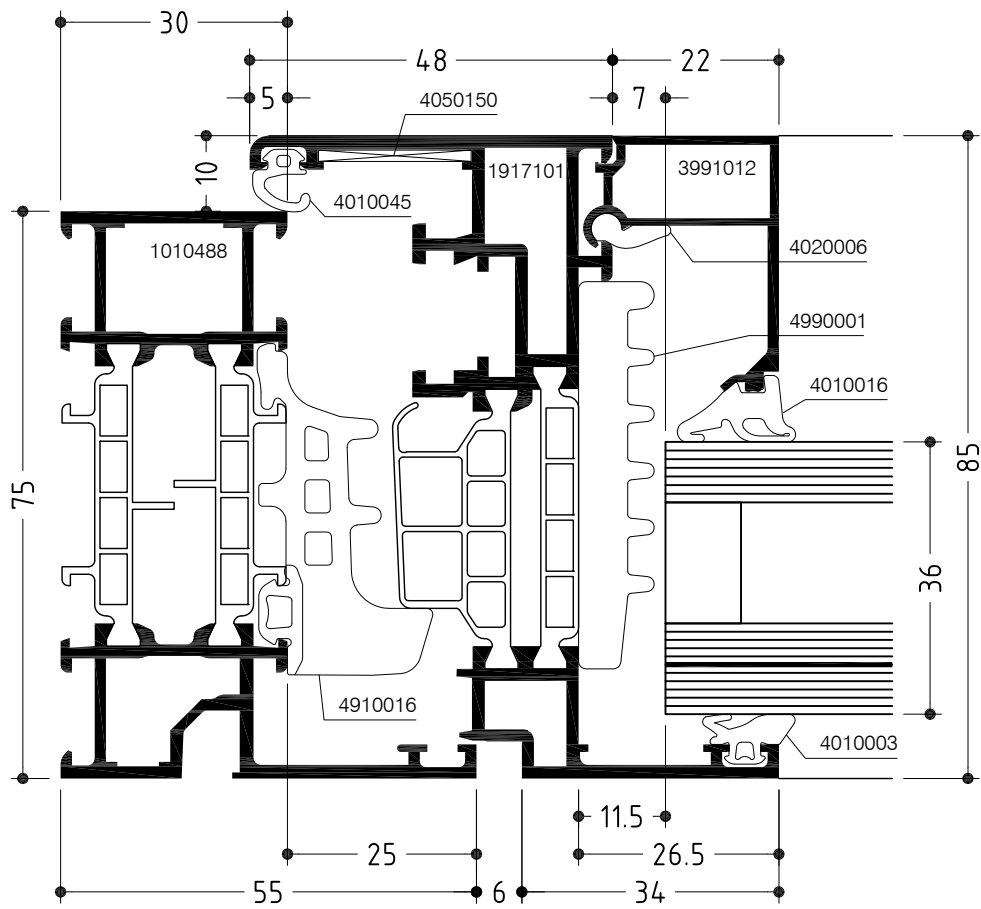



# WICLINE 75

Stulpfenster - Mittelstoß  
Double casement window - Meeting stiles

Konstruktionsschnitt  
Construction section

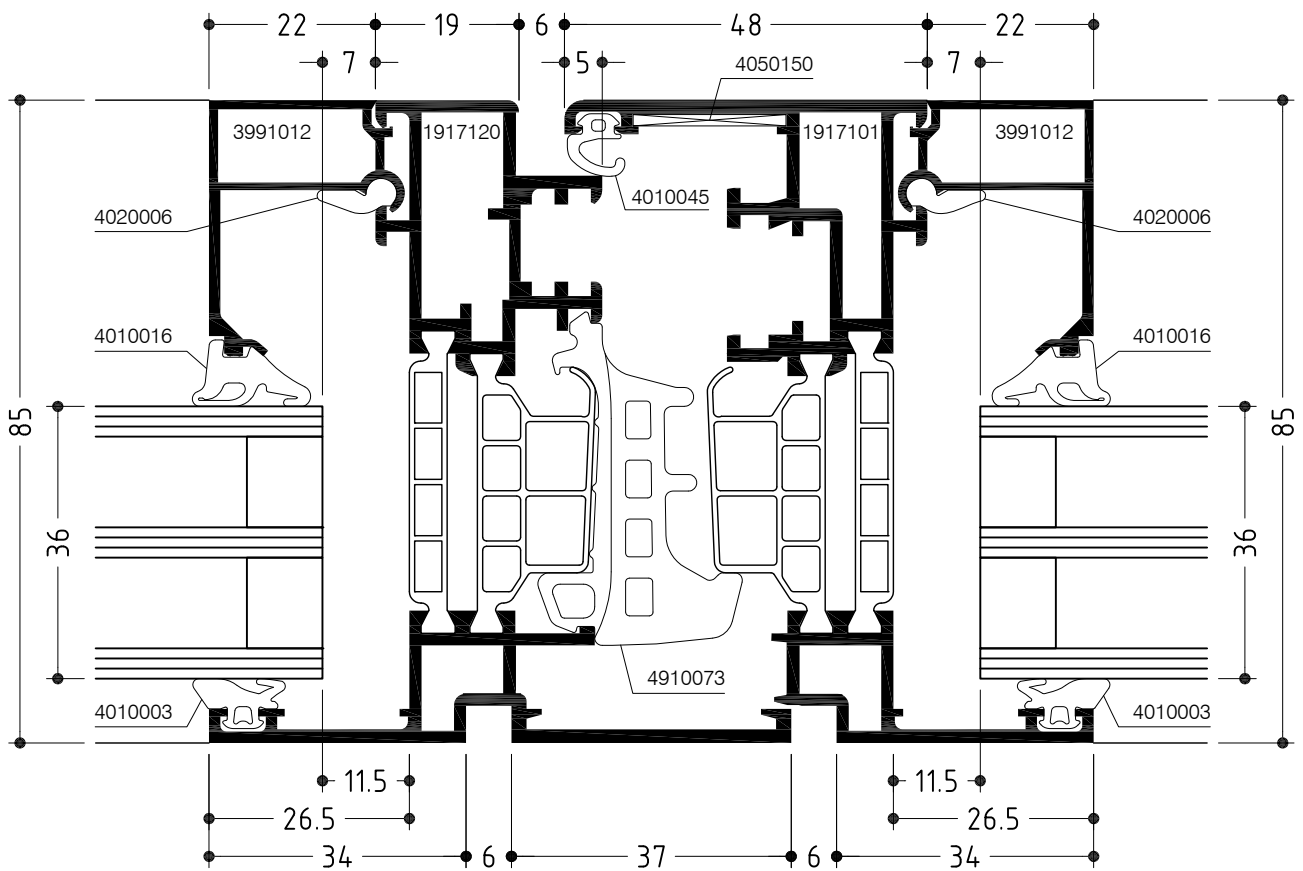
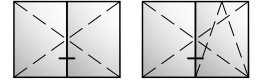

# WICLINE 75

Stulpfenster mit Aufsatzprofil - Mittelstoß  
 Double casement window with supplm. profile - Meeting stiles

Konstruktionsschnitt  
 Construction section

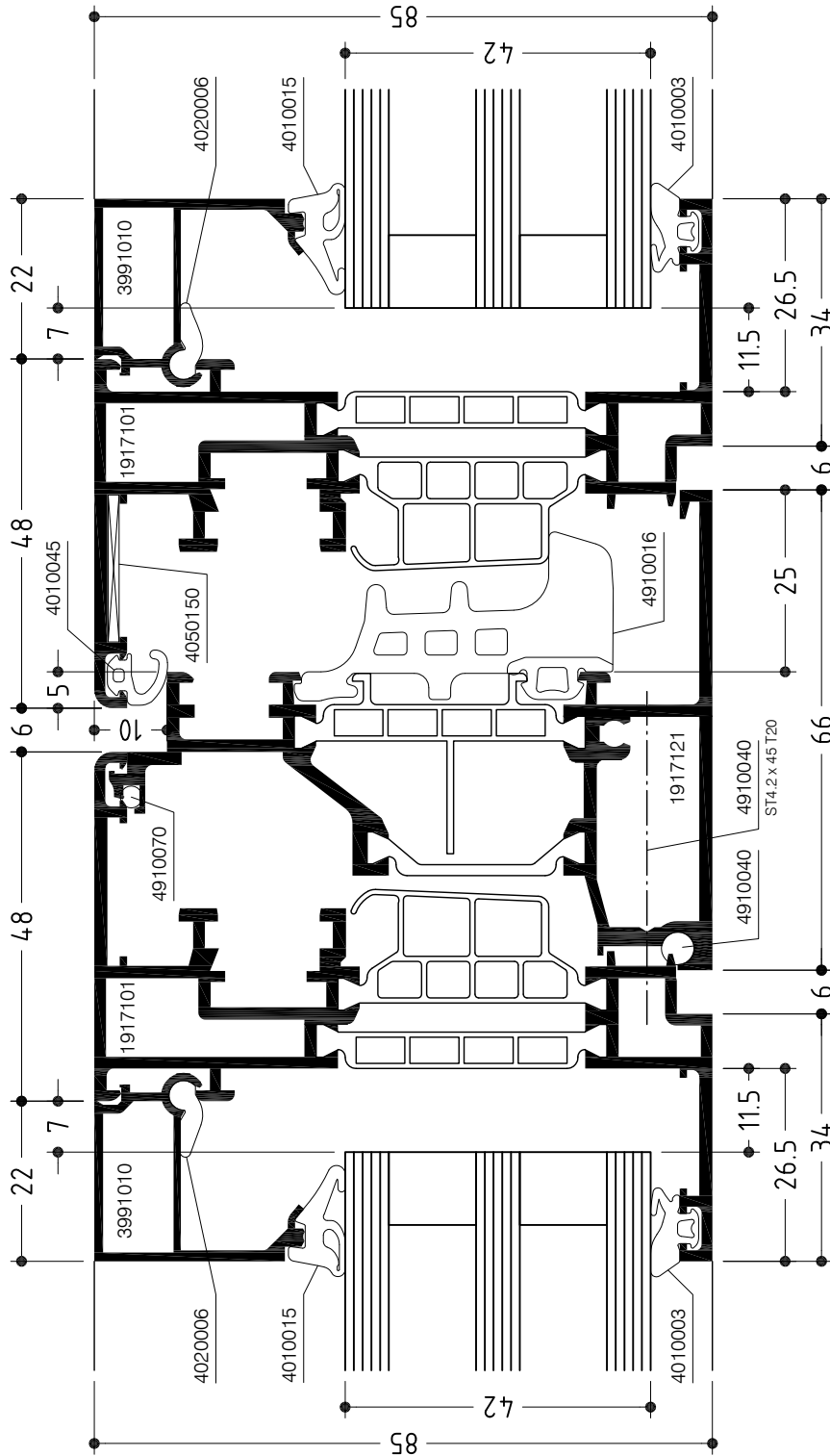
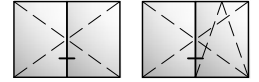

# WICLINE 75

Flügelprofil im Blendrahmen mit Kämpfer  
Sash profile in frame with transom

Konstruktionsschnitt  
Construction section

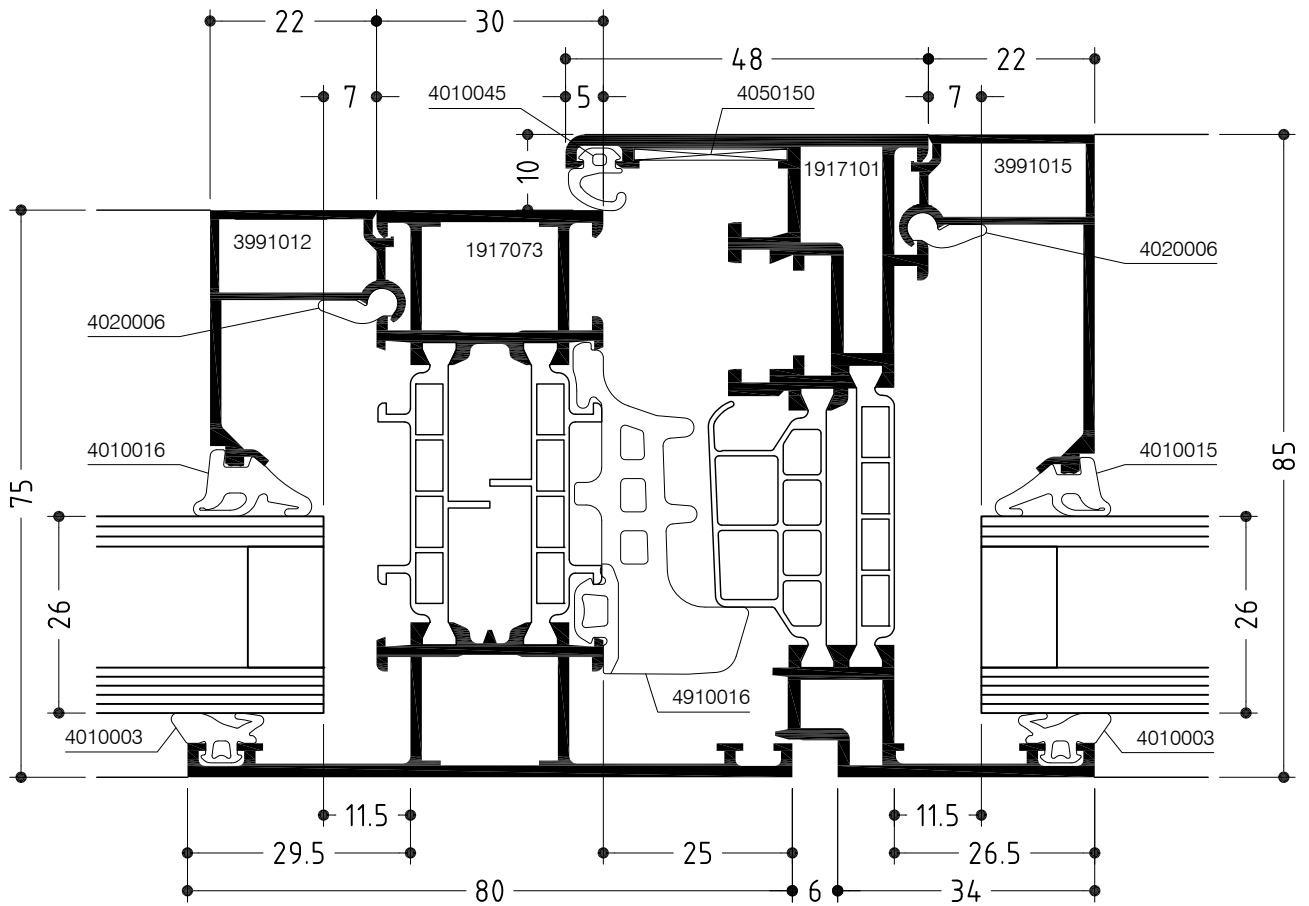
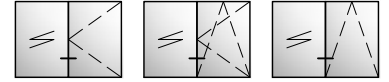



# WICLINE 75

Festverglasung mit Sprossenprofil  
Fixed glazing with glazing bar profile

Konstruktionsschnitt  
Construction section

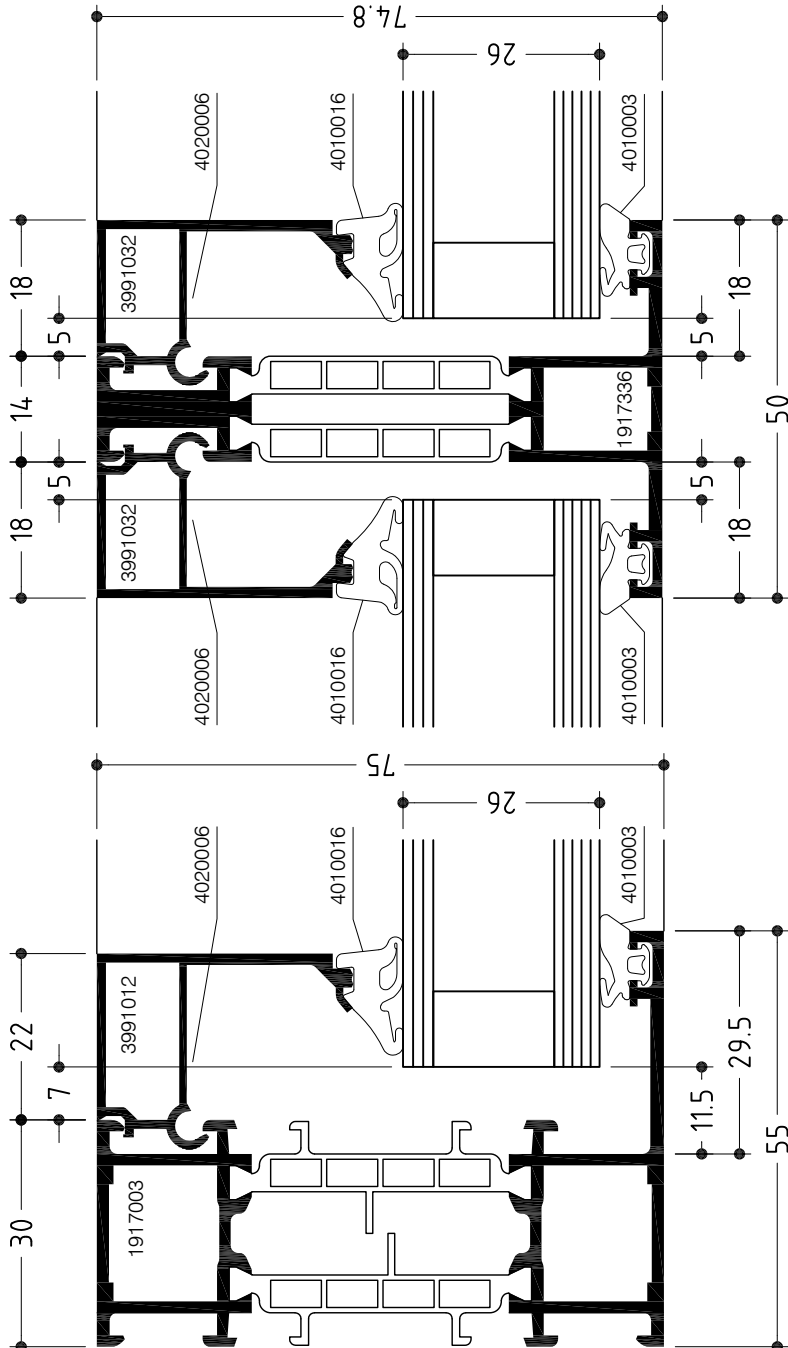

# WICLINE 75

Verdeckte Entwässerung, Festverglasung mit Sprossenprofil  
Concealed drainage, fixed glazing with glazing bar profile

Konstruktionsschnitt  
Construction section

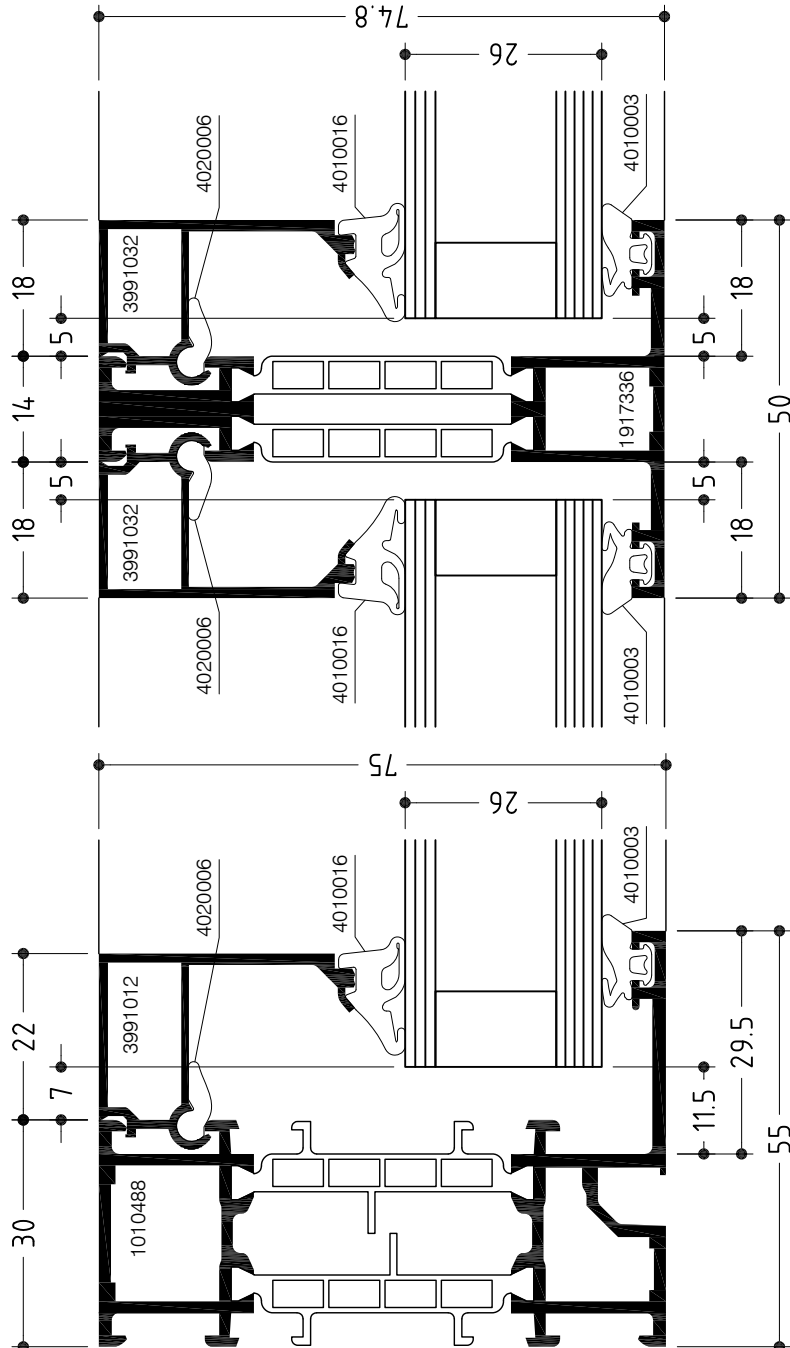

# WICLINE 75

Flügelprofil im Blendrahmen mit Ziersprossenprofil  
Sash profile in frame with glazing bar profile

Konstruktionsschnitt  
Construction section

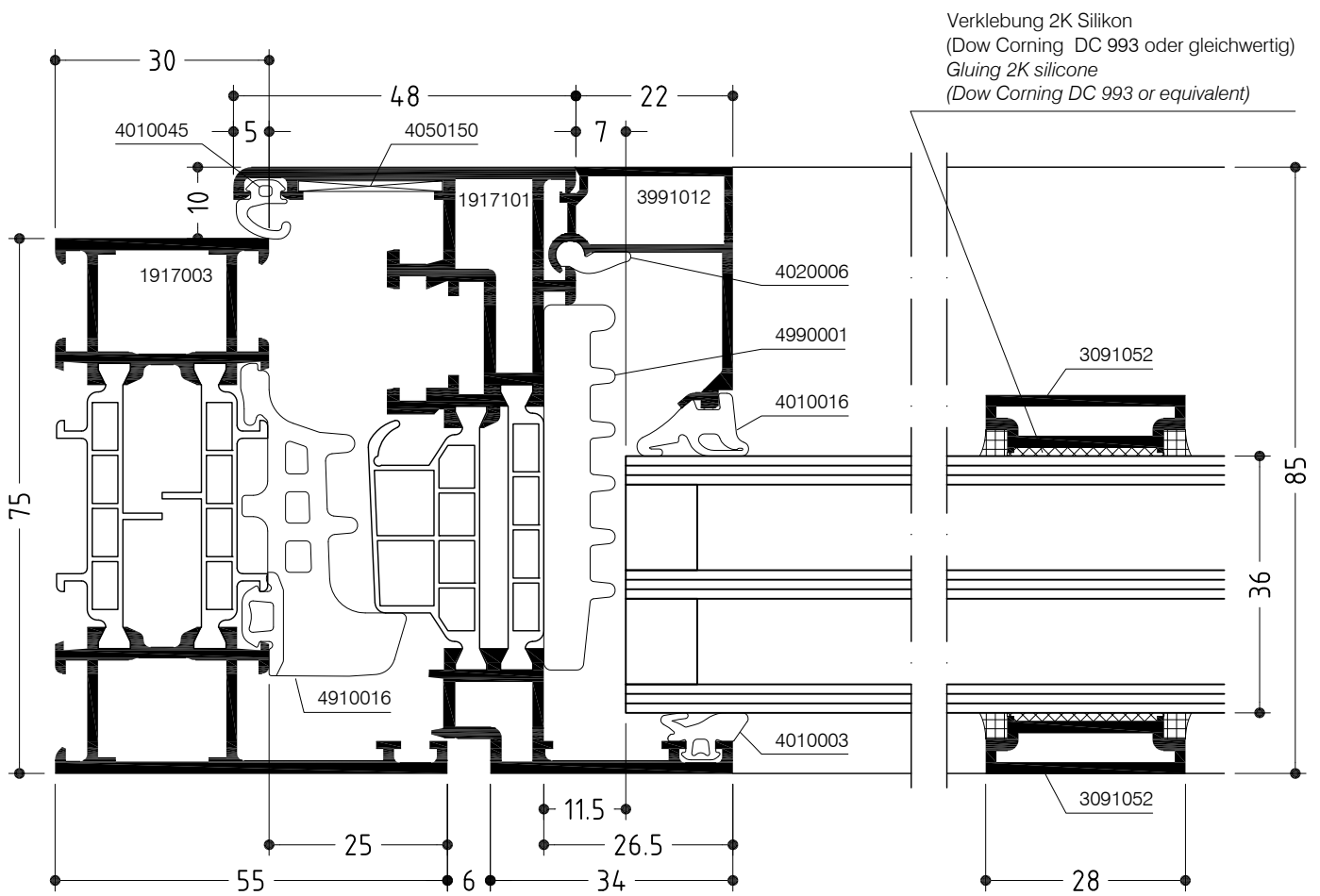

# WICLINE 75

Festverglasung  
Fixed glazing

Konstruktionsschnitt  
Construction section

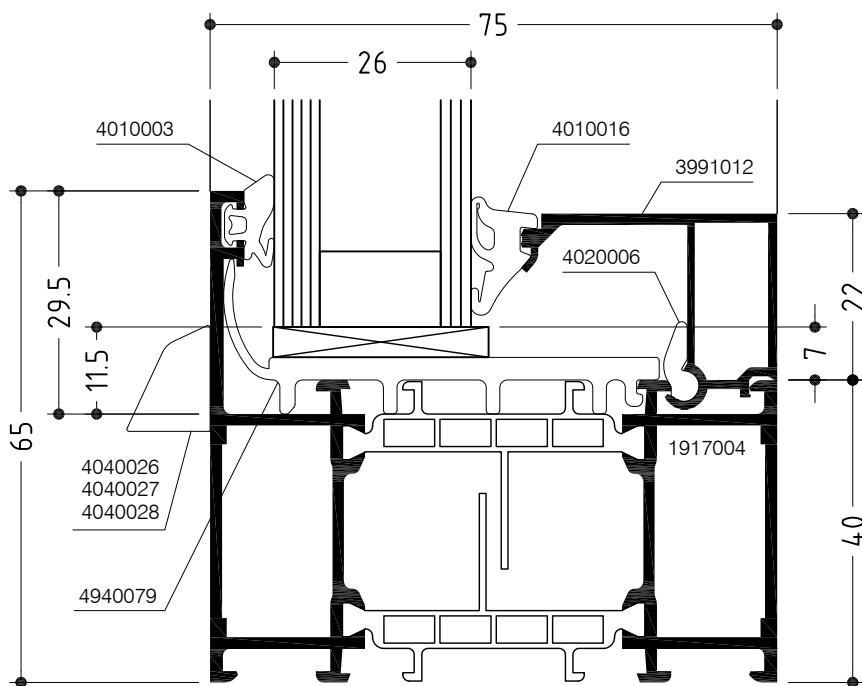



# WICLINE 75

Festverglasung mit Spezial-Dämmprofil  
Fixed glazing with special insulation profile

Konstruktionsschnitt  
Construction section

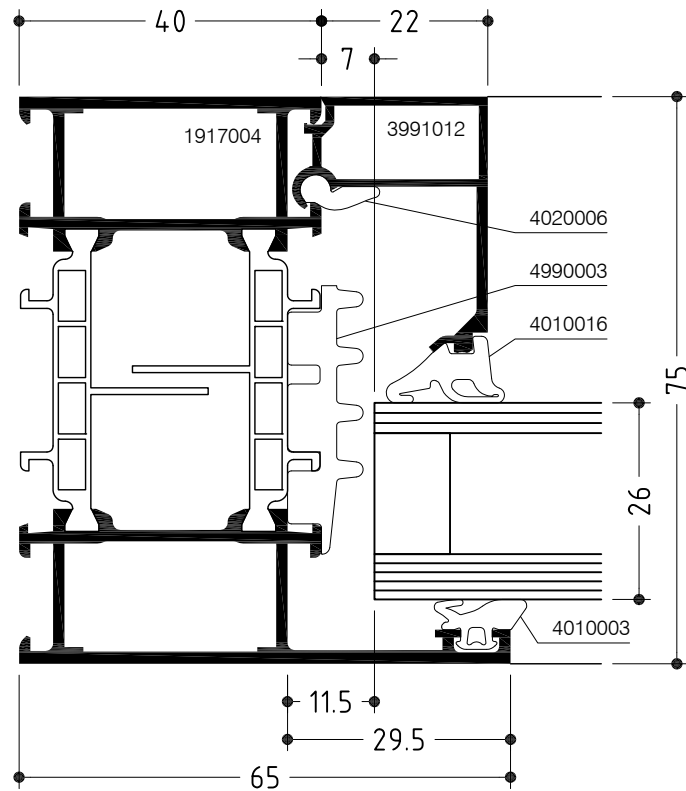

# WICLINE 75

Flügelprofil im Dehnstoßblendrahmen  
Sash profile in expansion joint frame

Konstruktionsschnitt  
Construction section

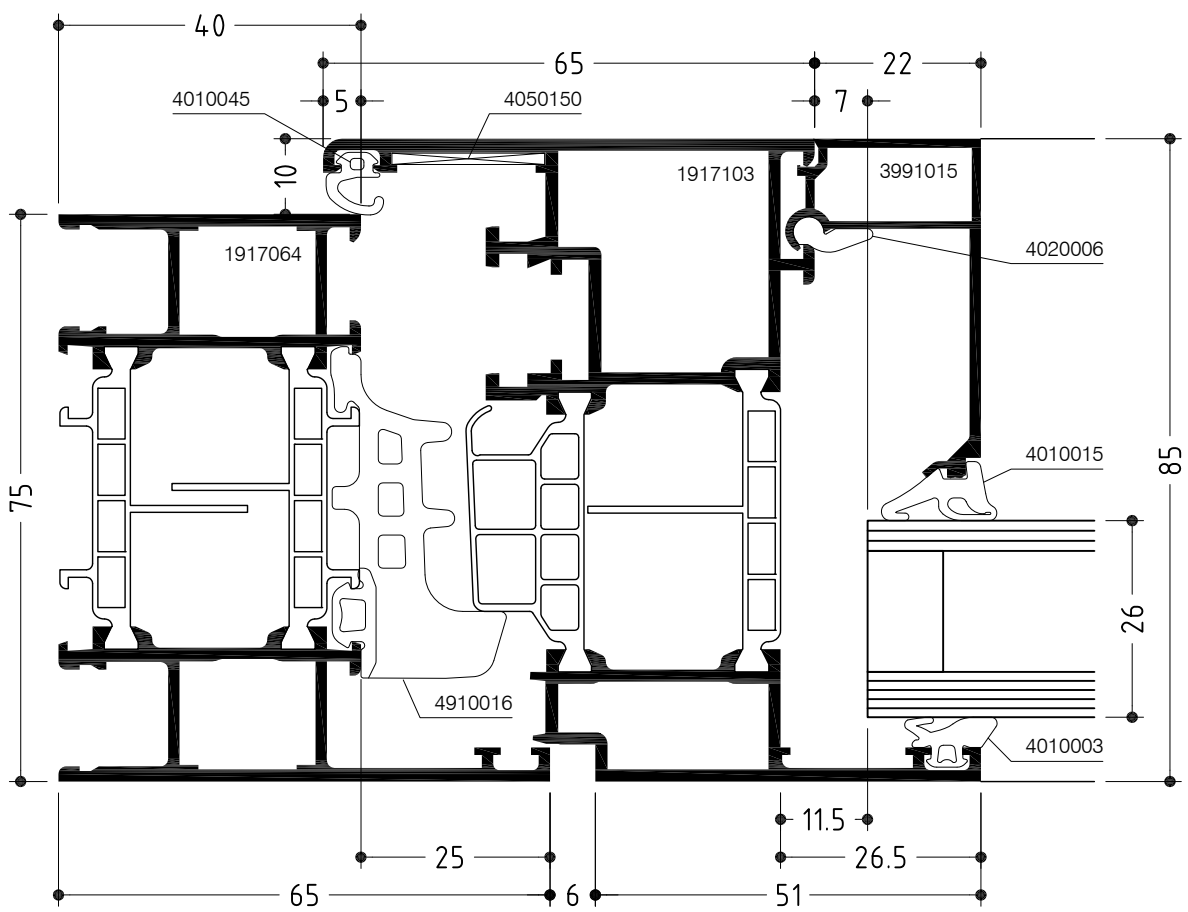

# WICLINE 75

Fenstertür, einwärts  
French window (window-door), inwards

Konstruktionsschnitt  
Construction section

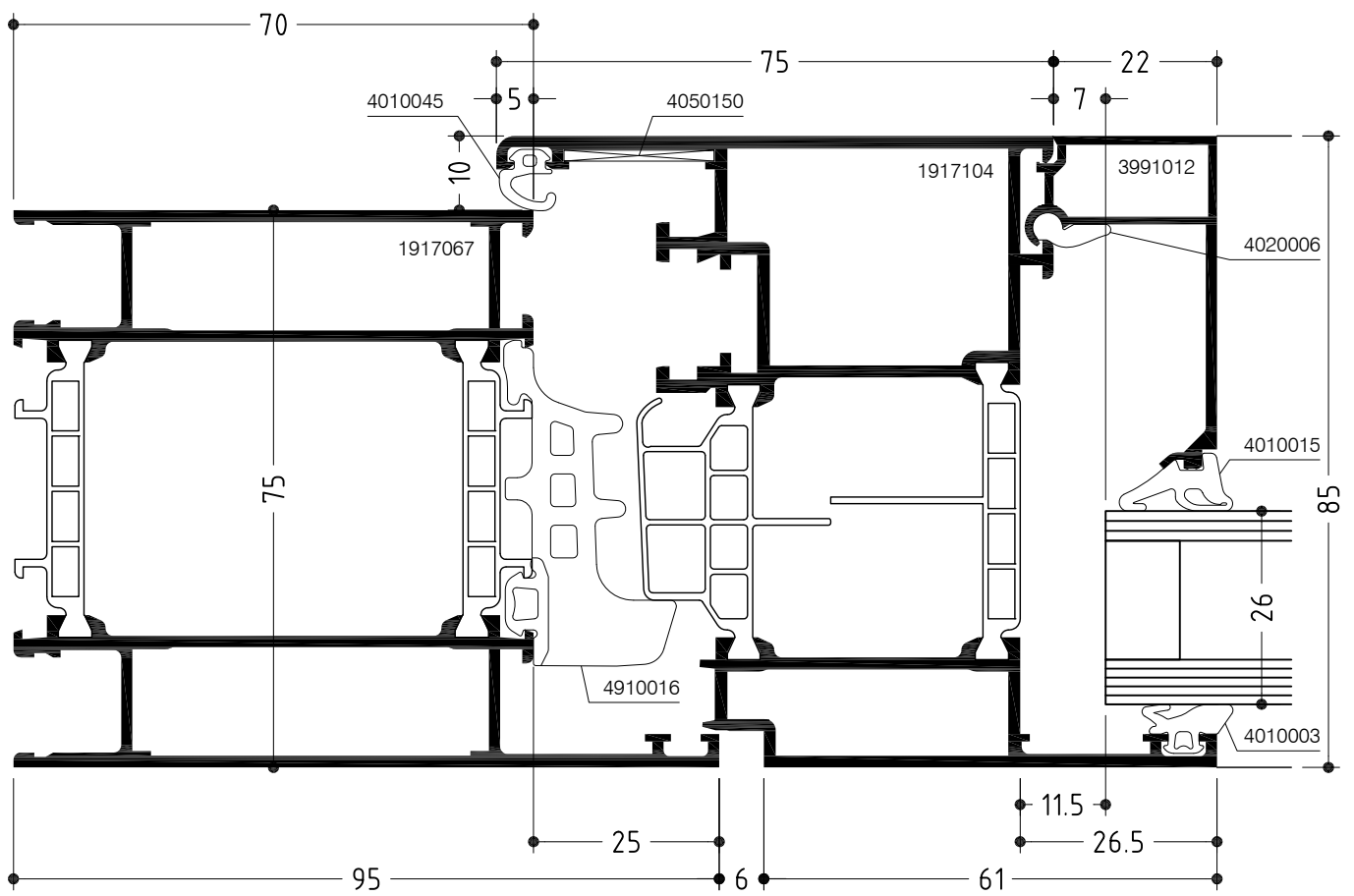
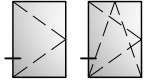

# WICLINE 75

Flügelprofil im Dehnstoßblendrahmen  
Sash profile in expansion joint frame

Konstruktionsschnitt  
Construction section

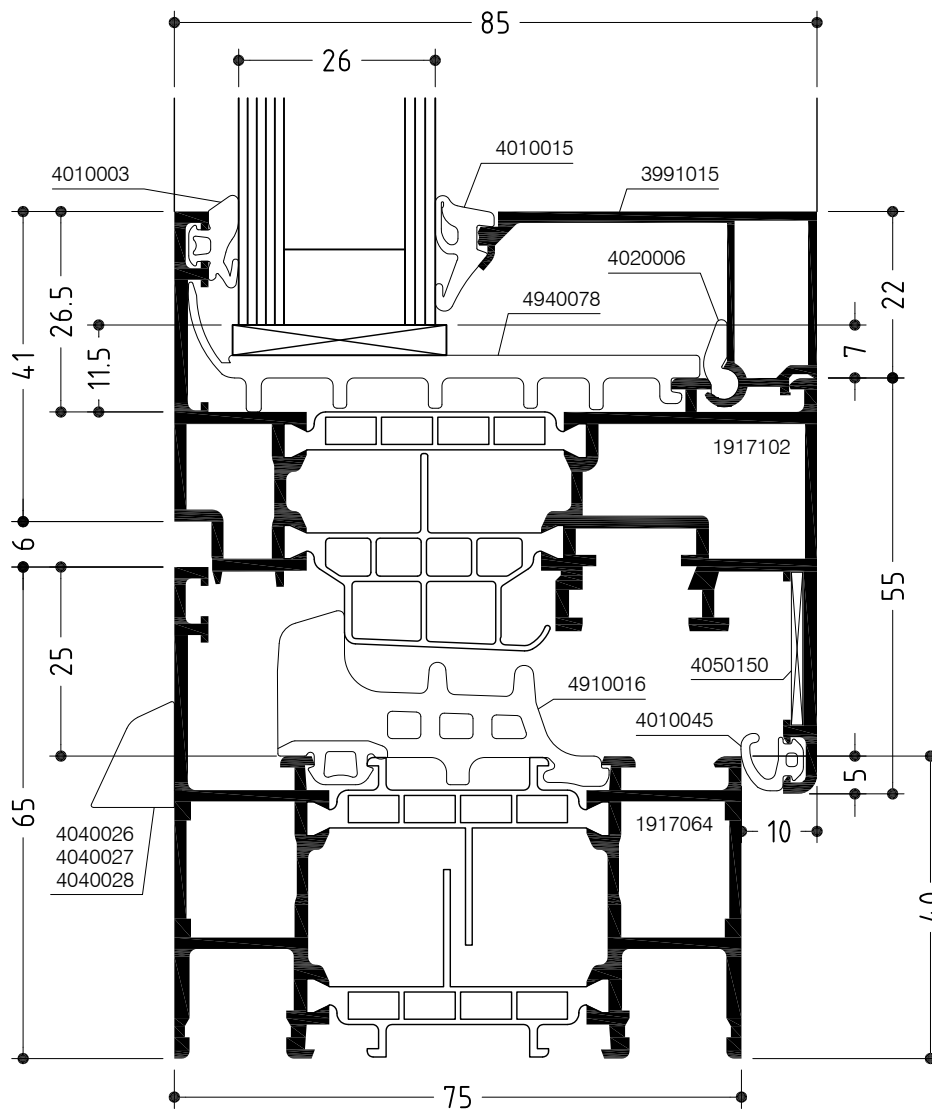

# WICLINE 75

Konstruktionsschnitt

Construction section

Blendrahmen - Dehnstoß und Festverglasung mit Spezial-Dämmprofil

Frame expansion joint and fixed glazing with special insulation profile

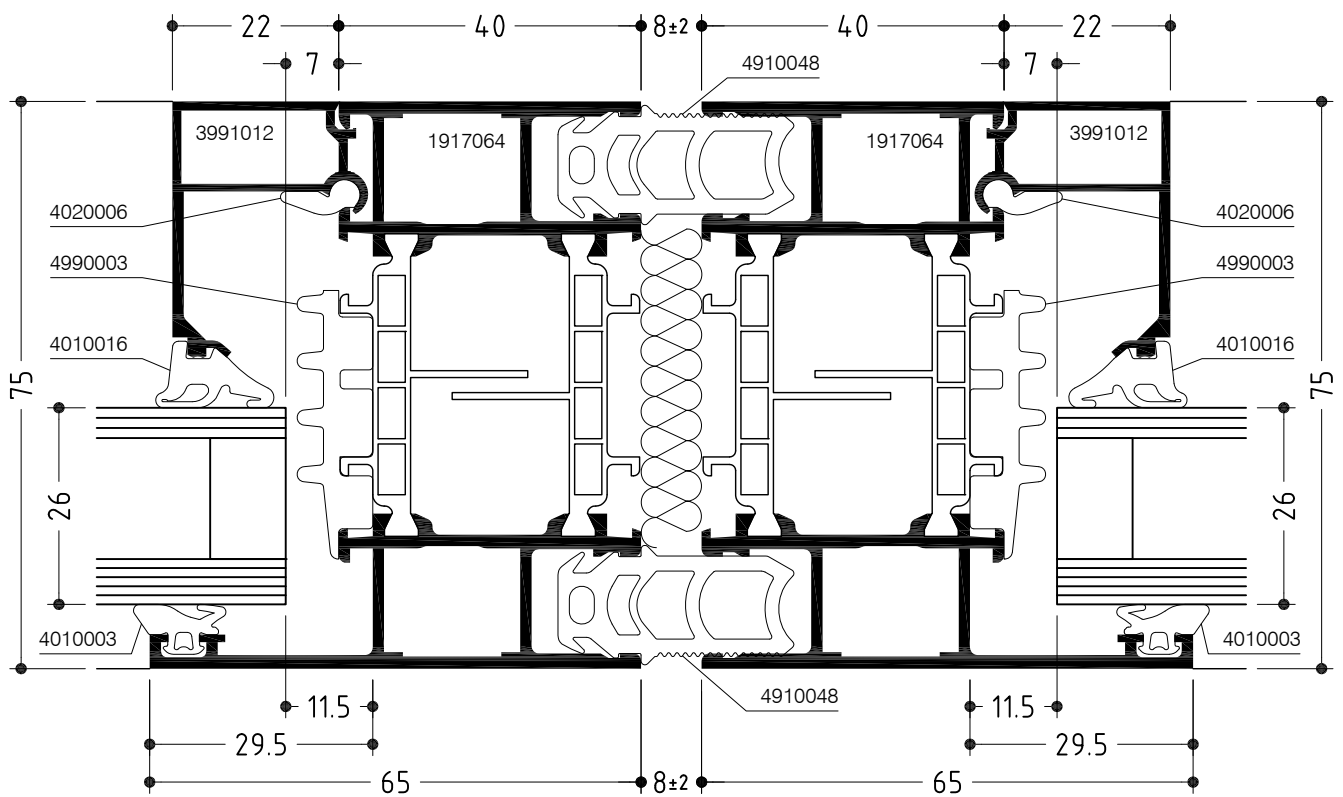
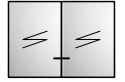

# WICLINE 75

Flügelprofil im Blendrahmen mit Kämpfer  
Sash profile in frame with transom

Konstruktionsschnitt  
Construction section

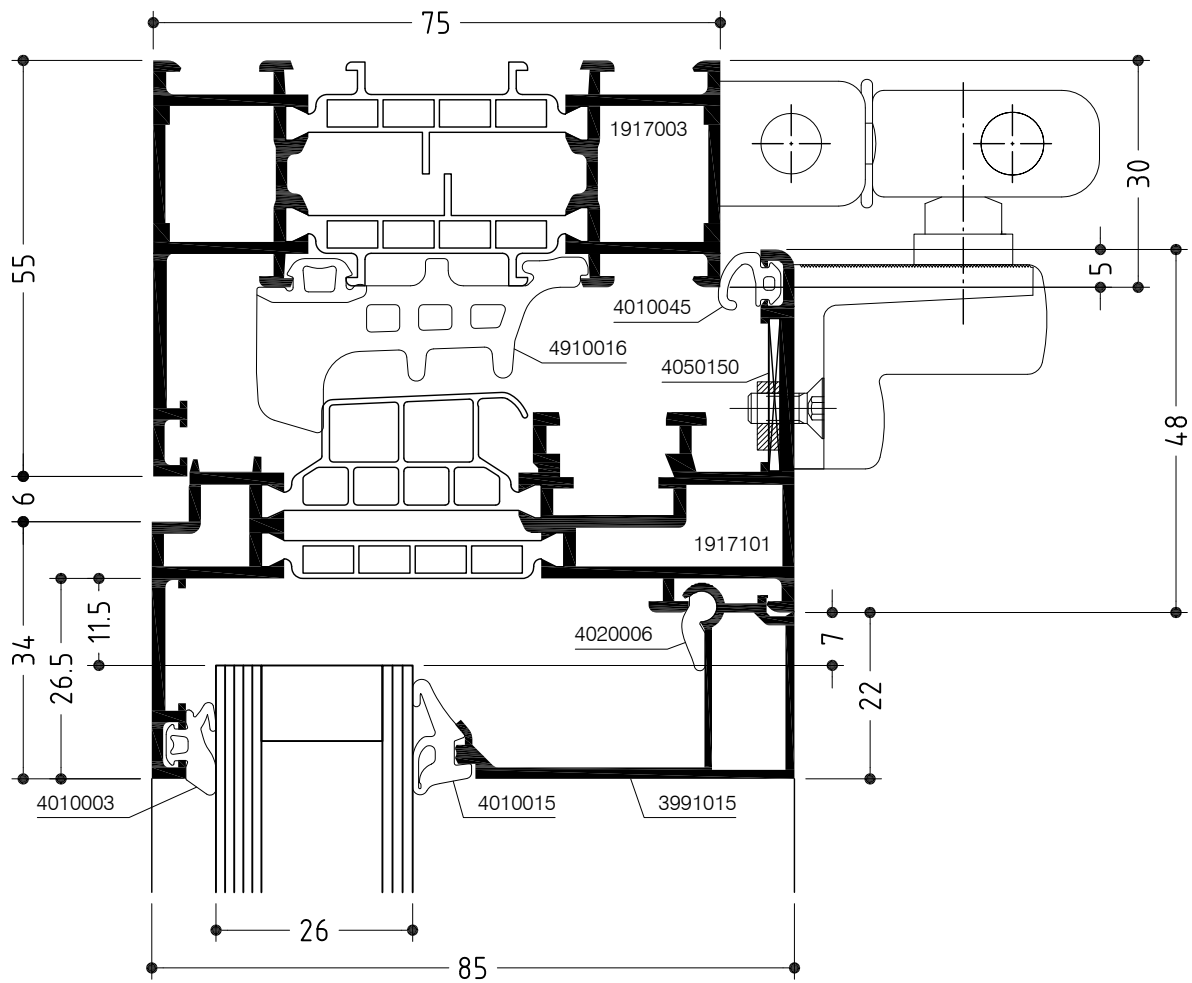
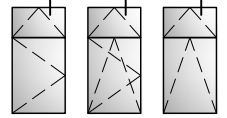

# WICLINE 75

Flügelprofil im Blendrahmen mit Kämpfer  
Sash profile in frame with transom

Konstruktionsschnitt  
Construction section

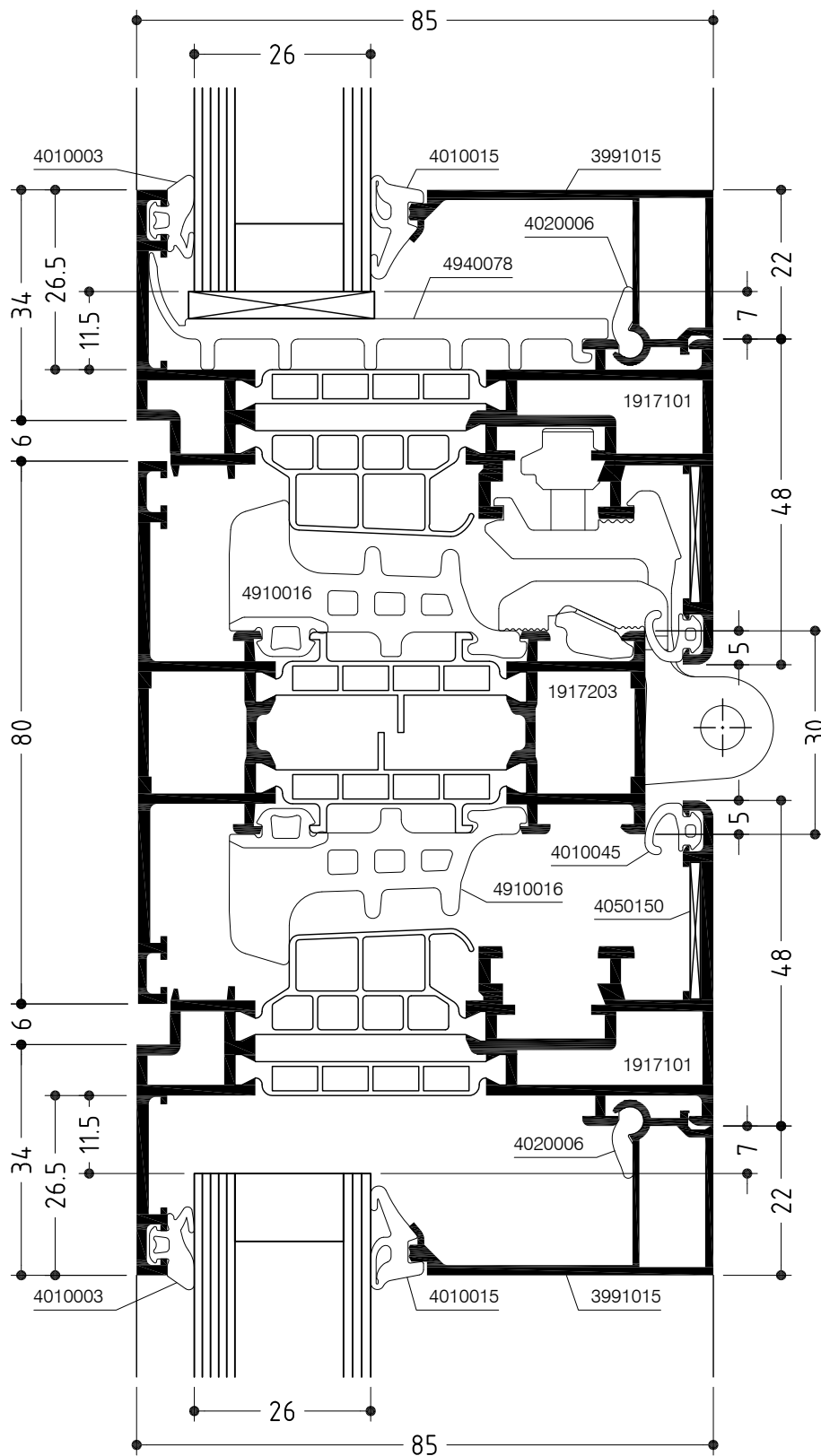
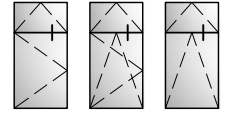

# WICLINE 75

Flügelprofil im Blendrahmen mit Kämpfer  
Sash profile in frame with transom

Konstruktionsschnitt  
Construction section

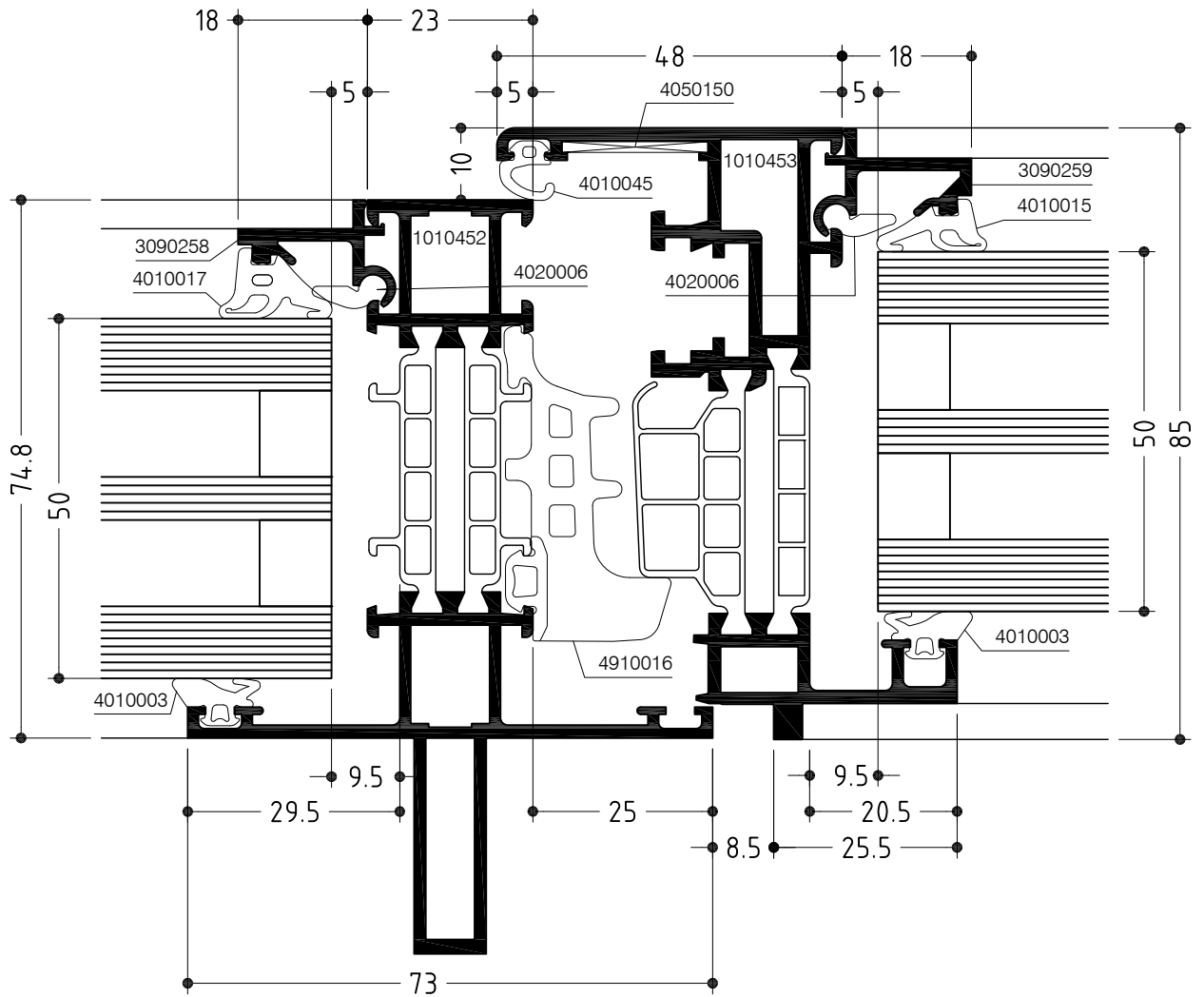
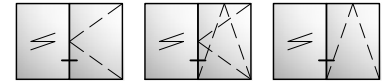



# WICLINE 75

## Konstruktionsschnitt

### Construction section

Kämpferprofil nach innen verstärkt mit Festverglasung

Internally reinforced transom profile with fixed glazing

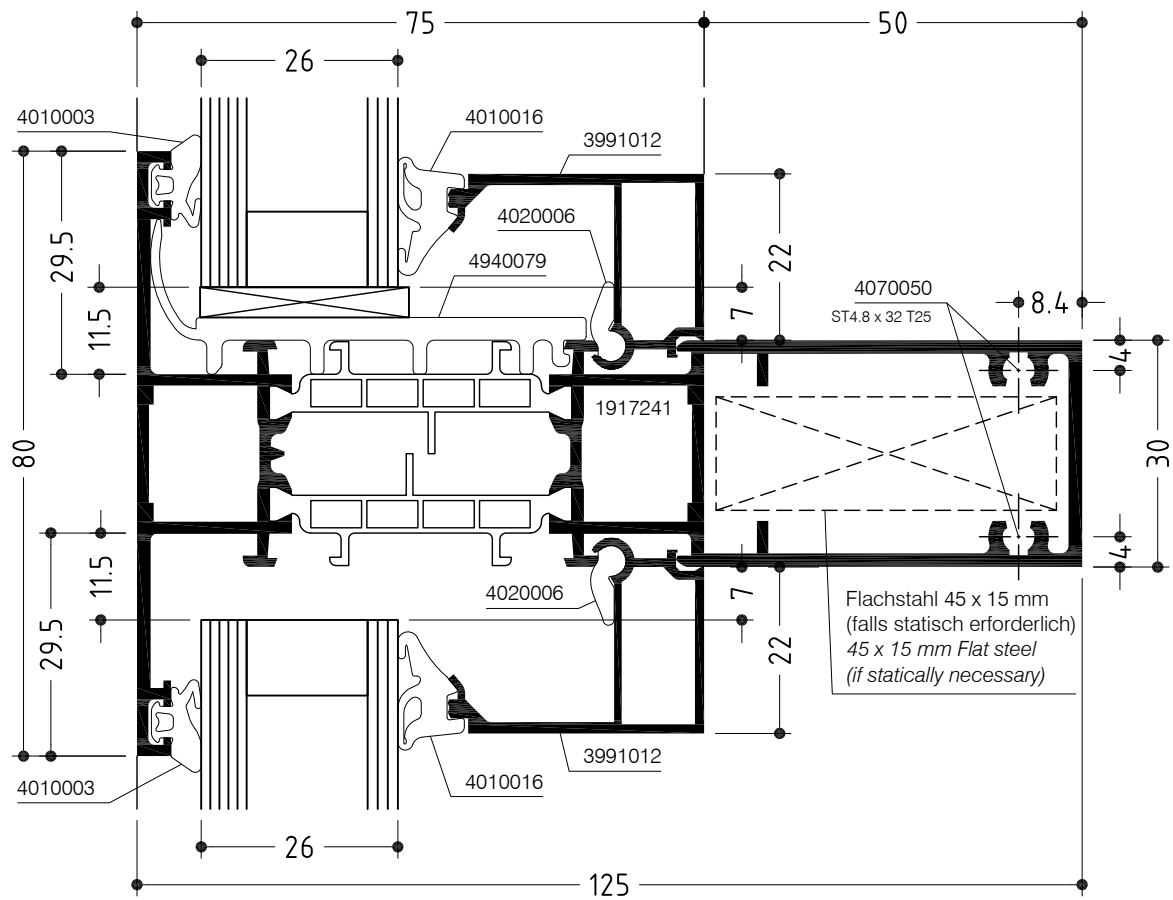
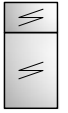

# WICLINE 75

Kämpferprofil nach innen verstärkt mit Falzverbreiterung  
*Internally reinforced transom profile with rebate widening*

Konstruktionsschnitt  
*Construction section*

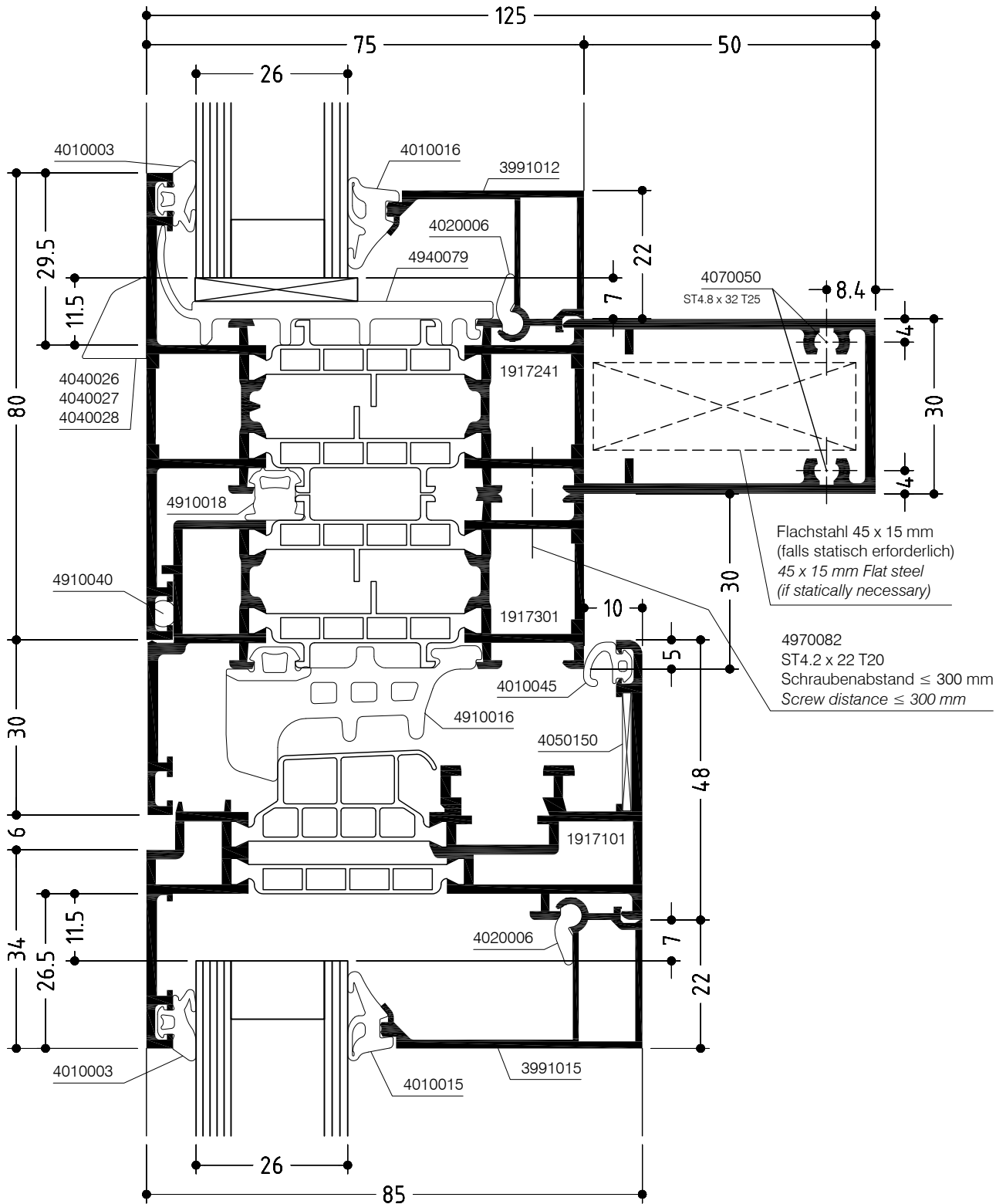
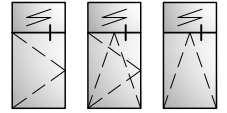

# WICLINE 75

Stützenprofile nach außen verstärkt  
Externally reinforced mullion profiles

Konstruktionsschnitt  
Construction section

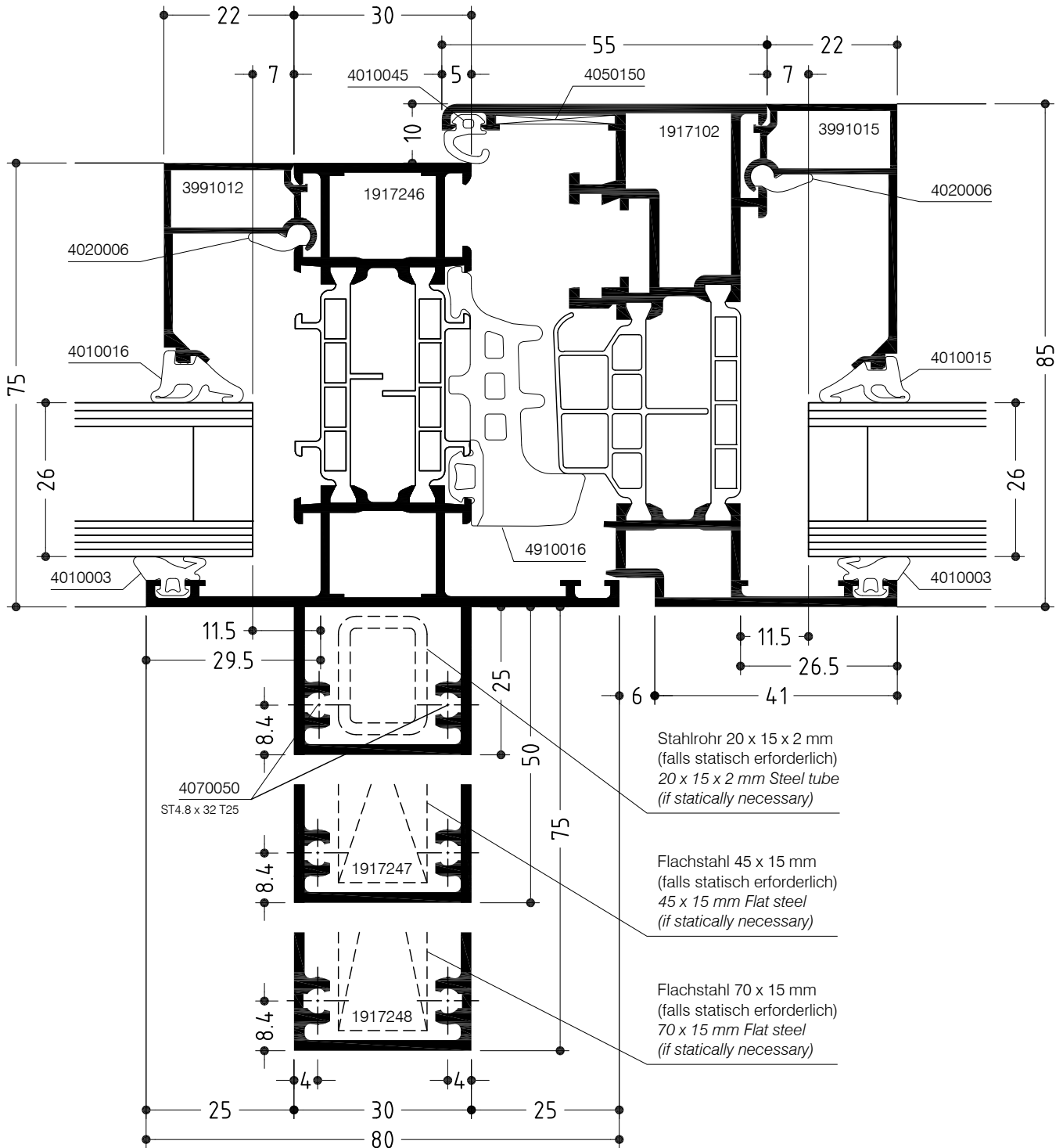
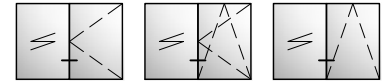

# WICLINE 75

Stützenprofile nach außen verstärkt  
Externally reinforced mullion profiles

Konstruktionsschnitt  
Construction section

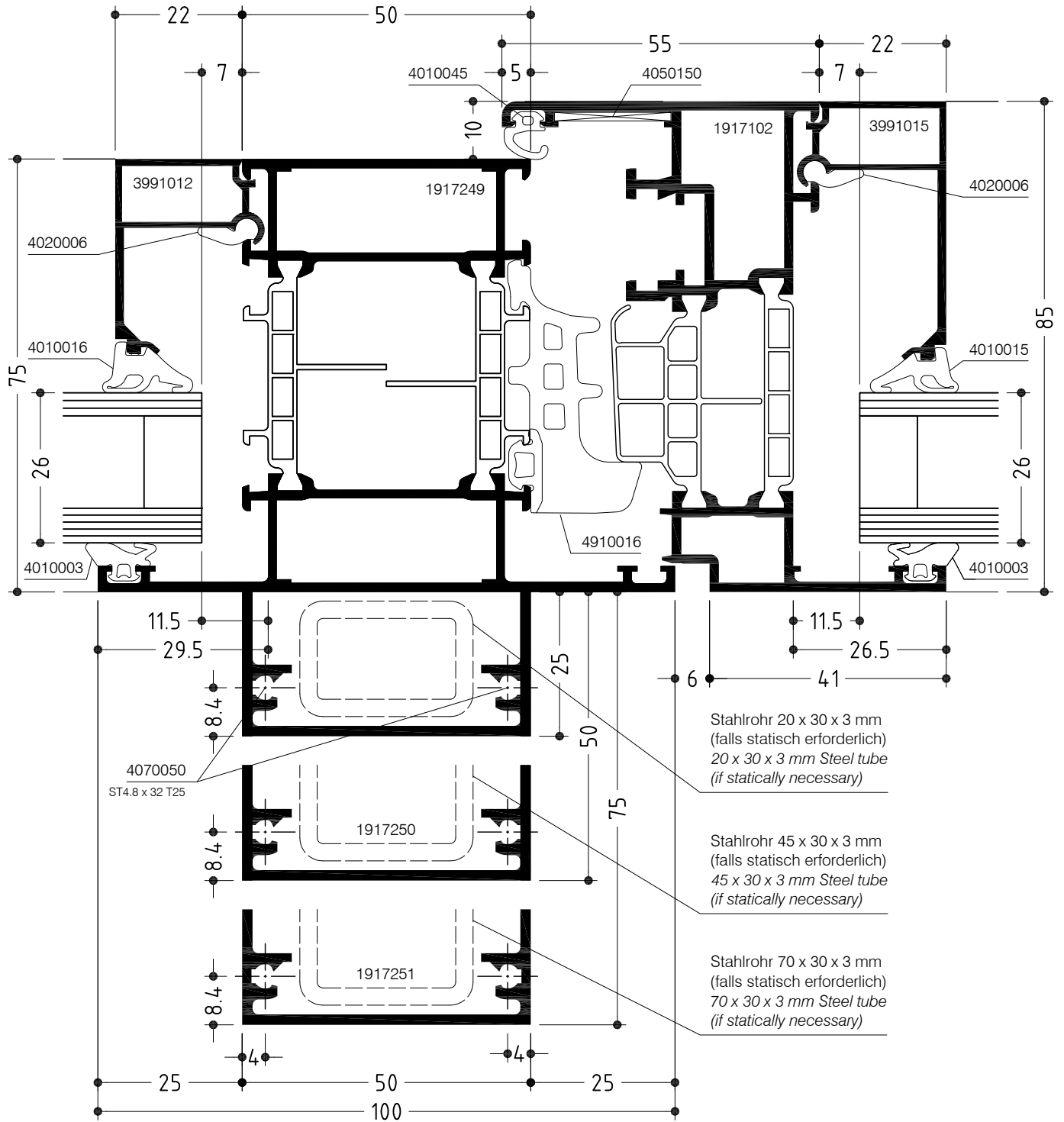
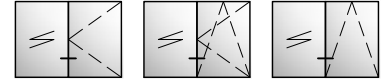

# WICLINE 75

Kämpferprofile nach außen verstärkt  
*Externally reinforced transom profiles*

Konstruktionsschnitt  
*Construction section*

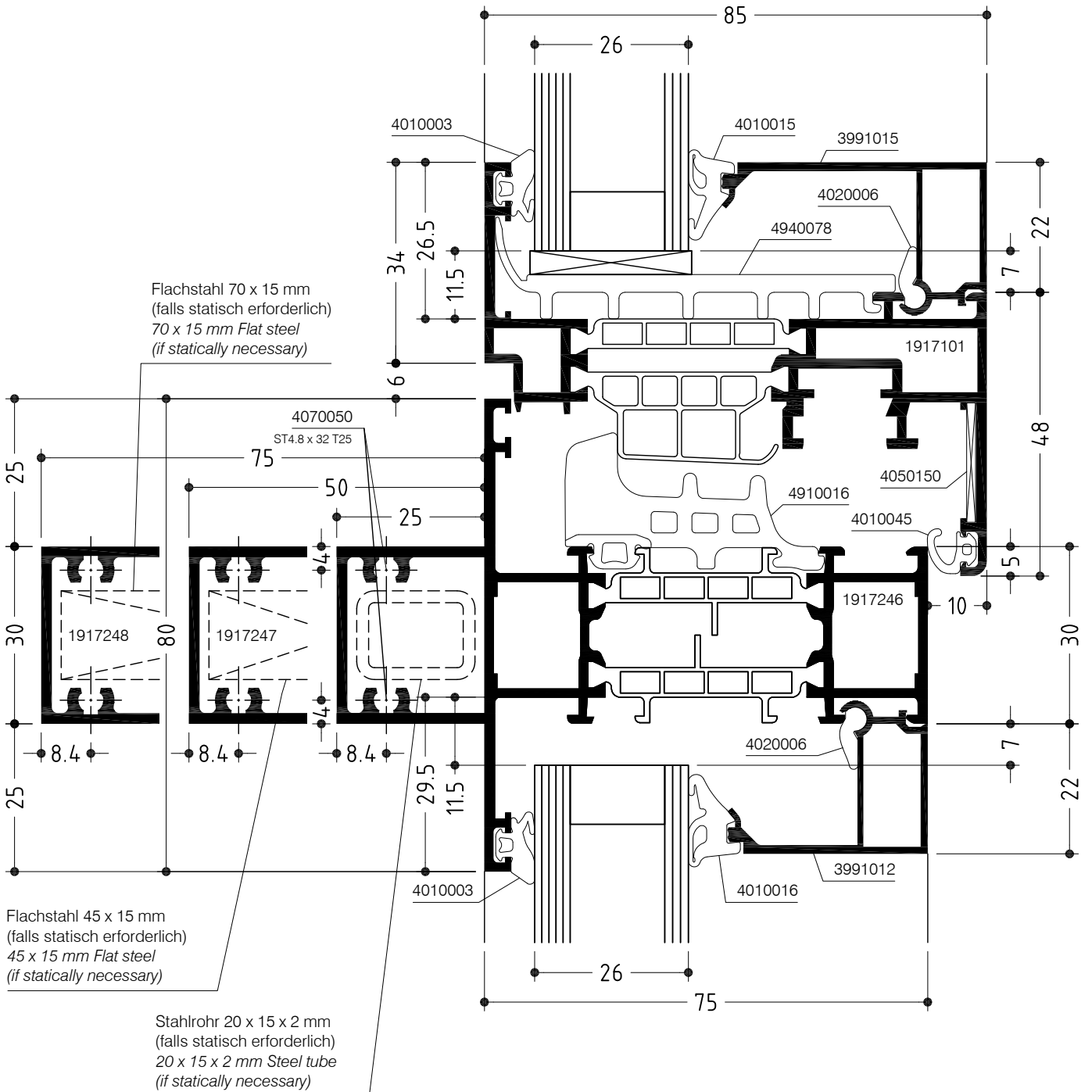
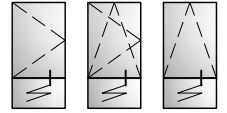

# WICLINE 75

Kämpferprofile nach außen verstärkt  
*Externally reinforced transom profiles*

Konstruktionsschnitt  
*Construction section*

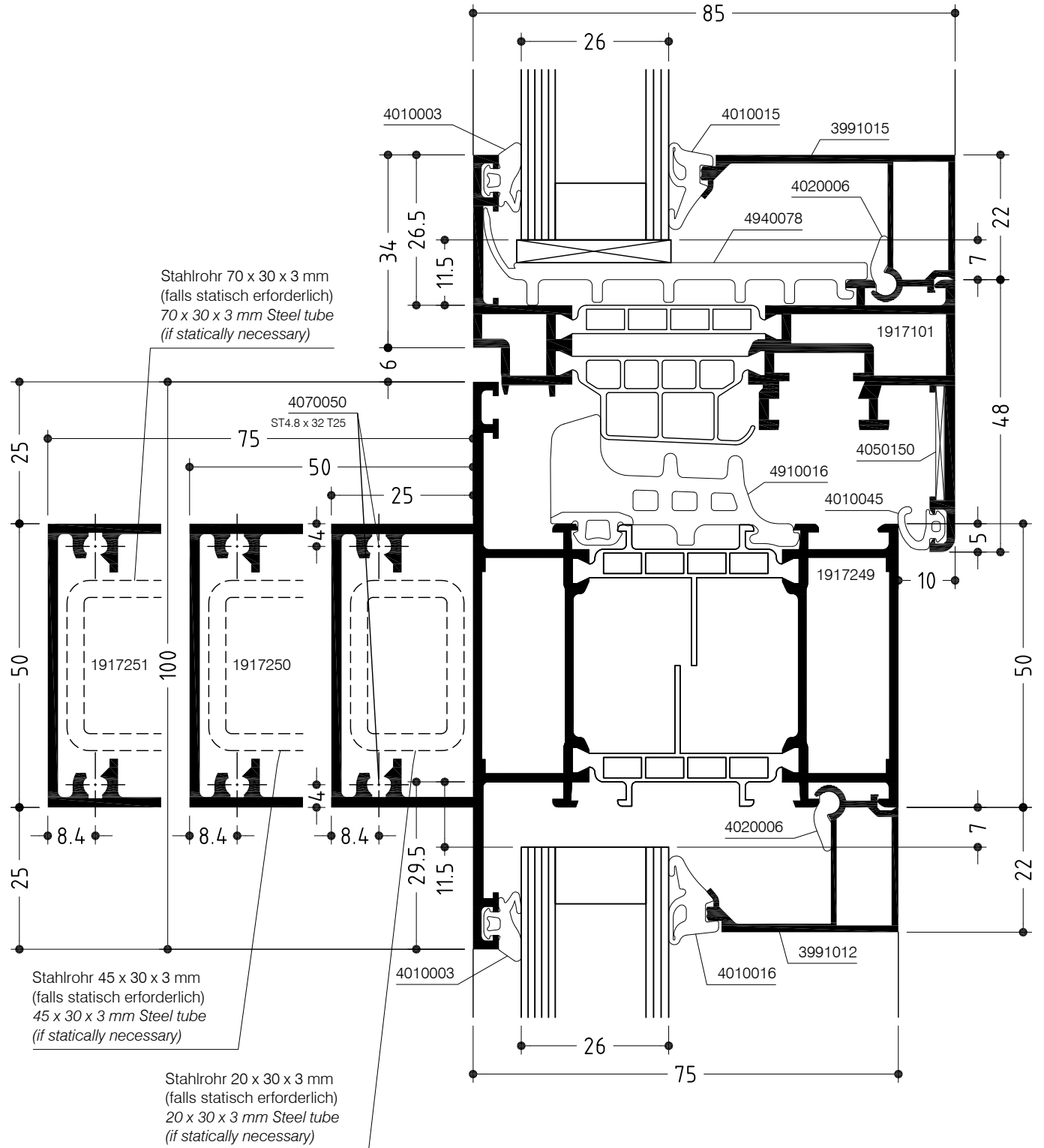
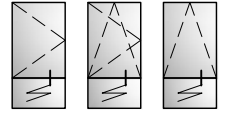

# WICLINE 75

Stützenprofile geteilt, nach außen verstärkt  
*Externally reinforced split mullion profiles*

Konstruktionsschnitt  
*Construction section*

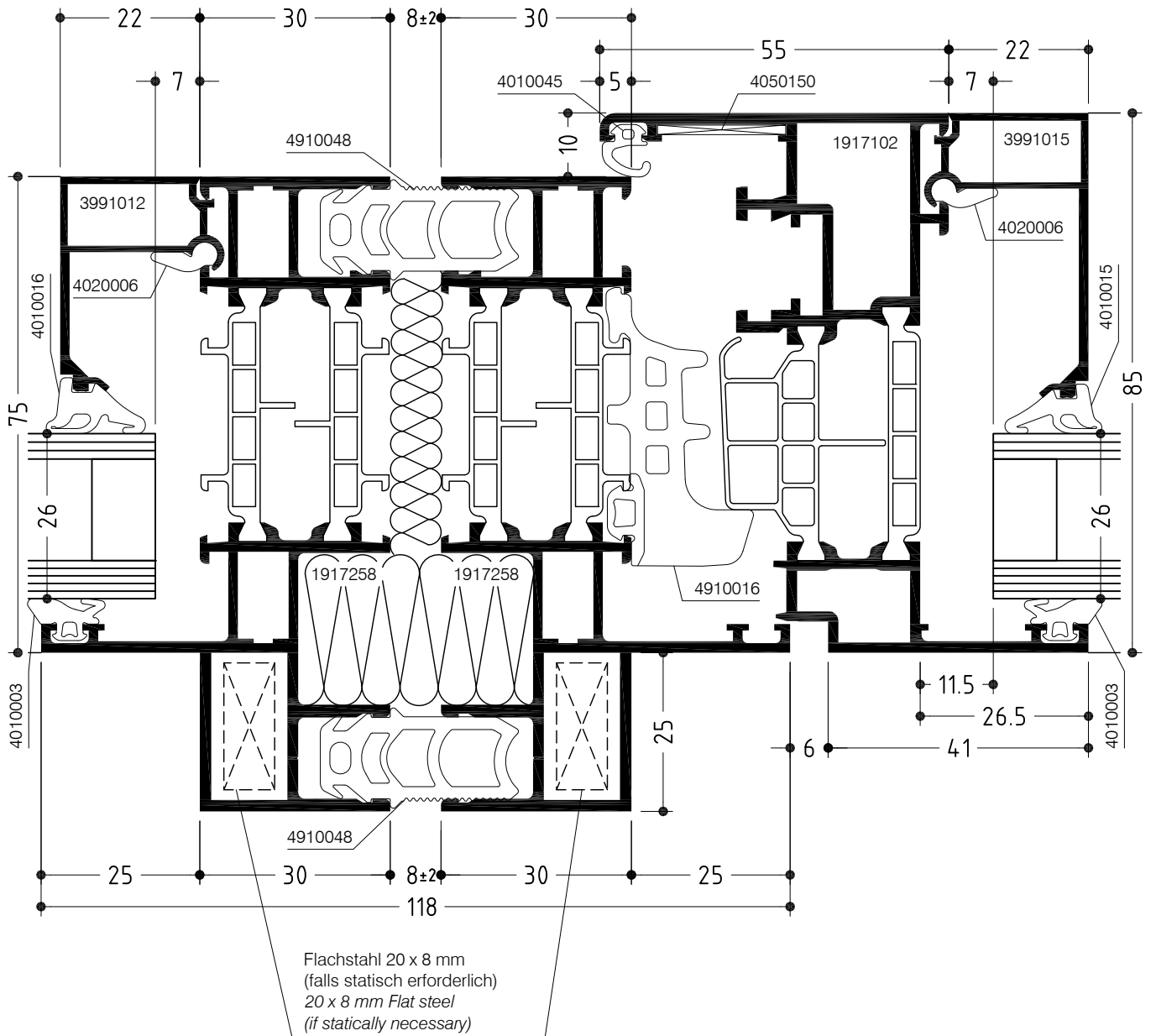
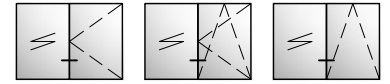

# WICLINE 75

Stützenprofile geteilt, nach außen verstärkt  
*Externally reinforced split mullion profiles*

Konstruktionsschnitt  
*Construction section*

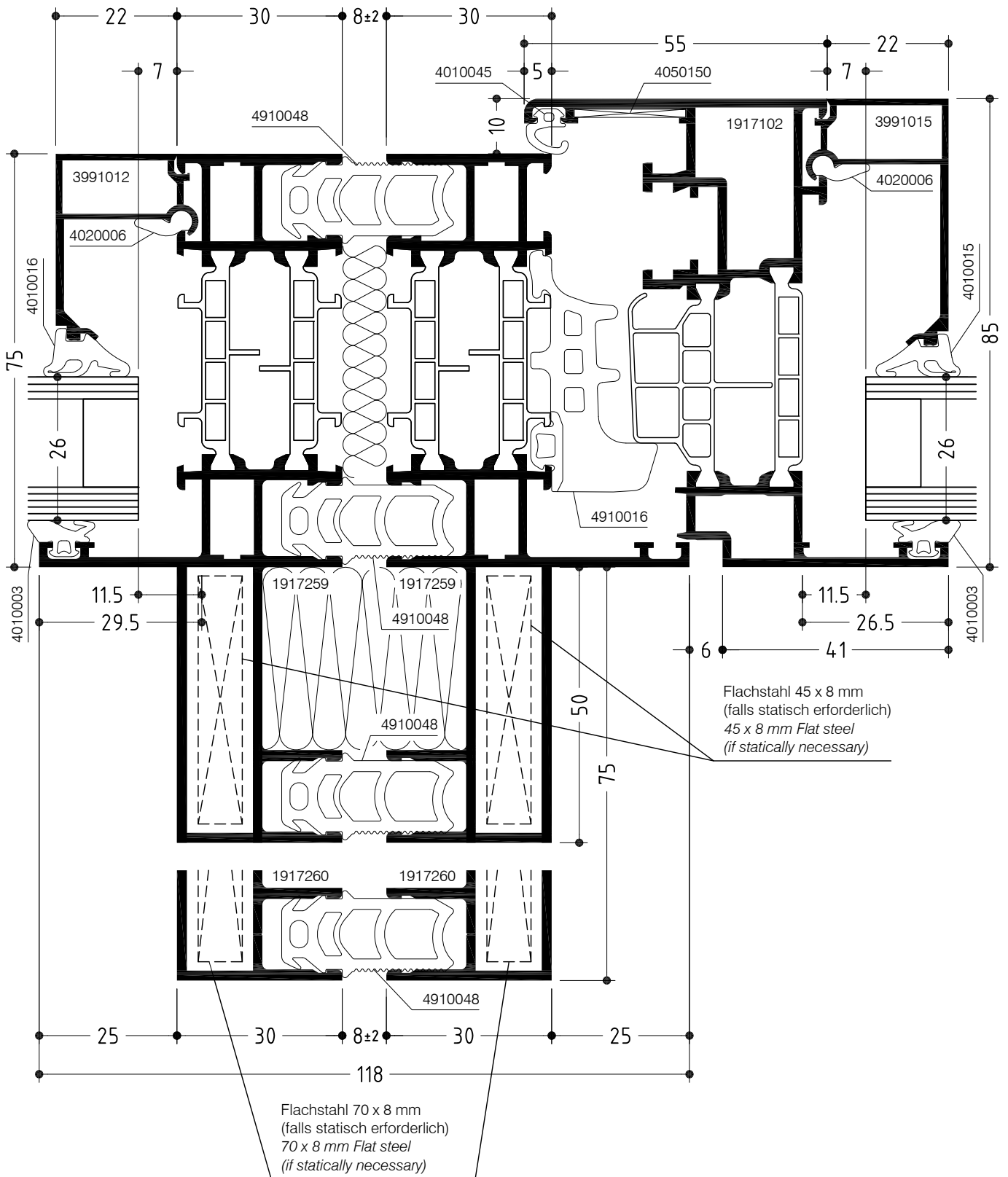
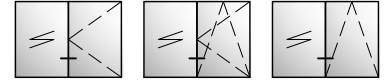









# WICLINE 75

Eckstützenprofil - Innenecke 135°  
 Corner mullion profile of 135° inner corner

Konstruktionsschnitt  
 Construction section

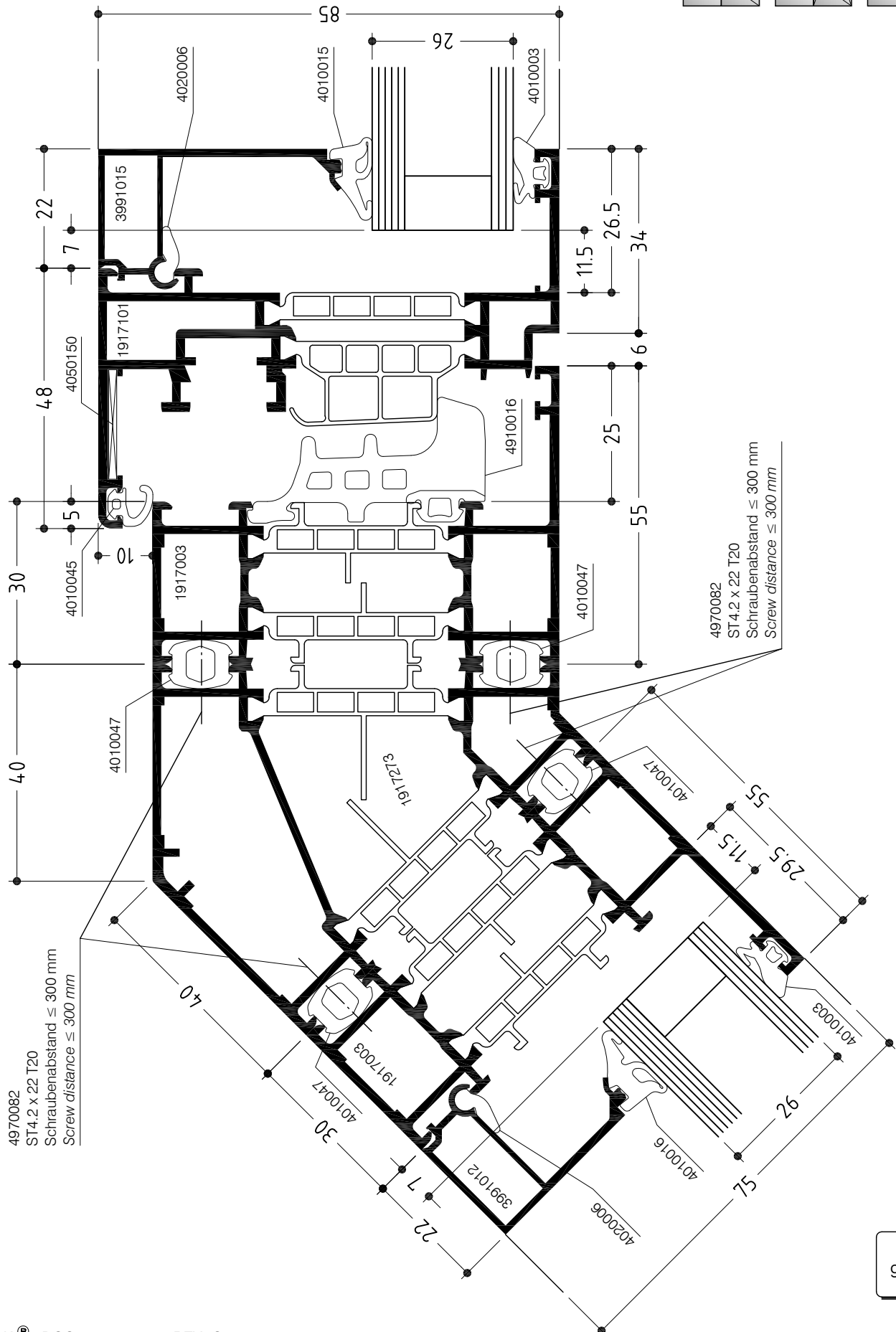
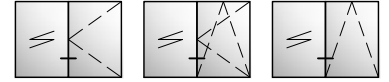



# WICLINE 75

## Konstruktionsschnitt

### Construction section

Flügelprofil im Blendrahmen mit Bauanschlussprofil 1917307

Sash profile in frame with profile 1917307 for junction to structure

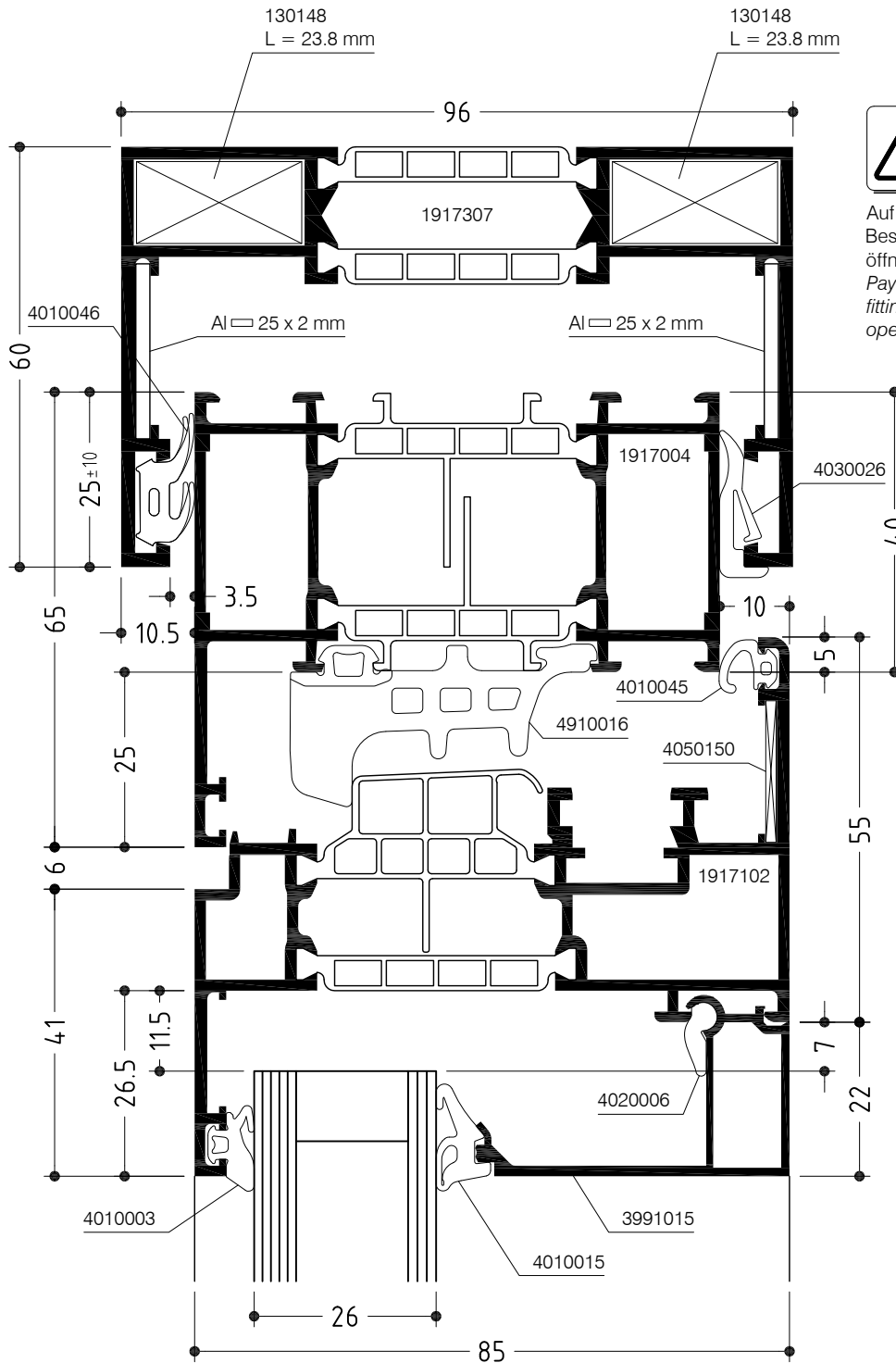

Auf Platzbedarf aufragender  
Beschlage wie Bander, Oberlicht-  
ffner usw. achten.  
*Pay attention to space required for  
fittings such as hinges, fanlight  
opener etc.*

# WICLINE 75

Flügelprofil im Einspannblendrahmen  
Sash profile in clamping frame

Konstruktionsschnitt  
Construction section

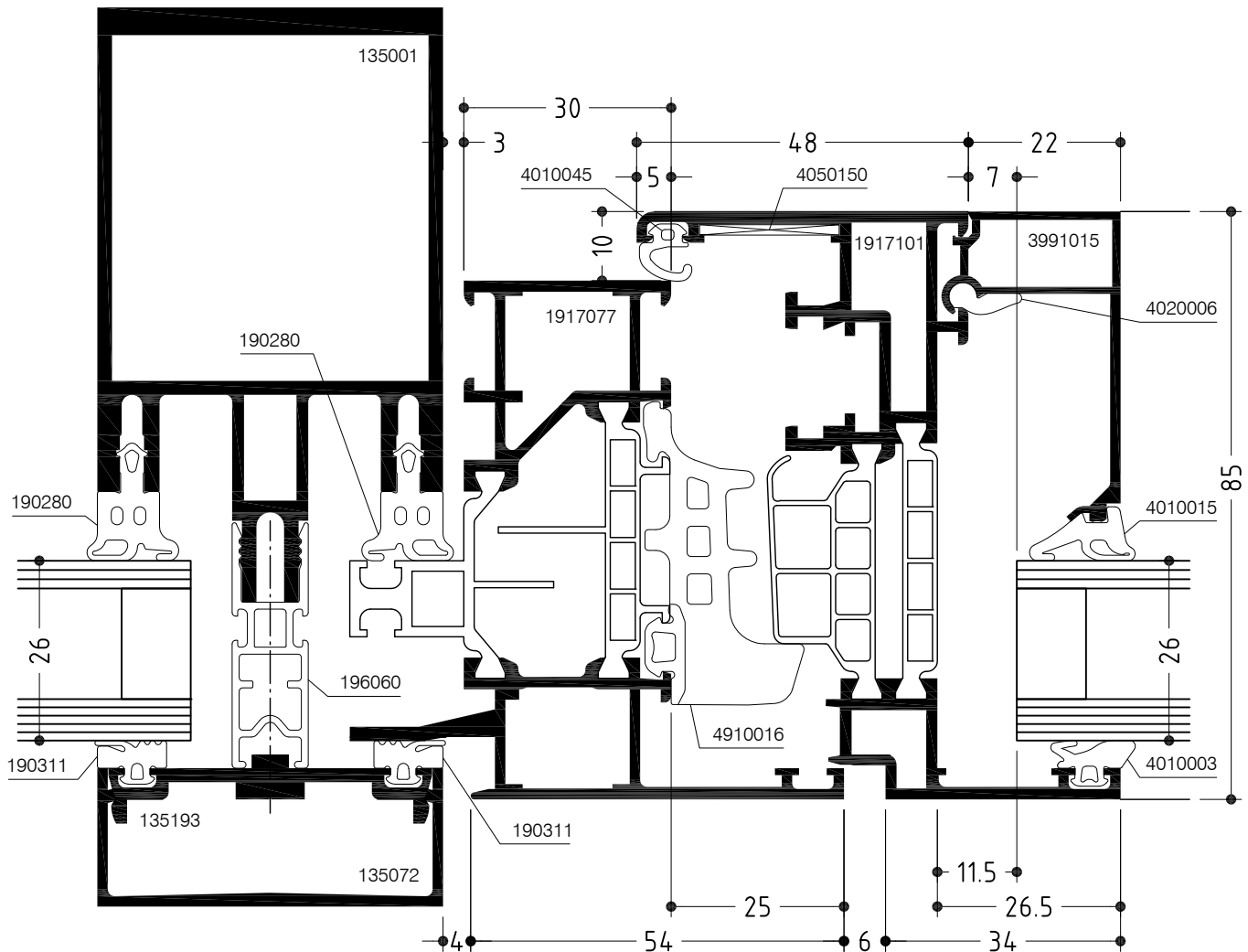

# WICLINE 75

## Konstruktionsschnitt

### Construction section

Flügelprofil im Blendrahmen mit Einspannaufsatz

Sash profile in frame with supplementary clamping profile

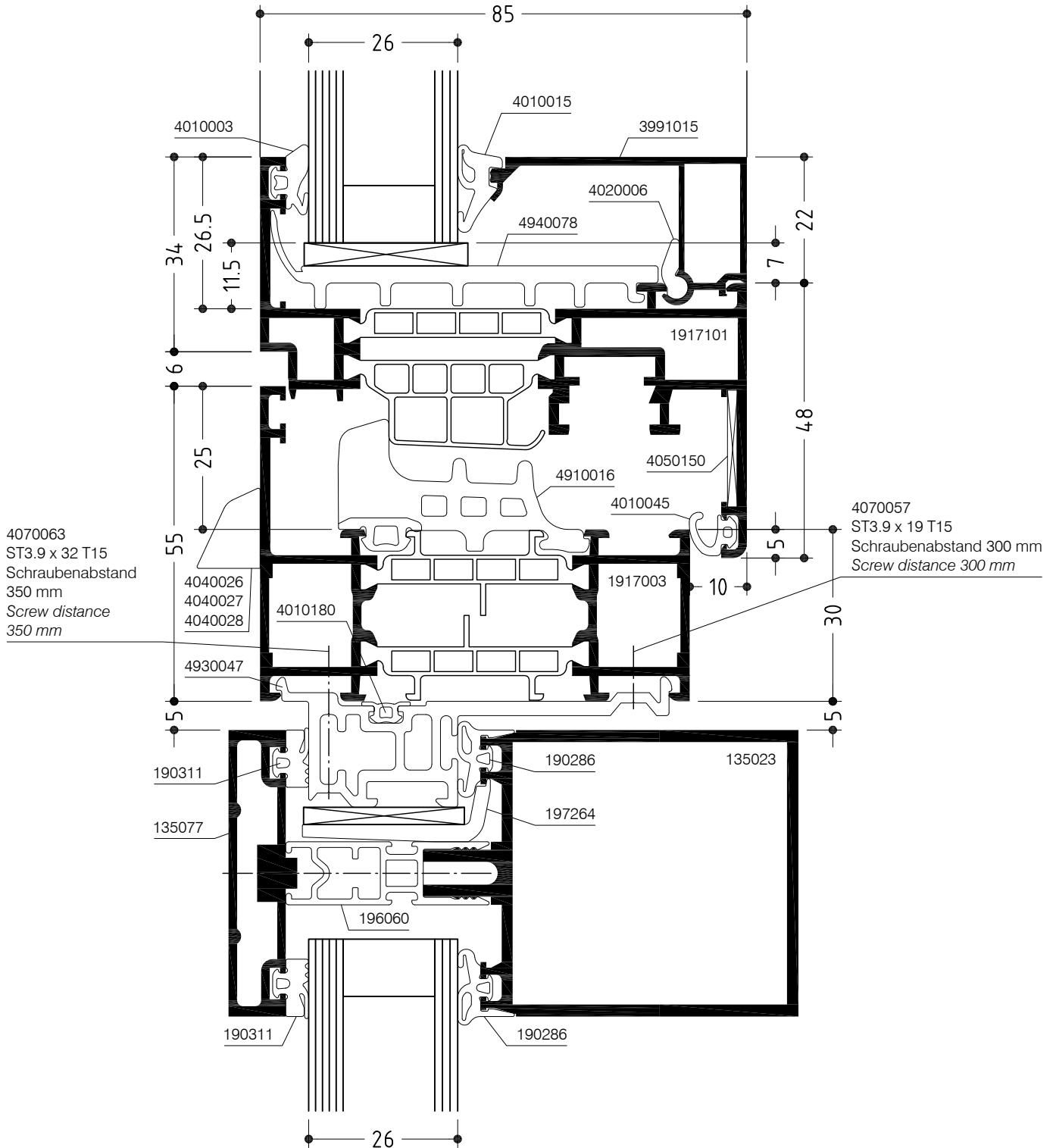



# WICLINE 75

## Konstruktionsschnitt

### Construction section

Blendrahmen mit Einspannaufsatz und Befestigungsteil

Frame with supplementary clamping profile and fixing part

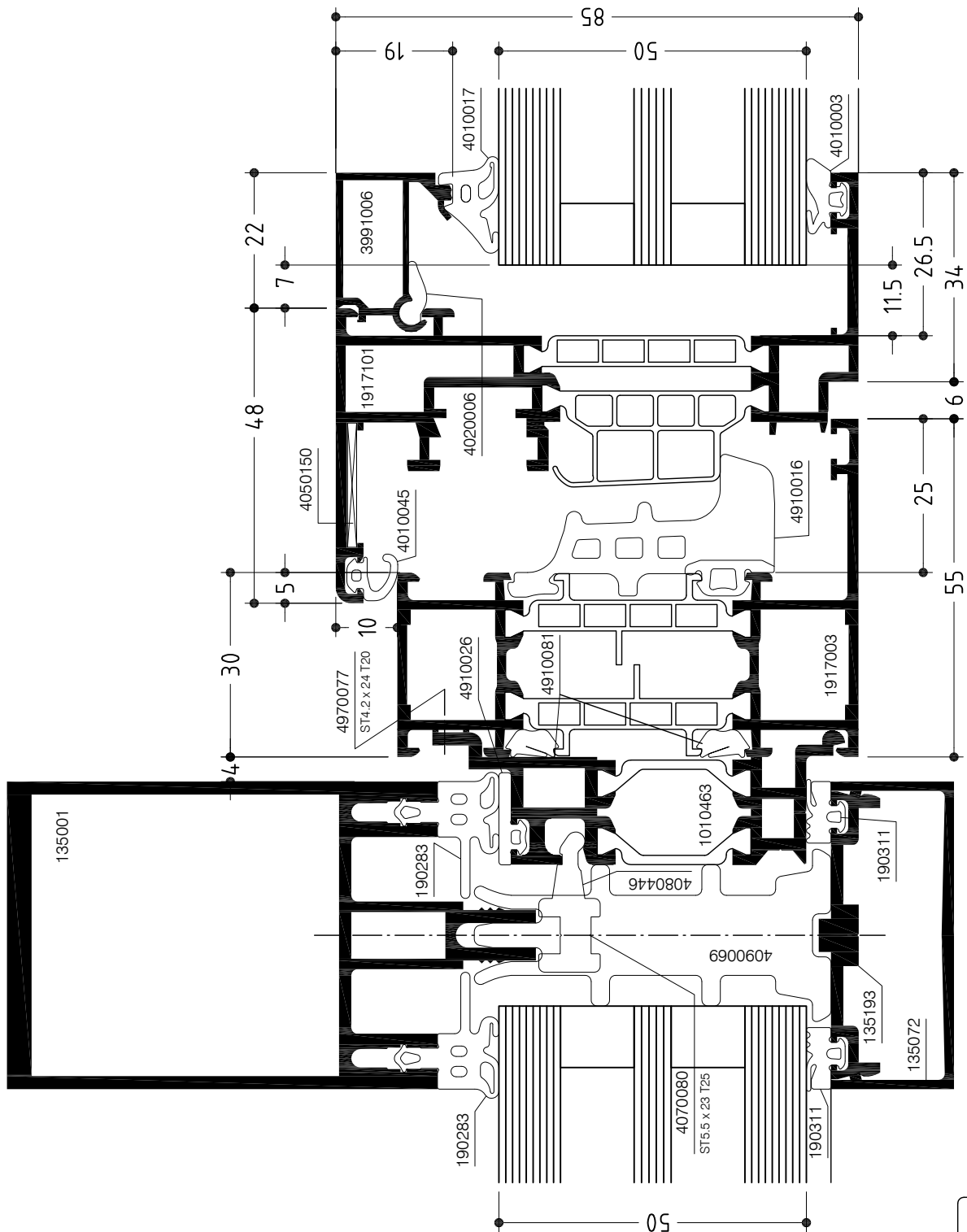

# WICLINE 75

Konstruktionsschnitt

Construction section

Kämpfer mit Einspannaufsatz und Befestigungsteil

Transom with supplementary clamping profile and fixing part

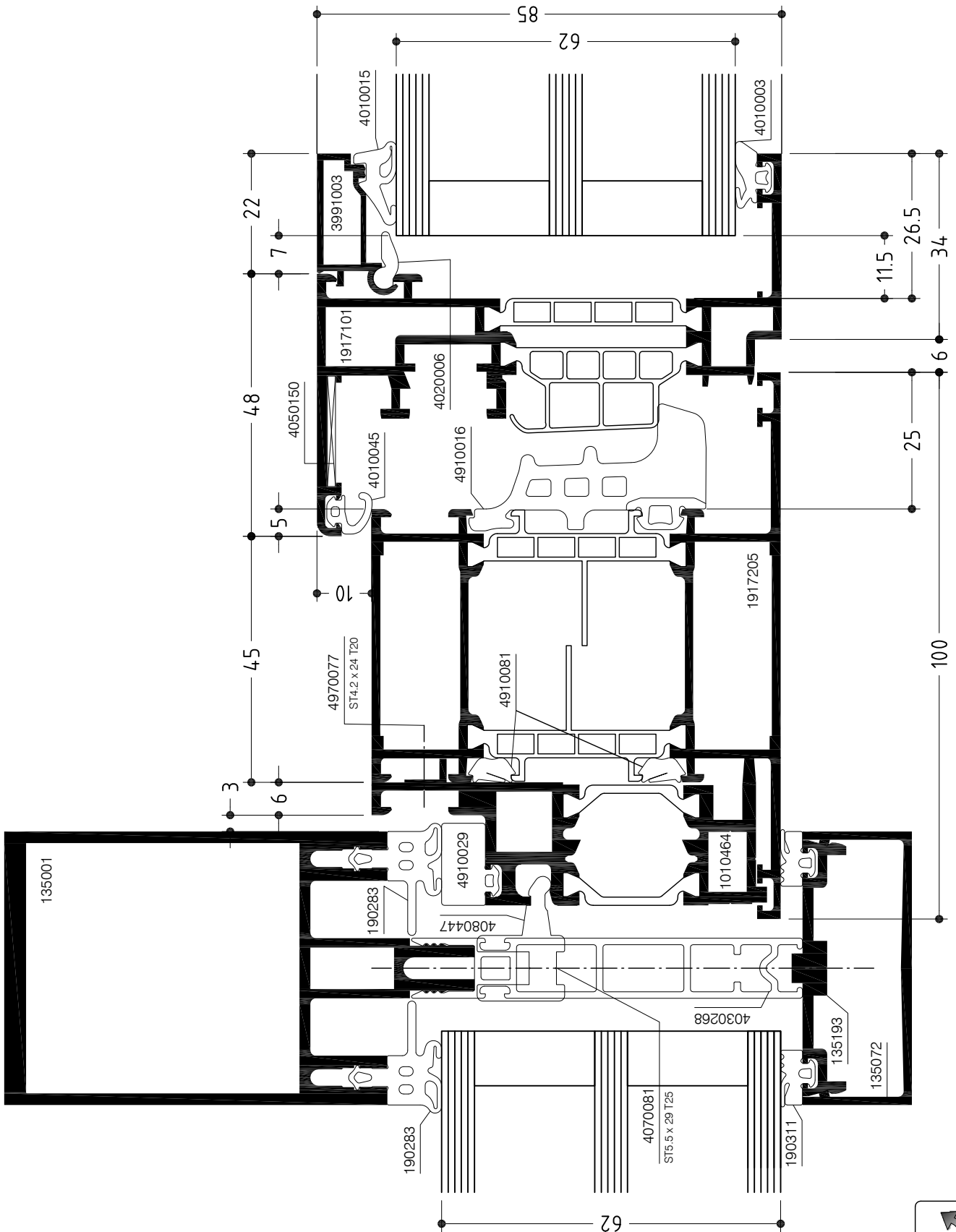

# WICLINE 75

## Konstruktionsschnitt

### Construction section

Bauanschluss unten mit Dämmauflage 4030365

Bottom junction to structure with insulation support 4030365

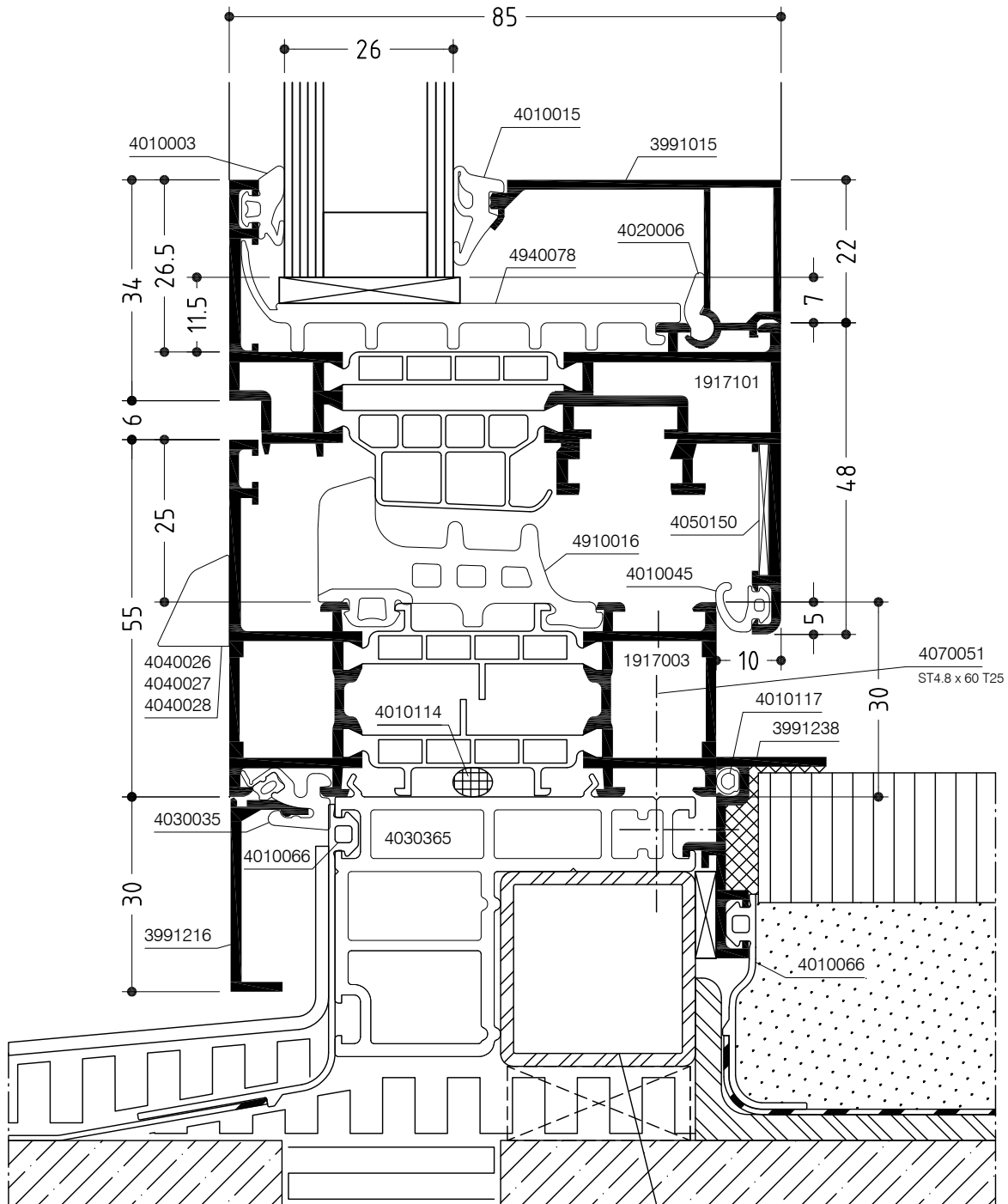

Stahlrohr 30 x 30 x 2.5  
verzinkt nach DIN 55928  
30 x 30 x 2.5 Steel tube,  
galv. acc. to DIN 55928

# WICLINE 75

## Konstruktionsschnitt

### Construction section

Bauanschluss unten mit Dämmauflage 4030365

Bottom junction to structure with insulation support 4030365

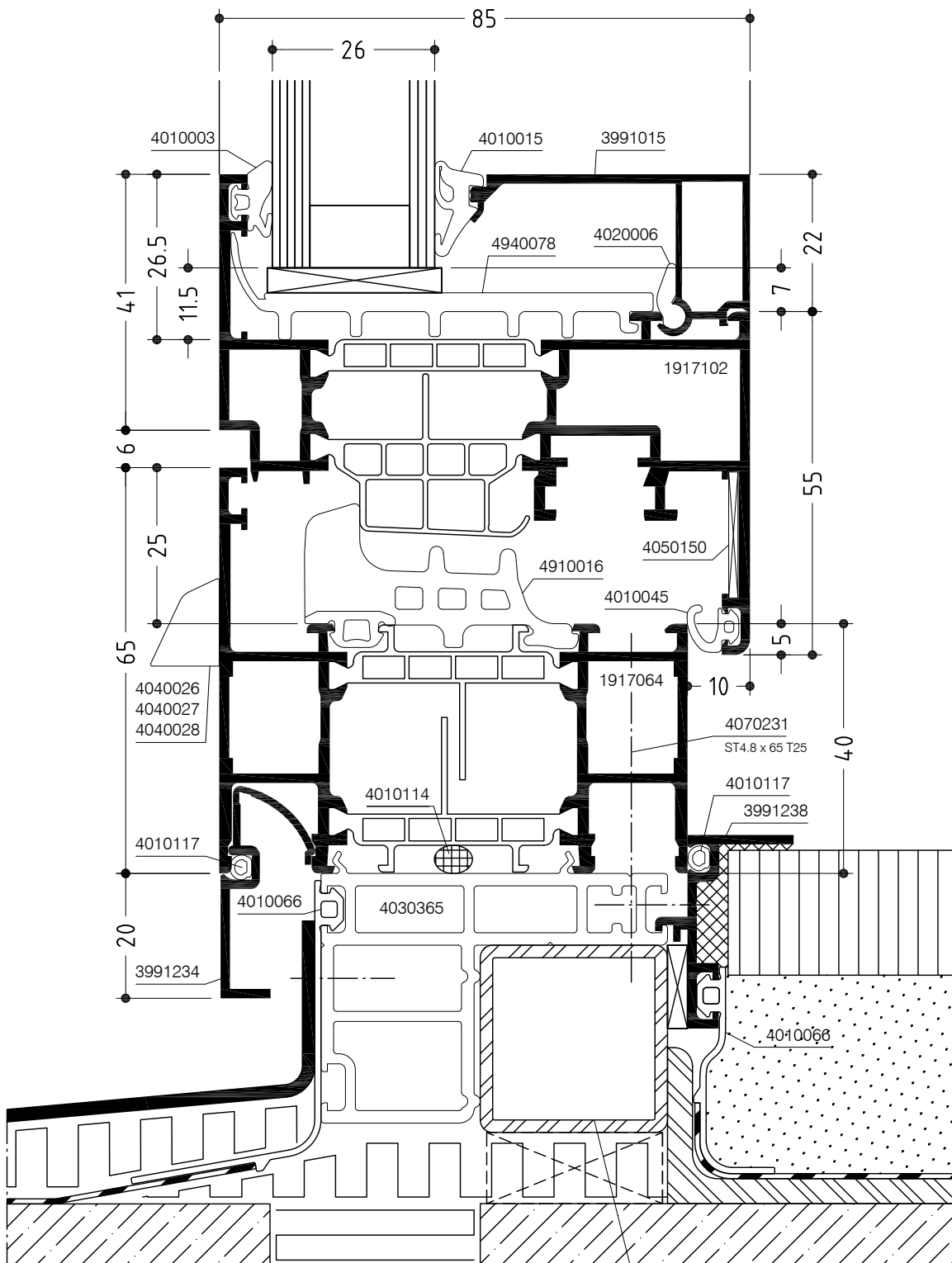

Stahlrohr 30 x 30 x 2.5  
 verzinkt nach DIN 55928  
 30 x 30 x 2.5 Steel tube,  
 galv. acc. to DIN 55928

# WICLINE 75

Flügelprofil im Blendrahmen, Klassik-Design  
Sash profile in frame, Classic design

Konstruktionsschnitt  
Construction section

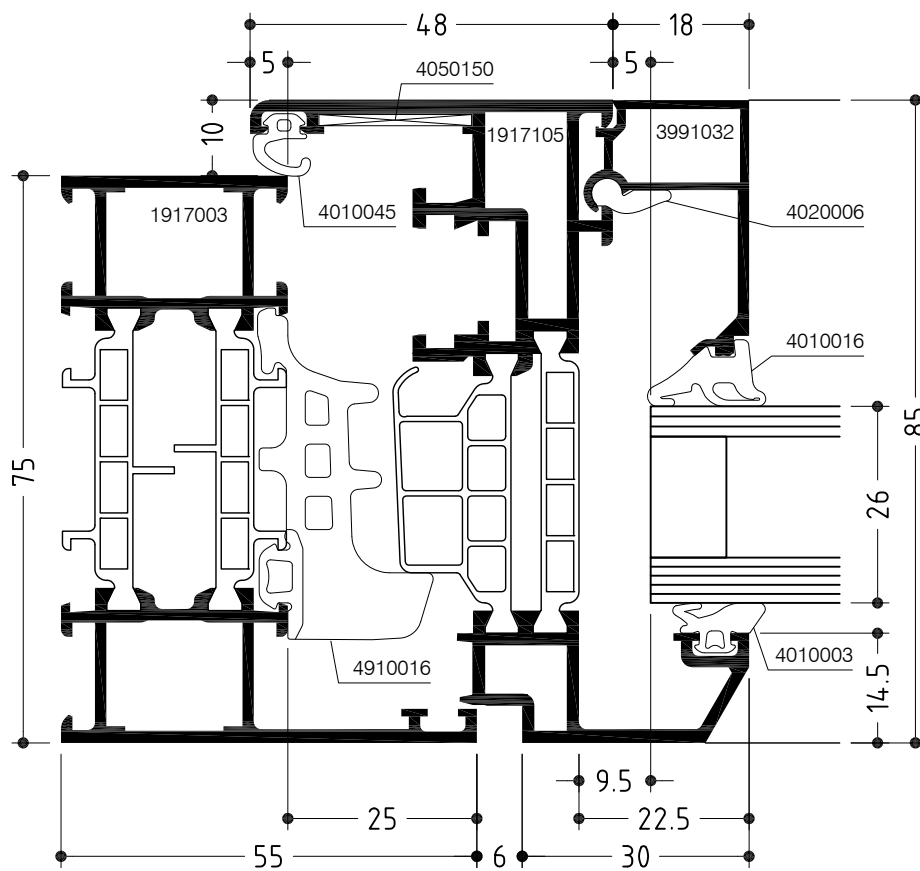

# WICLINE 75

Flügelprofil im Blendrahmen, Klassik-Design  
Sash profile in frame, Classic design

Konstruktionsschnitt  
Construction section

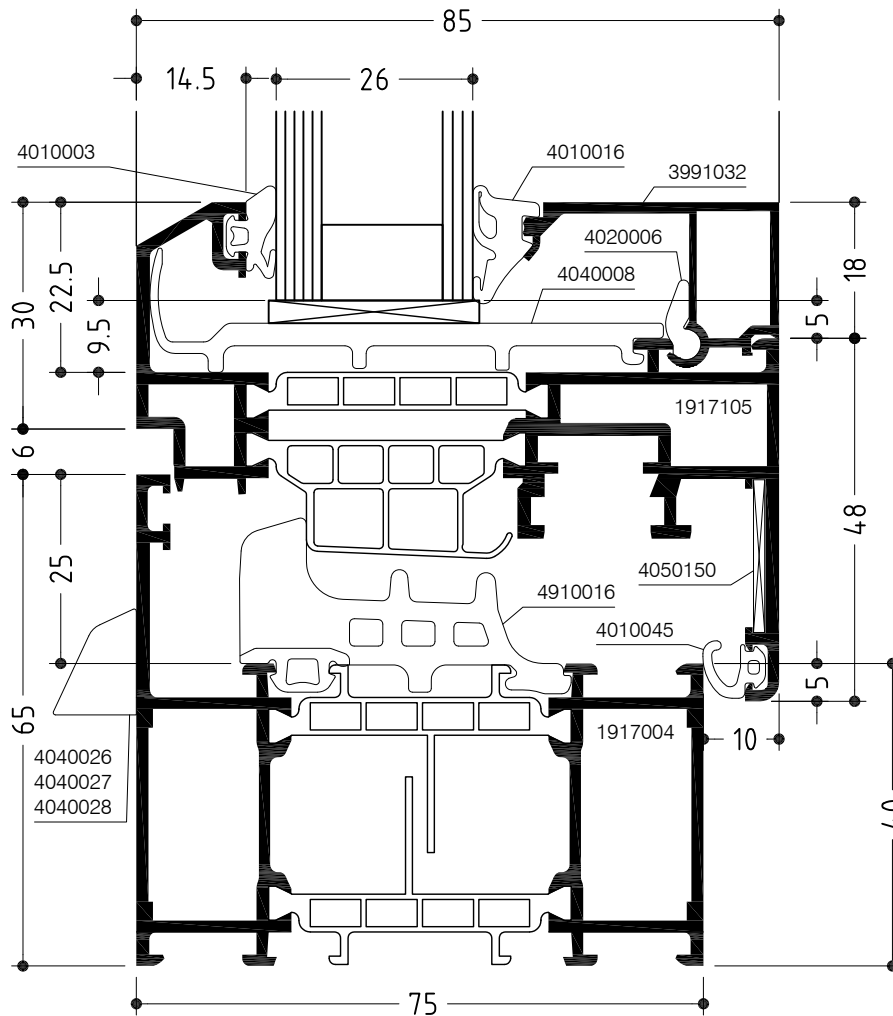

# WICLINE 75

Flügelprofil im Blendrahmen, Klassik-Design  
Sash profile in frame, Classic design

Konstruktionsschnitt  
Construction section

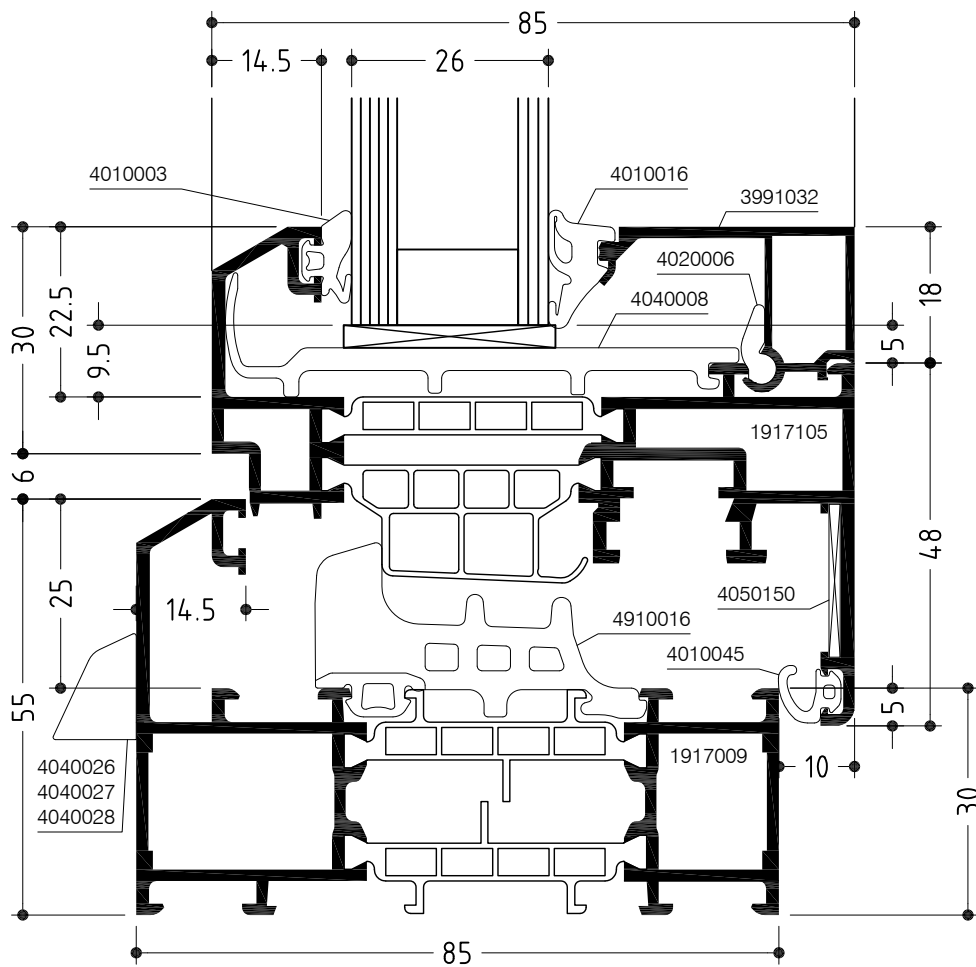

# WICLINE 75

Flügelprofil im Blendrahmen, Klassik-Design  
Sash profile in frame, Classic design

Konstruktionsschnitt  
Construction section

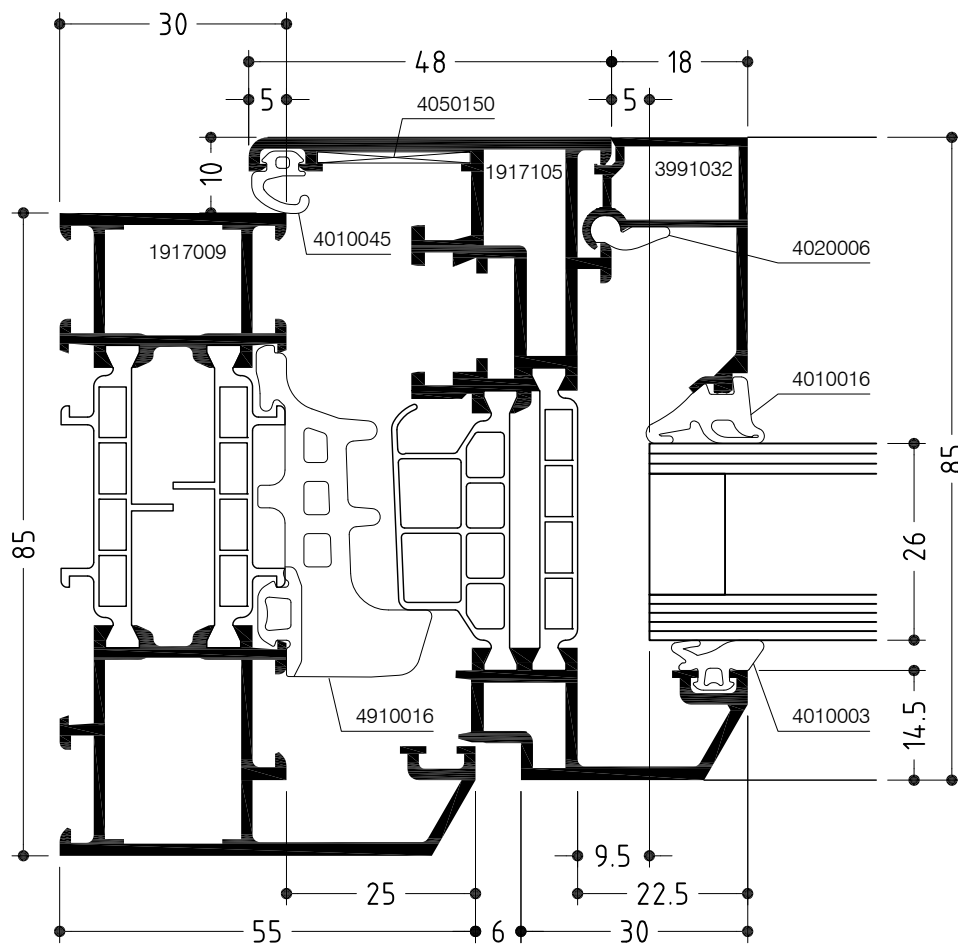



# WICLINE 75

Stulpfenster - Mittelstoß, Klassik-Design  
Double casement window - Meeting stiles, Classic design

Konstruktionsschnitt  
Construction section

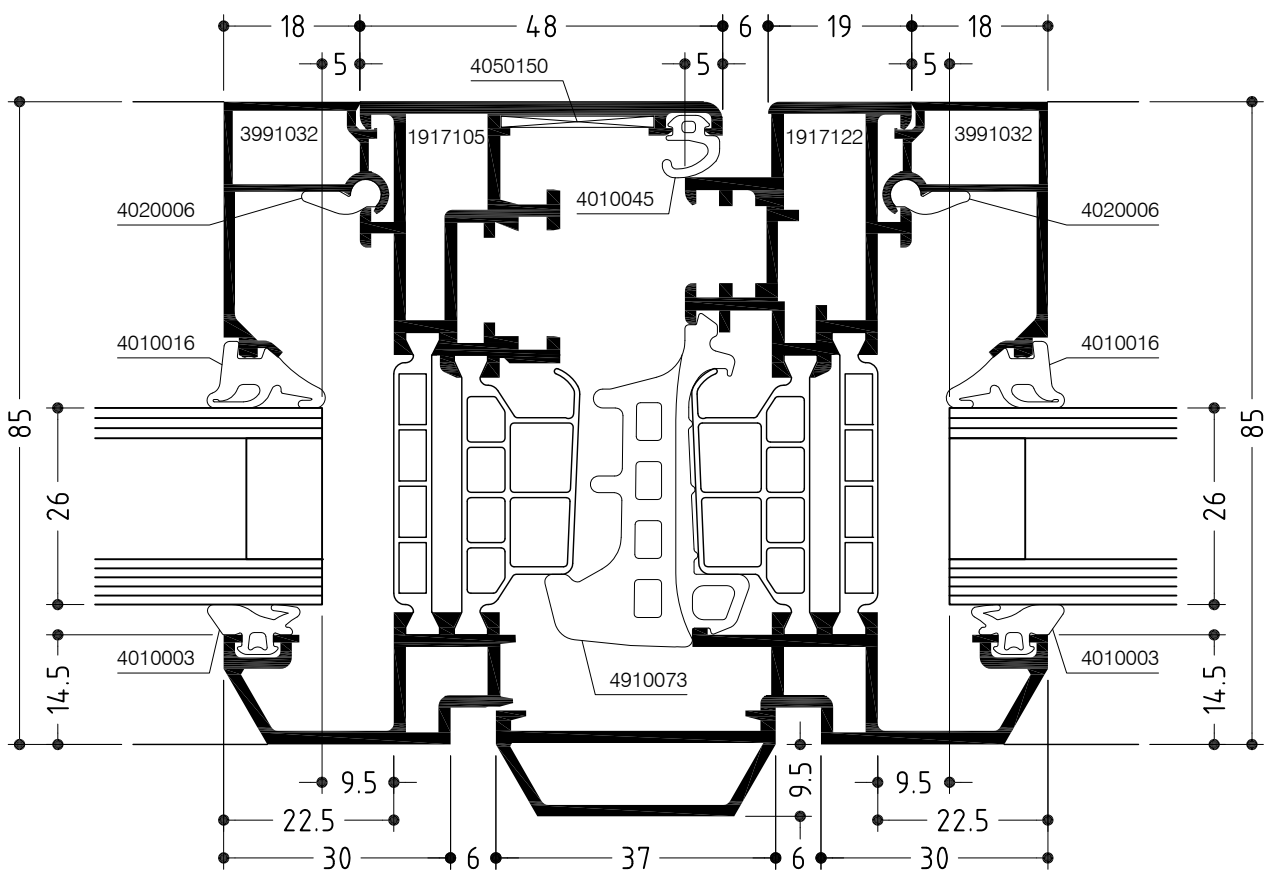
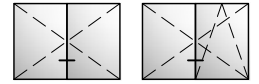

# WICLINE 75

Stulpfenster mit Aufsatzprofil - Mittelstoß, Klassik-Design  
Double casement window with supplm. profile - Meeting stiles, Classic design

Konstruktionsschnitt  
Construction section

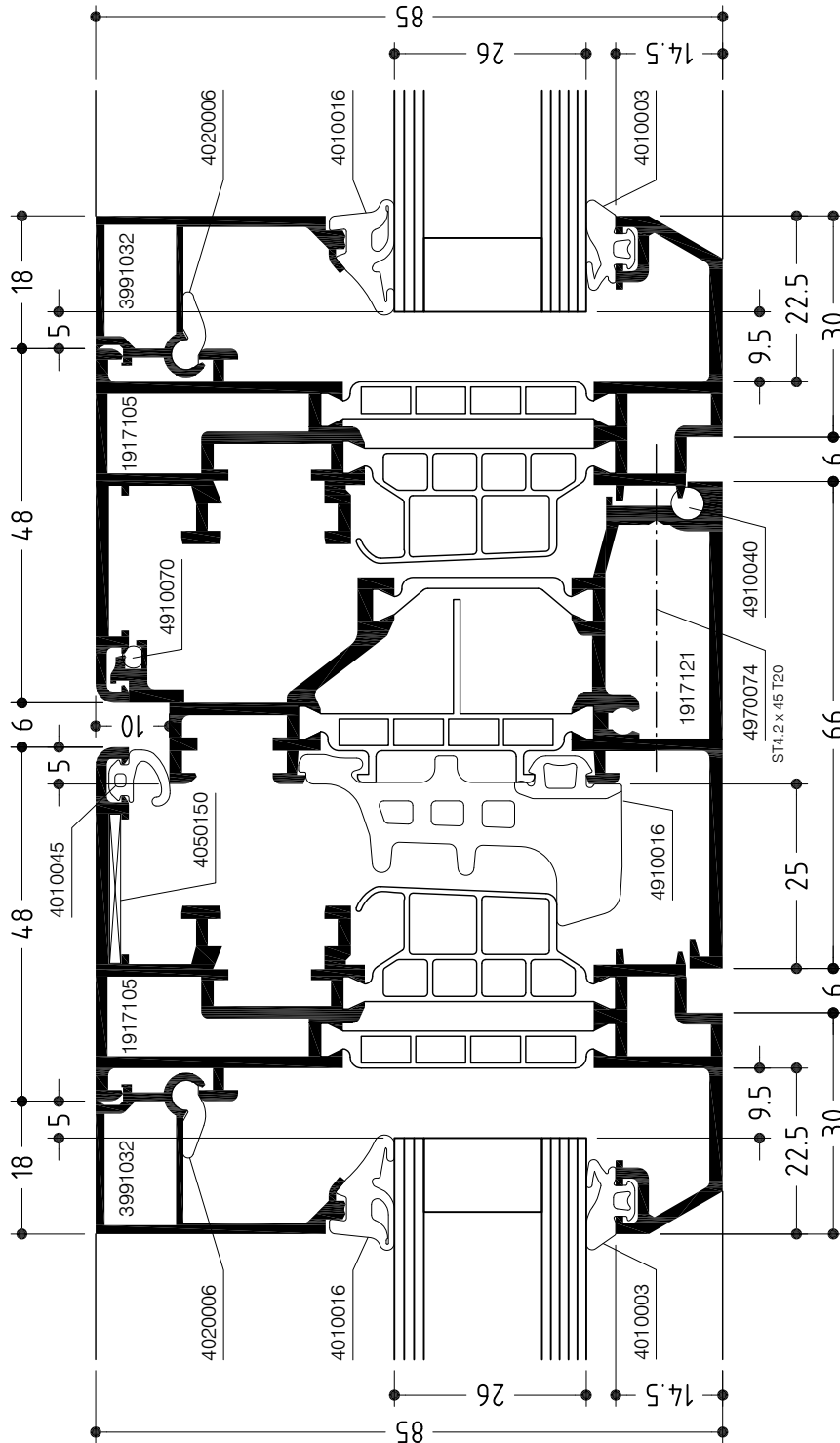
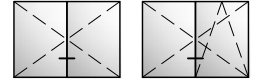



# WICLINE 75

Flügelprofil im Blendrahmen mit Kämpfer, Klassik-Design  
Sash profile in frame with transom, Classic design

Konstruktionsschnitt  
Construction section

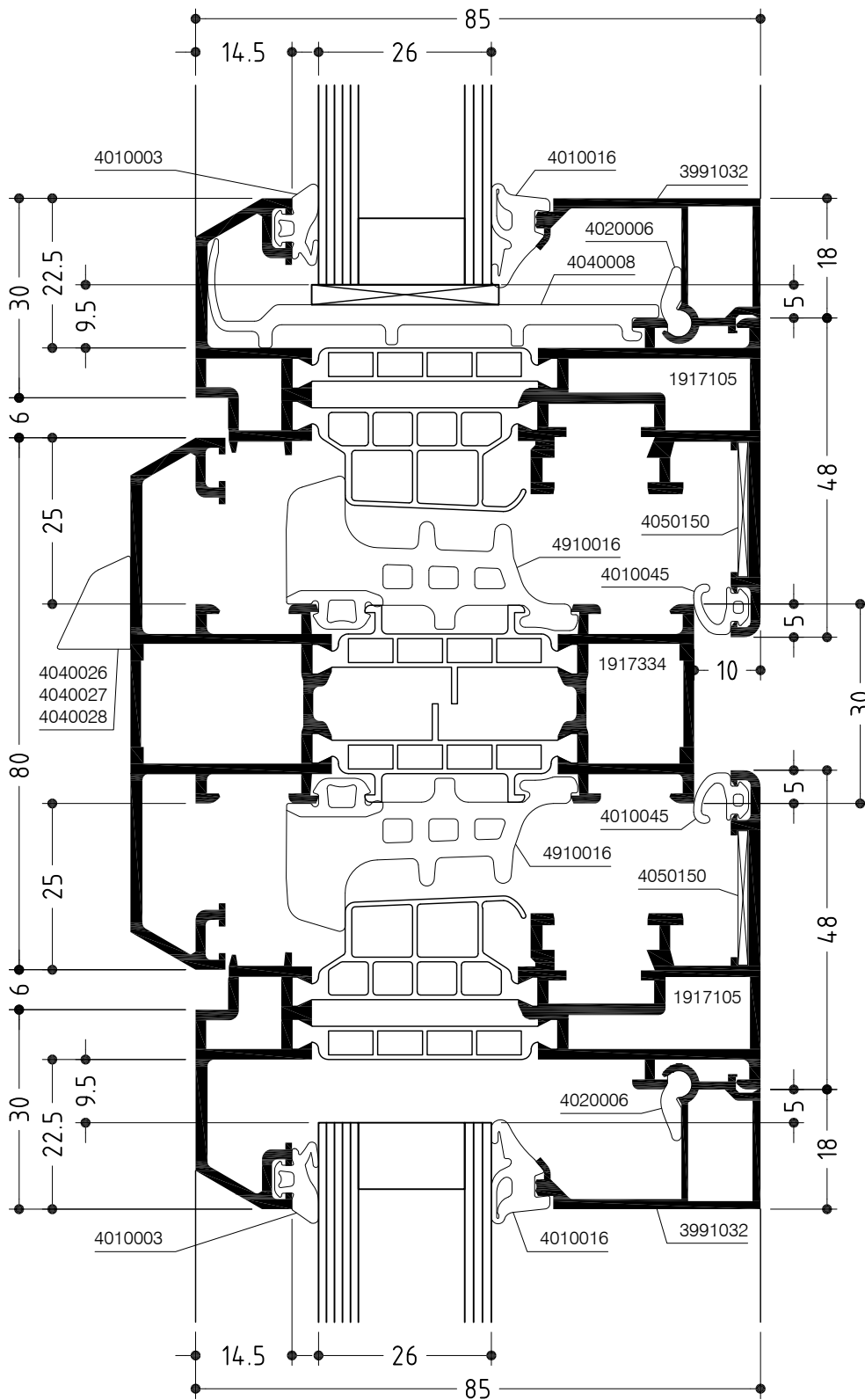
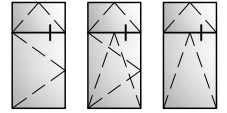



# WICLINE 75

Festverglasung mit Sprossenprofil, Klassik-Design  
 Fixed glazing with glazing bar profile, Classic design

Konstruktionsschnitt  
 Construction section

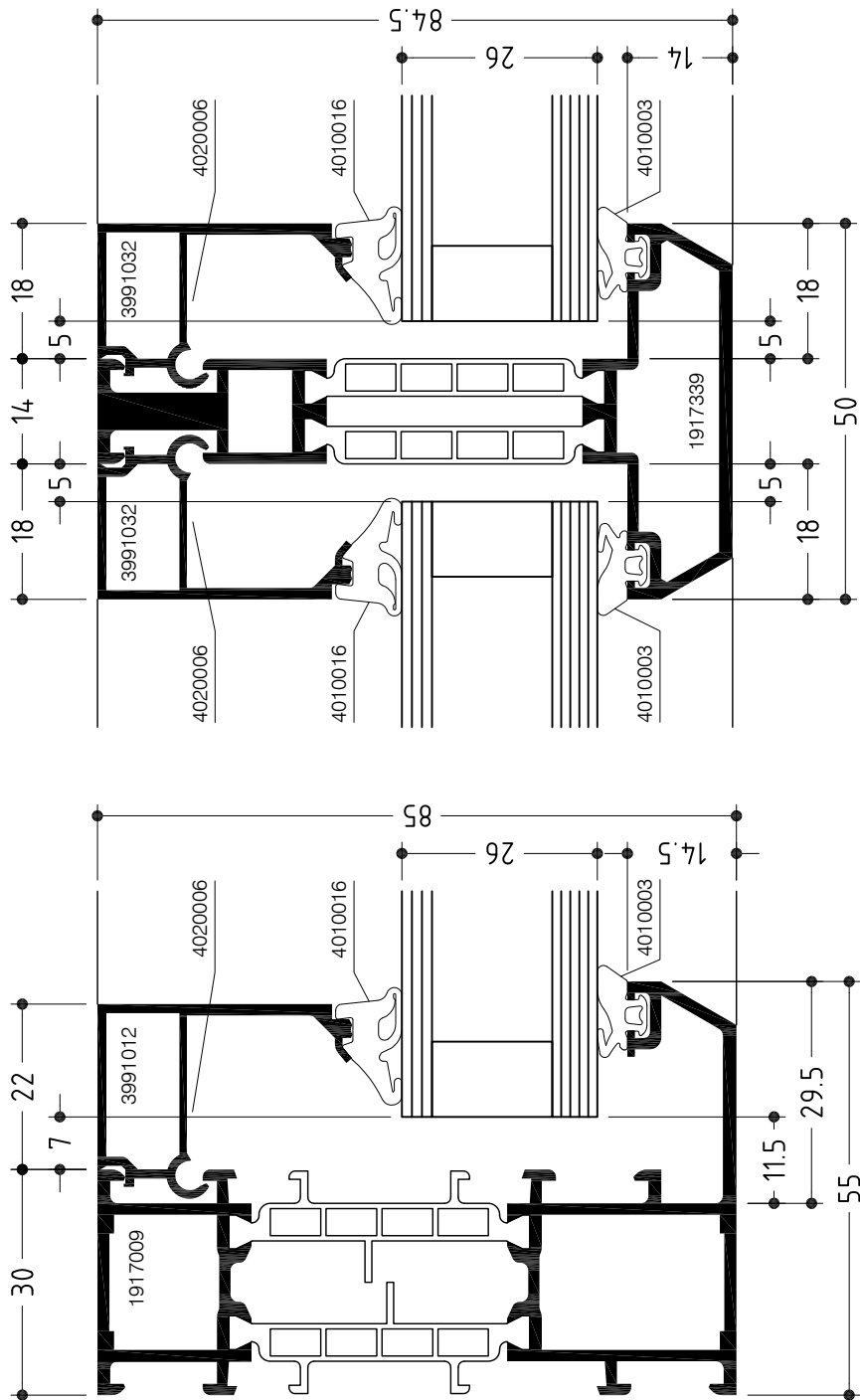

# WICLINE 75

Flügelprofil im Blendrahmen mit Ziersprossenprofil, Klassik-Design  
Sash profile in frame with glazing bar profile, Classic design

Konstruktionsschnitt  
Construction section

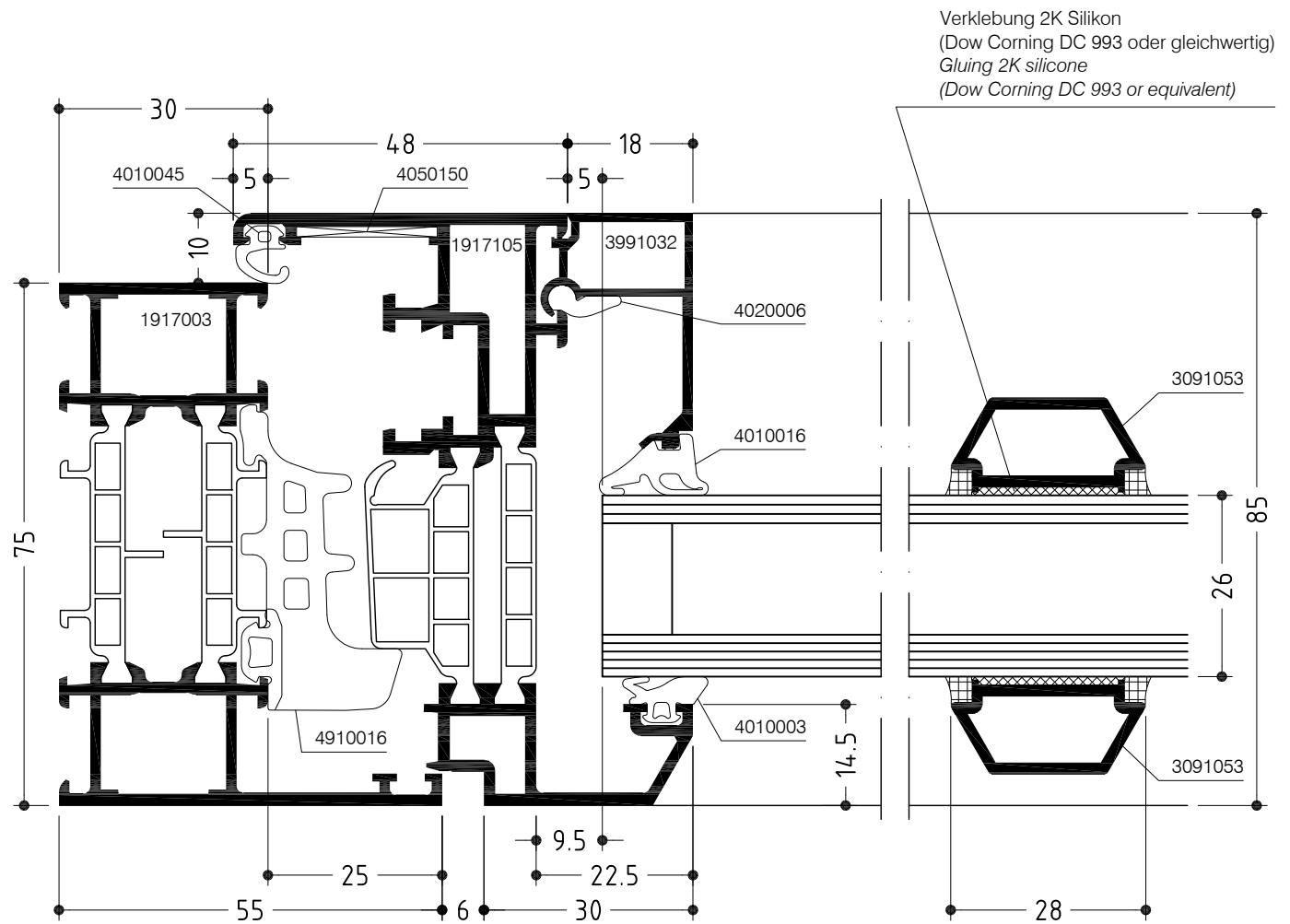

# WICLINE 75

Flügelprofil im Dehnstoßblendrahmen, Klassik-Design  
Sash profile in expansion joint frame, Classic design

Konstruktionsschnitt  
Construction section

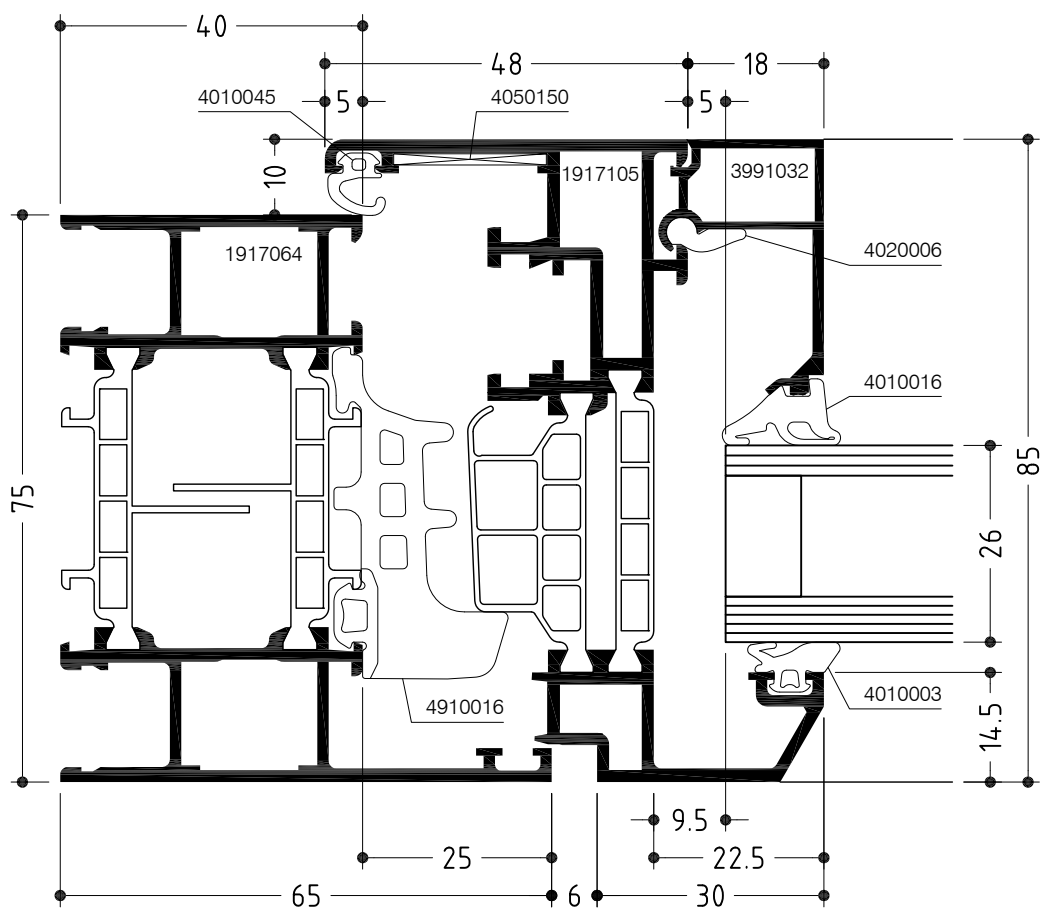



# WICLINE 75

## Konstruktionsschnitt

### Construction section

Flügelprofil im Einspannblendrahmen, Klassik-Design

Sash profile in clamping frame, Classic design

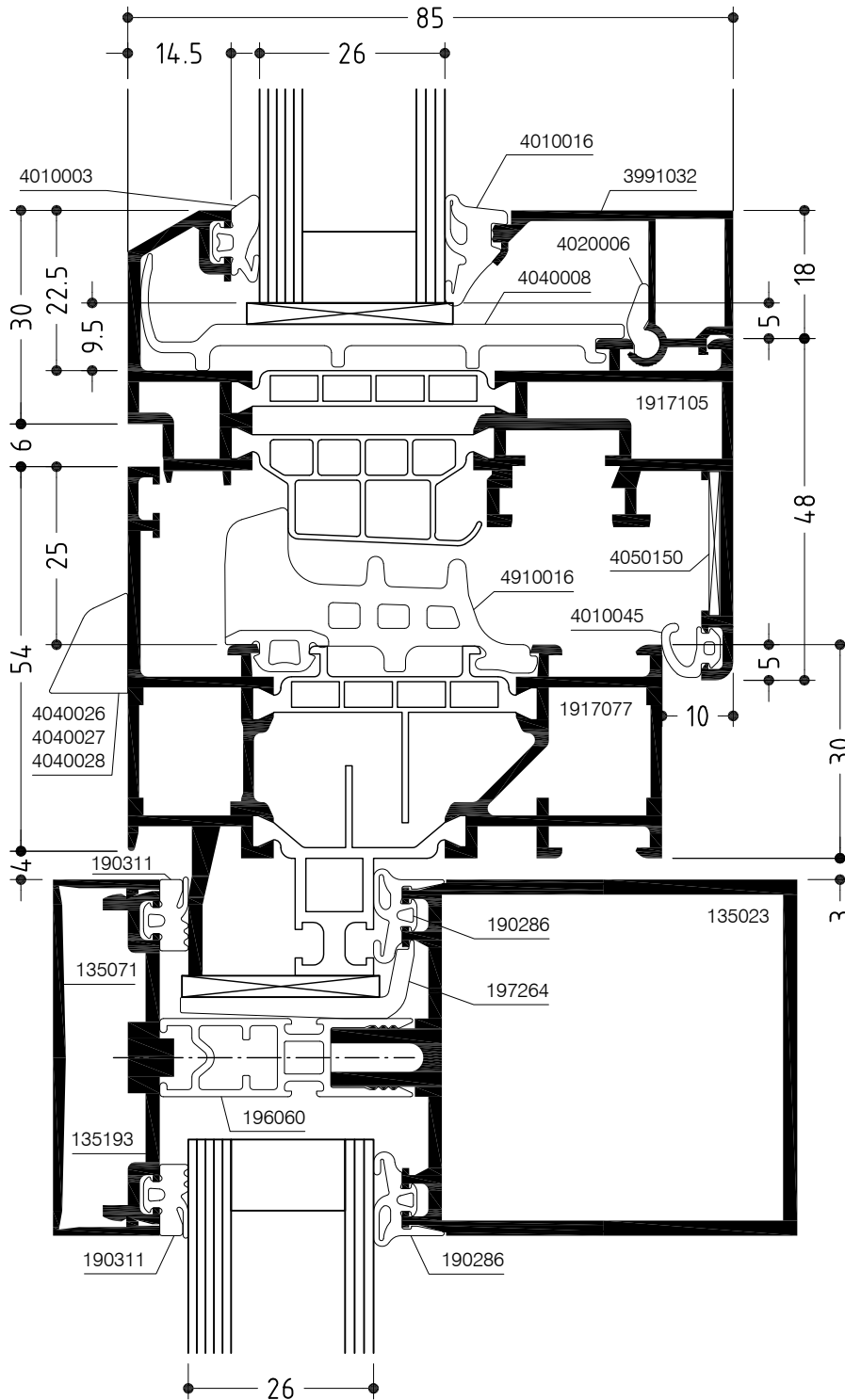

# WICLINE 75

## Konstruktionsschnitt

### Construction section

Bauanschluss unten mit Dämmauflage 4030365, Klassik-Design

Bottom junction to structure with insulation support 4030365, Classic design

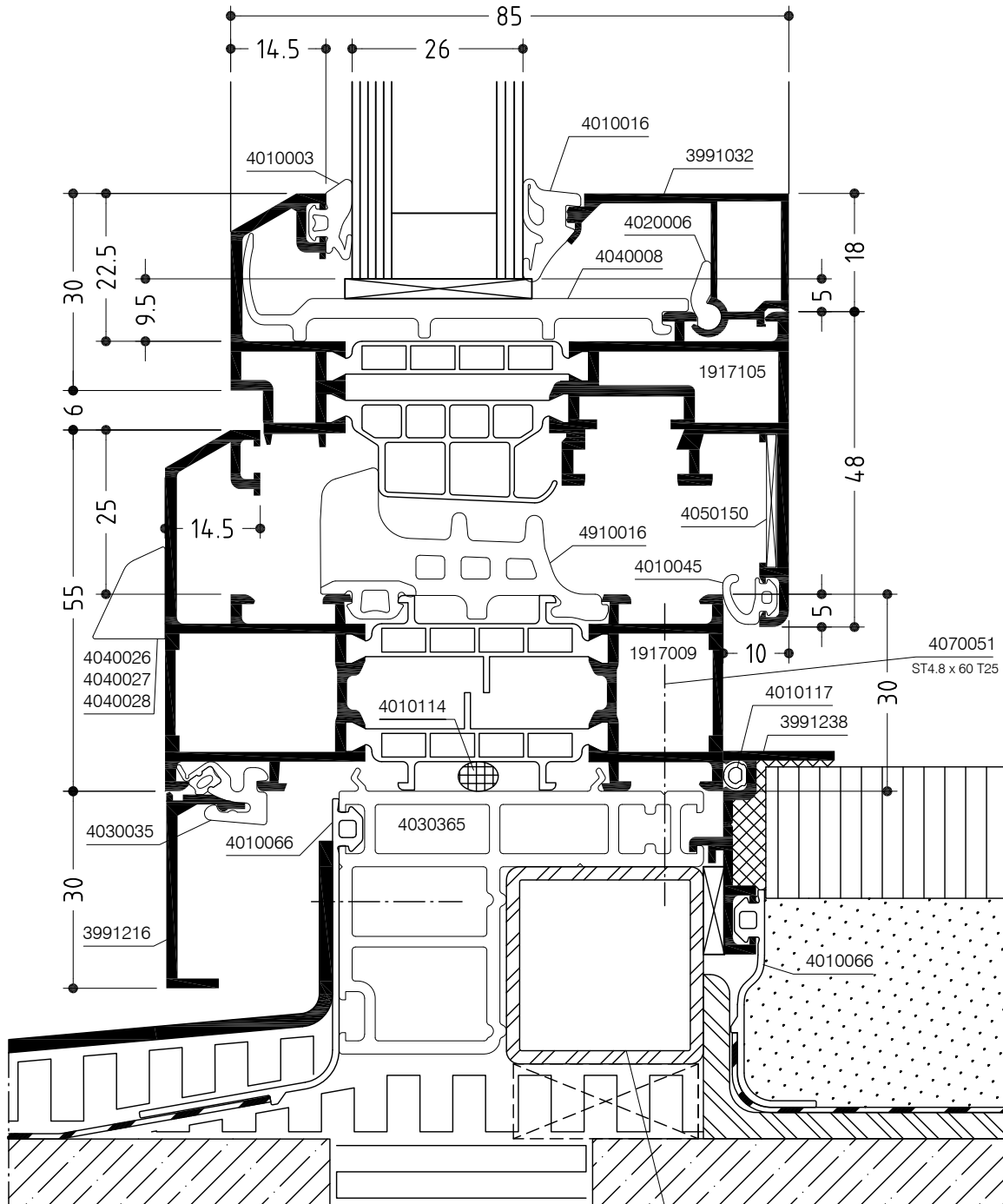

Stahlrohr 30 x 30 x 2.5  
verzinkt nach DIN 55928  
30 x 30 x 2.5 Steel tube,  
galv. acc. to DIN 55928

# WICLINE 75

Flügelprofil im Blendrahmen, verdeckter Flügel  
Concealed sash in frame

Konstruktionsschnitt  
Construction section

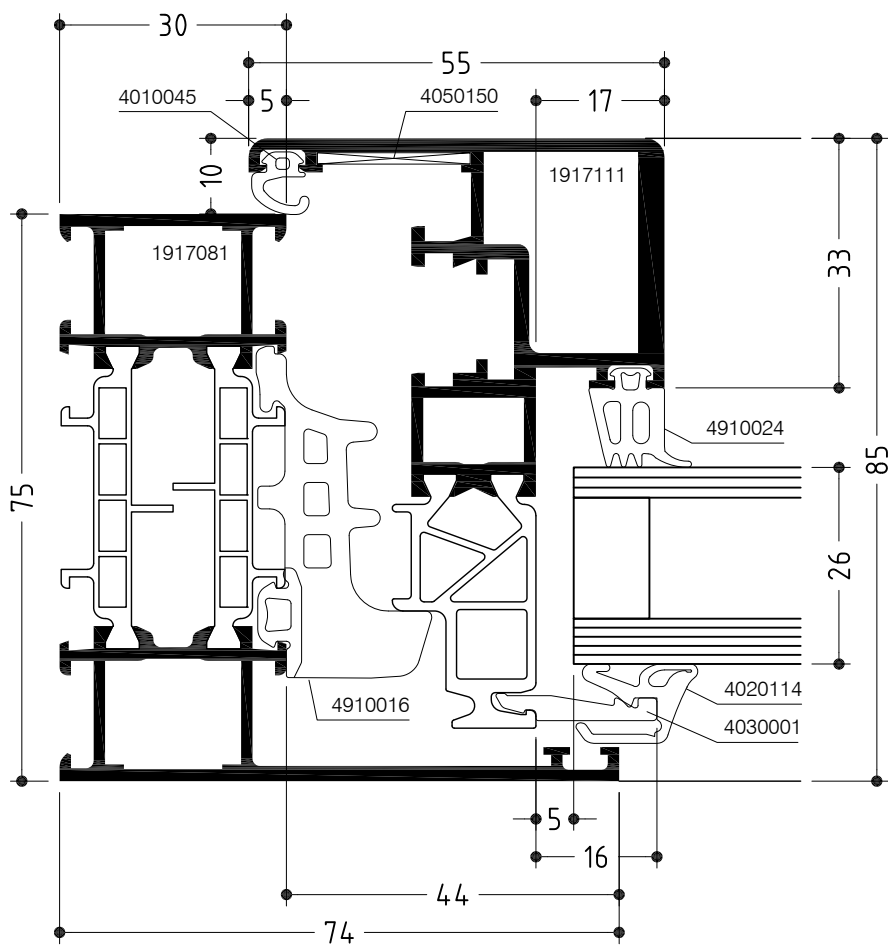

# WICLINE 75

Flügelprofil im Blendrahmen, verdeckter Flügel  
Concealed sash in frame

Konstruktionsschnitt  
Construction section

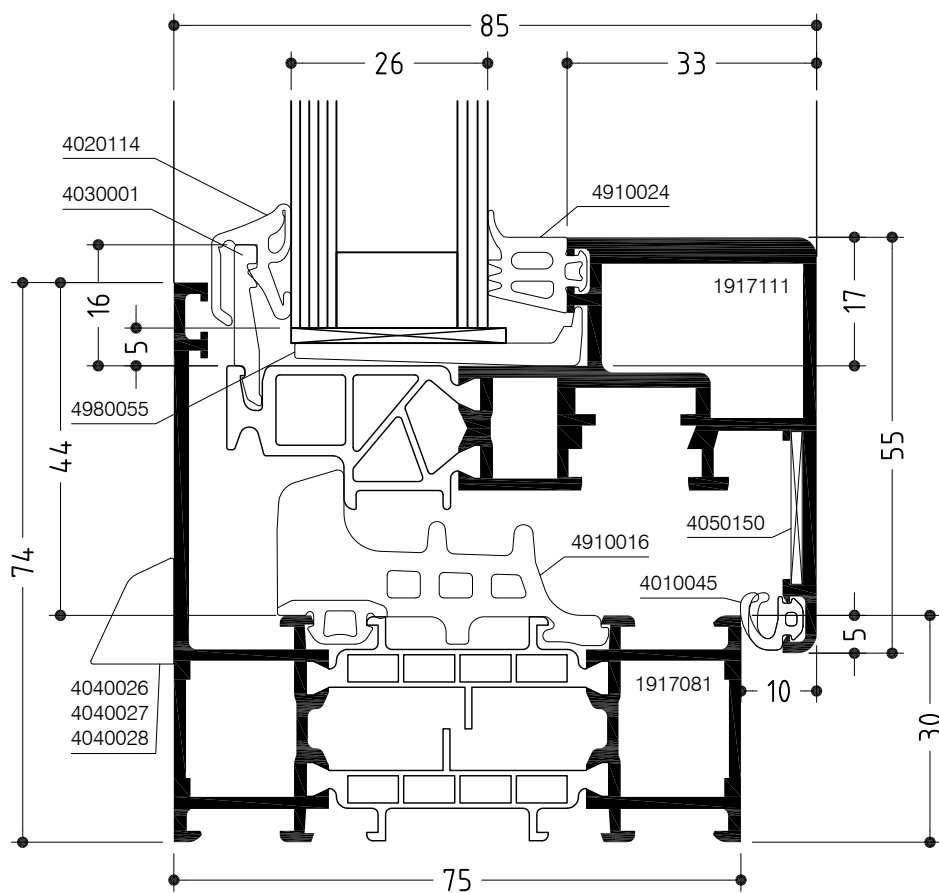

# WICLINE 75

Verdeckte Entwässerung, verdeckter Flügel  
Concealed drainage, concealed sash in frame

Konstruktionsschnitt  
Construction section

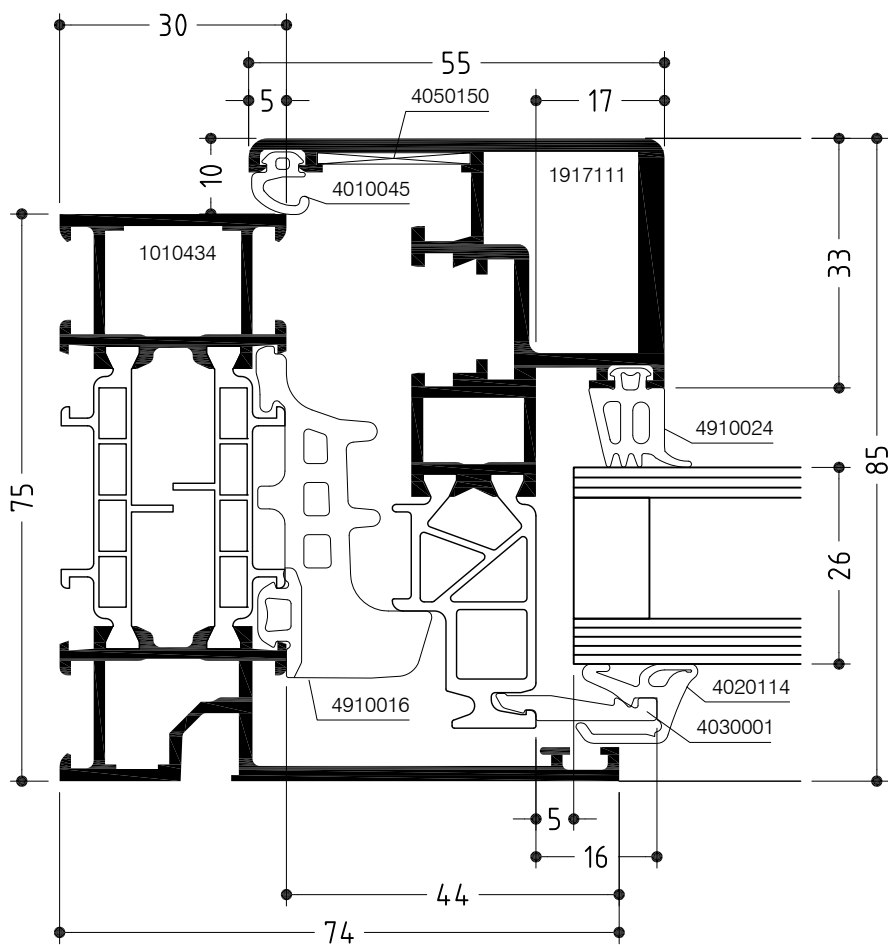

# WICLINE 75

Flügelprofil im Blendrahmen, verdeckter Flügel  
Concealed sash in frame

Konstruktionsschnitt  
Construction section

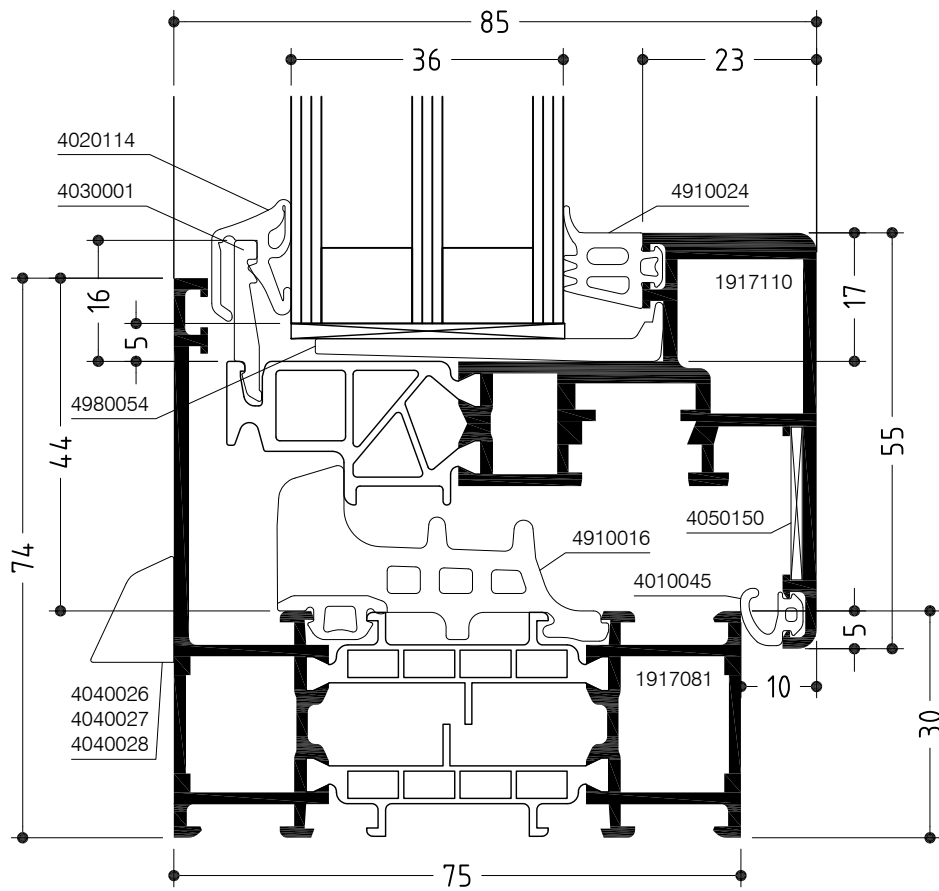

# WICLINE 75

Flügelprofil im Blendrahmen, verdeckter Flügel  
Concealed sash in frame

Konstruktionsschnitt  
Construction section

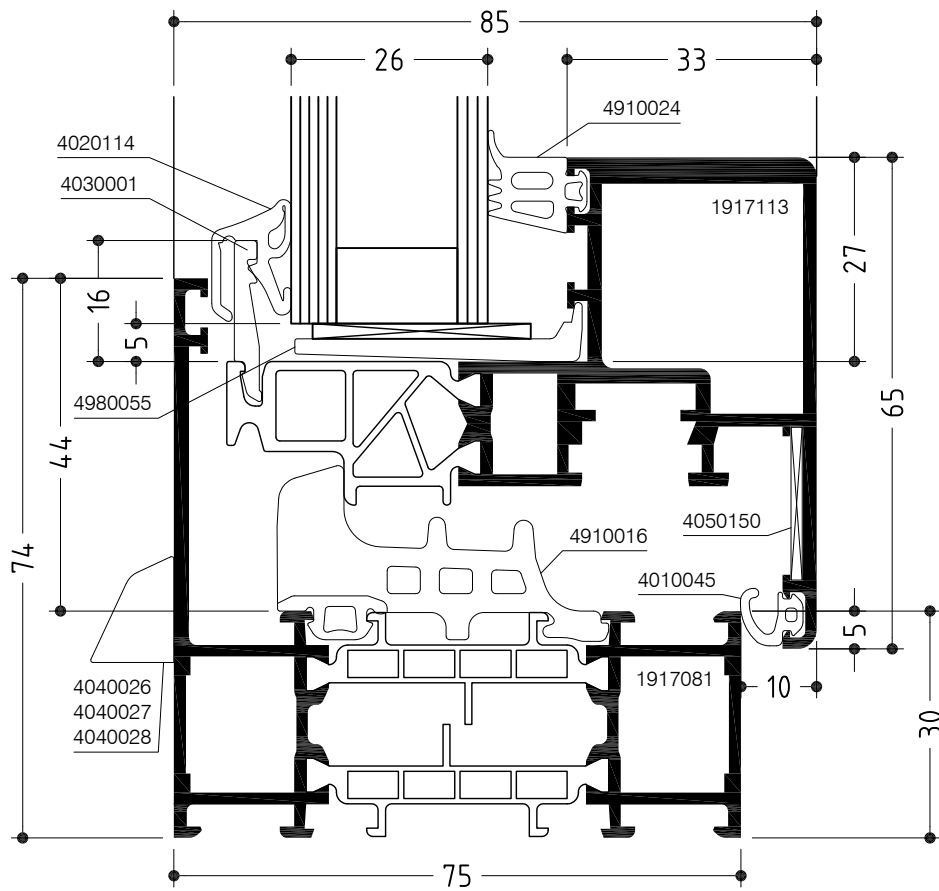

# WICLINE 75

Flügelprofil im Blendrahmen, verdeckter Flügel  
Concealed sash in frame

Konstruktionsschnitt  
Construction section

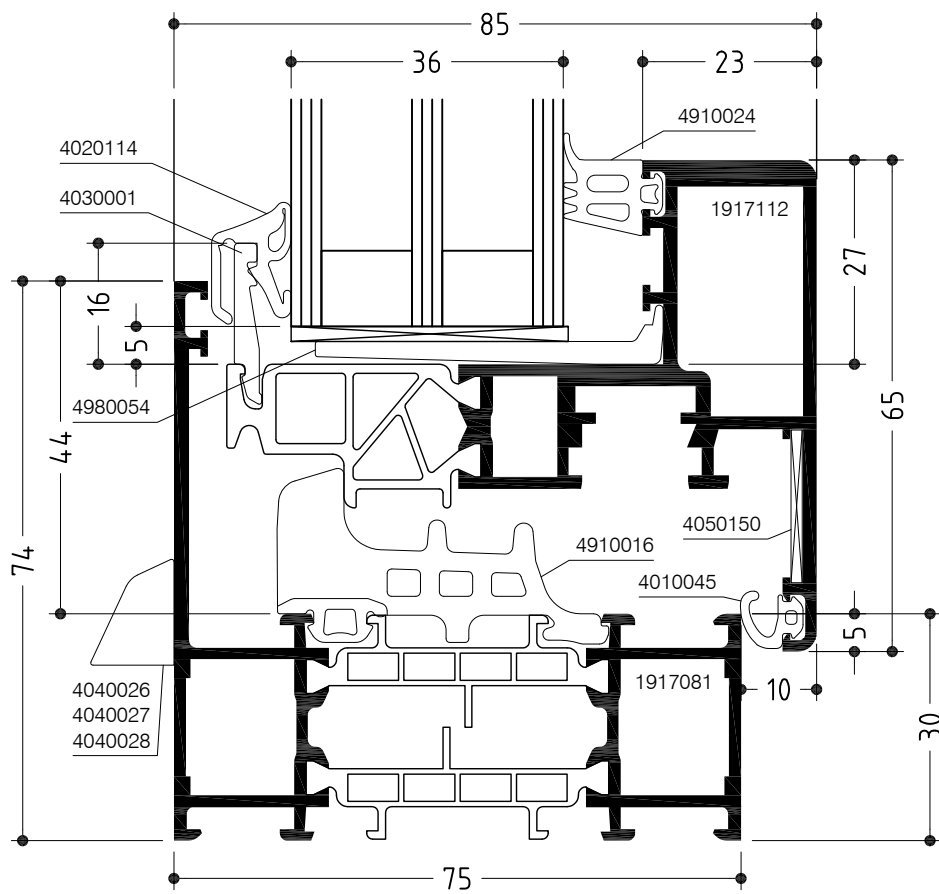



# WICLINE 75

Konstruktionsschnitt

Construction section

Stulpfenster - Mittelstoß, verdeckter Flügel

Double casement window with concealed sash - Meeting stiles

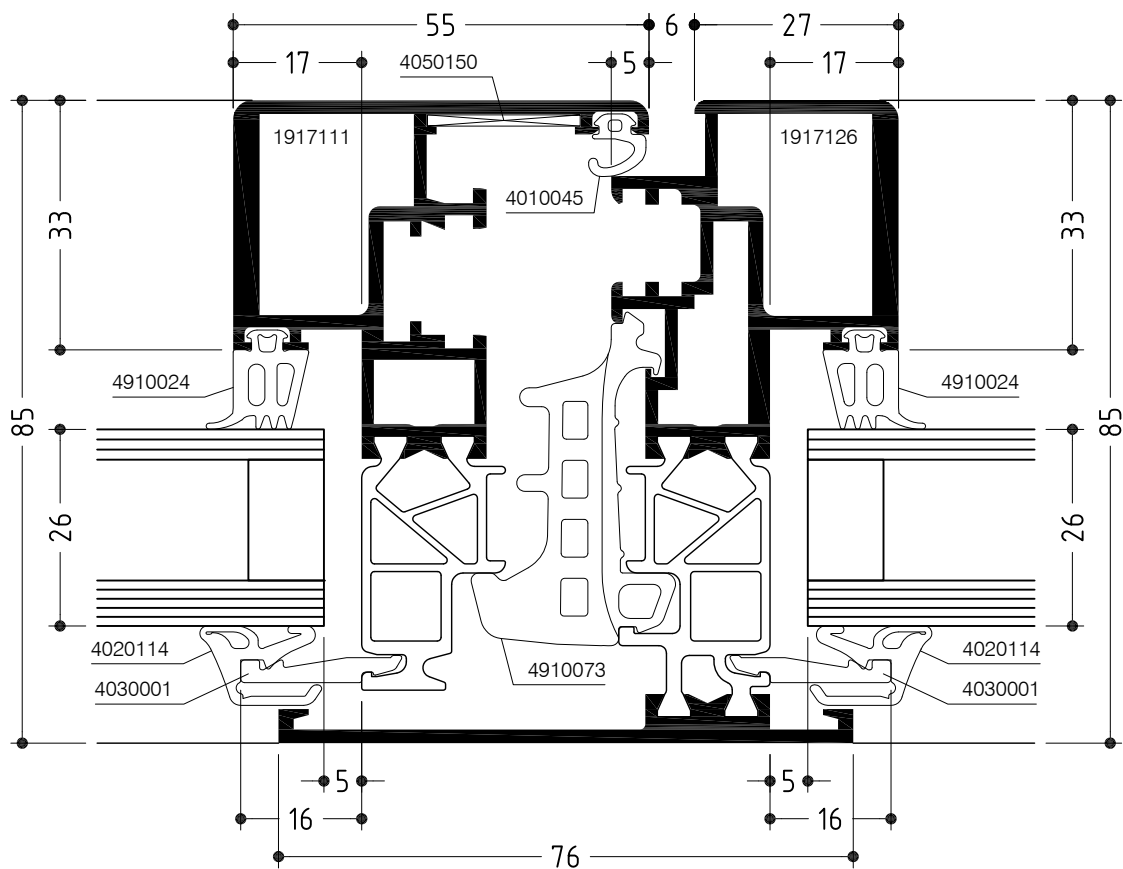
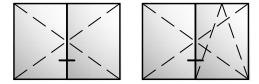

# WICLINE 75

## Konstruktionsschnitt

### Construction section

Stulpfenster - Mittelstoß, verdeckter Flügel

Double casement window with concealed sash - Meeting stiles

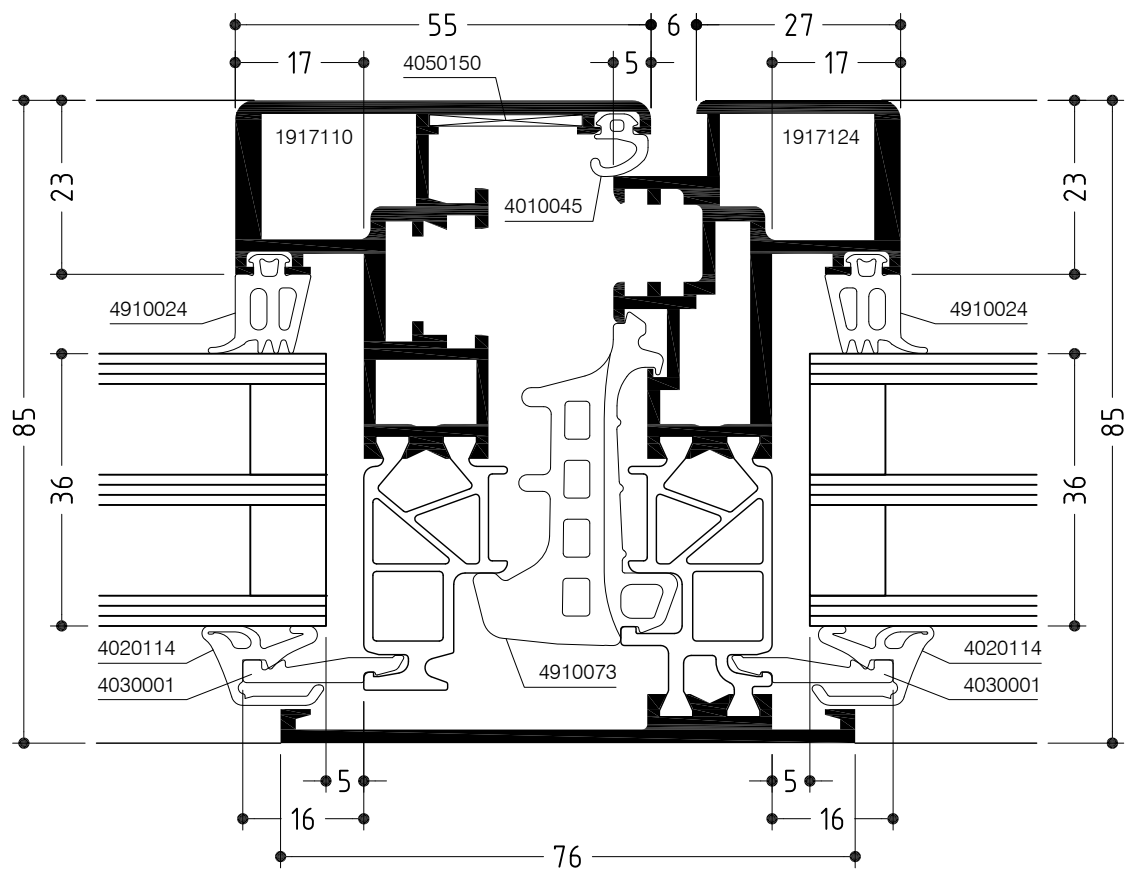
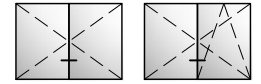

# WICLINE 75

## Konstruktionsschnitt

### Construction section

Flügelprofil im Blendrahmen mit Kämpfer, verdeckter Flügel

Concealed sash in frame with transom

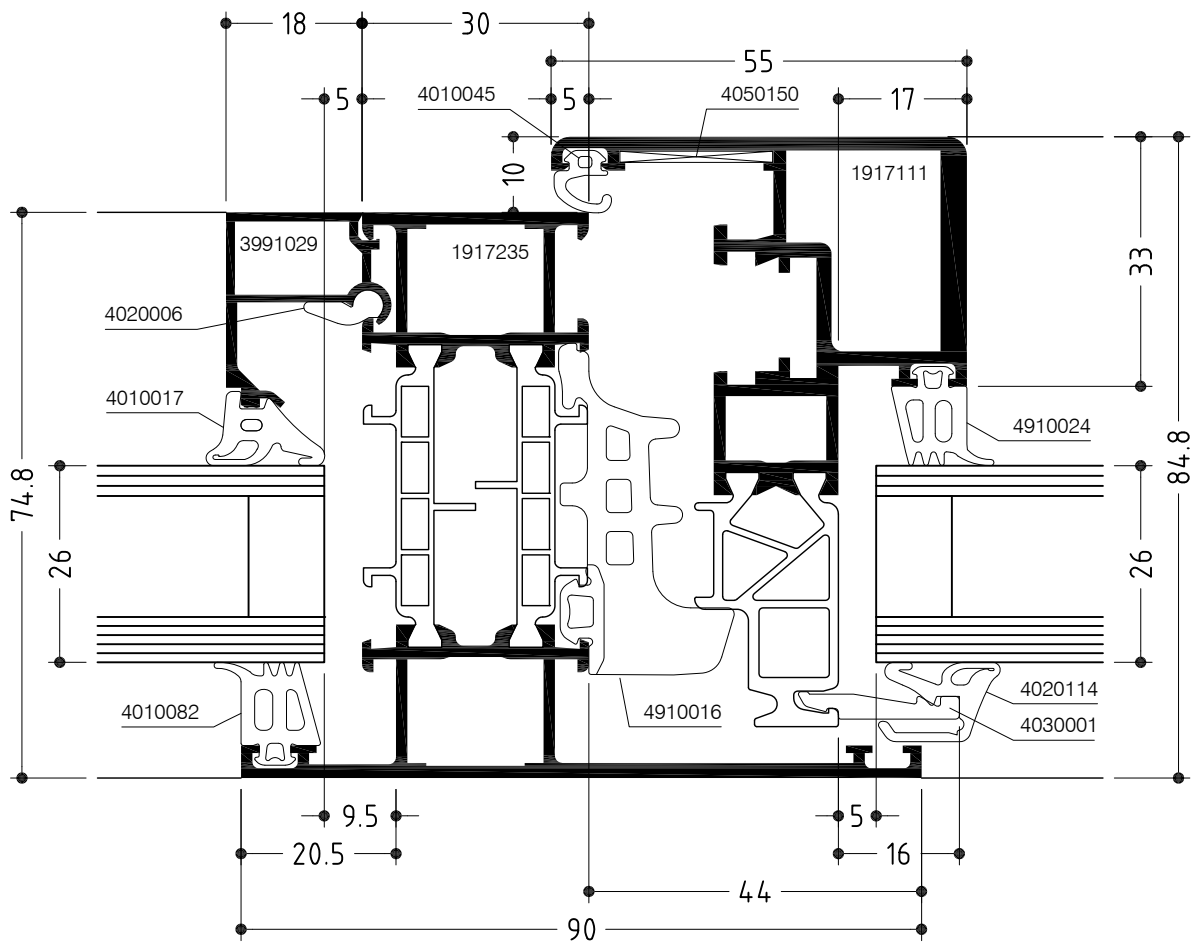
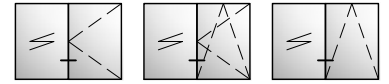

# WICLINE 75

## Konstruktionsschnitt

### Construction section

Flügelprofil im Blendrahmen mit Kämpfer, verdeckter Flügel

Concealed sash in frame with transom

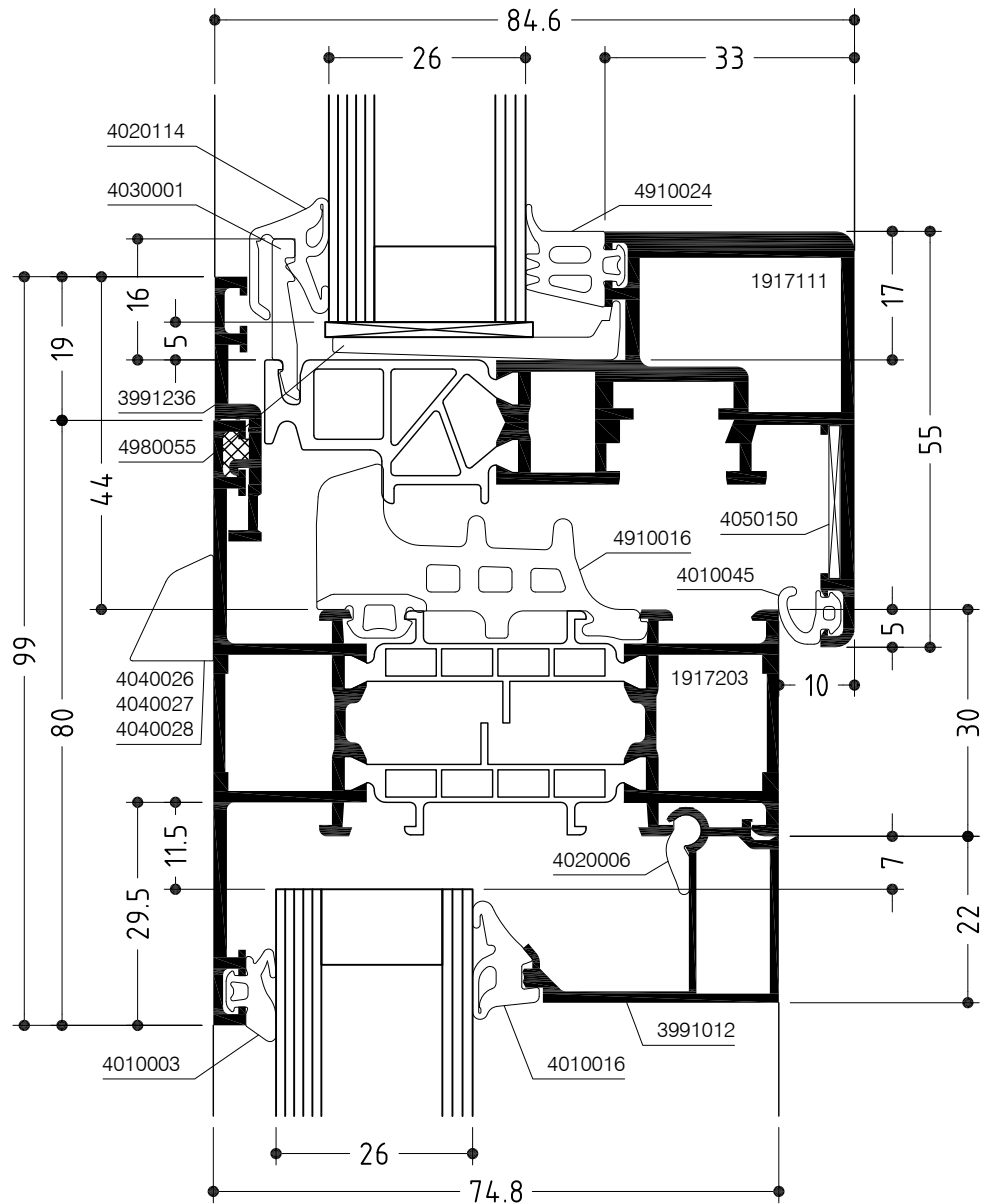
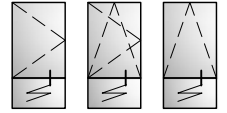

# WICLINE 75

## Konstruktionsschnitt

### Construction section

Flügelprofil im Blendrahmen mit Kämpfer, verdeckter Flügel

Concealed sash in frame with transom

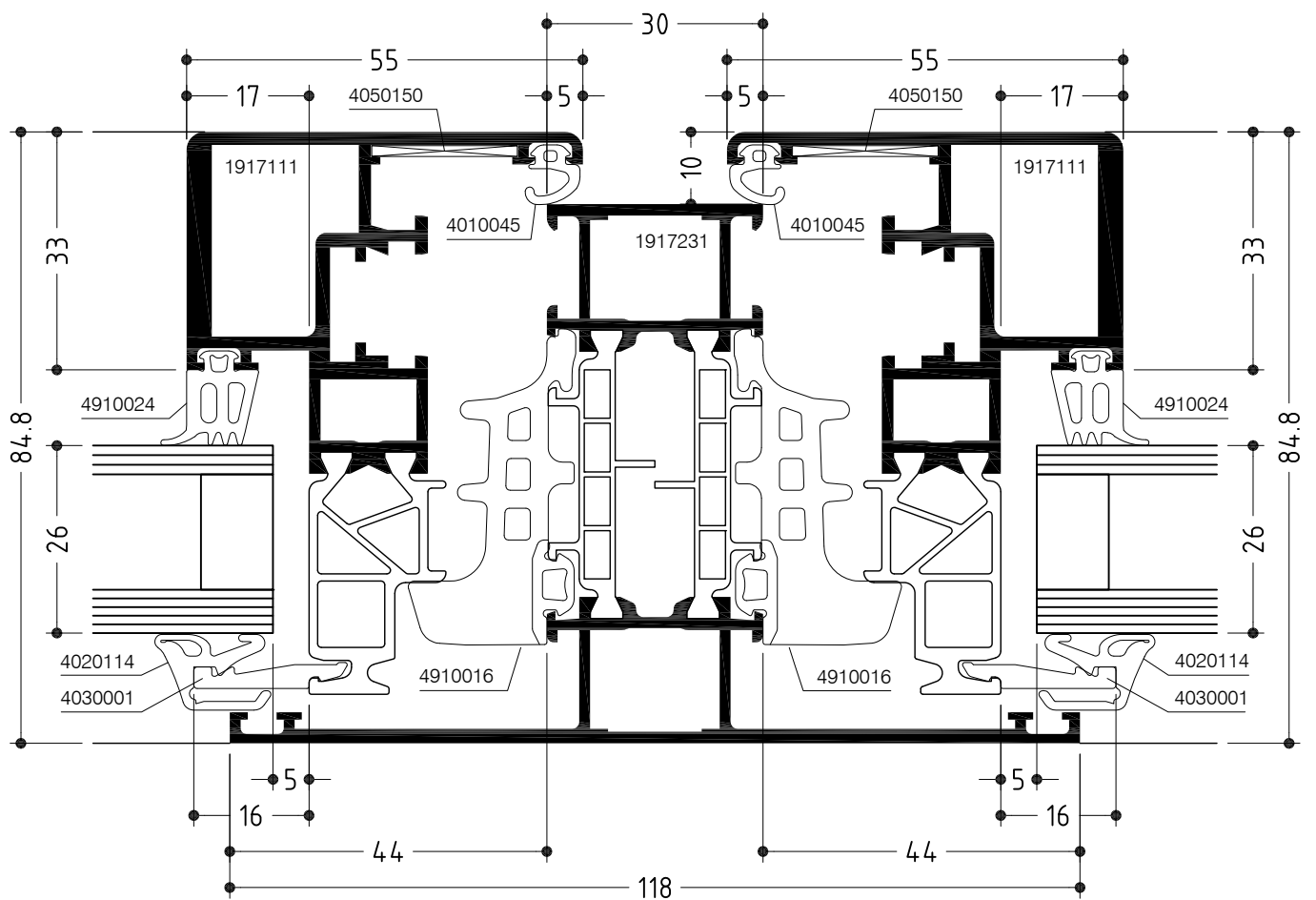
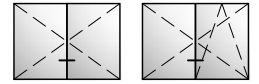

# WICLINE 75

## Konstruktionsschnitt

### Construction section

Flügelprofil im Blendrahmen mit Kämpfer, verdeckter Flügel

Concealed sash in frame with transom

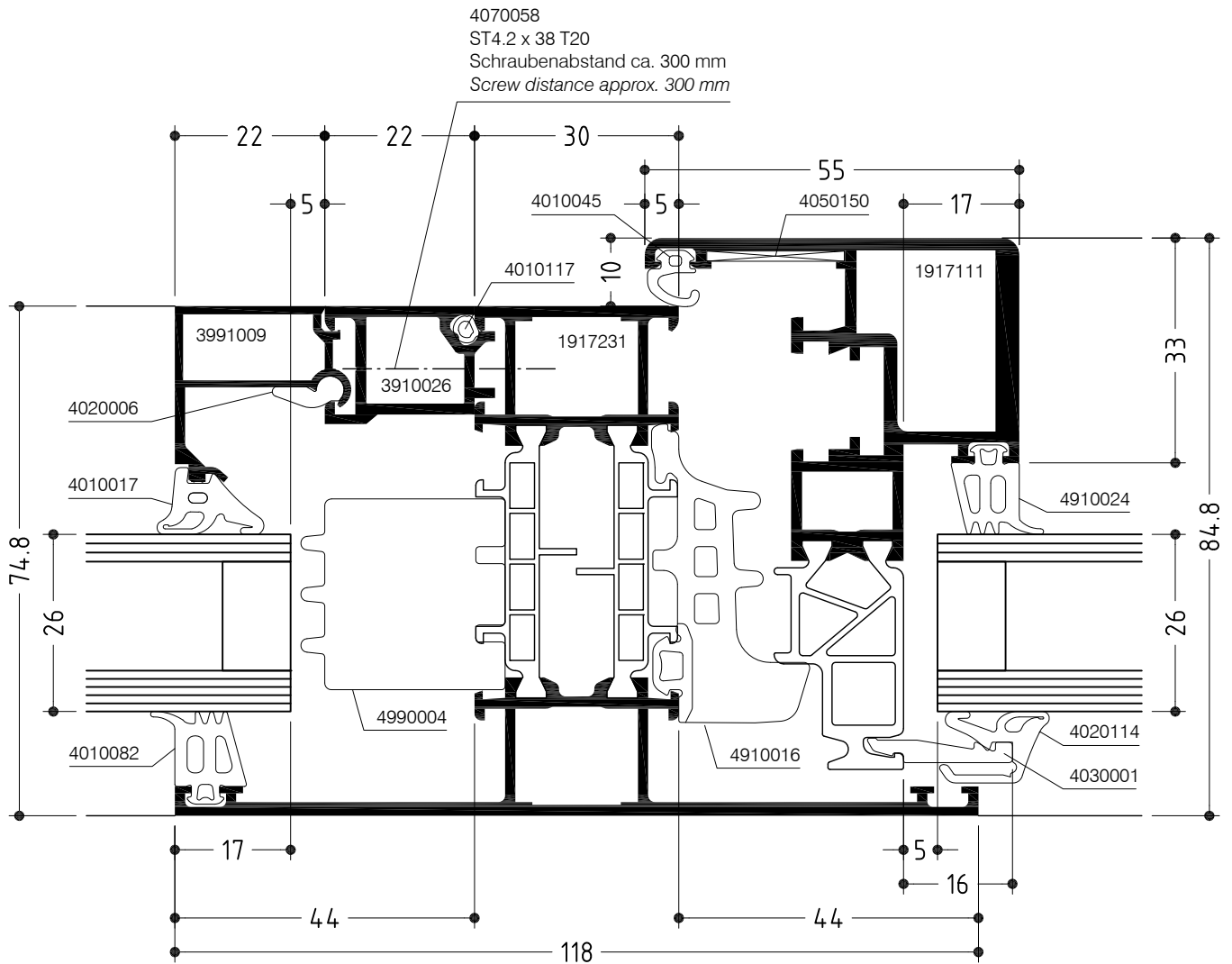
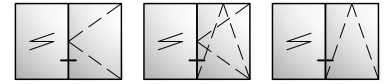

# WICLINE 75

## Konstruktionsschnitt

### Construction section

Flügelprofil im Blendrahmen mit Kämpfer, verdeckter Flügel

Concealed sash in frame with transom

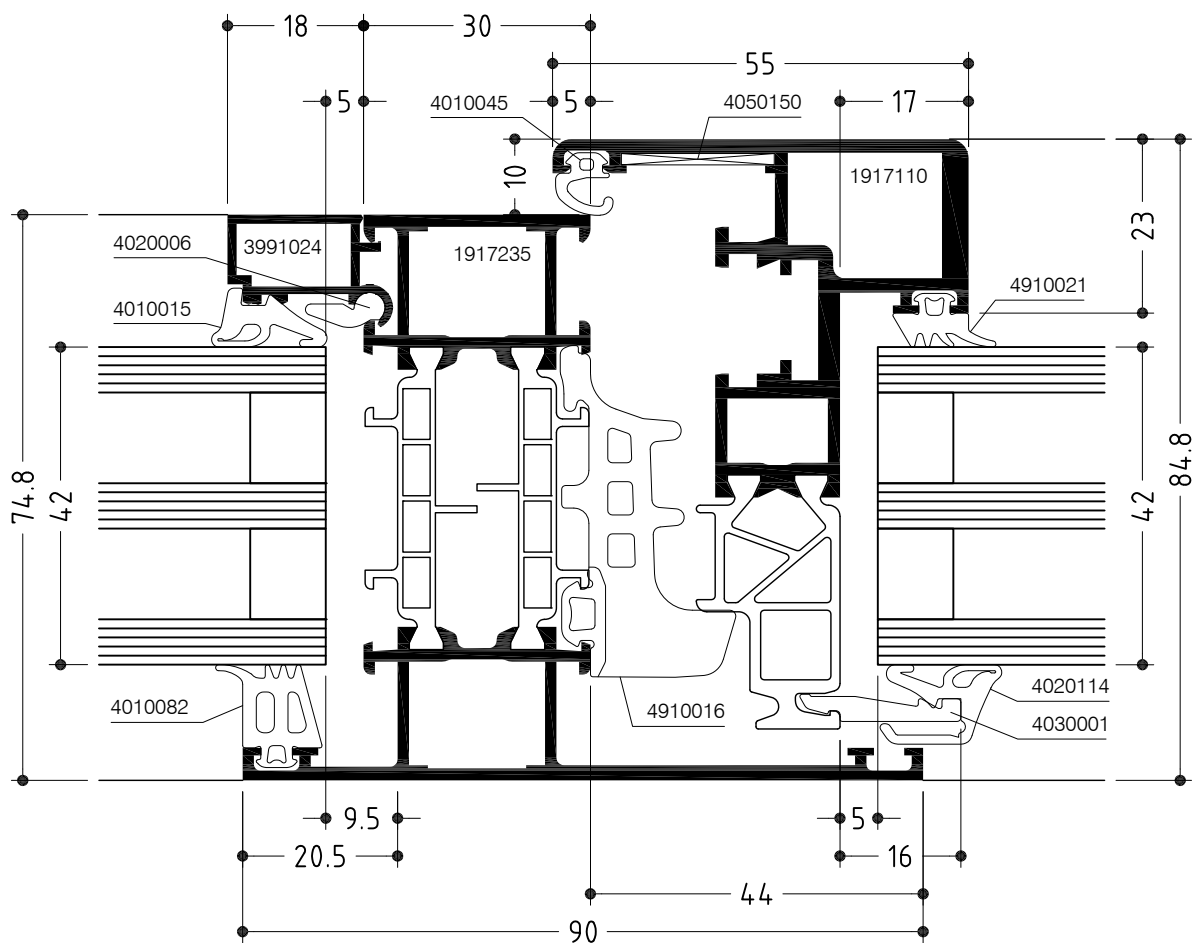
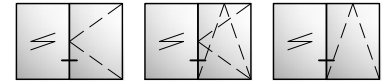

# WICLINE 75

Festverglasung, verdeckter Flügel  
Fixed glazing with frame of concealed sash

Konstruktionsschnitt  
Construction section

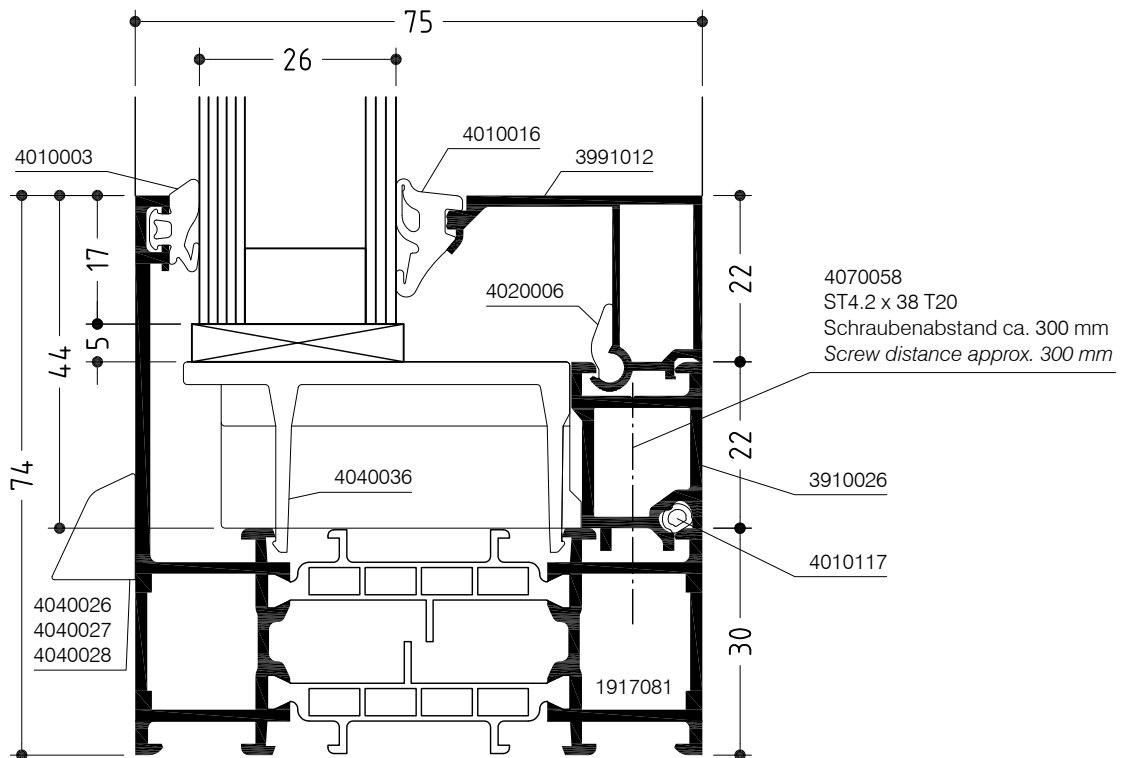



# WICLINE 75

Konstruktionsschnitt

Construction section

Flügelprofil im Dehnstoßblendrahmen, verdeckter Flügel

Concealed sash in expansion joint frame

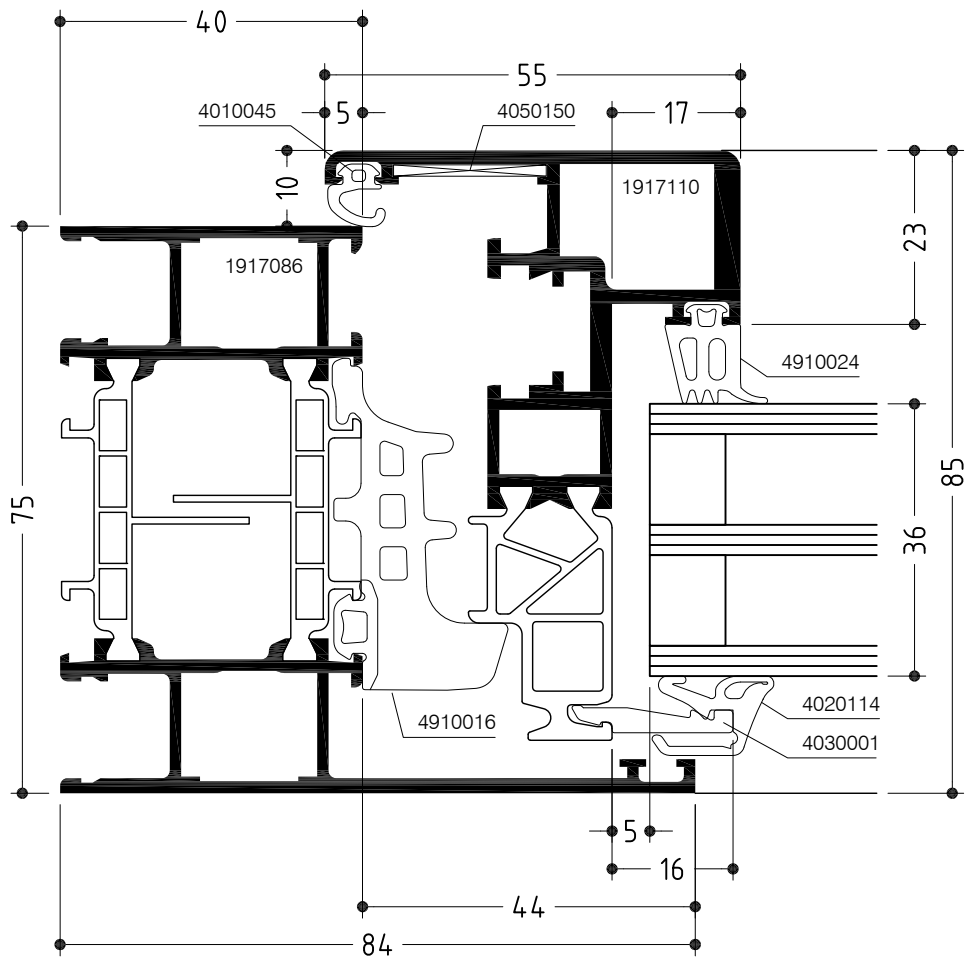



# WICLINE 75

## Konstruktionsschnitt

### Construction section

Blendrahmen mit Einspannaufsatz und Befestigungsteil,  
verdeckter Flügel

Frame with supplementary clamping profile and fixing part, concealed sash

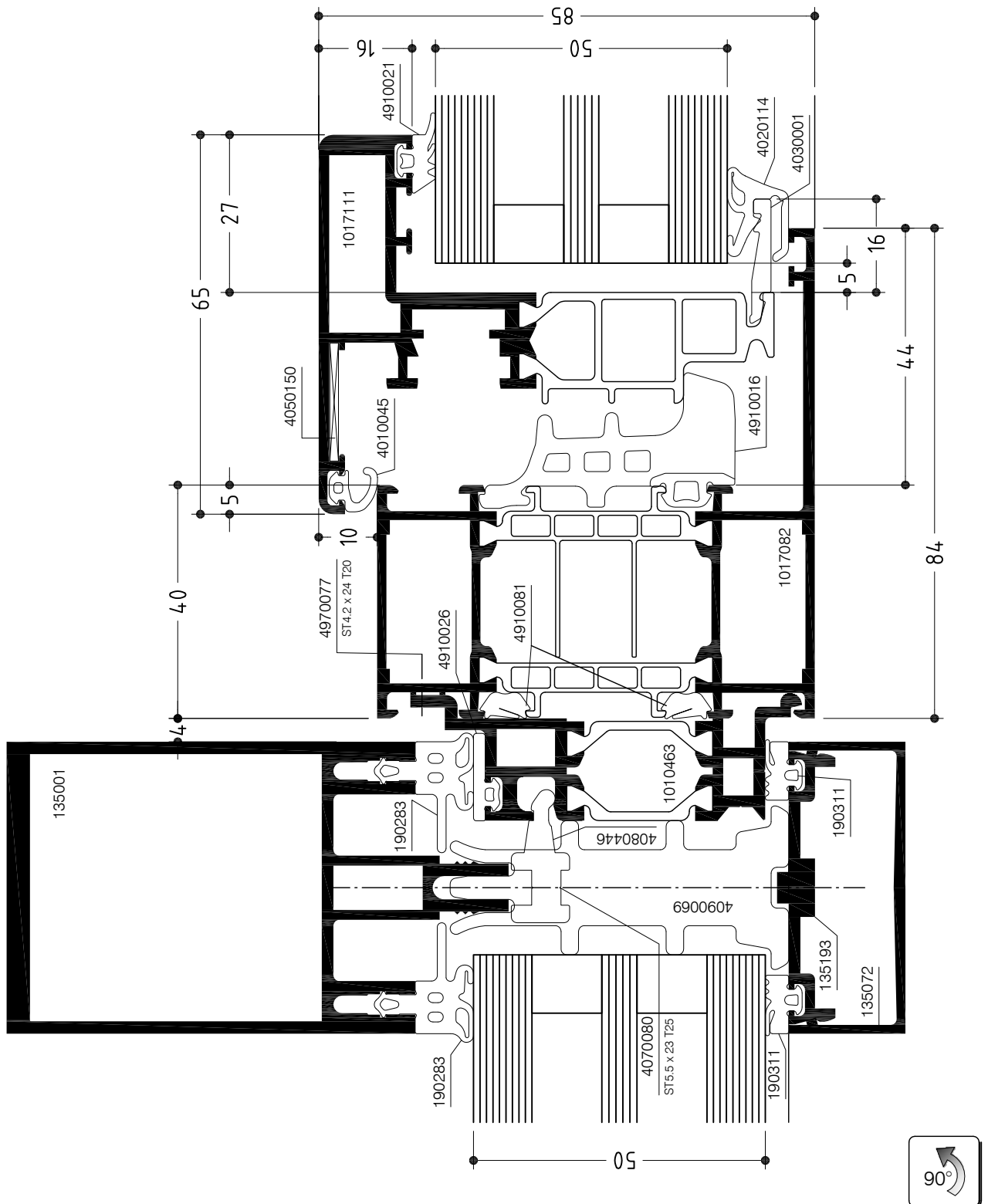

# WICLINE 75

## Konstruktionsschnitt

### Construction section

Flügelprofil im Blendrahmen mit Einspannaufsatz, verdeckter Flügel  
 Concealed sash in frame with supplementary clamping profile

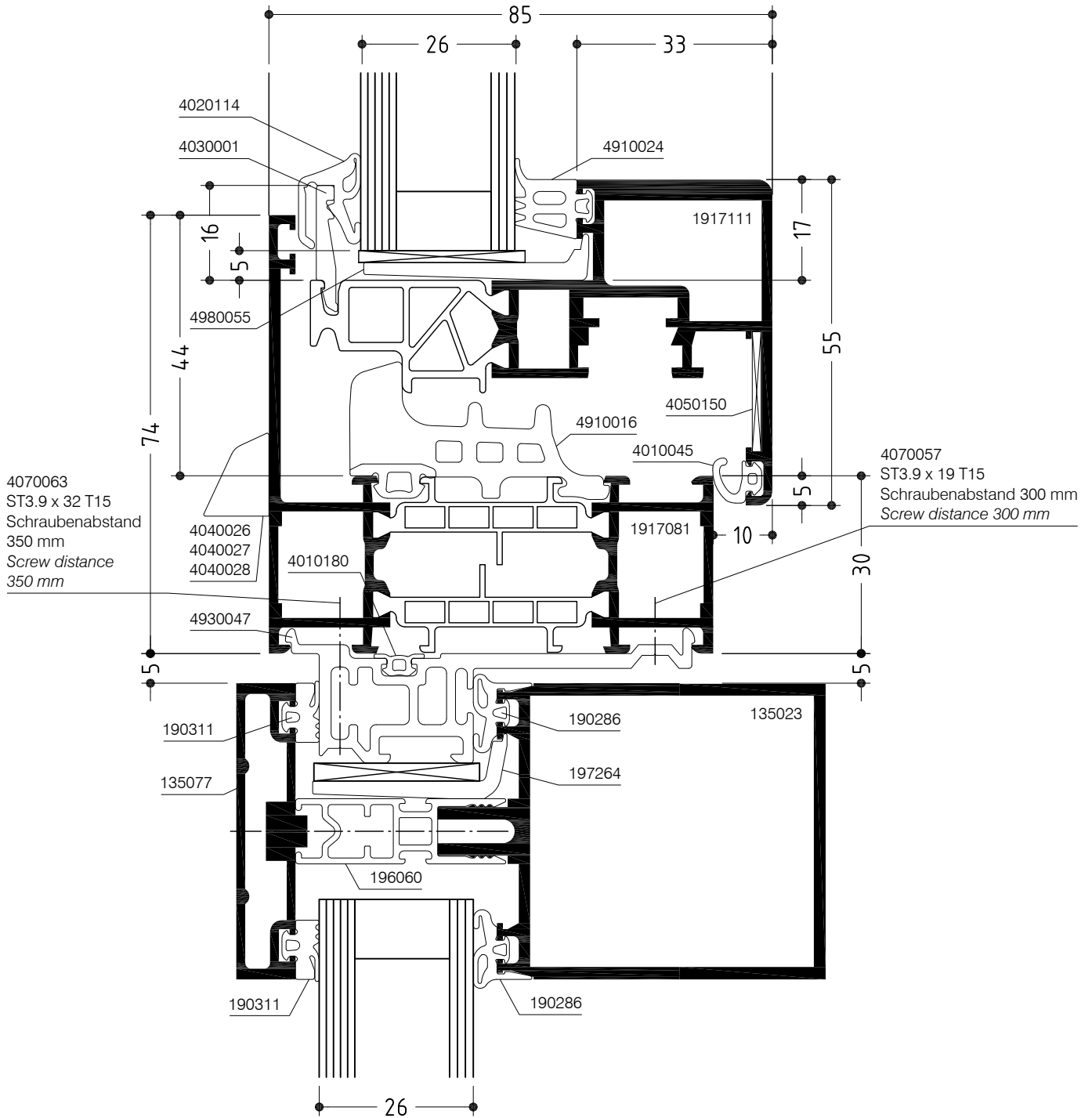

# WICLINE 75

## Konstruktionsschnitt

### Construction section

Bauanschluss unten mit Dämmauflage 4030365, verdeckter Flügel

Bottom junction to structure with insulation support 4030365 and concealed sash

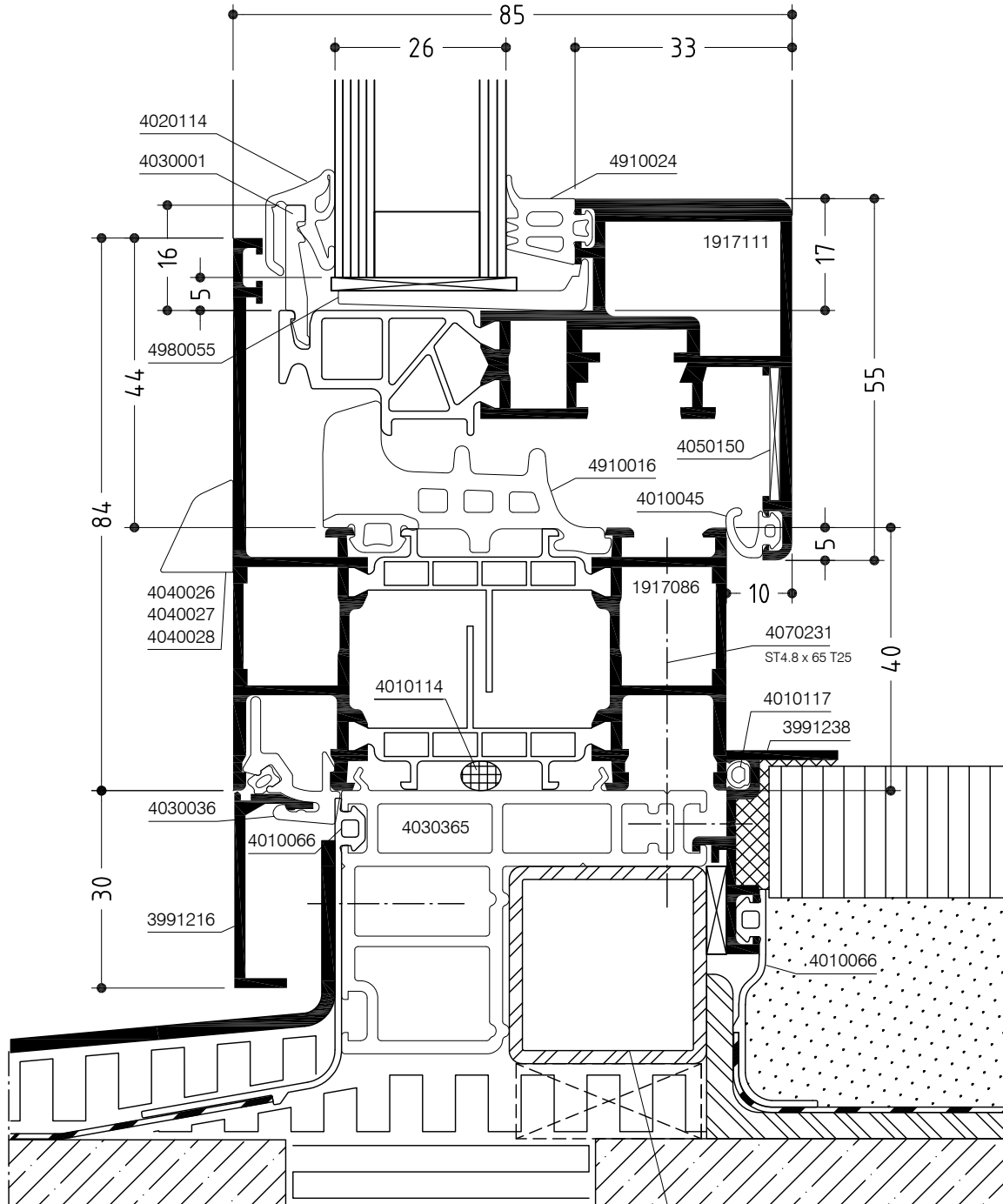

Stahlrohr 30 x 30 x 2.5  
 verzinkt nach DIN 55928  
 30 x 30 x 2.5 Steel tube,  
 galv. acc. to DIN 55928



# WICLINE 75

Senk-Klappfenster  
Italian style window

Konstruktionsschnitt  
Construction section

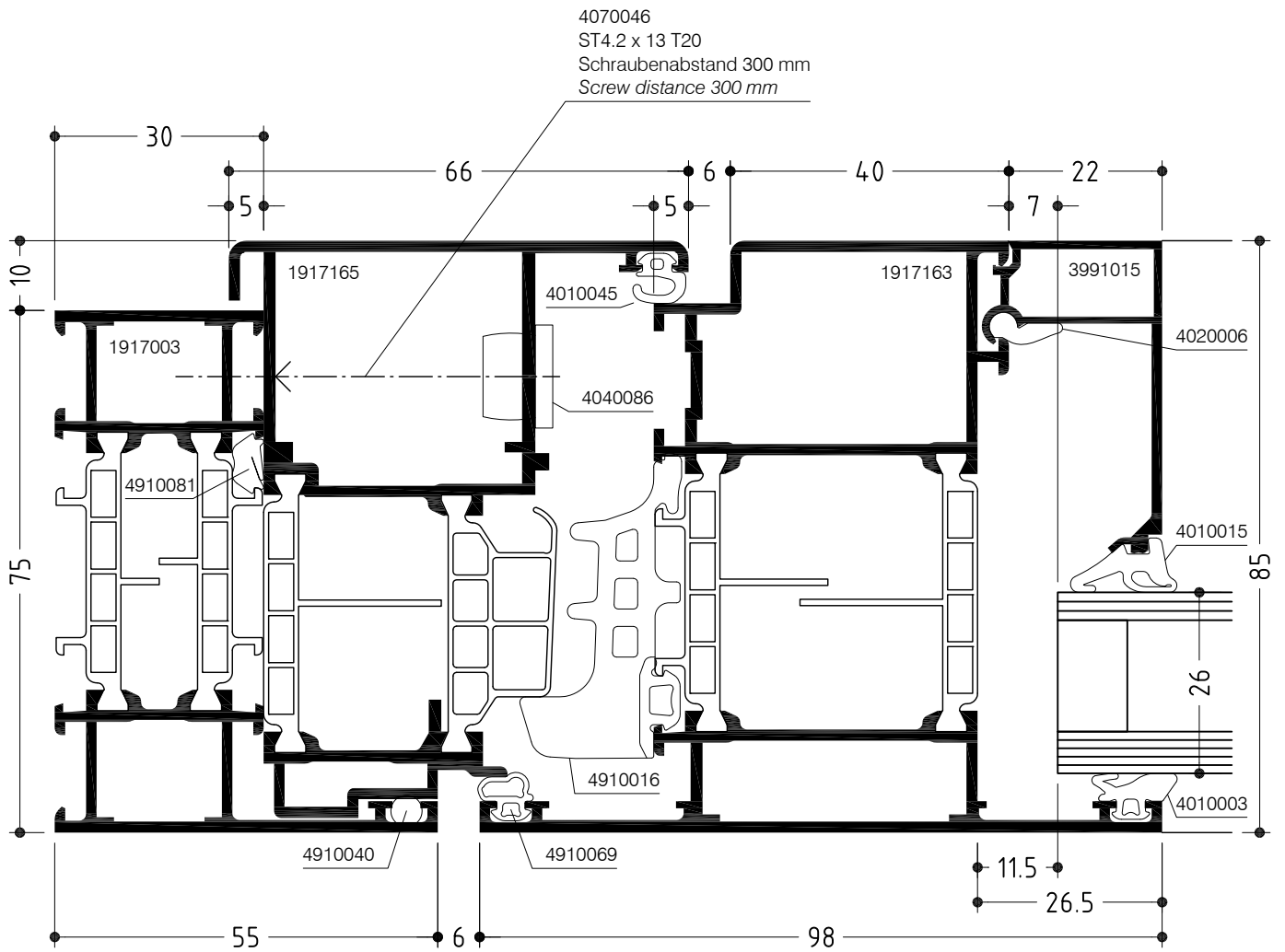





# WICLINE 75

Senk-Klappfenster  
Italian style window

Konstruktionsschnitt  
Construction section

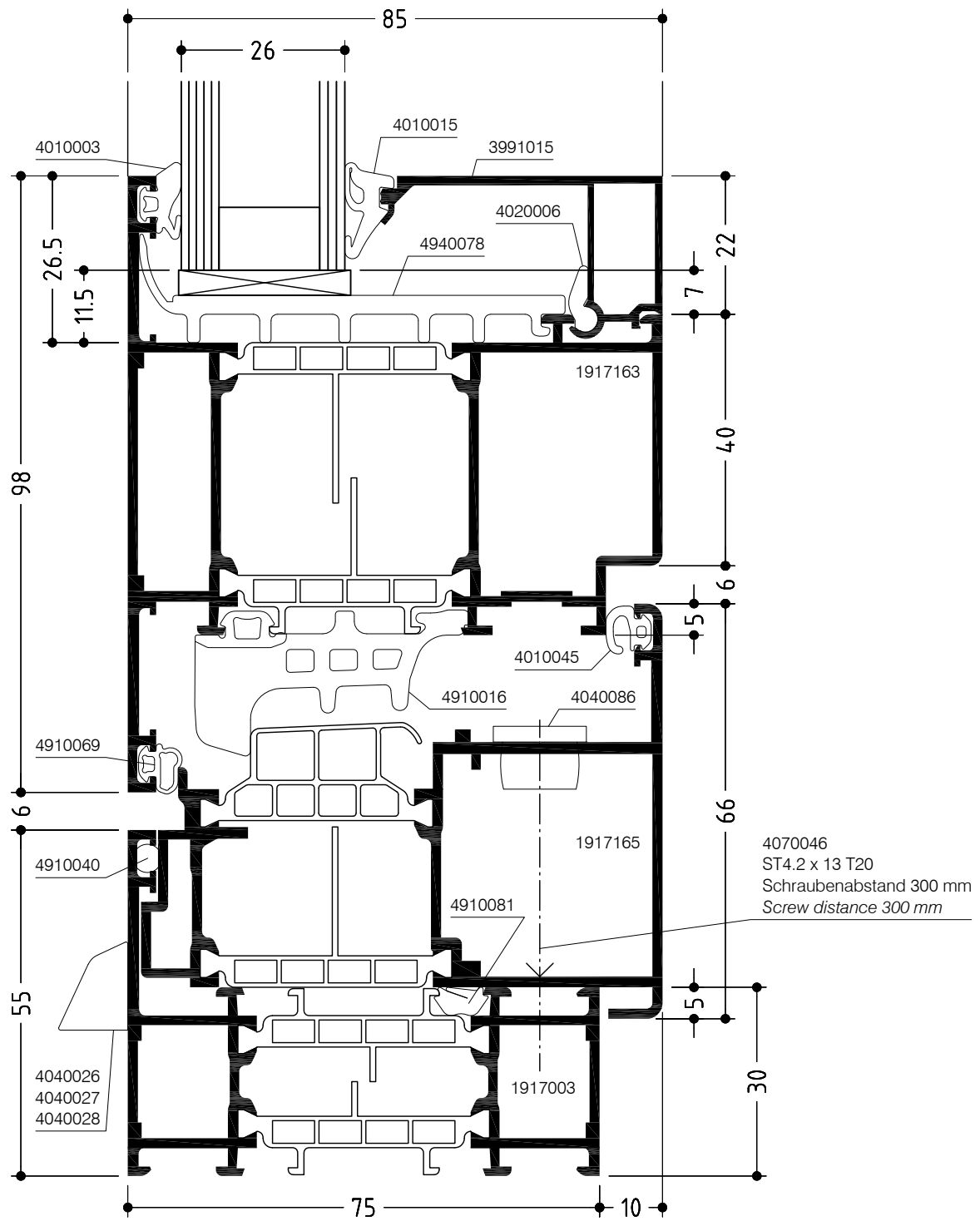

# WICLINE 75

Senk-Klappfenster  
Italian style window

Konstruktionsschnitt  
Construction section

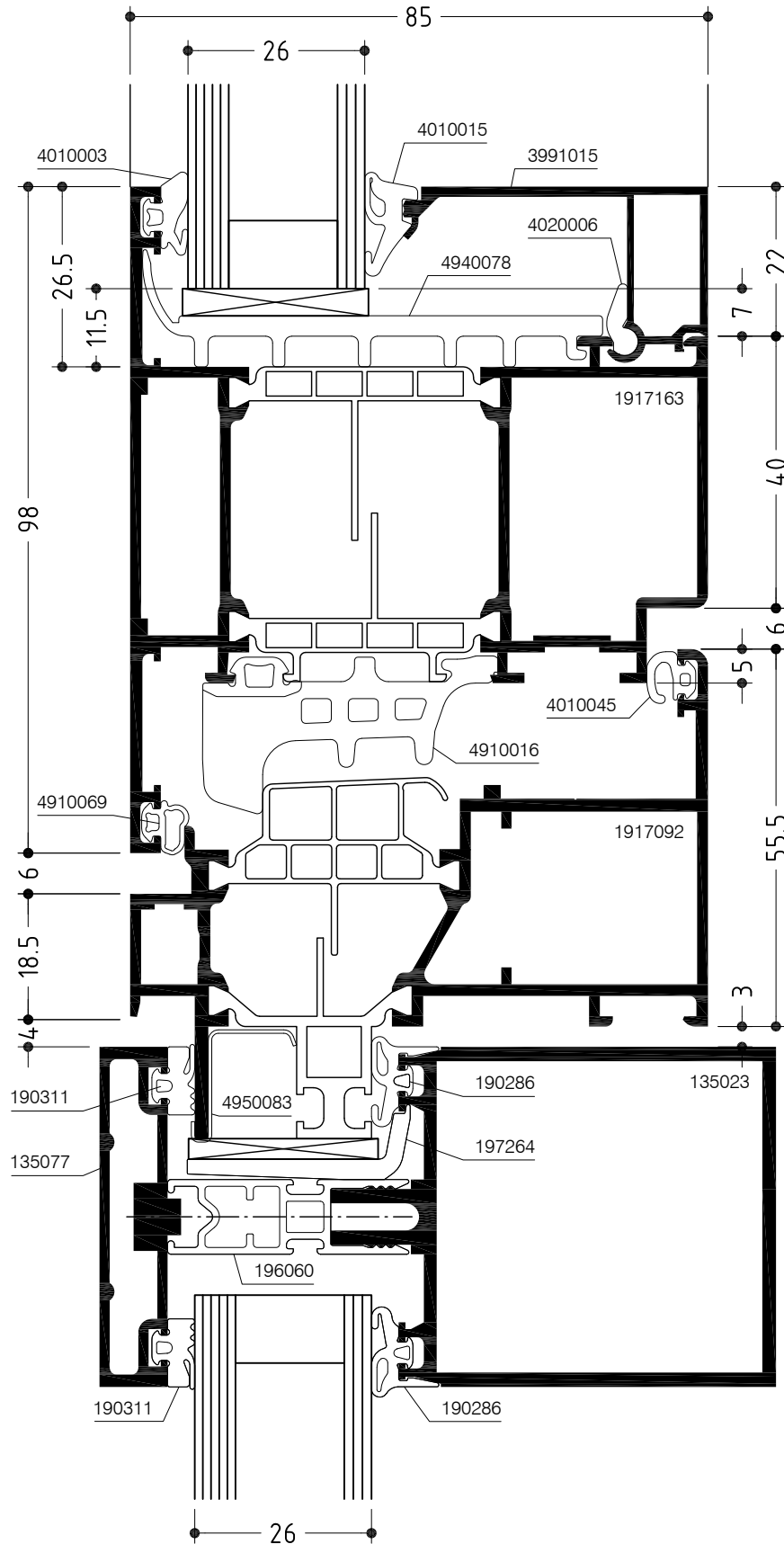

# WICLINE 75

Senk-Klappfenster  
Italian style window

Konstruktionsschnitt  
Construction section

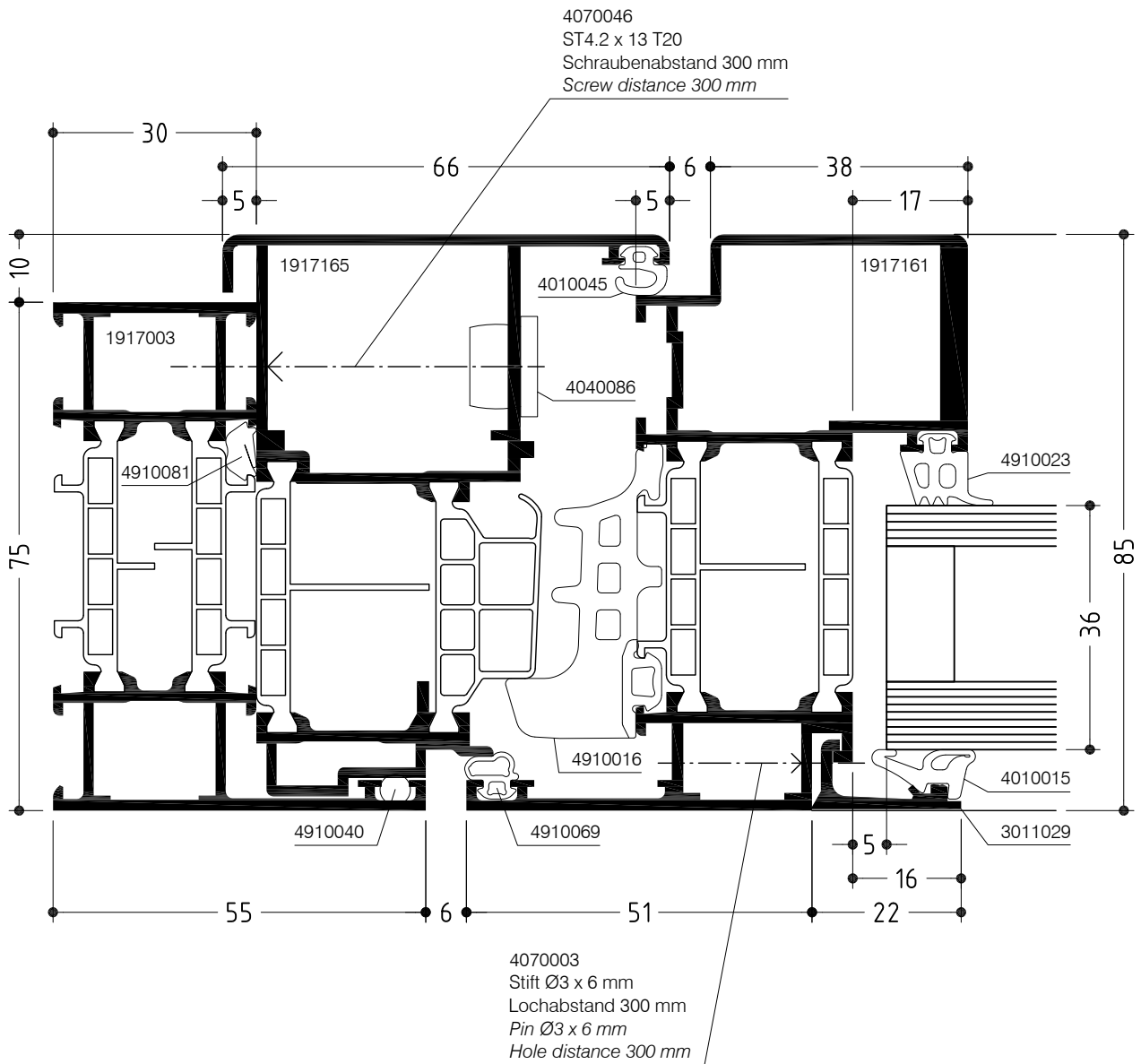



# WICLINE 75

Senk-Klappfenster  
Italian style window

Konstruktionsschnitt  
Construction section

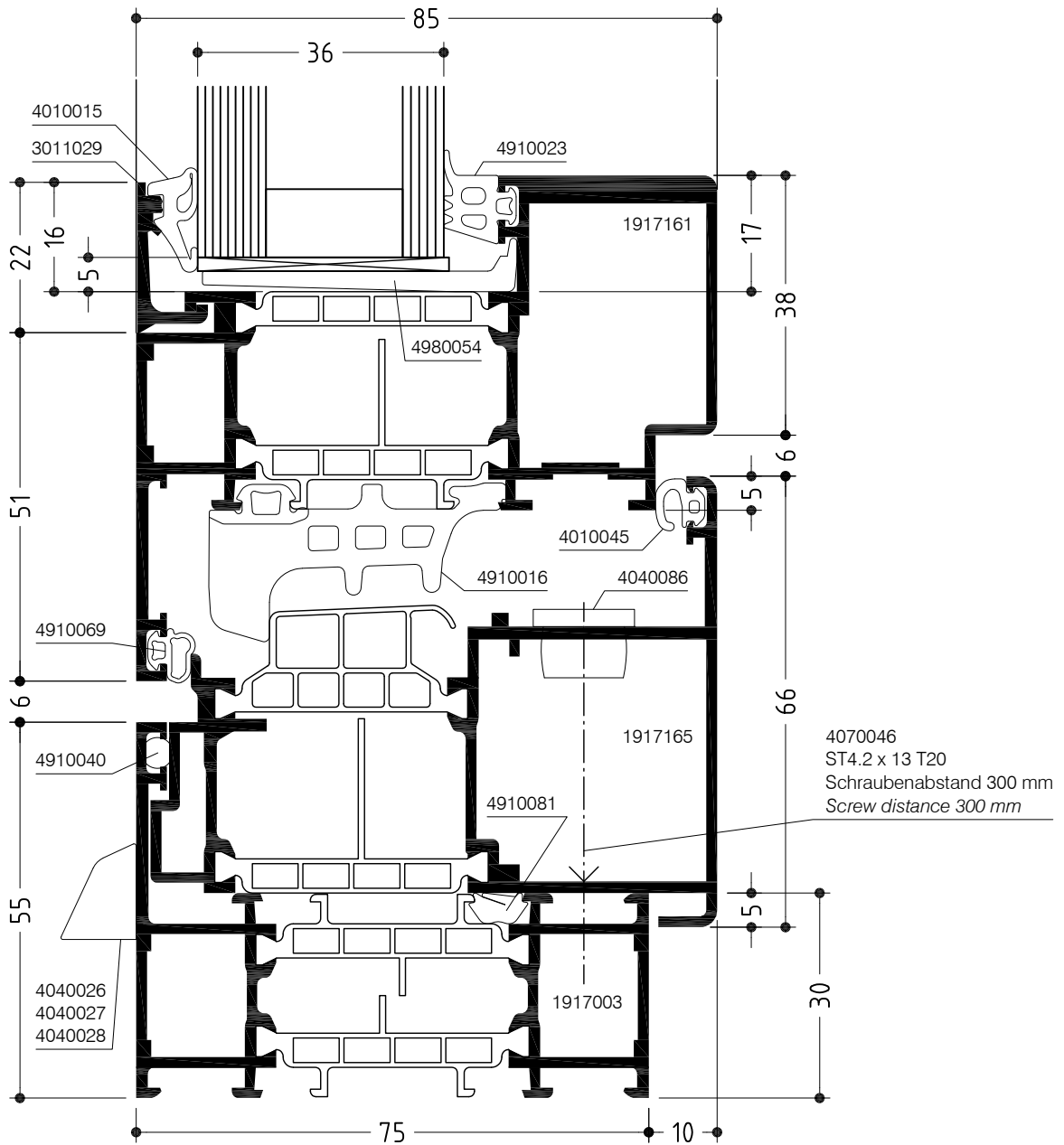

# WICLINE 75

Senk-Klappfenster  
Italian style window

Konstruktionsschnitt  
Construction section

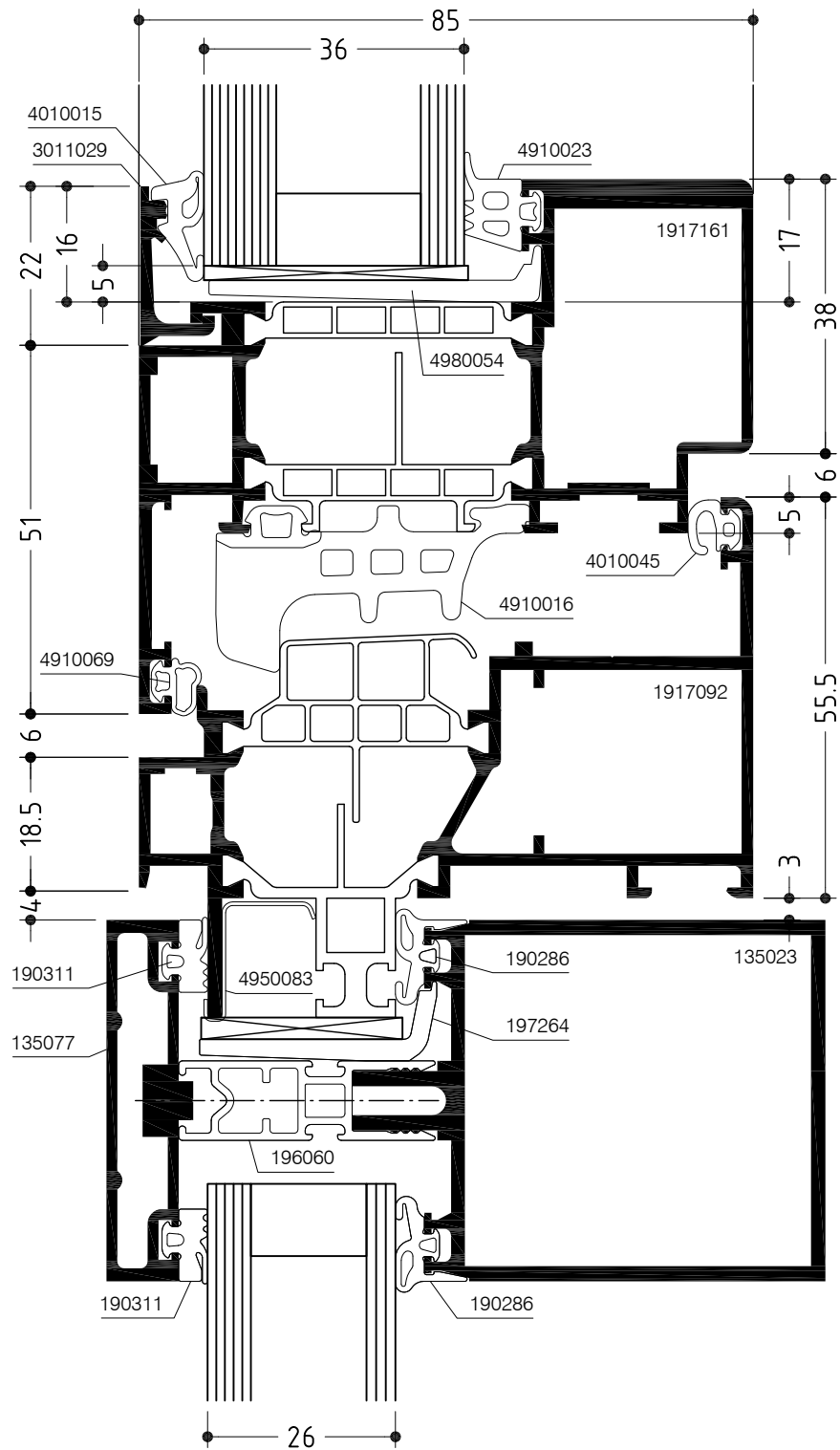

# WICLINE 75

Klappfenster  
Top-hung window

Konstruktionsschnitt  
Construction section

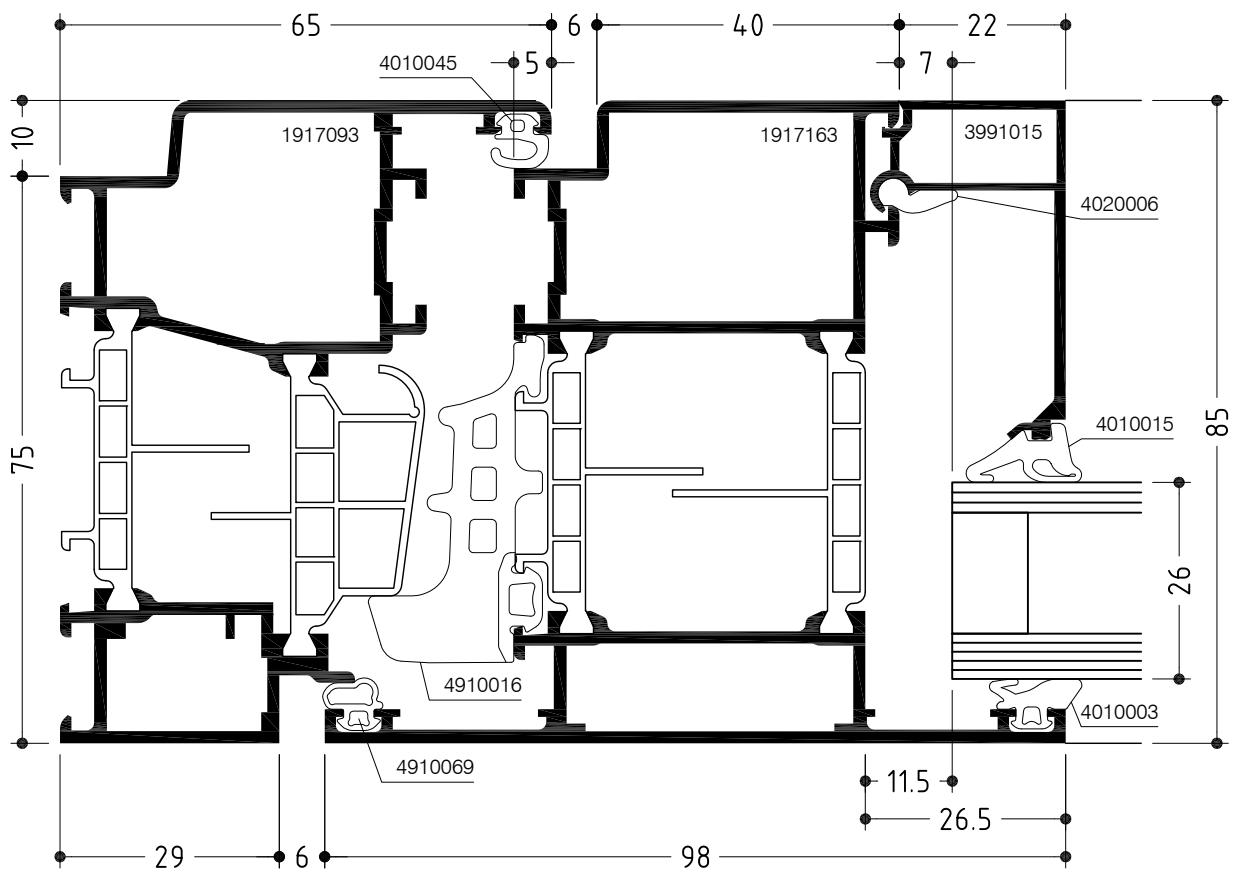

# WICLINE 75

Klappfenster  
Top-hung window

Konstruktionsschnitt  
Construction section

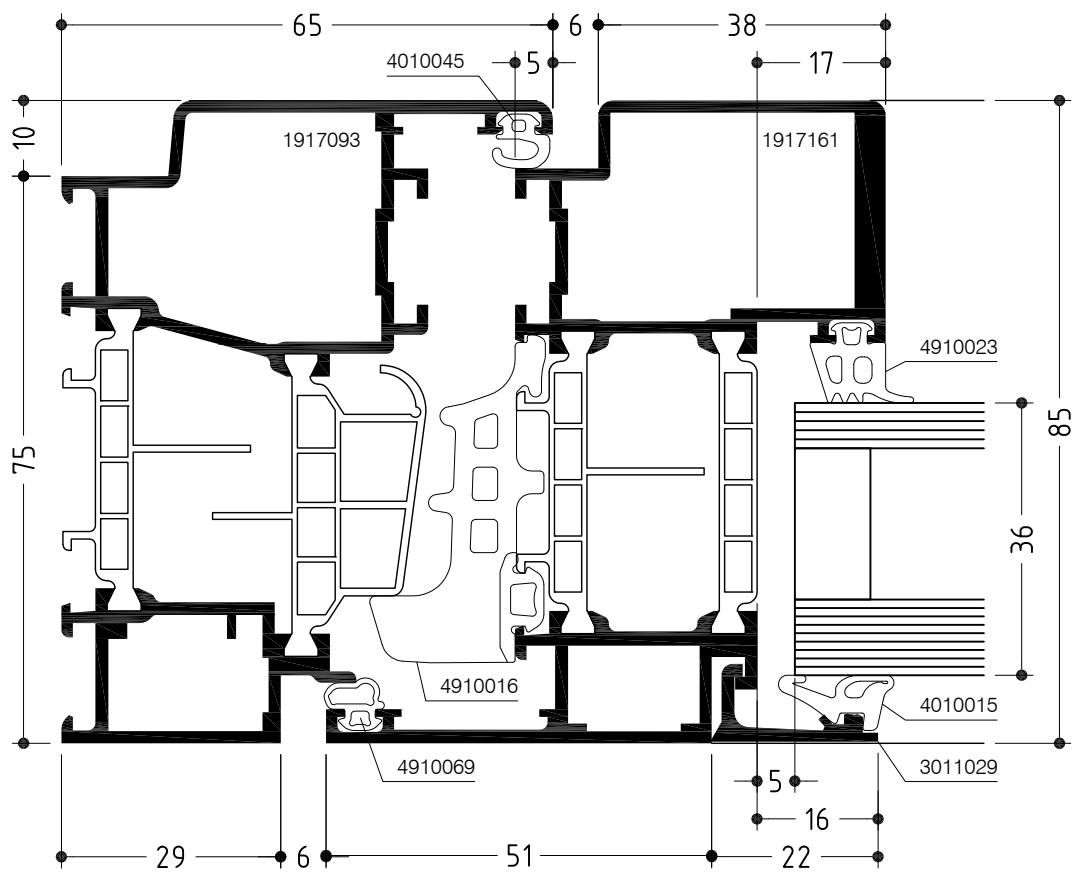



# WICLINE 75

Klappfenster  
Top-hung window

Konstruktionsschnitt  
Construction section

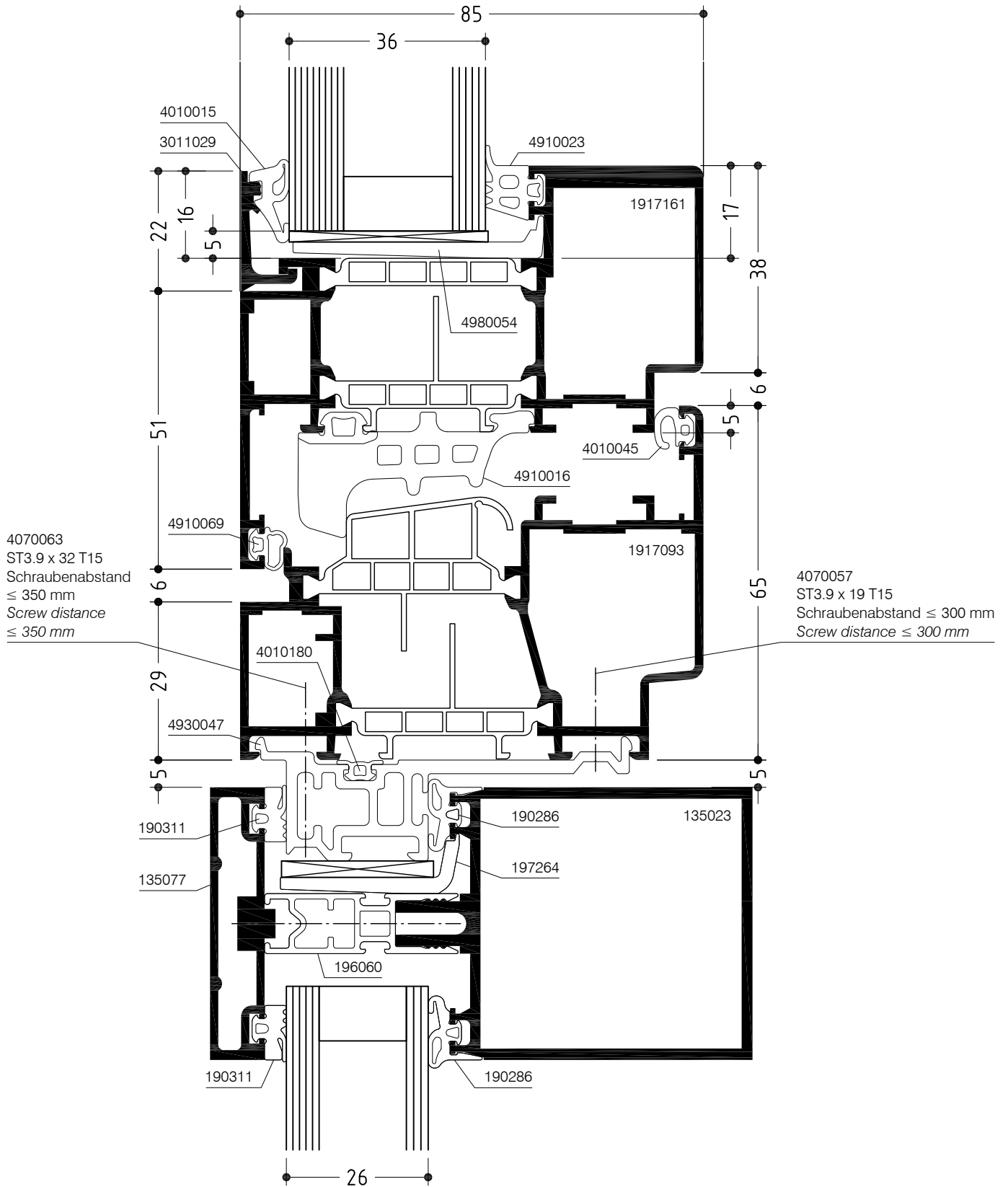

# WICLINE 75

Klappfenster  
Top-hung window

Konstruktionsschnitt  
Construction section

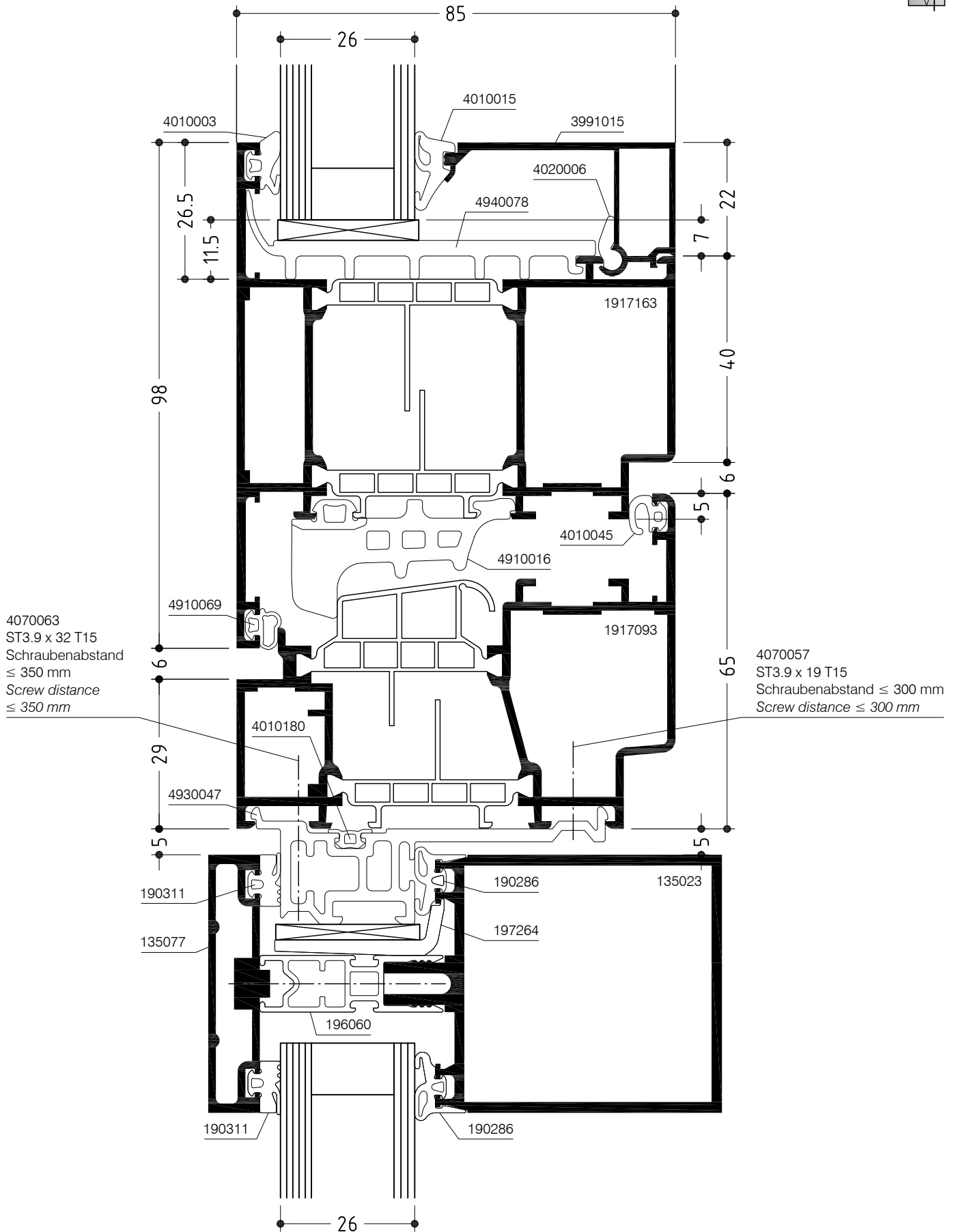

# WICLINE 75

Schwing-Wende-Fenster  
Horizontal/vertical pivot window

Konstruktionsschnitt  
Construction section

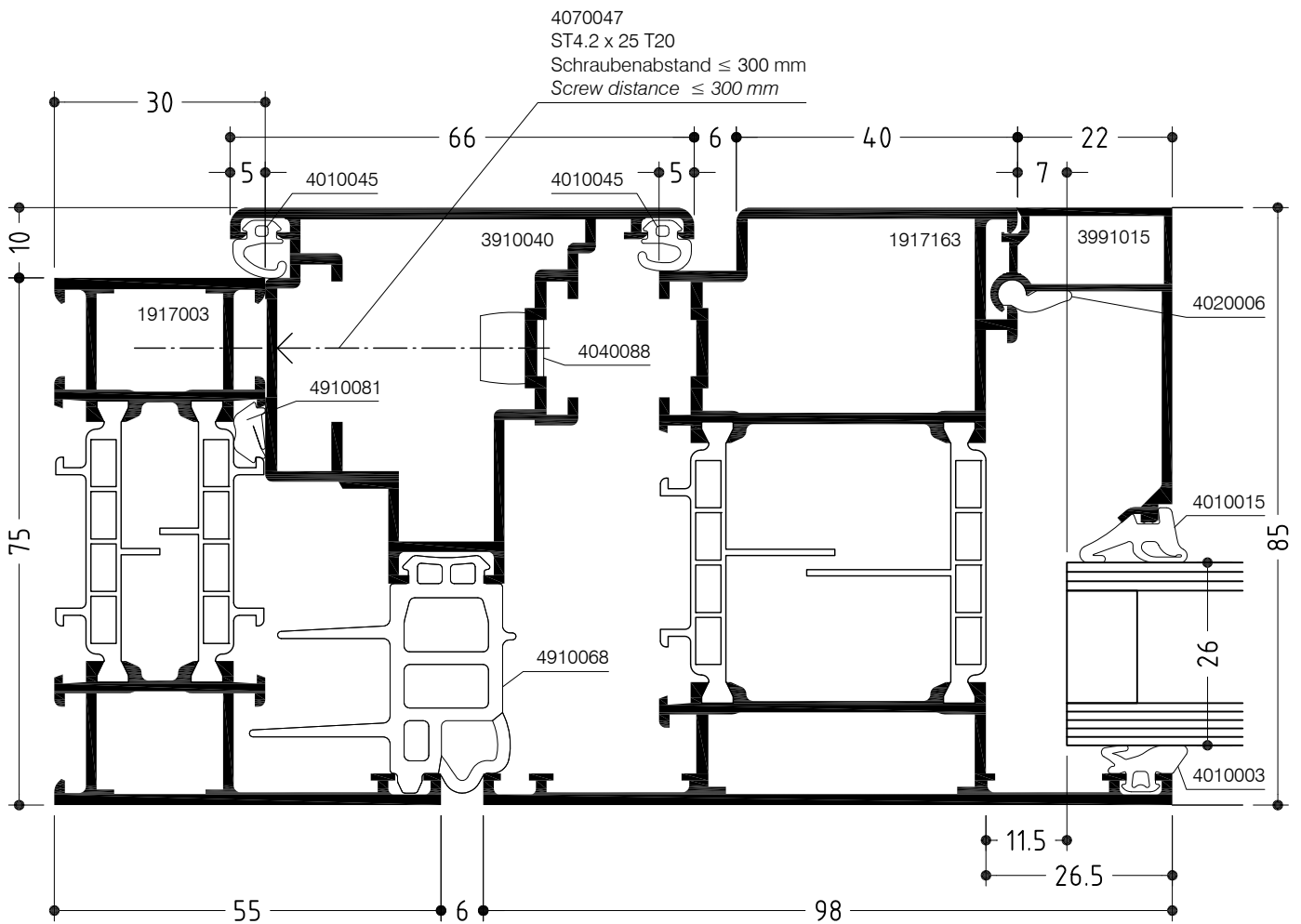
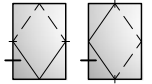

# WICLINE 75

Schwing-Wende-Fenster  
Horizontal/vertical pivot window

Konstruktionsschnitt  
Construction section

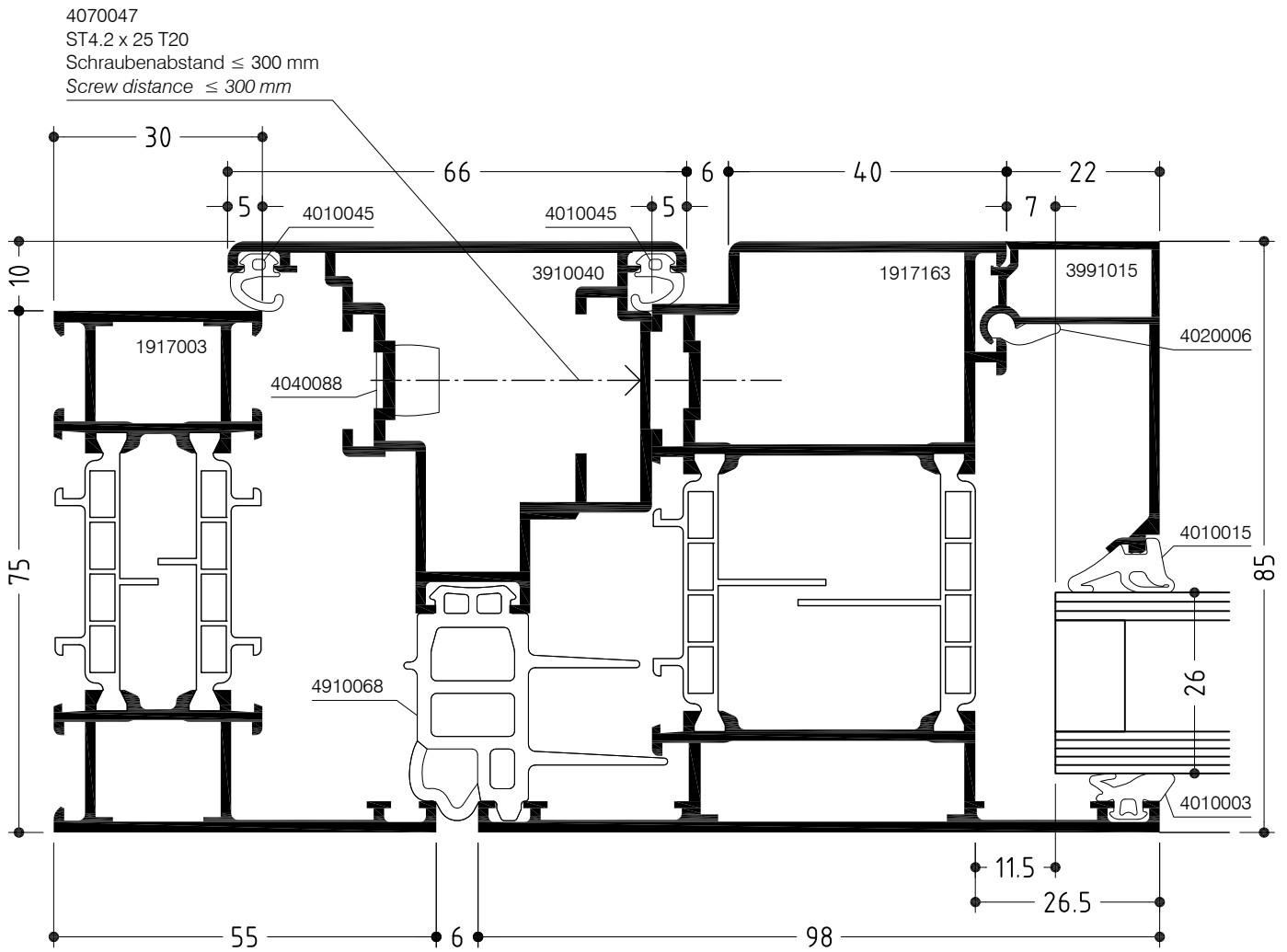
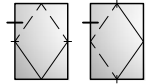

# WICLINE 75

Schwing-Wende-Fenster  
Horizontal/vertical pivot window

Konstruktionsschnitt  
Construction section

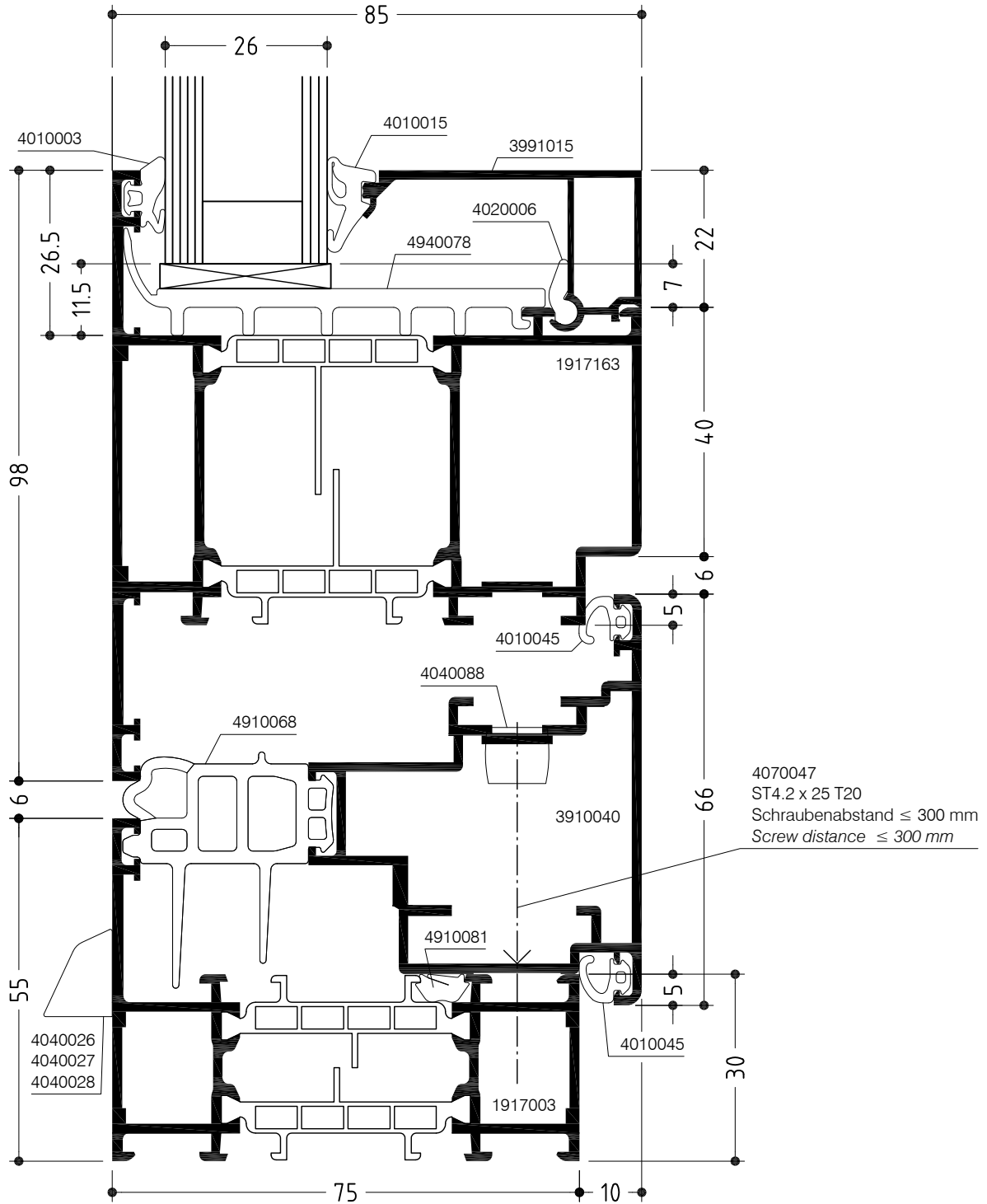
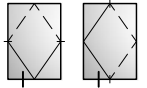

# WICLINE 75

Schwing-Wende-Fenster  
Horizontal/vertical pivot window

Konstruktionsschnitt  
Construction section

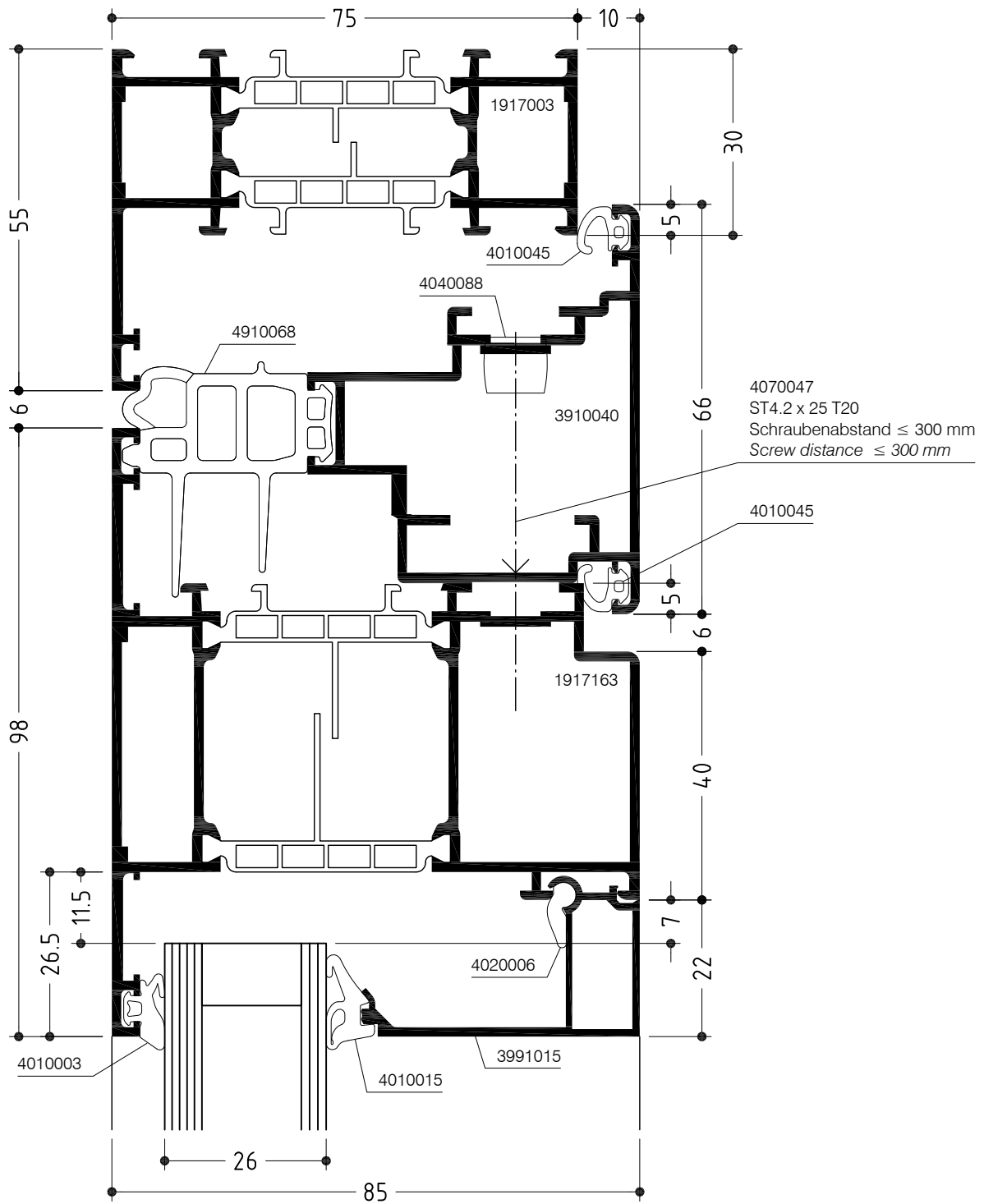
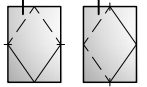

# WICLINE 75

Schwing-Wende-Fenster  
Horizontal/vertical pivot window

Konstruktionsschnitt  
Construction section

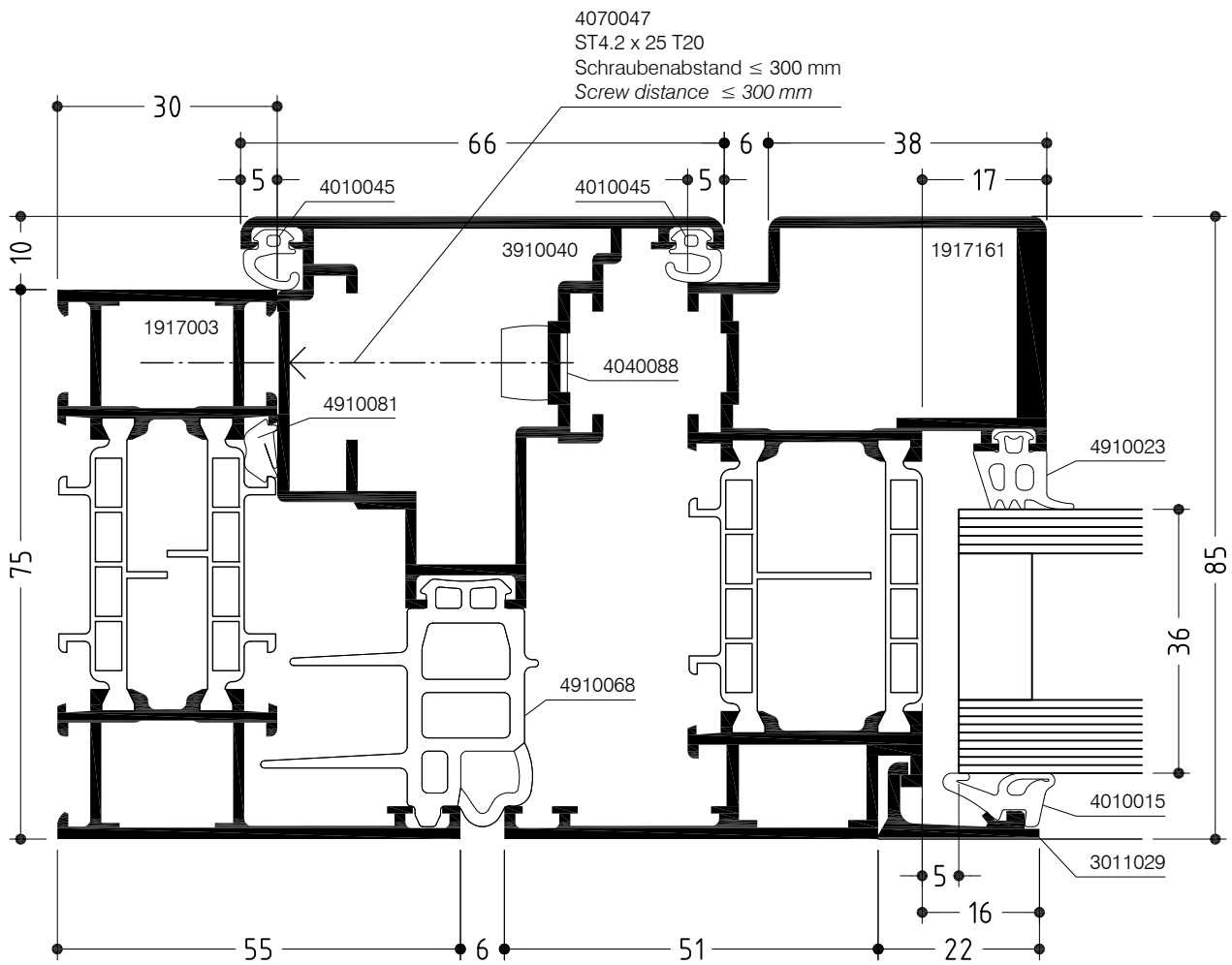
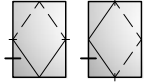

# WICLINE 75

Schwing-Wende-Fenster  
Horizontal/vertical pivot window

Konstruktionsschnitt  
Construction section

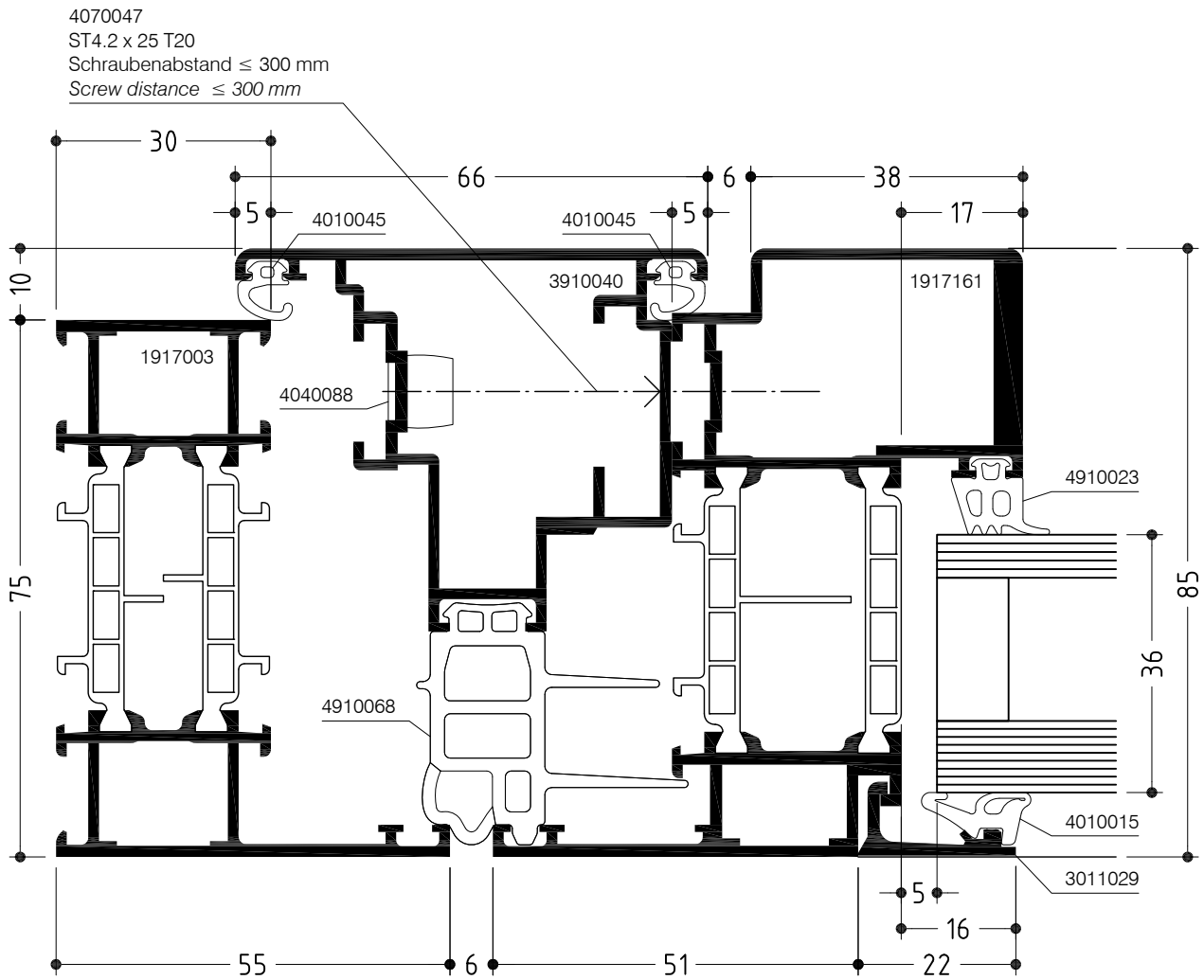
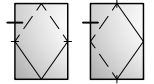



# WICLINE 75

Schwing-Wende-Fenster  
Horizontal/vertical pivot window

Konstruktionsschnitt  
Construction section

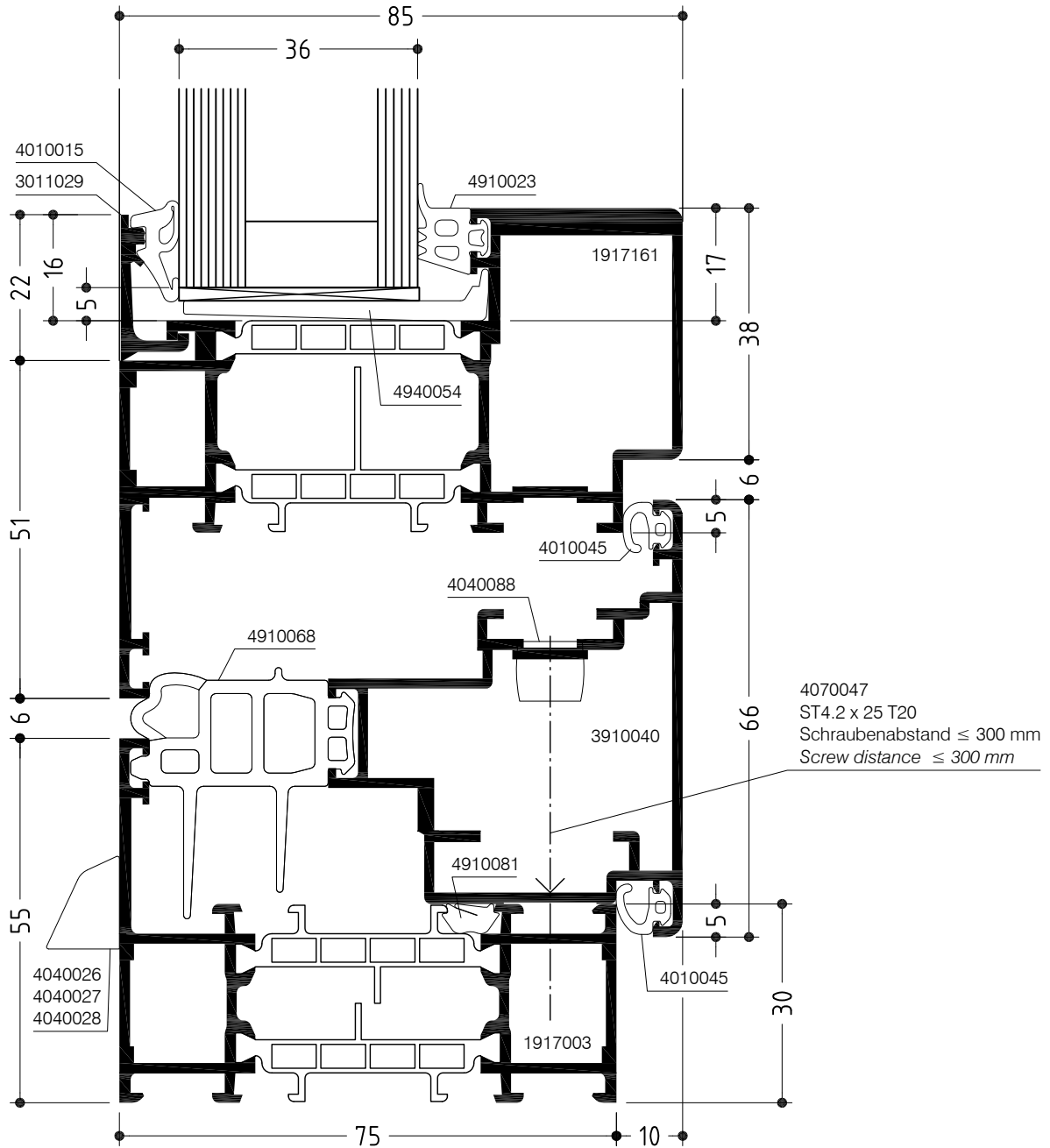
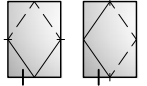



# WICLINE 75

Schwing-Wende-Fenster  
Horizontal/vertical pivot window

Konstruktionsschnitt  
Construction section

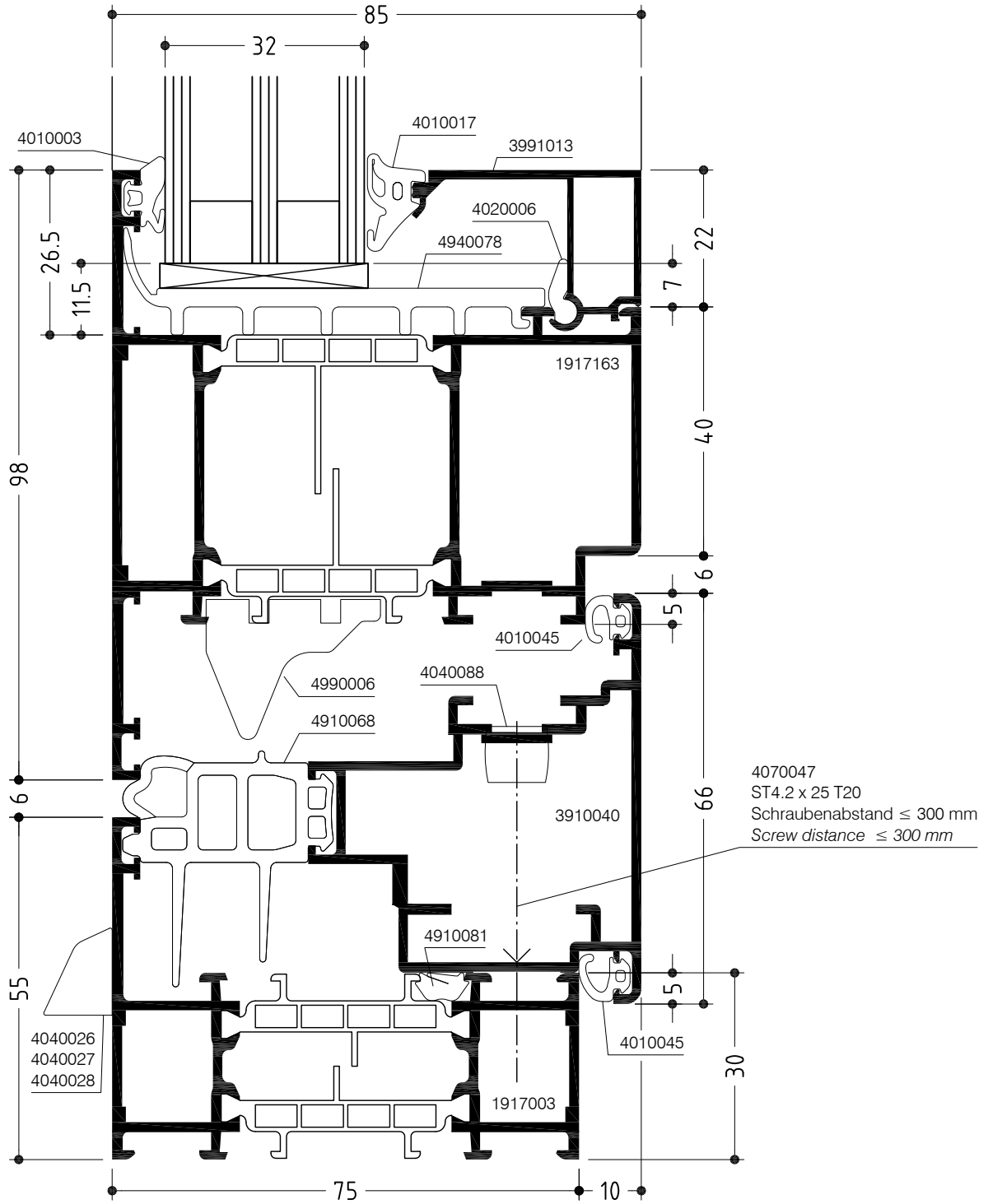
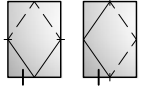

# WICLINE 75

Schwing-Wende-Fenster  
Horizontal/vertical pivot window

Konstruktionsschnitt  
Construction section

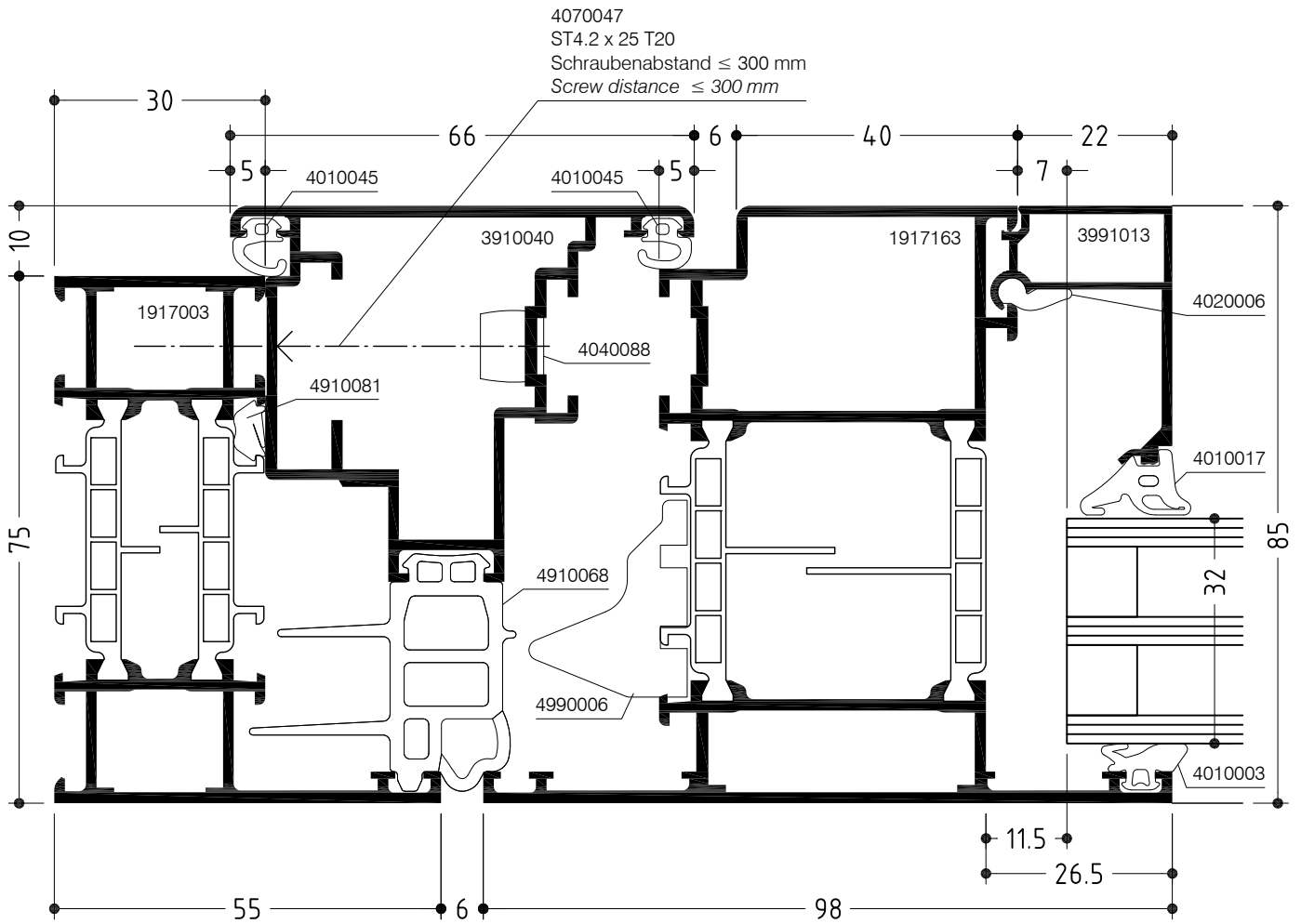
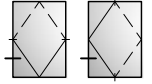

# WICLINE 75

Schwing-Wende-Fenster  
Horizontal/vertical pivot window

Konstruktionsschnitt  
Construction section

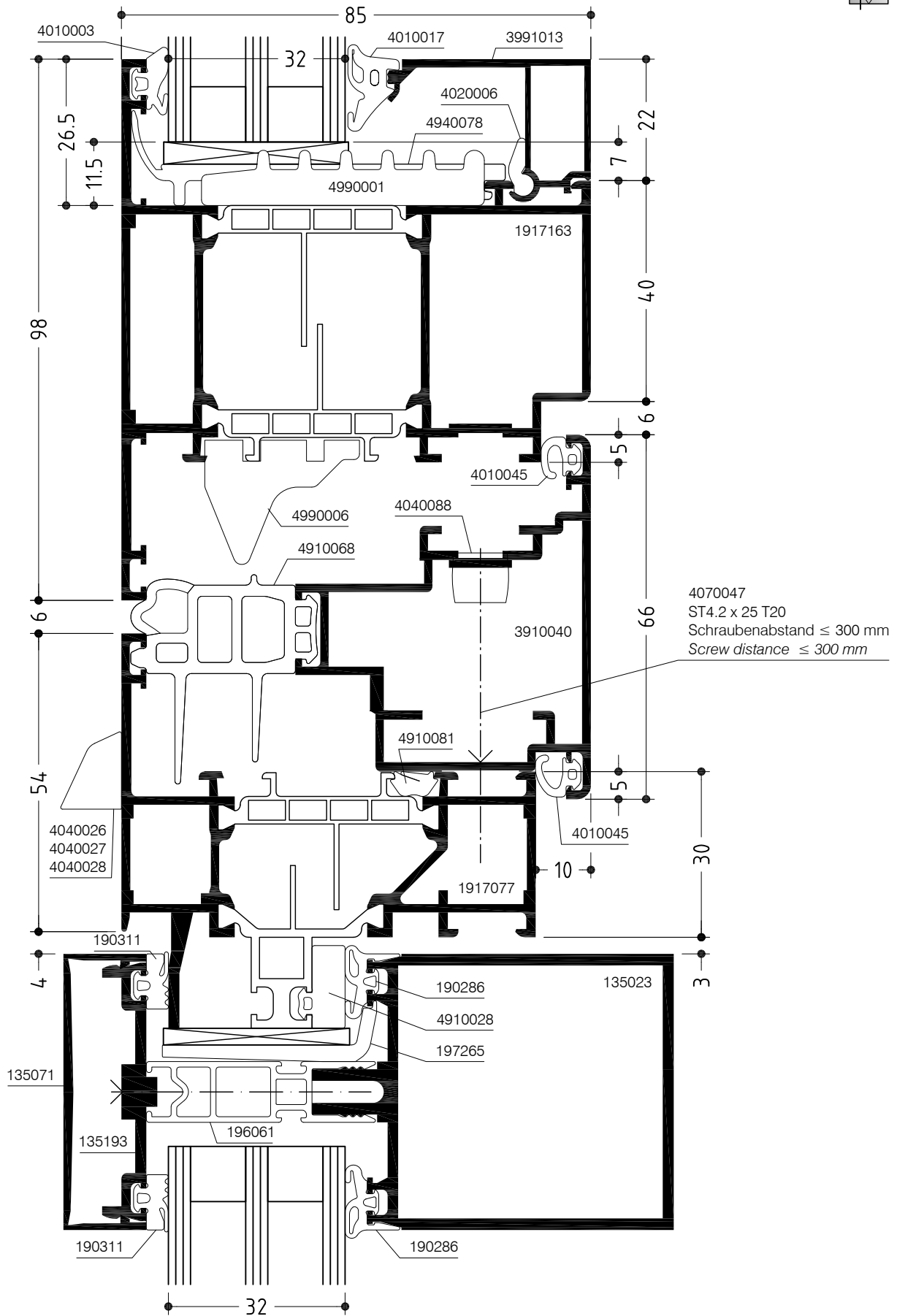
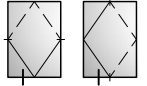



# WICLINE 75

## Konstruktionsschnitt Construction section

Fenstertür mit Schwellenprofil, einwärts  
Casement door with threshold profile, inwards

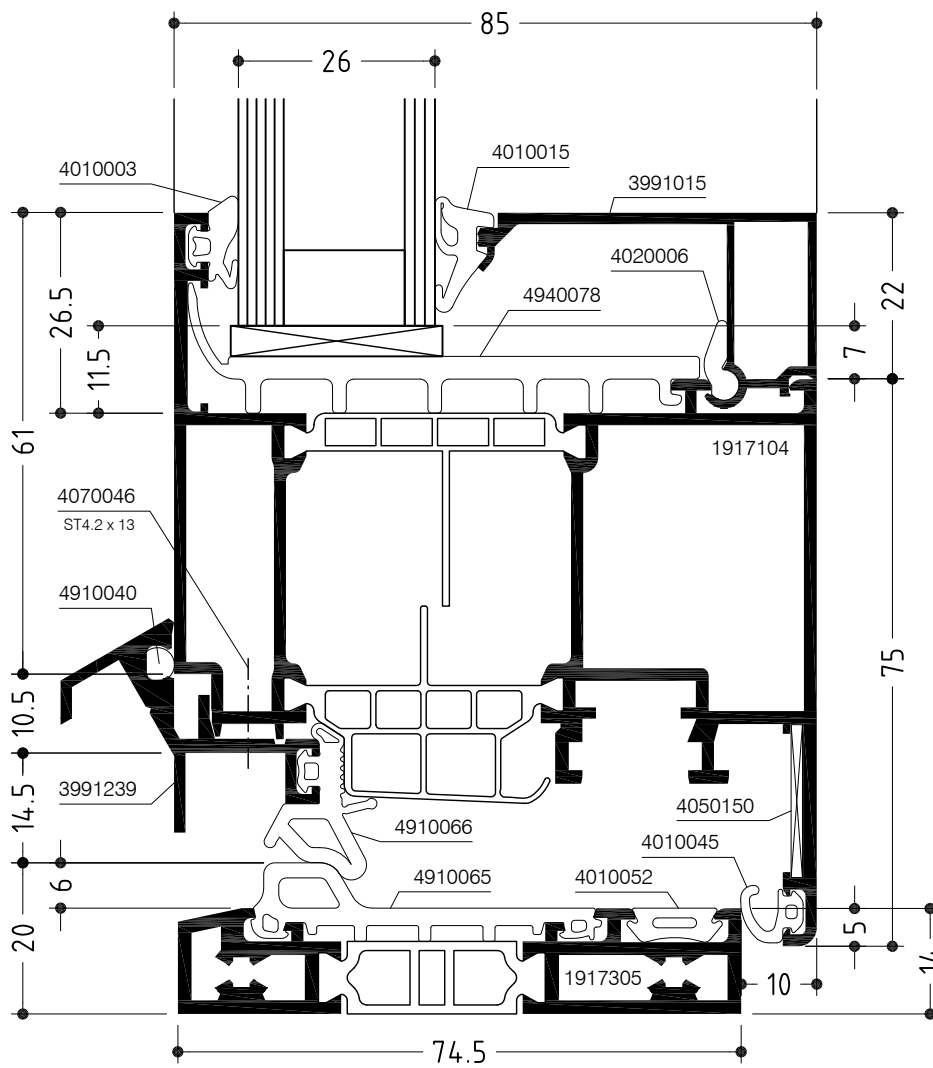
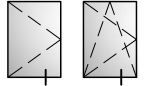

# WICLINE 75

Fenstertür mit Schwellenprofil, auswärts  
Casement door with threshold profile, outwards

Konstruktionsschnitt  
Construction section

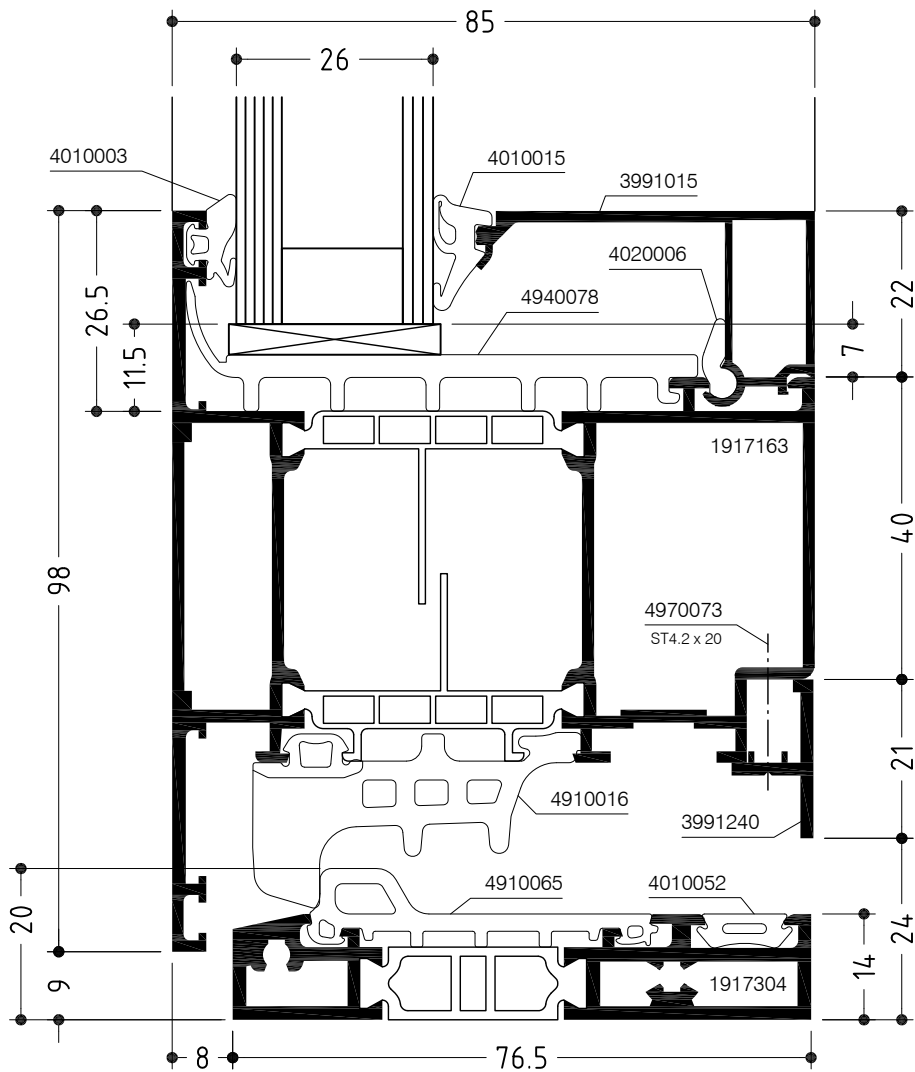



# WICLINE 75

## Konstruktionsschnitt

### Construction section

Fenstertür mit Aufsatzprofil, auswärts

Casement door with supplementary profile, outwards

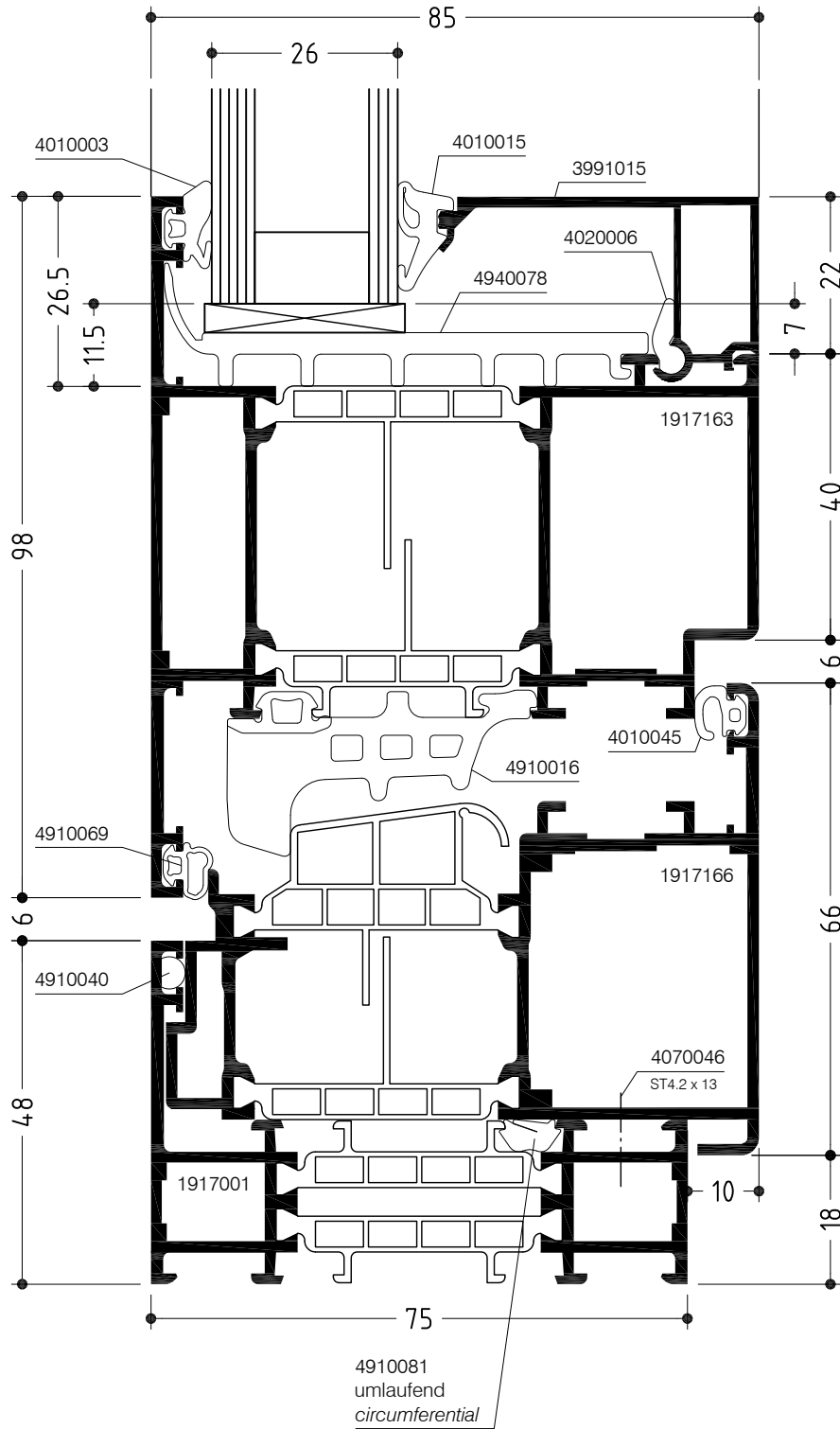

# WICLINE 75

Fenstertür, einwärts  
Casement door, inwards

Konstruktionsschnitt  
Construction section

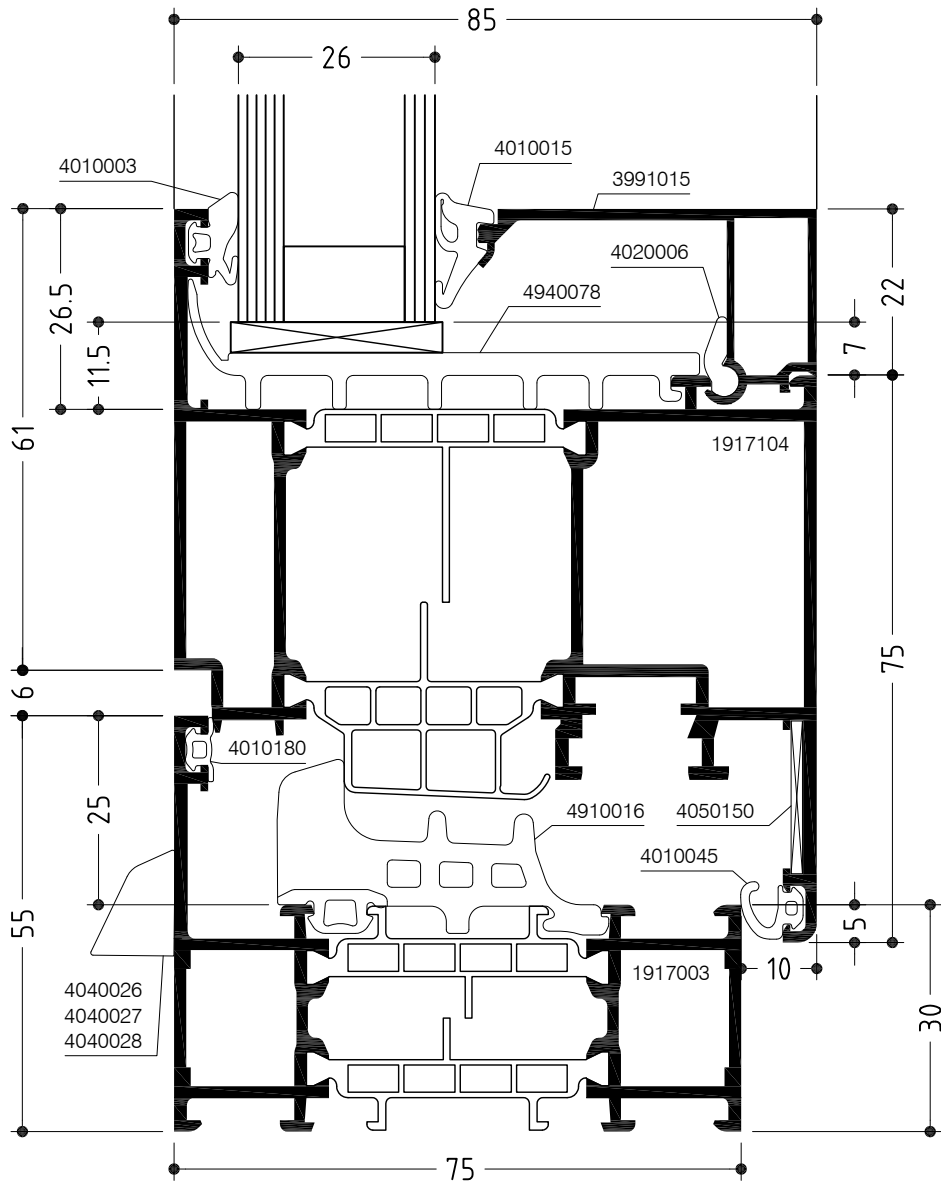
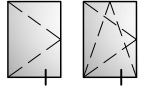

# WICLINE 75

Fenstertür, einwärts  
Casement door, inwards

Konstruktionsschnitt  
Construction section

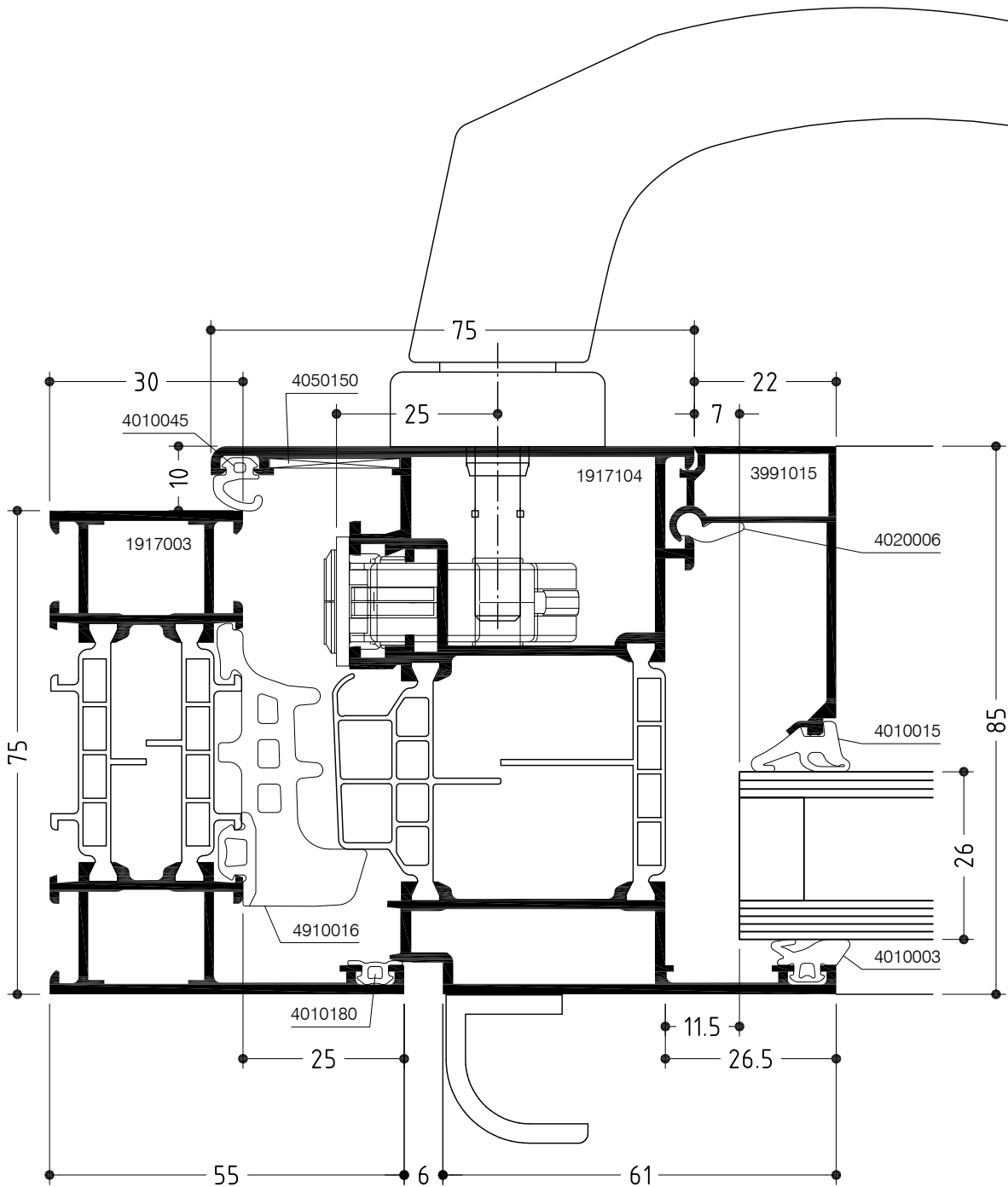
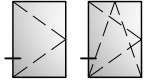

# WICLINE 75

Fenstertür, einwärts  
Casement door, inwards

Konstruktionsschnitt  
Construction section

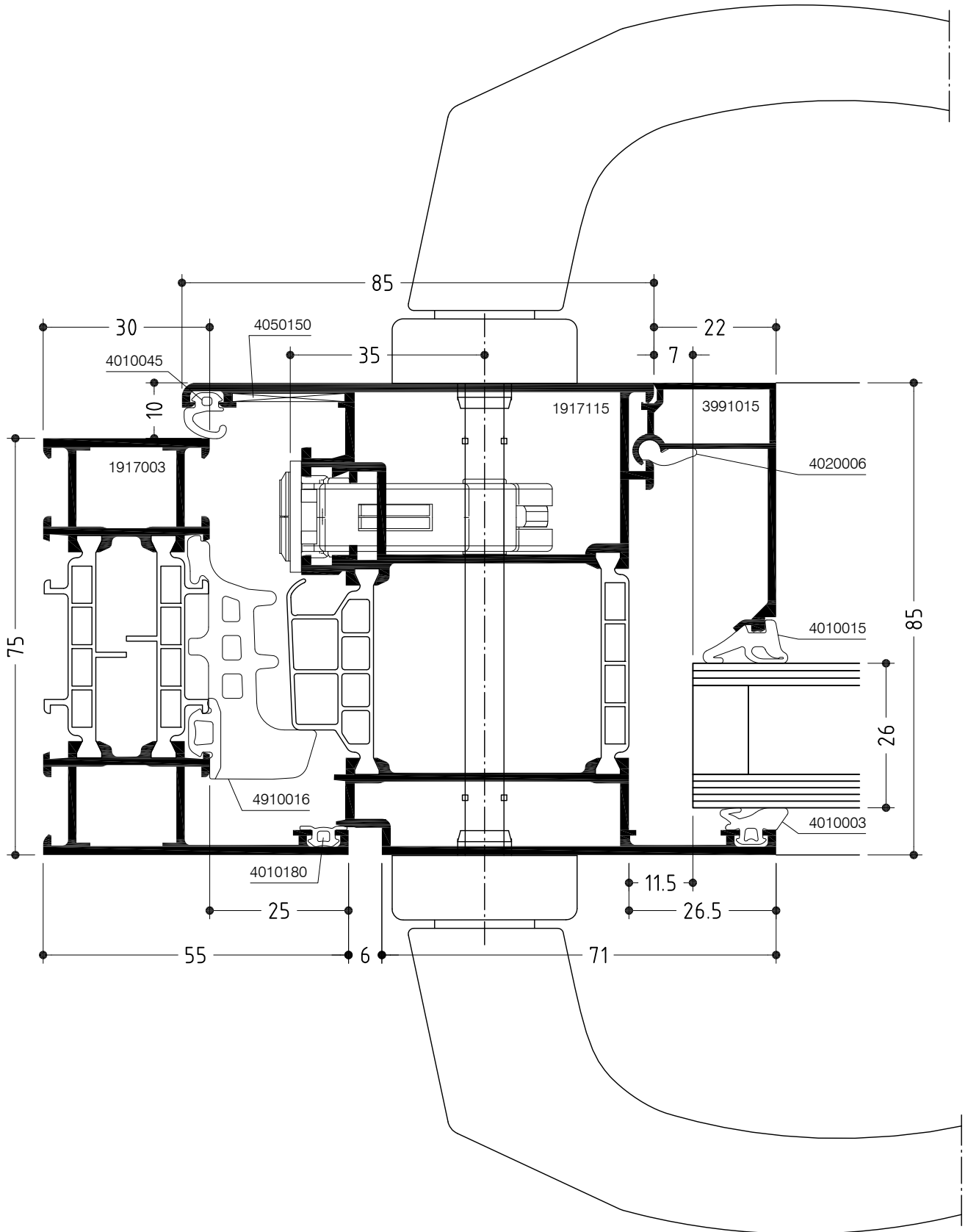
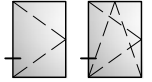

# WICLINE 75

Konstruktionsschnitt

Construction section

Fenstertür mit Aufsatzprofil, auswärts

Casement door with supplementary profile, outwards

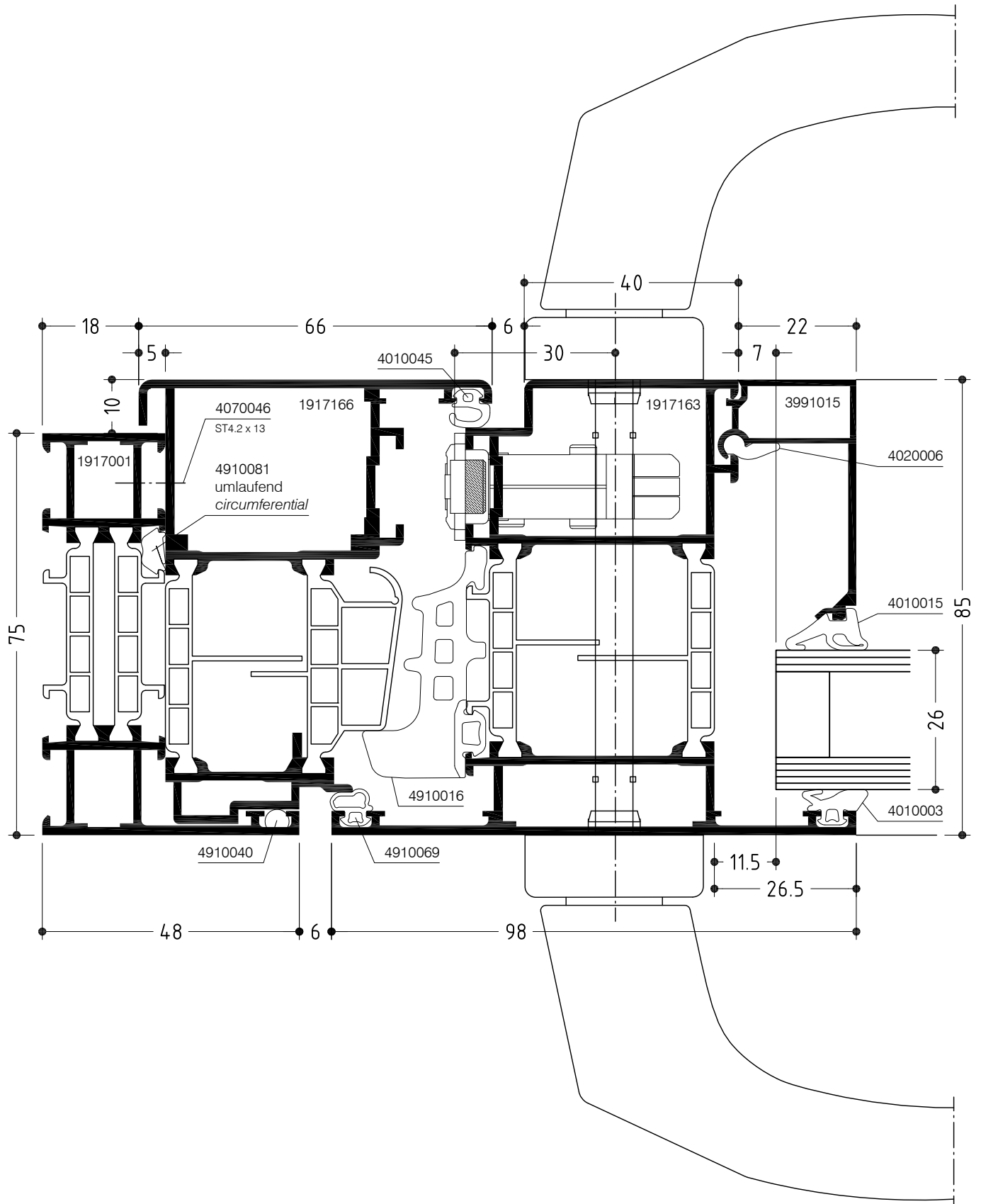



# WICLINE 75

Konstruktionsschnitt

Construction section

Parallel-Schiebe-Kipp-Fenster (ohne Zwangssteuerung)

Flügelgewicht max. 100 kg

Parallel sliding tilt window (without force operation)

Sash weight max. 100 kg

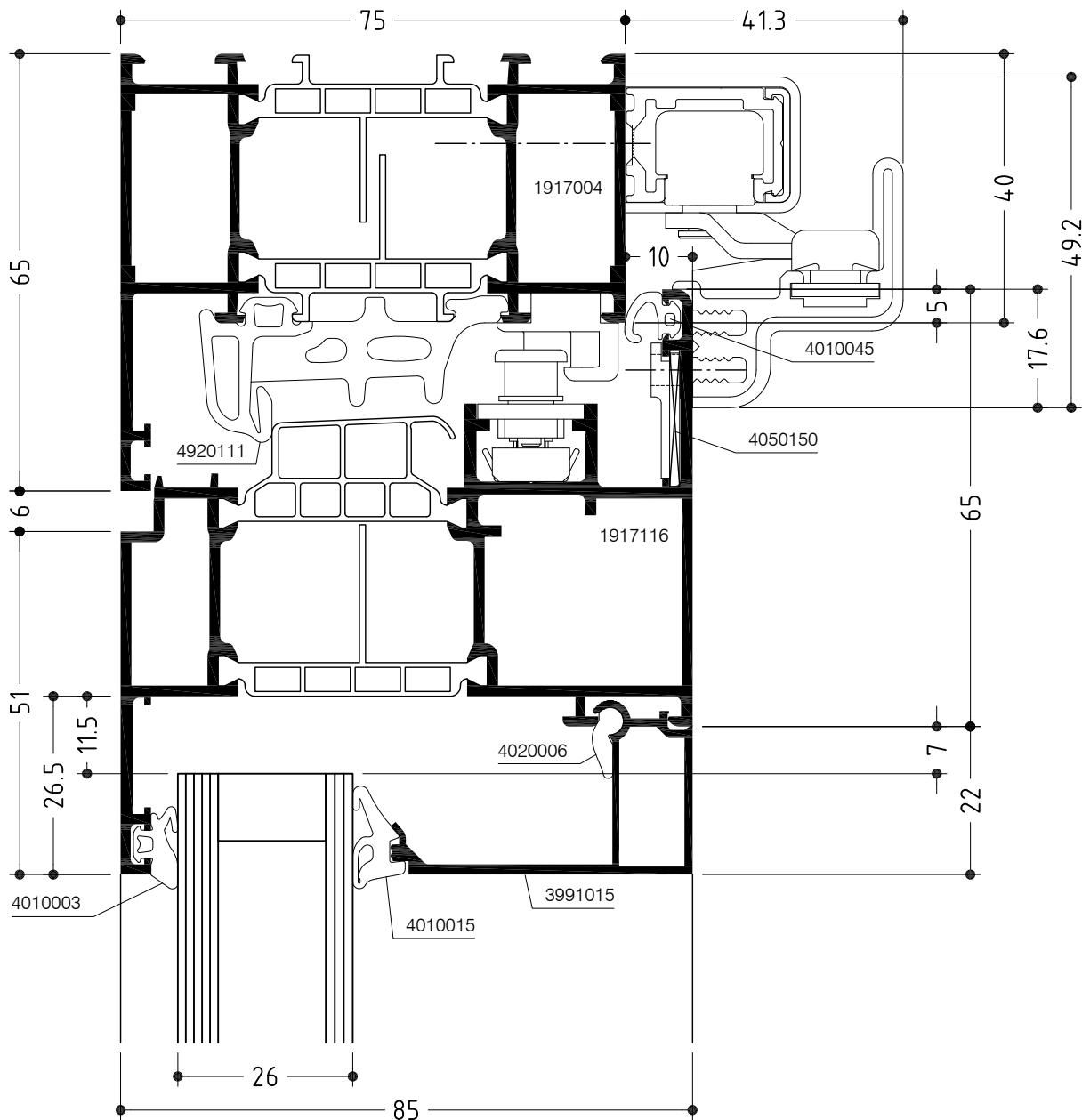
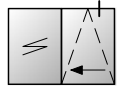

# WICLINE 75

Konstruktionsschnitt

Construction section

Parallel-Schiebe-Kipp-Fenster (ohne Zwangssteuerung)

Flügelgewicht max. 100 kg

Parallel sliding tilt window (without force operation)

Sash weight max. 100 kg

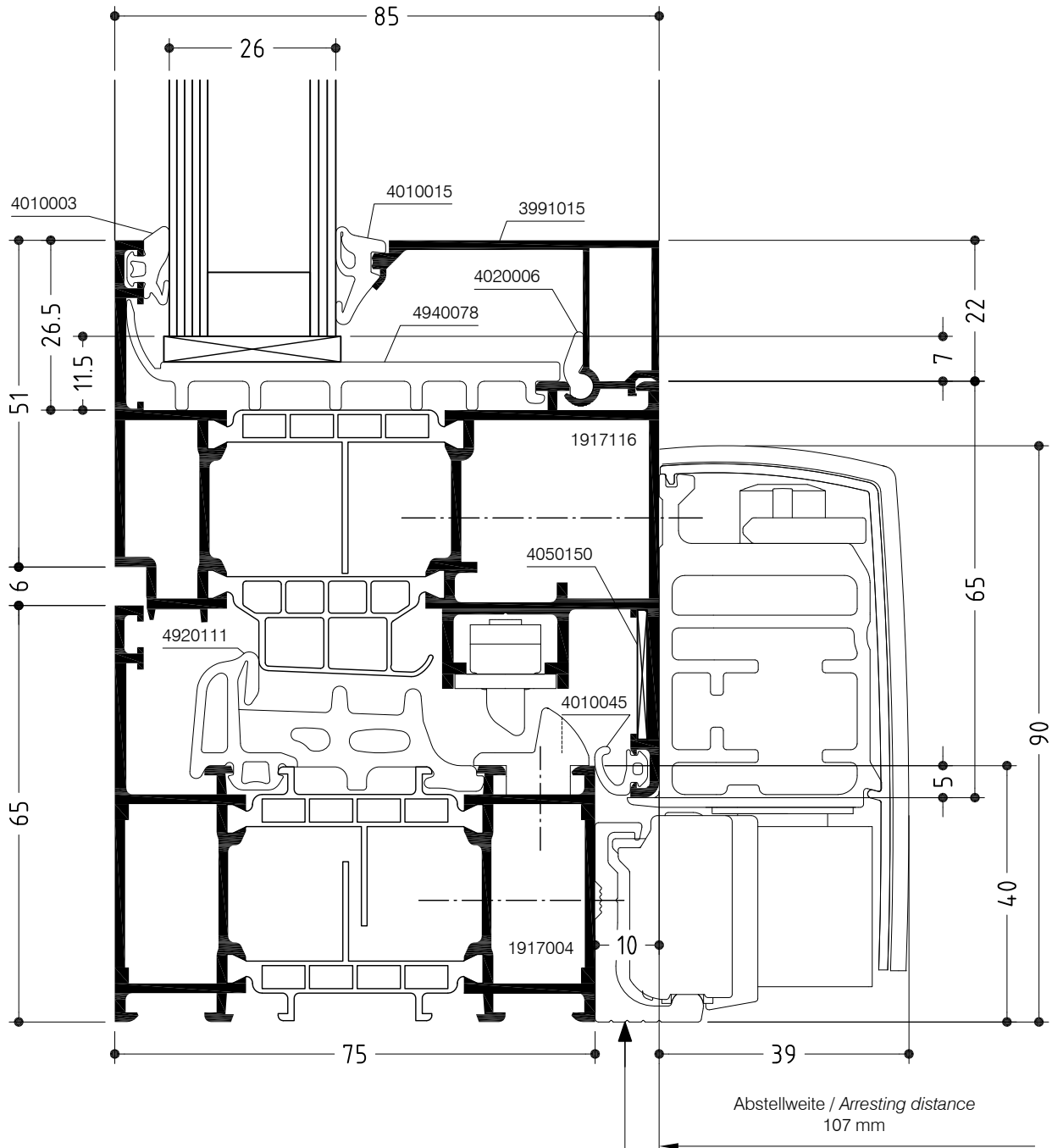
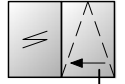

Für Laufschiene durchgehende Abstützung erforderlich!  
Continuous support necessary for slide rail!



# WICLINE 75

Konstruktionsschnitt

Construction section

Parallel-Schiebe-Kipp-Fenster (ohne Zwangssteuerung)

Flügelgewicht max. 100 kg

Parallel sliding tilt window (without force operation)

Sash weight max. 100 kg

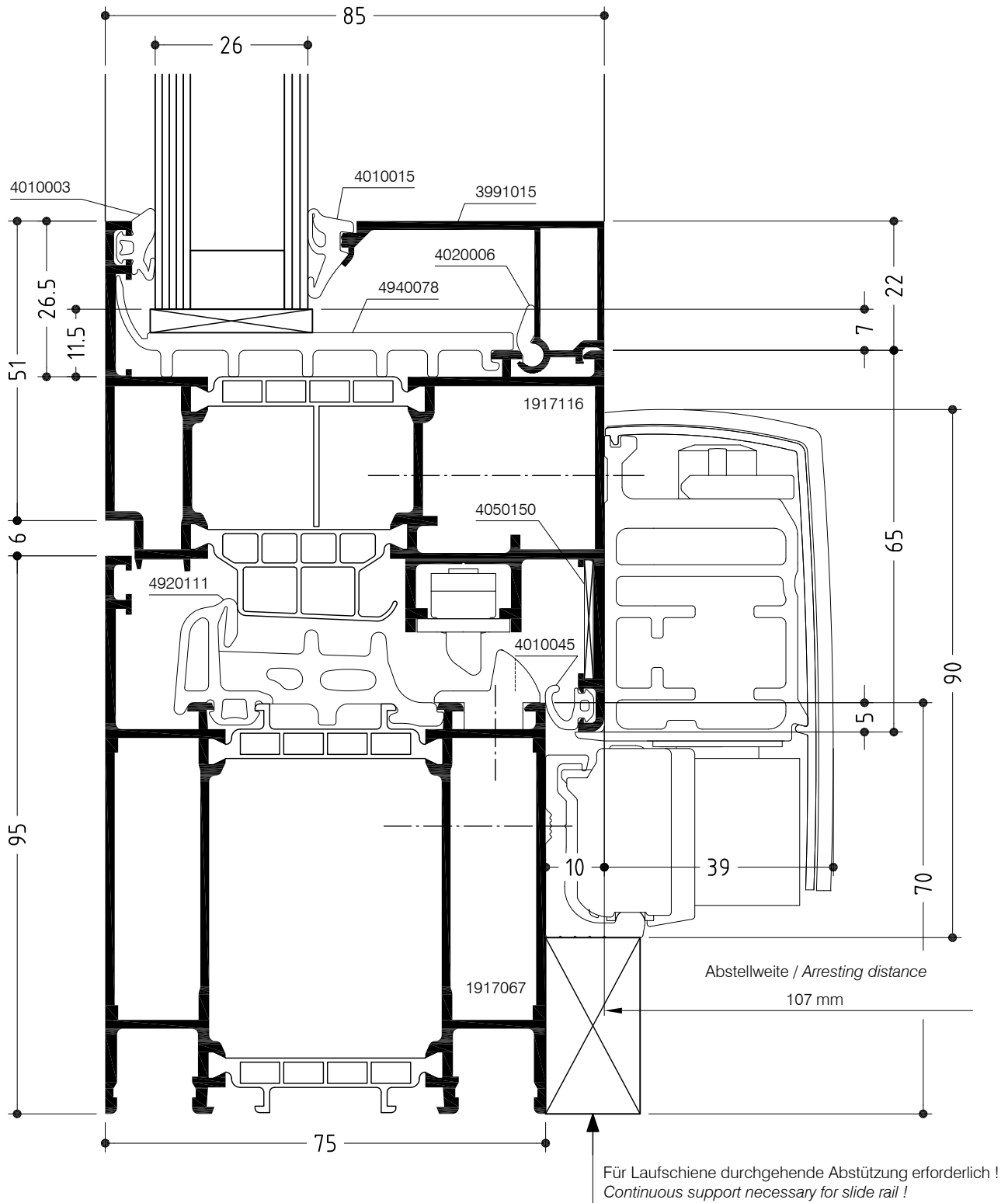
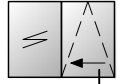

# WICLINE 75

Konstruktionsschnitt

Construction section

Parallel-Schiebe-Kipp-Fenster (ohne Zwangssteuerung)

Flügelgewicht max. 160 kg

Parallel sliding tilt window (without force operation)

Sash weight max. 160 kg

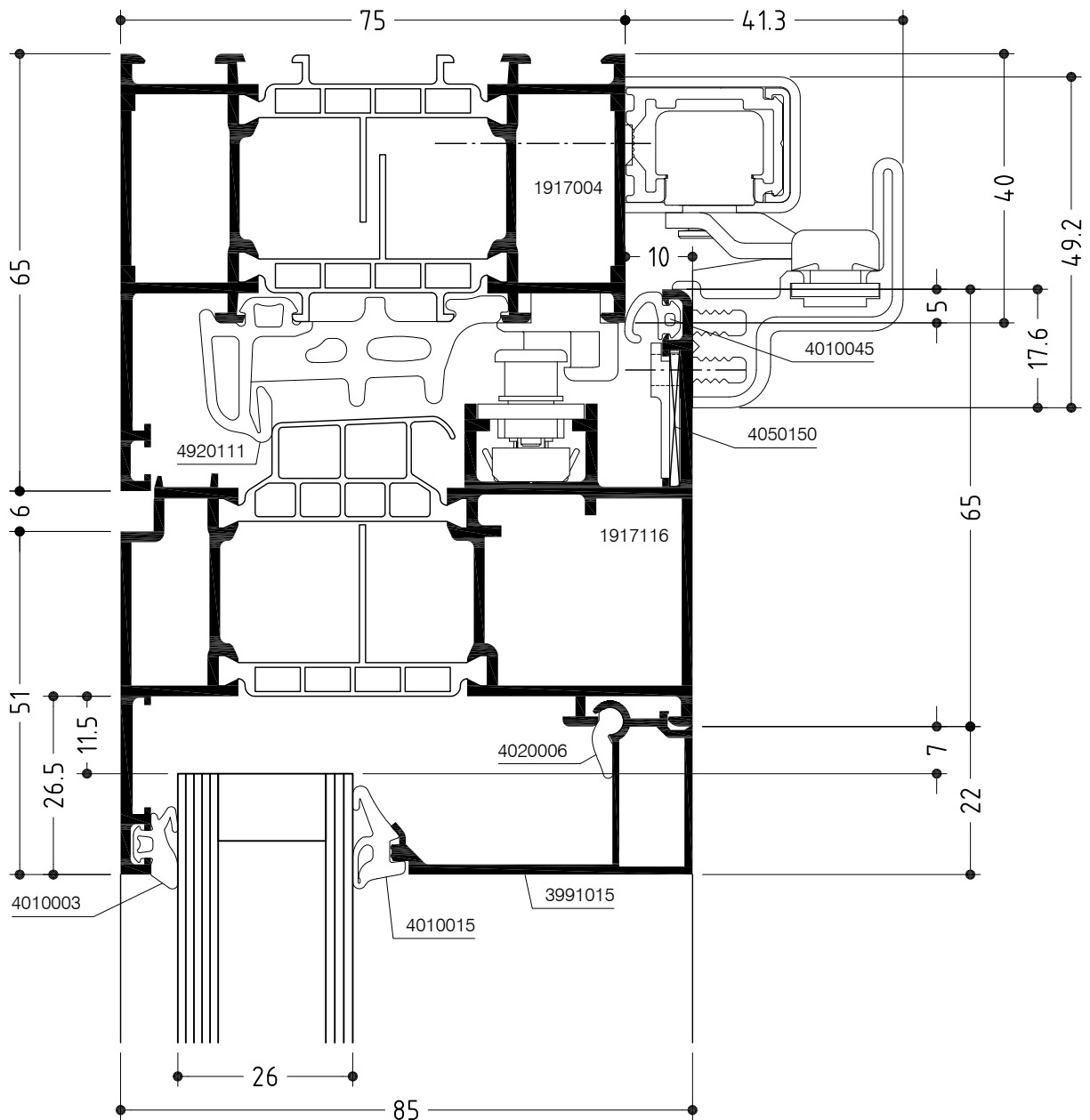
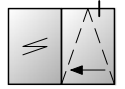

# WICLINE 75

Konstruktionsschnitt

Construction section

Parallel-Schiebe-Kipp-Fenster (ohne Zwangssteuerung)

Flügelgewicht max. 160 kg

Parallel sliding tilt window (without force operation)

Sash weight max. 160 kg

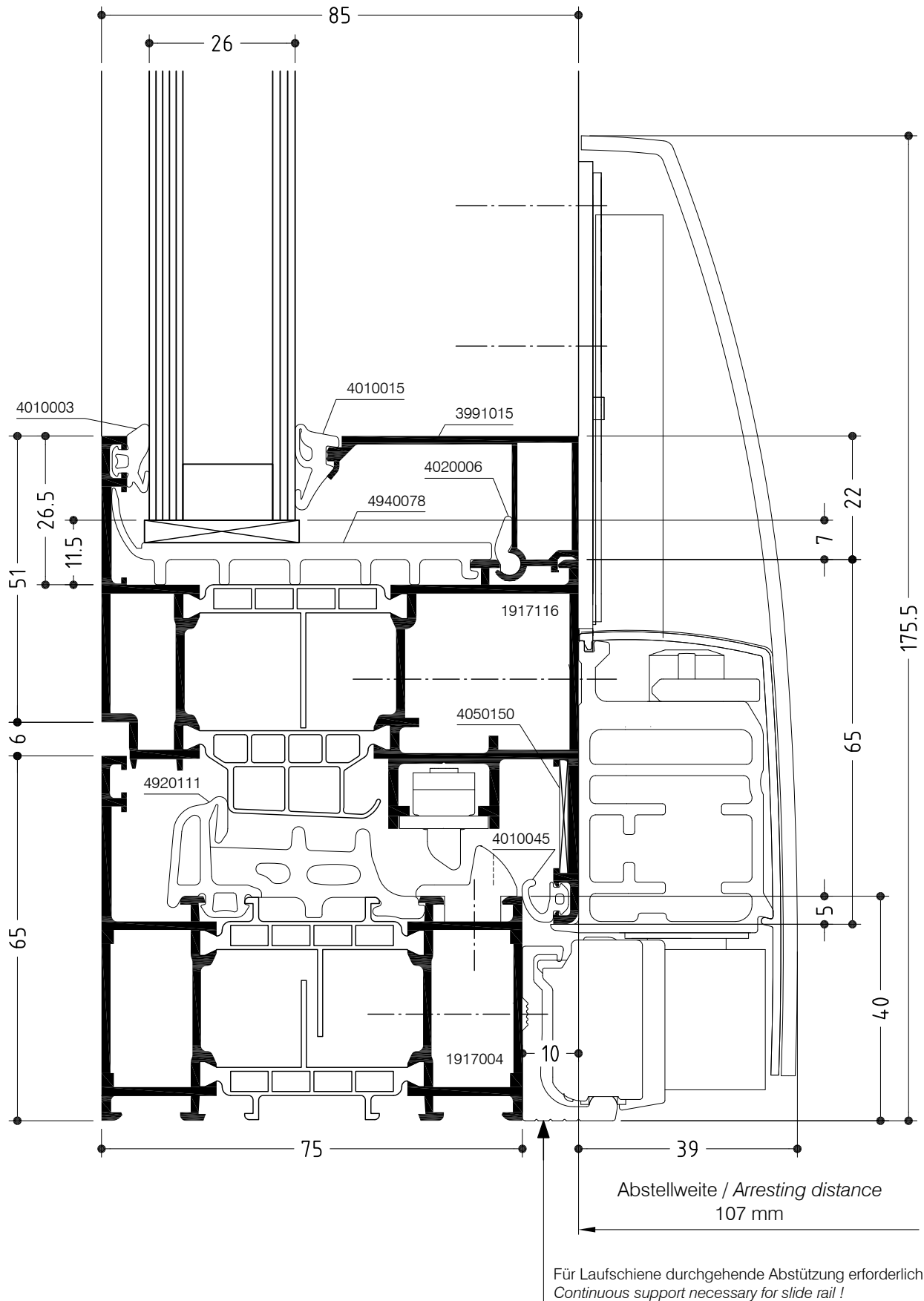
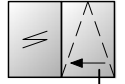

# WICLINE 75

Konstruktionsschnitt

Construction section

Parallel-Schiebe-Kipp-Fenster (mit Zwangssteuerung)

Flügelgewicht max. 100 kg

Parallel sliding tilt window (with force operation)

Sash weight max. 100 kg

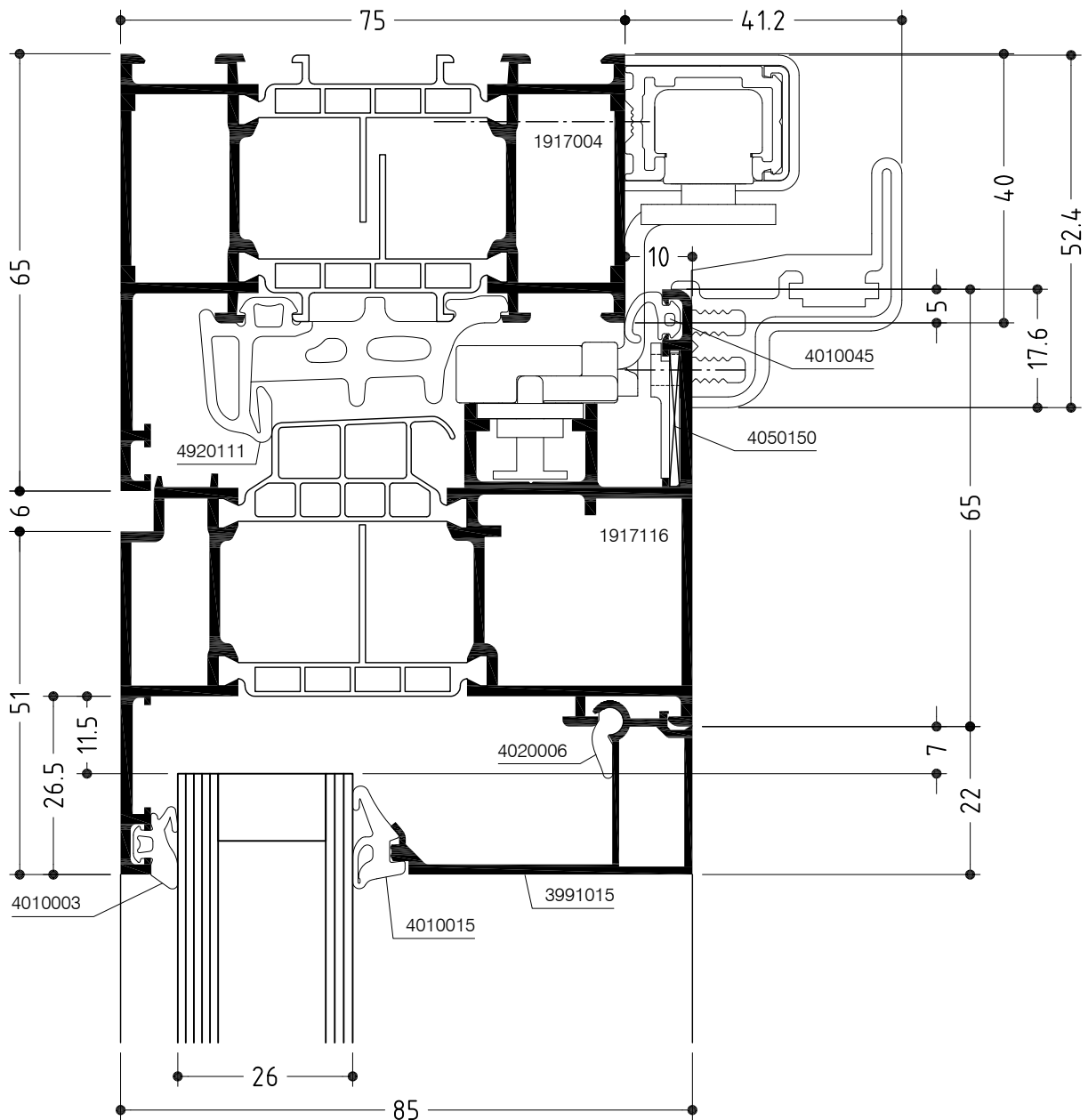
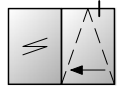

# WICLINE 75

Konstruktionsschnitt

Construction section

Parallel-Schiebe-Kipp-Fenster (mit Zwangssteuerung)

Flügelgewicht max. 100 kg

Parallel sliding tilt window (with force operation)

Sash weight max. 100 kg

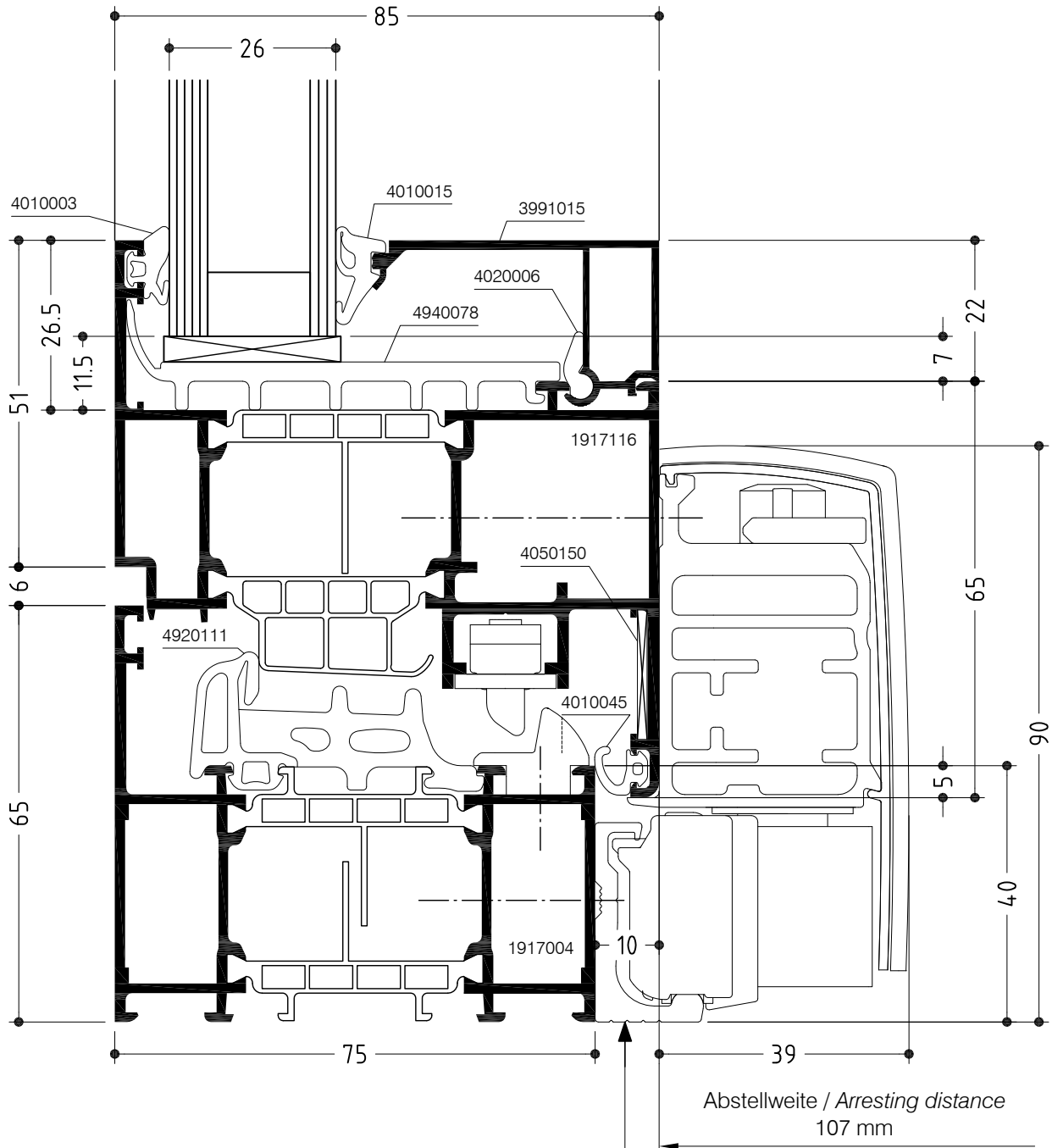
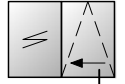

Für Laufschiene durchgehende Abstützung erforderlich!  
Continuous support necessary for slide rail!

# WICLINE 75

Konstruktionsschnitt

Construction section

Parallel-Schiebe-Kipp-Fenster (mit Zwangssteuerung)

Flügelgewicht max. 200 kg

Parallel sliding tilt window (with force operation)

Sash weight max. 200 kg

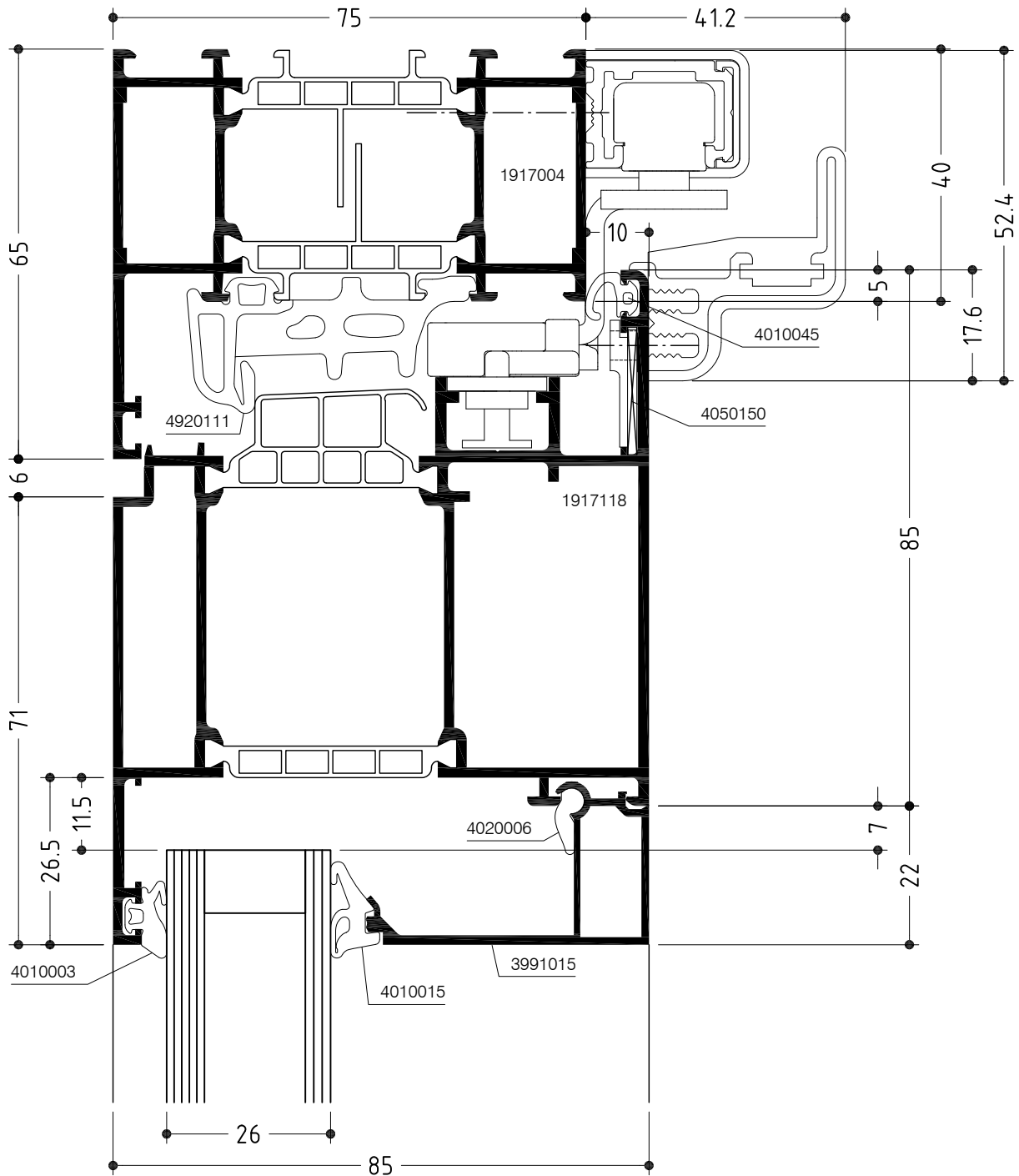
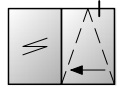

# WICLINE 75

Konstruktionsschnitt

Construction section

Parallel-Schiebe-Kipp-Fenster (mit Zwangssteuerung)

Flügelgewicht max. 200 kg

Parallel sliding tilt window (with force operation)

Sash weight max. 200 kg

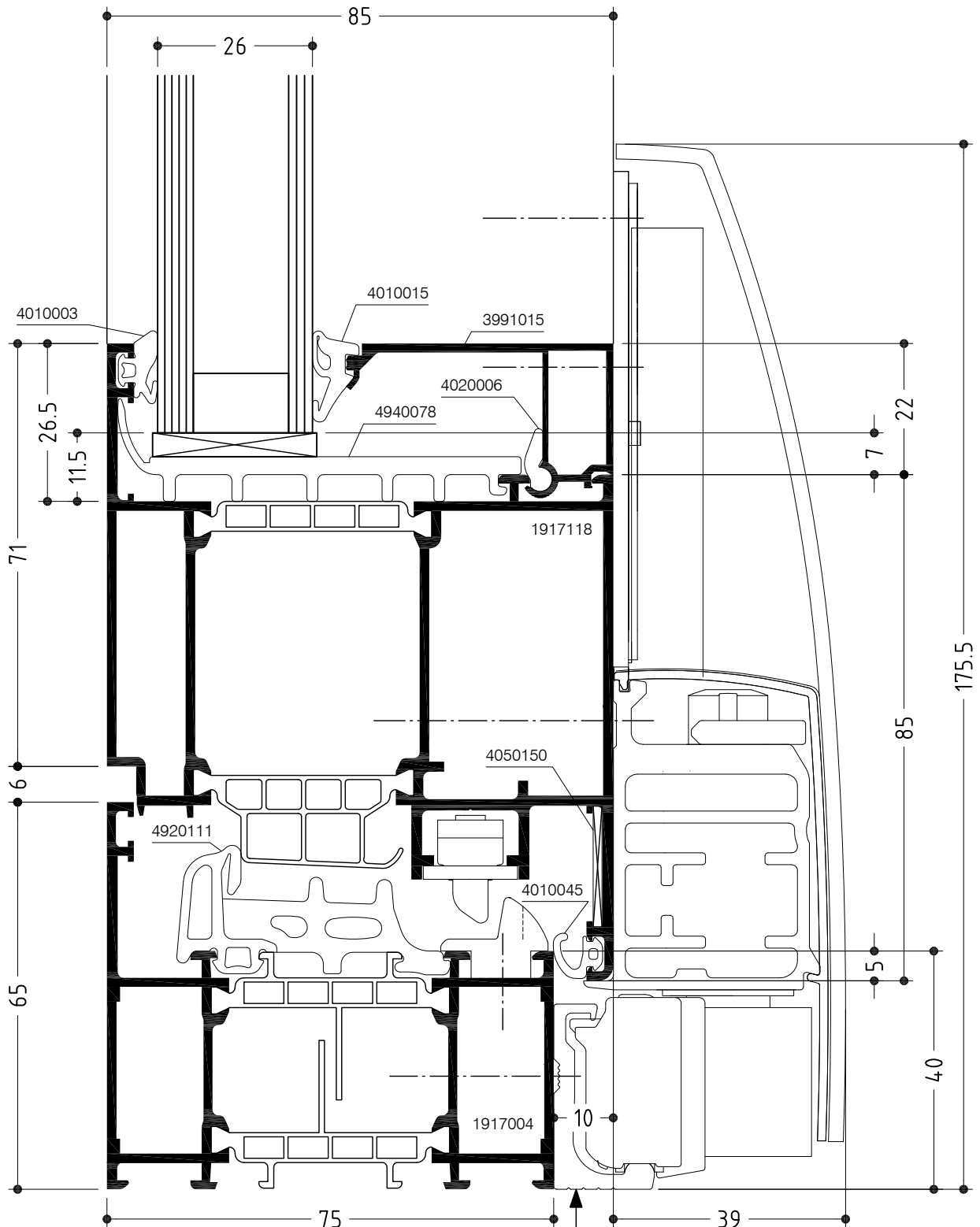
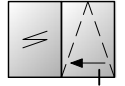

Abstellweite / Arresting distance  
107 mm

Für Laufschiene durchgehende Abstützung erforderlich!  
Continuous support necessary for slide rail!

# WICLINE 75

## Konstruktionsschnitt

### Construction section

Parallel-Schiebe-Kipp-Fenster - Mittelstoß

(ohne und mit Zwangssteuerung)

Parallel sliding tilt window - Meeting stiles

(without and with force operation)

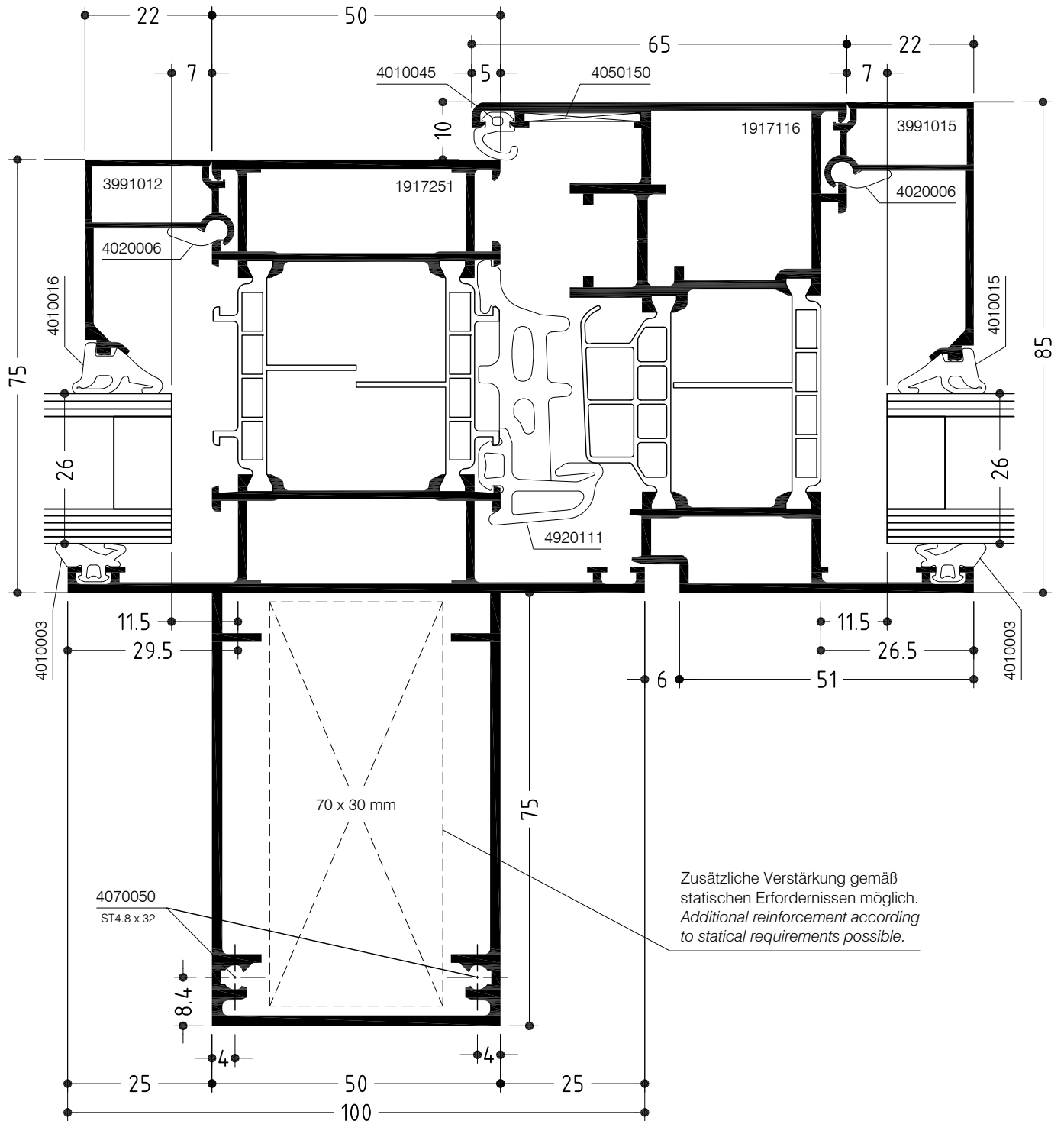
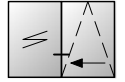



# WICLINE 75

## Konstruktionsschnitt

### Construction section

Flügelprofil im Blendrahmen mit Kämpfer

EH-Verriegelung / Füllungssicherung

Sash profile in frame with transom

Burglar resistant locking / Infill safeguard

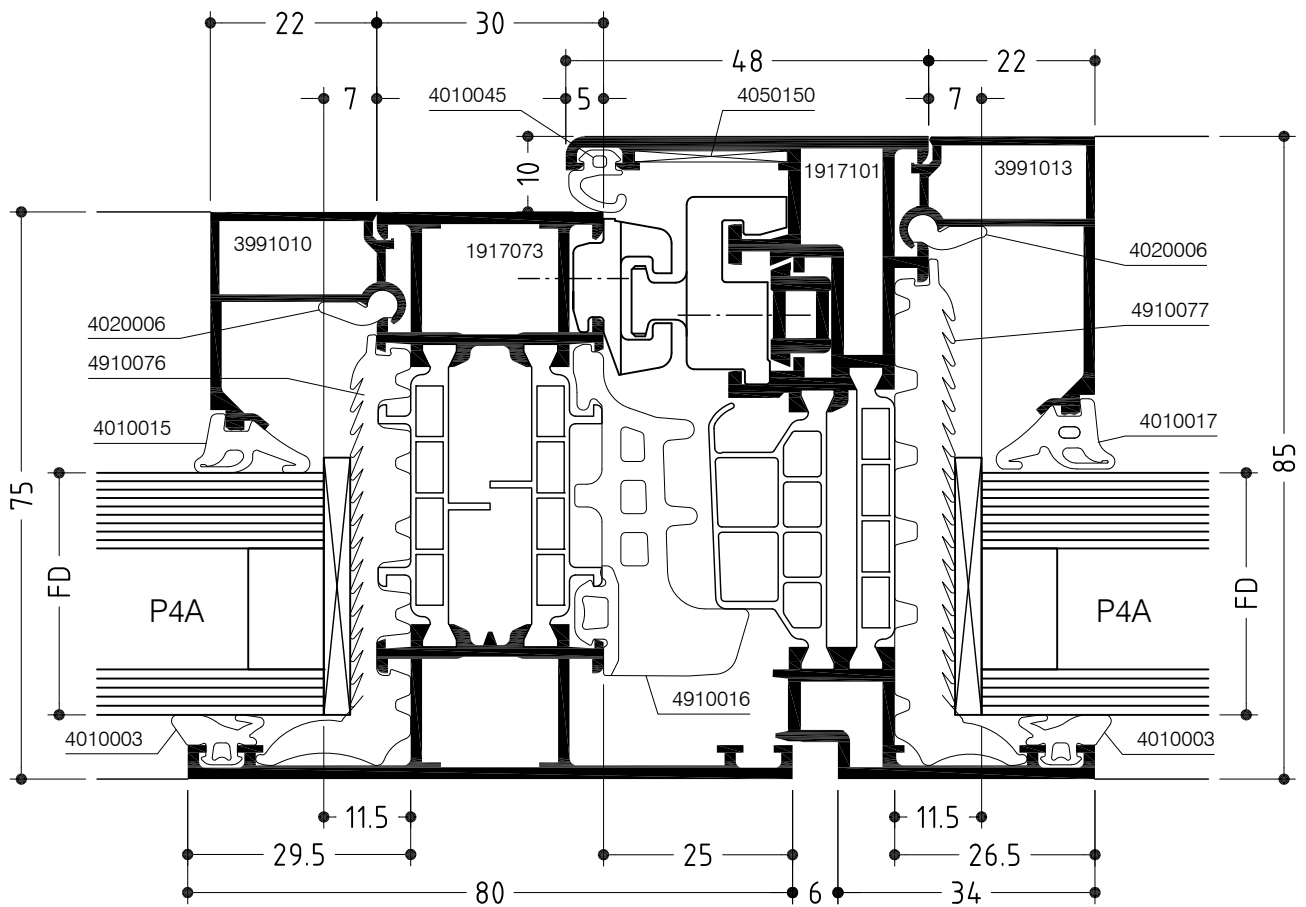
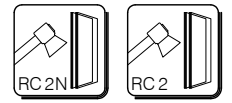
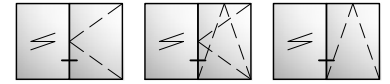

# WICLINE 75

Konstruktionsschnitt

Construction section

Flügelprofil im Blendrahmen mit Kämpfer

EH-Verriegelung / Füllungssicherung

Sash profile in frame with transom

Burglar resistant locking / Infill safeguard

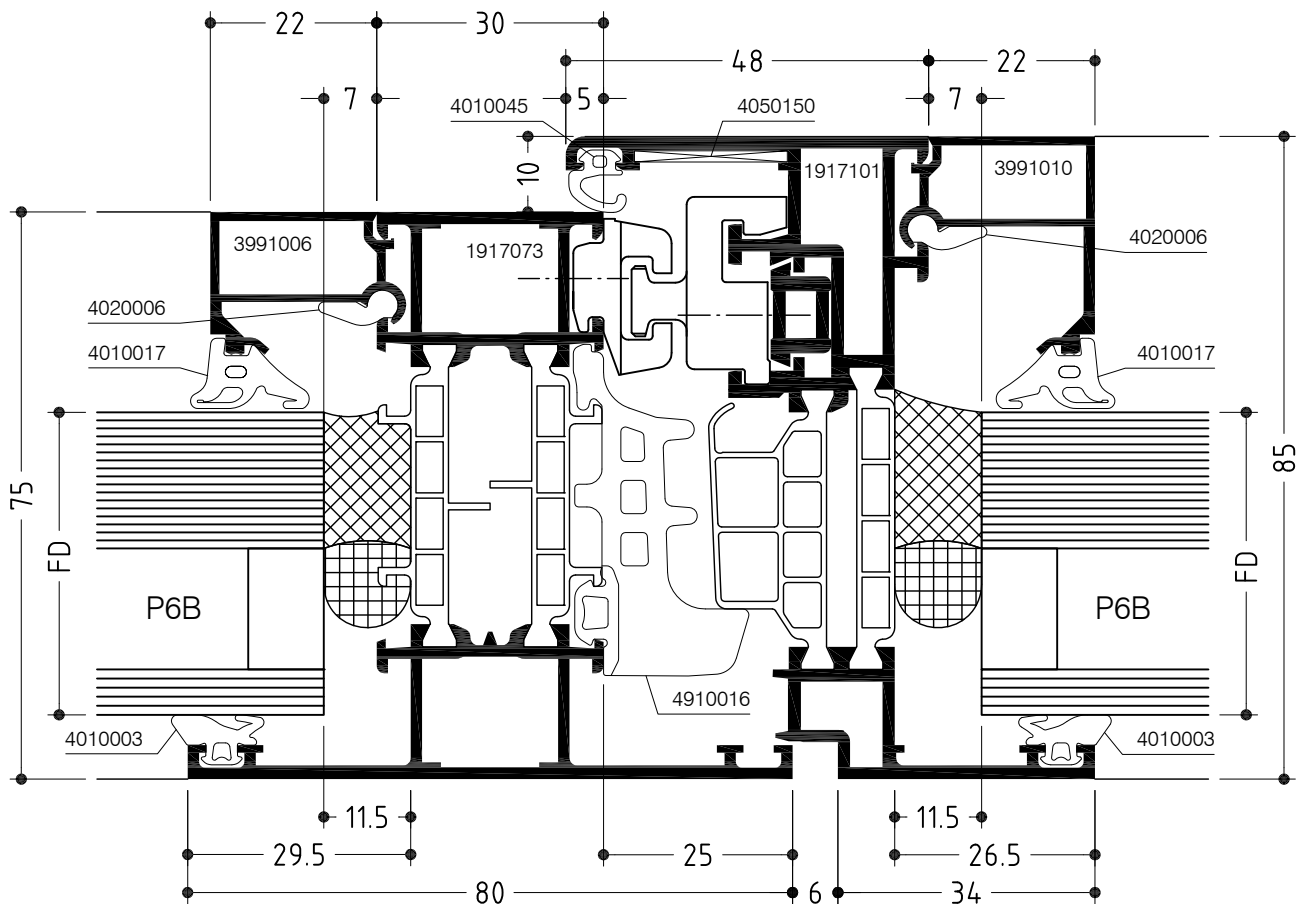
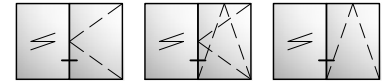





# WICLINE 75

## Konstruktionsschnitt

### Construction section

Flügelprofil im Blendrahmen mit Kämpfer, Klassik-Design

EH-Verriegelung / Füllungssicherung

Sash profile in frame with transom, Classic design

Burglar resistant locking / Infill safeguard

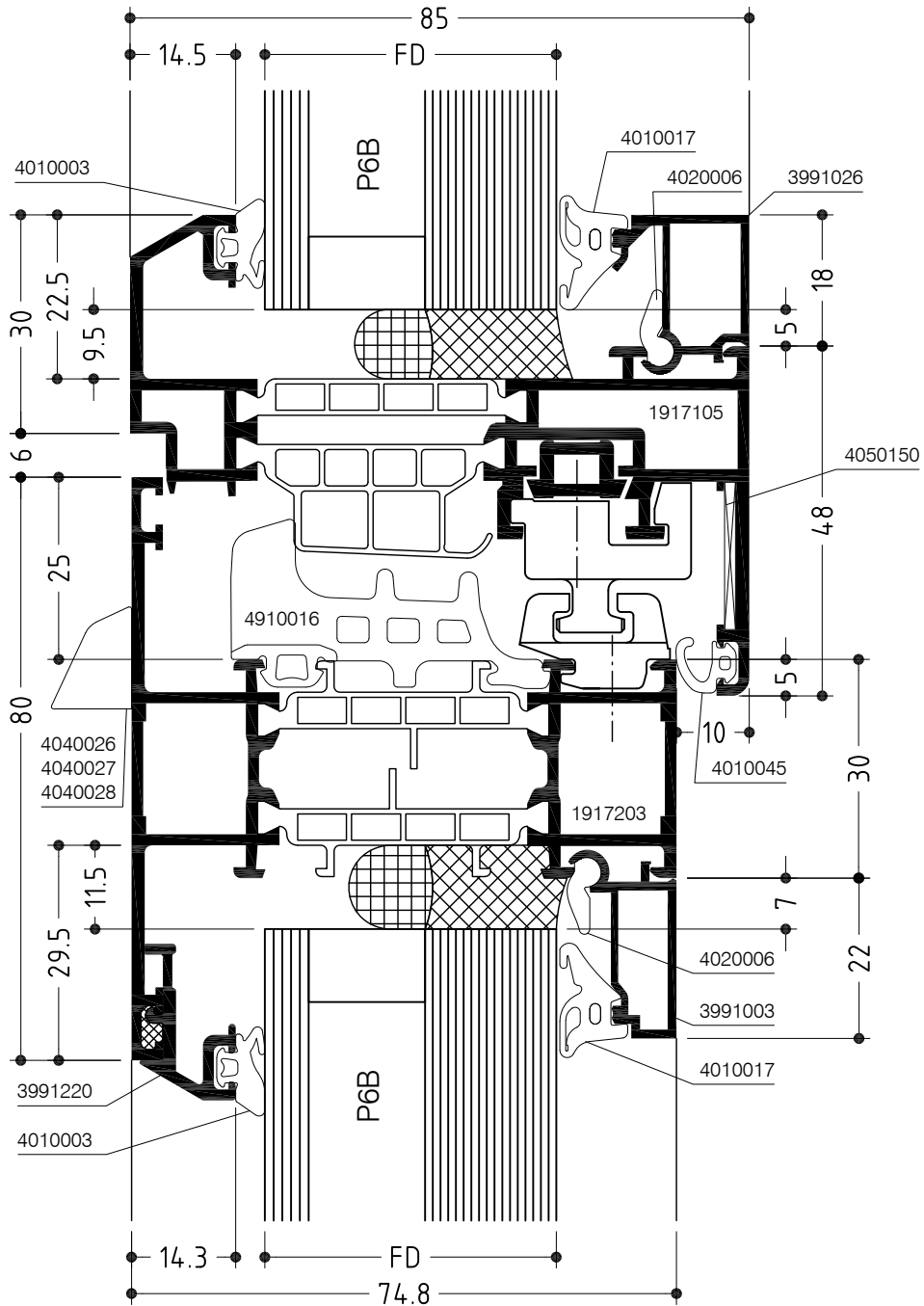
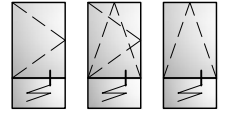



# WICLINE 75

## Konstruktionsschnitt

### Construction section

Flügelprofil im Blendrahmen mit Kämpfer, verdeckter Flügel

EH-Verriegelung / Füllungssicherung

Concealed sash in frame with transom

Burglar resistant locking / Infill safeguard

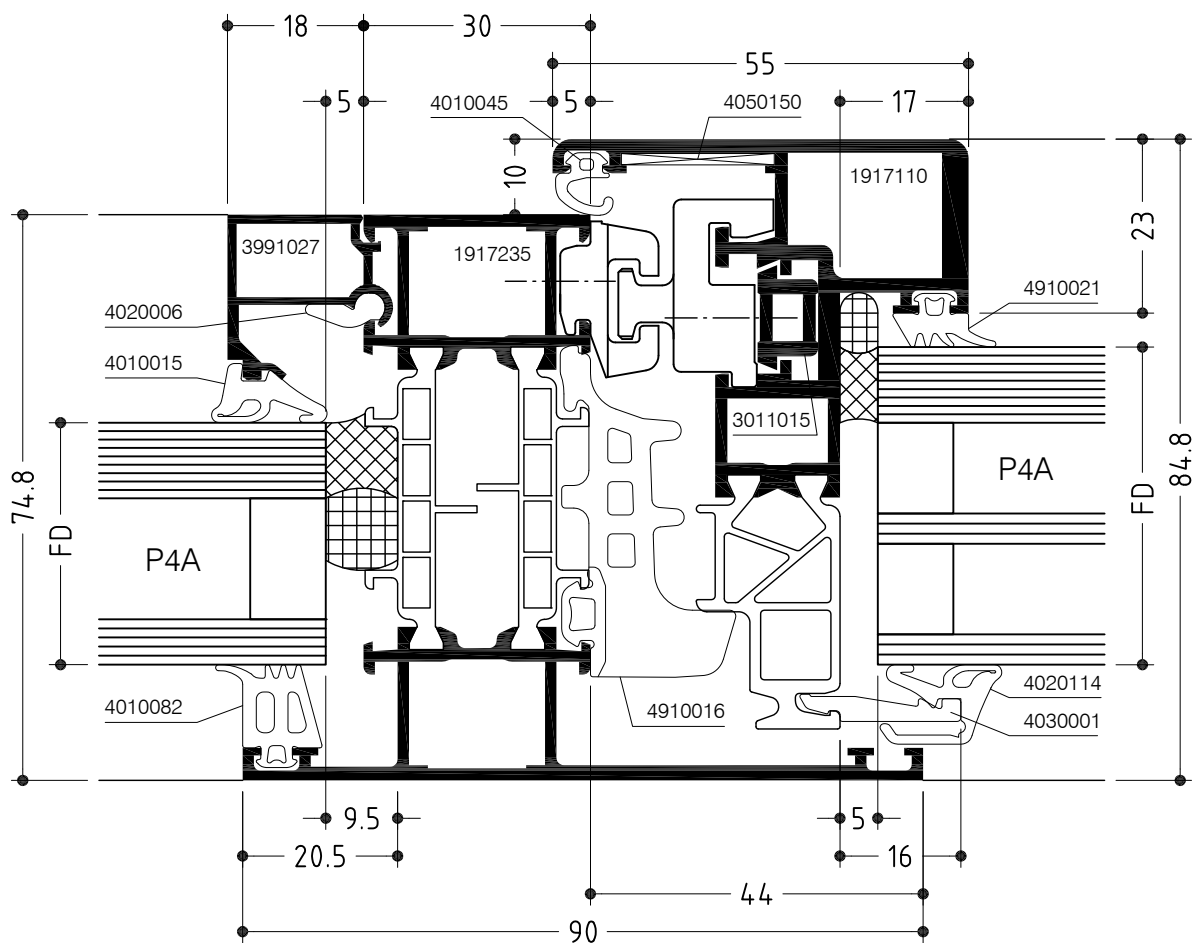
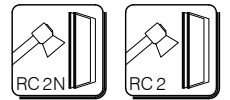
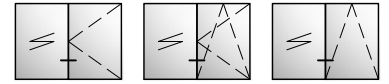

# WICLINE 75

Konstruktionsschnitt

Construction section

Flügelprofil im Blendrahmen mit Kämpfer, verdeckter Flügel

EH-Verriegelung / Füllungssicherung

Concealed sash in frame with transom

Burglar resistant locking / Infill safeguard

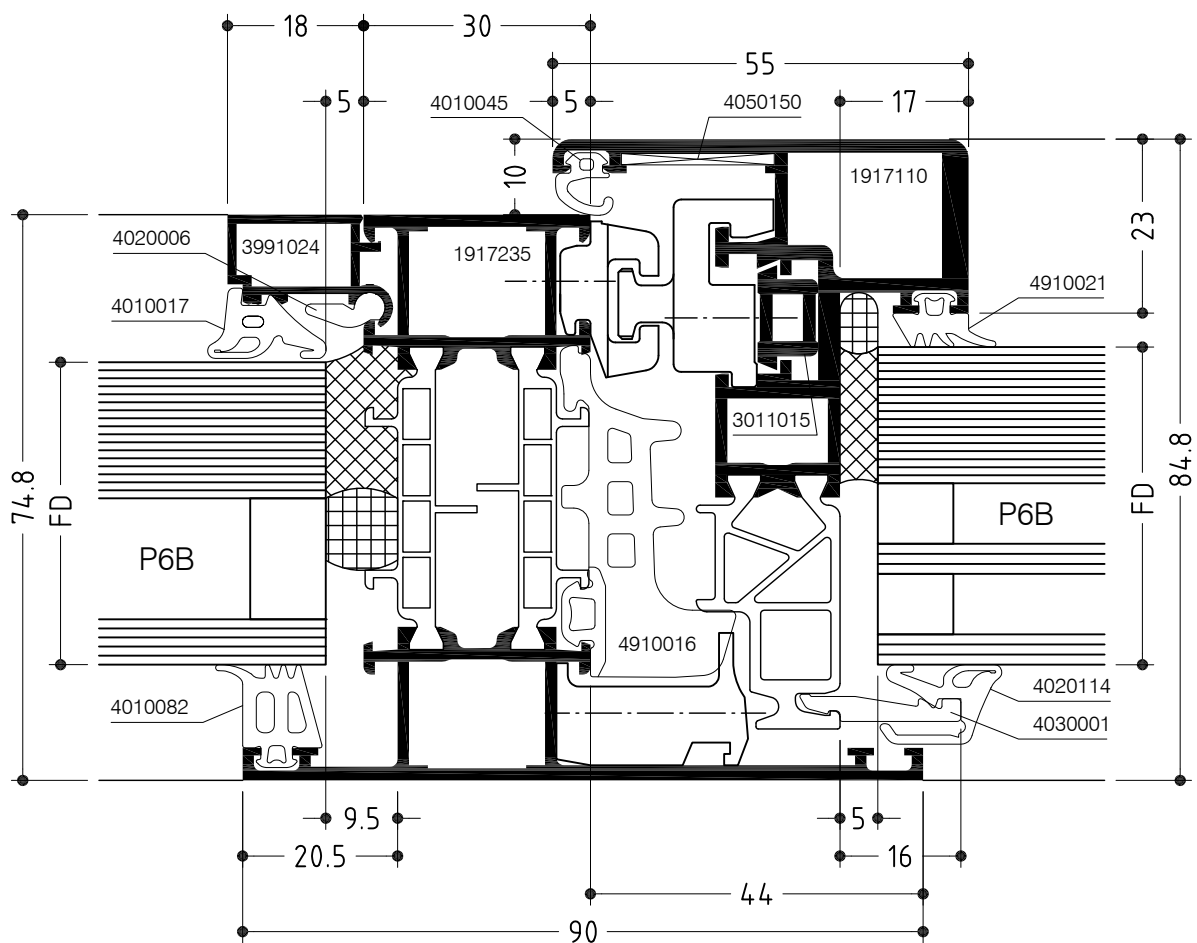
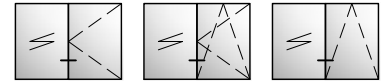



# WICLINE 75

Blendrahmen  
Festverglasung  
Frame profile  
Fixed glazing

Konstruktionsschnitt  
Construction section

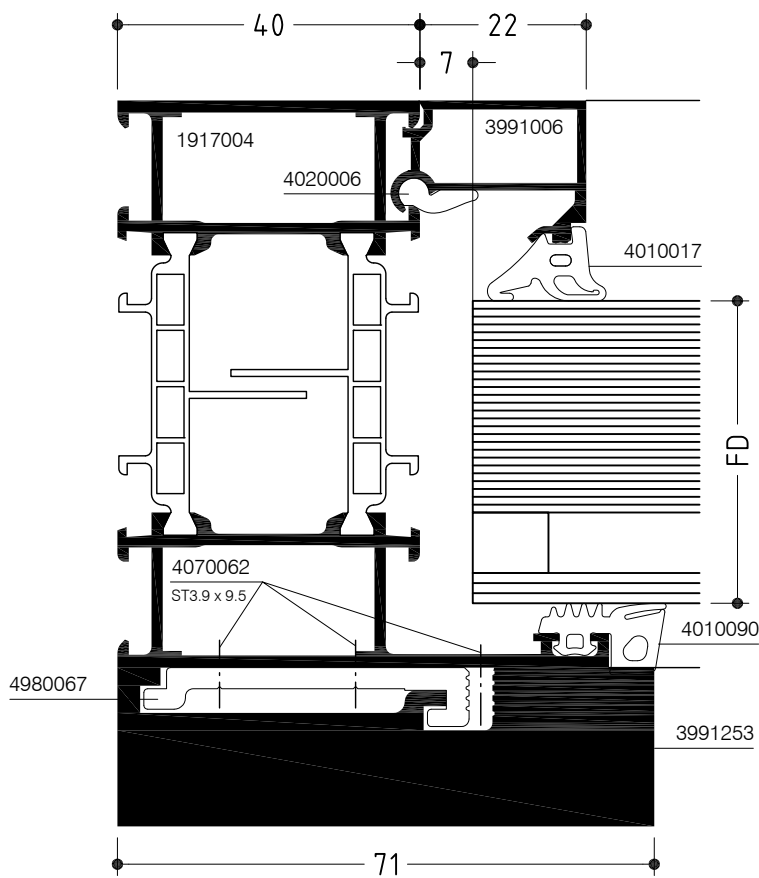

# WICLINE 75

Konstruktionsschnitt  
Construction section

Elementkopplung  
Festverglasung  
Unit coupling  
Fixed glazing

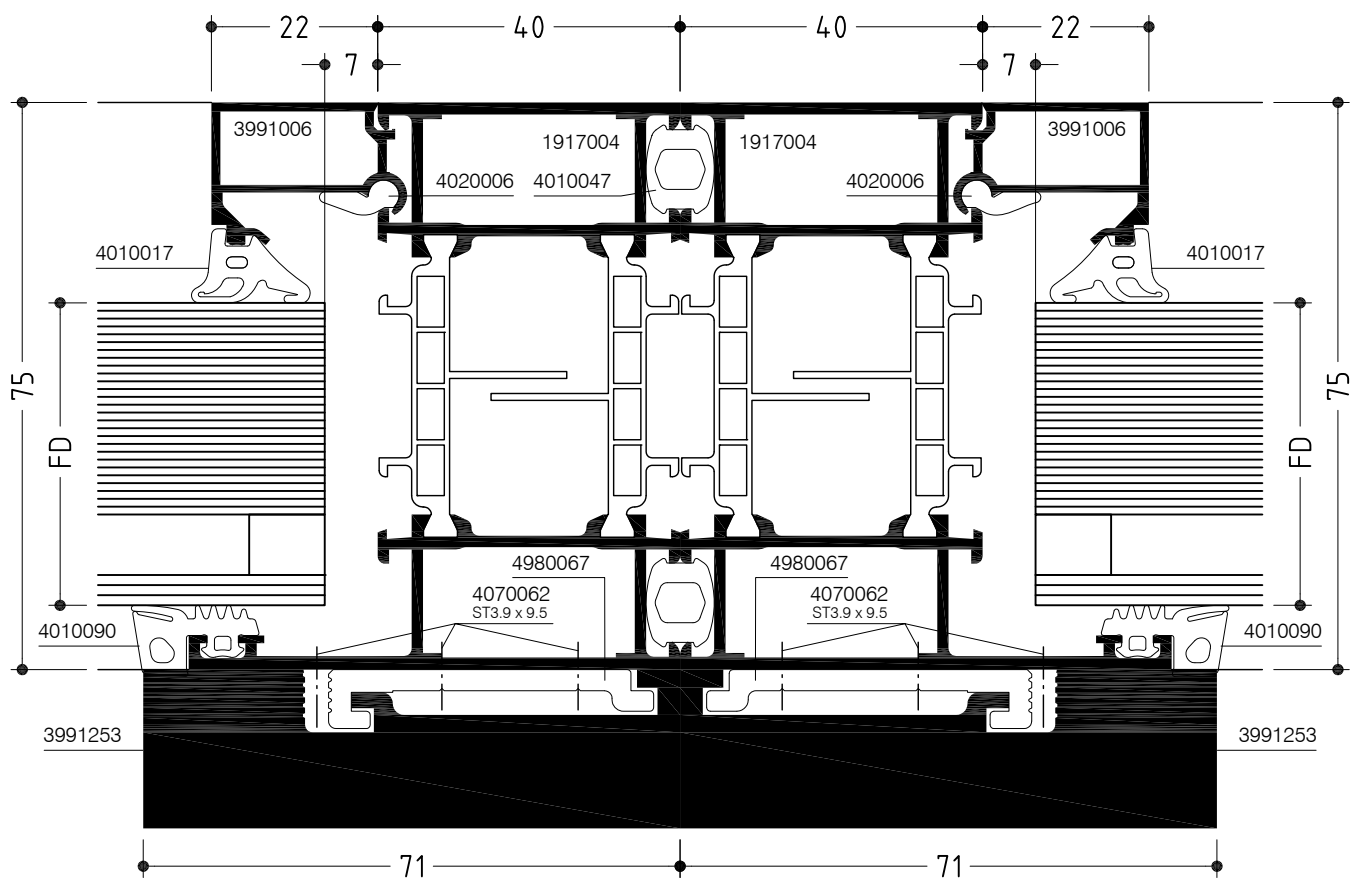
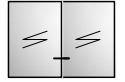

# WICLINE 75

Blendrahmen  
Fensterflügel  
Frame profile  
Window sash

Konstruktionsschnitt  
Construction section

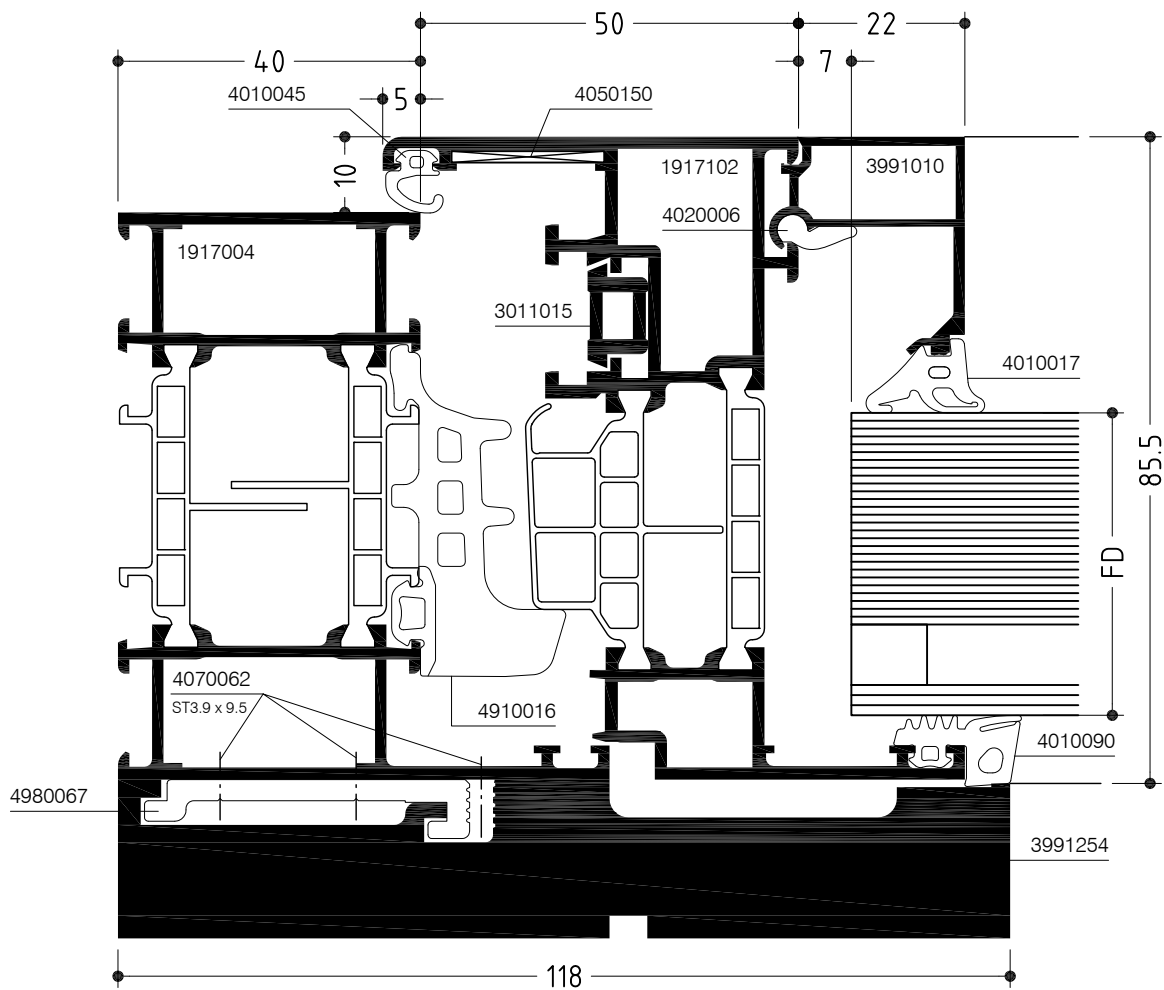

# WICLINE 75

Elementkopplung  
Fensterflügel / Festverglasung  
Unit coupling  
Window sash / Fixed glazing

Konstruktionsschnitt  
Construction section

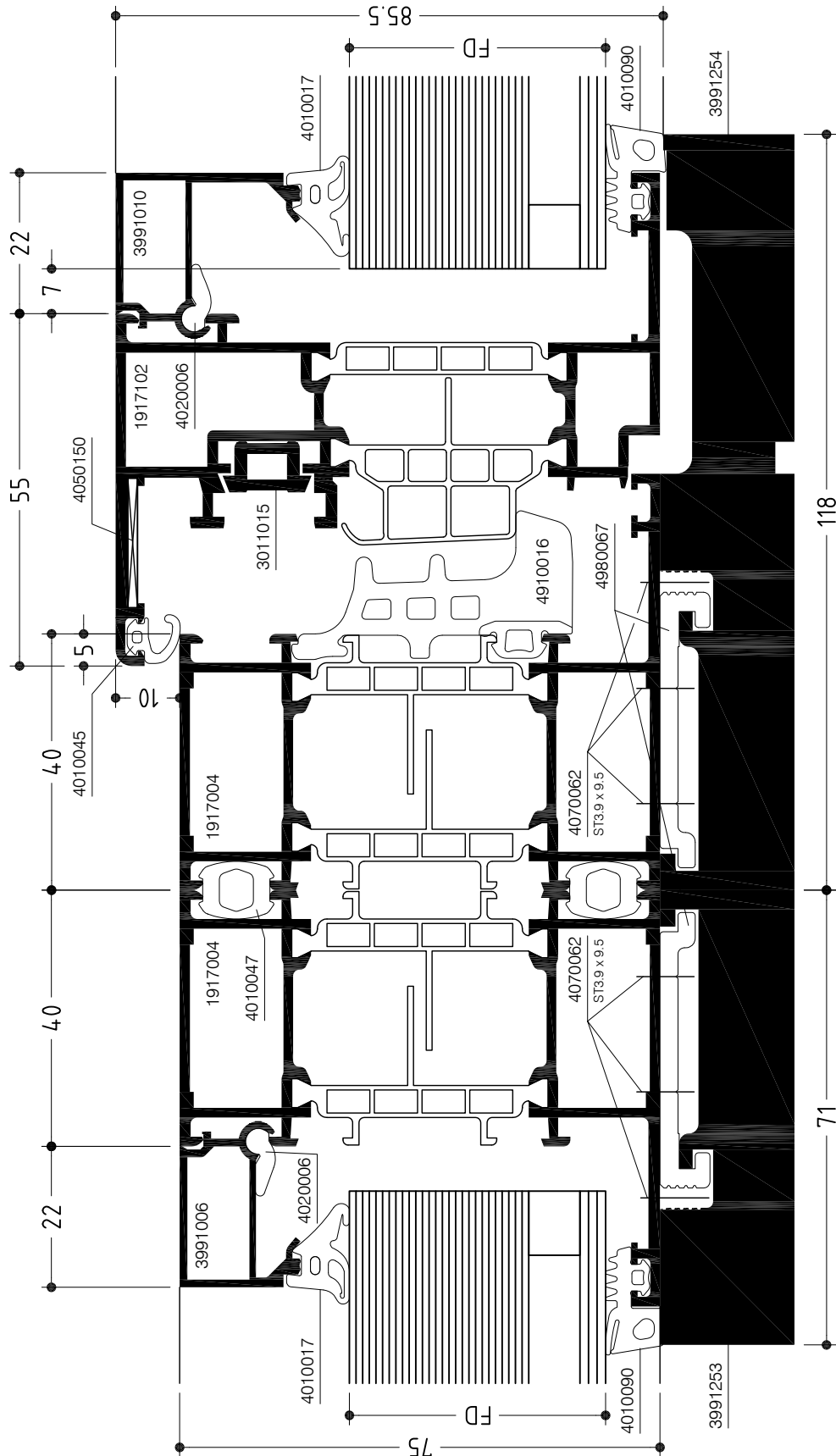
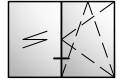

# WICLINE 75

Elementkopplung  
Fensterflügel  
Unit coupling  
Window sash

Konstruktionsschnitt  
Construction section

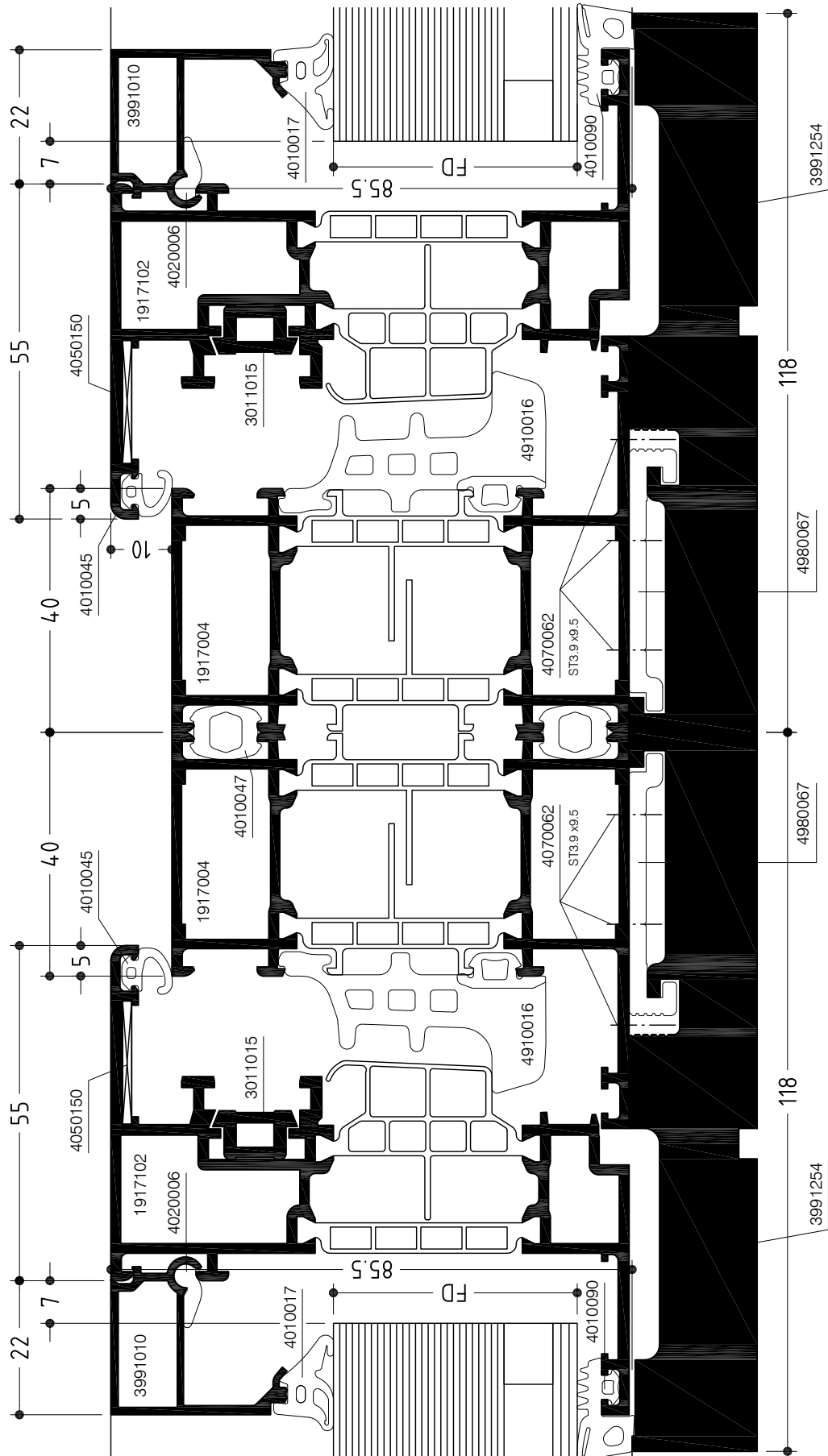

# WICLINE 75

Kämpferprofil  
Festverglasung  
Transom profile  
Fixed glazing

Konstruktionsschnitt  
Construction section

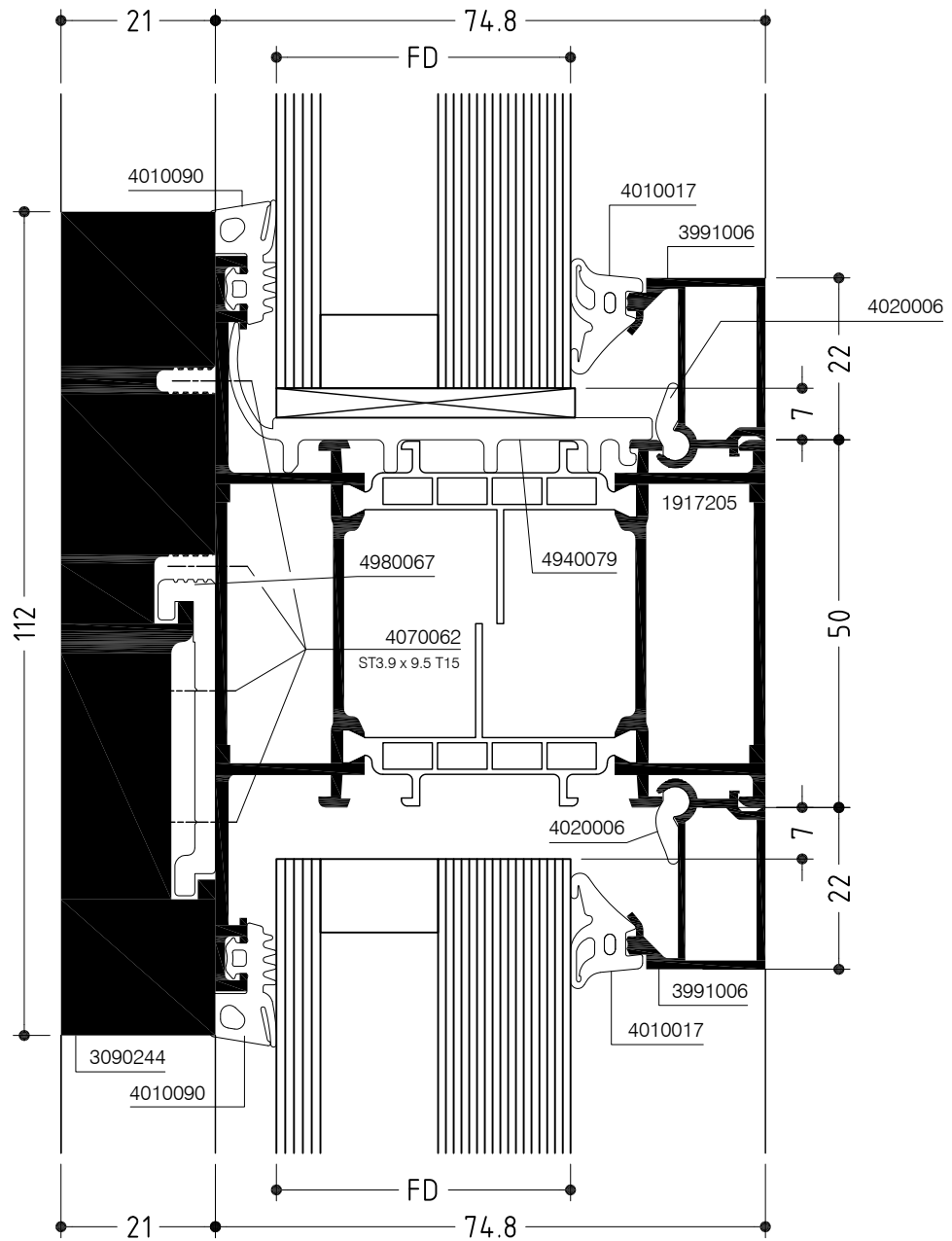
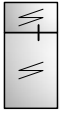

# WICLINE 75

Kämpferprofil  
Festverglasung  
Transom profile  
Fixed glazing

Konstruktionsschnitt  
Construction section

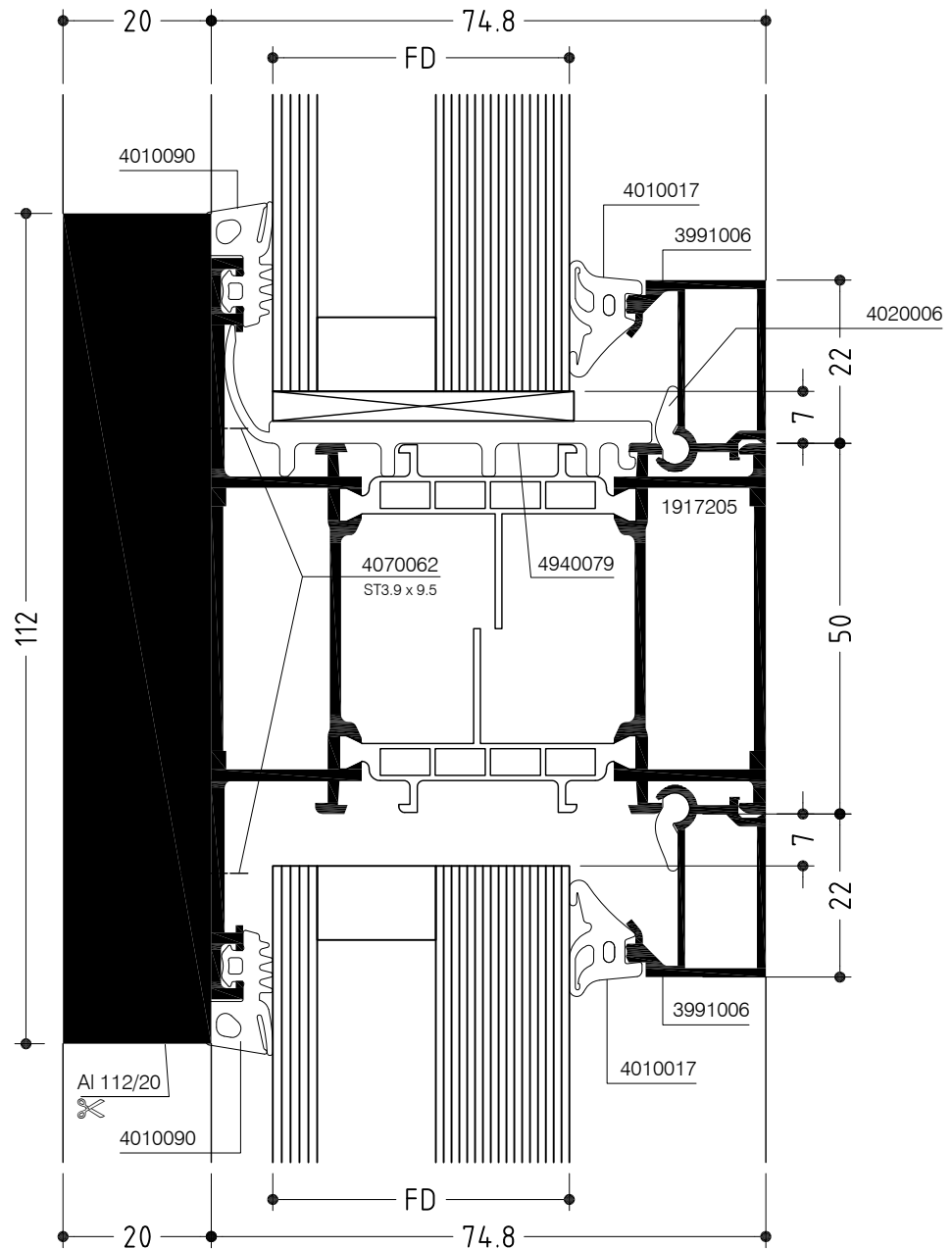





# WICLINE 75

Konstruktionsschnitt  
Construction section

Hochwärmedämmend

Flügelprofil im Blendrahmen mit Spezial-Dämmprofil

High insulated

Sash profile in frame with special insulation profile

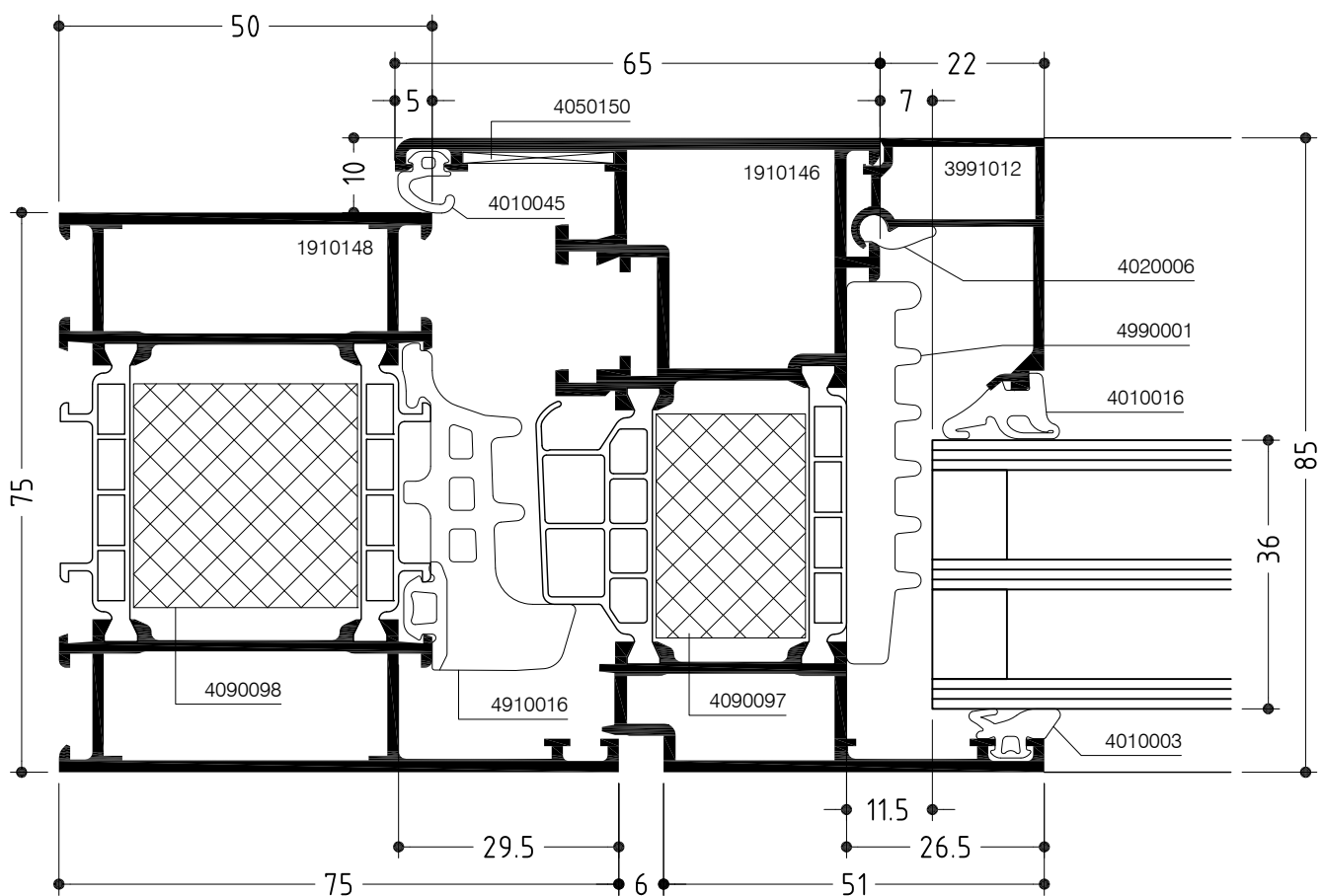

# WICLINE 75

Konstruktionsschnitt

Construction section

Hochwärmedämmend

Flügelprofil im Blendrahmen mit Spezial-Dämmprofil

High insulated

Sash profile in frame with special insulation profile

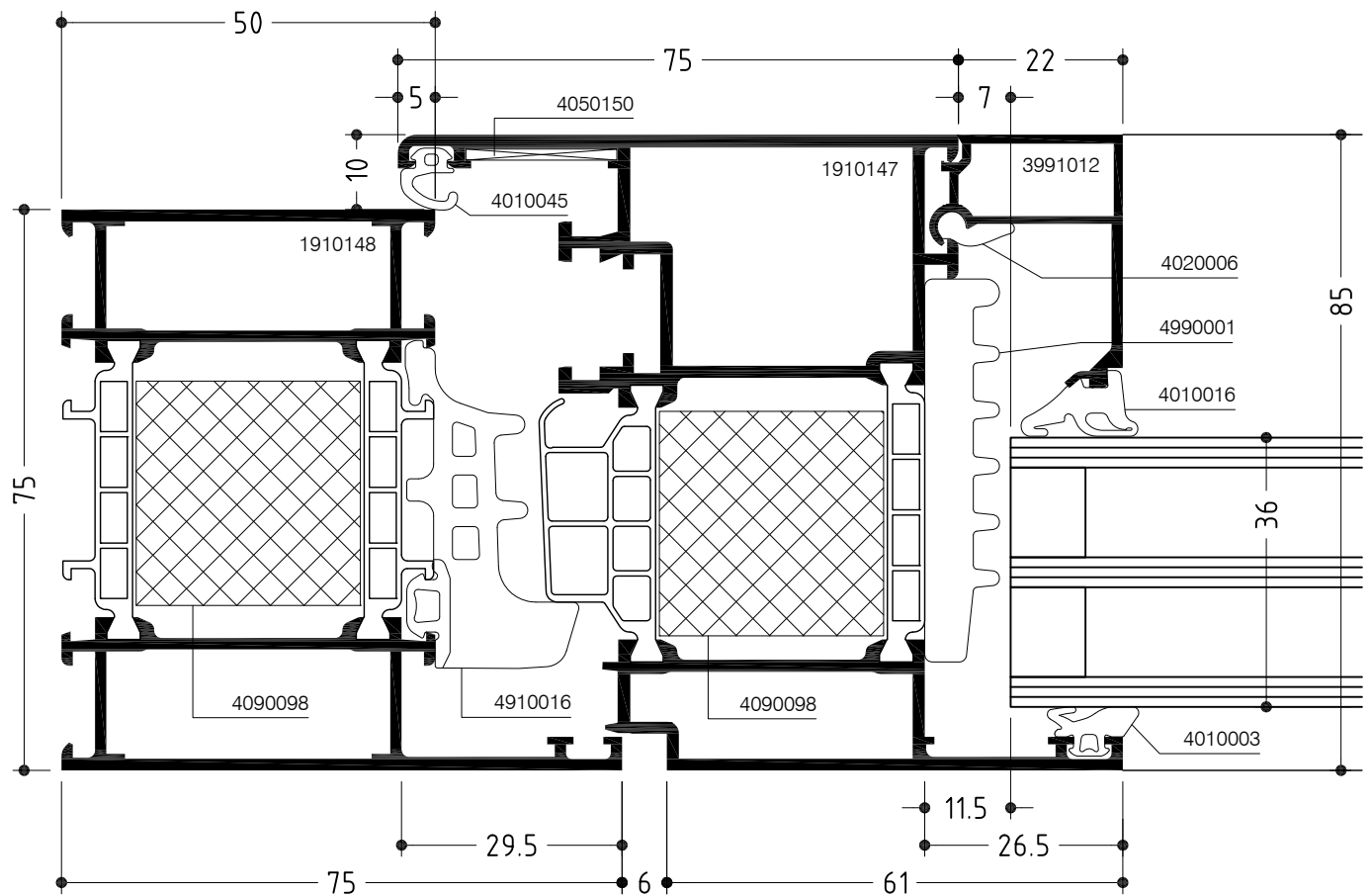



# WICLINE 75

Konstruktionsschnitt

Construction section

Hochwärmedämmend

Kämpferprofil mit Festverglasung und Spezial-Dämmprofil

High insulated

Transom profile with fixed glazing and special insulation profile

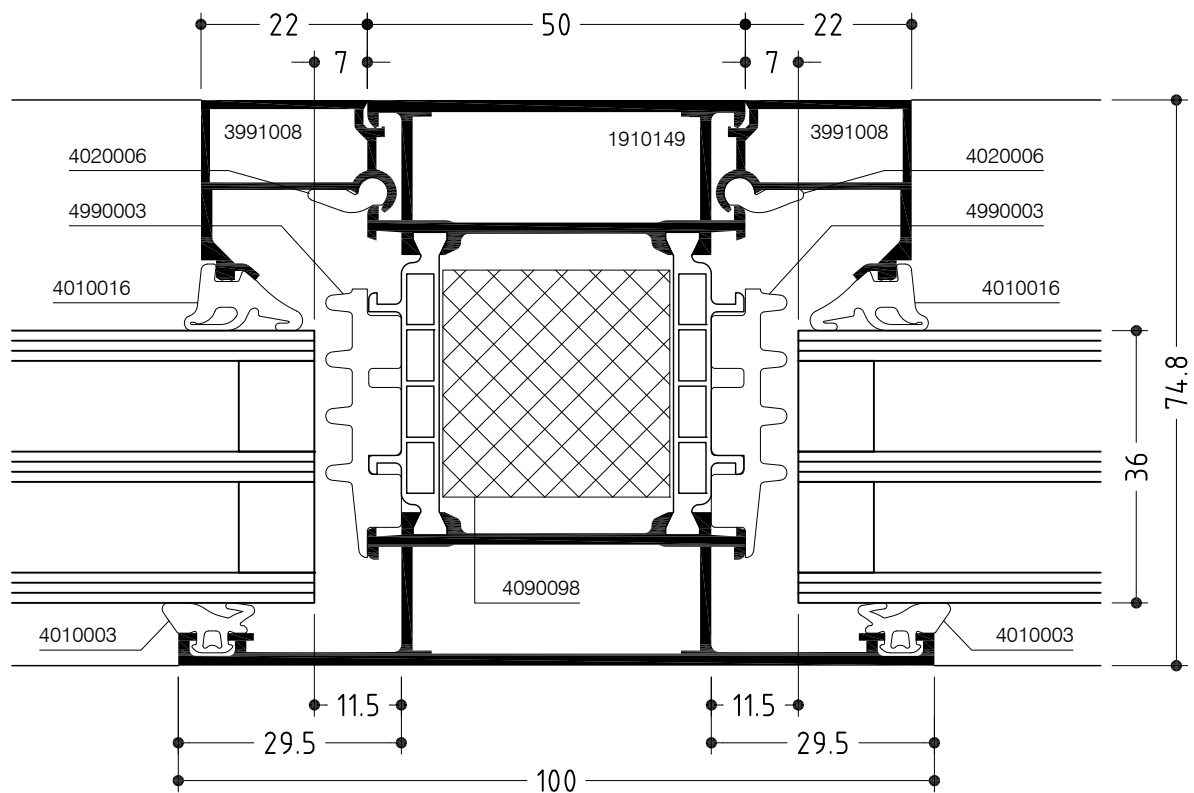
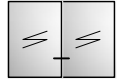

# WICLINE 75

Konstruktionsschnitt

Construction section

Hochwärmedämmend

Kämpferprofil mit Festverglasung und Spezial-Dämmprofil

High insulated

Transom profile with fixed glazing and special insulation profile

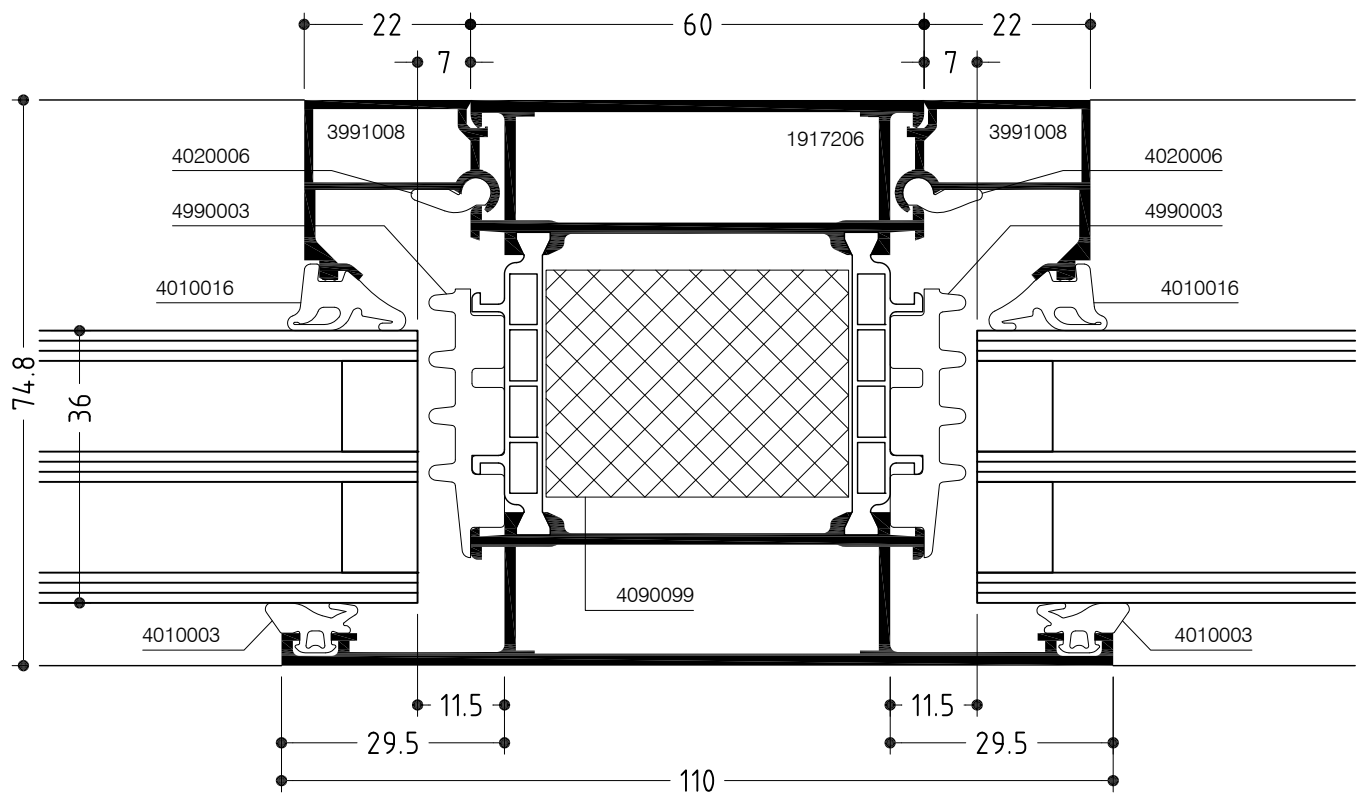
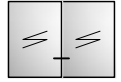

# WICLINE 75

Konstruktionsschnitt  
Construction section

Hochwärmедämmend

Kämpferprofil mit Festverglasung und Spezial-Dämmprofil

High insulated

Transom profile with fixed glazing and special insulation profile

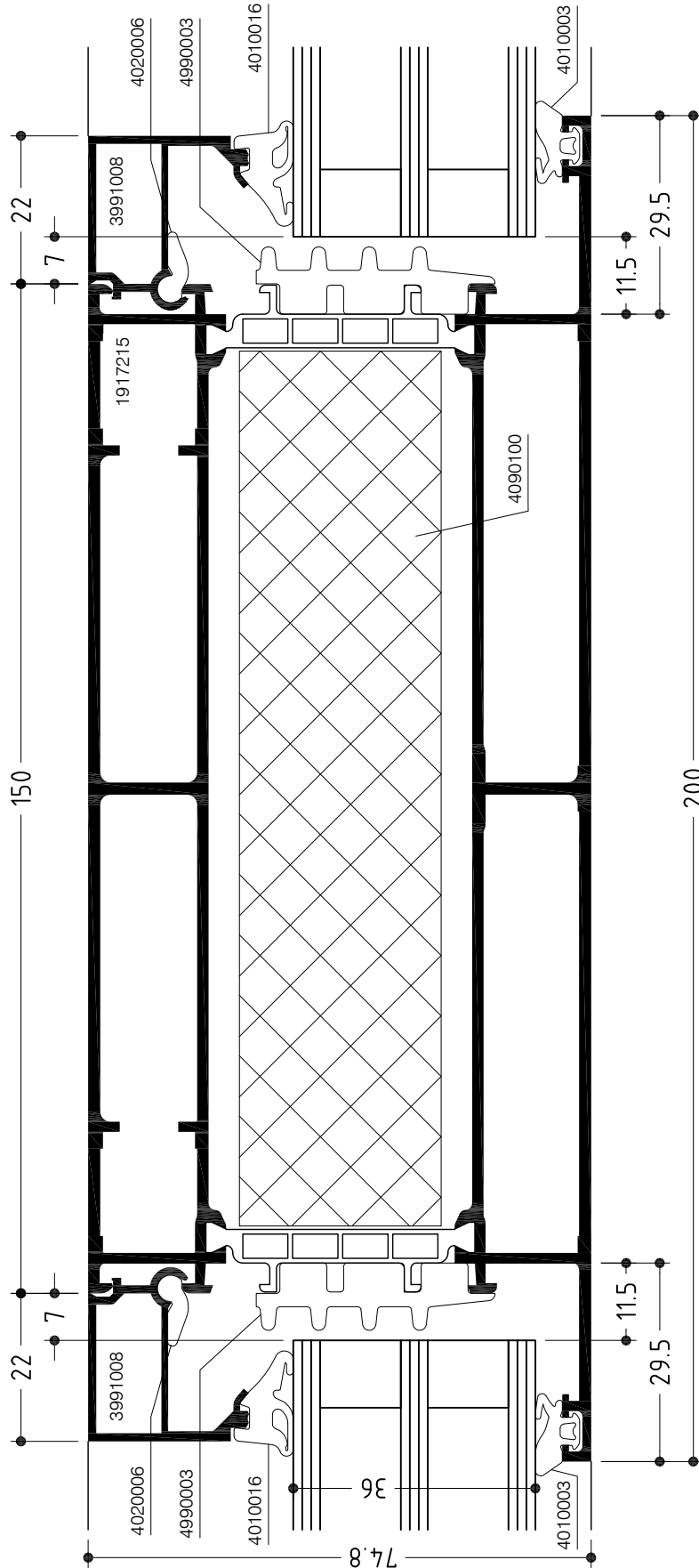
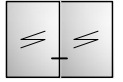

# WICLINE 75

Konstruktionsschnitt  
Construction section

Hochwärmedämmend

Kämpferprofil mit Festverglasung und Spezial-Dämmprofil

High insulated

Transom profile with fixed glazing and special insulation profile

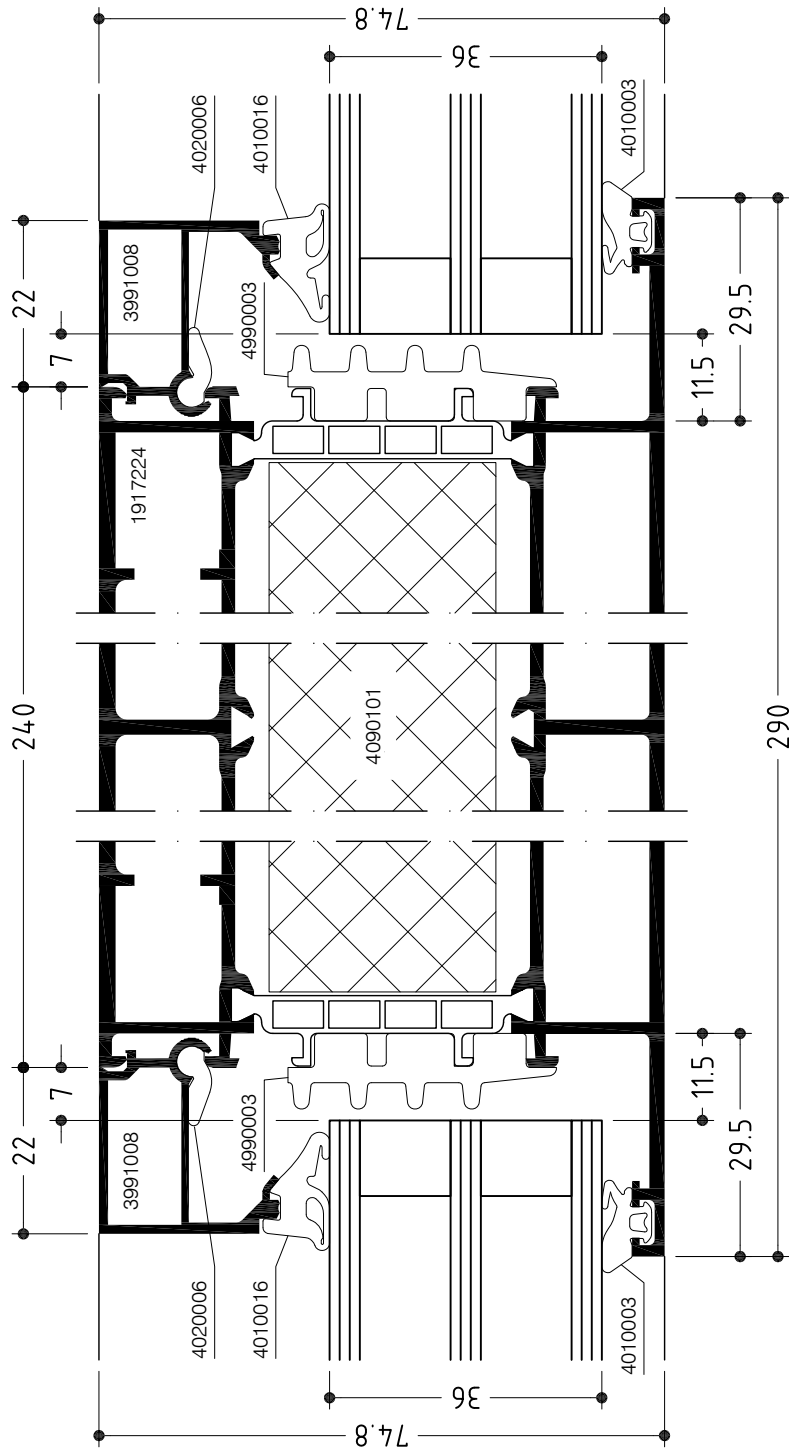
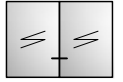

# WICLINE 75

Konstruktionsschnitt  
Construction section

Hochwärmedämmend

Festverglasung mit Spezial-Dämmprofil

High insulated

Fixed glazing with special insulation profile

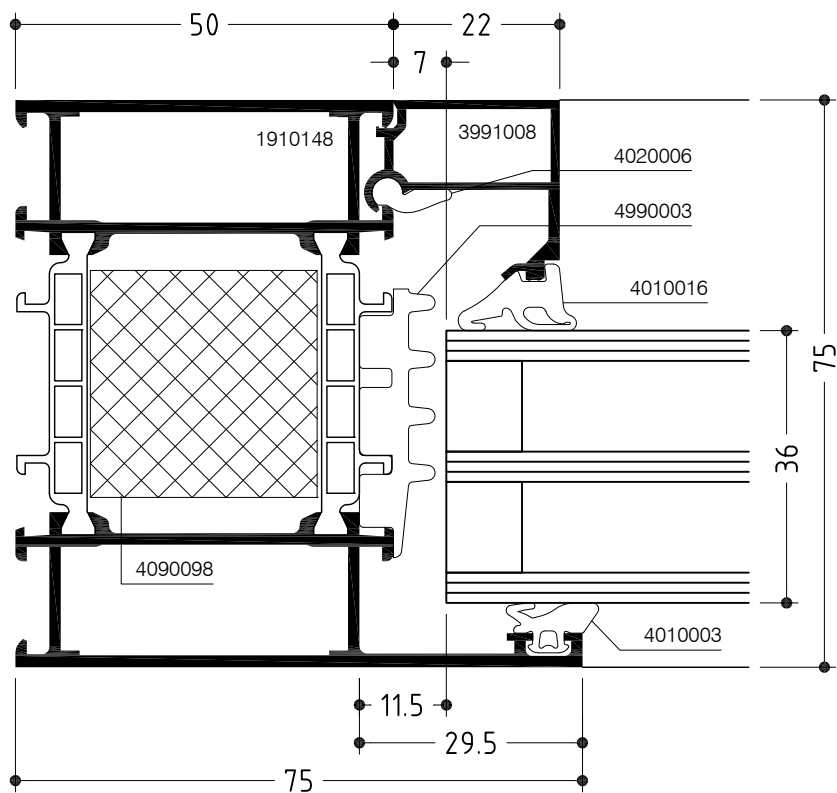



# WICLINE 75

Konstruktionsschnitt

Construction section

MINERGIE-P®

Flügelprofil im Spezialblendrahmen

MINERGIE-P®

Sash profile in special frame

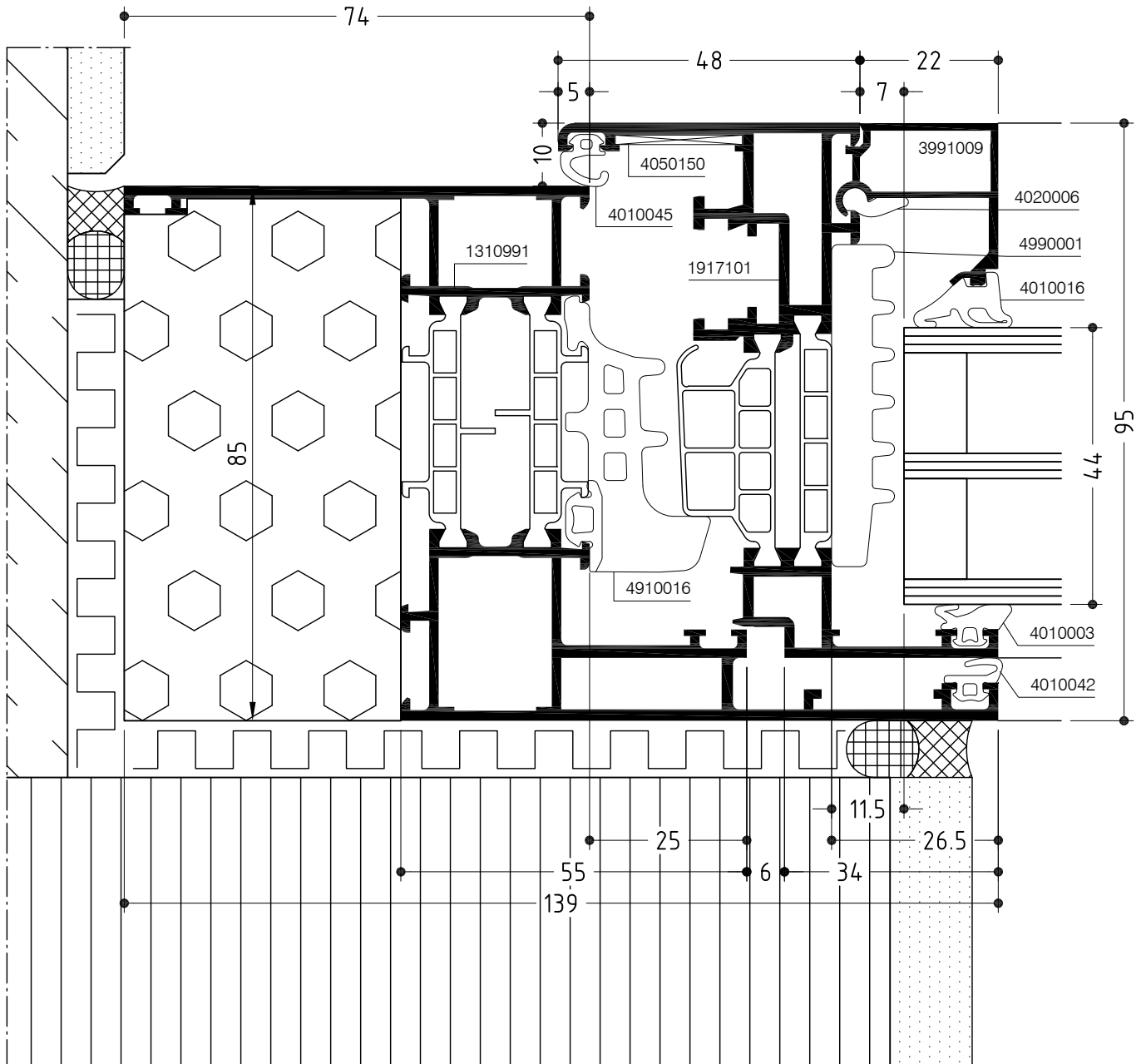

# WICLINE 75

Konstruktionsschnitt

Construction section

MINERGIE-P®

Flügelprofil im Spezialblendrahmen

MINERGIE-P®

Sash profile in special frame

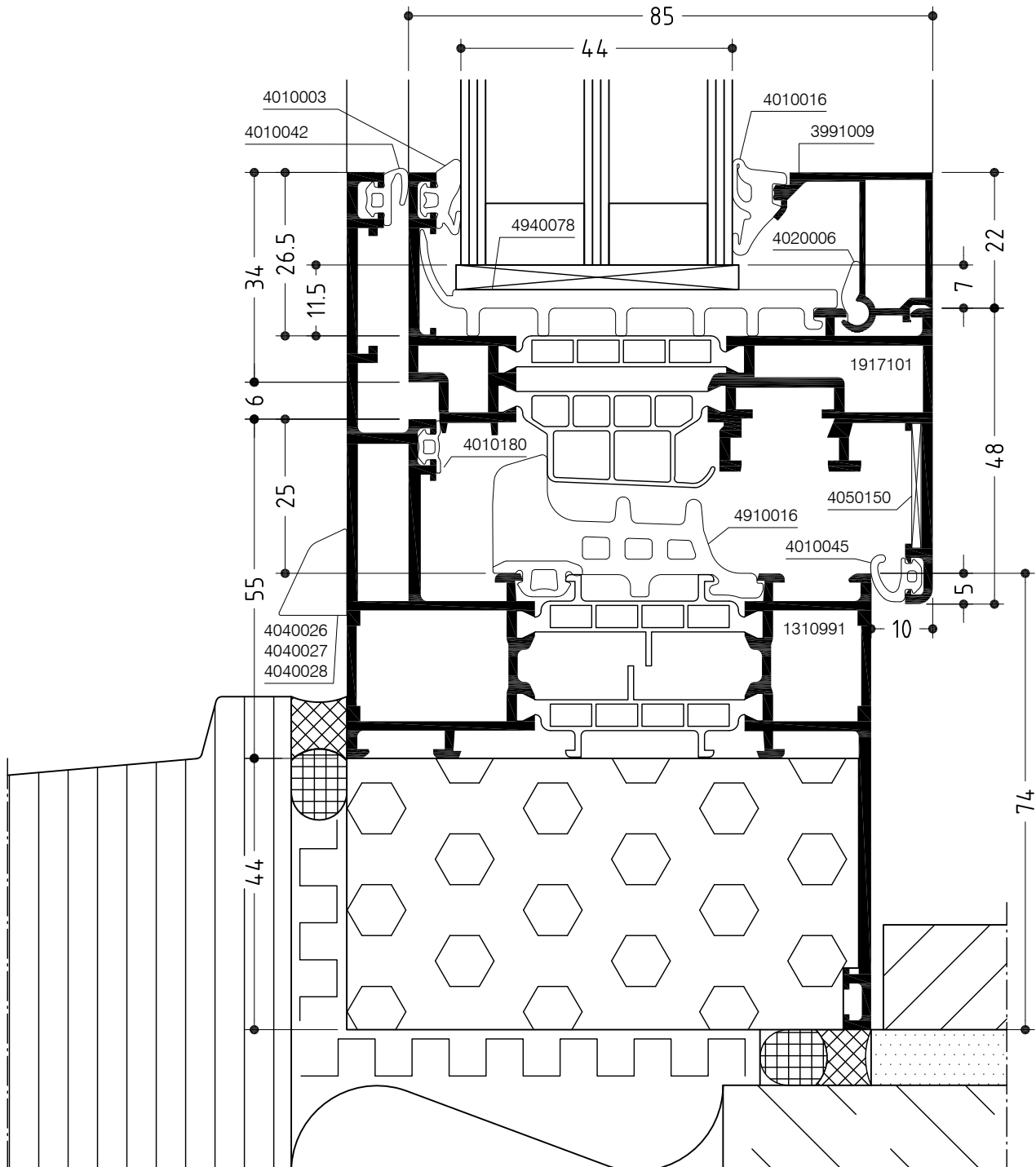

# WICLINE 75

Konstruktionsschnitt  
Construction section

MINERGIE-P®

Stulpfenster - Mittelstoß

MINERGIE-P®

Double casement window - Meeting stiles

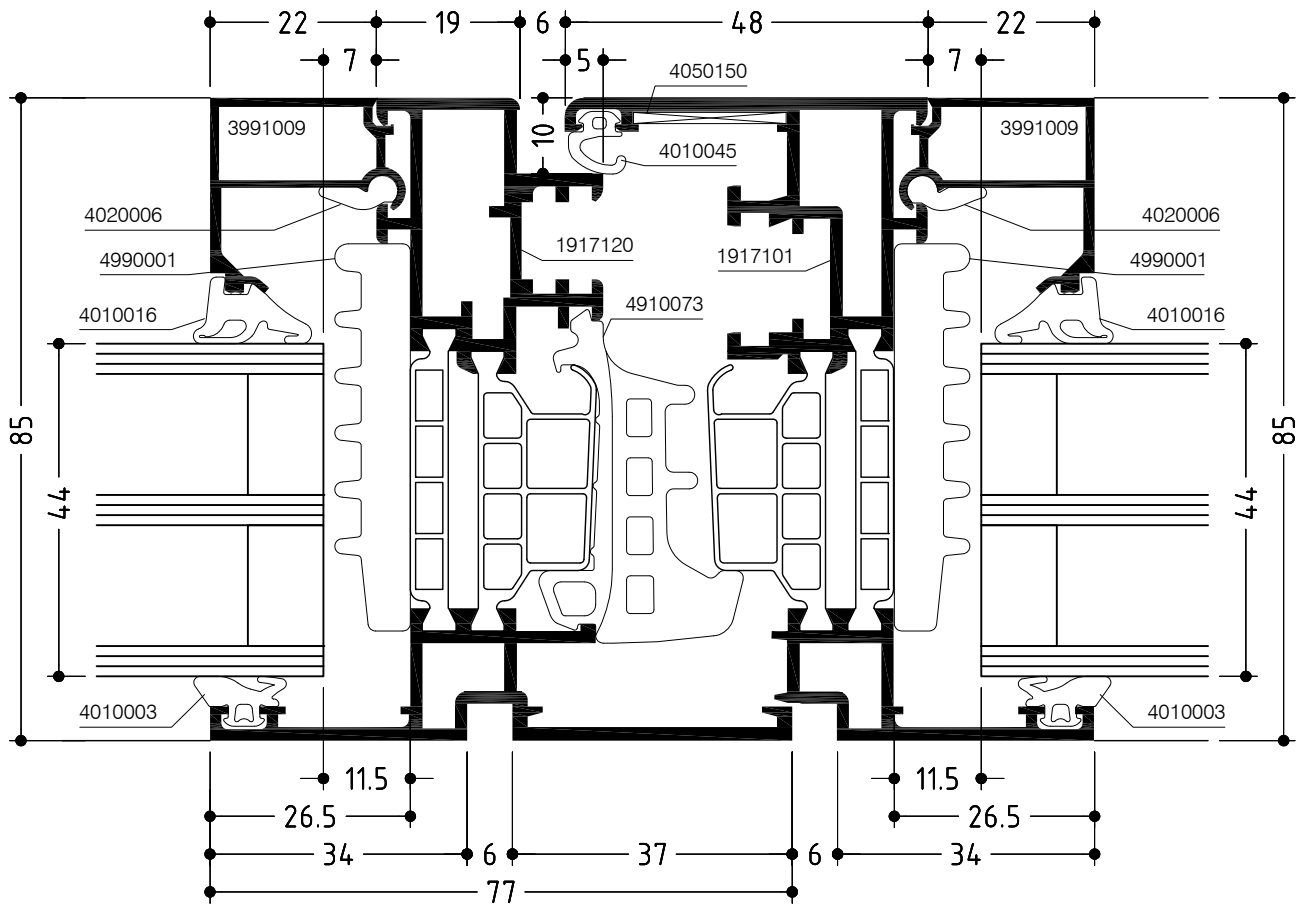
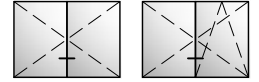



# WICLINE 75

## Konstruktionsschnitt

### Construction section

Zusatzprofil 3091036, 3991215, 3991216 und 3991217

Additional profile 3091036, 3991215, 3991216 and 3991217

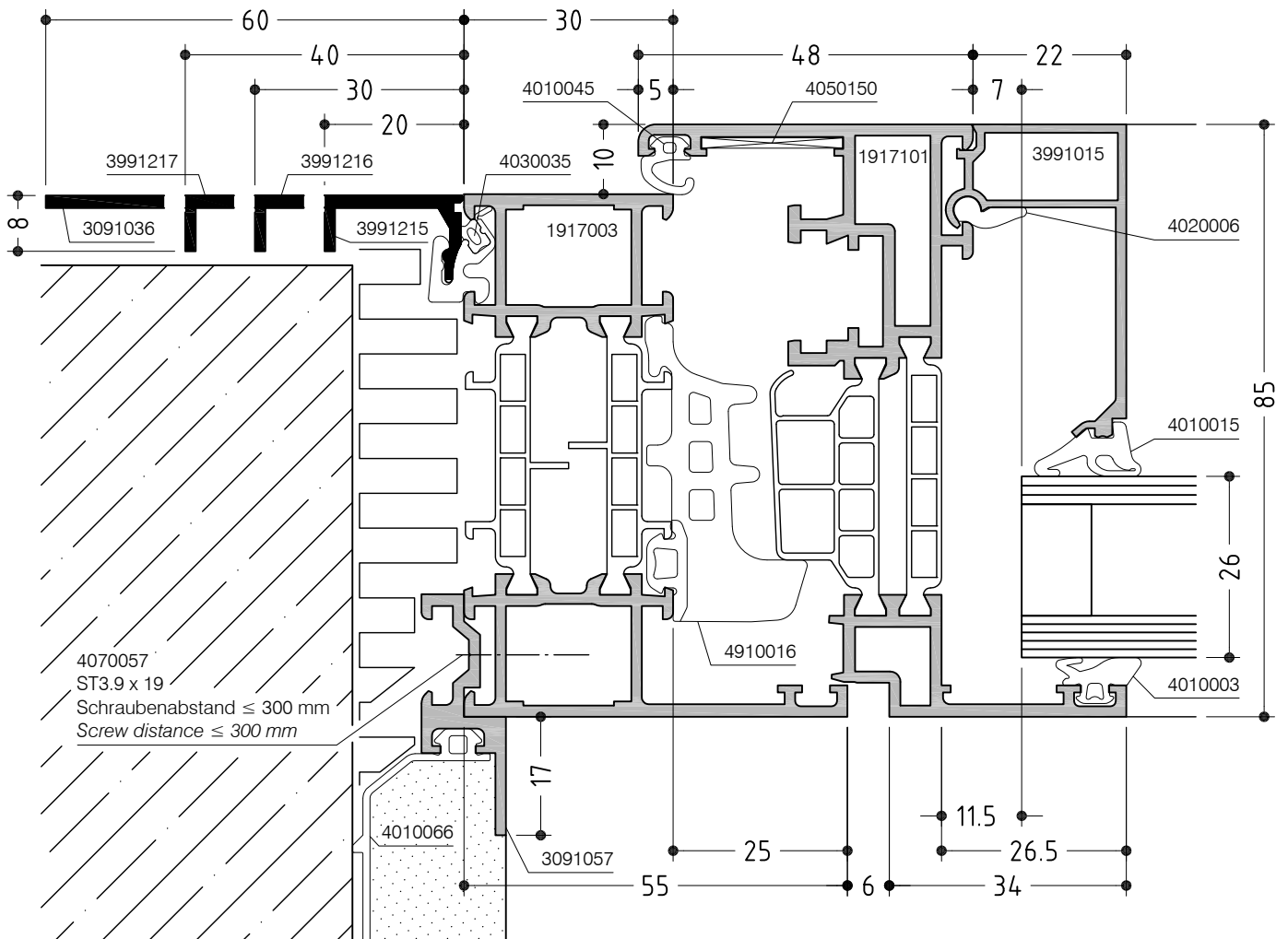

# WICLINE 75

Zusatzprofil 3091031 und 3991234  
Additional profile 3091031 and 3991234

Konstruktionsschnitt  
Construction section

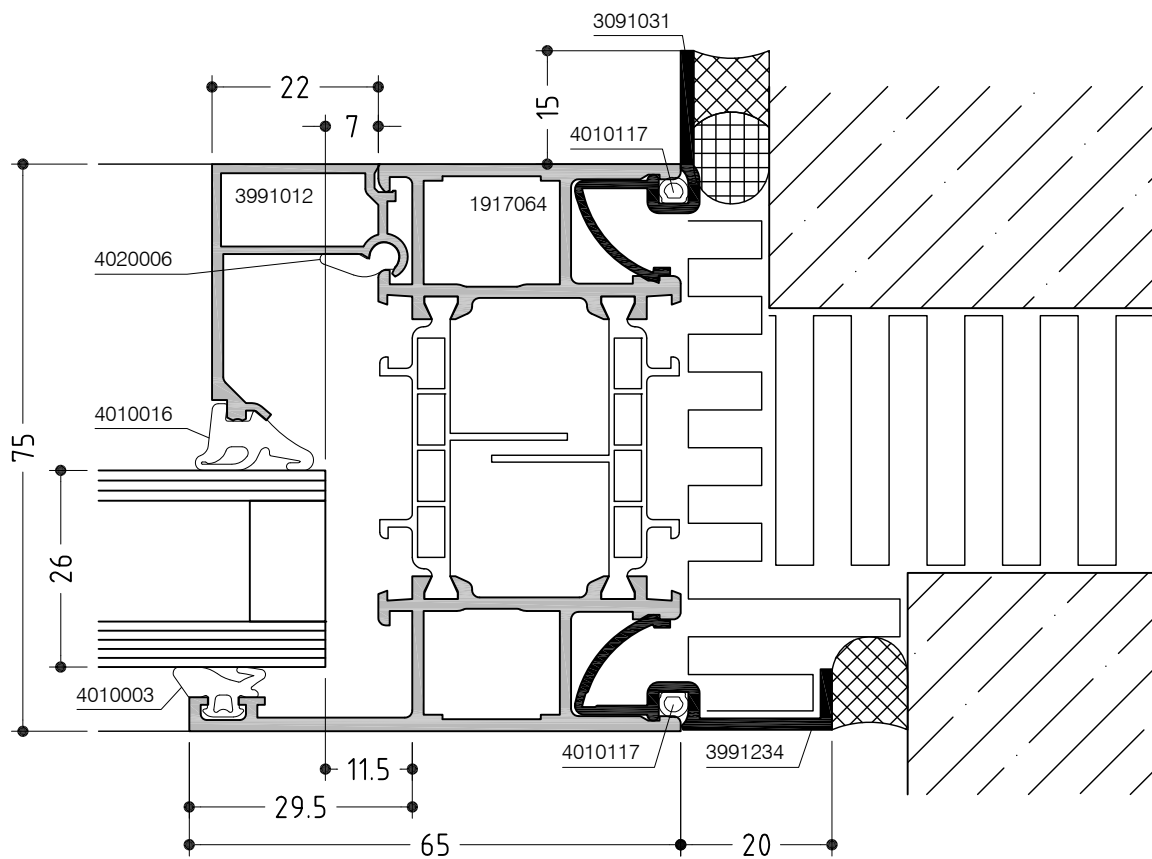

# WICLINE 75

Zusatzprofil 160747 und 3091057  
Additional profile 160747 and 3091057

Konstruktionsschnitt  
Construction section

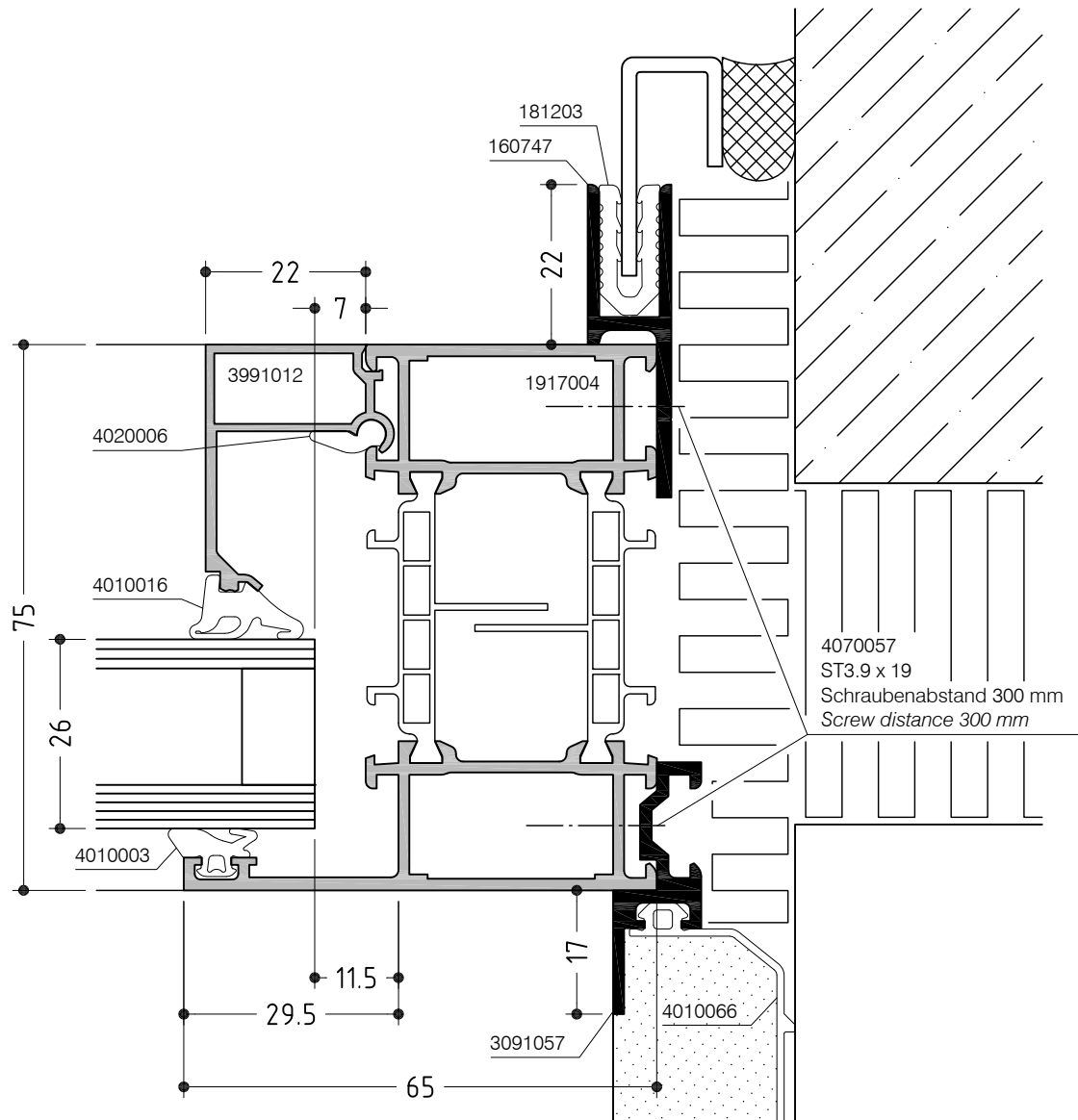

# WICLINE 75

Zusatzprofil 3091055 und 3091057  
Additional profile 3091055 and 3091057

Konstruktionsschnitt  
Construction section

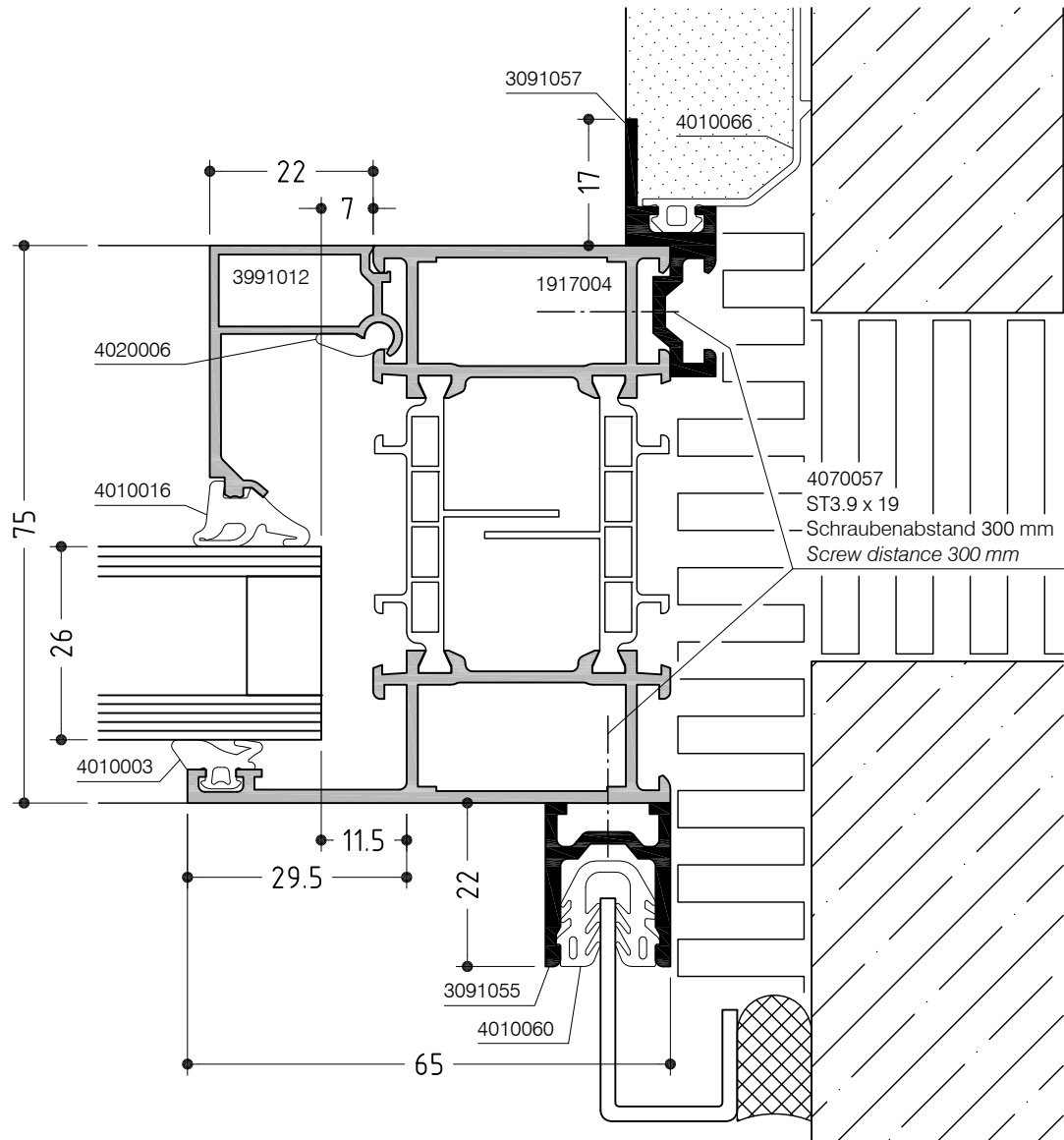



# WICLINE 75

Zusatzprofil 3091037 und 3991280  
 Additional profile 3091037 and 3991280

Konstruktionsschnitt  
 Construction section

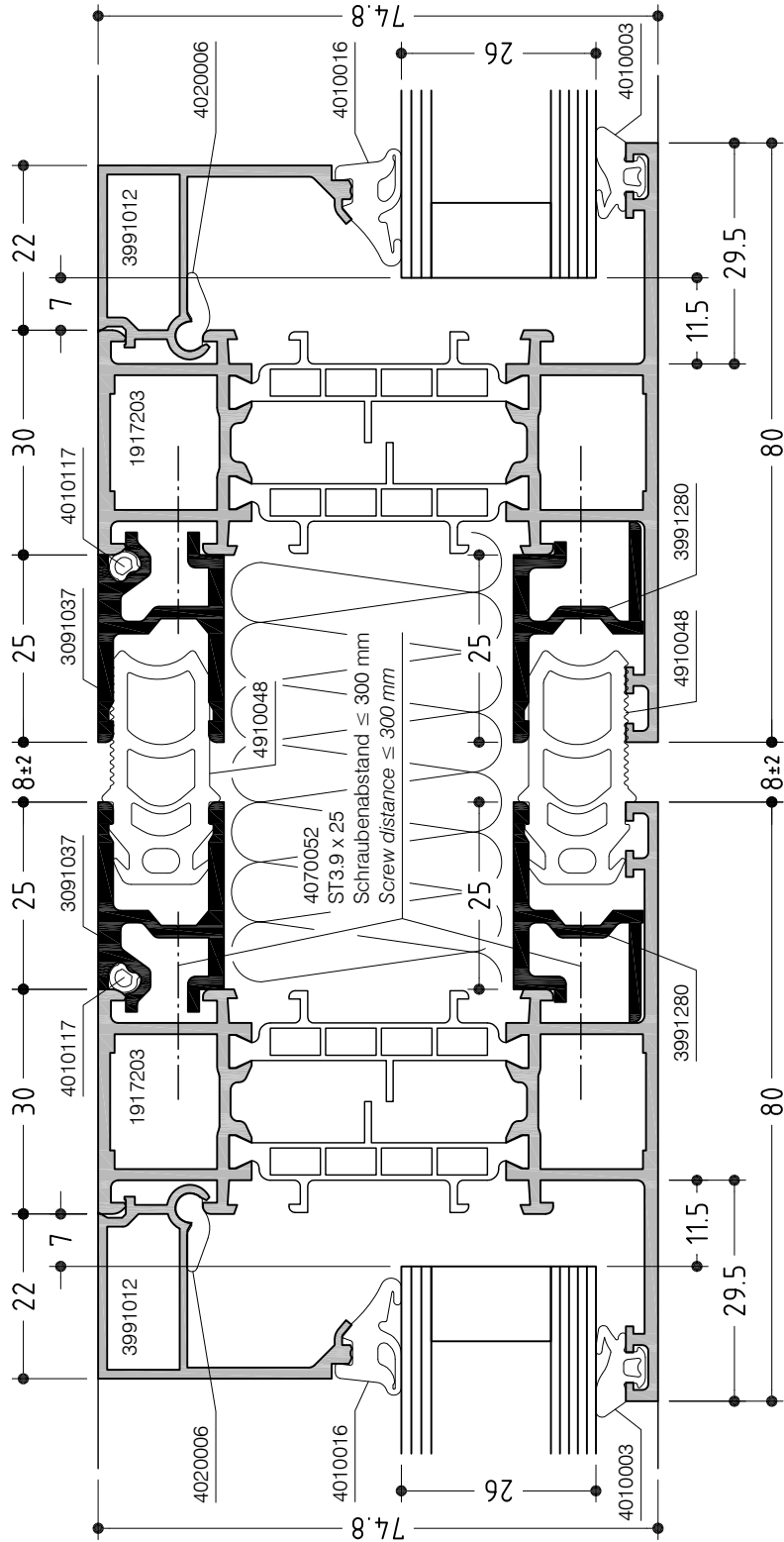
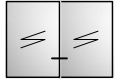



# WICLINE 75

Zusatzprofil 3991237  
Additional profile 3991237

Konstruktionsschnitt  
Construction section

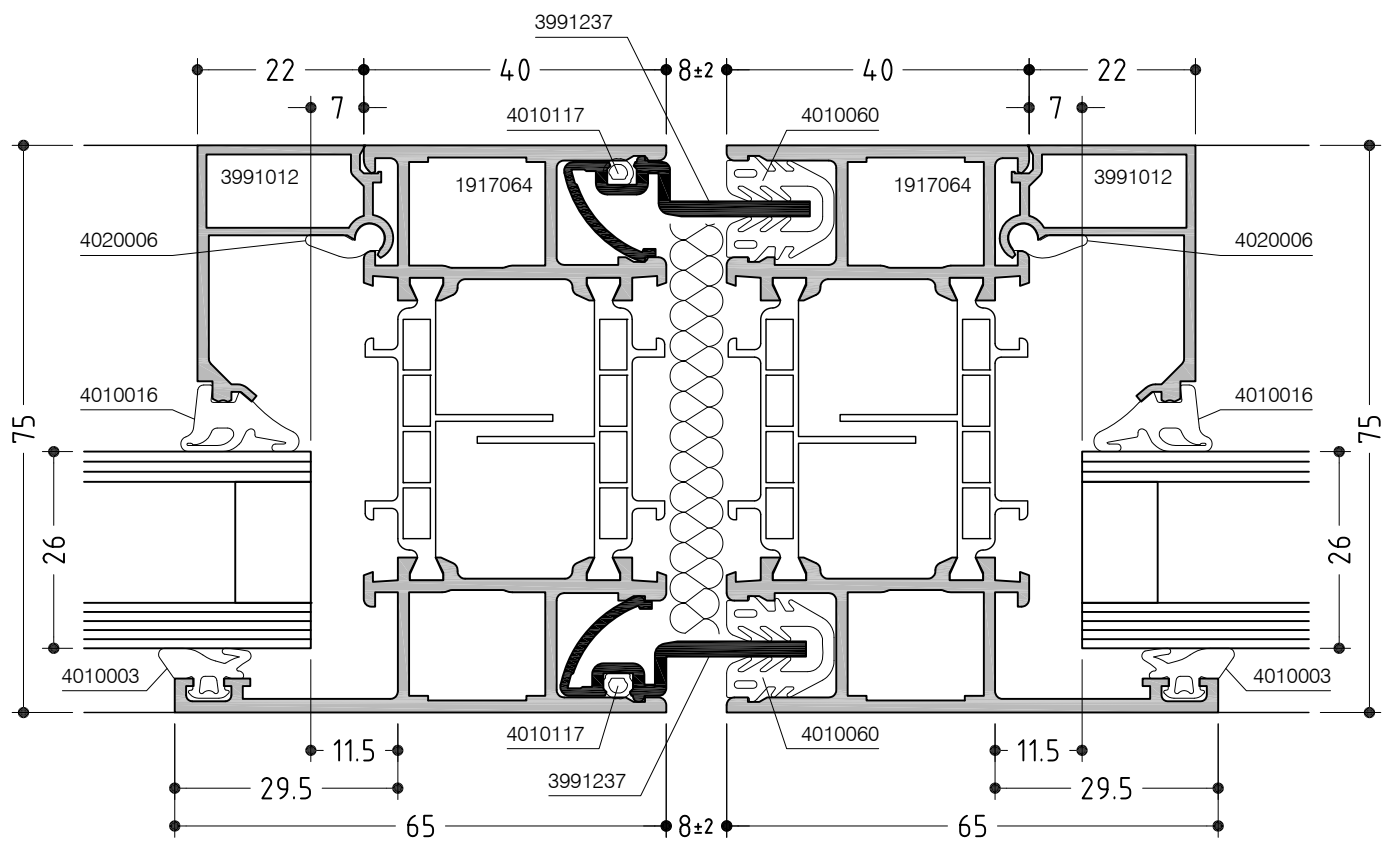
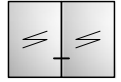

# WICLINE 75

## Konstruktionsschnitt Construction section

Zusatzprofil 3091044 und 3091054  
Verstärkungsprofile Fenstertüren  
Additional profiles 3091044 and 3091054  
Reinforcement profile casement doors

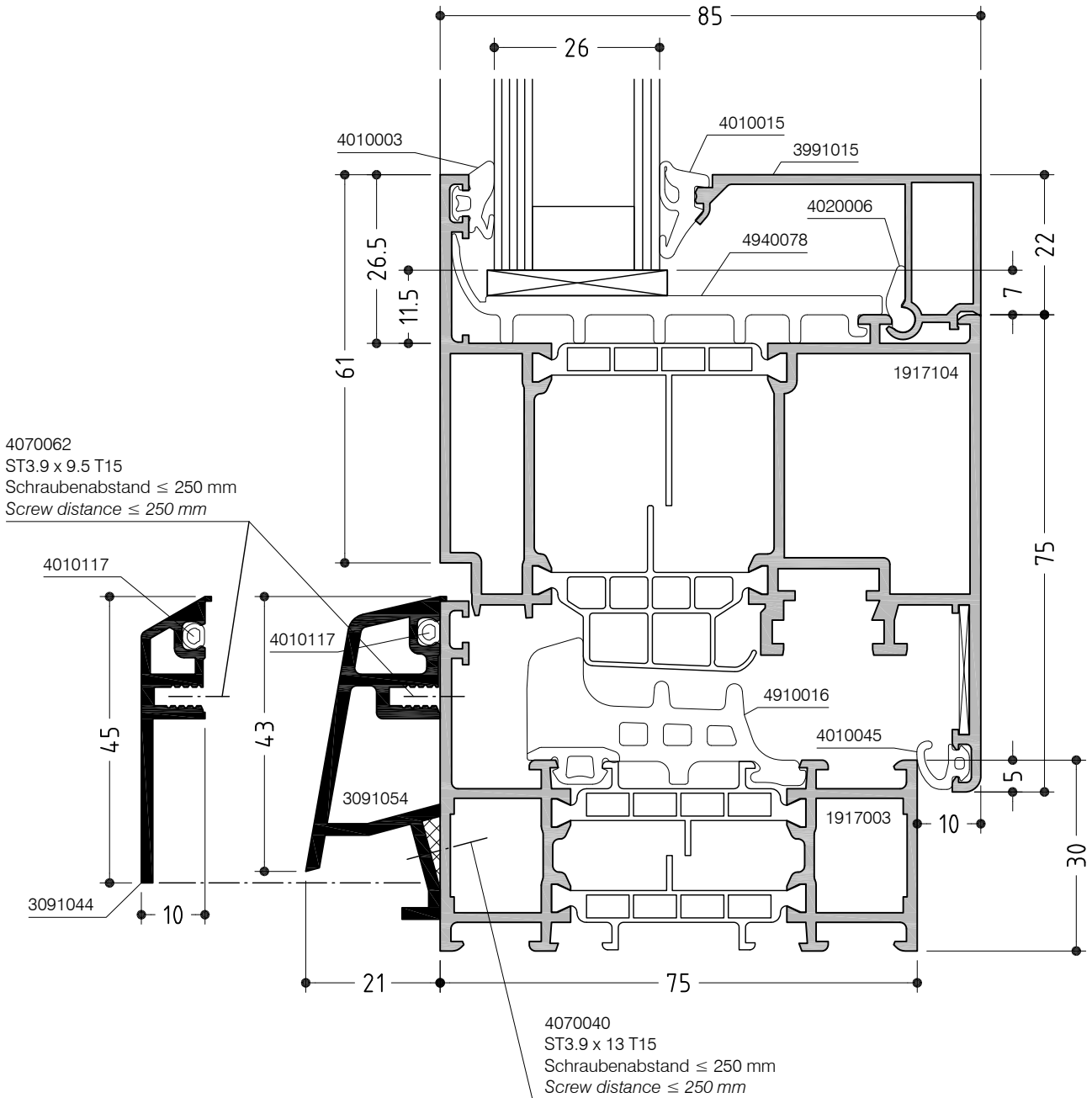

# WICLINE 75

Zusatzprofil 3091045  
Additional profile 3091045

Konstruktionsschnitt  
Construction section

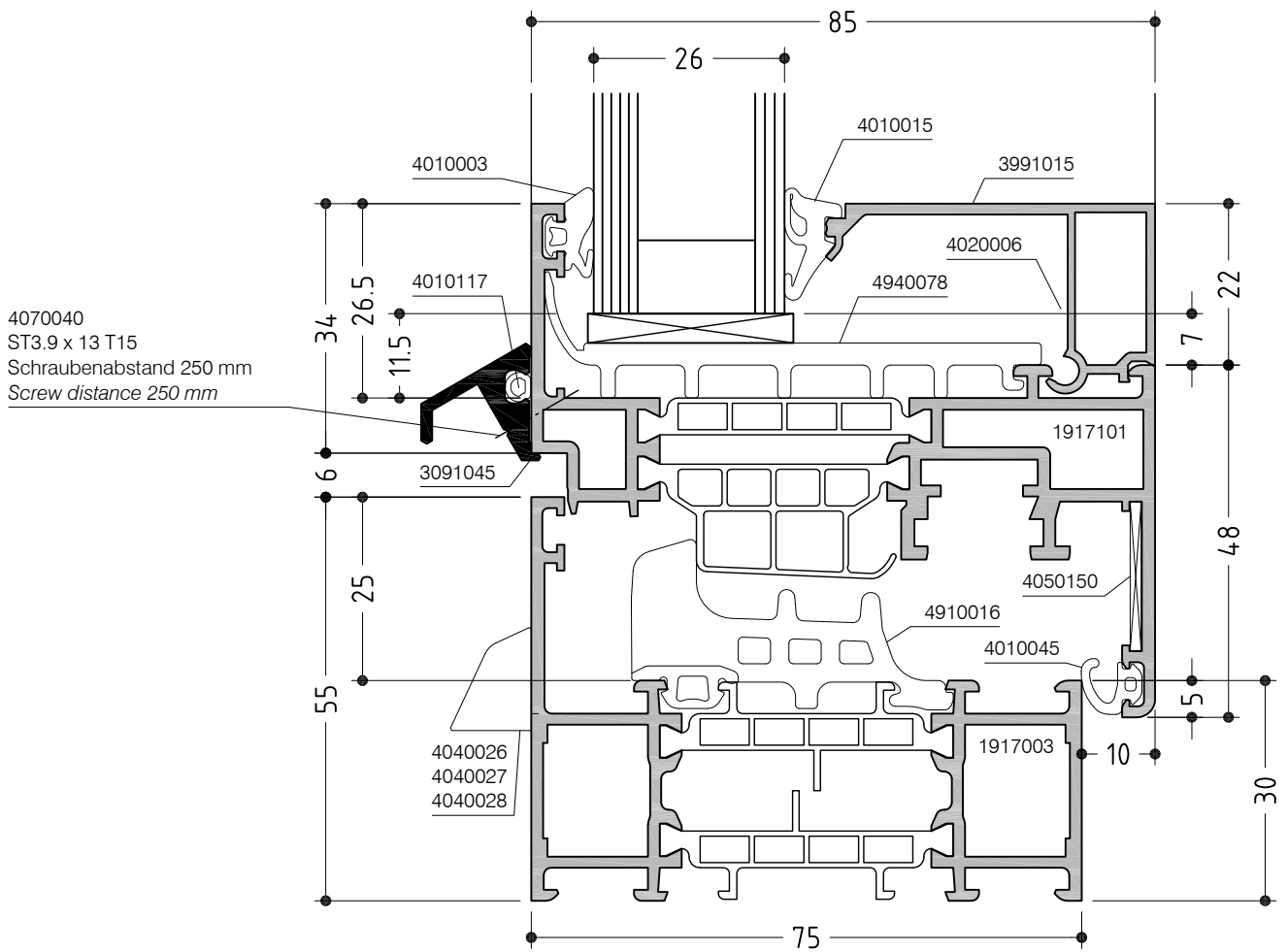

# WICLINE 75

Zusatzprofil 3091039 und 3091040  
Additional profile 3091039 and 3091040

Konstruktionsschnitt  
Construction section

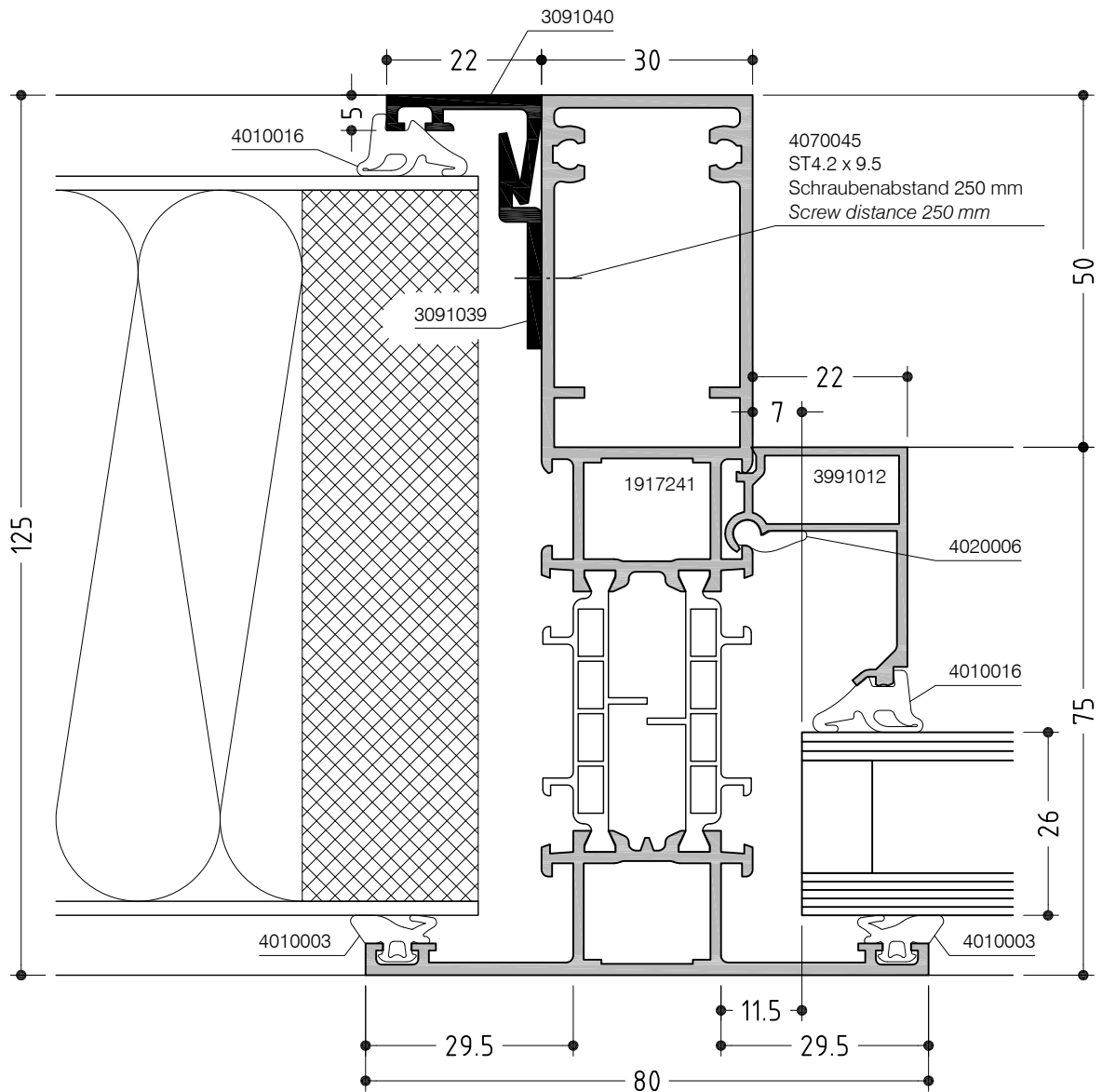
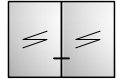

# WICLINE 75

Zusatzprofil 3091049 und 3091050  
Additional profile 3091049 and 3091050

Konstruktionsschnitt  
Construction section

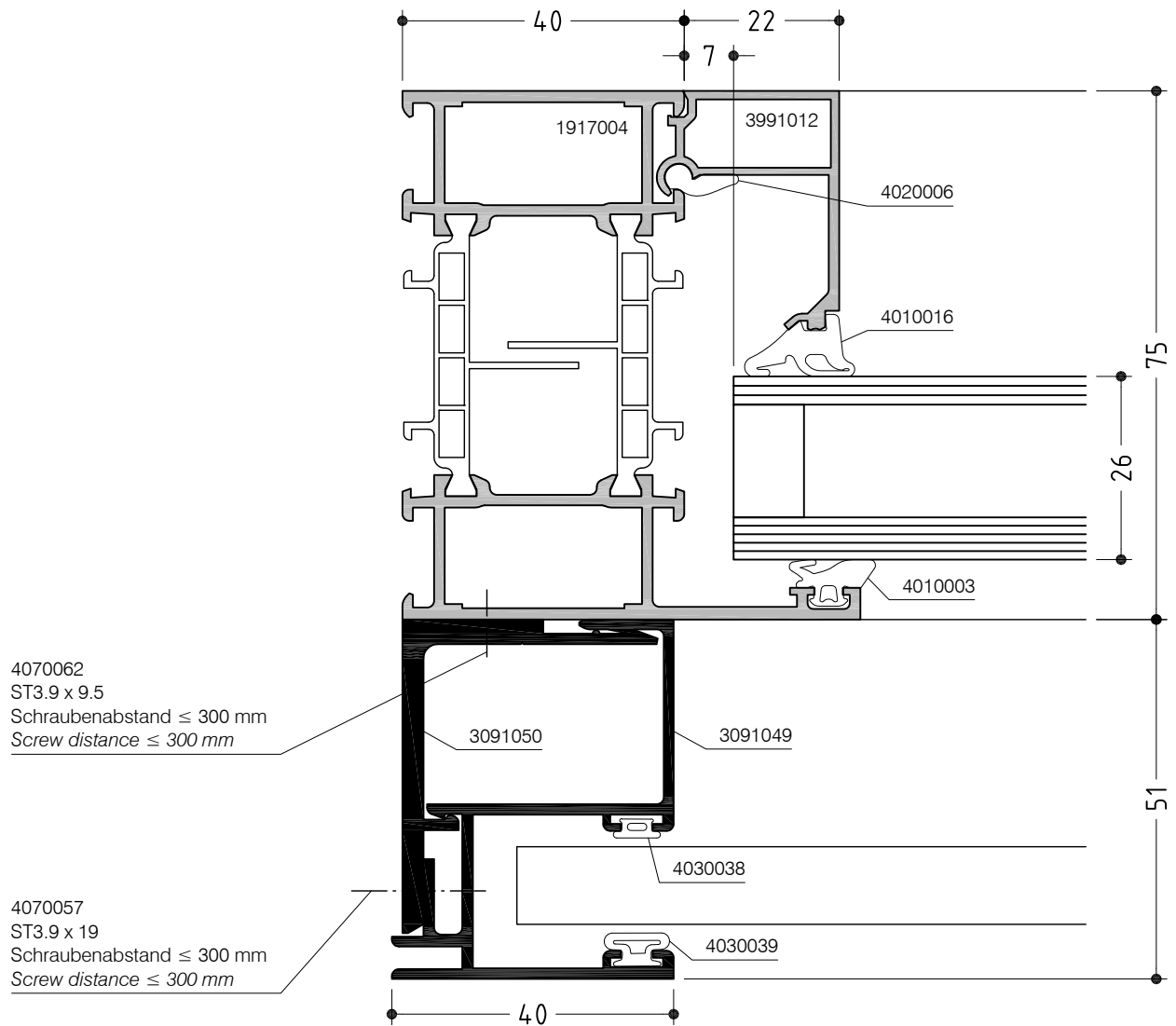

# WICLINE 75

Zusatzprofil 3091048 und 3091051  
Additional profile 3091048 and 3091051

Konstruktionsschnitt  
Construction section

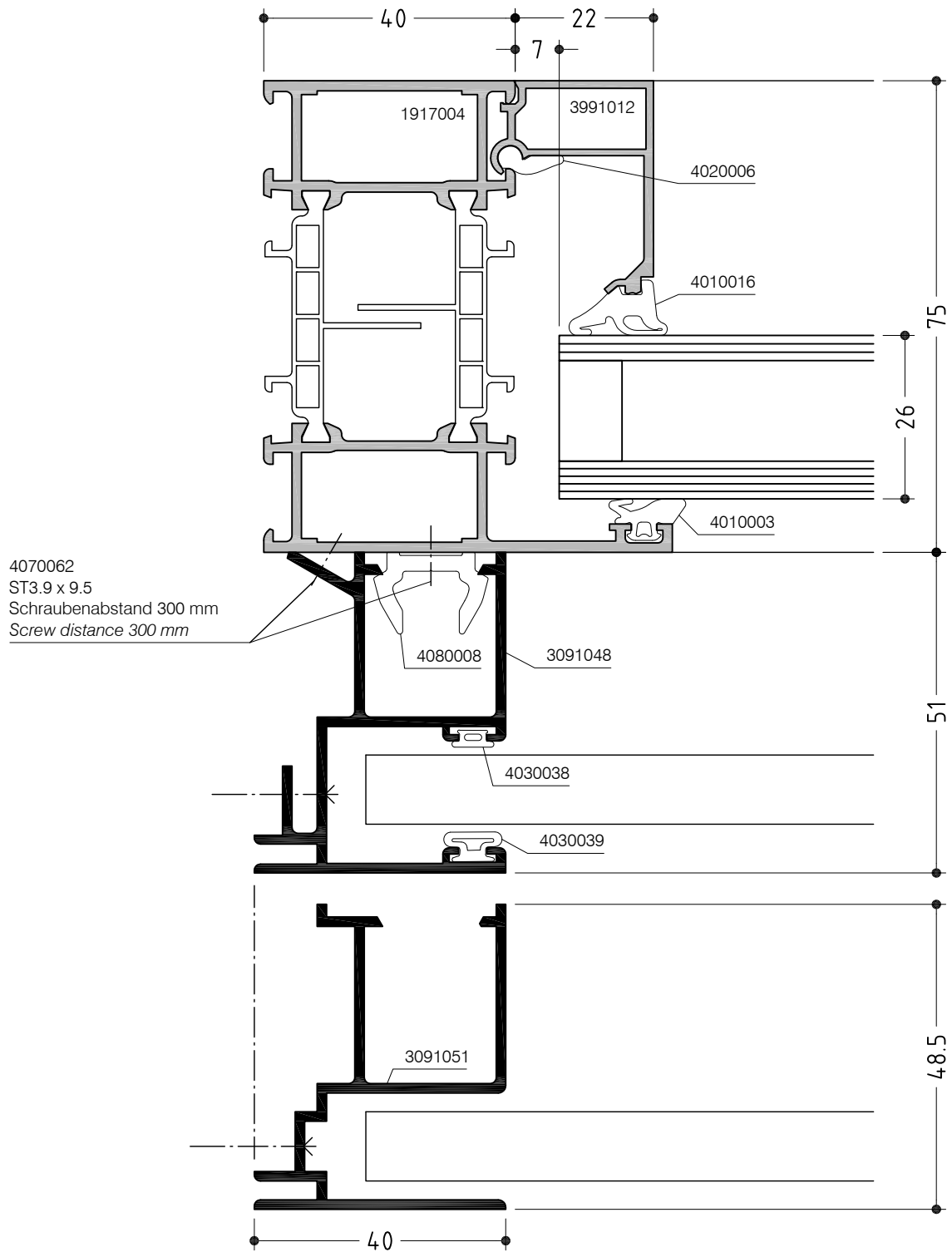



# WICLINE 75

Zusatzprofil 3091046 und 3091047  
Additional profile 3091046 and 3091047

Konstruktionsschnitt  
Construction section

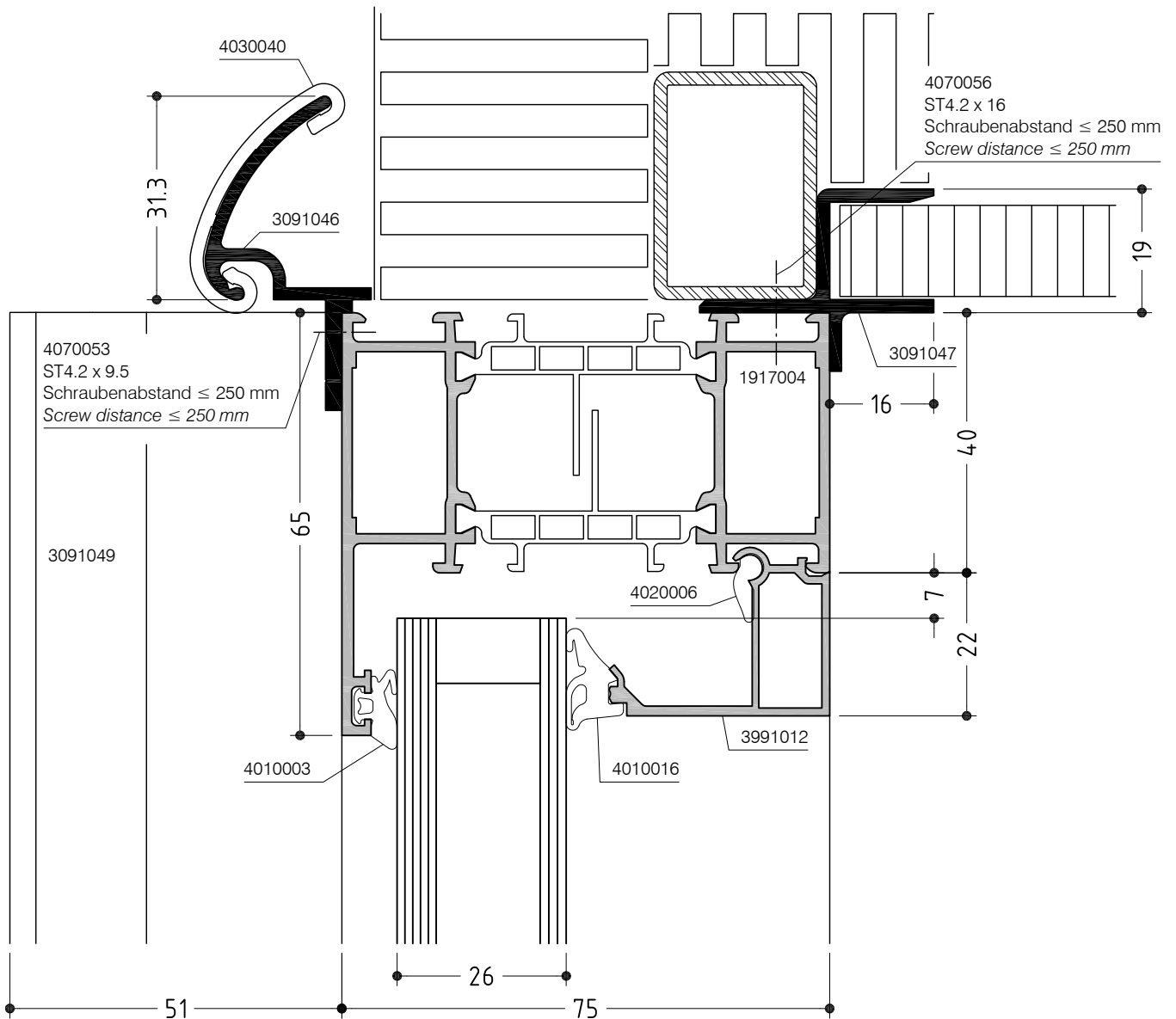

# WICLINE 75

Zusatzprofil 3091058 und 3091059  
Additional profile 3091058 and 3091059

Konstruktionsschnitt  
Construction section

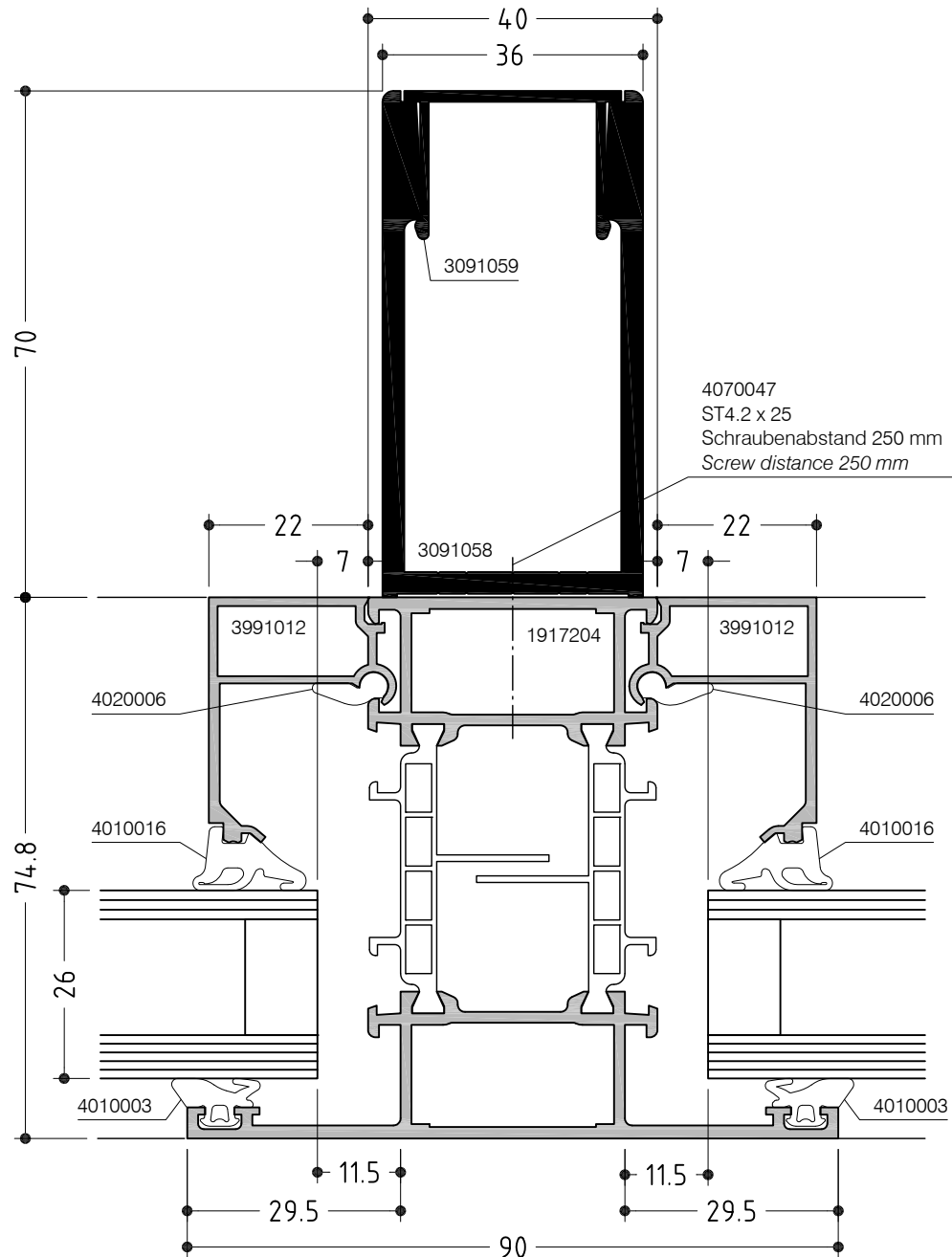
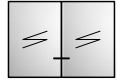



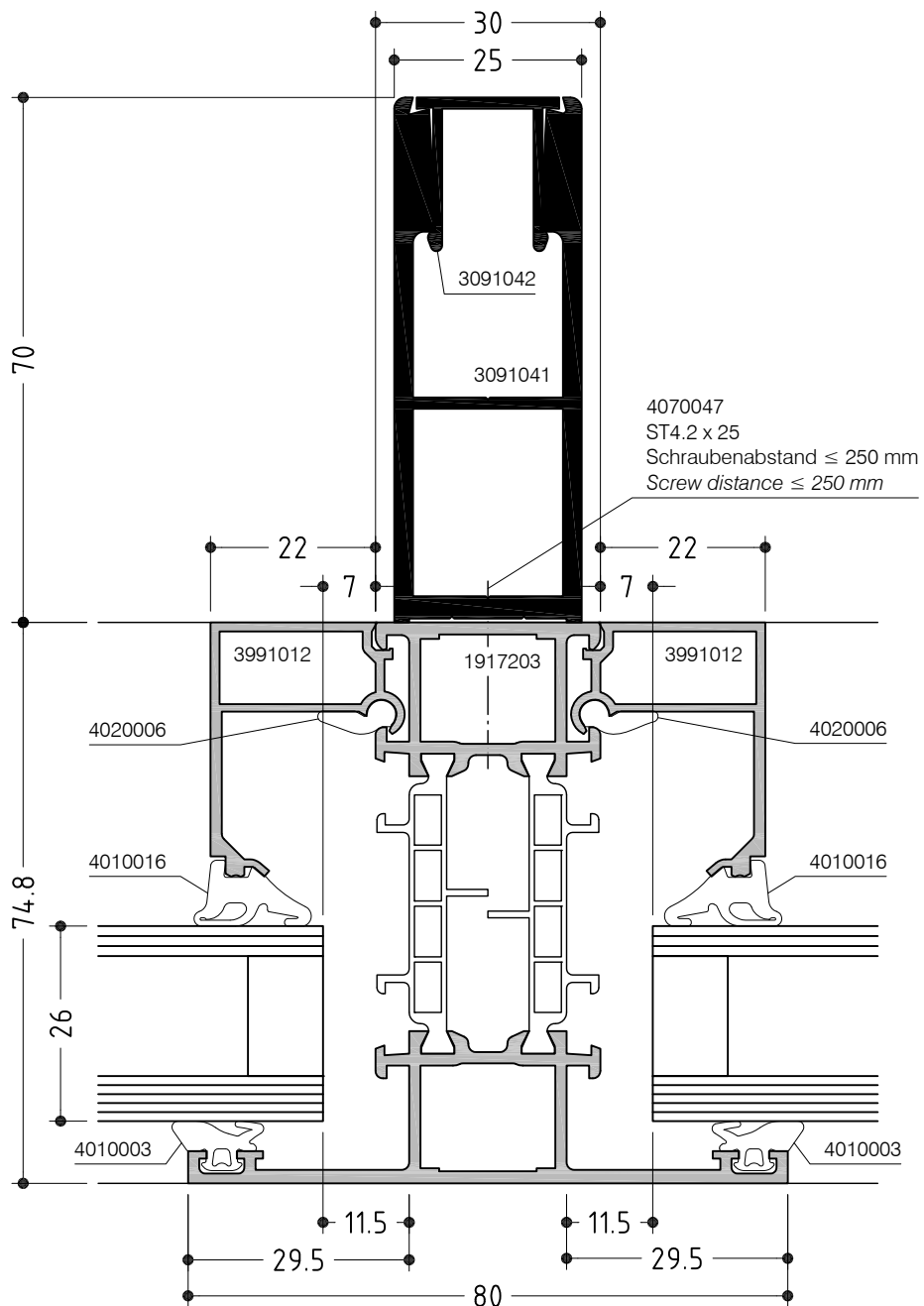
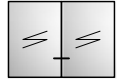

# WICLINE 75

Zusatzprofil 3091041 und 3091042  
Additional profile 3091041 and 3091042

Konstruktionsschnitt  
Construction section

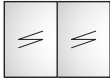









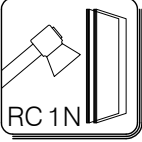

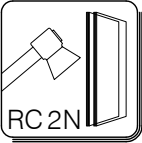

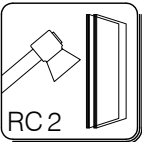
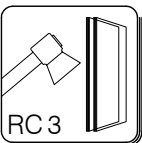































	Seite Page
<b>Symbole</b> <i>Symbols</i>	<b>371</b>
<b>Übersicht der Öffnungsarten</b> <i>Survey of opening types</i>	<b>372</b>
	<b>375</b>
<b>Flügelprofil im Blendrahmen, verdeckter Flügel</b> <i>Concealed sash in frame</i>	
	<b>377</b>
<b>Festverglasung</b> <i>Fixed glazing</i>	
	<b>379</b>
<b>Verdeckte Entwässerung</b> <b>Flügelprofil im Blendrahmen, verdeckter Flügel</b> <i>Concealed drainage</i> <i>Concealed sash in frame</i>	
	<b>380</b>
<b>Verdeckte Entwässerung</b> <b>Festverglasung mit Sprossenprofil</b> <i>Concealed drainage</i> <i>Fixed glazing with glazing bar profile</i>	
	<b>381</b>
<b>Flügelprofil im Einspannblendrahmen</b> <i>Sash profile in clamping frame</i>	



Symbole  
Symbols

















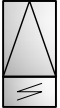

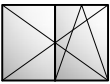
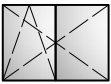
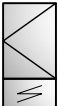
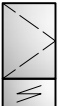
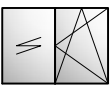
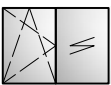

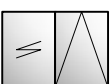
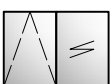

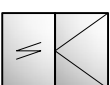
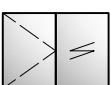

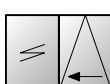
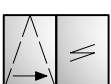
Symbol	Bezeichnung	Symbol	Bezeichnung
Symbols	Designation	Symbols	Designation
	Einbruchhemmung RC 1 N nach DIN EN 1627:2011  <i>Burglary resistance RC 1 N according to DIN EN 1627:2011</i>		barrierefrei  <i>barrier-free</i>
	Einbruchhemmung RC 2 N nach DIN EN 1627:2011  <i>Burglary resistance RC 2 N according to DIN EN 1627:2011</i>		Darstellung 90° gedreht  <i>Representation turned by 90°</i>
	Einbruchhemmung RC 2 nach DIN EN 1627:2011  <i>Burglary resistance RC 2 according to DIN EN 1627:2011</i>		
	Einbruchhemmung RC 3 nach DIN EN 1627:2011  <i>Burglary resistance RC 3 according to DIN EN 1627:2011</i>		
	Durchschusshemmung nach EN 1522  <i>Bullet resistance according to EN 1522</i>		

### Öffnungsarten Opening types

Ansicht von Innen <i>Inner view</i>	Bezeichnung <i>Designation</i>	Ansicht von Außen <i>Outer view</i>	Ansicht von Innen <i>Inner view</i>	Bezeichnung <i>Designation</i>	Ansicht von Außen <i>Outer view</i>
	Festverglasung <i>Fixed glazing</i>			Senk - Klapp - Fenster <i>Italian style window</i>	
	Photovoltaik <i>Photovoltaic</i>			Klapp - Fenster <i>Top-hung window</i>	
	Kipp - Fenster <i>Tilt window</i>			Schwing - Fenster <i>Horizontal pivot window</i>	
	Dreh - Fenster <i>Turn window</i>			Wende - Fenster <i>Vertical pivot window</i>	
	Drehkipp - Fenster <i>Turn/tilt window</i>			Parallel - Ausstellfenster <i>Parallel opening window</i>	
	Festverglasung mit Oberlicht <i>Fixed glazing with fanlight</i>			Rundbogen - Festverglasung <i>Semi-circular arch fixed glazing</i>	
	Drehkipp - Fenster mit Oberlicht <i>Turn/tilt window with fanlight</i>			Schräg - Festverglasung <i>Sloped fixed glazing</i>	
	Festverglasung mit Oberlicht Kippflügel <i>Fixed glazing with fanlight window fanlight</i>			Rundbogen - Drehkipp - Fenster <i>Semi-circular arch turn/tilt window</i>	
	Drehkipp - Fenster mit Oberlicht Kippfenster <i>Turn/tilt window with tilt window fanlight</i>			Schräg - Drehkipp - Fenster <i>Sloped turn/tilt window</i>	

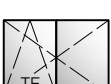

### Öffnungsarten Opening types

Ansicht von Innen <i>Inner view</i>	Bezeichnung <i>Designation</i>	Ansicht von Außen <i>Outer view</i>	Ansicht von Innen <i>Inner view</i>	Bezeichnung <i>Designation</i>	Ansicht von Außen <i>Outer view</i>
	Stichbogen - Drehkipp - Fenster <i>Segmental arch turn/tilt window</i>			Drehkipp - Fenster; Tilt-First Ausführung <i>Turn/tilt window. Type: Tilt-First</i>	
	Segment - Drehkipp - Fenster <i>Segmental turn/tilt window</i>			Kipp - Fenster mit Unterlicht <i>Tilt window with sublight</i>	
	Stulp - Fenster oder 2 - flügeliges Fenster mit Kämpfer <i>Double casement window or double sash window with transom</i>			Dreh - Fenster mit Unterlicht <i>Turn window with sublight</i>	
	Drehkipp - Fenster mit Festverglasung <i>Turn/tilt window with fixed glazing</i>			Drehkipp - Fenster mit Unterlicht <i>Turn/tilt window with sublight</i>	
	Kipp - Fenster mit Festverglasung <i>Tilt window with fixed glazing</i>			Festverglasung mit Sprosse <i>Fixed glazing with glazing bars</i>	
	Dreh - Fenster mit Festverglasung <i>Turn window with fixed glazing</i>			Kippfenster - Sprossenfenster <i>Tilt window with glazing bars</i>	
	Parallel - Schiebe - Kipp - Fenster <i>Parallel sliding tilt window</i>			Drehfenster - Sprossenfenster <i>Turn window with glazing bars</i>	
	Stulp - Fenster oder 2 - flügeliges Fenster mit Kämpfer <i>Double casement window or double sash window with transom</i>			Drehkipp - Sprossenfenster <i>Turn/tilt window with glazing bars</i>	
	Stulp - Fenster oder 2 - flügeliges Fenster mit Kämpfer; Tilt-First Ausführung <i>Double casement window or double sash window with transom. Type: Tilt-First</i>			Fenstertür, barrierefrei <i>Casement door, accessible</i>	



# WICLINE 95

## Konstruktionsschnitt

### Construction section

Flügelprofil im Blendrahmen, verdeckter Flügel

Concealed sash in frame

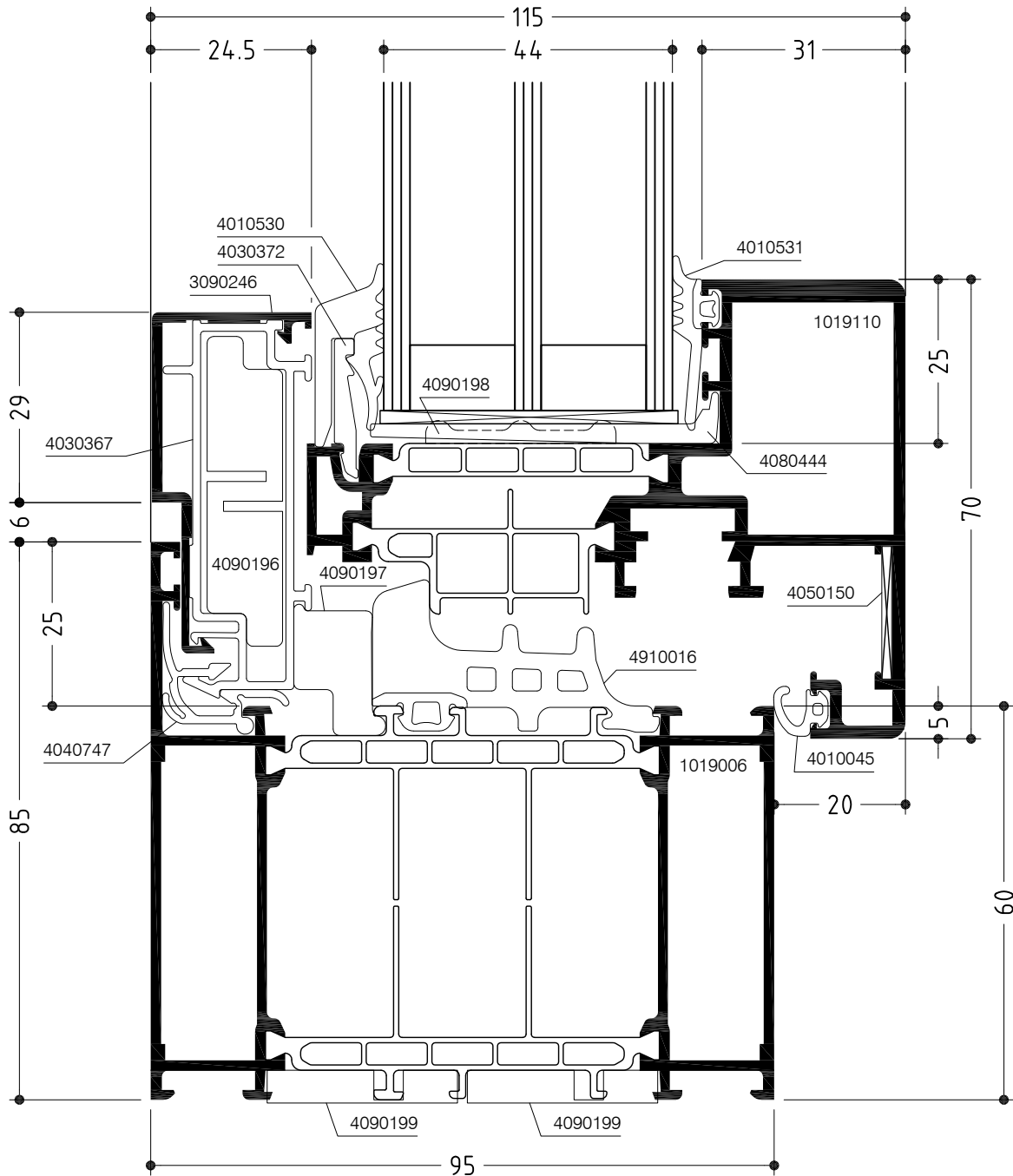

# WICLINE 95

Flügelprofil im Blendrahmen, verdeckter Flügel  
Concealed sash in frame

Konstruktionsschnitt  
Construction section

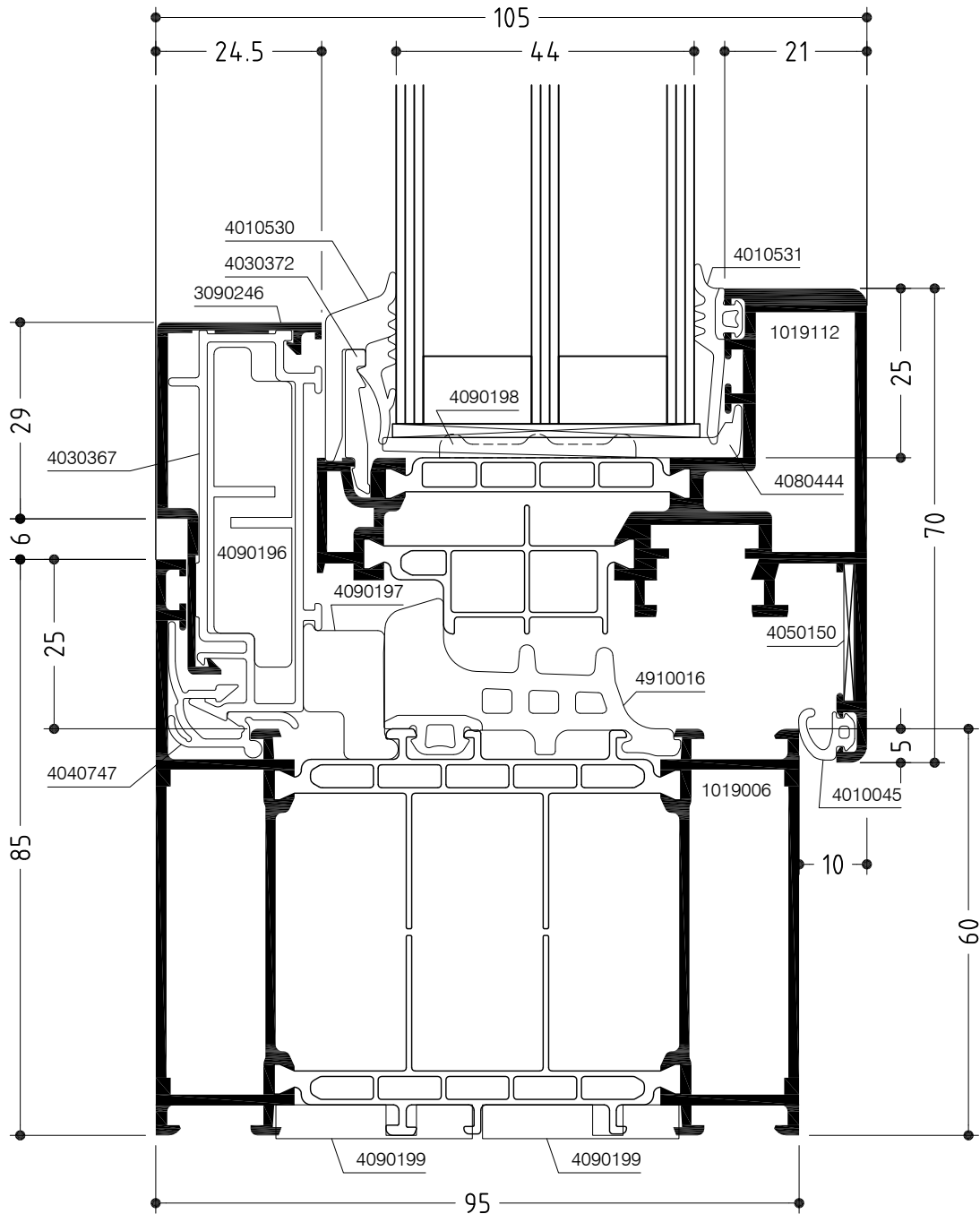

# WICLINE 95

Festverglasung  
Fixed glazing

Konstruktionsschnitt  
Construction section

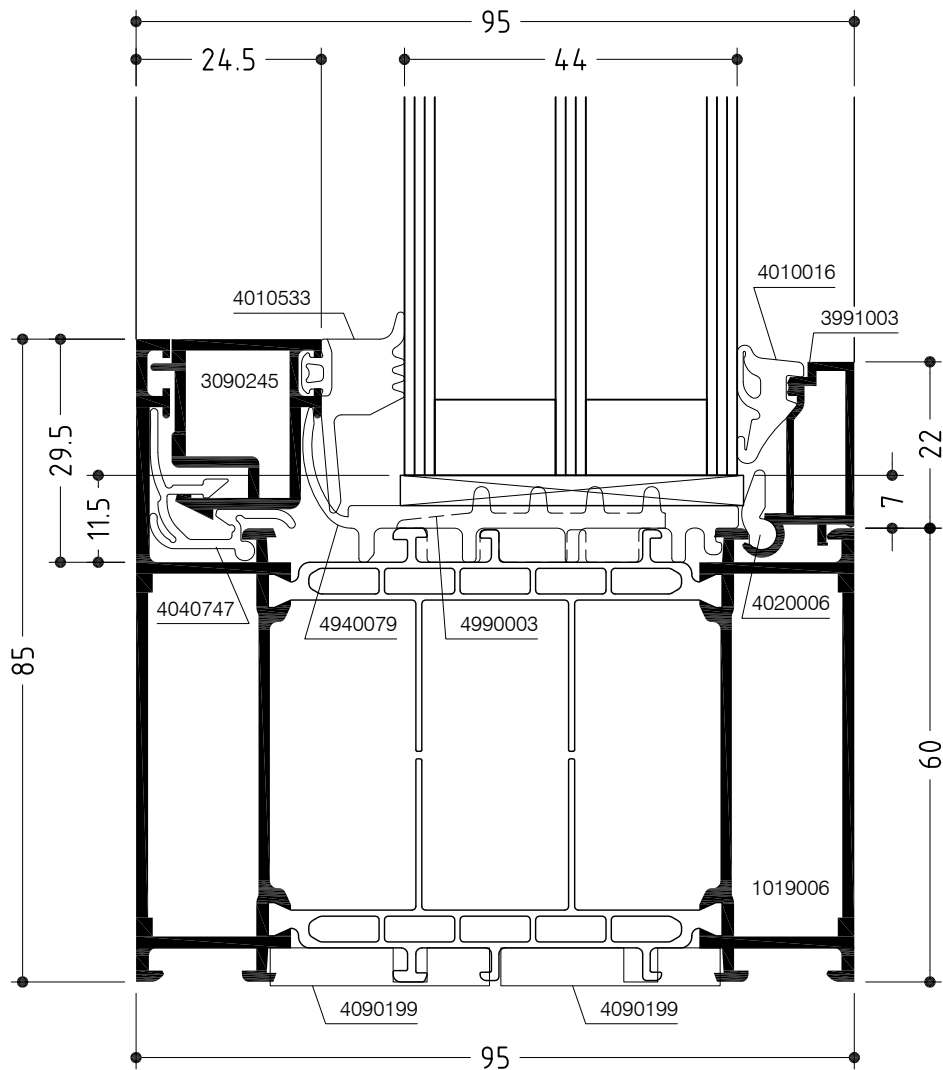

# WICLINE 95

Festverglasung  
Fixed glazing

Konstruktionsschnitt  
Construction section

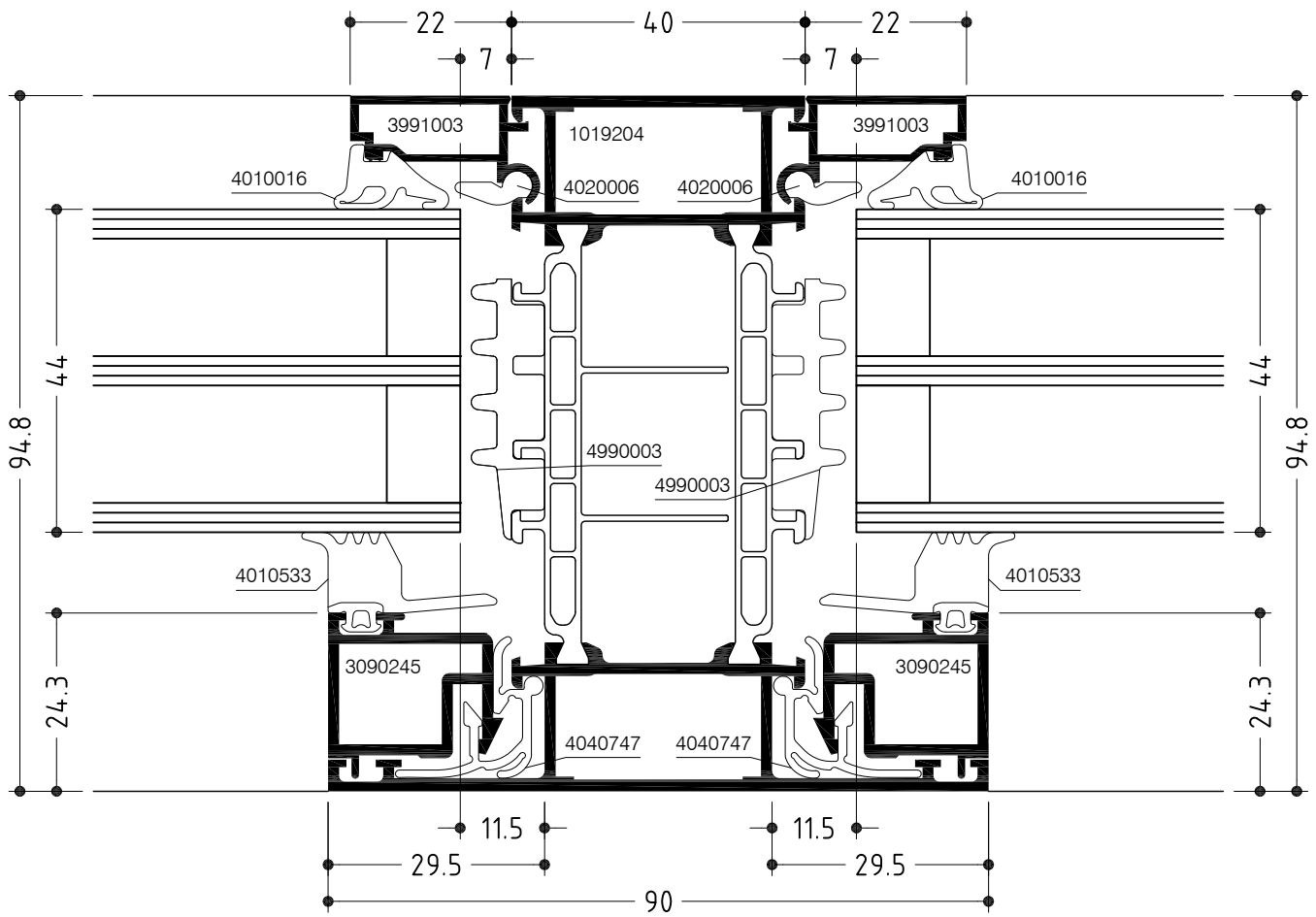
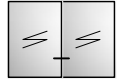

# WICLINE 95

Konstruktionsschnitt  
Construction section

Verdeckte Entwässerung  
Flügelprofil im Blendrahmen, verdeckter Flügel  
Concealed drainage  
Concealed sash in frame

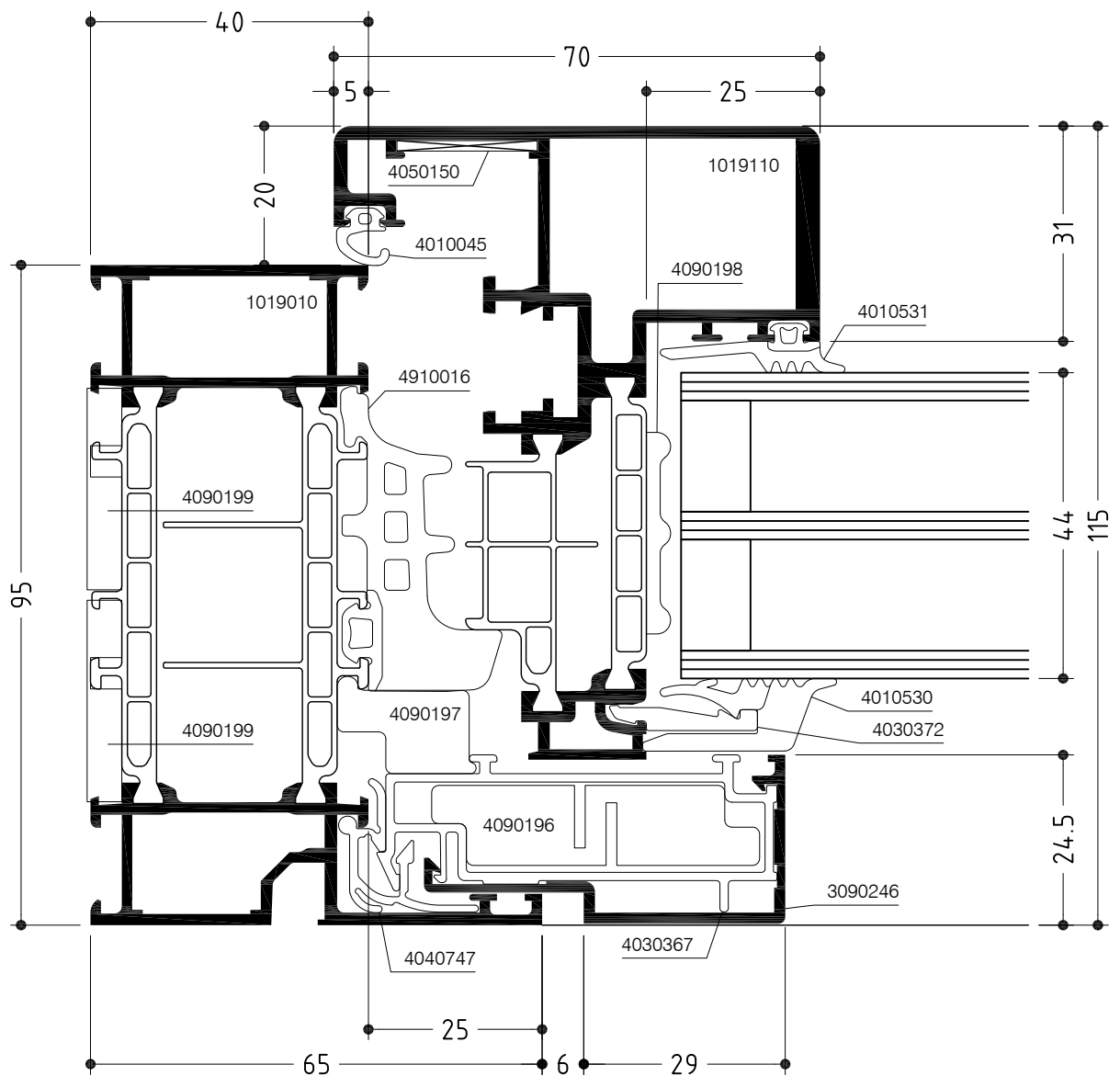

# WICLINE 95

Konstruktionsschnitt

Construction section

Verdeckte Entwässerung, Festverglasung mit Sprossenprofil

Concealed drainage, fixed glazing with glazing bar profile

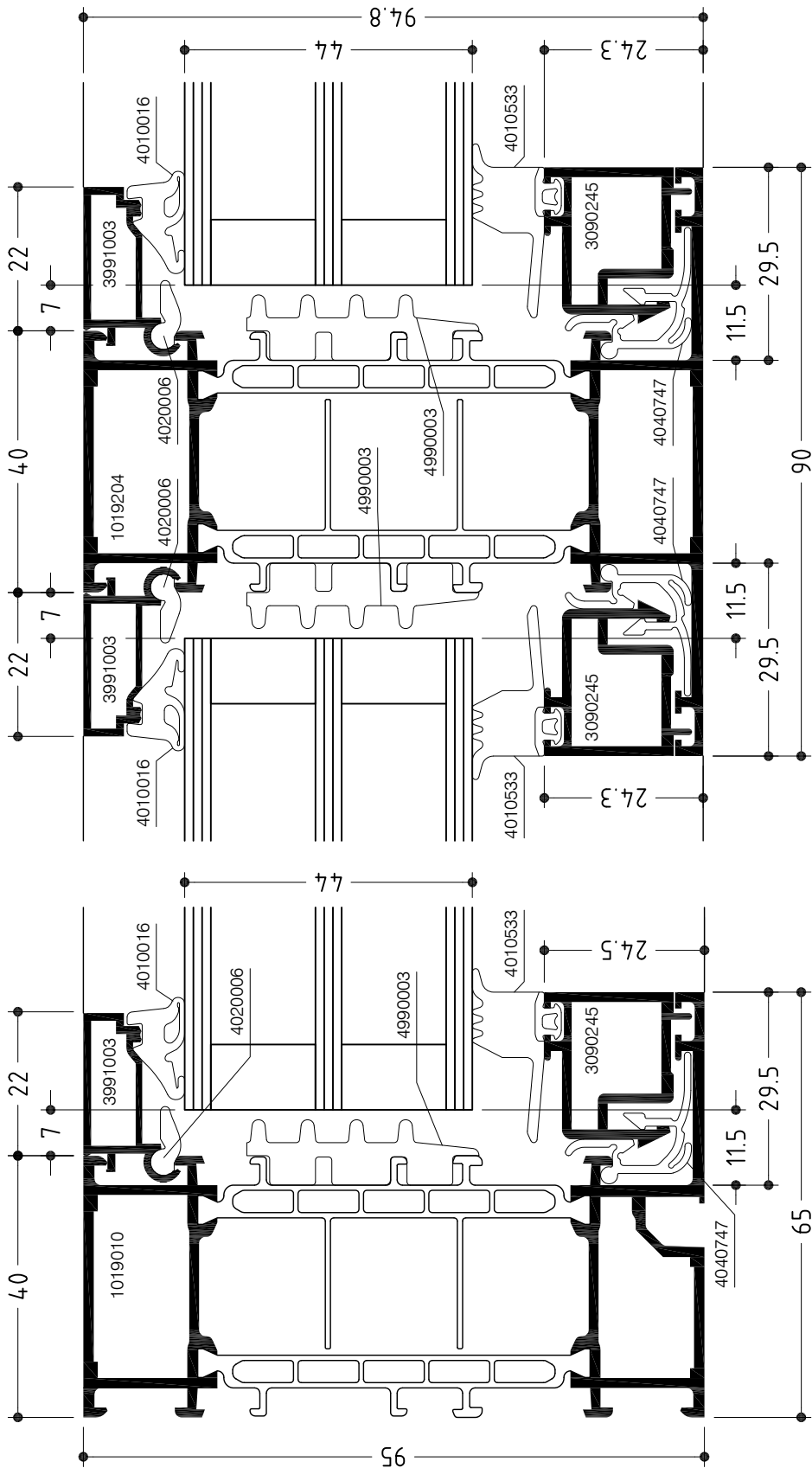



# WICLINE 95

Flügelprofil im Einspannblendrahmen  
Sash profile in clamping frame

Konstruktionsschnitt  
Construction section

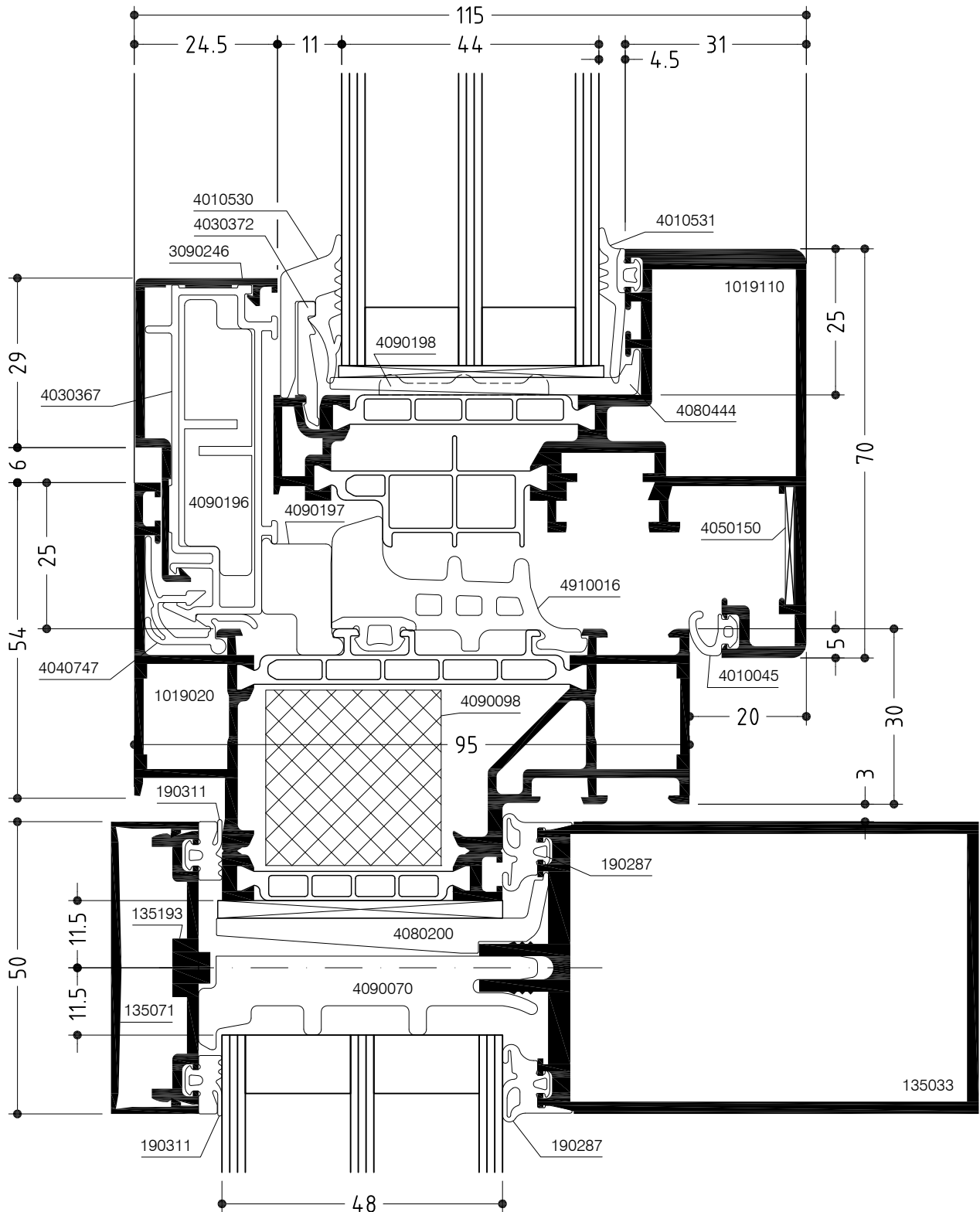

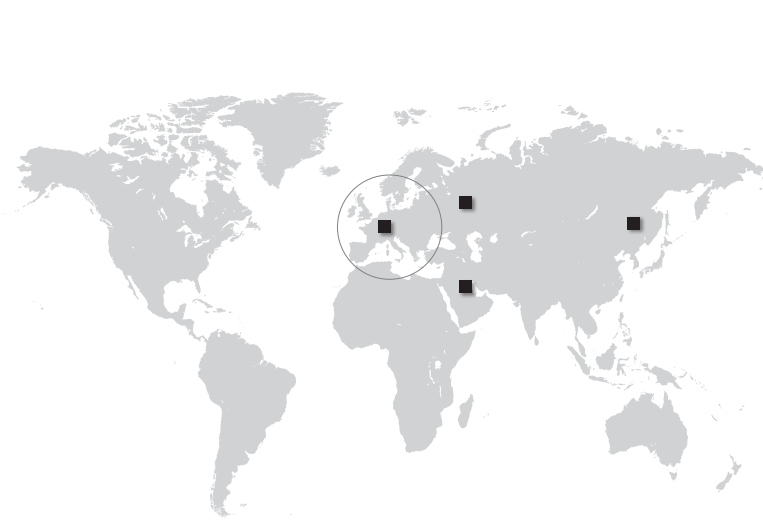
**Austria**

5201 Seekirchen  
☎ +43 6212 2000  
✉ info@wicona.at

**Benelux**

3400 Landen  
☎ +32 11 690316  
✉ info@wicona.be  
✉ info@wicona.nl

**Czech Republic**

63900 Brno  
☎ +420 543 422030  
✉ info@wicona.cz

**Denmark**

7430 Ikast  
☎ +45 7020 2048  
✉ info@wicona.dk

**España**

08195 Sant Cugat del Vallès  
Barcelona  
☎ +34 902 222323  
✉ info@wicona.es

**Estonia / Latvia / Lithuania**

11317, Tallinn  
☎ +37 2657 6635  
✉ info@wicona.lt

**France**

02200 Courmelles  
☎ +33 3 23598200  
✉ info@wicona.fr

94388 Bonneuil-sur-Marne Cedex

☎ +33 1 45138000

**Germany**

89077 Ulm  
☎ +49 731 3984-0  
✉ info@wicona.de

47051 Duisburg  
☎ +49 203 45046-0

04315 Leipzig  
☎ +49 341 989795-0

64646 Heppenheim  
☎ +49 6252 6736-0

**Hungary**

1031 Budapest  
☎ +36 (1) 4533457  
✉ info@wicona.hu

**Ireland**

Dublin 22, Eire  
☎ +353 1 4105766  
✉ info@wicona.ie

**Italia**

20063 Cernusco sul Naviglio MI  
☎ +39 02 924291  
✉ info@wicona.it

**Norway**

0283 Oslo  
☎ +47 22 422200  
✉ info@wicona.no

**Poland**

03-828 Warszawa  
☎ +48 22 3308170  
✉ info@wicona.pl

**Russia**

RUS-123995, Москва  
☎ +7 495 2077530  
✉ info@wicona.ru

**Sweden**

352 45 Växjö  
☎ +46 470 787400  
✉ info@wicona.se

**Switzerland**

5506 Mägenwil  
☎ +41 62 88741-41  
✉ info@wicona.ch

**United Kingdom**

Wakefield WF5 9TG  
☎ +44 845 6028799  
✉ info@wicona.co.uk

**Africa / Asia / America**

31037 Toulouse  
☎ +33 5 61312626  
✉ info@wicona-int.com

**China**

Tongzhou District, Beijing, PRC 101102  
☎ +8610 60595686  
✉ info@wicona.cn

**Qatar**

Doha  
☎ +974 44 912552  
✉ info@wicona-int.com

