

Systema®

UBEKA:

Unterkonstruktionen für ebene Fassadenplatten

14



UBEKA:

holding tracks for flat wall panels

UBEKA:

ossature pour des plaques façade lisse

UBEKA:
Unterkonstruktionen für ebene Fassadenplatten

UBEKA:
holding tracks for flat wall panels

UBEKA:
ossature pour des plaques façade lisse

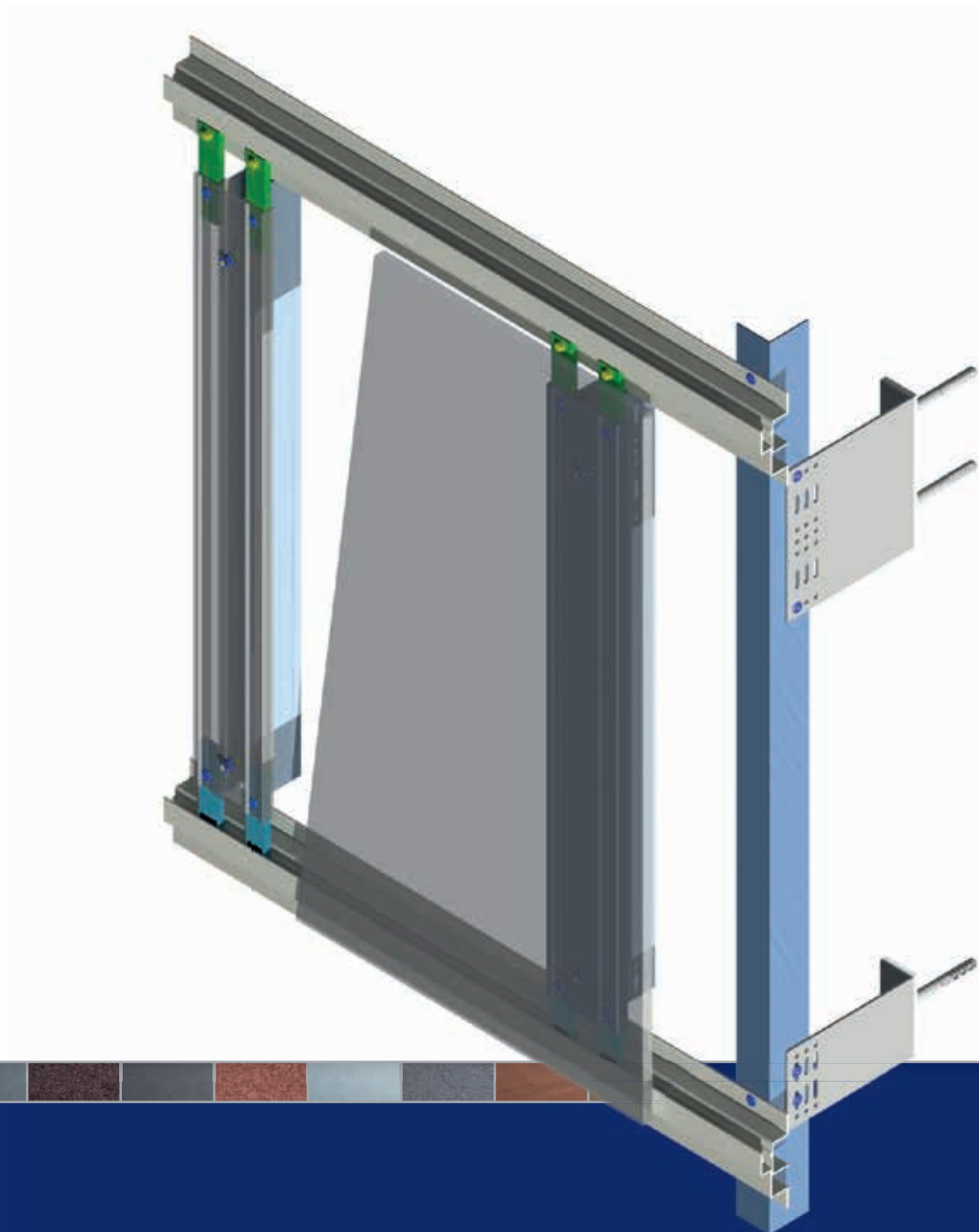

System: **UBEKA**
Unterkonstruktionen für ebene Fassadenplatten

System: **UBEKA**
holding tracks for flat wall panels

Système: **UBEKA**
ossature pour des plaques façade lisse

Seite page	14.02	Schnittübersicht	summary of sections	vue d'ensemble
	14.03	Isometrie	isometric view	dessin isométrique
	14.04	Schnitt horizontal	section horizontal	coupe horizontale
	14.05	Schnitt vertikal	section vertical	coupe verticale
	14.06	Innenecke	internal corner	coin intérieur
	14.07	Außenecke stumpf gestoßen	external corner blunt	coin extérieur bout à bout
	14.08	Außenecke mit negativem Winkel	external corner with negative angle	coin extérieur à angle négatif
	14.09	Außenecke Vierkantprofil	external corner with square profile	coin extérieur avec profil carré
	14.10	Fenstersturz	window lintel	linteau
	14.11	Fensterlaibung	window recess	joue de fenêtre
	14.12	Fensterbank	windowsill	bavette de fenêtre extérieure
	14.13	Sockelabschluss	bottom closure	tôle basse de calfeutrement (raccord de socle)
	14.14	Attikaabschluss	parapet	couvre-mur
	14.15	Profilübersicht UBEKA	profile list UBEKA	ensemble de profil UBEKA

UBEKA

Schnittübersicht

summary of sections

vue d'ensemble

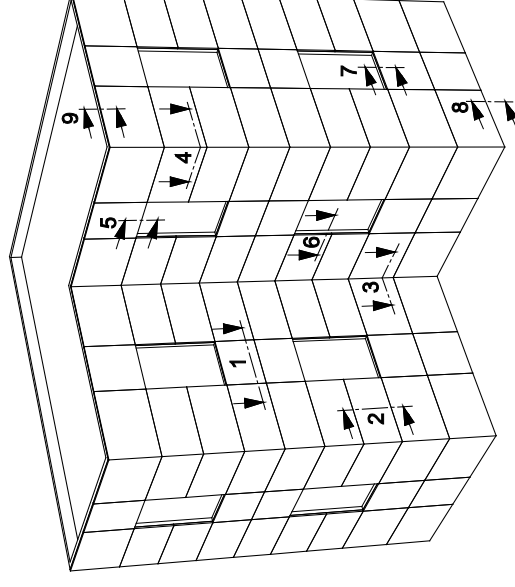

Schnitt 1: horizontal

Schnitt 2: vertikal

Schnitt 3: Innenecke

Schnitt 4: Außenecke

Schnitt 5: Fenstersturz

Schnitt 6: Fensterlaibung

Schnitt 7: Fensterbank

Schnitt 8: Sockelabschluss

Schnitt 9: Attikaabschluss

section 1: horizontal

section 2: vertical

section 3: internal corner

section 4: external corner

section 5: window lintel

section 6: window recess

section 7: windowsill

section 8: bottom closure

section 9: parapet

coupe 1: horizontale

coupe 2: verticale

coupe 3: coin intérieur

coupe 4: coin extérieur

coupe 5: linteau

coupe 6: joue de fenêtre

coupe 7: bavette de

fenêtre extérieure

coupe 8: tôle basse de

calfeutrement (raccord de

socle)

coupe 9: couvre-mur

Unterkonstruktionen für ebene Fassadenplatten

holding tracks for flat wall panels

ossature pour des plaques façade lisse

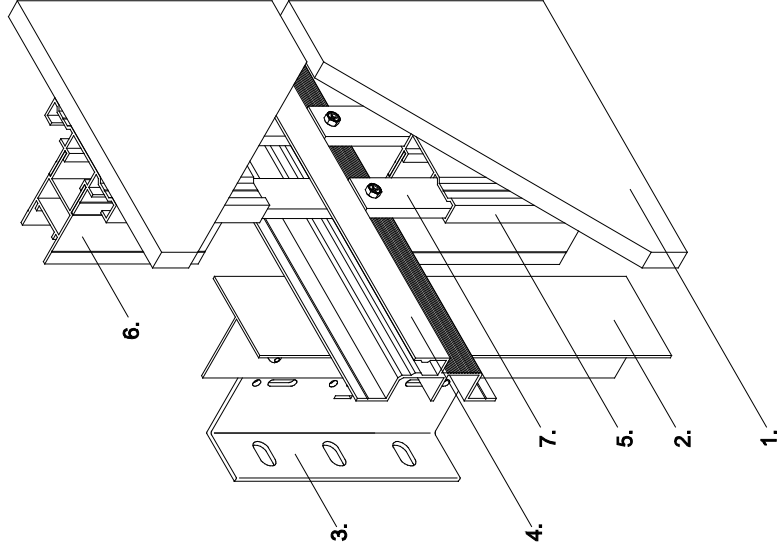

1. Fassadenbekleidung
2. senkrechtes Tragprofil
3. Systea L-Wandkonsole
4. Laschenprofil
5. Basisprofil
6. Supportprofil
7. Lasche

1. cladding panel
2. vertical holding track
3. Systea L-bracket
4. splice profile
5. basic profile
6. support profile
7. splice plate

1. revêtement de façade
2. profil support vertical
3. équerre en L Systea
4. profil d'attache
5. profil de base
6. profil d'appui
7. attache

Schnitt 1 horizontal

section 1 horizontal

coupe 1 horizontale

Bekleidung: Keramik, Faserzement, Naturstein, Feinsteinzeug, HPL mit Hinterschnittbefestigung

cladding: ceramic panels, fiber cement, natural stone, porcelain stoneware, HPL fixing with non-expanding anchor bolts

revêtement de façade: céramique, ciment fibre, pierre naturelle, grès cérame fin vitrifié, HPL à fixation antérieure

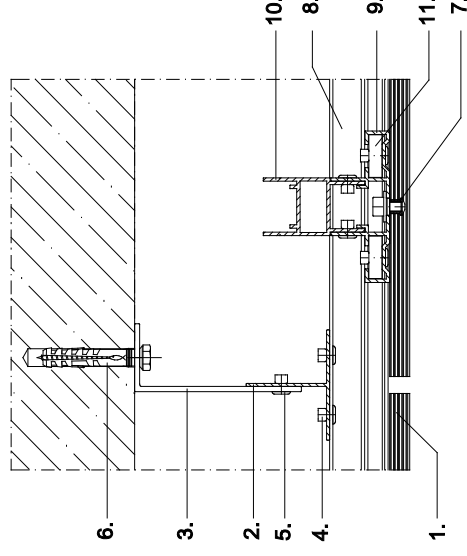

1. Fassadenbekleidung
2. senkrechtes Tragprofil
3. Systea L-Wandkonsole
4. Befestigungsniel
5. Verbindungsniel
6. Verankerung
7. Hinterschnittdübel
8. Laschenprofil
9. Basisprofil
10. Supportprofil
11. Lasche

1. cladding panel
2. vertical holding track
3. Systea L-bracket
4. fixing rivet
5. connecting rivet
6. fixing
7. non-expanding anchor bolt
8. splice profile
9. basic profile
10. support profile
11. splice plate

1. revêtement de façade
2. profil support vertical
3. équerre en L Systea
4. rivet de fixation
5. jonction
6. ancrage
7. cheville antérieure
8. profil d'attache
9. profil de base
10. profil d'appui
11. attache

Schnitt 2 vertikal

Bekleidung: Keramik,
Faserzement, Naturstein,
Feinsteinzeug, HPL mit
Hinterschnittbefestigung

section 2 vertical

cladding: ceramic panels,
fiber cement, natural stone,
porcelain stoneware, HPL
fixing with non-expanding
achor bolts

coupe 2 verticale

revêtement de façade:
céramique, ciment fibre,
pierre naturelle, grès cérame
fin vitrifié, HPL à fixation
antérieure

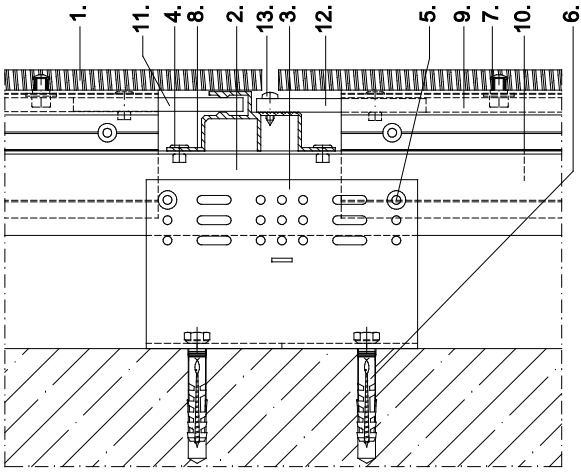

- | | |
|------------------------------|-------------------------------|
| 1. Fassadenbekleidung | 1. revêtement de façade |
| 2. senkrechtes Tragprofil | 2. profil support vertical |
| 3. Systema L-Wandkonsole | 3. équerre en L Systea |
| 4. Befestigungsniet | 4. rivet de fixation |
| 5. Verbindungsniet | 5. jonction |
| 6. Verankerung | 6. ancrage |
| 7. Hinterschnittdübel | 7. cheville antérieure |
| 8. Laschenprofil | 8. profil d'attache |
| 9. Basisprofil | 9. profil de base |
| 10. Supportprofil | 10. profil d'appui |
| 11. Lasche Typ 1F | 11. attache type 1F |
| 12. Lasche Typ 2 bzw. Typ 2R | 12. attache type 2 ou type 2R |
| 13. Blechschraube | 13. vis à tôle |

Schnitt 3 Innenecke

Bekleidung: Keramik,
Faserzement, Naturstein,
Feinsteinzeug, HPL mit
Hinterschnittbefestigung

section 3 internal corner

cladding: ceramic panels,
fiber cement, natural stone,
porcelain stoneware, HPL
fixing with non-expanding
achor bolts

coupe 3 coin intérieur

revêtement de façade:
céramique, ciment fibre,
pierre naturelle, grès cérame
fin vitrifié, HPL à fixation
antérieure

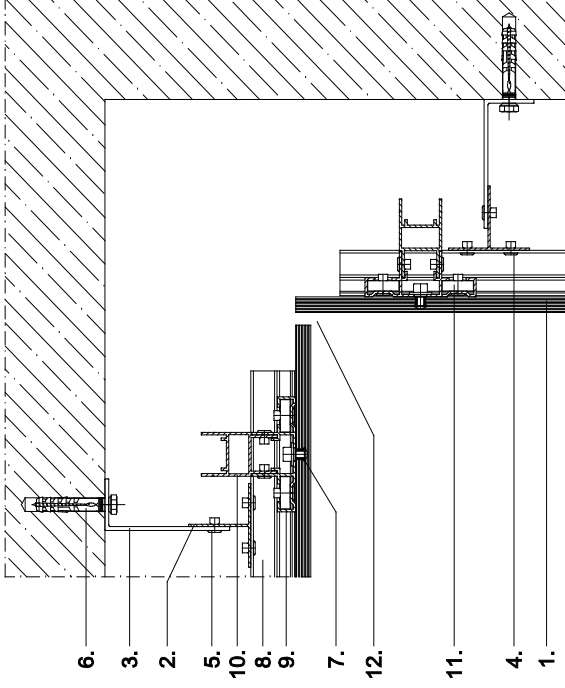

- | | |
|---------------------------|---------------------------------|
| 1. Fassadenbekleidung | 1. revêtement de façade |
| 2. senkrechtes Tragprofil | 2. profil support vertical |
| 3. Systema L-Wandkonsole | 3. équerre en L Systea |
| 4. Befestigungsniet | 4. rivet de fixation |
| 5. Verbindungsniet | 5. jonction |
| 6. Verankerung | 6. ancrage |
| 7. Hinterschnittdübel | 7. cheville antérieure |
| 8. Laschenprofil | 8. profil d'attache |
| 9. Basisprofil | 9. profil de base |
| 10. Supportprofil | 10. profil d'appui |
| 11. Lasche | 11. attache |
| 12. Innenecke gestoßen | 12. coin intérieure bout à bout |

Schnitt 4
Außenecke
stumpf gestoßen

Bekleidung: Keramik,
Faserzement, Naturstein,
Feinsteinzeug, HPL mit
Hinterschnittbefestigung

section 4
external corner
blunt

cladding: ceramic panels,
fiber cement, natural stone,
porcelain stoneware, HPL
fixing with non-expanding
achor bolts

coupe 4
coin extérieur
bout à bout

revêtement de façade:
céramique, ciment fibre,
pierre naturelle, grès cérame
fin vitrifié, HPL à fixation
antérieure

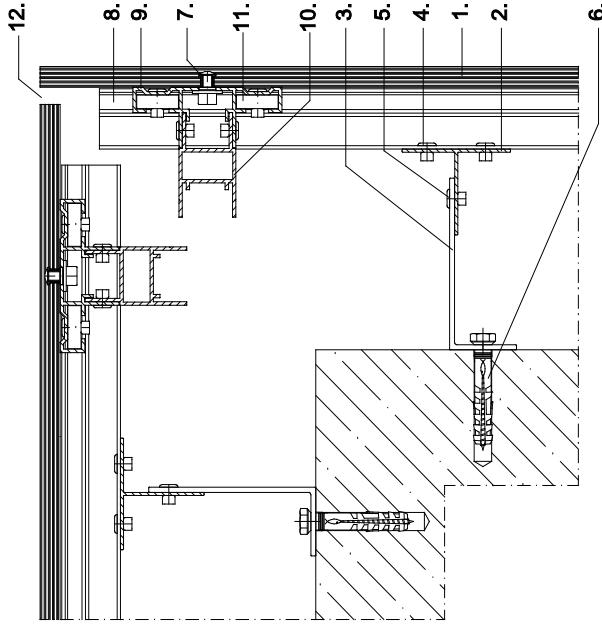

1. Fassadenbekleidung
2. senkrechtcs Tragprofil
3. Systea L-Wandkonsole
4. Befestigungsniel
5. Verbindungsniel
6. Verankerung
7. Hinterschnitttöbel
8. Laschenprofil
9. Basisprofil
10. Supportprofil
11. Lasche
12. Außenecke stumpf gestoßen

1. cladding panel
2. vertical holding track
3. Systea L-bracket
4. fixing rivet
5. connecting rivet
6. fixing
7. non-expanding anchor
8. splice profile
9. basic profile
10. support profile
11. splice plate
12. external corner, blunt

Schnitt 4
Außenecke mit
negativem Winkel

Bekleidung: Keramik,
Faserzement, Naturstein,
Feinsteinzeug, HPL mit
Hinterschnittbefestigung

section 4
external corner with
negative angle

cladding: ceramic panels,
fiber cement, natural stone,
porcelain stoneware, HPL
fixing with non-expanding
achor bolts

coupe 4
coin extérieur
à angle négatif

revêtement de façade:
céramique, ciment fibre,
pierre naturelle, grès cérame
fin vitrifié, HPL à fixation
antérieure

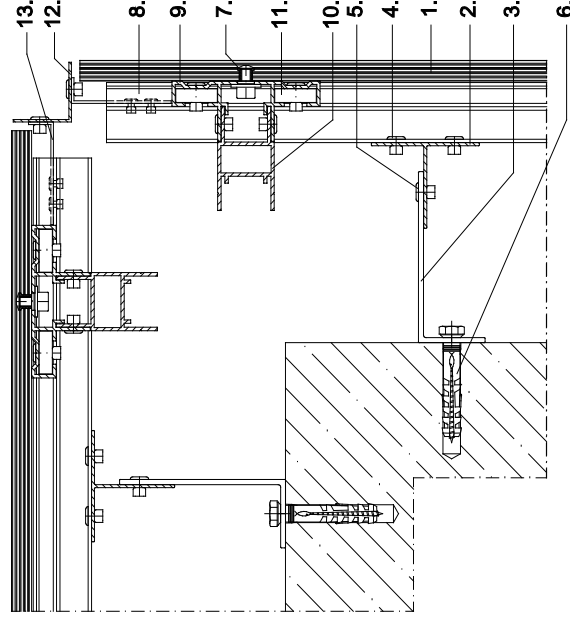

1. Fassadenbekleidung
2. senkrechtcs Tragprofil
3. Systea L-Wandkonsole
4. Befestigungsniel
5. Verbindungsniel
6. Verankerung
7. Hinterschnitttöbel
8. Laschenprofil
9. Basisprofil
10. Supportprofil
11. Lasche
12. Außenecke mit Negativausbildung
13. Winkelprofil

1. cladding panel
2. vertical holding track
3. Systea L-bracket
4. fixing rivet
5. connecting rivet
6. fixing
7. non-expanding anchor
8. splice profile
9. basic profile
10. support profile
11. splice plate
12. external corner with negative angle
13. angle profile

1. revêtement de façade
2. profil support vertical
3. équerre en L Systea
4. rivet de fixation
5. jonction
6. ancrage
7. cheville antérieure
8. profil d'attache
9. profil de base
10. profil d'appui
11. attache
12. profil extérieur à configuration négative
13. profil d'équerre

Schnitt 4 Außenecke mit Vierkantprofil

Bekleidung: Keramik,
Faserzement, Naturstein,
Feinsteinzeug, HPL mit
Hinterschnittbefestigung

section 4 external corner with square profile

cladding: ceramic panels,
fiber cement, natural stone,
porcelain stoneware, HPL
fixing with non-expanding
achor bolts

coupe 4 coin extérieur avec profil carré

revêtement de façade:
céramique, ciment fibre,
pierre naturelle, grès cérame
fin vitrifié, HPL à fixation
antérieure

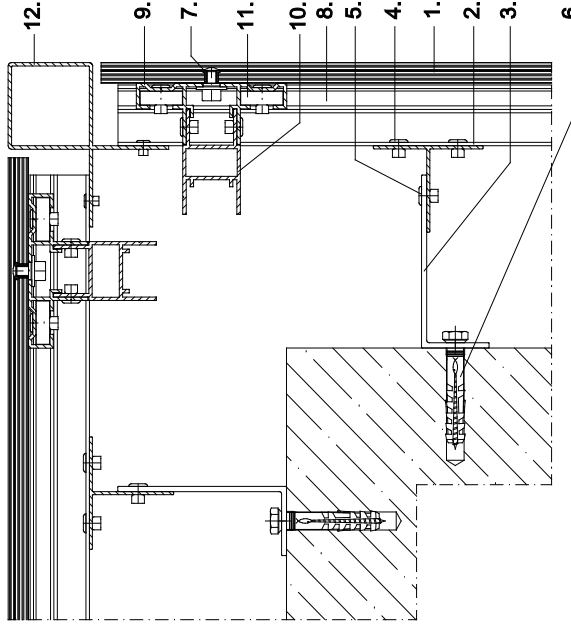

1. Fassadenbekleidung
2. senkrechtcs Tragprofil
3. Systea L-Wandkonsole
4. Befestigungsniel
5. Verbindungsniel
6. Verankerung
7. Hinterschnittdübel
8. Laschenprofil
9. Basisprofil
10. Supportprofil
11. Lasche
12. Außenecke mit Vierkantprofil

1. cladding panel
2. vertical holding track
3. Systea L-bracket
4. fixing rivet
5. connecting rivet
6. fixing
7. non-expanding achor bolt
8. splice profile
9. basic profile
10. support profile
11. splice plate
12. external corner with square profile

1. revêtement de façade
2. profil support vertical
3. équerre en L Systea
4. rivet de fixation
5. jonction
6. ancrage
7. cheville antérieure
8. profil d'attache
9. profil de base
10. profil d'appui
11. attache
12. coin extérieur avec profil carré

Schnitt 5 Fenstersturz

Bekleidung: Keramik,
Faserzement, Naturstein,
Feinsteinzeug, HPL mit
Hinterschnittbefestigung

section 5 window lintel

cladding: ceramic panels,
fiber cement, natural stone,
porcelain stoneware, HPL
fixing with non-expanding
achor bolts

coupe 5 linteau

revêtement de façade:
céramique, ciment fibre,
pierre naturelle, grès cérame
fin vitrifié, HPL à fixation
antérieure

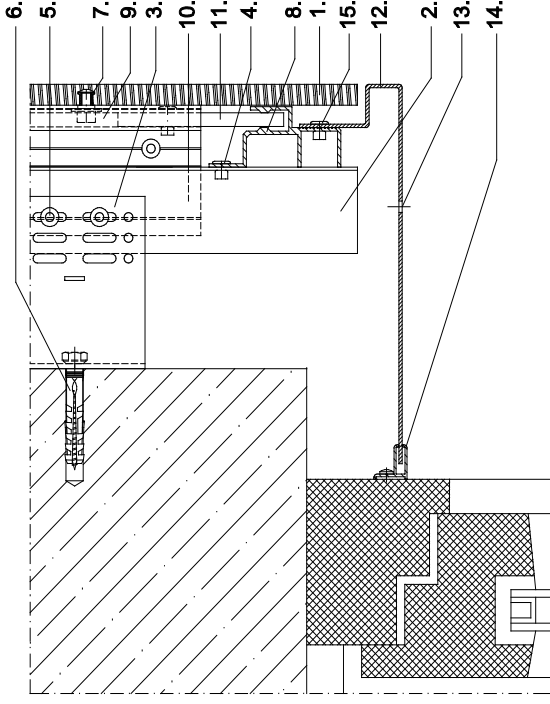

1. Fassadenbekleidung
2. senkrechtcs Tragprofil
3. Systea L-Wandkonsole
4. Befestigungsniel
5. Verbindungsniel
6. Verankerung
7. Hinterschnittdübel
8. Laschenprofil
9. Basisprofil
10. Supportprofil
11. Lasche Typ 1F
12. Fensterzarge
13. Belüftungsöffnung
14. Systea Stimmgabelprofil
15. Befestigungselement

1. cladding panel
2. vertical holding track
3. Systea L-bracket
4. fixing rivet
5. connecting rivet
6. fixing
7. non-expanding achor bolt
8. splice profile
9. basic profile
10. support profile
11. splice plate typ 1F
12. window frame
13. ventilation opening
14. Systea F-profile (diapason)
15. fixing element

1. revêtement de façade
2. profil support vertical
3. équerre en L Systea
4. rivet de fixation
5. jonction
6. ancrage
7. cheville antérieure
8. profil d'attache
9. profil de base
10. profil d'appui
11. attache type 1F
12. châssis
13. ventilation
14. profil F Systea (diapason)
15. élément de fixation

Schnitt 6 Fensterlaibung

Bekleidung: Keramik,
Faserzement, Naturstein,
Feinsteinzeug, HPL mit
Hinterschnittbefestigung

section 6 window recess

cladding: ceramic panels,
fiber cement, natural stone,
porcelain stoneware, HPL
fixing with non-expanding
achor bolts

coupe 6 joue de fenêtre

revêtement de façade:
céramique, ciment fibre,
pierre naturelle, grès cérame
fin vitrifié, HPL à fixation
antérieure

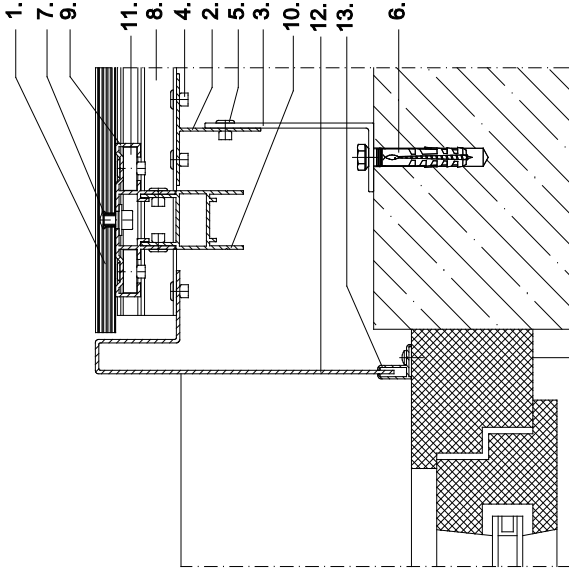

1. Fassadenbekleidung
2. senkrechtes Tragprofil
3. Systea L-Wandkonsole
4. Befestigungsniet
5. Verbindungsniet
6. Verankerung
7. Hinterschnittdübel
8. Laschenprofil
9. Basisprofil
10. Supportprofil
11. Lasche
12. Fensterzarge
13. Systea Stimmgabelprofil

1. cladding panel
2. vertical holding track
3. Systea L-bracket
4. fixing rivet
5. connecting rivet
6. fixing
7. non-expanding achor bolt
8. splice profile
9. basic profile
10. support profile
11. splice plate
12. window frame
13. Systea F-profile

1. revêtement de façade
2. profil support vertical
3. équerre en L Systea
4. rivet de fixation
5. jonction
6. ancrage
7. cheville antérieure
8. profil d'attache
9. profil de base
10. profil d'appui
11. attache
12. châssis
13. profil F Systea (diapason)

Schnitt 7 Fensterbank

Bekleidung: Keramik,
Faserzement, Naturstein,
Feinsteinzeug, HPL mit
Hinterschnittbefestigung

section 7 windowsill

cladding: ceramic panels,
fiber cement, natural stone,
porcelain stoneware, HPL
fixing with non-expanding
achor bolts

coupe 7 bavette de fenêtre extérieure

revêtement de façade:
céramique, ciment fibre,
pierre naturelle, grès cérame
fin vitrifié, HPL à fixation
antérieure

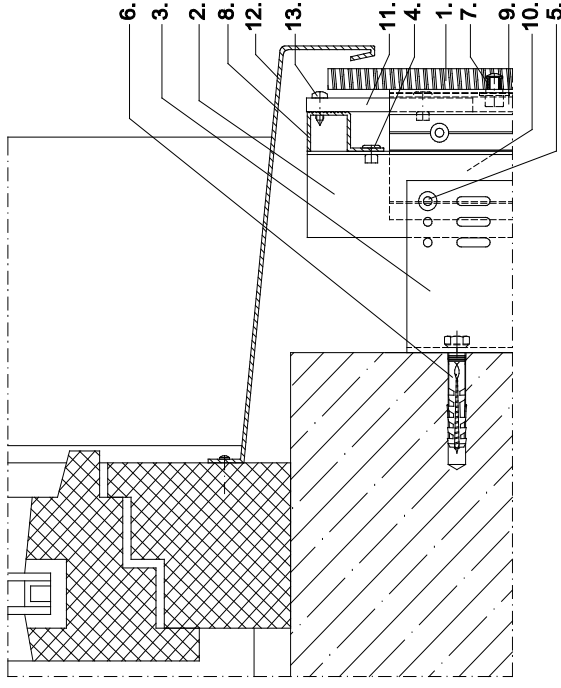

1. Fassadenbekleidung
2. senkrechtes Tragprofil
3. Systea L-Wandkonsole
4. Befestigungsniet
5. Verbindungsniet
6. Verankerung
7. Hinterschnittdübel
8. Laschenprofil einseitig
9. Basisprofil
10. Supportprofil
11. Lasche Typ 2 bzw. Typ 2R
12. Systea Fensterbank
13. Blechschraube

1. cladding panel
2. vertical holding track
3. Systea L-bracket
4. fixing rivet
5. connecting rivet
6. fixing
7. non-expanding achor bolt
8. one-side splice profile
9. basic profile
10. support profile
11. splice plate typ 2 or typ 2R
12. Systea windowsill
13. metal screw

1. revêtement de façade
2. profil support vertical
3. équerre en L Systea
4. rivet de fixation
5. jonction
6. ancrage
7. cheville antérieure
8. profil d'attache unilatéral
9. profil de base
10. profil d'appui
11. attache type 2 ou type 2R
12. bavette Systea
13. vis à tête

Schnitt 8 Sockelabschluss

Bekleidung: Keramik,
Faserzement, Naturstein,
Feinsteinzeug, HPL mit
Hinterschnittbefestigung

section 8 bottom closure

cladding: ceramic panels,
fiber cement, natural stone,
porcelain stoneware, HPL
fixing with non-expanding
achor bolts

coupe 8 tôle basse de caffeutrement (raccord de socle)

revêtement de façade:
céramique, ciment fibre,
pierre naturelle, grès cérame
fin vitrifié, HPL à fixation
antérieure

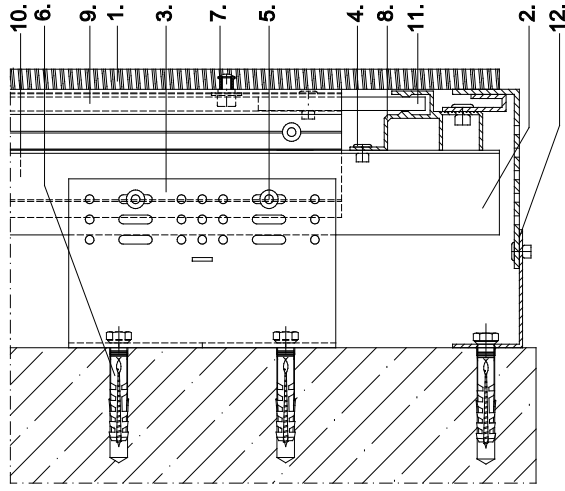

- | | | |
|-----------------------------------|------------------------------|----------------------------|
| 1. Fassadenbekleidung | 1. cladding panel | 1. revêtement de façade |
| 2. senkrechtcs Tragprofil | 2. vertical holding track | 2. profil support vertical |
| 3. Systea L-Wandkonsole | 3. Systea L-bracket | 3. équerre en L Systea |
| 4. Befestigungsniet | 4. fixing rivet | 4. rivet de fixation |
| 5. Verbindungsniet | 5. connecting rivet | 5. jonction |
| 6. Verankerung | 6. fixing | 6. ancrage |
| 7. Hinterschnittdübel | 7. non-expanding anchor bolt | 7. cheville antérieure |
| 8. Laschenprofil | 8. splice profile | 8. profil d'attache |
| 9. Basisprofil | 9. basic profile | 9. profil de base |
| 10. Supportprofil | 10. support profile | 10. profil d'appui |
| 11. Lasche Typ 1F | 11. splice plate type 1F | 11. attache type 1F |
| 12. Abschlusswinkel mit Belüftung | 12. ventilated angle | 12. angle pour ventilation |

Schnitt 9 Attikaabschluss

Bekleidung: Keramik,
Faserzement, Naturstein,
Feinsteinzeug, HPL mit
Hinterschnittbefestigung

section 9 parapet

cladding: ceramic panels,
fiber cement, natural stone,
porcelain stoneware, HPL
fixing with non-expanding
achor bolts

coupe 9 couvre-mur

revêtement de façade:
céramique, ciment fibre,
pierre naturelle, grès cérame
fin vitrifié, HPL à fixation
antérieure

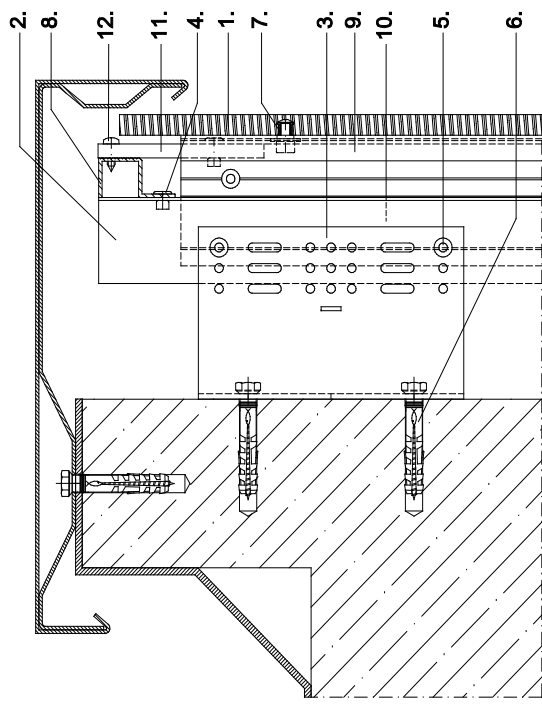

- | | | |
|------------------------------|------------------------------------|-------------------------------|
| 1. Fassadenbekleidung | 1. cladding panel | 1. revêtement de façade |
| 2. senkrechtcs Tragprofil | 2. vertical holding track | 2. profil support vertical |
| 3. Systea L-Wandkonsole | 3. Systea L-bracket | 3. équerre en L Systea |
| 4. Befestigungsniet | 4. fixing rivet | 4. rivet de fixation |
| 5. Verbindungsniet | 5. connecting rivet | 5. jonction |
| 6. Verankerung | 6. fixing | 6. ancrage |
| 7. Hinterschnittdübel | 7. non-expanding anchor bolt | 7. cheville antérieure |
| 8. Laschenprofil | 8. splice profile | 8. profil d'attache |
| 9. Basisprofil | 9. basic profile | 9. profil de base |
| 10. Supportprofil | 10. support profile | 10. profil d'appui |
| 11. Lasche Typ 2 bzw. Typ 2R | 11. splice plate type 2 or type 2R | 11. attache type 2 ou type 2R |
| 12. Blechschraube | 12. metal screw | 12. vis à tôle |

Inhaltsverzeichnis Profilübersicht UBEKA Contents profile list UBEKA Index ensemble de profil UBEKA

Seite page page	Profile	profiles	profilés
14.16	vertikale Tragprofile T-Profil 40/55 T-Profil 65/50 Wanddicke 2mm T-Profil 80/50 Wanddicke 2mm	vertical holding tracks T-profile 40/55 T-profile 65/50 wall thickness 2mm T-profile 80/50 wall thickness 2mm	rails porteurs verticaux profil T 40/55 profil T 65/50 épaisseur du mur 2mm profil T 80/50 épaisseur du mur 2mm
14.17	Systemprofile UBEKA Laschenprofil "Neu" 99,5/35,1mm beid. Laschenprofil "Neu" 70/35,1mm beid. Laschenprofil "Neu" 46/23mm eins. Basisprofil 89,2 x 35,25mm Supportprofil 61 x 34mm	system profiles UBEKA splice profile "new" 99,5/35,1mm two-sided splice profile "new" 70/35,1mm two-sided splice profile "new" 46/23mm one-sided basic profile 89,2 x 35,25mm support profile 61 x 34mm	profilés de système UBEKA profil d'attache "nouveau" 99,5/35,1mm bilatéral profil d'attache "nouveau" 70/35,1mm bilatéral profil d'attache "nouveau" 46/23mm unilatéral profil de base 89,2 x 35,25mm profil d'appui 61 x 34mm
14.18	Lasche Typ 1F 25x8 - 100mm Lasche Typ 2 25x8 - 100mm Lasche Typ 2R 25x8 - 100mm	splice plate typ 1F 25x8 - 100mm splice plate typ 2 25x8 - 100mm splice plate typ 2R 25x8 - 100mm	attache type 1F 25x8 - 100mm attache type 2 25x8 - 100mm attache type 2R 25x8 - 100mm
14.19	L-Wandkonsolen WB 0 - 85/160/250mm WB 1-6 - 85/160/250mm WB 7-9,5 - 85/160/250 WB 10-14 - 85/160/250mm	L-brackets WB 0 - 85/160/250mm WB 1-6 - 85/160/250mm WB 7-9,5 - 85/160/250 WB 10-14 - 85/160/250mm	équerres en L WB 0 - 85/160/250mm WB 1-6 - 85/160/250mm WB 7-9,5 - 85/160/250 WB 10-14 - 85/160/250mm

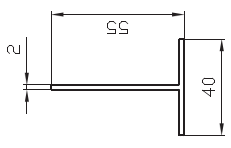
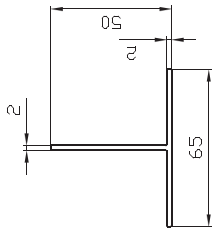
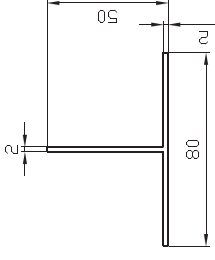

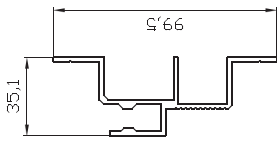
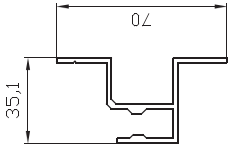
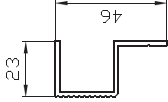
Profiltyp profile type type de profil	Länge (mm) length (mm) longueur (mm)	Material material matériel	Einzelpreis unit price prix unitaire
 <p>T-Profil 40/55 T-profile 40/55 profil T 40/55</p>	5600	EN AW 6063 T66	
	6000		
 <p>T-Profil 65/50 Wanddicke 2mm T-profile 65/50 wall thickness 2mm profil T 65/50 épaisseur du mur 2mm</p>	5600	EN AW 6063 T66	
	6000		
 <p>T-Profil 80/50 Wanddicke 2mm T-profile 80/50 wall thickness 2mm profil T 80/50 épaisseur du mur 2mm</p>	5600	EN AW 6063 T66	
	6000		

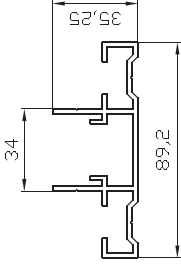
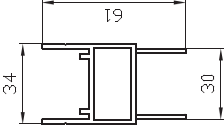
Profiltyp profile type type de profil	Länge (mm) length (mm) longueur (mm)	Material material matériel	Einzelpreis unit price prix unitaire
 <p>Laschenprofil „Neu“ 99,5/35,1mm beids. splice profile „new“ 99,5/35,1mm two-sided profil d'attache „nouveau“ 99,5/35,1mm bilatéral</p>	6000	EN AW 6063 T66	
 <p>Laschenprofil „Neu“ 70/35,1mm beids. splice profile „neu“ 70/35,1mm two-sided profil d'attache „nouveau“ 70/35,1mm bilatéral</p>	6000	EN AW 6063 T66	
 <p>Laschenprofil „Neu“ 46/23mm eins. splice profile „new“ 46/23mm one-sided profil d'attache „nouveau“ 46/23mm unilatéral</p>	6000	EN AW 6063 T66	

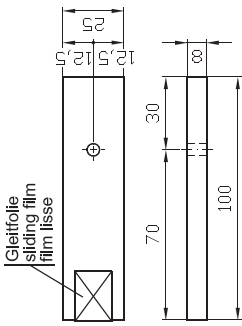
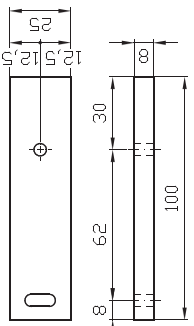
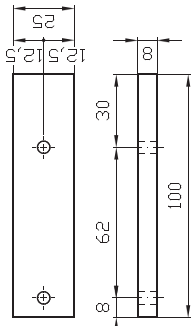
Profiltyp profile type type de profil	Länge (mm) length (mm) longueur (mm)	Material material matériel	Einzelpreis unit price prix unitaire
 <p>Basisprofil 89,2 x 35,25mm basic profile 89,2 x 35,25mm profil de base 89,2 x 35,25mm</p>	6000	EN AW 6063 T66	
 <p>Supportprofil 61 x 34mm support profile 61 x 34mm profil d'appui 61 x 34mm</p>	6000	EN AW 6063 T66	

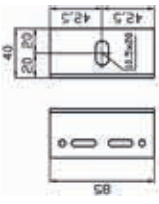
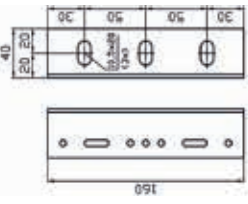
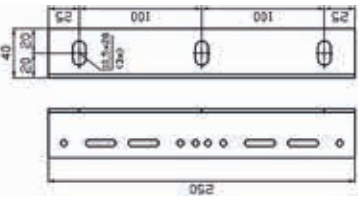
Profiltyp profile type type de profil	Länge (mm) length (mm) longueur (mm)	Material material matériau	Einzelpreis unit price prix unitaire
 <p>Gleitfolie sliding film film lisse</p> <p>Lasche Typ 1F 25x8-100mm splice plate typ 1F 25x8-100mm attache type 1F 25x8-100mm</p>		EN AW 6063 T66	
 <p>Lasche Typ 2 25x8-100mm splice plate typ 2 25x8-100mm attache type 2 25x8-100mm</p>		EN AW 6063 T66	
 <p>Lasche Typ 2R 25x8-100mm splice plate typ 2R 25x8-100mm attache type 2R 25x8-100mm</p>		EN AW 6063 T66	

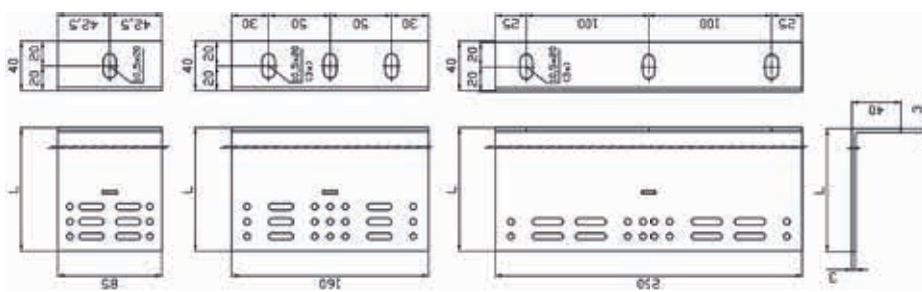
Profiltyp profile type type de profil	Länge (mm) length (mm) longueur (mm)	Material material matériau	Einzelpreis unit price prix unitaire
  	<p>WB0 40/40/3-85</p> <p>WB0 40/40/3-160</p> <p>WB0 40/40/3-250</p>	<p>EN AW 6063 T66</p> <p>EN AW 6063 T66</p> <p>EN AW 6063 T66</p>	
WB0 40/40/3 - 85/160/250mm			

Profiltyp profile type type de profil	Länge (mm) length (mm) longueur (mm)	Material material matériau	Einzelpreis unit price prix unitaire														
	WB1 40/60/3-85 WB2 40/80/3-85 WB3 40/100/3-85 WB4 40/120/3-85 WB5 40/140/3-85 WB6 40/160/3-85	EN AW 6063 T66															
	WB1 40/60/3-160 WB2 40/80/3-160 WB3 40/100/3-160 WB4 40/120/3-160 WB5 40/140/3-160 WB6 40/160/3-160	EN AW 6063 T66															
	WB1 40/60/3-250 WB2 40/80/3-250 WB3 40/100/3-250 WB4 40/120/3-250 WB5 40/140/3-250 WB6 40/160/3-250	EN AW 6063 T66															
<table border="1"> <thead> <tr> <th>L-Wandkonsole L-bracket équerre en L</th> <th>Länge L length L longueur L</th> </tr> </thead> <tbody> <tr> <td>WB1</td> <td>60 mm</td> </tr> <tr> <td>WB2</td> <td>80 mm</td> </tr> <tr> <td>WB3</td> <td>100 mm</td> </tr> <tr> <td>WB4</td> <td>120 mm</td> </tr> <tr> <td>WB5</td> <td>140 mm</td> </tr> <tr> <td>WB6</td> <td>160 mm</td> </tr> </tbody> </table>			L-Wandkonsole L-bracket équerre en L	Länge L length L longueur L	WB1	60 mm	WB2	80 mm	WB3	100 mm	WB4	120 mm	WB5	140 mm	WB6	160 mm	
L-Wandkonsole L-bracket équerre en L	Länge L length L longueur L																
WB1	60 mm																
WB2	80 mm																
WB3	100 mm																
WB4	120 mm																
WB5	140 mm																
WB6	160 mm																
<p>WB 1-6 - 85/160/250mm</p> 																	

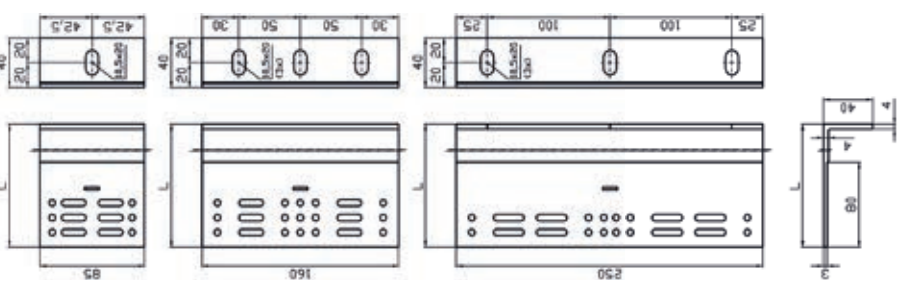
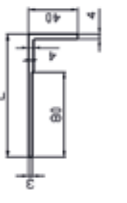
Profiltyp profile type type de profil	Länge (mm) length (mm) longueur (mm)	Material material matériau	Einzelpreis unit price prix unitaire												
	WB7 40/180/4/3-85 WB8 40/200/4/3-85 WB8.5 40/210/4/3-85 WB9 40/220/4/3-85 WB9.5 40/230/4/3-85	EN AW 6063 T66													
	WB7 40/180/4/3-160 WB8 40/200/4/3-160 WB8.5 40/210/4/3-160 WB9 40/220/4/3-160 WB9.5 40/230/4/3-160	EN AW 6063 T66													
	WB7 40/180/4/3-250 WB8 40/200/4/3-250 WB8.5 40/210/4/3-250 WB9 40/220/4/3-250 WB9.5 40/230/4/3-250	EN AW 6063 T66													
<table border="1"> <thead> <tr> <th>L-Wandkonsole L-bracket équerre en L</th> <th>Länge L length L longueur L</th> </tr> </thead> <tbody> <tr> <td>WB7</td> <td>180 mm</td> </tr> <tr> <td>WB8</td> <td>200 mm</td> </tr> <tr> <td>WB8.5</td> <td>210 mm</td> </tr> <tr> <td>WB9</td> <td>220 mm</td> </tr> <tr> <td>WB9.5</td> <td>230 mm</td> </tr> </tbody> </table>			L-Wandkonsole L-bracket équerre en L	Länge L length L longueur L	WB7	180 mm	WB8	200 mm	WB8.5	210 mm	WB9	220 mm	WB9.5	230 mm	
L-Wandkonsole L-bracket équerre en L	Länge L length L longueur L														
WB7	180 mm														
WB8	200 mm														
WB8.5	210 mm														
WB9	220 mm														
WB9.5	230 mm														
<p>WB7-9.5 - 85/160/250mm</p> 															

Profiltyp profile type type de profil	Länge (mm) length (mm) longueur (mm)	Material material matériau	Einzelpreis unit price prix unitaire
	WB10 43/240/4/3-85 WB11 43/260/4/3-85 WB12 43/280/4/3-85 WB13 43/300/4/3-85 WB14 43/320/4/3-85	EN AW 6063 T66	
	WB10 43/240/4/3-160 WB11 43/260/4/3-160 WB12 43/280/4/3-160 WB13 43/300/4/3-160 WB14 43/320/4/3-160	EN AW 6063 T66	
	WB10 43/240/4/3-250 WB11 43/260/4/3-250 WB12 43/280/4/3-250 WB13 43/300/4/3-250 WB14 43/320/4/3-250	EN AW 6063 T66	
	WB10-14 - 85/160/250mm	L-Wandkonsole L-bracket équerre en L WB10 WB11 WB12 WB13 WB14	Länge L length L longueur L WB10 240 mm WB11 260 mm WB12 280 mm WB13 300 mm WB14 320 mm



Systema®

Systema GmbH

Margarete-Steiff-Str. 6
D-24558 Henstedt-Ulzburg
Deutschland / Germany

Fon: +49 (0) 41 93 / 99 11-0
Fax: +49 (0) 41 93 / 99 11-49

info@systema.systems
www.systema.systems

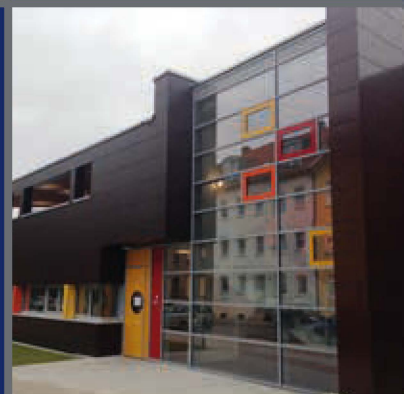

Bitte besuchen Sie uns für weitere
technische Informationen und
eine Vielzahl von Referenzen
im Internet: www.systema.systems