

Systema®

KH 35/SZ 20/CS 20:

Unterkonstruktionen für Kassetten aus Verbundmaterial

16



KH 35/SZ 20/CS 20:

holding tracks for cassettes of composite material

KH 35/SZ 20/CS 20:

ossature pour des cassettes du matériel composé

KH 35/SZ 20/CS 20:
Unterkonstruktionen für Kassetten aus Verbundmaterial

KH 35/SZ 20/CS 20:
holding tracks for cassettes of composite material

KH 35/SZ 20/CS 20:
ossature pour des cassettes du matériel composé

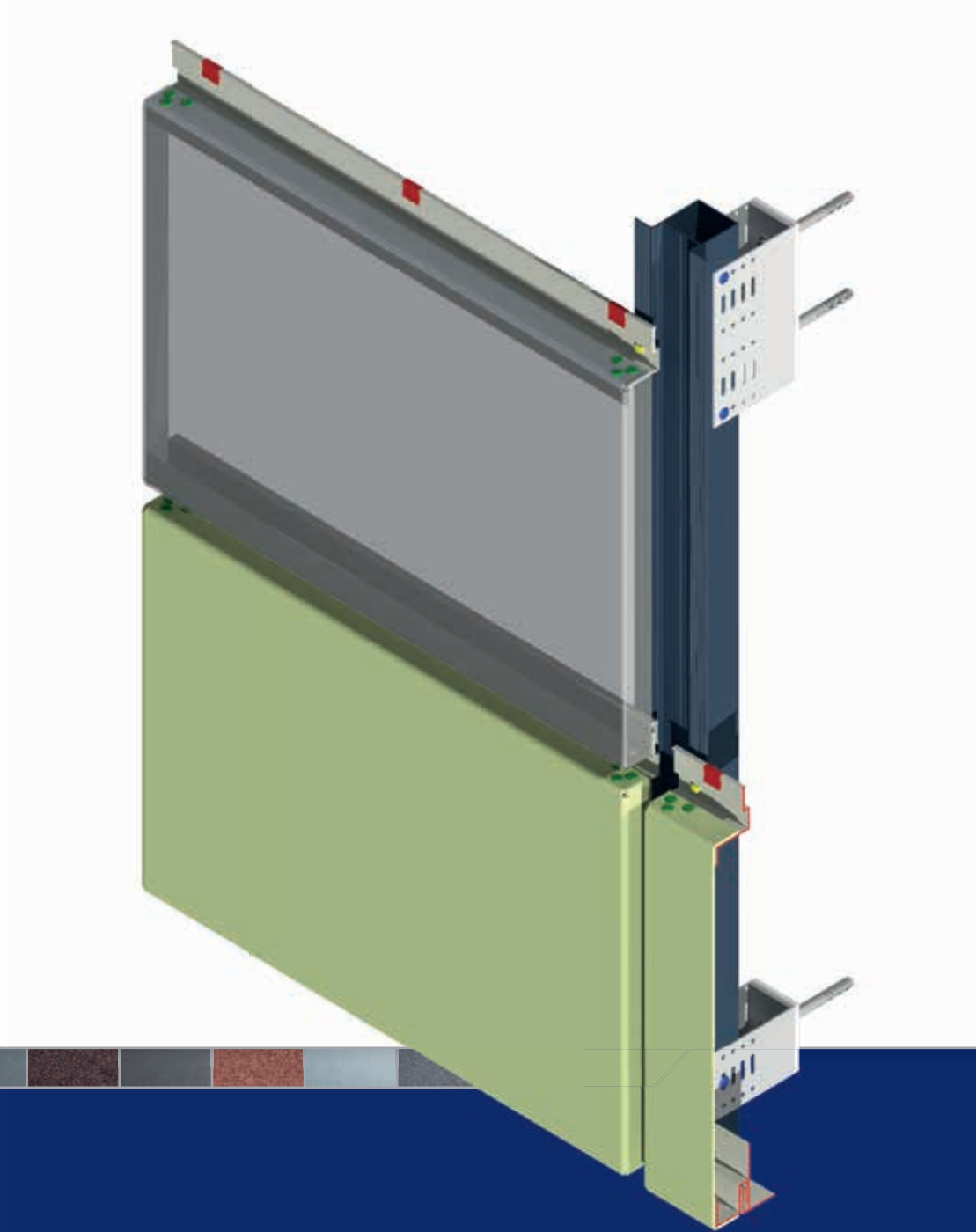

Inhaltsverzeichnis Contents Index

System: **KH 35/SZ 20/CS 20**
Unterkonstruktionen für Kassetten aus Verbundmaterial

System: **KH 35/SZ 20/CS 20**
holding tracks for cassettes of composite material

Système: **KH 35/SZ 20/CS 20**
ossature pour des cassettes du matériel composé

Seite page page	Schnittübersicht	summary of sections	vue d'ensemble
16.02	Isometrie	isometric view	dessin isométrique
16.03	Schnitt horizontal	section horizontal	coupe horizontale
16.04	Schnitt vertikal	section vertical	coupe verticale
16.05	Außenecke	external corner	coin extérieur
16.06	Fensterlaibung	window recess	joue de fenêtre
16.07	Fensterbank	windowsill	bavette de fenêtre extérieure
16.08	Sockelabschluss	bottom closure	tôle basse de calfeutrement (raccord de socle)
16.09	Attikaabschluss	parapet	couvre-mur
16.10	Profilübersicht	profile list	ensemble de profil
16.11	KH 35/SZ 20/CS 20	KH 35/SZ 20/CS 20	KH 35/SZ 20/CS 20

KH 35/SZ 20/CS 20
für Kassetten aus
Verbundmaterial

Schnittübersicht

KH 35/SZ 20/CS 20
for cassettes of composite
material

summary of sections

KH 35/SZ 20/CS 20 pour
des cassettes du matériel
composé

vue d'ensemble

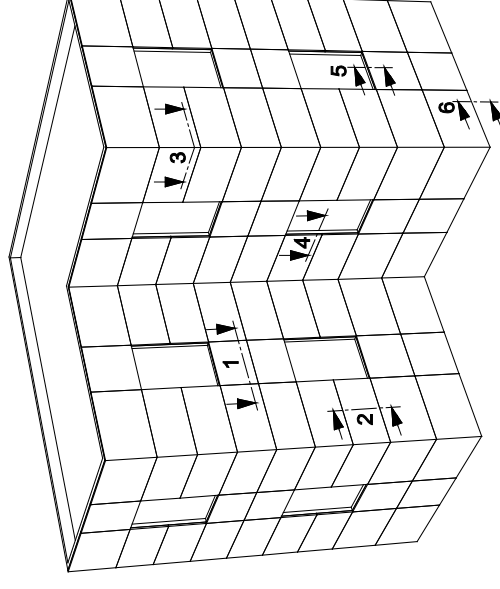

Schnitt 1: horizontal
Schnitt 2: vertikal
Schnitt 3: Außenecke
Schnitt 4: Fensterlaibung
Schnitt 5: Fensterbank
Schnitt 6: Sockelabschluss

section 1: horizontal
section 2: vertical
section 3: external corner
section 4: window recess
section 5: windowsill
section 6: bottom closure

coupe 1: horizontale
coupe 2: verticale
coupe 3: coin extérieur
coupe 4: joue de fenêtre
coupe 5: bavette de
fenêtre extérieure
coupe 6: tôle basse de
calfeutrement (raccord de
socle)

KH 35/SZ 20/CS 20

Unterkonstruktionen für
Kassetten aus Verbund-
material

holding tracks for
cassettes of composite
material

ossature pour des
cassettes du matériel
composé

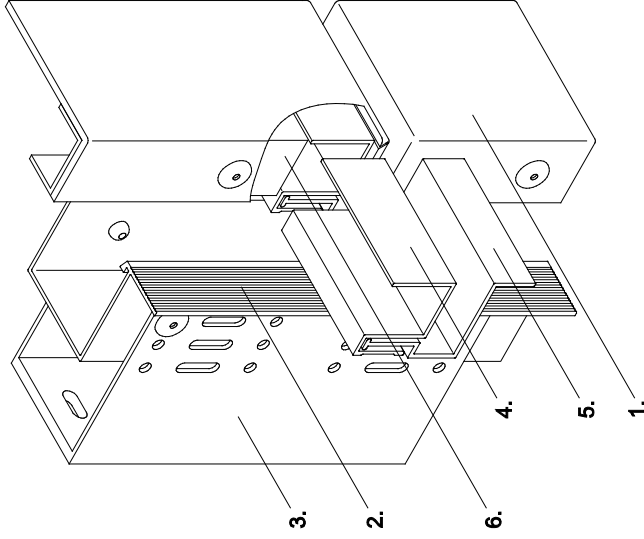

1. Kassette
2. Hutprofil
3. Systema U-Wandkonsole
4. S-Profil
5. Kassettenprofil
6. U-Profil

1. cassette
2. top hat profile
3. Systema U-bracket
4. S-profile
5. section for connecting profile
6. U-profile

1. cassette
2. profil omega
3. étrier en U Systema
4. profil en S
5. profil de cassette
6. profil en U

Schnitt 1 horizontal KH 35/SZ 20/CS 20

section 1 horizontal KH 35/SZ 20/CS 20

coupe 1 horizontale KH 35/SZ 20/CS 20

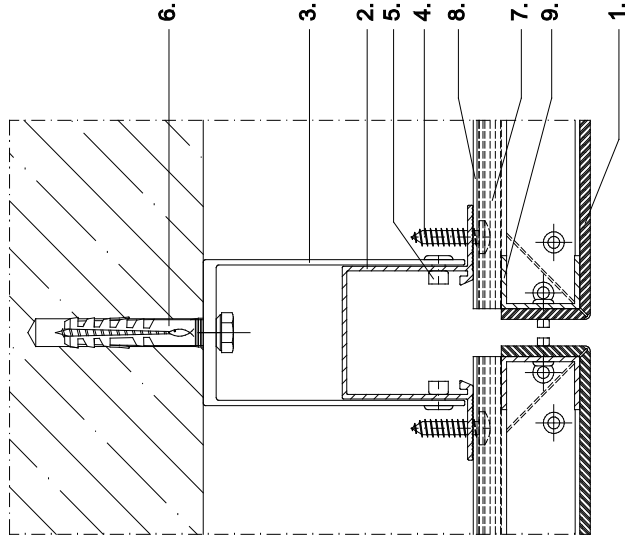

1. Kassette
2. Hutprofil
3. Systema U-Wandkonsole
4. Befestigungselement
5. Verbindungsniet
6. Verankerung
7. S-Profil
8. Kassettenprofil
9. U-Profil

1. cassette
2. top hat profile
3. Systema U-bracket
4. fixing element
5. connecting rivet
6. fixing
7. S-profile
8. section for connecting profile
9. U-profile

1. cassette
2. profil omega
3. étrier en U Systema
4. élément de fixation
5. jonction
6. ancrage
7. profil en S
8. profil de cassette
9. profil en U

**Schnitt 2
vertikal**

KH 35/SZ 20/CS 20

**section 2
vertical**

KH 35/SZ 20/CS 20

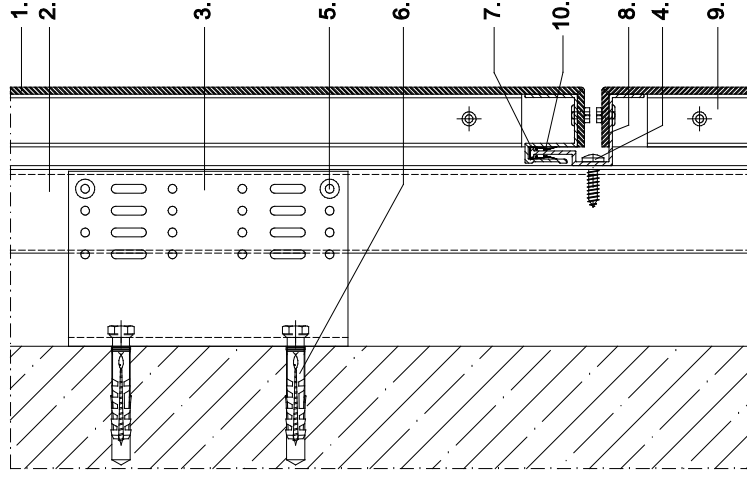

- | | |
|--------------------------|-----------------------------------|
| 1. Kassette | 1. cassette |
| 2. Hutprofil | 2. top hat profile |
| 3. Systema U-Wandkonsole | 3. Systema U-bracket |
| 4. Befestigungselement | 4. fixing element |
| 5. Verbindungsniet | 5. connecting rivet |
| 6. Verankerung | 6. fixing |
| 7. S-Profil | 7. S-profile |
| 8. Kassettenprofil | 8. section for connecting profile |
| 9. U-Profil | 9. U-profile |
| 10. Kunststoffclip | 10. plastic clip |

16.05

**Schnitt 3
Außenecke**

KH 35/SZ 20/CS 20

**section 3
external corner**

KH 35/SZ 20/CS 20

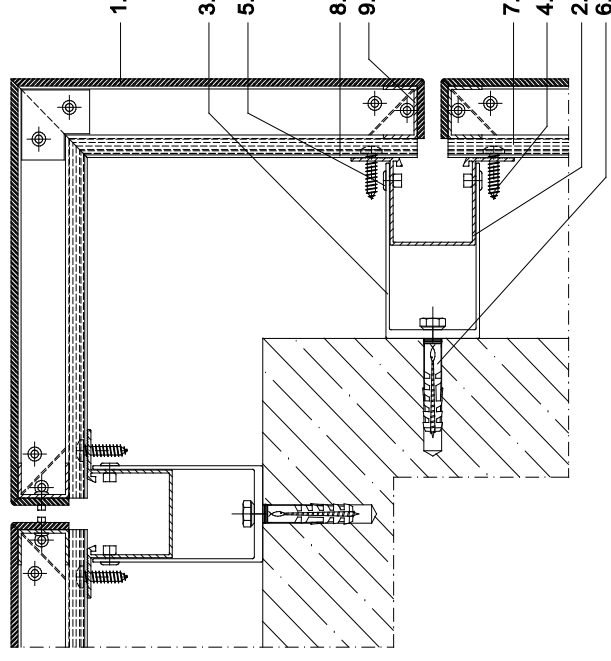

- | | |
|--------------------------|-----------------------------------|
| 1. Kassette | 1. cassette |
| 2. Hutprofil | 2. top hat profile |
| 3. Systema U-Wandkonsole | 3. Systema U-bracket |
| 4. Befestigungselement | 4. fixing element |
| 5. Verbindungsniet | 5. connecting rivet |
| 6. Verankerung | 6. fixing |
| 7. S-Profil | 7. S-profile |
| 8. Kassettenprofil | 8. section for connecting profile |
| 9. U-Profil | 9. U-profile |

16.06

Schnitt 4
Fensterlaibung
KH 35/SZ 20/CS 20

section 4
window recess
KH 35/SZ 20/CS 20

coupe 4
joue de fenêtre
KH 35/SZ 20/CS 20

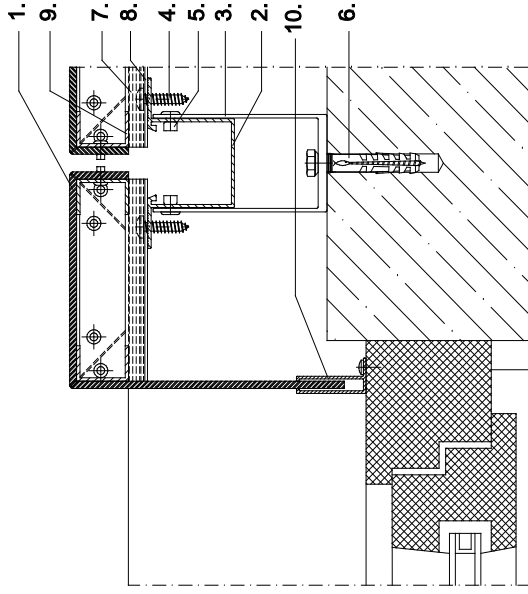

- 1. Kasette
- 2. Hutprofil
- 3. Systea U-Wandkonsole
- 4. Befestigungselement
- 5. Verbindungsniel
- 6. Verankerung
- 7. S-Profil
- 8. Kassettenprofil
- 9. U-Profil
- 10. Systea Stimmgabelprofil

- 1. cassette
- 2. top hat profile
- 3. Systea U-bracket
- 4. fixing element
- 5. connecting rivet
- 6. fixing
- 7. S-profile
- 8. section for connecting profile
- 9. U-profile
- 10. Systea F-profile

- 1. cassette
- 2. profil omega
- 3. étrier en U Systea
- 4. élément de fixation
- 5. jonction
- 6. ancrage
- 7. profil en S
- 8. profil de cassette
- 9. profil en U
- 10. profil F Systea (diapason)

Schnitt 5
Fensterbank
KH 35/SZ 20/CS 20

section 5
windowsill
KH 35/SZ 20/CS 20

coupe 5
bavette de fenêtre
extérieure
KH 35/SZ 20/CS 20

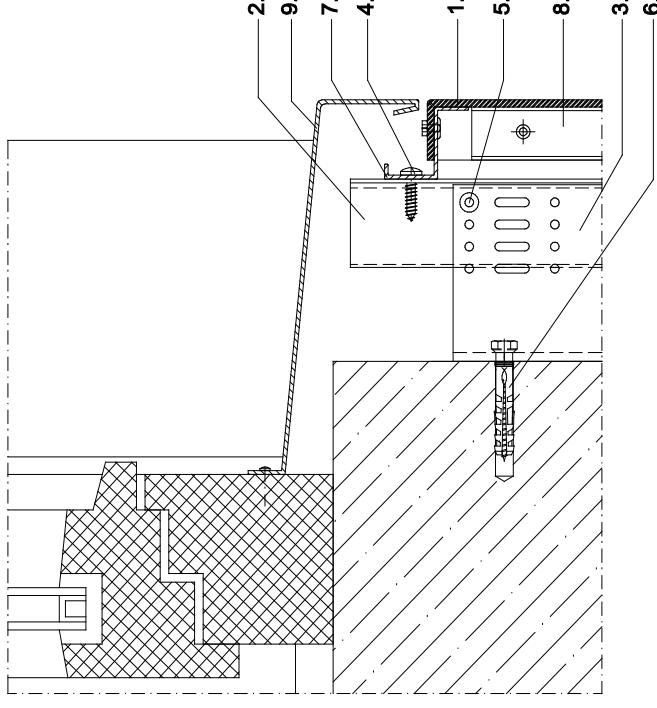

- 1. Kasette
- 2. Hutprofil
- 3. Systea U-Wandkonsole
- 4. Befestigungselement
- 5. Verbindungsniel
- 6. Verankerung
- 7. CS 20 Fensterabschlussprofil
- 8. U-Profil
- 9. Systea Fensterbank

- 1. cassette
- 2. top hat profile
- 3. Systea U-bracket
- 4. fixing element
- 5. connecting rivet
- 6. fixing
- 7. CS 20 closing-off profile
- 8. U-profile
- 9. Systea windowsill

- 1. cassette
- 2. profil omega
- 3. étrier en U Systea
- 4. élément de fixation
- 5. jonction
- 6. ancrage
- 7. CS 20 profil encadrement de fenêtre
- 8. profil en U
- 9. bavette Systea

Schnitt 6

Sockelabschluss
KH 35/SZ 20/CS 20

section 6

bottom closure
KH 35/SZ 20/CS 20

coupe 6

**tôle basse de
cafeutrement
(raccord de socle)**
KH 35/SZ 20/CS 20

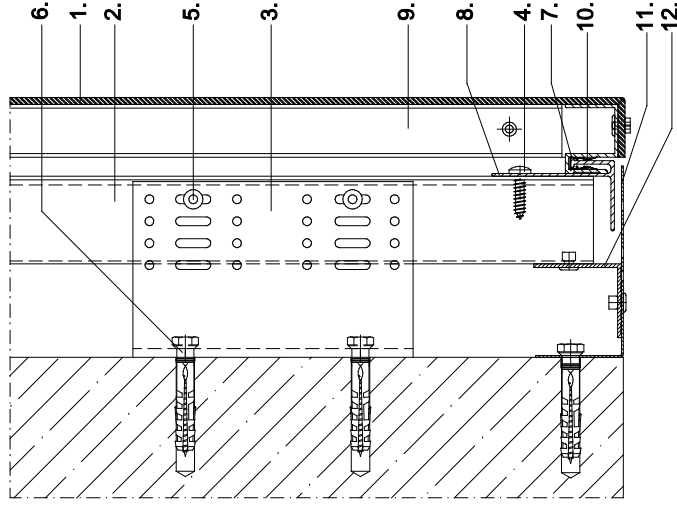

- | | |
|--------------------------------------|--------------------------|
| 1. Kassette | 1. cassette |
| 2. Hutprofil | 2. top hat profile |
| 3. Systea U-Wandkonsole | 3. Systea U-bracket |
| 4. Befestigungselement | 4. fixing element |
| 5. Verbindungsniet | 5. connecting rivet |
| 6. Verankerung | 6. fixing |
| 7. S-Profil | 7. S-profile |
| 8. KH-Sockelabschluss | 8. section for beginning |
| 9. U-Profil | 9. U-profile |
| 10. Kunststoffclip | 10. plastic clip |
| 11. Abschlusswinkel mit
Belüftung | 11. ventilated angle |
| 12. Winkelprofil | 12. angle profile |

Schnitt 7

Attikaabschluss
KH 35/SZ 20/CS 20

section 7

parapet
KH 35/SZ 20/CS 20

coupe 7

couvre-mur
KH 35/SZ 20/CS 20

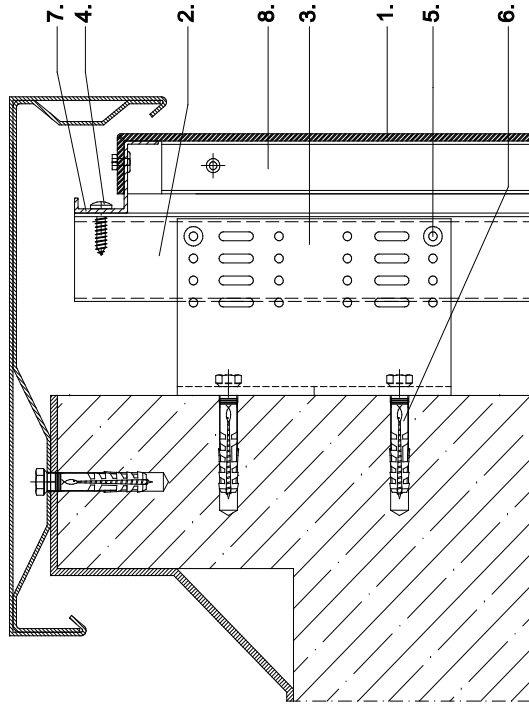

- | | |
|--------------------------------------|------------------------------|
| 1. Kassetten | 1. cassette |
| 2. Hutprofil | 2. top hat profile |
| 3. Systea U-Wandkonsole | 3. Systea U-bracket |
| 4. Befestigungselement | 4. fixing element |
| 5. Verbindungsniet | 5. connecting rivet |
| 6. Verankerung | 6. fixing |
| 7. CS 20 Fensterabschluss-
profil | 7. CS 20 closing-off profile |
| 8. U-Profil | 8. U-profile |

- | | |
|-------------------------------------------|-------------------------------------------|
| 1. cassette | 1. cassette |
| 2. profil omega | 2. profil omega |
| 3. équerre en U Systea | 3. équerre en U Systea |
| 4. élément de fixation | 4. élément de fixation |
| 5. jonction | 5. jonction |
| 6. ancrage | 6. ancrage |
| 7. CS 20 profil encadrement
de fenêtre | 7. CS 20 profil encadrement
de fenêtre |
| 8. profil en U | 8. profil en U |

Inhaltsverzeichnis Profilübersicht KH 35/SZ 20/CS 20 Contents profile list KH 35/SZ 20/CS 20 Index ensemble de profil KH 35/SZ 20/CS 20

Seite page page	Profile	profiles	profilés
16.12	horizontale Tragprofile, Clip Kassettenprofil 65/40,8mm. (Profil Nr. 785) S-Profil 30/39,3mm (Profil Nr. 784) KH-Sockelabschluss 70x40mm CS 20 Z-Profil 71/40,8mm S-Profil 35/39,3mm Versatz 5mm CS 20 Startprofil 70/40mm CS 20 Fensterabschlussprofil Kunststoffclip für Kassettenprofil Nr. 785 und CS 20 Z-Profil 71/40,8mm	horizontal carrier tracks, clip section for connecting profile 65/40,8mm (profile no. 785) S-profile 30/39,3mm (profile no. 784) section for beginning 70x40mm CS 20 Z-profile 71/40,8mm S-profile 35/39,3mm offset 5mm CS 20 section for beginning 70/40mm CS 20 closing-off profile plastic clip for section for connecting profile no. 785 and CS 20 Z-profile 71/40,8mm	rails porteurs, clip horizontaux, clip profil de cassette 65/40,8mm (profil no. 785) profil S 30/39,3mm (profil no. 784) profil raccord de socle 70x40mm CS 20 profil Z 71/40,8mm profil S 35/39,3mm déport 5mm CS 20 profil de début 70/40mm CS 20 profil encadrement clip de plastique pour profil de cassette no. 785 et CS 20 Z-Profil 71/40,8mm
16.13	Hutprofile Hutprofil 30/50/50/50/30mm (Profil Nr. 781) Hutprofil 40/50/50/50/40mm (Flanschstärke 3mm)	top hat profiles top hat profile 30/50/50/50/30mm (profile no.781) top hat profile 40/50/50/50/40mm (flange thickness 3mm)	profilés oméga profil oméga 30/50/50/50/30mm (profil no.781) profil oméga 40/50/50/50/40mm (épaisseur de la bride 3mm)
16.14	U-Wandkonsolen UH 40/55/40 -70/160mm UH 60/55/60 -70/160mm UH 80/55/80 -70/160mm UH 100/55/100 -70/160mm UH 120/55/120 -70/160mm UH 135/57/135 -70/160mm UH 150/57/150 -70/160mm UH 180/57/180 -70/160mm	U-brackets UH 40/55/40 -70/160mm UH 60/55/60 -70/160mm UH 80/55/80 -70/160mm UH 100/55/100 -70/160mm UH 120/55/120 -70/160mm UH 135/57/135 -70/160mm UH 150/57/150 -70/160mm UH 180/57/180 -70/160mm	équerrés en U UH 40/55/40 -70/160mm UH 60/55/60 -70/160mm UH 80/55/80 -70/160mm UH 100/55/100 -70/160mm UH 120/55/120 -70/160mm UH 135/57/135 -70/160mm UH 150/57/150 -70/160mm UH 180/57/180 -70/160mm

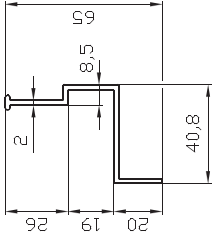
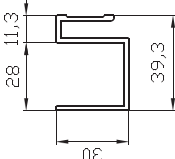
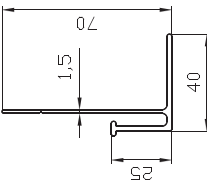
Profiltyp profile type type de profil	Länge (mm) length (mm) longueur (mm)	Material material matériel	Einzelpreis unit price prix unitaire
 <p>Kassettenprofil 65/40,8mm (Profil Nr. 785) section for connecting profile 65/40,8mm (profil no. 785) profil de cassette 65/40,8mm (profil no. 785)</p>	6000	EN AW 6063 T66	
 <p>S-Profil 30/39,3mm (Profil Nr. 784) S-profile 30/39,3mm (profil no. 784) profil S 30/39,3mm (profil no. 784)</p>	6000	EN AW 6063 T66	
 <p>KH-Sockelabschluss 70/40mm section for beginning 70/40mm profil raccord de socle 70/40mm</p>	6000	EN AW 6063 T66	

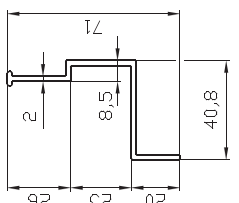
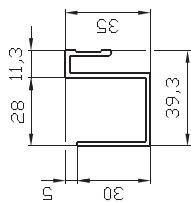
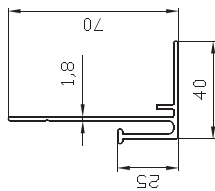
Profiltyp profile type type de profil	Länge (mm) length (mm) longueur (mm)	Material material matériel	Einzelpreis unit price prix unitaire
 <p>CS 20 Z-Profil 71/40,8mm CS 20 Z-profile 71/40,8mm CS 20 profil Z 71/40,8mm</p>	6000	EN AW 6063 T66	
 <p>S-Profil 35/39,3mm Versatz 5mm S-profile 35/39,3mm offset 5mm profil S 35/39,3mm déport 5mm</p>	6000	EN AW 6063 T66	
 <p>CS 20 Startprofil 70/40mm CS 20 section for beginning 70/40mm CS 20 profil de début 70/40mm</p>	6000	EN AW 6063 T66	

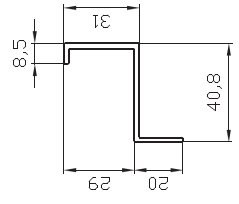
Profiltyp profile type type de profil	Länge (mm) length (mm) longueur (mm)	Material material matériel	Einzelpreis unit price prix unitaire
 <p>CS 20 Fensterabschlussprofil CS 20 closing-off profile CS 20 profil encadrement de fenêtre</p>	6000	EN AW 6063 T66	
<p>Kunststoffclip für Kassettenprofil Nr. 785 und CS 20 Z-Profil 71/40,8mm plastic clip for section for connecting profile no. 785 and CS 20 Z-profile 71/40,8mm clip de plastique pour profil de cassette no. 785 et CS 20 profil Z 71/40,8mm</p>			

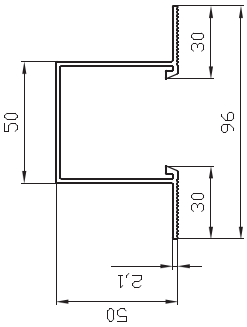
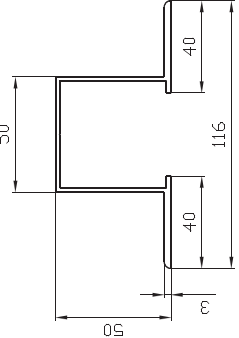
Profiltyp profile type type de profil	Länge (mm) length (mm) longueur (mm)	Material material matériel	Einzelpreis unit price prix unitaire
 <p>Hutprofil 30/50/50/50/30mm (Profil Nr. 781) top hat profile 30/50/50/50/30mm (profile no. 781) profil omega 30/50/50/50/30mm (profil no. 781)</p>	6000	EN AW 6063 T66	
 <p>Hutprofil 40/50/50/50/40mm (Flanschstärke 3mm) top hat profile 40/50/50/50/40mm (flange thickness 3mm) profil omega 40/50/50/50/40 (épaisseur de la bride 3mm)</p>	6000	EN AW 6063 T66	

Profiltyp profile type type de profil	Länge (mm) length (mm) longueur (mm)	Material material matériel	Einzelpreis unit price prix unitaire
 <p>Rückenlöcher gemäß Statik back holes in accordance to the static calculation perforation dorsale selon statique</p> <p>UH 40/55/40 - 70/160mm</p>	UH 40/55/40-70 UH 40/55/40-160	EN AW 6063 T66 EN AW 6063 T66	
 <p>Rückenlöcher gemäß Statik back holes in accordance to the static calculation perforation dorsale selon statique</p> <p>UH 60/55/60 - 70/160mm</p>	UH 60/55/60-70 UH 60/55/60-160	EN AW 6063 T66 EN AW 6063 T66	

Profiltyp profile type type de profil	Länge (mm) length (mm) longueur (mm)	Material material matériel	Einzelpreis unit price prix unitaire
 <p>Rückenhöcher gemäß Statik back holes in accordance to the static calculation perforation dorsale selon statique</p>	UH 80/55/80 -70	EN AW 6063 T66	
	UH 80/55/80-160	EN AW 6063 T66	
UH 80/55/80 - 70/160mm			
 <p>Rückenhöcher gemäß Statik back holes in accordance to the static calculation perforation dorsale selon statique</p>	UH 100/55/100-70	EN AW 6063 T66	
	UH 100/55/100-160	EN AW 6063 T66	
UH 100/55/100 - 70/160mm			

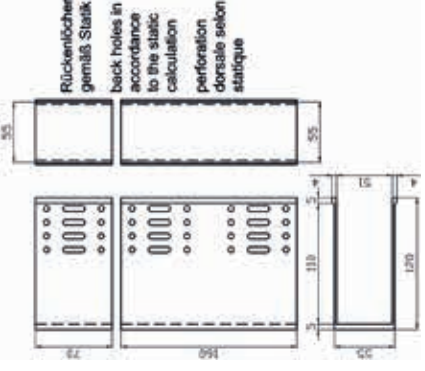
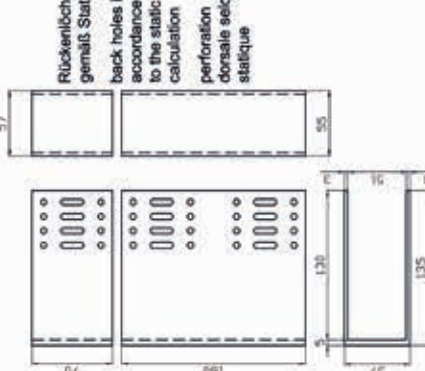
Profiltyp profile type type de profil	Länge (mm) length (mm) longueur (mm)	Material material matériel	Einzelpreis unit price prix unitaire
 <p>Rückenhöcher gemäß Statik back holes in accordance to the static calculation perforation dorsale selon statique</p>	UH120/55/120-70	EN AW 6063 T66	
	UH120/55/120-160	EN AW 6063 T66	
UH 120/55/120 - 70/160mm			
 <p>Rückenhöcher gemäß Statik back holes in accordance to the static calculation perforation dorsale selon statique</p>	UH135/57/135-70	EN AW 6063 T66	
	UH135/57/135-160	EN AW 6063 T66	
UH 135/57/135 - 70/160mm			

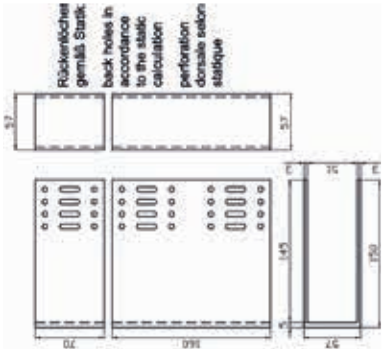
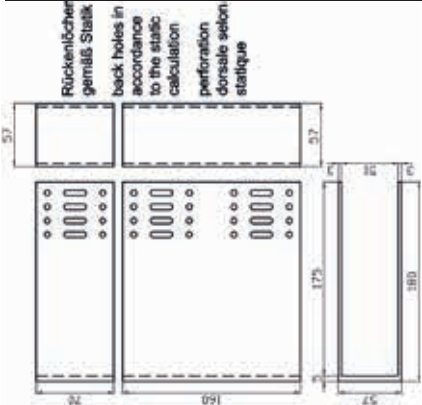
Profiltyp profile type type de profil	Länge (mm) length (mm) longueur (mm)	Material material matériau	Einzelpreis unit price prix unitaire
 <p data-bbox="774 1780 798 1993">UH 150/57/150 - 70/160mm</p>	<p data-bbox="343 1545 367 1668">UH150/57/150-70</p> <p data-bbox="438 1545 462 1668">UH150/57/150-160</p>	<p data-bbox="343 1400 367 1523">EN AW 6063 T66</p> <p data-bbox="438 1400 462 1523">EN AW 6063 T66</p>	
 <p data-bbox="1308 1780 1332 1993">UH 180/57/180 - 70/160mm</p>	<p data-bbox="877 1545 901 1668">UH180/57/180-70</p> <p data-bbox="989 1545 1013 1668">UH180/57/180-160</p>	<p data-bbox="877 1400 901 1523">EN AW 6063 T66</p> <p data-bbox="989 1400 1013 1523">EN AW 6063 T66</p>	

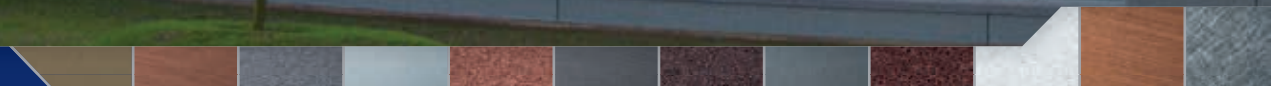

Systema[®]

Systema GmbH

Margarete-Steiff-Str. 6
D-24558 Henstedt-Ulzburg
Deutschland / Germany

Fon: +49 (0) 41 93 / 99 11-0
Fax: +49 (0) 41 93 / 99 11-49

info@systema.systems
www.systema.systems

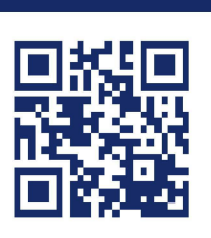
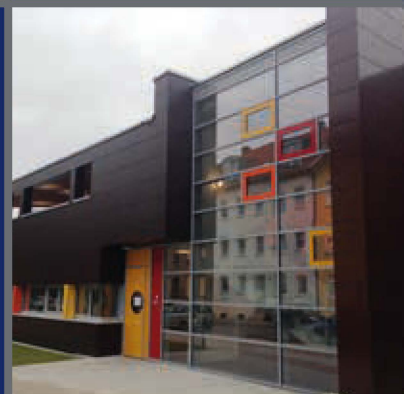

Bitte besuchen Sie uns für weitere
technische Informationen und
eine Vielzahl von Referenzen
im Internet: www.systema.systems