

# Systema®

## UKLA:

Unterkonstruktionen für keramische Fassadenplatten  
(Klammerbefestigung)

# 05



## ULKA:

holding tracks for ceramic wall panels  
(clip-on fixing)

## ULKA:

ossature pour des plaques céramiques  
(fixation crampe)

**UKLA:**  
Unterkonstruktionen für keramische Fassadenplatten  
(Klammerbefestigung)

**UKLA:**  
holding tracks for ceramic wall panels  
(clip-on fixing)

**UKLA:**  
ossature pour des plaques céramiques  
(fixation crampe)

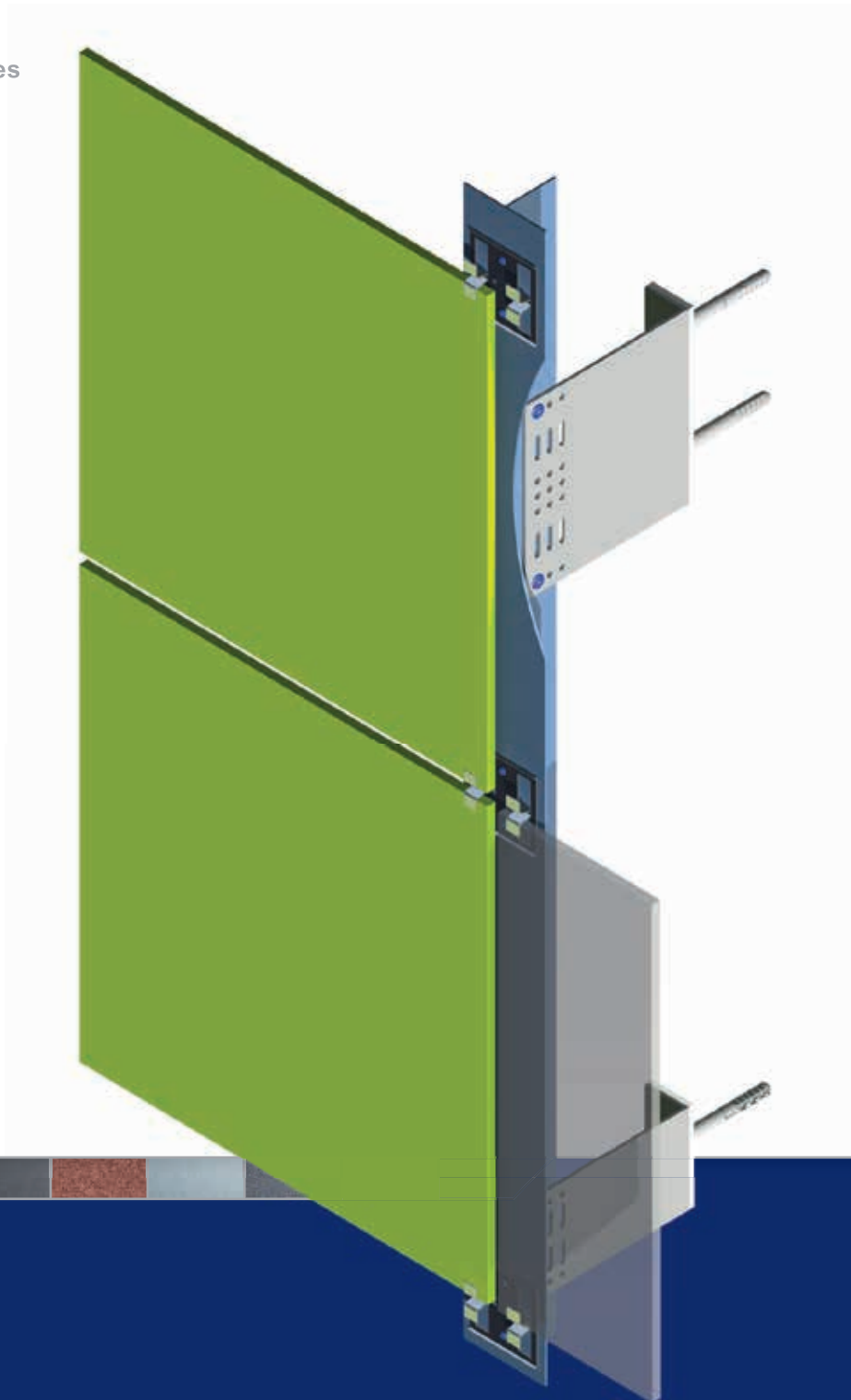

## Inhaltsverzeichnis Contents Index

System: **UKLA**  
Unterkonstruktionen für keramische Fassadenplatten  
(Klammerbefestigung)

System: **UKLA**  
holding tracks for ceramic wall panels (clip-on fixing)

Système: **UKLA**  
ossature pour des plaques céramiques (fixation crampe)

Seite page page			
05.02	Schnittübersicht	summary of sections	vue d'ensemble
05.03	Isometrie	isometric view	dessin isométrique
05.04	Schnitt horizontal	section horizontal	coupe horizontale
05.05	Schnitt vertikal	section vertical	coupe verticale
05.06	Innenecke	internal corner	coin intérieur
05.07	Außenecke	external corner	coin extérieur
05.08	Profilübersicht UKLA	profile list UKLA	ensemble de profil UKLA

**UKLA** für keramische  
Fassadenplatten  
(Klammerbefestigung)

**UKLA** for ceramic wall  
panels (clip-on fixing)

**UKLA** pour des plaques  
céramiques (fixation  
crampe)

Schnittübersicht

summary of sections

vue d'ensemble

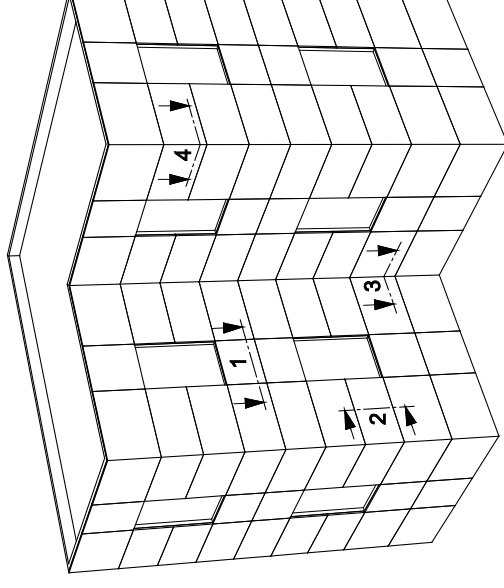

Schnitt 1: horizontal  
Schnitt 2: vertikal  
Schnitt 3: Innenecke  
Schnitt 4: Außenecke

section 1: horizontal  
section 2: vertical  
section 3: internal corner  
section 4: external corner

coupe 1: horizontale  
coupe 2: verticale  
coupe 3: coin intérieur  
coupe 4: coin extérieur

## UKLA

Unterkonstruktionen  
für keramische  
Fassadenplatten  
(Klammerbefestigung)

holding tracks for  
ceramic wall panels (clip-  
on fixing)

ossature pour des plaques  
céramiques (fixation  
crampe)

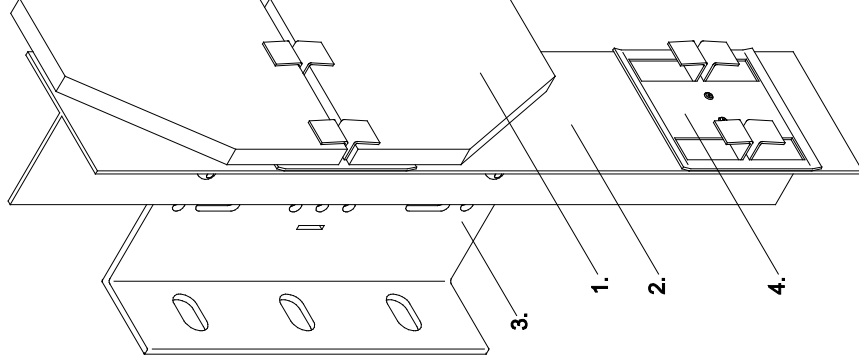

1. Fassadenbekleidung
2. senkrechtcs Tragprofil
3. Systea L-Wandkonsole
4. Klammer

1. cladding panel
2. vertical holding track
3. Systea L-bracket
4. clip

1. revêtement de façade
2. profil support vertical
3. équerre en L Systea
4. crampe

## Schnitt 1 horizontal

## coupe 1 horizontale

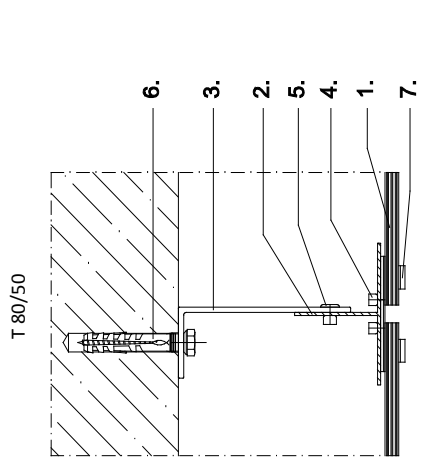

1. Fassadenbekleidung
2. senkrechtcs Tragprofil  
T 65/50 bzw. T 80/50
3. Systea L-Wandkonsole
4. Befestigungsniel
5. Verbindungsniel
6. Verankerung
7. Klammer

1. cladding panel
2. vertical holding track  
T 65/50 or T 80/50
3. Systea L-bracket
4. fixing rivet
5. connecting rivet
6. fixing
7. clip

1. revêtement de façade
2. profil support vertical  
T 65/50 ou T 80/50
3. équerre en L Systea
4. rivet de fixation
5. jonction
6. ancrage
7. crampe

Schnitt 2  
vertikal

section 2  
vertical

coupe 2  
verticale

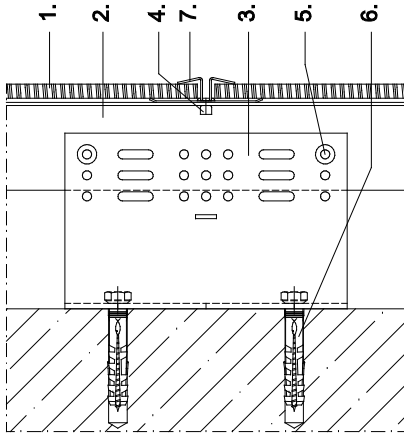

1. Fassadenbekleidung
2. senkrechtes Tragprofil  
T 65/50 bzw. T 80/50
3. Systema L-Wandkonsole
4. Befestigungsniel
5. Verbindungsniel
6. Verankerung
7. Klammer

1. cladding panel
2. vertical holding track  
T 65/50 or T 80/50
3. Systema L-bracket
4. fixing rivet
5. connecting rivet
6. fixing
7. clip

1. revêtement de façade
2. profil support vertical  
T 65/50 ou T 80/50
3. équerre en L Systema
4. rivet de fixation
5. jonction
6. ancrage
7. crampe

Schnitt 3  
Innenecke

section 3  
internal corner

coupe 3  
coin intérieur

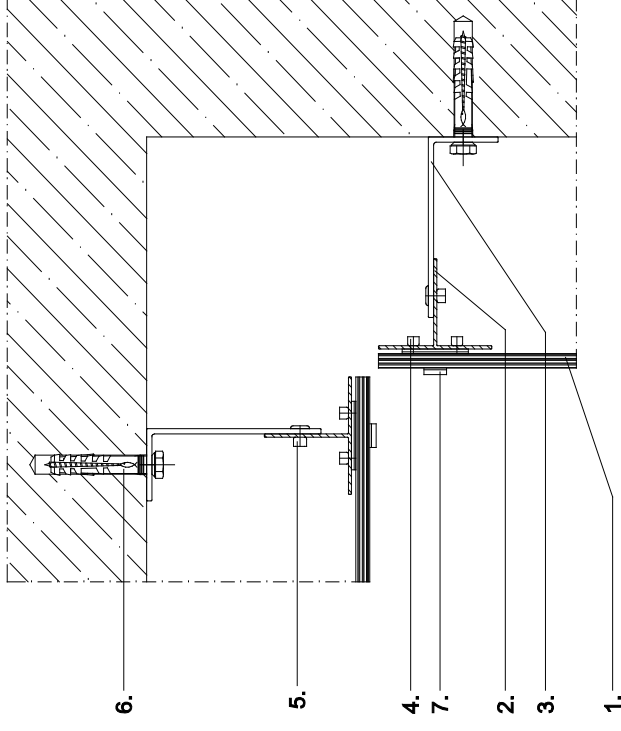

1. Fassadenbekleidung
2. senkrechtes Tragprofil  
T 65/50 bzw. T 80/50
3. Systema L-Wandkonsole
4. Befestigungsniel
5. Verbindungsniel
6. Verankerung
7. Klammer

1. cladding panel
2. vertical holding track  
T 65/50 or T 80/50
3. Systema L-bracket
4. fixing rivet
5. connecting rivet
6. fixing
7. clip

1. revêtement de façade
2. profil support vertical  
T 65/50 ou T 80/50
3. équerre en L Systema
4. rivet de fixation
5. jonction
6. ancrage
7. crampe

**Schnitt 4**  
Außenecke

**section 4**  
external corner

**coupe 4**  
coin extérieur

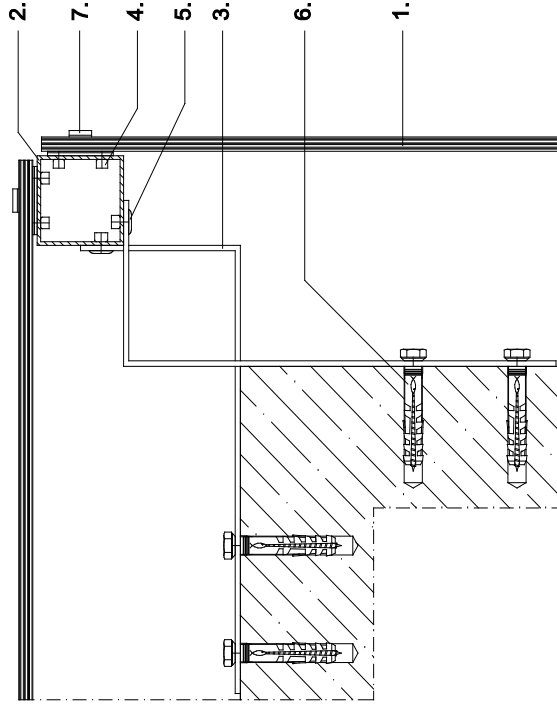

1. Fassadenbekleidung
2. Außeneckprofil
3. Anschlusswinkel
4. Befestigungsniel
5. Verbindungsniel
6. Verankerung
7. Klammer

1. cladding panel
2. external corner profile
3. connecting angle
4. fixing rivet
5. connecting rivet
6. fixing
7. clip

1. revêtement de façade
2. profil de coin extérieur
3. équerre de raccord
4. rivet de fixation
5. jonction
6. ancrage
7. crampe

Inhaltsverzeichnis Profilübersicht UKLA  
Contents profile list UKLA  
Index ensemble de profil UKLA

Seite page	Profile	profiles	profilés
05.09	<b>vertikale Tragprofile</b> T-Profil 65/50 Wanddicke 2mm T-Profil 80/50 Wanddicke 2mm	<b>vertical holding tracks</b> T-profile 65/50 wall thickness 2mm T-profile 80/50 wall thickness 2mm	<b>rails porteurs verticaux</b> profil T 65/50 épaisseur du mur 2mm profil T 80/50 épaisseur du mur 2mm
05.10	<b>L-Wandkonsolen</b> WB 0 - 85/160/250mm	<b>L-brackets</b> WB 0 - 85/160/250mm	<b>équerres en L</b> WB 0 - 85/160/250mm
05.11	WB 1-6 - 85/160/250mm	WB 1-6 - 85/160/250mm	WB 1-6 - 85/160/250mm
05.12	WB 7-9,5 - 85/160/250	WB 7-9,5 - 85/160/250	WB 7-9,5 - 85/160/250
05.13	WB 10-14 - 85/160/250mm	WB 10-14 - 85/160/250mm	WB 10-14 - 85/160/250mm

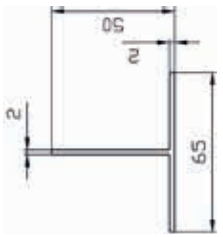
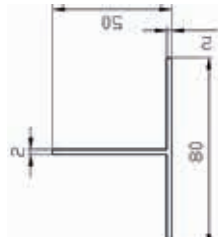
Profiltyp profile type type de profil	Länge (mm) length (mm) longueur (mm)	Material material matériau	Einzelpreis unit price prix unitaire
 <p>T-Profil 65/50 Wanddicke 2mm T-profile 65/50 wall thickness 2mm profilé T 65/50 épaisseur du mur 2mm</p>	5600	EN AW 6063 T66	
	6000		
 <p>T-Profil 80/50 Wanddicke 2mm T-profile 80/50 wall thickness 2mm profilé T 80/50 épaisseur du mur 2mm</p>	5600	EN AW 6063 T66	
	6000		

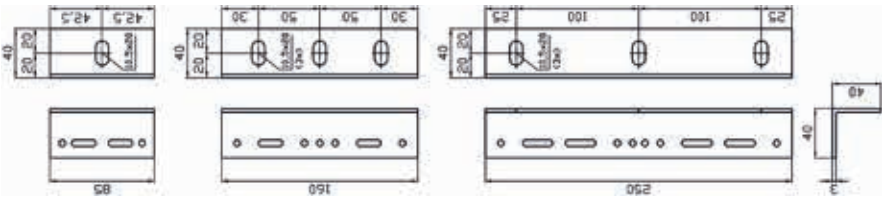

Profiltyp profile type type de profil	Länge (mm) length (mm) longueur (mm)	Material material matériau	Einzelpreis unit price prix unitaire
 <p>WB0 40/40/3-85 WB0 40/40/3-160 WB0 40/40/3-250</p>	WB0 40/40/3-85	EN AW 6063 T66	
	WB0 40/40/3-160	EN AW 6063 T66	
	WB0 40/40/3-250	EN AW 6063 T66	

WB0 40/40/3 - 85/160/250mm

Profiltyp profile type type de profil	Länge (mm) length (mm) longueur (mm)	Material material matériau	Einzelpreis unit price prix unitaire																
	WB1 40/60/3-85 WB2 40/80/3-85 WB3 40/100/3-85 WB4 40/120/3-85 WB5 40/140/3-85 WB6 40/160/3-85	EN AW 6063 T66																	
	WB1 40/60/3-160 WB2 40/80/3-160 WB3 40/100/3-160 WB4 40/120/3-160 WB5 40/140/3-160 WB6 40/160/3-160	EN AW 6063 T66																	
	WB1 40/60/3-250 WB2 40/80/3-250 WB3 40/100/3-250 WB4 40/120/3-250 WB5 40/140/3-250 WB6 40/160/3-250	EN AW 6063 T66			<table border="1"> <tr> <td>L-Wandkonsole L-bracket équerre en L</td> <td>Länge L length L longueur L</td> </tr> <tr> <td>WB1</td> <td>60 mm</td> </tr> <tr> <td>WB2</td> <td>80 mm</td> </tr> <tr> <td>WB3</td> <td>100 mm</td> </tr> <tr> <td>WB4</td> <td>120 mm</td> </tr> <tr> <td>WB5</td> <td>140 mm</td> </tr> <tr> <td>WB6</td> <td>160 mm</td> </tr> </table>	L-Wandkonsole L-bracket équerre en L	Länge L length L longueur L	WB1	60 mm	WB2	80 mm	WB3	100 mm	WB4	120 mm	WB5	140 mm	WB6	160 mm
	L-Wandkonsole L-bracket équerre en L	Länge L length L longueur L																	
	WB1	60 mm																	
	WB2	80 mm																	
	WB3	100 mm																	
	WB4	120 mm																	
	WB5	140 mm																	
	WB6	160 mm																	
	WB 1-6 - 85/160/250mm																		

Profiltyp profile type type de profil	Länge (mm) length (mm) longueur (mm)	Material material matériau	Einzelpreis unit price prix unitaire														
	WB7 40/180/4/3-85 WB8 40/200/4/3-85 WB8.5 40/210/4/3-85 WB9 40/220/4/3-85 WB9.5 40/230/4/3-85	EN AW 6063 T66															
	WB7 40/180/4/3-160 WB8 40/200/4/3-160 WB8.5 40/210/4/3-160 WB9 40/220/4/3-160 WB9.5 40/230/4/3-160	EN AW 6063 T66															
	WB7 40/180/4/3-250 WB8 40/200/4/3-250 WB8.5 40/210/4/3-250 WB9 40/220/4/3-250 WB9.5 40/230/4/3-250	EN AW 6063 T66			<table border="1"> <tr> <td>L-Wandkonsole L-bracket équerre en L</td> <td>Länge L length L longueur L</td> </tr> <tr> <td>WB7</td> <td>180 mm</td> </tr> <tr> <td>WB8</td> <td>200 mm</td> </tr> <tr> <td>WB8.5</td> <td>210 mm</td> </tr> <tr> <td>WB9</td> <td>220 mm</td> </tr> <tr> <td>WB9.5</td> <td>230 mm</td> </tr> </table>	L-Wandkonsole L-bracket équerre en L	Länge L length L longueur L	WB7	180 mm	WB8	200 mm	WB8.5	210 mm	WB9	220 mm	WB9.5	230 mm
	L-Wandkonsole L-bracket équerre en L	Länge L length L longueur L															
	WB7	180 mm															
	WB8	200 mm															
	WB8.5	210 mm															
	WB9	220 mm															
	WB9.5	230 mm															
	WB7-9.5 - 85/160/250mm																

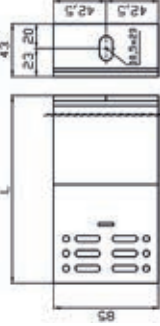
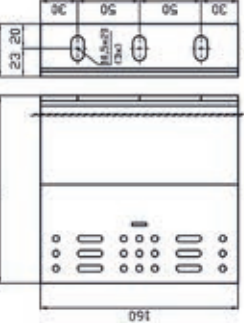
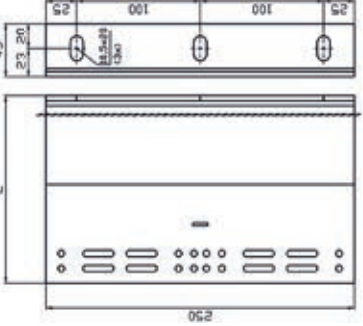

Profiltyp profile type type de profil	Länge (mm) length (mm) longueur (mm)	Material material matériau	Einzelpreis unit price prix unitaire												
	WB10 43/240/4/3-85 WB11 43/260/4/3-85 WB12 43/280/4/3-85 WB13 43/300/4/3-85 WB14 43/320/4/3-85	EN AW 6063 T66													
	WB10 43/240/4/3-160 WB11 43/260/4/3-160 WB12 43/280/4/3-160 WB13 43/300/4/3-160 WB14 43/320/4/3-160	EN AW 6063 T66													
	WB10 43/240/4/3-250 WB11 43/260/4/3-250 WB12 43/280/4/3-250 WB13 43/300/4/3-250 WB14 43/320/4/3-250	EN AW 6063 T66													
 <p data-bbox="1332 1794 1364 2004">WB10-14 - 85/160/250mm</p>			<table border="1"> <thead> <tr> <th>L-Wandkonsole L-bracket équerre en L</th> <th>Länge L length L longueur L</th> </tr> </thead> <tbody> <tr> <td>WB10</td> <td>240 mm</td> </tr> <tr> <td>WB11</td> <td>260 mm</td> </tr> <tr> <td>WB12</td> <td>280 mm</td> </tr> <tr> <td>WB13</td> <td>300 mm</td> </tr> <tr> <td>WB14</td> <td>320 mm</td> </tr> </tbody> </table>	L-Wandkonsole L-bracket équerre en L	Länge L length L longueur L	WB10	240 mm	WB11	260 mm	WB12	280 mm	WB13	300 mm	WB14	320 mm
L-Wandkonsole L-bracket équerre en L	Länge L length L longueur L														
WB10	240 mm														
WB11	260 mm														
WB12	280 mm														
WB13	300 mm														
WB14	320 mm														



# Systema®

## Systema GmbH

Margarete-Steiff-Str. 6  
D-24558 Henstedt-Ulzburg  
Deutschland / Germany

Fon: +49 (0) 41 93 / 99 11-0  
Fax: +49 (0) 41 93 / 99 11-49

info@systema.systems  
www.systema.systems

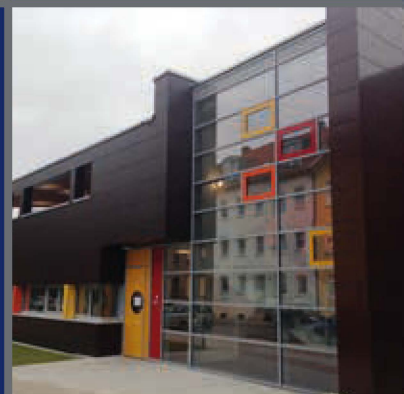

Bitte besuchen Sie uns für weitere  
technische Informationen und  
eine Vielzahl von Referenzen  
im Internet: [www.systema.systems](http://www.systema.systems)