



BI-FOLDING DOORS



CONTENTS

BI-FOLDING DOORS FROM SOLARLUX 04

FLEXIBLE DESIGN WITH BI-FOLDING DOORS 06

SYSTEMS TO SUIT ANY REQUIREMENT 24

The bi-folding door family

Windows for the bi-folding door family

The all-glass bi-folding door - SL 82

The bi-folding door for passive houses - SL 97

Non-insulated bi-folding doors - SL 35 and SL 45

SYSTEM FEATURES - COMPARISON 48

THE TECHNOLOGY OF THE BI-FOLDING DOOR 54

ABOUT SOLARLUX 72

BI-FOLDING DOORS FROM SOLARLUX

Generous living space in open-plan rooms

For more than 35 years, Solarlux has stood for the outstanding quality of versatile glazing solutions for public and private spaces. The bi-folding door has been the beating heart of the international, family-owned company right from the very beginning. Unlike traditional sliding doors, which can leave a large section of the opening covered by glass even when fully open, the individual elements of the bi-folding door gather up into a slender bundle of panels to one side. This produces generous glass fronts that can be opened across almost 100% of their large area while still offering maximum protection when closed.





DESIGN, MATERIAL,
OPENING - *freedom*
IN EVERY RESPECT

FLEXIBLE DESIGN WITH BI-FOLDING DOORS

SPACE FOR YOUR INDIVIDUAL TOUCH

Enjoy limitless possibilities

Thanks to its perfect functionality, the creative freedom offered by its high-quality materials, and the limitless possibilities for combining it with other elements, the bi-folding door is the ideal solution for a wide range of projects. Systems from the bi-folding door family, non-insulated variants and versions with high-performance thermal insulation for use in passive houses - with bi-folding doors, the possibilities are almost endless.



APPLICATIONS

The possibilities offered by a bi-folding door are almost limitless. It can be used as a substructure element for a wintergarden that can be opened across almost its entire width, as an entrance to a swimming pool, or used as an alternative to a traditional patio door or window. It is also suitable for public spaces, of course! Use it to build your shop entrance, glaze the VIP box in your stadium, or create a facade on your balustrade - whatever you're building, make the bi-folding door your first choice.



Bespoke solutions for the
wintergarden • Frisia, Netherlands



The alternative to
traditional windows
Hamburg, Germany



Bring air and light to your pool · Nottuln, Germany



Flexible use of space - the bi-folding door as a partition · Best, Netherlands



Glazing balconies, creating space · Hattingen, Germany

Flexibility for restaurants & business entrances
Olpe, Germany

Sports facilities with the perfect view
Mainz, Germany





MAXIMUM CREATIVE FREEDOM

Inwards or outwards, folding to the left and/or to the right - Solarlux bi-folding doors offer countless opening system possibilities. The individual glass elements can be opened or closed in just a few simple steps, across their whole area, while integrating tilt-and-turn panels and window elements can help you enjoy even more creative freedom.

CONFIGURATION EXAMPLES

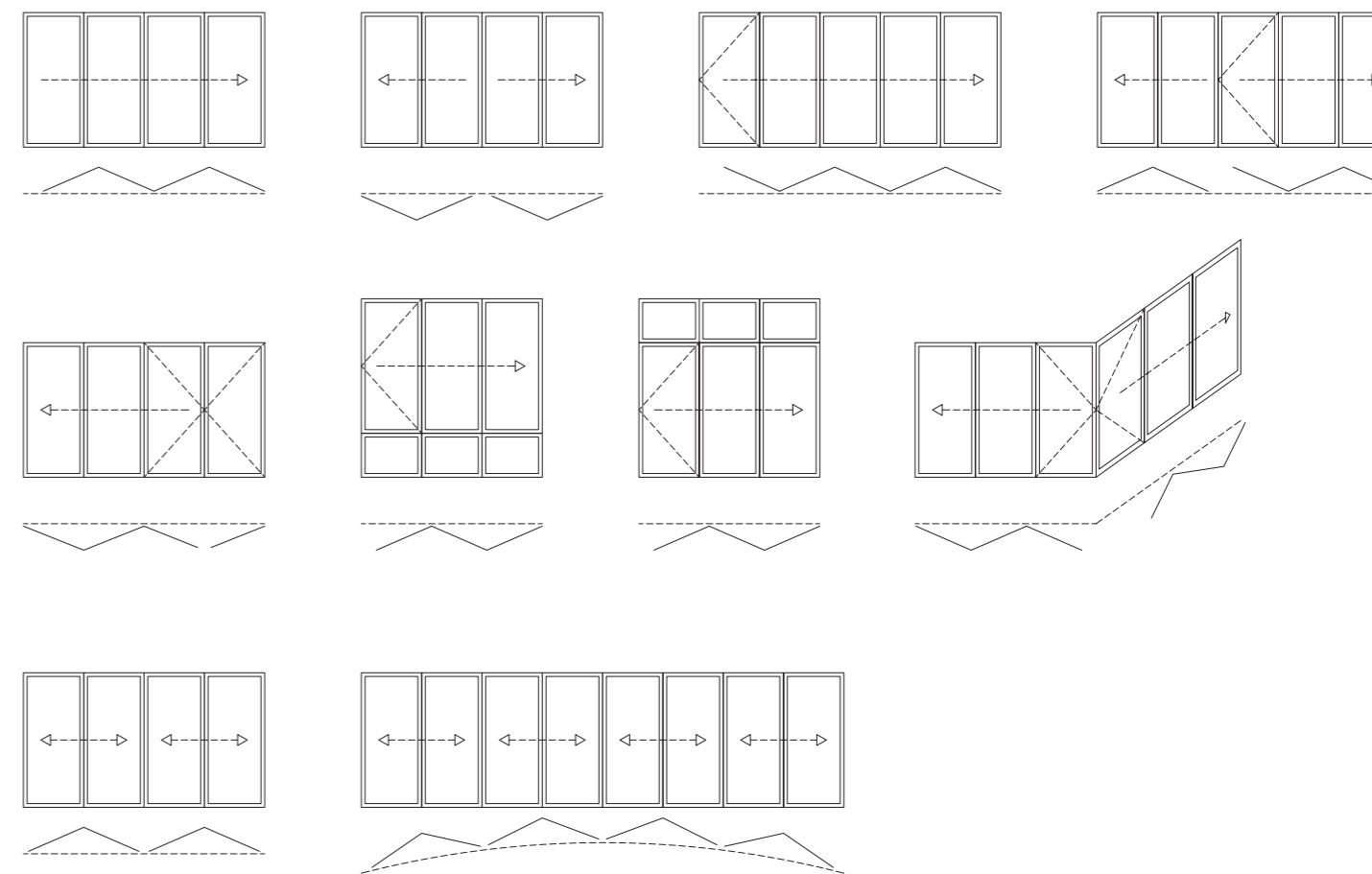

OUR MATERIALS

The high-quality aluminium and wood materials we use at Solarlux offer maximum creative freedom for your design - not to mention sustainability and durability. By combining these materials with our patented technology, we can make the Solarlux bi-folding door the perfect designer solution for your construction projects.



WOOD

The natural material for a cosy environment

The woods used by Solarlux are FSC® and PEFC™-certified, and are sourced from sustainable forestry. Both our certificates in this area set high standards, particularly in terms of sustainability, the environmental sustainability of the forest cultivation, the quality of the work and the social expertise of the forestry companies we work with. Our use of water-based finishes and energy-saving production with recycling of water and heat provide further evidence of the care with which we handle our natural resources.

This means that when you choose wood as your material, you are opting for a natural raw material that will provide individual and cosy living. Solarlux fulfil this preference in every respect. In addition to spruce and pine, we also offer a wide range of other timbers, depending on the grain. Our surface treatments are completely individual too. Whether you opt for a varnish, a hand-oiled surface or an opaque lacquer, Solarlux products are available in any colour of your choice, regardless of the product manufacturer.

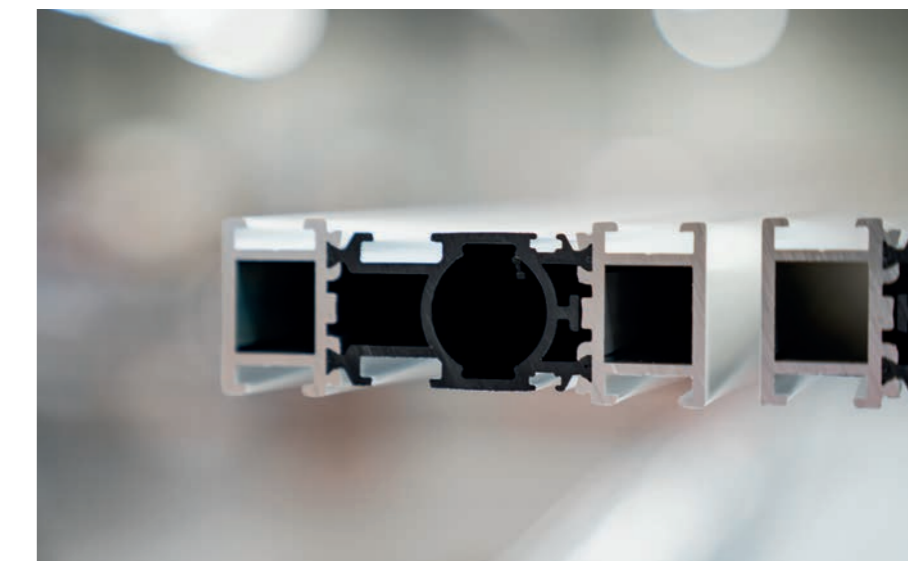

ALUMINIUM

The material for durability

Durable and almost completely zero-maintenance - this is the promise that aluminium keeps as a material. We also apply environmental awareness to our aluminium production - Solarlux is certified in accordance with the German A.U.F. Recycling Loop, which has confirmed that our aluminium is recycled in an environmentally conscious manner that saves on resources. All of our aluminium bi-folding doors are available in any colour - including special colours, Eloxal and DB.

OUR COLOURS

When you choose a Solarlux bi-folding door, you opt for individuality. Solarlux standard colour options, which include around 30 RAL colours, offer all the colours of the rainbow in matt and gloss finishes, at no extra cost. This allows every bi-folding door to match its building's interior and exterior design. We use our own in-house coating plant - one of the most modern in Europe - for top surface quality.

THE SOLARLUX WORLD OF COLOURS

 RAL 1015	 RAL 3011	 RAL 5003	 RAL 5008
 RAL 5014	 RAL 6005	 RAL 6009	 RAL 7004
 RAL 7006	 RAL 7015	 RAL 7016	 RAL 7021
 RAL 7024	 RAL 7035	 RAL 7038	 RAL 7039
 RAL 7040	 RAL 8017	 RAL 8019	 RAL 8022
 RAL 8077	 RAL 9001	 RAL 9003	 RAL 9004
 RAL 9005	 RAL 9006	 RAL 9007	 RAL 9010
 RAL 9011	 RAL 9016		



**THE SOLARLUX COATING IS CERTIFIED
TO INTERNATIONAL STANDARDS**

SOLARLUX SPECIAL COLOURS

Distinctive finishes for unique projects

It goes without saying that we also offer special DB, RAL and Eloxal colours, as well as special surface finishes (e.g. Tiger) for anyone looking to give their bi-folding doors a unique twist. We can make almost any wish come true - and we also offer coatings for special climate requirements (such as coastal properties).



THE ADVANTAGES OF THE SOLARLUX BI-FOLDING DOOR - AN OVERVIEW



MAXIMUM OPENING AND SLIM SIGHT LINES

The most important feature of the bi-folding door is its accordion-like folding technique, which allows it to be opened almost 100%. When closed, it boasts incredibly slim sight lines of just 99mm for the Ecoline and Highline systems across the panel joint.



SECURITY AND ANTI-BURGLARY PROTECTION

Bi-folding doors are high-quality and extremely sturdy. They fulfil the requirements of the standard European anti-burglary protection class RC2. This even applies to systems with an even number of panels - which is a benefit you won't find anywhere else on the market.



THERMAL AND SOUND INSULATION

A bi-folding door guarantees optimum thermal insulation and, depending on the system and packages, can also be used for passive houses. The soundproofing certification that can be achieved with these elements guarantees a quiet living space, even in bustling, built-up areas.



ACCESSIBILITY AND CONVENIENCE

Bi-folding doors are extremely convenient, with accessible floor tracks available with durable stainless steel carriages and rollers.



WHAT SOLARLUX OFFERS

- In-depth consultation and planning
- Patented technical details
- Durability and high quality
- Made in Germany
- Systems certified by national and international institutes
- Filigree sight lines of 99 mm in the panel butt joint for the Ecoline and Highline
- Maximum transparency and flexibility
- Sophisticated technical design and assembly
- Compliance with all applicable standards and specifications



INCREASED SECURITY

RC2 certified or comparable security equipment possible



A NEW DIMENSION FOR OPEN *living*

BI-FOLDING DOORS TO SUIT ANY REQUIREMENT



THE SYSTEM FAMILY

The bi-folding door family includes aluminium, wood and wood/aluminium systems, and offers decisive benefits: perfected technical details such as a patented carriage, TwinX® panel centring mechanism, accessible floor tracks and frame cladding are used for every system in the product range, while the specific requirements of the wood or aluminium profiles are also incorporated into the technical design.

This "system for all seasons" also comes with advantages in terms of assembly. Thanks to their sophisticated fitting technology and the fact that they all use the same components, every system in the bi-folding door family is quick to assemble and easy to adjust. This not only provides maximum room to manoeuvre, but also helps to ensure that your project goes off without a hitch.



**ECOLINE, HIGHLINE, WOODLINE
AND COMBILINE: THE NEXT
GENERATION OF SYSTEMS**

ECOLINE AND HIGHLINE

ALUMINIUM

Incredibly slim sight line, patented technology

Despite their differences in overall depth (67 mm and 84 mm), both our thermally insulated bi-folding door systems, Ecoline and Highline, boast a slim sight line of 99 mm at the panel butt joint. This is thanks to the heart of the bi-folding door: the bionicTURTLE®, a multi-functional break profile that combines a range of technical details. Its shape helps to keep profiles extremely slim - even when using large and heavy panels. It also houses the locking mechanism and fittings that ensure perfect insulation.

AWARD-WINNING DESIGN

The Ecoline and Highline are more than merely functional - they also boast an impressive design, as has been confirmed by renowned international experts. This is reflected in the fact that the new bi-folding door has already won four awards.



ECOLINE

- Overall depth: 67 mm
- Sight line: 99 mm
- Glass thickness: 5 - 36 mm
- $U_w \geq 1.1 \text{ W/m}^2\text{K}$
- Panel width: Up to 1 m;
- Panel height: Up to 3 m
- Panel weight: Up to 90 kg

HIGHLINE

- Overall depth: 84 mm
- Sight line: 99 mm
- Glass thickness: 22 - 60 mm
- $U_w \geq 0.8 \text{ W/m}^2\text{K}$
- Panel width: Up to 1.1 m;
- Panel height: Up to 3.5 m
- Panel weight: Up to 110 kg





WOODLINE

WOOD

Cosy living with an individual touch

A cosy yet modern living space: The Woodline bi-folding door is the perfect choice for those who want the best of both worlds. Its profiles are made from multi-laminated, high-quality wood, while a special panel corner joint gives the system additional stability. The sub-frame comprises an aluminium structure that is completely clad with solid-wood sections, inside and out. The slender sight line in the panel butt joint - just 143 mm - ensures maximum transparency when the doors are closed, in keeping with your natural approach to living.

WOODLINE

- Overall depth: 86 mm
- Sight line: 143 mm
- Glass thickness: 28 - 48 mm
- $U_w \geq 1.0 \text{ W/m}^2\text{K}$
- Panel height: Up to 2.8 m
- Panel weight: Up to 100 kg



GERMAN
DESIGN
AWARD
WINNER
2019

COMBILINE

WOOD/ALUMINIUM

The perfect combination for a weatherproof solution

With its wood/aluminium profiles, the Combine bi-folding door provides maximum weatherproofing. This system maintains the overall panel profile depth of 86 mm, despite the square aluminium cover placed over the wood profile. The sub-frame comprises an aluminium structure that is faced with solid-wood sections on the inside of the frame. The seal encompasses two continuous sealing levels, so optimum drainage is guaranteed.

COMBILINE

- Overall depth: 86 mm
- Sight line: 147 mm
- Glass thickness: 28 - 52 mm
- $U_w \geq 1.1 \text{ W/m}^2\text{K}$
- Panel height: Up to 2.8 m
- Panel weight: Up to 100 kg
- Exceptionally weatherproof thanks to external aluminium covers



WINDOWS FOR THE BI-FOLDING DOOR FAMILY

Turn-and-tilt, tilting and fixed elements

We offer a range of window elements to match our bi-folding doors: the Ecoline and Highline aluminium bi-folding doors, the wooden Woodline and the wood/aluminium Combiline model. You can integrate a traditional tilt-and-turn window, a motorised tilt fanlight or fixed elements wherever you want in your system. The benefits: The profiles of the windows will match your bi-folding door perfectly, creating a uniform aesthetic for the entire combination of bi-folding door and windows. The window and folding elements are treated using the same coating or painting procedure in order to ensure that there are no differences in shade or hue between the different elements.



ECOLINE & HIGHLINE *Aluminium*

Our aluminium window elements are available in fixed, tilting and turn-and-tilt variants, with window panels that open inward to either the right or the left.



- Overall frame depth: 67 mm (Ecoline) or 84 mm (Highline)
- Minimum panel sight line: 78.5 mm or 100 mm with frame
- Fixed, tilt and turn-and-tilt elements available
- RC2/RC2N version available as an option
- Available with up to four sealing levels

WOODLINE *Wood*

Our wooden window profiles are made using multi-laminated, high-quality wooden beams. Thanks to their form-fitted Plug-Tec corner joints and additional screw fittings, the panels are extremely stable.



- Overall frame depth: 91 mm in the panel and sub-frame profile
- All-round sight line: 72 mm for fixed window; 100 mm for element with panel
- True divided light glazing bar with range of sight lines available as an option

COMBILINE *Wood/aluminium*

Our thermally insulated window system with an overall frame depth of 89.5 mm in the sub-frame profile is fitted with a square aluminium cover on the outside, and available with a choice of three profile designs. The sight lines of the panel frames vary depending on which design variant you choose for your aluminium cover.



- **Minimum profile**
- Panel frame almost completely covered by a square aluminium cover (sight line 88 mm)
- 10 mm all-round panel line visible in closed position



- **Flush-mounted profile**
- Exterior wooden frame completely faced with an angular aluminium cover (68 mm sight line)
- Panel sheathed by a box-shaped profile (5 mm sight line)
- Continuous flush mounting between panel and frame on the exterior

TAKE A LOOK INSIDE THE BI-FOLDING DOOR FAMILY

Inter-system harmony was one of our greatest concerns when developing the bi-folding door family: all four variants use the patented technical details described in the following pages. The benefits of this approach are reflected in both the fitting process for the bi-folding doors and their ease of operation.

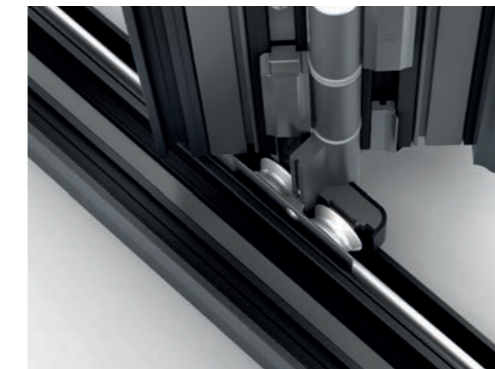

CARRIAGE

Optimum load transfer

The stainless steel carriage with double-layered grooved ball bearings runs smoothly and quietly. It offers optimum load transfer onto its carriage and running track, allowing it to carry even heavy panels with little effort. The entire stainless steel sliding mechanism is extremely low-maintenance and non-wearing.

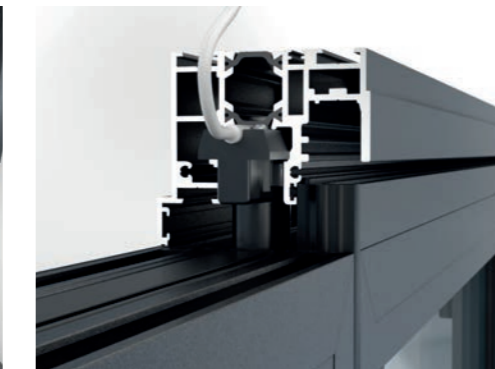

LOCKING MECHANISM

Certified to security standard RC2

With its 24 mm upward and downward stroke in the frame, the Solarlux special gearbox provides a high level of security. It can be fitted with a reed-contact lock monitoring system and concealed wiring, available in RC2 or RC2N design.



TWINX®

Uniform panel design

The TwinX® concealed panel centring mechanism stands for uniform, homogeneous panel design (only the top and bottom hinges are visible). Keeping the panels centrally aligned with one another, it provides stability even when the system is subjected to high wind loads, and ensures that the joint alignment remains even. It also ensures that the sealing levels remain unchanged and uninterrupted throughout the system.



PANEL CATCH

Secure opening and closing

The "Comfort Snap" functional panel catch offers incredibly convenient operation when operating your bi-folding door. The swing panel can be opened and closed easily and securely by following the set sequence: once fully opened, the swing panel snaps onto the next panel, and is not released until it is closed again.

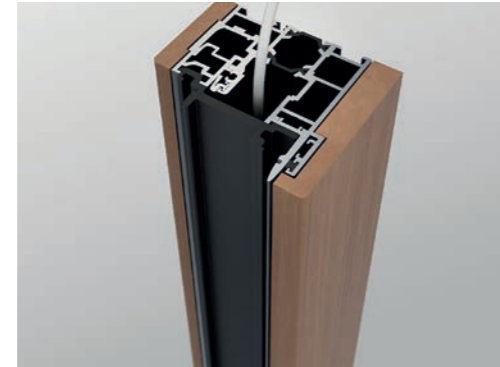

FRAME COVER

Homogeneous sight lines

The black polyamide frame cover conceals all the fixtures, and the hollow space between the base of the profile and the cover can be used to lay concealed cables or house an additional convection chamber interruption seal.



IMPACT PROTECTION

A safe step

The Solarlux 3s aluminium impact protection clips into the floor track. It also keeps dirt out of the running track, and can be removed again easily if required.



CLEANING PIN

Top user-friendliness

The cleaning pin with "Easy Clean Technology" is convenient to lock and unlock, and makes cleaning the outer faces of the panels easy, even on the upper floors of tall buildings. Thanks to its new locking technology, it is impossible to operate incorrectly. The new safety lock prevents the hinge pin from falling out.



ADJUSTABLE PROFILE

Quick compensation

The adjustable side profile provides a quick and easy means of compensating for panel tolerances. The width of the panels is adjusted in the sub-frame, and this operation no longer needs to be carried out separately for each panel. As a result, the seal contact pressure between the panels is maintained at every point. The adjustable profile does not interrupt the sealing level.



FITTING PANELS

Optimum load transfer

The stainless steel fittings offer optimum load transfer in the most stable section of the laminated profile when fitting the frame. A sealing cushion behind the screw head seals the mounting hole to prevent any moisture ingress.



A NEW CLASS OF ACCESSORY

FITTING OPTIONS

Equipment packages are available for the entire bi-folding door family. By choosing the appropriate package, customers can place greater focus on aspects such as security, thermal or sound insulation, lighting, or convenience. This range of options for picking and mixing individual options to personalise your system makes the bi-folding door even more attractive.

SHADING

Solarlux pleated blinds are great at both shading you from sunlight and protecting your privacy. They can be adjusted up and down to any position or length, making them the perfect solution. They are available as single or two-part elements, and can be easily positioned simply by moving them up or down. They also offer one other great advantage: they can be fitted without the hassle of drilling or gluing, by simply clipping them into the profiles. They can even be easily retrofitted to any existing bi-folding door.

FLOOR TRACKS WITH LIGHTING

In many types of floor track, the 3s impact protection can be fitted with LED lights and concealed cabling. The lighting creates a great ambience, especially in the evening. What's more, this orientation aid also ensures that the access and entry area is easy to find for the visually impaired, as required by German standard DIN 18040.





THE SL 82 ALL-GLASS BI-FOLDING DOOR

ALUMINIUM

Award-winning design with a unique look

The flush outer design of its glass surface gives the SL 82 all-glass, aluminium bi-folding door a unique look that will appeal to even the most discerning design fans. It is the winner of the Red Dot Award: Product Design and the iF Product Design Award.

THE SL 82 IN BRIEF:

- An all-glass aluminium system
- Stepped-edge glazing conceals profile to create an all-glass look
- Glass edges protected by all-round aluminium panel frame with slim 8 mm sight line
- Optimum thermal insulation in accordance with the latest version of the German Building Energy Act (GEG)
- Sturdy, hollow-chamber profiles with quadruple-rolled break profiles
- Built-in convenience lock for high-level security
- Elements can be opened and closed from the outside using through-glass lever door handle and profile cylinder
- Flush floor track without rebate for accessible living

THE SL 97 BI-FOLDING DOOR

WOOD/ALUMINIUM

Thermal insulation for maximum energy savings

The great thermal insulation offered by the wood/aluminium SL 97 will help to bring your home closer to passive house standards. Laminated wood profiles with a overall depth of 96 mm, an additional layer of insulation, and triple glazing result in a thermal transmittance (U_w) of $\geq 0.8 \text{ W/m}^2 \text{ K}$.

THE SL 97 IN BRIEF:

- Wood/aluminium profile system with high-performance thermal insulation
- U_w of $\geq 0.8 \text{ W/m}^2 \text{ K}$
- Laminated woods with rear-ventilated aluminium covers and additional insulation layer
- System fitted with underlaid running gear as standard
- Running tracks and guide rails built flush into the system
- All designs come with swing panel
- Panels fold either inwards or outwards and slide to either left or right





THE SL 35 & SL 45 BI-FOLDING DOORS

ALUMINIUM

Wind & weather protection for balconies & patios

Depending on their requirements, some projects are also suited to the use of non-insulated bi-folding doors. These elements can be used as balcony glazing for non-insulated facades, glazing for under glass canopies, or in any situation where thermal insulation is not important, e.g. as internal partitions.

THE SL 35 & SL 45 IN BRIEF:

- Non-insulated aluminium systems
- Overall depth: 35 mm/45 mm
- No upstream running or guide rails
- Low-wear, even after 10,000 operations
- Flush floor track without rebate for accessible living
- Two all-round sealing levels to protect against wind and rain

SL 35 features

- Cleaning pin for cleaning the outer faces of the panels on upper levels
- Highly sturdy thanks to tongue and groove joint and sturdy corner joints

SL 45 features

- One section of the panel opens inwards, the other outwards
- System can be segmented up to 22.5°



GREAT DIVERSITY REQUIRES *clarity*

SYSTEM FEATURES - COMPARISON



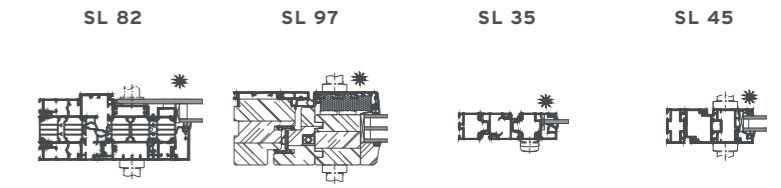
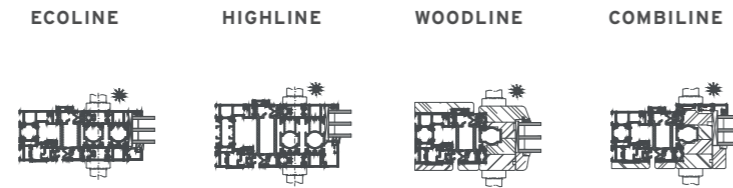

OVERVIEW OF THE BI-FOLDING DOOR SYSTEMS



	ECOLINE	HIGHLINE	WOODLINE	COMBILINE		SL 82	SL 97	SL 35	SL 45
Material					Material				
Aluminium	●	●	○	○	Aluminium	●	○	●	●
Wood	○	○	●	○	Wood	○	○	○	○
Wood/aluminium	○	○	○	●	Wood/aluminium	○	●	○	○
Profile					Profile				
Thermally insulated	●	●	●	●	Thermally insulated	●	●	○	○
Non-insulated	○	○	○	○	Non-insulated	○	○	●	●
Overall depth	67 mm	84 mm	86 mm	86 mm	Overall depth	80 mm	96 mm	35 mm	45 mm
Panel butt joint sight line	99 mm	99 mm	143 mm	147 mm	Panel butt joint sight line	104 mm	184 mm	100 mm	117.5 mm
Frame height	0-72 mm	0-72 mm	0-72 mm	0-72 mm	Frame height	12-97 mm	45-108 mm	5-70 mm	5-64 mm
Glazing					Glazing				
Glass thicknesses	5-36 mm	22-60 mm	28-48 mm	28-52 mm	Glass thicknesses	30-38 mm	24-46 mm	5-18 mm	5-20 mm
Thermal insulation value					Thermal insulation value				
Thermal transmittance in accordance with DIN EN ISO 10077-1	≥ 1.1 W/m²K	≥ 0.8 W/m²K	≥ 1.0 W/m²K	≥ 1.1 W/m²K	Thermal transmittance in accordance with DIN EN ISO 10077-1	≥ 1.2 W/m²K	≥ 0.8 W/m²K	-	-
Panels					Panels				
Max. panel dimensions (max. width x max. height)	1 m x 3 m	1.1 m x 3.5 m	1 m x 2.8 m	1 m x 2.8 m	Max. panel dimensions (max. width x max. height)	1 m x 2.5 m	1 m x 2.8 m	0.9 m x 2.5 m	1.1 m x 2.8 m
Panel weight	90 kg	110 kg	100 kg	100 kg	Panel weight	70 kg	100 kg	65 kg	100 kg
Sealing					Sealing				
Resistance to wind load in accordance with DIN EN 12210	B4	B4	C3	C3	Resistance to wind load in accordance with DIN EN 12210	B4	C3	-	-
Water tightness in accordance with DIN EN 12208	8A	9A	7A	7A	Water tightness in accordance with DIN EN 12208	7A	7A	4A	4A
Air permeability in accordance with DIN EN 12207	3	3	3	3	Air permeability in accordance with DIN EN 12207	3	3	2	2
Burglar resistance in accordance with DIN EN 1627-1630	RC2/RC2N	RC2/RC2N	RC2/RC2N	RC2/RC2N	Burglar resistance in accordance with DIN EN 1627-1630	-	-	-	-
Sound reduction index in accordance with DIN EN ISO 10140-2	40 dB	45 dB	42 dB	42 dB	Sound reduction index in accordance with DIN EN ISO 10140-2	NPD	NPD	31 dB	25 dB
Resistance to repeated opening and closing in accordance with DIN EN 12400	2	2	2	2	Resistance to repeated opening and closing in accordance with DIN EN 12400	2	2	2	2

OVERVIEW OF THE WINDOW SYSTEMS

Next is an overview of all our window systems and options so that you can compare them with just a quick glance.

	ECOLINE WINDOW SYSTEM	HIGHLINE WINDOW SYSTEM	WOODLINE WINDOW SYSTEM	COMBILINE WINDOW SYSTEM
				
Material				
Aluminium	●	●	○	○
Wood	○	○	●	○
Wood/aluminium	○	○	○	●
Profile				
Overall frame depth	67 mm	84 mm	91 mm	89 mm
Overall panel depth	77 mm	94 mm	91 mm	96 mm (MP), 105 mm (FP)
Frame finished element sight line	0 - 72 mm	0 - 87 mm	0 - 72 mm/0 - 100 mm	0 - 62 mm/0 - 101 mm
Panel sight line	78.5 mm	78.5 mm	72 mm	72 mm (FP, MP)
Panel butt joint sight line	173 mm	173 mm	160 mm	170 mm
Frame height	Max. 2,400 mm	Max. 2,400 mm	Max. 2,400 mm	Max. 2,400 mm
Glazing				
Glass thicknesses	5 - 36 mm can be used	22 - 60 mm can be used	28 - 48 mm can be used	28 - 52 mm can be used
Dry glazing	●	●	●	●
Thermal insulation value				
Thermal transmittance in accordance with DIN EN ISO 10077-1	$U_w \geq 1.17 \text{ W/m}^2\text{K}$	$U_w \geq 0.88 \text{ W/m}^2\text{K}$	$U_w \geq 1 \text{ W/m}^2\text{K}$	$U_w \geq 1.1 \text{ W/m}^2\text{K}$
Panels				
Panel weight	Max. 130 kg	Max. 130 kg	Max. 130 kg	Max. 130 kg
Panel width	Min. 800 mm not incl. wind and impact loads	Min. 800 mm not incl. wind and impact loads	Min. 400 mm not incl. wind and impact loads	Min. 400 mm not incl. wind and impact loads
Special sizes available on demand	●	●	●	●
Sealing				
Resistance to wind load in accordance with DIN EN 12210	B4	B4	C3	C3
Water tightness in accordance with DIN EN 12208	8A	9A	9A	9A
Air permeability in accordance with DIN EN 12207	3	3	4	4
Burglar resistance in accordance with DIN EN 1627-1630	RC2/RC2N	RC2/RC2N	RC2/RC2N	RC2/RC2N
Sound reduction index in accordance with DIN EN ISO 10140-2	32 dB	32 dB	32 dB	32 dB
Resistance to repeated opening and closing in accordance with DIN EN 12400	2	2	2	2

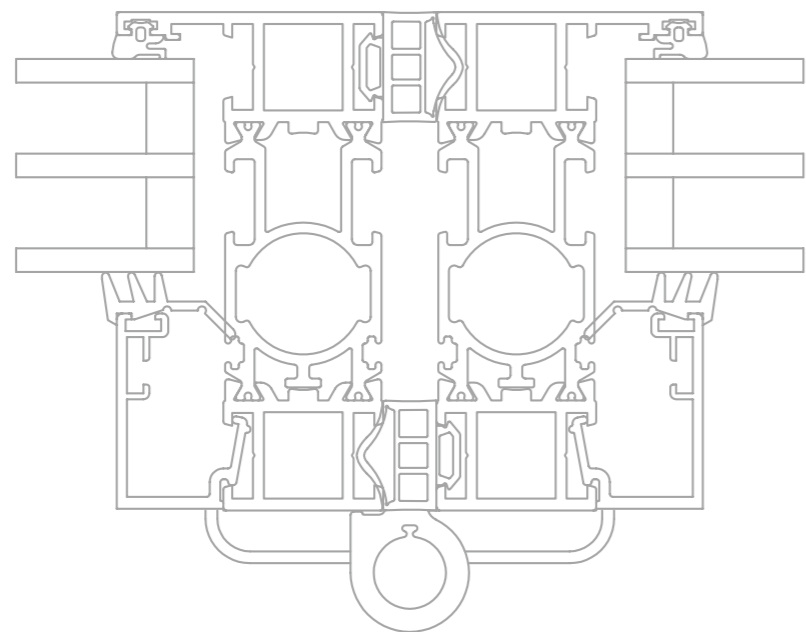

THE TECHNOLOGY OF THE BI-FOLDING DOOR AND WINDOWS

THE BI-FOLDING DOOR FAMILY

Detail sections: Ecoline/Highline - Aluminium

Detail sections: Woodline, Combiline - Wood, Wood/aluminium

Floor track variants

Frame solution for element combinations

Detail sections: Windows

Window sill joints

SL 82

Detail sections: All-glass/aluminium

SL 97

Detail sections: Wood/aluminium

SL 35 AND SL 45

Detail sections: Aluminium

THE BI-FOLDING DOOR FAMILY

Detail sections: Ecoline – Aluminium

Vertical section

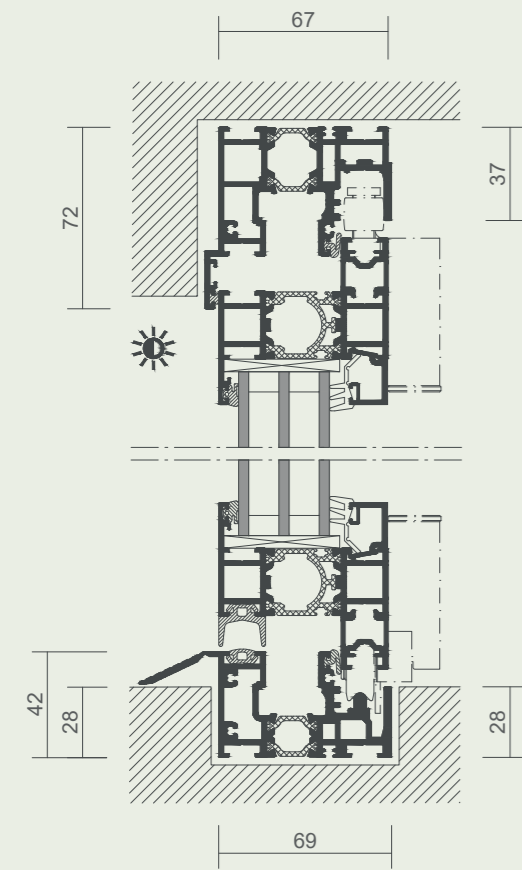

Horizontal section

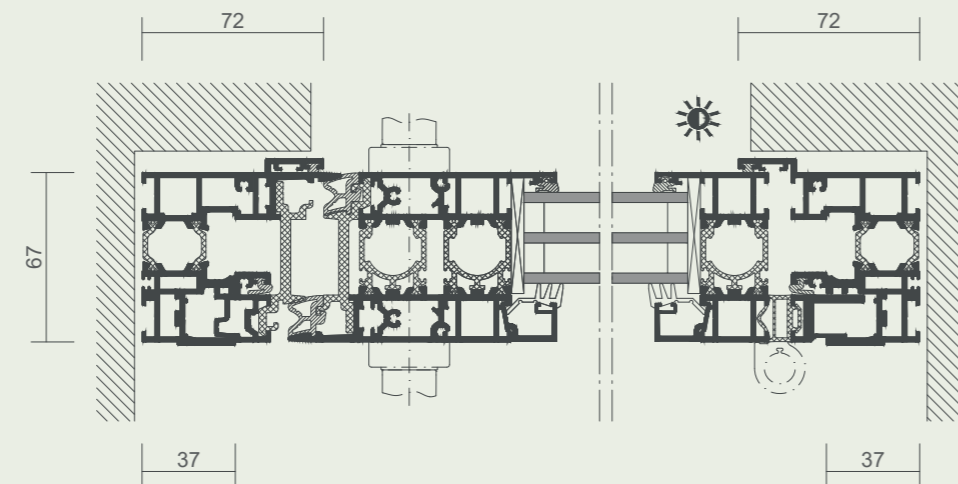

Detail sections: Highline – Aluminium

Vertical section

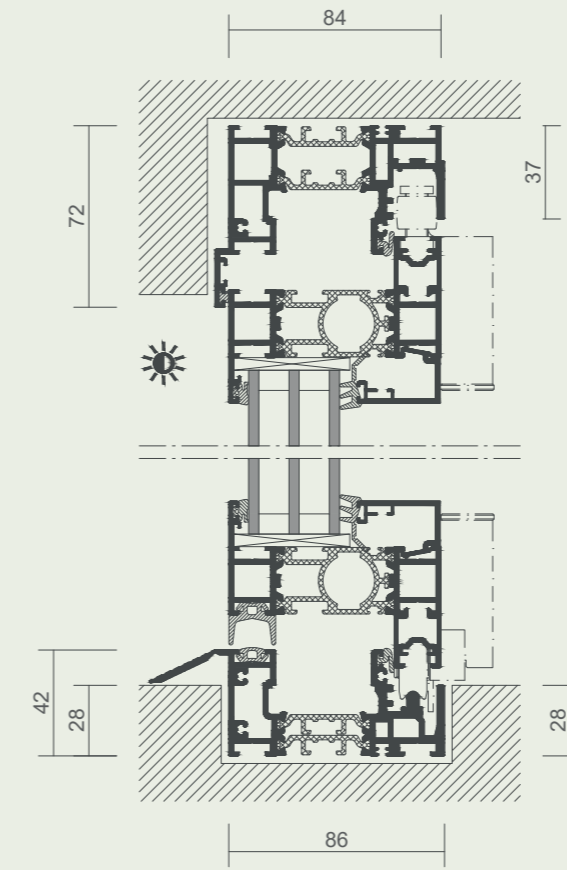

Horizontal section

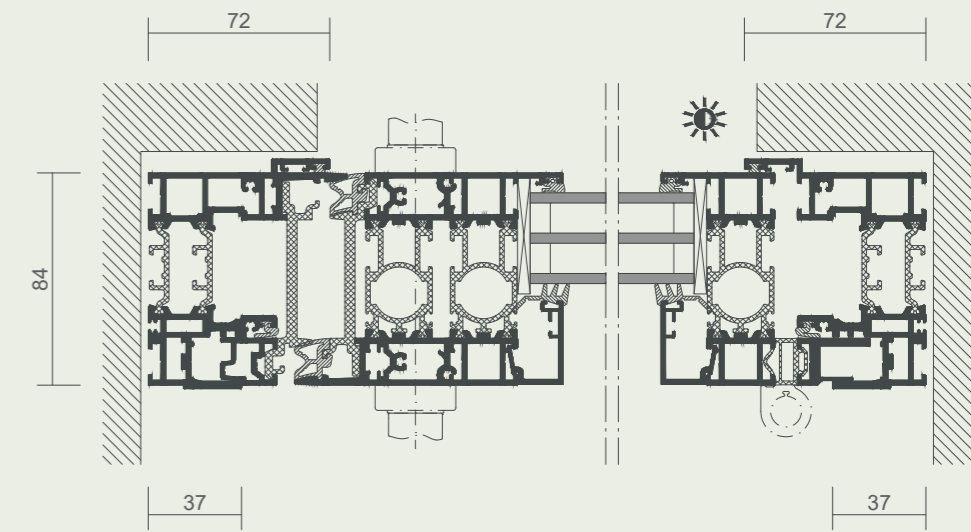

Detail sections: Woodline – Wood

Vertical section

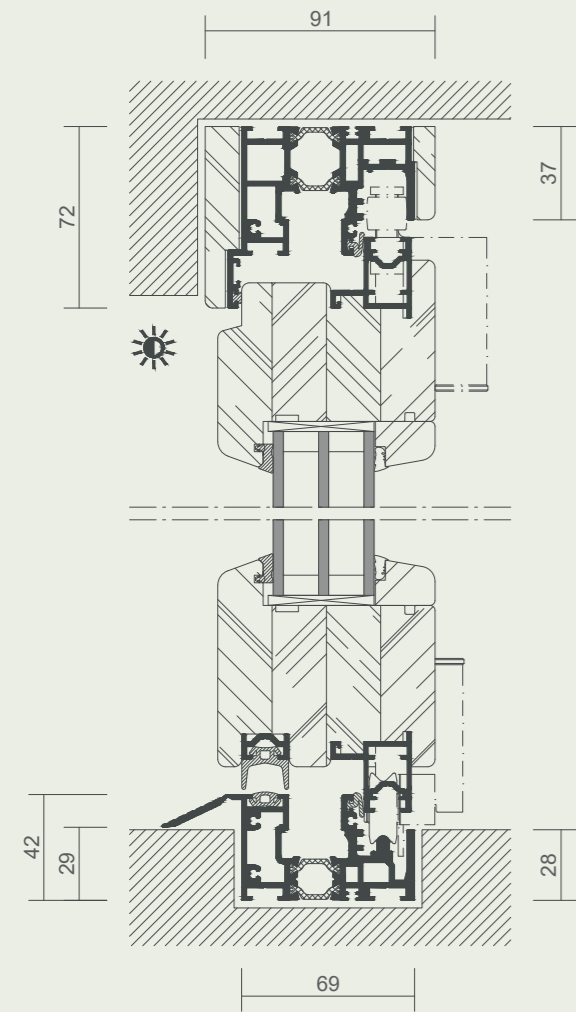

Horizontal section

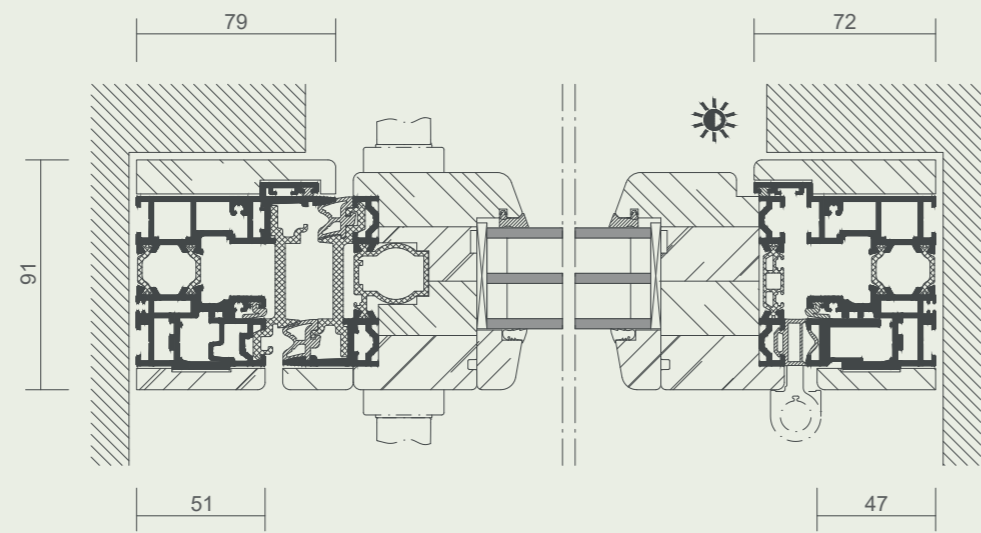

Detail sections: Combiline – Wood/aluminium

Vertical section

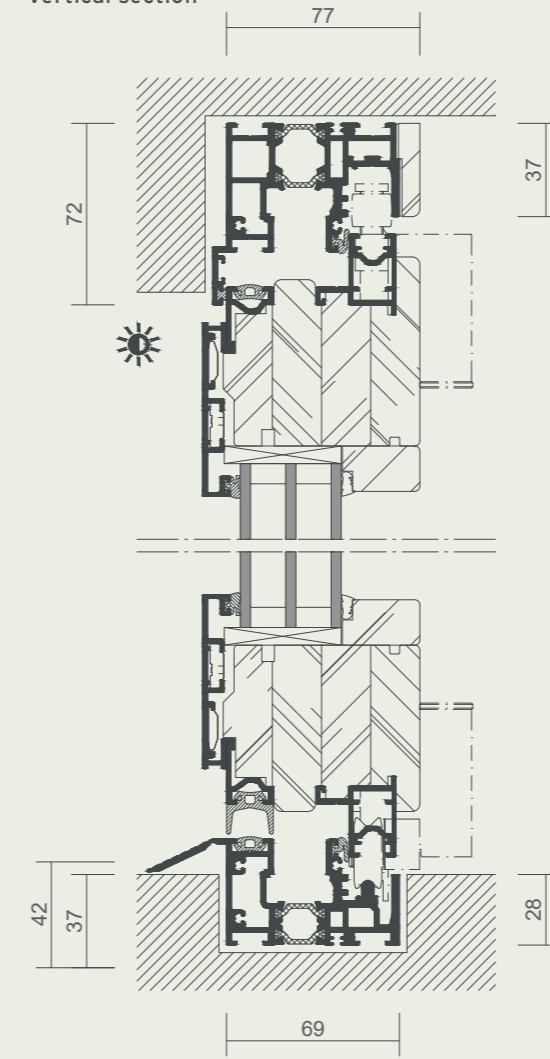

Horizontal section

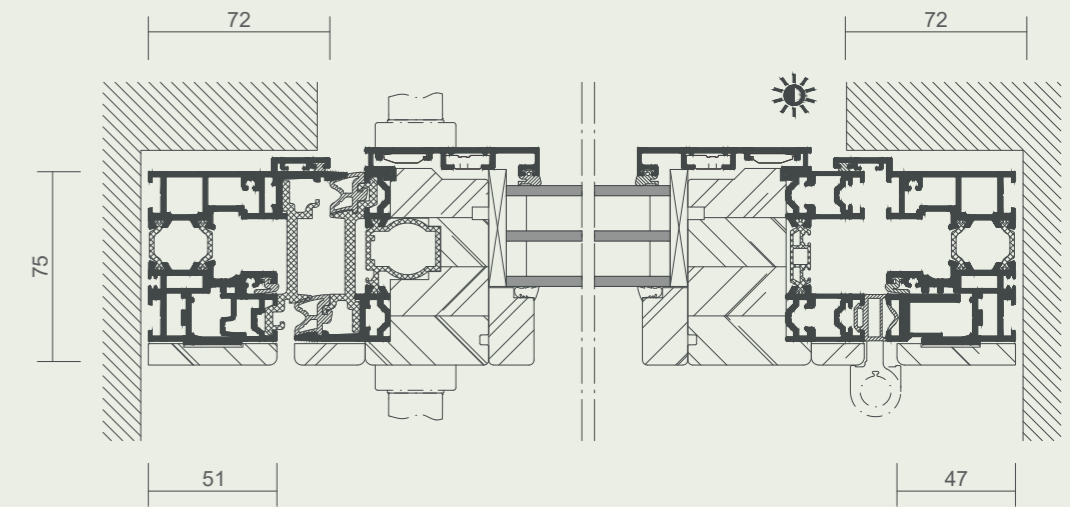

Floor track variants

The only way to cater for different applications is with a variety of floor tracks. We offer the right solution for every area: accessible and suitable for living spaces, with a rebate or completely flush, and even a minimalist option with a depth of just 29 mm. You can choose any of the floor tracks designed for the bi-folding door family, regardless of the material. Running tracks and guide rails are integrated into the respective systems so they do not protrude.

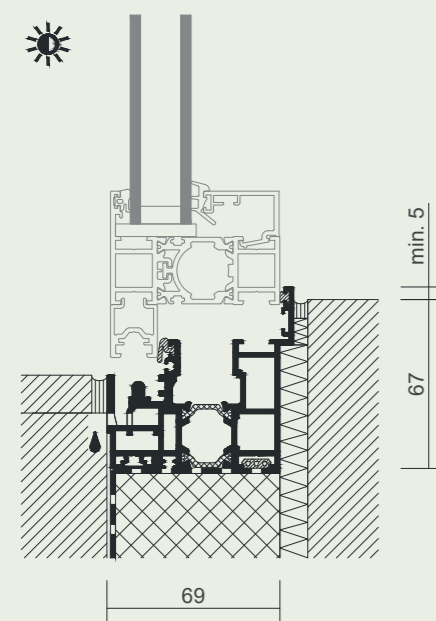

- Floor track with rebate suitable for living spaces
- Opens inwards and outwards

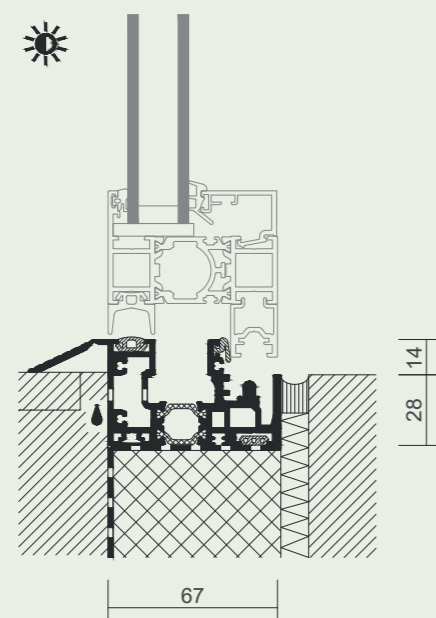

- Floor track suitable for living spaces
- Accessible with 14 mm rebate
- Opens inwards

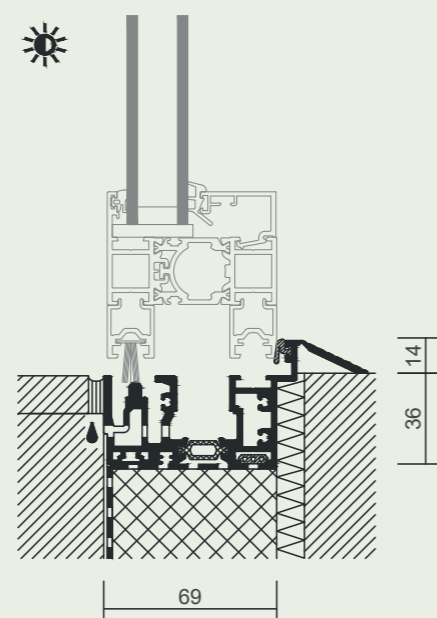

- Floor track suitable for living spaces
- Accessible with 14 mm rebate
- Opens outwards

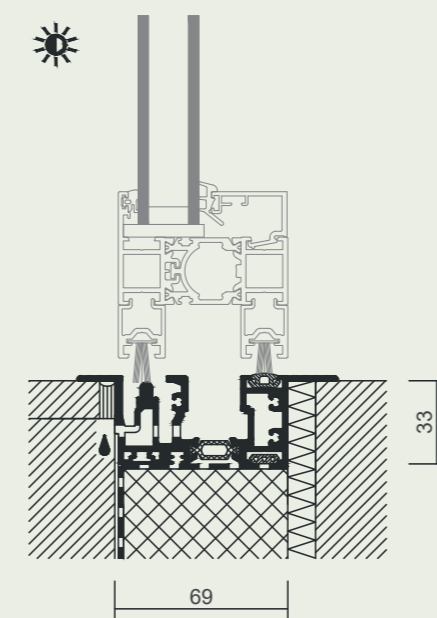

- Flush floor track
- Accessible without rebate
- Opens inwards and outwards

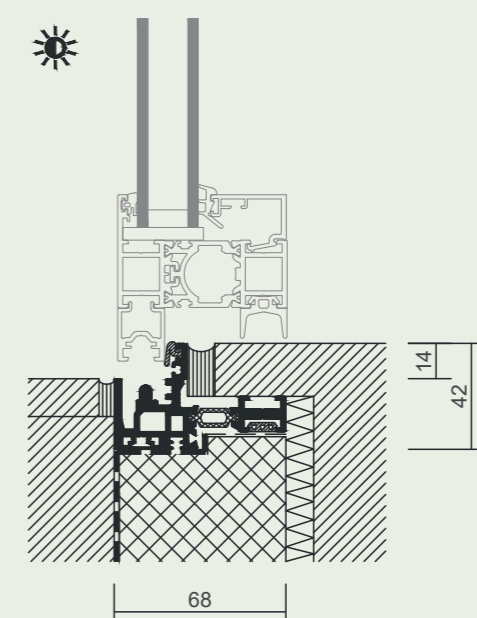

- Minimalist floor track (29 mm)
- Accessible with 14 mm rebate
- Opens outwards

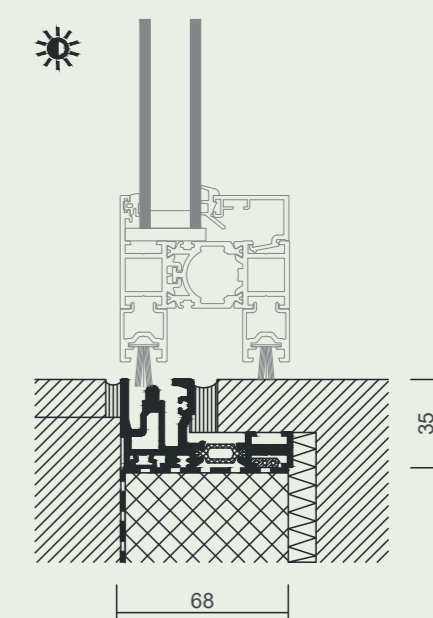

- Minimalist floor track (29 mm)
- Accessible with 0 mm rebate
- Opens inwards and outwards

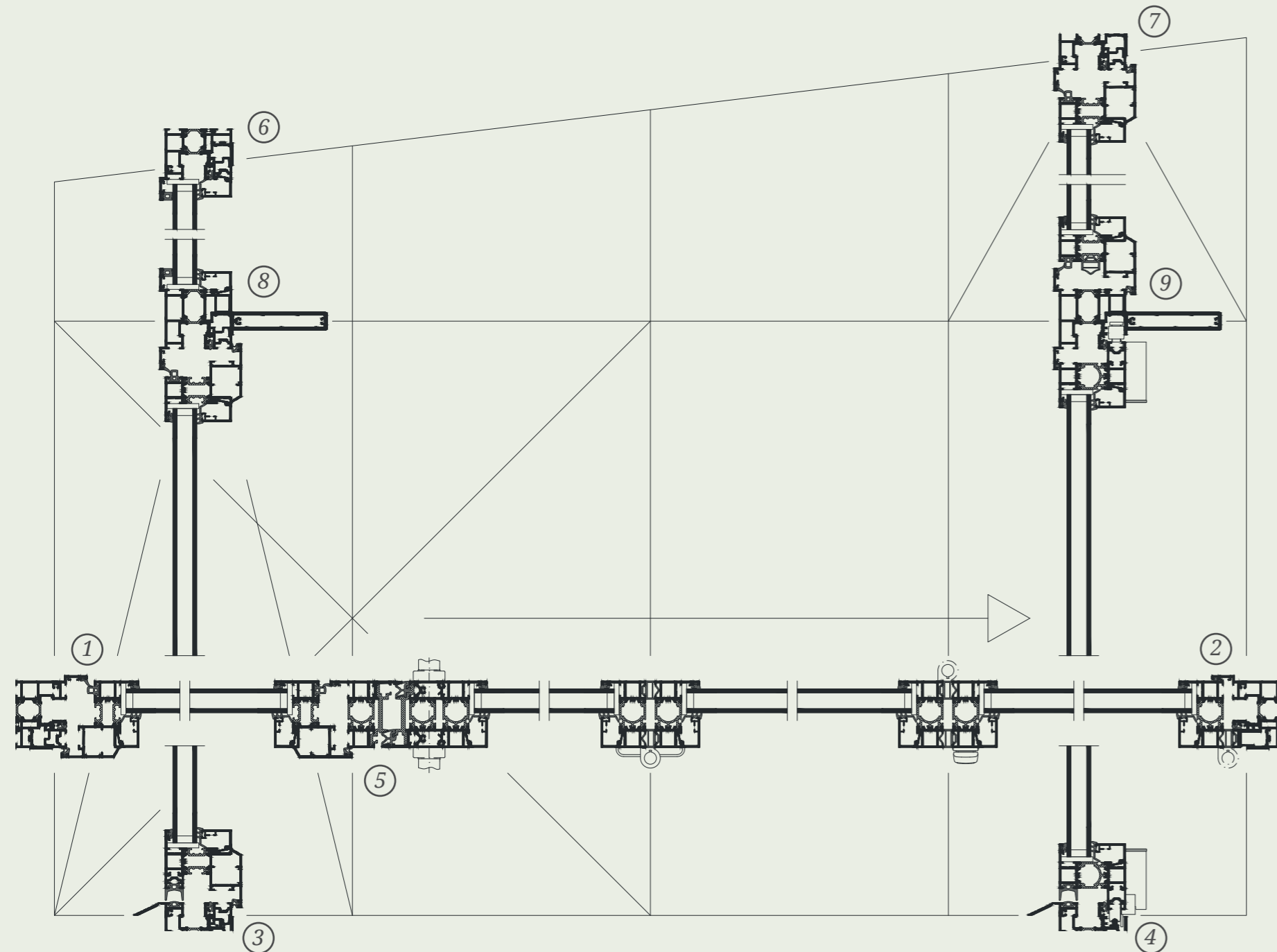

Frame solution for element combinations

In more complex projects, the remit often extends beyond simply integrating a bi-folding door into the building - other elements such as tilt-and-turn panels, fixed elements and top lights are also required. Thanks to its built-in mullion, the run-through modular frame can be used to mount a variety of elements in a single frame without joining the elements in question. This guarantees slim sight lines throughout the system.

① ②

FRAME PROFILE, LEFT & RIGHT

- Side frame profile for the tilt-and-turn element and the hinge side of the bi-folding door

③ ④

RUN-THROUGH FLOOR TRACK

- Accessible floor tracks suitable for living spaces, for the tilt-and-turn element and the bi-folding door

⑥ ⑦

TOP FRAME PROFILE

- Top frame profile for the fixed element and the tilting panel

⑤

MULLION PROFILE

- Thin mullion profile between the tilt-and-turn element and the swing panel of the bi-folding door

⑧ ⑨

STATIC BOLT

- Thin, multi-functional static bolt for absorbing transverse loads

Detail sections: Windows

ECOLINE, HIGHLINE - ALUMINIUM

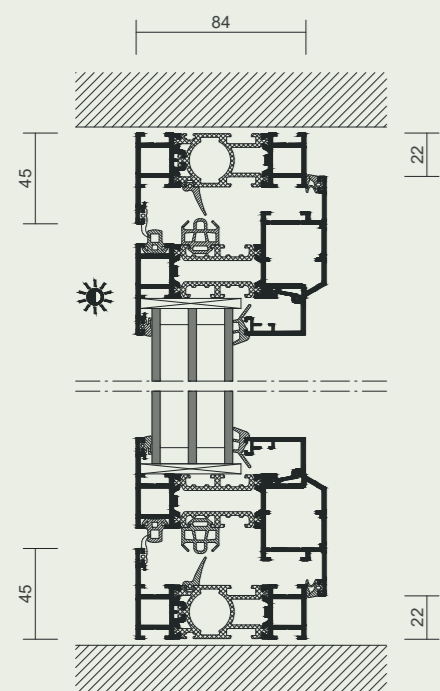

WOODLINE - WOOD

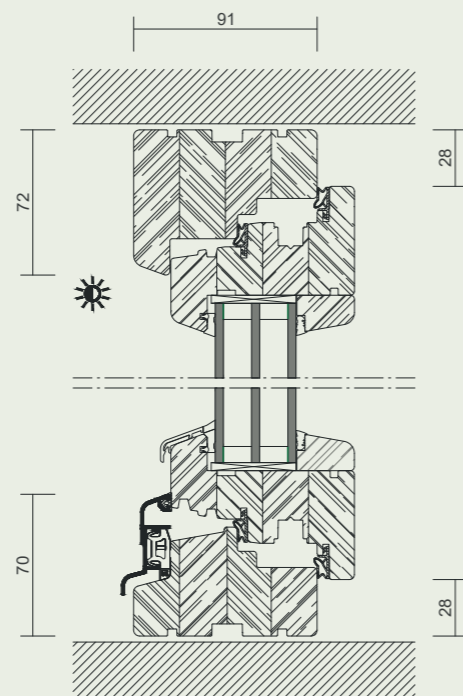

COMBILINE - WOOD/ALUMINIUM

Minimal

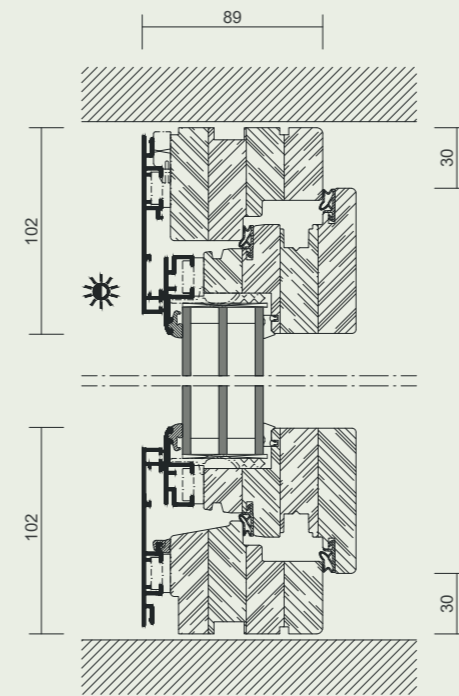

Flush-mounted

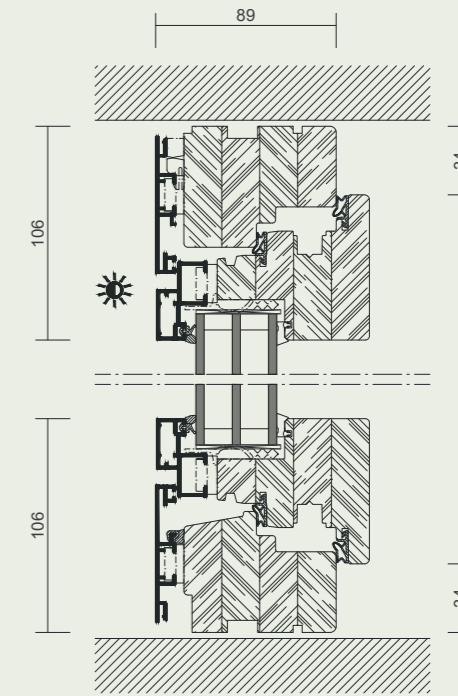

Window sill joints

Film seal with beading in the frame groove ensures a joint that provides protection against wind and driving rain. The window sill joint below the frame profile allows controlled drainage of any water. This prevents water from entering the building structure.

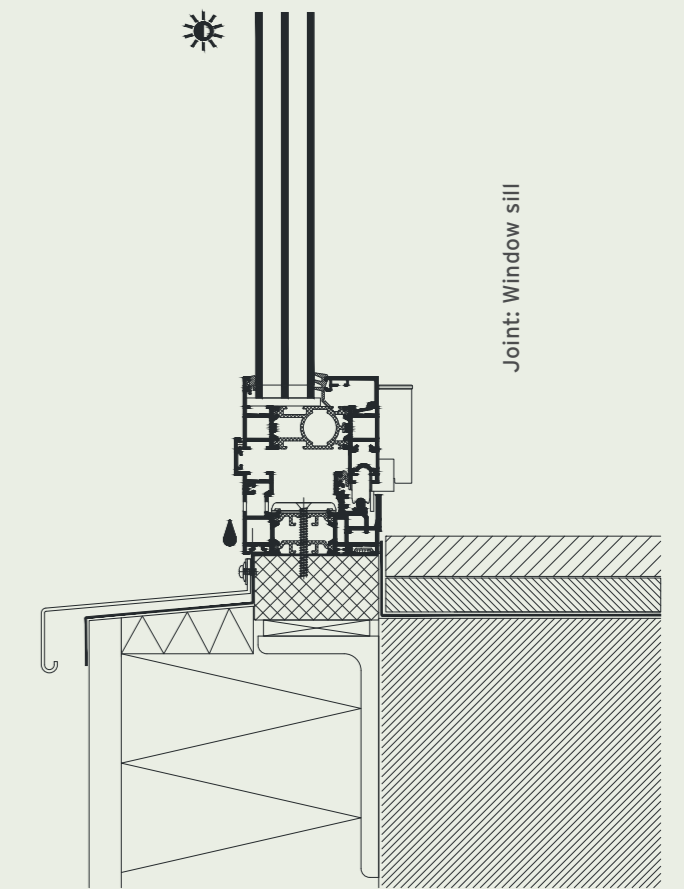
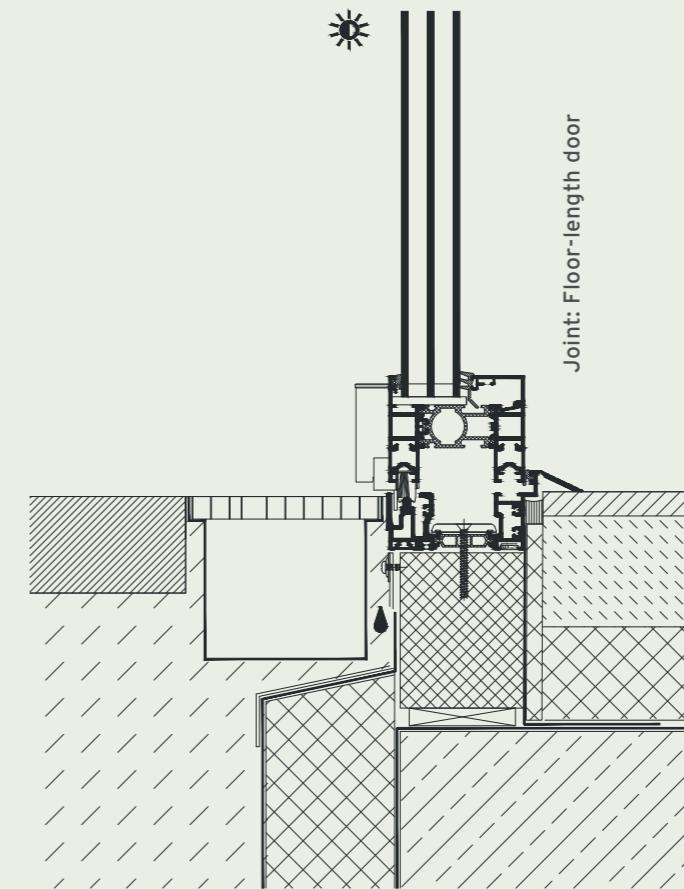

SL 82

Detail sections: All-glass/aluminium

Vertical section

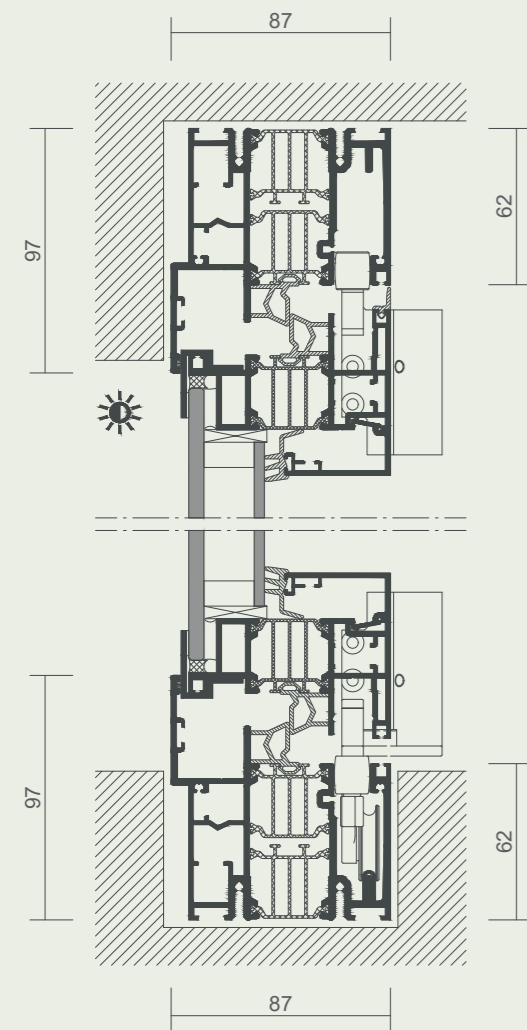

Horizontal section

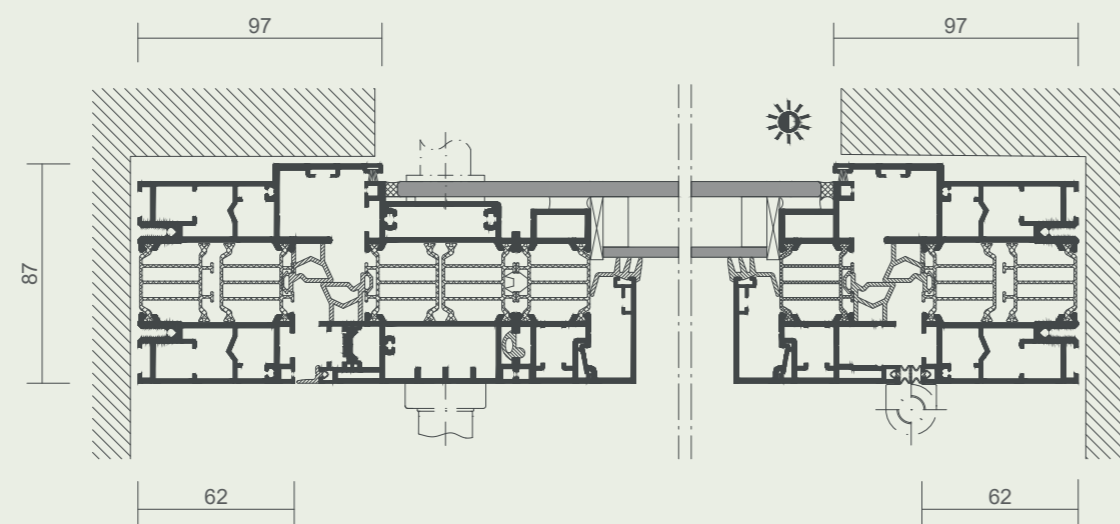

SL 97

Detail sections: Wood/aluminium

Vertical section

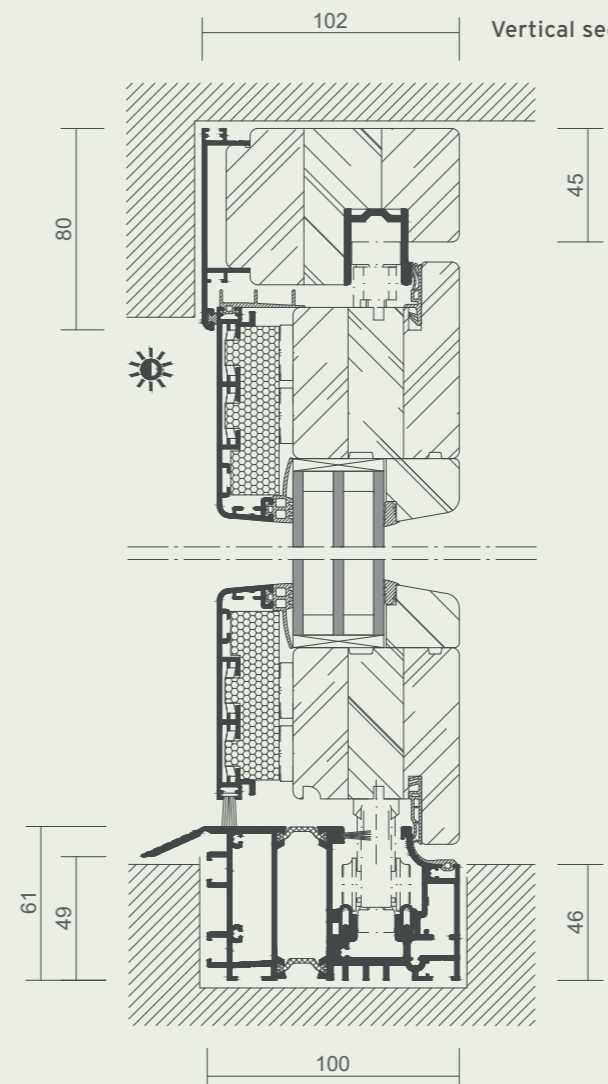

Horizontal section

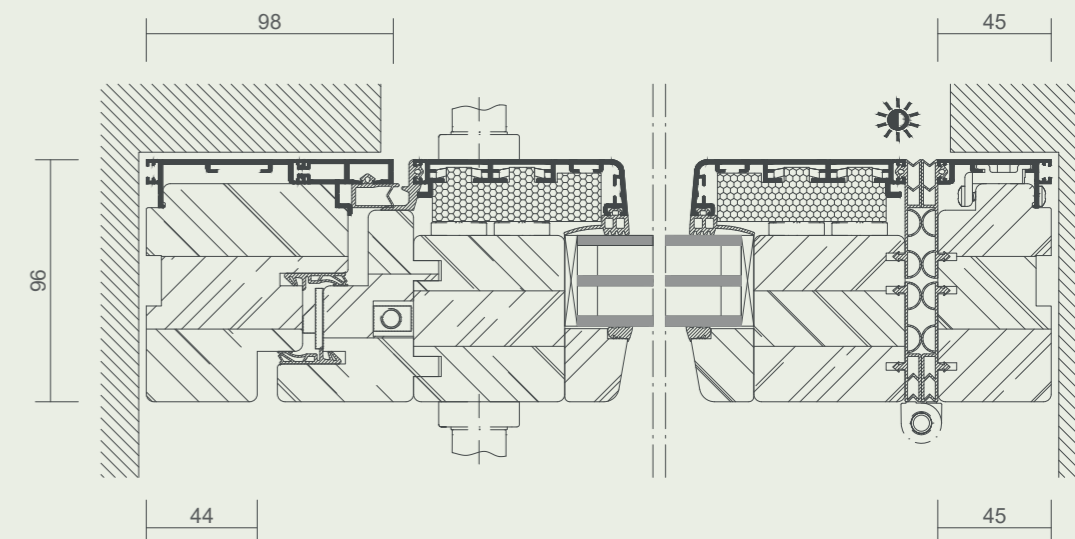

SL 35

Detail sections: Aluminium

Vertical section

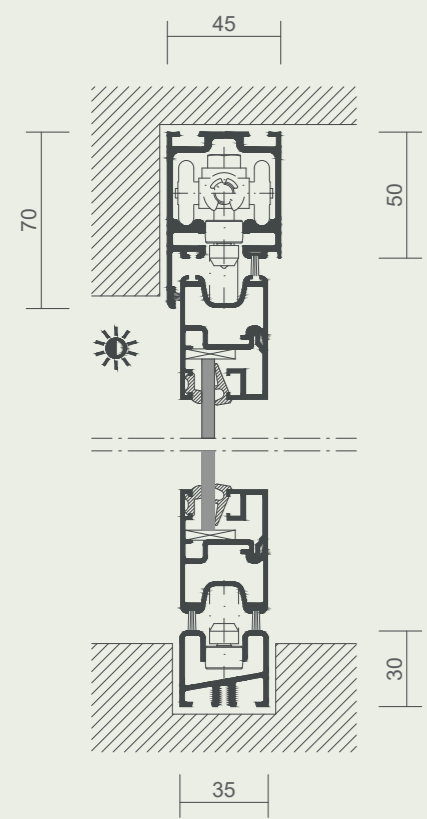

Horizontal section

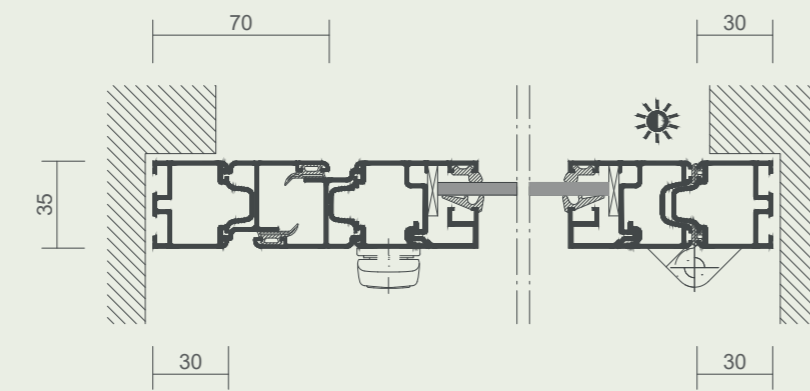

SL 45

Detail sections: Aluminium

Vertical section

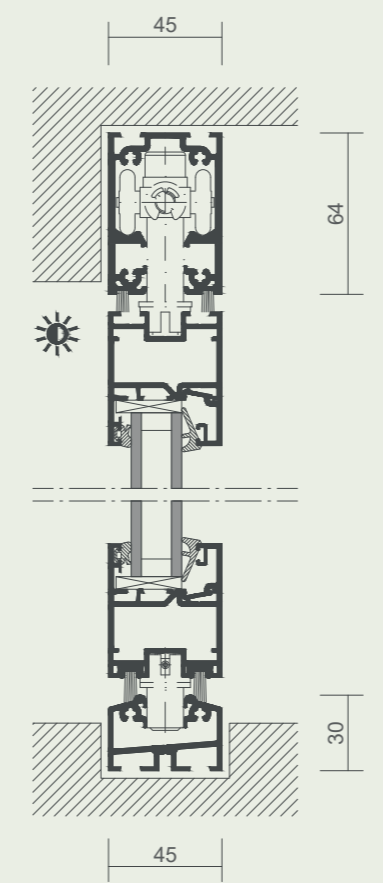

Horizontal section

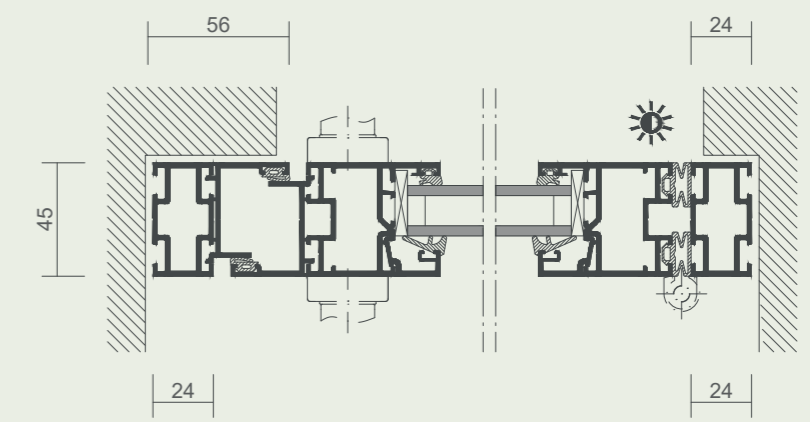



PLACE YOUR TRUST
IN A STRONG *company*

ABOUT SOLARLUX



A SPECIAL FAMILY-OWNED COMPANY

Down-to-earth, innovative and passionate

For more than 35 years, Solarlux has represented exceptional quality in the production of bi-folding doors, wintergardens and facade solutions. Founded by Herbert Holtgreife and based in the town of Melle, north-west Germany, the company is now managed by Holtgreife's son, Stefan. But the real driving force behind Solarlux is its employees: A workforce of around 900 imaginative employees is vital for the success of the leading system provider.

The company's environmentally friendly approach to production, in-house production control structure and compliance with the highest quality standards are reflected in its ISO 9001, ISO 14001 and DIN EN 1090 certificates. When combined with the extensive community outreach that has been part of Solarlux ever since it was founded, this truly makes the family-owned company something special.

**"YOU CAN LOOK BACK, AND
YOU CAN LOOK TO THE FUTURE.
WE DO BOTH."**



THE WORLD OF SOLARLUX



WHAT DOES SOLARLUX STAND FOR?

- Family-owned company
- Certified in accordance with ISO 9001
- In-house Research and Development division
- 900 employees worldwide
- Successful projects in over 60 different countries
- Community outreach, sense of responsibility for people and nature



PRODUCTION

- 57,000 m² production site in north-west Germany
- State-of-the-art manufacturing machinery
- In-house painting line and powder coating plant
- Sustainable and energy-efficient
- Certified in accordance with environmental standard ISO 14001



SOLARLUX PRODUCTS

- Made in Germany
- CE-approved
- Certified and independently tested
- Winner of national and international design awards
- Equipped with the best profile surface
- Comply with the strictest quality standards
- Custom products made to order



SOLARLUX SERVICE

- Top-class consultation
- Everything from a single source
- Tidy assembly
- Private and public building projects handled professionally
- Maintenance and service agreements that extend beyond project completion

KEEP TRACK OF SOLARLUX IN THE DIGITAL REALM

Stay up to date

Projects, references, news - the world of Solarlux moves fast, and an image is sometimes worth a thousand words. What more reason do you need to visit our website or the mySolarlux portal, or to follow us on social media?

It should go without saying that, even in this digital age, we love hearing from you directly and answering your questions in person or on the phone. So don't delay - contact us today! Whether you'd like a zero-obligation consultation session, a sketch of your personal idea, or simply an answer to your question, there are plenty of ways to get in touch with us.



