

## wedi Fundo Rinnenablauf senkrecht, DN 50 mit Feuerstopp

wedi Fundo vertical channel drain, DN 50, fire protection collar | Canal d'écoulement vertical wedi Fundo, DN 50, coupe-feu | wedi Fundo gootafvoer verticaal, DN 50, brandstop | Scarico con canaletta wedi Fundo verticale, DN 50, tagliafuoco | wedi Fundo con canal de desagüe vertical, DN 50, cortafuegos | wedi Fundo de canal com drenagem vertical, DN 50, pára-fogo | wedi Fundo lodret afløbsrende, DN 50, brandstop | wedi Fundo vertikalt avløpsrenne, DN 50, brannsperre | wedi Fundo golvränna lodrätt, DN 50, brandskydd | wedi svislá žlabový odpad Fundo, DN 50, protipožární zábranou | wedi Fundo odpływ korytkowy pionowy, DN 50, zaporą przeciwogniową | wedi Fundo odvod žlijeba vertikalni, DN 50, zaustavljanjem vatre

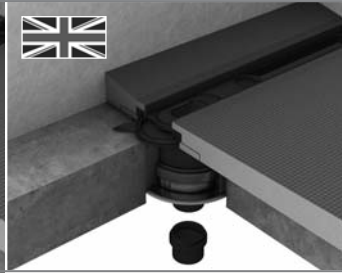

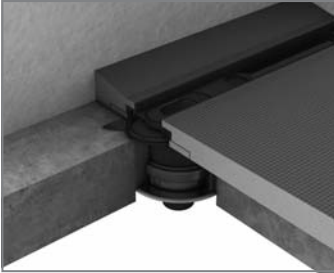
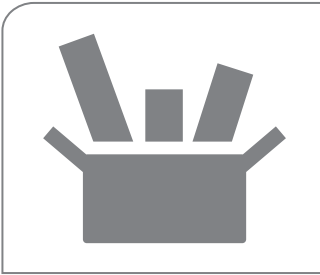

Art.-Nr. 07-37-49/011

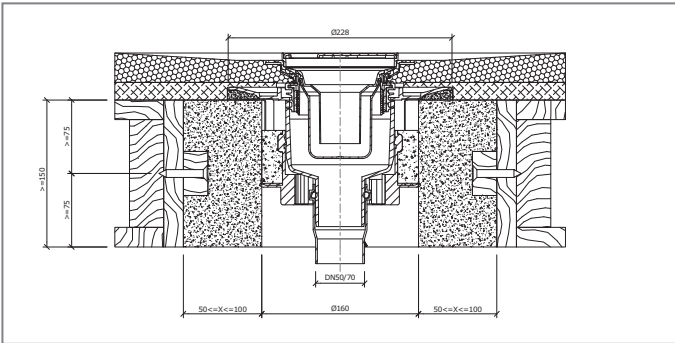
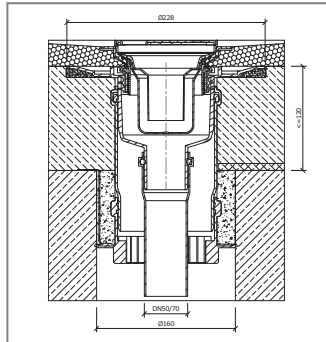
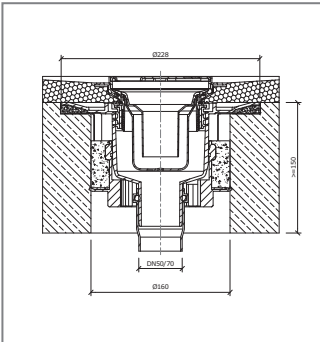

Einbaubeispiele/Installation example/Exemple d'installation



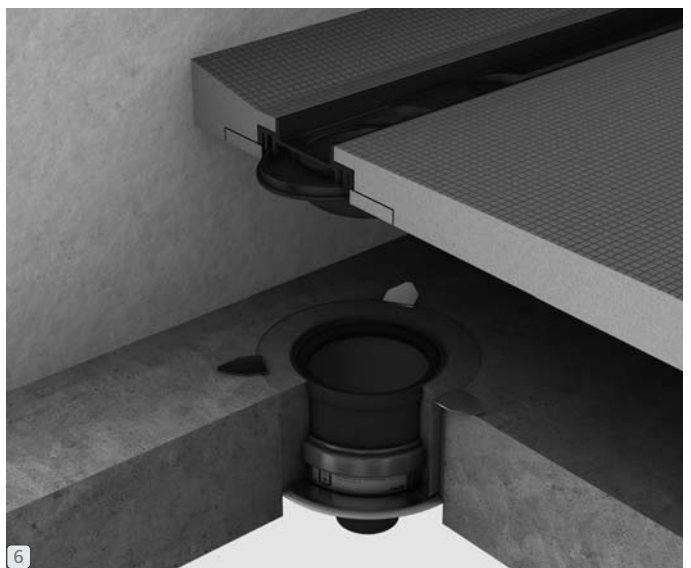
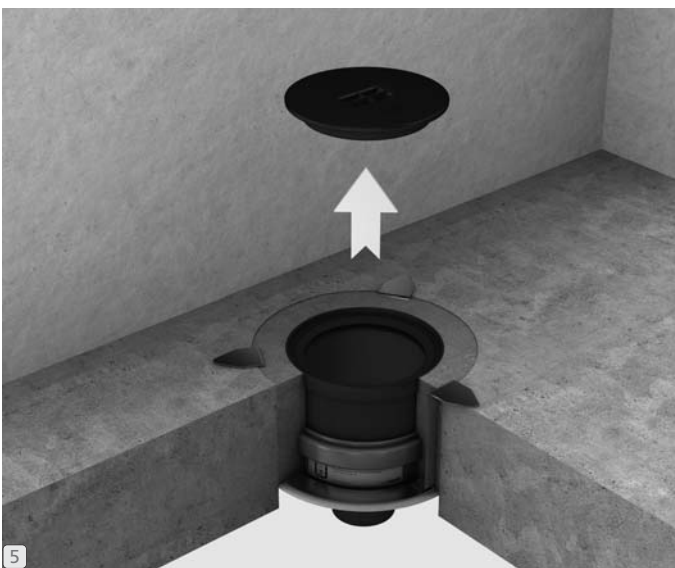
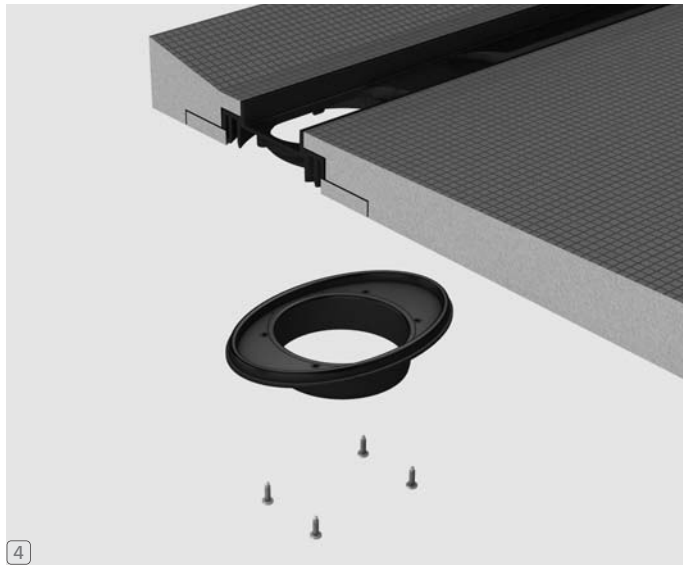
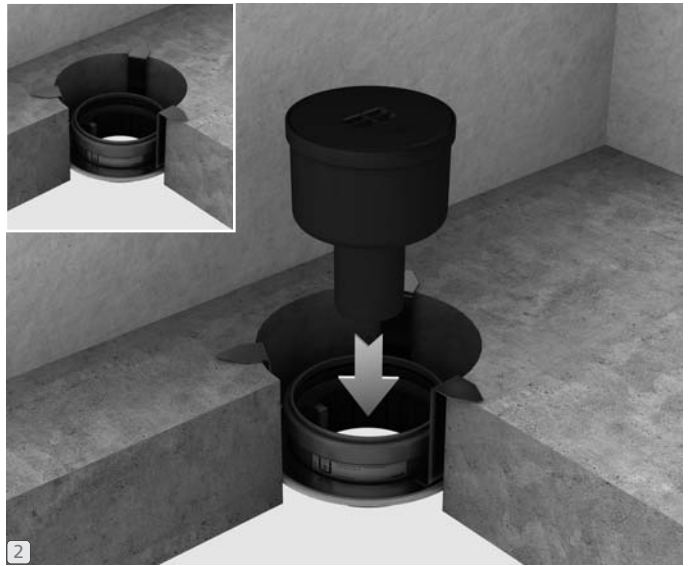
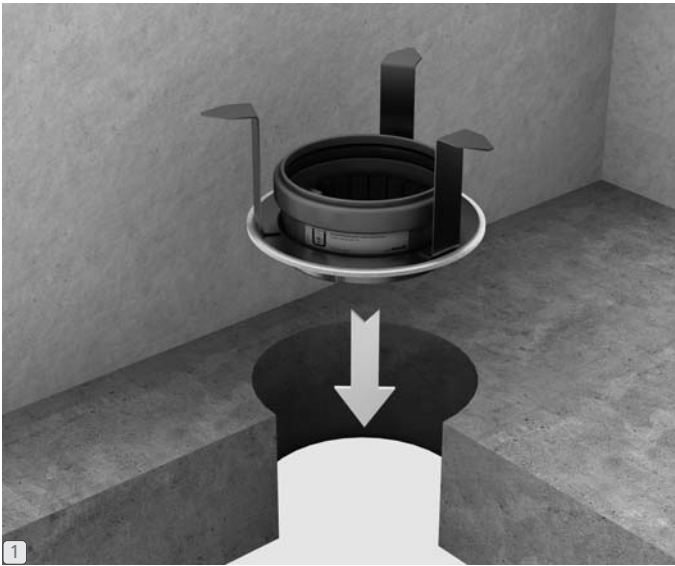

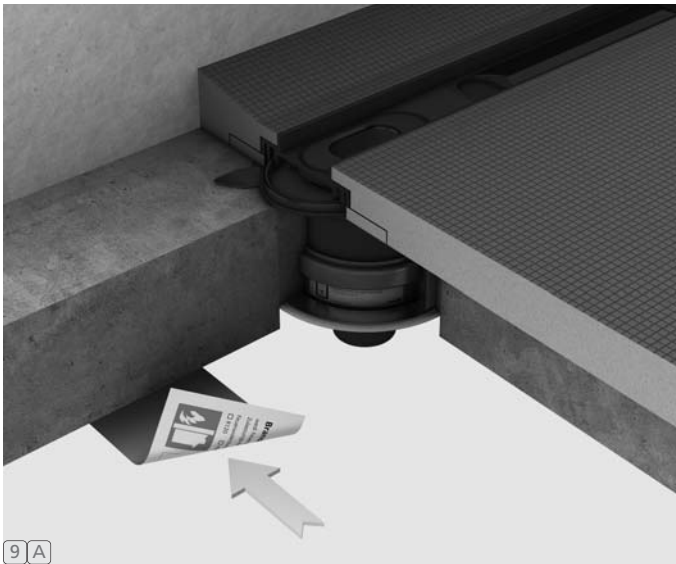
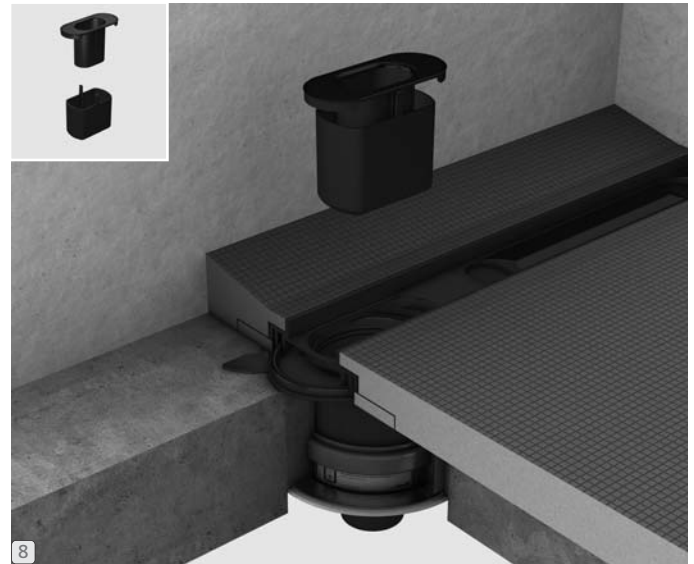
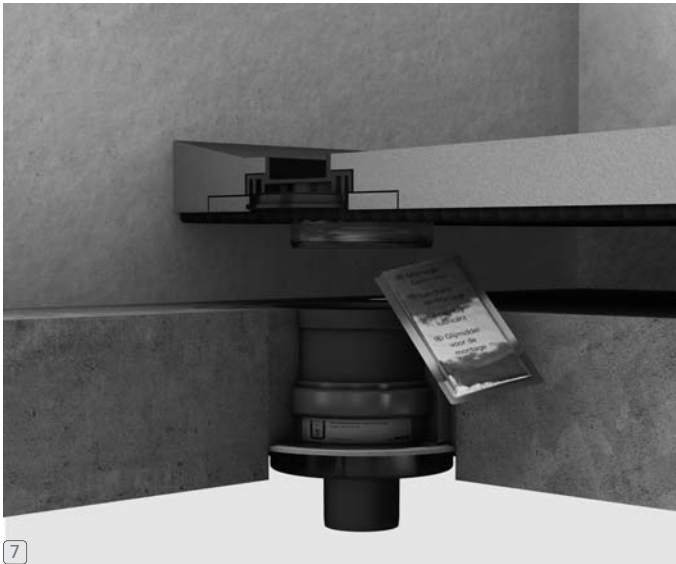

**D Zulässige Rohre:**

An den wassergefüllten Bodenablauf dürfen folgende Anschlussleitungen angeschlossen sein:

weichmacherfreies Polyvinylchlorid (PVC-U, PVC-HI)	gemäß DIN 8062	sowie DIN 19531
chloriertes Polyvinylchlorid (PVC-C)	gemäß DIN 8079	sowie DIN 19538
Polypropylen (PP)	gemäß DIN EN 1451-1	sowie DIN 8077
Polyethylen hoher Dichte (PE-HD)	gemäß DIN 8074	sowie DIN 19537-1
Polyethylen niedriger Dichte (LDPE)	gemäß DIN 19533	sowie DIN 8072
Acrylnitril-Butadien-Styrol (ABS)	gemäß DIN 16891	
Acrylester-Styrol-Acrylnitril (ASA)	gemäß DIN 16891	
Styrol-Copolymerisate	gemäß DIN V 19561	
vernetztes Polyethylen (PE-X)	gemäß DIN 16893	
Polybuten (PB)	gemäß DIN 16969	

bzw. aus Kunststoffen nach den allgemeinen bauaufsichtlichen Zulassungen

Z-42.1-265 "Silent db20"	Z-42.1-432 "Geberit Silent PP"	Z-42.1-506 "POLO-KAL XS"
Z-42.1-241 "POLO-KAL NG (PKNG)"	Z-42.1-341 "POLO-KAL 3S"	Z-42.1-426 "TRIPLUS"
Z-42.1-223 "Rehau Raupiano plus"	Z-42.1-508 "Raupiano Light"	
Z-42.1-228 "Wavin AS"	Z-42.1-403 "WAVIN SiTech"	
Z-42.1-510 "CONEL DRAIN"	Z-42.1-481 "Master 3"	
Z-42.1-220.. "Friaphon"	Z-42.1-399 "POLlphon" und "dBlue"	
Z-42.1-411.. "BluePower"	Z-42.1-217 "Skolan dB"	

**...wedi®**

wedi GmbH  
 Hollefeldstraße 51 · D-48282 Emsdetten  
 Tel. +49 2572 156-0 · Fax +49 2572 156-133  
 info@wedi.de · www.wedi.eu