

Mosa.

Product Details **2024**

Mosa.

Royal Mosa

Meerssenerweg 358
NL-6224 AL Maastricht
P.O. Box 1026
NL-6201 BA Maastricht

Algemeen / Réception / Allgemein / General

T +31 (0)43 368 94 44
info@mosa.com
www.mosa.com

Customer Service

T +31 (0)43 368 92 29
info@mosa.com

After Sales

T +31 (0)43 368 92 49
aftersales@mosa.com

Versie / Version 24-01

Dit Product Details-boek bevat informatie over producten die bij Koninklijke Mosa bv (Mosa) te koop zijn. Mosa heeft alle redelijke inspanningen geleverd om de nauwkeurigheid van de informatie te waarborgen en kan niet aansprakelijk worden gesteld voor mogelijke fouten. Mosa biedt geen garantie voor de nauwkeurigheid en behoudt zich het recht voor om zonder voorafgaande kennisgeving en op elk gewenst moment wijzigingen aan te brengen in zijn portfolio en prijzen. Houd er rekening mee dat deze documentatie geen exacte weergave van kleuren en structuren bevat vanwege technische beperkingen. Daarnaast kunnen de aangegeven verpakkingsgegevens afwijken van de daadwerkelijk geleverde hoeveelheden. Alle voorgaande edities van dit Product Details-boek worden vervangen en herroepen door deze nieuwe editie. Ga naar www.mosa.com voor een overzicht van ons meest recente productaanbod.

Ce livre Product Details comprend des informations sur les produits disponibles à l'achat auprès de Royal Mosa bv (Mosa). Mosa a fait tous les efforts raisonnables pour garantir l'exactitude des informations et ne peut en aucun cas être tenu responsable des erreurs éventuelles. Mosa ne garantit pas l'exactitude des données et se réserve le droit d'apporter des modifications à son portefeuille et à ses prix sans préavis et à tout moment. Veuillez noter que cette documentation ne comporte pas de reproduction exacte des couleurs et structures en raison de restrictions techniques. En outre, les détails d'emballage indiqués peuvent différer des quantités effectivement livrées. Toutes les éditions précédentes du livre Product Details sont remplacées et annulées par cette nouvelle édition. Pour un aperçu de notre offre de produits la plus récente, veuillez consulter le site www.mosa.com.

Dieses Product Details-Buch enthält Informationen zum verfügbaren Produktangebot von Royal Mosa bv (Mosa). Mosa hat alles unternommen, was nach vernünftigem Ermessen erforderlich ist, um die Genauigkeit der Informationen zu gewährleisten, und lehnt jegliche Haftung für eventuelle Fehler ab. Mosa garantiert nicht für die Genauigkeit und behält sich das Recht vor, ohne Vorankündigung jederzeit Änderungen am Produktsortiment und den Preisen vorzunehmen. Bitte beachten Sie, dass diese Dokumentation aufgrund technischer Einschränkungen keine exakte Wiedergabe der Farben und Strukturen darstellt. Ferner können die Verpackungsangaben von den tatsächlichen Liefermengen abweichen. Diese neue Ausgabe ersetzt alle vorherigen Ausgaben des Product Details-Buches. Eine Übersicht über unser aktuelles Produktangebot finden Sie unter www.mosa.com.

This Product Details book includes information about products available for purchase from Royal Mosa bv (Mosa). Mosa has made all reasonable efforts to ensure the accuracy of the information and cannot be held responsible for potential errors. Mosa does not warrant the accuracy and reserves the right to make changes to its portfolio and pricing without notice and at any time. Please note that this documentation does not include an exact reproduction of colours and structures due to technical restrictions. Moreover, the indicated packing details can differ from the actual delivered quantities. All preceding editions of this Product Details book are replaced and cancelled by this new edition. For an overview of our most recent product offering please visit www.mosa.com.

© Royal Mosa Maastricht 2023

Find

This Mosa Product Details 2024 document contains detailed product information about the complete Mosa collection. It is organized by wall tiles, floor tiles, sizes, series, colours and articles. There are two ways to search through the PDF document:

search from the window 'Find':























Mac = Cmd+F / Windows = Ctrl+F

use the extensive search function in the toolbar:

Mac = Shift+Cmd+F / Windows = Shift+Ctrl+F

In both cases Acrobat searches the complete documentation.

Help

	nalevergarantie tot het jaar 2025	livraison garantie jusqu'en 2025	garantiert nachlieferbar bis 2025	guarantee after delivery until the year 2025
	nalevergarantie tot het jaar 2040	livraison garantie jusqu'en 2040	garantiert nachlieferbar bis 2040	guarantee after delivery until the year 2040
	nalevergarantie tot het jaar 2050	livraison garantie jusqu'en 2050	garantiert nachlieferbar bis 2050	guarantee after delivery until the year 2050
	prijsgroep	groupe de prix	Preisgruppe	price group
	glanzend	brillant	glänzend	gloss
	poedermat	mat poudré	pulvermatt	powdermatt
	steenmat	mat pierre	steinmatt	stonematt
	zjdemat	satiné	seidenmatt	satin
	mat	mat	matt	matt
	in deze kleur leverbare wandtegelaccessoires	accessoires pour carreaux de faïences disponibles dans cette couleur	in dieser Farbe lieferbare Wandfliesen-ormteile	accessories for wall tiles, available in this colour
	in deze kleur leverbare vloertegelaccessoires	accessoires pour carreaux de sol disponibles dans cette couleur	in dieser Farbe lieferbare Bodenfliesen-ormteile	accessories for floor tile, available in this colour
	overige, in deze kleur leverbare wandtegelformaten	autres formats carreaux de faïences disponibles dans cette couleur	übrige, in dieser Farbe lieferbare Wandfliesen-ormate	other sizes wall tiles, available in this colour
	overige, in deze kleur leverbare vloertegelformaten	autres formats carreaux de sol disponibles dans cette couleur	übrige, in dieser Farbe lieferbare Bodenfliesen-ormate	other sizes floor tile, available in this colour
	in deze kleur en dit formaat leverbare reliëfvloertegels	carreaux de sol en relief disponibles dans cette couleur et ce format	in dieser Farbe und diesen Format lieferbare Relief Bodenfliese	relief floor tile, available in this colour and size
	in dit formaat en deze kleur leverbare Holland 2050 prefab tegelpanelen			
	shapes	shapes	shapes	shapes
	vorstbestand	ingélif	frostsicher	frost proof
	gerectifi eerd	rectifi	rektifizie t	rectifie
	loopveiligheid R*, V	antidérapance R*, V	Trittsicherheit R*, V	slip resistance R*, V
	loopveiligheid A, B, C	antidérapance A, B, C	Trittsicherheit A, B, C	slip resistance A, B, C
	Cradle to Cradle Certified® Gol	Cradle to Cradle Certified® Gol	Cradle to Cradle Certified® Gol	Cradle to Cradle Certified® Gol
	lichtrefle tiewaarde (indicatief)	valeur de réfle tance (indicatif)	Lichtreflektion wert (indikativ)	light refle tance value (indicative)
	best passende NCS-kleur	couleur NCS correspondant le mieux	korrespondierende NCS-Farbe	best matching NCS-colour

- * Waarschuwing: De weergegeven loopveiligheidswaarde bij a eivering is indicatief en kan in voorkomend geval afwijken. Op aanvraag kan Mosa een certi cering met een exactere waarde per individuele partij tegels verstrekken.
- * Avertissement : L'indice d'antiglossance indiqué à la livraison est uniquement fourni à titre indicatif et peut varier le cas échéant. Mosa peut fournir sur demande une certi cation contenant un indice plus précis par lot individuel de carreaux.
- * Warnung: Der angegebene Trittsicherheitswert bei Auslieferung ist nur ein Richtwert und kann im Einzelfall variieren. Auf Anfrage kann Mosa eine Zerti zierung mit einem genaueren Wert pro Fliesencharge abgeben.
- * Warning: The displayed slip resistance value on delivery is indicative and may vary in particular cases. Upon request, Mosa can provide a certi cation with a more precise value for each individual batch of tiles.

Item number index

A artikelnummer / numéro d'article / Artikelnummer / item number A prijsgroep / groupe de prix / Preisgruppe / price group A pagina / page / Seite / page

0 4 6 0 - 1 5 3 0	CC12	2 0 0 X V 6 0 6 0	AP01	2 0 6 B P 6 0 1 0	D 117	2 1 6 R L 6 0 6 0	BP16
0 4 6 5 - 1 5 3 0	CC12	2 0 0 Y V 1 0 6 0	AP07	2 0 6 B P 9 0 1 0	D 249	2 1 6 R M 1 5 1 5	BP21
0 4 9 0 - 1 5 1 5	U0	2 0 0 Y V 1 5 6 0	AP07	2 0 6 H V 3 0 1 2 0	D 676	2 1 6 T V G 3 0 1 2 0	D 380
0 4 9 0 - 1 5 3 0	CC33	2 0 0 Y V 3 0 6 0	AP01	2 0 6 R L 1 0 6 0	BP17	2 1 6 V 1 0 6 0	BP17
0 4 9 0 - 2 0 2 5	U0	2 0 0 Y V 5 6 0 0	AP07	2 0 6 R L 1 5 6 0	BP17	2 1 6 V 1 5 6 0	BP17
0 4 9 0 - 2 5 3 3	DC11	2 0 0 Y V 6 0 6 0	AP01	2 0 6 R L 2 0 6 0	BP17	2 1 6 V 2 0 6 0	BP17
0 4 9 0 R E 1 5 1 5	D0	2 0 0 Z V 1 0 6 0	AP07	2 0 6 R L 3 0 3 0	BP19	2 1 6 V 2 4 2 4	D 103
0 4 9 0 3 - 1 5 2 0	U0	2 0 0 Z V 1 5 6 0	AP07	2 0 6 R L 3 0 6 0	BP16	2 1 6 V 2 7 6 6	AP49
0 4 9 0 5 - 2 0 2 5	U0	2 0 0 Z V 3 0 6 0	AP01	2 0 6 R L 5 6 0 0	BP17	2 1 6 V 2 9 2 9	AP50
0 4 9 0 H E 1 5 1 5	D0	2 0 0 Z V 5 6 0 0	AP07	2 0 6 R L 6 0 6 0	BP16	2 1 6 V 3 0 3 0	BP19
0 4 9 0 H I 1 5 3	D48	2 0 0 Z V 6 0 6 0	AP01	2 0 6 R M 1 5 1 5	BP21	2 1 6 V 3 0 6 0	BP16
0 4 9 0 H I 2 0 3	D48	2 0 3 B P 3 0 1 0	D 69	2 0 6 T V G 3 0 1 2 0	D 380	2 1 6 V 4 9 2 6	AP50
0 4 9 0 H U 1 5 3	D48	2 0 3 B P 6 0 1 0	D 117	2 0 6 V 1 0 6 0	BP17	2 1 6 V 5 6 0 0	BP17
0 4 9 0 H U 2 0 3	D48	2 0 3 B P 9 0 1 0	D 249	2 0 6 V 1 5 6 0	BP17	2 1 6 V 5 9 2 9	AP50
0 4 9 0 I I 3 3	D107	2 0 3 H V 3 0 1 2 0	D 676	2 0 6 V 2 0 6 0	BP17	2 1 6 V 5 9 3 0	AP49
0 4 9 0 I U 3 3	D107	2 0 3 R L 1 0 6 0	BP17	2 0 6 V 2 4 2 4	D 103	2 1 6 V 6 0 1 2 0	BP12
0 4 9 0 L 1 5 2 0	U0	2 0 3 R L 1 5 6 0	BP17	2 0 6 V 2 7 6 6	AP49	2 1 6 V 6 0 6 0	BP16
0 4 9 0 M 1 5 1 5	U0	2 0 3 R L 2 0 6 0	BP17	2 0 6 V 2 9 2 9	AP50	2 1 6 V 6 6 2 7	AP49
0 4 9 0 R E 1 5 1 5	D0	2 0 3 R L 3 0 3 0	BP19	2 0 6 V 3 0 3 0	BP19	2 1 6 V 8 4 4 2	AP48
0 4 9 0 U 1 5 3	D107	2 0 3 R L 3 0 6 0	BP16	2 0 6 V 3 0 6 0	BP16	2 1 6 V 9 0 9 0	BP12
0 4 9 0 U U 5 3	D107	2 0 3 R L 5 6 0 0	BP17	2 0 6 V 4 9 2 6	AP50	2 1 6 V V 1 5 1 5	BP21
0 4 9 5 - 1 5 3 0	CC33	2 0 3 R L 6 0 6 0	BP16	2 0 6 V 5 6 0 0	BP17	2 1 6 X V 1 0 6 0	AP07
0 4 9 5 - 2 0 2 5	U0	2 0 3 R M 1 5 1 5	BP21	2 0 6 V 5 9 2 9	AP50	2 1 6 X V 1 5 6 0	AP07
0 4 9 5 - 2 5 3 3	DC11	2 0 3 T V G 3 0 1 2 0	D 380	2 0 6 V 5 9 3 0	AP49	2 1 6 X V 3 0 6 0	AP01
0 4 9 5 H E 1 5 1 5	D0	2 0 3 V 1 0 6 0	BP17	2 0 6 V 6 0 1 2 0	BP12	2 1 6 X V 5 6 0 0	AP07
0 4 9 5 L 1 5 2 0	U0	2 0 3 V 1 5 6 0	BP17	2 0 6 V 6 0 6 0	BP16	2 1 6 X V 6 0 6 0	AP01
0 4 9 5 M 1 5 1 5	U0	2 0 3 V 2 0 6 0	BP17	2 0 6 V 6 6 2 7	AP49	2 1 6 Y V 1 0 6 0	AP07
0 4 9 5 R E 1 5 1 5	D0	2 0 3 V 2 4 2 4	D 103	2 0 6 V 8 4 4 2	AP48	2 1 6 Y V 1 5 6 0	AP07
0 4 9 7 - 1 5 3 0	CC33	2 0 3 V 2 7 6 6	AP49	2 0 6 V 9 0 9 0	BP12	2 1 6 Y V 3 0 6 0	AP01
0 4 9 7 - 2 0 2 5	U0	2 0 3 V 2 9 2 9	AP50	2 0 6 V V 1 5 1 5	BP21	2 1 6 Y V 5 6 0 0	AP07
0 4 9 7 3 - 1 5 2 0	U0	2 0 3 V 3 0 3 0	BP19	2 0 6 X V 1 0 6 0	AP07	2 1 6 Y V 6 0 6 0	AP01
0 4 9 7 5 - 2 0 2 5	U0	2 0 3 V 3 0 6 0	BP16	2 0 6 X V 1 5 6 0	AP07	2 1 6 Z V 1 0 6 0	AP07
0 4 9 7 H E 1 5 1 5	D0	2 0 3 V 4 9 2 6	AP50	2 0 6 X V 3 0 6 0	AP01	2 1 6 Z V 1 5 6 0	AP07
0 4 9 7 L 1 5 2 0	U0	2 0 3 V 5 6 0 0	BP17	2 0 6 X V 5 6 0 0	AP07	2 1 6 Z V 3 0 6 0	AP01
0 4 9 7 M 1 5 1 5	U0	2 0 3 V 5 9 2 9	AP50	2 0 6 X V 6 0 6 0	AP01	2 1 6 Z V 5 6 0 0	AP07
0 4 9 7 R E 1 5 1 5	D0	2 0 3 V 5 9 3 0	AP49	2 0 6 Y V 1 0 6 0	AP07	2 1 6 Z V 6 0 6 0	AP01
0 4 9 8 - 1 5 3 0	CC33	2 0 3 V 6 0 1 2 0	BP12	2 0 6 Y V 1 5 6 0	AP07	2 2 2 B P 6 0 1 0	D 117
0 4 9 8 - 2 0 2 5	U0	2 0 3 V 6 0 6 0	BP16	2 0 6 Y V 3 0 6 0	AP01	2 2 2 V 1 0 6 0	BP17
0 4 9 8 H E 1 5 1 5	D0	2 0 3 V 6 6 2 7	AP49	2 0 6 Y V 5 6 0 0	AP07	2 2 2 V 1 5 6 0	BP17
0 4 9 8 L 1 5 2 0	U0	2 0 3 V 8 4 4 2	AP48	2 0 6 Y V 6 0 6 0	AP01	2 2 2 V 2 0 6 0	BP17
0 4 9 8 M 1 5 1 5	U0	2 0 3 V 9 0 9 0	BP12	2 0 6 Y V 6 6 0 6	AP07	2 2 2 V 2 4 2 4	D 103
0 4 9 8 R E 1 5 1 5	D0	2 0 3 V V 1 5 1 5	BP21	2 0 6 Z V 1 5 6 0	AP07	2 2 2 V 2 7 6 6	AP49
0 6 0 1 - 1 0 2 0	BC09	2 0 3 X V 1 0 6 0	AP07	2 0 6 Z V 3 0 6 0	AP01	2 2 2 V 2 9 2 9	AP50
0 6 0 2 - 1 0 2 0	BC09	2 0 3 X V 1 5 6 0	AP07	2 0 6 Z V 5 6 0 0	AP07	2 2 2 V 3 0 6 0	BP16
0 6 0 3 - 1 0 2 0	BC09	2 0 3 X V 3 0 6 0	AP01	2 0 6 Z V 6 0 6 0	AP01	2 2 2 V 4 9 2 6	AP50
0 6 0 4 - 1 0 2 0	BC09	2 0 3 X V 5 6 0 0	AP07	2 1 1 B P 3 0 1 0	D 69	2 2 2 V 5 6 0 0	BP17
0 6 0 5 - 1 0 2 0	BC09	2 0 3 X V 6 0 6 0	AP01	2 1 1 B P 6 0 1 0	D 117	2 2 2 V 5 9 2 9	AP50
0 6 0 6 - 1 0 2 0	BC09	2 0 3 Y V 1 0 6 0	AP07	2 1 1 B P 9 0 1 0	D 249	2 2 2 V 5 9 3 0	AP49
0 6 0 7 - 1 0 2 0	BC09	2 0 3 Y V 1 5 6 0	AP07	2 1 1 H V 3 0 1 2 0	D 676	2 2 2 V 6 0 6 0	BP16
0 6 0 8 - 1 0 2 0	BC09	2 0 3 Y V 3 0 6 0	AP01	2 1 1 R L 1 0 6 0	BP17	2 2 2 V 6 6 2 7	AP49
0 6 0 9 - 1 0 2 0	BC09	2 0 3 Y V 5 6 0 0	AP07	2 1 1 R L 1 5 6 0	BP17	2 2 2 V 8 4 4 2	AP48
0 6 1 0 - 1 0 2 0	BC09	2 0 3 Y V 6 0 6 0	AP01	2 1 1 R L 2 0 6 0	BP17	2 2 5 B P 3 0 1 0	D 69
1 0 3 H M 1 5 1 5	D92	2 0 3 Z V 1 0 6 0	AP07	2 1 1 R L 3 0 3 0	BP19	2 2 5 B P 6 0 1 0	D 117
1 0 3 V M 1 5 1 5	D92	2 0 3 Z V 1 5 6 0	AP07	2 1 1 R L 3 0 6 0	BP16	2 2 5 B P 9 0 1 0	D 249
1 0 4 H M 1 5 1 5	D92	2 0 3 Z V 3 0 6 0	AP01	2 1 1 R L 5 6 0 0	BP17	2 2 5 R M 1 5 1 5	BP21
1 0 4 V M 1 5 1 5	D92	2 0 3 Z V 5 6 0 0	AP07	2 1 1 R L 6 0 6 0	BP16	2 2 5 V 1 0 6 0	BP17
1 1 6 H M 1 5 1 5	D92	2 0 3 Z V 6 0 6 0	AP01	2 1 1 T V G 3 0 1 2 0	D 380	2 2 5 V 1 5 6 0	BP17
1 1 6 V M 1 5 1 5	D92	2 0 4 B P 3 0 1 0	D 69	2 1 1 V 1 0 6 0	BP17	2 2 5 V 2 0 6 0	BP17
1 2 5 H M 1 5 1 5	D92	2 0 4 B P 6 0 1 0	D 117	2 1 1 V 1 5 6 0	BP17	2 2 5 V 2 4 2 4	D 103
1 2 5 V M 1 5 1 5	D92	2 0 4 B P 9 0 1 0	D 249	2 1 1 V 2 0 6 0	BP17	2 2 5 V 2 7 6 6	AP49
1 2 6 H M 1 5 1 5	D92	2 0 4 H V 3 0 1 2 0	D 676	2 1 1 V 3 0 3 0	BP19	2 2 5 V 2 9 2 9	AP50
1 2 6 V M 1 5 1 5	D92	2 0 4 R L 1 0 6 0	BP17	2 1 1 V 3 0 6 0	BP16	2 2 5 V 3 0 3 0	BP19
1 6 4 H M 1 5 1 5	D92	2 0 4 R L 1 5 6 0	BP17	2 1 1 V 5 6 0 0	BP17	2 2 5 V 3 0 6 0	BP16
1 6 4 V M 1 5 1 5	D92	2 0 4 R L 2 0 6 0	BP17	2 1 1 V 6 0 1 2 0	BP12	2 2 5 V 4 9 2 6	AP50
1 6 6 H M 1 5 1 5	D92	2 0 4 R L 3 0 3 0	BP19	2 1 1 V 6 0 6 0	BP16	2 2 5 V 5 6 0 0	BP17
1 6 6 V M 1 5 1 5	D92	2 0 4 R L 3 0 6 0	BP16	2 1 4 B P 6 0 1 0	D 117	2 2 5 V 5 9 2 9	AP50
2 0 0 B P 6 0 1 0	D 117	2 0 4 R L 5 6 0 0	BP17	2 1 4 V 3 0 6 0	BP16	2 2 5 V 5 9 3 0	AP49
2 0 0 B P 9 0 1 0	D 249	2 0 4 R L 6 0 6 0	BP16	2 1 4 V 6 0 6 0	BP16	2 2 5 V 6 0 1 2 0	BP12
2 0 0 H V 3 0 1 2 0	D 676	2 0 4 R M 1 5 1 5	BP21	2 1 5 B P 6 0 1 0	D 117	2 2 5 V 6 0 6 0	BP16
2 0 0 R L 1 0 6 0	BP17	2 0 4 T V G 3 0 1 2 0	D 380	2 1 5 V 3 0 6 0	BP16	2 2 5 V 6 6 2 7	AP49
2 0 0 R L 1 5 6 0	BP17	2 0 4 V 1 0 6 0	BP17	2 1 5 V 6 0 6 0	BP16	2 2 5 V 8 4 4 2	AP48
2 0 0 R L 2 0 6 0	BP17	2 0 4 V 1 5 6 0	BP17	2 1 5 X V 1 0 6 0	AP07	2 2 5 V 9 0 9 0	BP12
2 0 0 R L 3 0 6 0	BP16	2 0 4 V 2 0 6 0	BP17	2 1 5 X V 1 5 6 0	AP07	2 2 5 V 9 1 5 1 5	BP21
2 0 0 R L 5 6 0 0	BP17	2 0 4 V 3 0 3 0	BP19	2 1 5 X V 3 0 6 0	AP01	2 2 6 B P 3 0 1 0	D 69
2 0 0 R L 6 0 6 0	BP16	2 0 4 V 3 0 6 0	BP16	2 1 5 X V 5 6 0 0	AP07	2 2 6 B P 6 0 1 0	D 117
2 0 0 T V G 3 0 1 2 0	D 380	2 0 4 V 5 6 0 0	BP17	2 1 5 X V 6 0 6 0	AP07	2 2 6 B P 9 0 1 0	D 249
2 0 0 V 1 0 6 0	BP17	2 0 4 V 6 0 1 2 0	BP12	2 1 5 Y V 1 0 6 0	AP07	2 2 6 H V 3 0 1 2 0	D 676
2 0 0 V 1 5 6 0	BP17	2 0 4 V 6 0 6 0	BP16	2 1 5 Y V 1 5 6 0	AP07	2 2 6 R M 1 5 1 5	BP21
2 0 0 V 2 0 6 0	BP17	2 0 4 V 9 0 9 0	BP12	2 1 5 Y V 3 0 6 0	AP01	2 2 6 T V G 3 0 1 2 0	D 380
2 0 0 V 2 4 2 4	D 103	2 0 4 V V 1 5 1 5	BP21	2 1 5 Y V 5 6 0 0	AP07	2 2 6 V 1 0 6 0	BP17
2 0 0 V 2 7 6 6	AP49	2 0 4 X V 1 0 6 0	AP07	2 1 5 Y V 6 0 6 0	AP01	2 2 6 V 1 5 6 0	BP17
2 0 0 V 2 9 2 9	AP50	2 0 4 X V 1 5 6 0	AP07	2 1 5 Z V 1 0 6 0	AP07	2 2 6 V 2 0 6 0	BP17
2 0 0 V 3 0 6 0	BP16	2 0 4 X V 3 0 6 0	AP01	2 1 5 Z V 1 5 6 0	AP07	2 2 6 V 3 0 3 0	BP19
2 0 0 V 4 9 2 6	AP50	2 0 4 X V 5 6 0 0	AP07	2 1 5 Z V 3 0 6 0	AP01	2 2 6 V 3 0 6 0	BP16
2 0 0 V 5 6 0 0	BP17	2 0 4 X V 6 0 6 0	AP01	2 1 5 Z V 5 6 0 0	AP07	2 2 6 V 5 6 0 0	BP17
2 0 0 V 5 9 2 9	AP50	2 0 4 Y V 1 0 6 0	AP07	2 1 5 Z V 6 0 6 0	AP01	2 2 6 V 6 0 1 2 0	BP12
2 0 0 V 5 9 3 0	AP49	2 0 4 Y V 1 5 6 0	AP07	2 1 6 B P 3 0 1 0	D 69	2 2 6 V 6 0 6 0	BP16
2 0 0 V 6 0 1 2 0	BP12	2 0 4 Y V 3 0 6 0	AP01	2 1 6 B P 6 0 1 0	D 117	2 2 6 V 9 0 9 0	BP12
2 0 0 V 6 0 6 0	BP16	2 0 4 Y V 5 6 0 0	AP07	2 1 6 B P 9 0 1 0	D 249	2 2 6 V V 1 5 1 5	BP21
2 0 0 V 6 6 2 7	AP49	2 0 4 Y V 6 0 6 0	AP01	2 1 6 H V 3 0 1 2 0	D 676	2 2 7 B P 3 0 1 0	D 69
2 0 0 V 8 4 4 2	AP48	2 0 4 Z V 1 0 6 0	AP07	2 1 6 R L 1 0 6 0	BP17	2 2 7 B P 6 0 1 0	D 117
2 0 0 V 9 0 9 0	BP12	2 0 4 Z V 1 5 6 0	AP07	2 1 6 R L 1 5 6 0	BP17	2 2 7 B P 9 0 1 0	D 249
2 0 0 X V 1 0 6 0	AP07	2 0 4 Z V 3 0 6 0	AP01	2 1 6 R L 2 0 6 0	BP17	2 2 7 H V 3 0 1 2 0	D 676
2 0 0 X V 1 5 6 0	AP07	2 0 4 Z V 5 6 0 0	AP07	2 1 6 R L 3 0 3 0	BP19	2 2 7 T V G 3 0 1 2 0	D 380
2 0 0 X V 3 0 6 0	AP01	2 0 4 Z V 6 0 6 0	AP01	2 1 6 R L 3 0 6 0	BP16	2 2 7 V 1 0 6 0	BP17
2 0 0 X V 5 6 0 0	AP07	2 0 6 B P 3 0 1 0	D 69	2 1 6 R L 5 6 0 0	BP17	2 2 7 V 1 5 6 0	BP17

2 2 7 V 2 0 6 0	BP17	2 6 4 V 6 0 6 0	BP16	3 5 0 4 C R 6 0 6 0	BP16	5 1 0 2 V 2 9 2 9	AP50
2 2 7 V 2 4 2 4	D 103	2 6 4 V 6 6 2 7	AP49	3 5 0 4 C R 9 0 9 0	BP12	5 1 0 2 V 3 0 6 0	BP03
2 2 7 V 2 7 6 6	AP49	2 6 4 V 8 4 4 2	AP48	3 5 0 4 T C G 3 0 6 0	D 289	5 1 0 2 V 4 0 6 0	BP04
2 2 7 V 2 9 2 9	AP50	2 6 4 V V 1 5 1 5	BP21	3 5 0 6 B P 6 0 1 0	D 117	5 1 0 2 V 4 9 2 6	AP50
2 2 7 V 3 0 3 0	BP19	2 6 5 B P 6 0 1 0	D 117	3 5 0 6 B P 9 0 1 0	D 249	5 1 0 2 V 5 9 2 9	AP50
2 2 7 V 3 0 6 0	BP16	2 6 5 B P 9 0 1 0	D 249	3 5 0 6 C R 3 0 6 0	BP16	5 1 0 2 V 5 9 3 0	AP49
2 2 7 V 4 9 2 6	AP50	2 6 5 T V G 3 0 1 2 0	D 380	3 5 0 6 C R 6 0 6 0	BP16	5 1 0 2 V 6 0 6 0	BP03
2 2 7 V 5 6 0 0	BP17	2 6 5 V 1 0 6 0	BP17	3 5 0 6 C R 9 0 9 0	BP12	5 1 0 2 V 6 6 2 7	AP49
2 2 7 V 5 9 2 9	AP50	2 6 5 V 1 5 6 0	BP17	3 5 0 6 T C G 3 0 6 0	D 289	5 1 0 2 V 8 4 4 2	AP48
2 2 7 V 5 9 3 0	AP49	2 6 5 V 2 0 6 0	BP17	3 5 0 8 B P 6 0 1 0	D 117	5 1 0 2 V 9 0 9 0	BP02
2 2 7 V 6 0 1 2 0	BP12	2 6 5 V 3 0 6 0	BP16	3 5 0 8 B P 9 0 1 0	D 249	5 1 0 4 B P 6 0 1 0	D 117
2 2 7 V 6 0 6 0	BP16	2 6 5 V 5 6 0 0	BP17	3 5 0 8 C R 3 0 6 0	BP16	5 1 0 4 B P 9 0 1 0	D 249
2 2 7 V 6 6 2 7	AP49	2 6 5 V 6 0 1 2 0	BP12	3 5 0 8 C R 6 0 6 0	BP16	5 1 0 4 H V 3 0 6 0	D 641
2 2 7 V 8 4 4 2	AP48	2 6 5 V 6 0 6 0	BP16	3 5 0 8 C R 9 0 9 0	BP12	5 1 0 4 T V G 3 0 6 0	D 289
2 2 9 B P 3 0 1 0	D 69	2 6 6 B P 3 0 1 0	D 69	3 5 0 8 T C G 3 0 6 0	D 289	5 1 0 4 V 3 0 6 0	BP03
2 2 9 B P 6 0 1 0	D 117	2 6 6 B P 6 0 1 0	D 117	3 5 1 0 B P 6 0 1 0	D 117	5 1 0 4 V 6 0 6 0	BP03
2 2 9 B P 9 0 1 0	D 249	2 6 6 R L 3 0 3 0	BP19	3 5 1 0 B P 9 0 1 0	D 249	5 1 0 4 V 9 0 9 0	BP02
2 2 9 H V 3 0 1 2 0	D 676	2 6 6 R M 1 5 1 5	BP21	3 5 1 0 C R 3 0 6 0	BP16	5 1 0 6 B P 6 0 1 0	D 117
2 2 9 T V G 3 0 1 2 0	D 380	2 6 6 V 1 0 6 0	BP17	3 5 1 0 C R 6 0 6 0	BP16	5 1 0 6 B P 9 0 1 0	D 249
2 2 9 V 1 0 6 0	BP17	2 6 6 V 1 5 6 0	BP17	3 5 1 0 C R 9 0 9 0	BP12	5 1 0 6 H V 3 0 6 0	D 641
2 2 9 V 1 5 6 0	BP17	2 6 6 V 2 0 6 0	BP17	3 5 1 0 T C G 3 0 6 0	D 289	5 1 0 6 M R 6 0 6 0	BP03
2 2 9 V 2 0 6 0	BP17	2 6 6 V 3 0 3 0	BP19	3 5 1 2 B P 6 0 1 0	D 117	5 1 0 6 T V G 3 0 6 0	D 289
2 2 9 V 3 0 3 0	BP19	2 6 6 V 3 0 6 0	BP16	3 5 1 2 B P 9 0 1 0	D 249	5 1 0 6 V 3 0 6 0	BP03
2 2 9 V 3 0 6 0	BP16	2 6 6 V 5 6 0 0	BP17	3 5 1 2 C R 3 0 6 0	BP16	5 1 0 6 V 6 0 6 0	BP03
2 2 9 V 5 6 0 0	BP17	2 6 6 V 6 0 6 0	BP16	3 5 1 2 C R 6 0 6 0	BP16	5 1 0 6 V 9 0 9 0	BP02
2 2 9 V 6 0 1 2 0	BP12	2 6 6 V V 1 5 1 5	BP21	3 5 1 2 C R 9 0 9 0	BP12	5 1 0 8 B P 6 0 1 0	D 117
2 2 9 V 6 0 6 0	BP16	2 6 6 X V 1 0 6 0	AP07	3 5 1 2 T C G 3 0 6 0	D 289	5 1 0 8 B P 9 0 1 0	D 249
2 2 9 V 9 0 9 0	BP12	2 6 6 X V 1 5 6 0	AP07	3 5 1 4 B P 6 0 1 0	D 117	5 1 0 8 H V 3 0 6 0	D 641
2 3 8 B P 6 0 1 0	D 117	2 6 6 X V 3 0 6 0	AP01	3 5 1 4 B P 9 0 1 0	D 249	5 1 0 8 M R 6 0 6 0	BP03
2 3 8 V 3 0 6 0	BP16	2 6 6 X V 5 6 0 0	AP07	3 5 1 4 C R 3 0 6 0	BP16	5 1 0 8 T V G 3 0 6 0	D 289
2 3 8 V 6 0 6 0	BP16	2 6 6 X V 6 0 6 0	AP01	3 5 1 4 C R 6 0 6 0	BP16	5 1 0 8 V 1 0 6 0	BP04
2 3 9 B P 6 0 1 0	D 117	2 6 6 Y V 1 0 6 0	AP07	3 5 1 4 C R 9 0 9 0	BP12	5 1 0 8 V 2 0 6 0	BP04
2 3 9 V 1 0 6 0	BP17	2 6 6 Y V 1 5 6 0	AP07	3 5 1 4 T C G 3 0 6 0	D 289	5 1 0 8 V 2 4 2 4	D 103
2 3 9 V 1 5 6 0	BP17	2 6 6 Y V 3 0 6 0	AP01	3 5 1 6 B P 6 0 1 0	D 117	5 1 0 8 V 2 7 6 6	AP49
2 3 9 V 2 0 6 0	BP17	2 6 6 Y V 5 6 0 0	AP07	3 5 1 6 B P 9 0 1 0	D 249	5 1 0 8 V 2 9 2 9	AP50
2 3 9 V 2 4 2 4	D 103	2 6 6 Y V 6 0 6 0	AP01	3 5 1 6 C R 3 0 6 0	BP16	5 1 0 8 V 3 0 6 0	BP03
2 3 9 V 2 7 6 6	AP49	2 6 6 Z V 1 0 6 0	AP07	3 5 1 6 C R 6 0 6 0	BP16	5 1 0 8 V 4 0 6 0	BP04
2 3 9 V 2 9 2 9	AP50	2 6 6 Z V 1 5 6 0	AP07	3 5 1 6 C R 9 0 9 0	BP12	5 1 0 8 V 4 9 2 6	AP50
2 3 9 V 3 0 6 0	BP16	2 6 6 Z V 3 0 6 0	AP01	3 5 1 6 T C G 3 0 6 0	D 289	5 1 0 8 V 5 9 2 9	AP50
2 3 9 V 4 9 2 6	AP50	2 6 6 Z V 5 6 0 0	AP07	3 5 1 8 B P 6 0 1 0	D 117	5 1 0 8 V 5 9 3 0	AP49
2 3 9 V 5 6 0 0	BP17	2 6 6 Z V 6 0 6 0	AP01	3 5 1 8 B P 9 0 1 0	D 249	5 1 0 8 V 6 0 6 0	BP03
2 3 9 V 5 9 2 9	AP50	2 7 0 B P 6 0 1 0	D 117	3 5 1 8 C R 3 0 6 0	BP16	5 1 0 8 V 6 6 2 7	AP49
2 3 9 V 5 9 3 0	AP49	2 7 0 V 1 0 6 0	BP17	3 5 1 8 C R 6 0 6 0	BP16	5 1 0 8 V 8 4 4 2	AP48
2 3 9 V 6 0 6 0	BP16	2 7 0 V 1 5 6 0	BP17	3 5 1 8 C R 9 0 9 0	BP12	5 1 0 8 V 9 0 9 0	BP02
2 3 9 V 6 6 2 7	AP49	2 7 0 V 2 0 6 0	BP17	3 5 1 8 T C G 3 0 6 0	D 289	5 1 1 0 B P 6 0 1 0	D 117
2 3 9 V 8 4 4 2	AP48	2 7 0 V 3 0 6 0	BP16	4 1 0 1 R Q 6 0 6 0	AP10	5 1 1 0 B P 9 0 1 0	D 249
2 6 2 B P 6 0 1 0	D 117	2 7 0 V 5 6 0 0	BP17	4 1 0 1 V 2 4 2 4	D 103	5 1 1 0 H V 3 0 6 0	D 641
2 6 2 B P 9 0 1 0	D 249	2 7 0 V 6 0 6 0	BP16	4 1 0 1 V 2 7 6 6	AP49	5 1 1 0 M R 6 0 6 0	BP03
2 6 2 H V 3 0 1 2 0	D 676	3 0 4 S P 1 5 3 0	D 76	4 1 0 1 V 2 9 2 9	AP50	5 1 1 0 T V G 3 0 6 0	D 289
2 6 2 T V G 3 0 1 2 0	D 380	3 0 6 S P 1 5 3 0	D 76	4 1 0 1 V 4 9 2 6	AP50	5 1 1 0 V 1 0 6 0	BP04
2 6 2 V 1 0 6 0	BP17	3 1 5 S P 1 5 3 0	D 76	4 1 0 1 V 5 9 2 9	AP50	5 1 1 0 V 2 0 6 0	BP04
2 6 2 V 1 5 6 0	BP17	3 1 6 S P 1 5 3 0	D 76	4 1 0 1 V 5 9 3 0	AP49	5 1 1 0 V 2 4 2 4	D 103
2 6 2 V 2 0 6 0	BP17	3 6 2 S P 1 5 3 0	D 76	4 1 0 1 V 6 0 6 0	AP10	5 1 1 0 V 2 7 6 6	AP49
2 6 2 V 2 4 2 4	D 103	1 0 0 1 - 1 0 2 0	BC05	4 1 0 1 V 6 6 2 7	AP49	5 1 1 0 V 2 9 2 9	AP50
2 6 2 V 2 7 6 6	AP49	1 0 0 3 - 1 0 1 0	D 21	4 1 0 1 V 8 4 4 2	AP48	5 1 1 0 V 3 0 6 0	BP03
2 6 2 V 2 9 2 9	AP50	1 0 1 1 - 1 0 2 0	BC05	4 1 0 2 R Q 6 0 6 0	AP10	5 1 1 0 V 4 0 6 0	BP04
2 6 2 V 3 0 6 0	BP16	1 0 1 3 - 1 0 1 0	D 21	4 1 0 2 V 2 4 2 4	D 103	5 1 1 0 V 4 9 2 6	AP50
2 6 2 V 4 9 2 6	AP50	1 1 0 1 V 1 0 6 0	CP31	4 1 0 2 V 2 7 6 6	AP49	5 1 1 0 V 5 9 2 9	AP50
2 6 2 V 5 6 0 0	BP17	1 1 0 1 V 1 5 1 5	CP34	4 1 0 2 V 2 9 2 9	AP50	5 1 1 0 V 5 9 3 0	AP49
2 6 2 V 5 9 2 9	AP50	1 1 0 1 V 1 5 6 0	CP31	4 1 0 2 V 4 9 2 6	AP50	5 1 1 0 V 6 0 6 0	BP03
2 6 2 V 5 9 3 0	AP49	1 1 0 1 V 3 0 3 0	CP33	4 1 0 2 V 5 9 2 9	AP50	5 1 1 0 V 6 6 2 7	AP49
2 6 2 V 6 0 1 2 0	BP12	1 1 0 1 V 3 0 6 0	CP30	4 1 0 2 V 5 9 3 0	AP49	5 1 1 0 V 8 4 4 2	AP48
2 6 2 V 6 0 6 0	BP16	1 1 0 1 V 4 5 4 5	CP32	4 1 0 2 V 6 0 6 0	AP10	5 1 1 0 V 9 0 9 0	BP02
2 6 2 V 6 6 2 7	AP49	1 1 0 1 V 6 0 6 0	CP30	4 1 0 2 V 6 6 2 7	AP49	5 1 1 2 B P 6 0 1 0	D 117
2 6 2 V 8 4 4 2	AP48	1 1 0 3 V 1 0 6 0	CP31	4 1 0 2 V 8 4 4 2	AP48	5 1 1 2 B P 9 0 1 0	D 249
2 6 2 V 9 0 9 0	BP12	1 1 0 3 V 1 5 1 5	CP34	4 1 0 3 R Q 6 0 6 0	AP10	5 1 1 2 H V 3 0 6 0	D 641
2 6 3 B P 6 0 1 0	D 117	1 1 0 3 V 1 5 6 0	CP31	4 1 0 3 V 6 0 6 0	AP10	5 1 1 2 T V G 3 0 6 0	D 289
2 6 3 V 1 0 6 0	BP17	1 1 0 3 V 3 0 3 0	CP33	4 1 0 4 V 6 0 6 0	AP10	5 1 1 2 V 1 0 6 0	BP04
2 6 3 V 1 5 6 0	BP17	1 1 0 3 V 3 0 6 0	CP30	4 1 0 4 V 2 4 2 4	D 103	5 1 1 2 V 2 0 6 0	BP04
2 6 3 V 2 0 6 0	BP17	1 1 0 3 V 4 5 4 5	CP32	4 1 0 4 V 2 7 6 6	AP49	5 1 1 2 V 2 4 2 4	D 103
2 6 3 V 2 4 2 4	D 103	1 1 0 3 V 6 0 6 0	CP30	4 1 0 4 V 2 9 2 9	AP50	5 1 1 2 V 2 7 6 6	AP49
2 6 3 V 2 7 6 6	AP49	1 1 0 4 V 1 0 6 0	CP31	4 1 0 4 V 4 9 2 6	AP50	5 1 1 2 V 2 9 2 9	AP50
2 6 3 V 2 9 2 9	AP50	1 1 0 4 V 1 5 1 5	CP34	4 1 0 4 V 5 9 2 9	AP50	5 1 1 2 V 3 0 6 0	BP03
2 6 3 V 3 0 6 0	BP16	1 1 0 4 V 1 5 6 0	CP31	4 1 0 4 V 5 9 3 0	AP49	5 1 1 2 V 4 0 6 0	BP04
2 6 3 V 4 9 2 6	AP50	1 1 0 4 V 3 0 3 0	CP33	4 1 0 4 V 6 0 6 0	AP10	5 1 1 2 V 4 9 2 6	AP50
2 6 3 V 5 6 0 0	BP17	1 1 0 4 V 3 0 6 0	CP30	4 1 0 4 V 6 6 2 7	AP49	5 1 1 2 V 5 9 2 9	AP50
2 6 3 V 5 9 2 9	AP50	1 1 0 4 V 4 5 4 5	CP32	4 1 0 4 V 8 4 4 2	AP48	5 1 1 2 V 5 9 3 0	AP49
2 6 3 V 5 9 3 0	AP49	1 1 0 4 V 6 0 6 0	CP30	4 1 0 5 R Q 6 0 6 0	AP10	5 1 1 2 V 6 0 6 0	BP03
2 6 3 V 6 0 6 0	BP16	1 1 0 5 V 1 0 6 0	CP31	4 1 0 5 V 6 0 6 0	AP10	5 1 1 2 V 6 6 2 7	AP49
2 6 3 V 6 6 2 7	AP49	1 1 0 5 V 1 5 1 5	CP34	4 1 0 7 R Q 6 0 6 0	AP10	5 1 1 2 V 8 4 4 2	AP48
2 6 3 V 8 4 4 2	AP48	1 1 0 5 V 1 5 6 0	CP31	4 1 0 7 V 6 0 6 0	AP10	5 1 1 2 V 9 0 9 0	BP02
2 6 4 B P 3 0 1 0	D 69	1 1 0 5 V 3 0 3 0	CP33	5 0 0 2 S P 1 5 3 0	D 82	5 1 1 4 B P 6 0 1 0	D 117
2 6 4 B P 6 0 1 0	D 117	1 1 0 5 V 3 0 6 0	CP30	5 0 0 6 S P 1 5 3 0	D 82	5 1 1 4 H V 3 0 6 0	D 641
2 6 4 R M 1 5 1 5	BP21	1 1 0 5 V 4 5 4 5	CP32	5 0 0 8 S P 1 5 3 0	D 82	5 1 1 4 M R 6 0 6 0	BP03
2 6 4 V 1 0 6 0	BP17	1 1 0 5 V 6 0 6 0	CP30	5 0 1 0 S P 1 5 3 0	D 82	5 1 1 4 T V G 3 0 6 0	D 289
2 6 4 V 1 5 6 0	BP17	2 8 8 0 L L 1 5 2 0	DC16	5 0 1 4 S P 1 5 3 0	D 82	5 1 1 4 V 3 0 6 0	BP03
2 6 4 V 2 0 6 0	BP17	2 9 0 0 L L 1 5 2 0	DC16	5 0 2 0 S P 1 5 3 0	D 82	5 1 1 4 V 6 0 6 0	BP03
2 6 4 V 2 4 2 4	D 103	3 5 0 2 B P 6 0 1 0	D 117	5 1 0 2 B P 6 0 1 0	D 117	5 1 1 8 B P 6 0 1 0	D 117
2 6 4 V 2 7 6 6	AP49	3 5 0 2 B P 9 0 1 0	D 249	5 1 0 2 B P 9 0 1 0	D 249	5 1 1 8 H V 3 0 6 0	D 641
2 6 4 V 2 9 2 9	AP50	3 5 0 2 C R 3 0 6 0	BP16	5 1 0 2 H V 3 0 6 0	D 641	5 1 1 8 T V G 3 0 6 0	D 289
2 6 4 V 3 0 3 0	BP19	3 5 0 2 C R 6 0 6 0	BP16	5 1 0 2 M R 6 0 6 0	BP03	5 1 1 8 V 3 0 6 0	BP03
2 6 4 V 3 0 6 0	BP16	3 5 0 2 C R 9 0 9 0	BP12	5 1 0 2 T V G 3 0 6 0	D 289	5 1 1 8 V 6 0 6 0	BP03
2 6 4 V 4 9 2 6	AP50	3 5 0 2 T C G 3 0 6 0	D 289	5 1 0 2 V 1 0 6 0	BP04	5 1 2 0 B P 6 0 1 0	D 117
2 6 4 V 5 6 0 0	BP17	3 5 0 4 B P 6 0 1 0	D 117	5 1 0 2 V 2 0 6 0	BP04	5 1 2 0 H V 3 0 6 0	D 641
2 6 4 V 5 9 2 9	AP50	3 5 0 4 B P 9 0 1 0	D 249	5 1 0 2 V 2 4 2 4	D 103	5 1 2 0 M R 6 0 6 0	BP03
2 6 4 V 5 9 3 0	AP49	3 5 0 4 C R 3 0 6 0	BP16	5 1 0 2 V 2 7 6 6	AP49	5 1 2 0 T V G 3 0 6 0	D 289

5 1 2 0 V 1 0 6 0	BP04	1 3 7 4 0 - 2 0 2 5	U 1	1 6 8 2 0 - 1 5 1 5	CC10	1 9 9 8 0 - 1 5 1 5	CC10
5 1 2 0 V 2 0 6 0	BP04	1 3 7 4 0 L 1 5 2 0	U 1	1 6 8 4 0 - 1 0 3 0	CC09	1 9 9 9 0 - 1 5 1 5	CC10
5 1 2 0 V 3 0 6 0	BP03	1 3 8 1 0 - 1 5 3 0	CC11	1 6 8 4 0 - 1 5 1 5	CC10	2 0 9 0 0 - 1 5 1 5	CC10
5 1 2 0 V 4 0 6 0	BP04	1 3 8 3 0 - 1 5 3 0	CC11	1 6 8 4 0 - 1 5 3 0	CC09	2 0 9 1 0 - 1 5 1 5	CC10
5 1 2 0 V 6 0 6 0	BP03	1 5 0 1 0 - 1 0 1 0	CC13	1 6 8 5 0 - 1 0 1 0	CC13	2 0 9 2 0 - 1 5 1 5	CC10
5 1 2 6 B P 6 0 1 0	D 117	1 5 0 1 0 - 1 0 3 0	CC09	1 6 8 5 0 - 1 0 3 0	CC09	2 0 9 3 0 - 1 5 1 5	CC10
5 1 2 6 H V 3 0 6 0	D 641	1 5 0 1 0 - 1 5 1 5	CC10	1 6 8 5 0 - 1 5 1 5	CC10	2 0 9 4 0 - 1 5 1 5	CC10
5 1 2 6 T V G 3 0 6 0	D 289	1 5 0 1 0 - 1 5 3 0	CC09	1 6 8 5 0 - 1 5 3 0	CC09	2 0 9 5 0 - 1 5 1 5	CC10
5 1 2 6 V 1 0 6 0	BP04	1 5 0 2 0 - 1 5 1 5	CC10	1 6 8 6 0 - 1 0 3 0	CC09	2 0 9 6 0 - 1 5 1 5	CC10
5 1 2 6 V 2 0 6 0	BP04	1 5 0 3 0 - 1 0 3 0	CC09	1 6 8 6 0 - 1 5 1 5	CC10	2 0 9 7 0 - 1 5 1 5	CC10
5 1 2 6 V 2 4 2 4	D 103	1 5 0 3 0 - 1 5 1 5	CC10	1 6 8 6 0 - 1 5 3 0	CC09	2 0 9 8 0 - 1 5 1 5	CC10
5 1 2 6 V 2 7 6 6	AP49	1 5 0 4 0 - 1 5 1 5	CC10	1 6 8 7 0 - 1 0 3 0	CC09	2 0 9 9 0 - 1 5 1 5	CC10
5 1 2 6 V 2 9 2 9	AP50	1 5 0 5 0 - 1 0 3 0	CC09	1 6 8 8 0 - 1 5 1 5	CC10	2 5 2 4 0 - 1 0 3 0	CC09
5 1 2 6 V 3 0 6 0	BP03	1 5 0 5 0 - 1 5 1 5	CC10	1 6 8 7 0 - 1 5 3 0	U 1	2 5 2 4 0 - 1 5 1 5	CC10
5 1 2 6 V 4 0 6 0	BP04	1 5 0 6 0 - 1 5 1 5	CC10	1 6 8 7 0 - 2 0 2 5	U 1	2 5 2 5 0 - 1 0 3 0	CC09
5 1 2 6 V 4 9 2 6	AP50	1 5 0 7 0 - 1 5 1 5	CC10	1 6 8 7 0 L 1 5 2 0	U 1	2 5 2 5 0 - 1 5 1 5	CC10
5 1 2 6 V 5 9 2 9	AP50	1 5 0 8 0 - 1 5 1 5	CC10	1 6 8 8 0 - 1 0 1 0	CC13	2 5 2 6 0 - 1 5 1 5	CC10
5 1 2 6 V 5 9 3 0	AP49	1 5 0 9 0 - 1 5 1 5	CC10	1 6 8 8 0 - 1 0 3 0	CC09	2 6 2 4 0 - 1 0 3 0	CC09
5 1 2 6 V 6 0 6 0	BP03	1 5 1 0 0 - 1 5 1 5	CC10	1 6 8 8 0 - 1 5 1 5	CC10	2 6 2 4 0 - 1 5 1 5	CC10
5 1 2 6 V 6 6 2 7	AP49	1 5 1 1 0 - 1 5 1 5	CC10	1 6 8 8 0 - 1 5 3 0	CC09	2 6 2 4 0 - 1 5 3 0	CC09
5 1 2 6 V 8 4 4 2	AP48	1 5 1 2 0 - 1 5 1 5	CC10	1 6 8 9 0 - 1 5 3 0	U 1	2 6 2 5 0 - 1 0 3 0	CC09
6 1 1 0 M R 1 5 1 5	BP22	1 5 1 3 0 - 1 5 1 5	CC10	1 6 8 9 0 - 2 0 2 5	U 1	2 6 2 5 0 - 1 5 1 5	CC10
6 1 1 0 V 1 5 1 5	BP22	1 5 1 4 0 - 1 5 1 5	CC10	1 6 8 9 0 L 1 5 2 0	U 1	2 6 2 5 0 - 1 5 3 0	CC09
6 1 1 1 V 1 5 1 5	BP22	1 5 1 5 0 - 1 5 1 5	CC10	1 6 9 0 0 - 1 0 1 0	CC13	2 6 2 6 0 - 1 5 1 5	CC10
6 1 1 2 V 1 5 1 5	BP22	1 5 1 6 0 - 1 5 1 5	CC10	1 6 9 0 0 - 1 0 3 0	CC09	2 7 0 1 0 - 1 5 3 0	DC17
6 1 1 4 D I 8 2	D 59	1 5 1 7 0 - 1 5 1 5	CC10	1 6 9 0 0 - 1 5 1 5	CC10	2 7 0 1 0 - 3 0 4 5	DC17
6 1 1 4 D P 8 1 5	D 38	1 5 1 8 0 - 1 5 1 5	CC10	1 6 9 0 0 - 1 5 3 0	CC09	2 7 0 1 0 - 3 0 6 0 - A	DC20
6 1 1 4 D U 8 2	D 59	1 5 2 0 0 - 1 0 3 0	CC09	1 6 9 0 1 - 1 0 1 0	AC01	2 7 0 2 0 - 1 5 3 0	DC17
6 1 1 4 S P 1 5 1 5	D 50	1 5 2 0 0 - 1 5 1 5	CC10	1 6 9 0 2 - 1 0 1 0	AC01	2 7 0 2 0 - 3 0 4 5	DC17
6 1 2 0 M R 1 5 1 5	BP22	1 5 2 0 0 - 1 5 3 0	CC09	1 6 9 0 3 - 1 0 1 0	AC01	2 7 0 2 0 - 3 0 6 0 - A	DC20
6 1 2 0 V 1 5 1 5	BP22	1 5 2 1 0 - 1 0 3 0	CC09	1 6 9 0 4 - 1 0 1 0	AC01	2 7 0 4 0 - 1 5 3 0	DC17
6 1 2 1 V 1 5 1 5	BP22	1 5 2 1 0 - 1 5 1 5	CC10	1 6 9 0 5 - 1 0 1 0	AC01	2 7 0 4 0 - 3 0 4 5	DC17
6 1 2 2 V 1 5 1 5	BP22	1 5 2 2 0 - 1 0 3 0	CC09	1 6 9 0 6 - 1 0 1 0	AC01	2 7 0 4 0 - 3 0 6 0 - A	DC20
6 1 2 4 D I 8 2	D 59	1 5 2 2 0 - 1 5 1 5	CC10	1 6 9 1 0 - 1 0 1 0	CC13	2 7 5 1 0 - 1 5 3 0	DC17
6 1 2 4 D P 8 1 5	D 38	1 5 2 2 0 - 1 5 3 0	CC09	1 6 9 1 0 - 1 0 3 0	CC09	2 7 5 1 0 - 3 0 4 5	DC17
6 1 2 4 D U 8 2	D 59	1 5 2 3 0 - 1 0 3 0	CC09	1 6 9 1 0 - 1 5 1 5	CC10	2 7 5 1 0 - 3 0 6 0 - A	DC20
6 1 2 4 S P 1 5 1 5	D 50	1 5 2 3 0 - 1 5 1 5	CC10	1 6 9 1 0 - 1 5 3 0	CC09	2 7 5 2 0 - 1 5 3 0	DC17
6 1 3 0 M R 1 5 1 5	BP22	1 5 2 4 0 - 1 0 3 0	CC09	1 6 9 2 0 - 1 5 1 5	CC10	2 7 5 2 0 - 3 0 4 5	DC17
6 1 3 0 V 1 5 1 5	BP22	1 5 2 4 0 - 1 5 1 5	CC10	1 6 9 3 0 - 1 5 1 5	CC10	2 7 5 2 0 - 3 0 6 0 - A	DC20
6 1 3 1 V 1 5 1 5	BP22	1 5 2 5 0 - 1 5 3 0	CC11	1 6 9 4 0 - 1 5 1 5	CC10	2 7 5 4 0 - 1 5 3 0	DC17
6 1 3 2 V 1 5 1 5	BP22	1 5 2 6 0 - 1 5 3 0	CC11	1 6 9 5 0 - 1 0 3 0	CC09	2 7 5 4 0 - 3 0 4 5	DC17
6 1 3 4 D I 8 2	D 59	1 5 2 7 0 - 1 5 3 0	CC11	1 6 9 5 0 S 1 5 1 5	CC10	2 7 5 4 0 - 3 0 6 0 - A	DC20
6 1 3 4 D P 8 1 5	D 38	1 5 8 1 0 - 1 5 1 5	BC06	1 6 9 7 0 - 1 5 1 5	CC10	3 0 0 1 0 - 1 5 1 5	CC08
6 1 3 4 D U 8 2	D 59	1 5 8 1 0 - 1 5 3 0	BC06	1 6 9 8 0 - 1 0 3 0	CC09	3 0 0 1 0 - 1 5 3 0	CC08
6 1 3 4 S P 1 5 1 5	D 50	1 5 8 2 0 - 1 5 1 5	BC06	1 6 9 8 0 - 1 5 1 5	CC10	3 0 0 1 0 - 3 0 3 0	CC08
6 1 4 0 M R 1 5 1 5	BP22	1 5 8 2 0 - 1 5 3 0	BC06	1 6 9 9 0 - 1 5 1 5	CC10	3 0 0 2 0 - 1 5 3 0	CC08
6 1 4 0 V 1 5 1 5	BP22	1 5 8 3 0 - 1 5 1 5	BC06	1 7 0 5 0 - 1 5 3 0	U 1	3 0 0 3 0 - 1 5 1 5	CC08
6 1 4 1 V 1 5 1 5	BP22	1 5 8 3 0 - 1 5 3 0	BC06	1 7 0 5 0 - 2 0 2 5	U 1	3 0 0 4 0 - 1 5 3 0	CC08
6 1 4 2 V 1 5 1 5	BP22	1 5 8 4 0 - 1 5 1 5	BC06	1 7 0 5 0 L 1 5 2 0	U 1	3 0 0 5 0 - 1 5 1 5	CC08
6 1 4 4 D I 8 2	D 59	1 5 8 4 0 - 1 5 3 0	BC06	1 7 0 6 0 - 1 5 3 0	U 1	3 0 0 6 0 - 1 5 3 0	CC08
6 1 4 4 D P 8 1 5	D 38	1 5 8 5 0 - 1 5 1 5	BC06	1 7 0 6 0 - 2 0 2 5	U 1	3 0 0 7 0 - 1 5 1 5	CC08
6 1 4 4 D U 8 2	D 59	1 5 8 5 0 - 1 5 3 0	BC06	1 7 0 6 0 L 1 5 2 0	U 1	3 0 0 8 0 - 1 5 3 0	CC08
6 1 4 4 S P 1 5 1 5	D 50	1 5 8 9 0 - 1 5 1 5	BC06	1 7 0 7 0 - 1 5 3 0	U 1	3 0 0 9 0 - 1 5 1 5	CC08
6 1 5 0 M R 1 5 1 5	BP22	1 5 8 9 0 - 1 5 3 0	BC06	1 7 0 7 0 - 2 0 2 5	U 1	3 0 1 0 0 - 1 5 3 0	CC08
6 1 5 0 V 1 5 1 5	BP22	1 5 9 1 0 - 1 5 1 5	BC06	1 7 0 7 0 L 1 5 2 0	U 1	3 0 1 1 0 - 1 5 1 5	CC08
6 1 5 1 V 1 5 1 5	BP22	1 5 9 2 0 - 1 5 1 5	BC06	1 7 0 9 0 - 1 5 3 0	CC11	3 0 1 2 0 - 1 5 3 0	CC08
6 1 5 2 V 1 5 1 5	BP22	1 5 9 3 0 - 1 5 1 5	BC06	1 7 0 9 0 - 2 0 2 5	DC11	3 0 1 3 0 - 1 5 1 5	CC08
6 1 5 4 D I 8 2	D 59	1 5 9 4 0 - 1 5 1 5	BC06	1 7 0 9 0 L 1 5 2 0	DC11	3 0 5 1 0 - 1 5 1 5	CC08
6 1 5 4 D P 8 1 5	D 38	1 5 9 5 0 - 1 5 1 5	BC06	1 7 9 0 0 - 1 0 1 0	CC13	3 0 5 1 0 - 1 5 3 0	CC08
6 1 5 4 D U 8 2	D 59	1 5 9 5 0 - 1 5 3 0	BC06	1 7 9 0 0 - 1 0 3 0	CC09	3 0 5 1 0 - 3 0 3 0	CC08
6 1 5 4 S P 1 5 1 5	D 50	1 5 9 6 0 - 1 5 1 5	BC06	1 7 9 0 0 - 1 5 1 5	CC10	3 0 5 2 0 - 1 5 1 5	CC08
6 1 6 0 M R 1 5 1 5	BP22	1 5 9 6 0 - 1 5 3 0	BC06	1 7 9 0 0 - 1 5 3 0	CC09	3 0 5 3 0 - 1 5 3 0	CC08
6 1 6 0 V 1 5 1 5	BP22	1 6 6 1 0 - 1 0 3 0	CC09	1 7 9 1 0 - 1 5 1 5	CC10	3 0 5 4 0 - 1 5 1 5	CC08
6 1 6 1 V 1 5 1 5	BP22	1 6 6 1 0 - 1 5 1 5	CC10	1 7 9 2 0 - 1 0 1 0	CC13	3 0 5 5 0 - 1 5 3 0	CC08
6 1 6 2 V 1 5 1 5	BP22	1 6 6 1 0 - 1 5 3 0	CC09	1 7 9 2 0 - 1 5 1 5	CC10	3 0 5 6 0 - 1 5 1 5	CC08
6 1 6 4 D I 8 2	D 59	1 6 6 2 0 - 1 5 1 5	CC10	1 7 9 3 0 - 1 5 1 5	CC10	3 0 5 7 0 - 1 5 3 0	CC08
6 1 6 4 D P 8 1 5	D 38	1 6 6 3 0 - 1 0 3 0	CC09	1 7 9 4 0 - 1 0 1 0	CC13	3 0 5 8 0 - 1 5 1 5	CC08
6 1 6 4 D U 8 2	D 59	1 6 6 3 0 - 1 5 1 5	CC10	1 7 9 4 0 - 1 5 1 5	CC10	3 0 5 9 0 - 1 5 3 0	CC08
6 1 6 4 S P 1 5 1 5	D 50	1 6 6 3 0 - 1 5 3 0	CC09	1 7 9 5 0 - 1 0 1 0	CC13	3 0 6 0 0 - 1 5 1 5	CC08
6 1 7 0 M R 1 5 1 5	BP22	1 6 6 4 0 - 1 5 1 5	CC10	1 7 9 5 0 - 1 5 1 5	CC10	3 0 6 1 0 - 1 5 3 0	CC08
6 1 7 0 V 1 5 1 5	BP22	1 6 6 5 0 - 1 0 3 0	CC09	1 7 9 6 0 - 1 0 1 0	CC13	3 0 6 2 0 - 1 5 1 5	CC08
6 1 7 1 V 1 5 1 5	BP22	1 6 6 5 0 - 1 5 1 5	CC10	1 7 9 6 0 - 1 5 1 5	CC10	3 0 6 3 0 - 1 5 3 0	CC08
6 1 7 2 V 1 5 1 5	BP22	1 6 6 5 0 - 1 5 3 0	CC09	1 7 9 7 0 - 1 0 1 0	CC13	3 1 0 1 0 - 3 0 6 0 - A	CC07
6 1 7 4 D I 8 2	D 59	1 6 6 6 0 - 1 0 1 0	CC13	1 7 9 7 0 - 1 5 1 5	CC10	3 1 0 5 0 - 3 0 6 0 - A	CC07
6 1 7 4 D P 8 1 5	D 38	1 6 6 6 0 - 1 5 1 5	CC10	1 7 9 8 0 - 1 5 1 5	CC10	3 1 0 7 0 - 3 0 6 0 - A	CC07
6 1 7 4 D U 8 2	D 59	1 6 6 6 0 - 1 5 3 0	CC09	1 7 9 9 0 - 1 0 1 0	CC13	3 1 1 3 0 - 3 0 6 0 - A	CC07
6 1 7 4 S P 1 5 1 5	D 50	1 6 6 7 0 - 1 5 1 5	CC10	1 7 9 9 0 - 1 5 1 5	CC10	3 1 5 1 0 - 3 0 6 0 - A	CC07
6 4 0 0 - 1 0 1 0	CC13	1 6 6 8 0 - 1 5 1 5	CC10	1 8 9 0 0 - 1 5 1 5	CC10	3 1 5 4 0 - 3 0 6 0 - A	CC07
6 4 0 0 - 1 5 1 5	CC10	1 6 6 8 0 - 1 5 3 0	CC09	1 8 9 1 0 - 1 0 1 0	CC13	3 1 5 6 0 - 3 0 6 0 - A	CC07
7 8 2 0 - 1 5 1 5	BC04	1 6 6 9 0 - 1 5 1 5	CC10	1 8 9 1 0 - 1 5 1 5	CC10	3 1 6 2 0 - 3 0 6 0 - A	CC07
7 8 2 0 H A 1 5 1 5	D 38	1 6 6 9 0 - 1 5 3 0	CC09	1 8 9 2 0 - 1 5 1 5	CC10	3 2 0 1 0 - 1 5 1 5	CC08
7 8 2 0 R A 1 5 1 5	D 38	1 6 7 0 0 - 1 5 1 5	CC10	1 8 9 3 0 - 1 5 1 5	CC10	3 2 0 2 0 - 1 5 3 0	CC08
7 8 5 1 - 1 5 3	D 38	1 6 7 1 0 - 1 5 1 5	CC10	1 8 9 4 0 - 1 5 1 5	CC10	3 2 0 3 0 - 1 5 1 5	CC08
8 3 1 4 - 1 5 3	D 16	1 6 7 2 0 - 1 5 1 5	CC10	1 8 9 5 0 - 1 5 1 5	CC10	3 2 0 4 0 - 1 5 3 0	CC08
8 3 1 4 M 1 5 3	D 16	1 6 7 3 0 - 1 5 1 5	CC10	1 8 9 6 0 - 1 5 1 5	CC10	3 2 0 9 0 - 1 5 1 5	CC08
8 3 3 4 - 1 5 5	D 21	1 6 7 4 0 - 1 5 1 5	CC10	1 8 9 7 0 - 1 5 1 5	CC10	3 2 1 0 0 - 1 5 3 0	CC08
8 3 6 4 - 2 0 4	D 28	1 6 7 4 0 - 1 5 3 0	CC09	1 8 9 8 0 - 1 5 1 5	CC10	3 2 1 1 0 - 1 5 1 5	CC08
1 3 0 0 0 - 1 0 3 0	CC09	1 6 7 5 0 - 1 5 1 5	CC10	1 8 9 9 0 - 1 5 1 5	CC10	3 2 1 2 0 - 1 5 3 0	CC08
1 3 6 1 0 - 1 5 3 0	CC11	1 6 7 6 0 - 1 5 1 5	CC10	1 9 9 0 0 - 1 5 1 5	CC10	3 2 1 3 0 - 1 5 1 5	CC08
1 3 6 3 0 - 1 5 3 0	CC11	1 6 7 6 0 - 1 5 3 0	CC09	1 9 9 1 0 - 1 5 1 5	CC10	3 2 1 4 0 - 1 5 3 0	CC08
1 3 6 4 0 - 1 5 3 0	CC11	1 6 7 7 0 - 1 5 1 5	CC10	1 9 9 2 0 - 1 5 1 5	CC10	3 2 1 8 0 - 1 5 3 0	CC08
1 3 7 1 0 - 1 5 3 0	CC11	1 6 7 8 0 - 1 5 1 5	CC10	1 9 9 3 0 - 1 5 1 5	CC10	3 2 2 0 0 - 1 5 3 0	CC08
1 3 7 3 0 - 1 5 3 0	CC11	1 6 7 9 0 - 1 5 1 5	CC10	1 9 9 4 0 - 1 5 1 5	CC10	3 2 2 4 0 - 1 5 3 0	CC08
1 3 7 3 0 - 2 0 2 5	DC11	1 6 7 9 0 - 1 5 3 0	CC09	1 9 9 5 0 - 1 5 1 5	CC10	3 2 2 5 0 - 1 5 1 5	CC08
1 3 7 3 0 L 1 5 2 0	DC11	1 6 8 0 0 - 1 5 1 5	CC10	1 9 9 6 0 - 1 5 1 5	CC10	3 2 2 6 0 - 1 5 3 0	CC08
1 3 7 4 0 - 1 5 3 0	U 1	1 6 8 1 0 - 1 5 1 5	CC10	1 9 9 7 0 - 1 5 1 5	CC10	3 2 2 7 0 - 1 5 1 5	CC08

3 2 2 8 0 - 1 5 3 0	CC08	7 4 0 7 0 D P 8 1 5	D38	7 5 1 1 0 V 1 5 1 5	CP27	7 5 2 3 0 H D 1 5 1 5	D92
3 2 2 9 0 - 1 5 1 5	CC08	7 4 0 7 0 D U 8 2	D59	7 5 1 1 0 V 3 0 3 0	CP27	7 5 2 3 0 I 1 0 4	D65
3 2 3 0 0 - 1 5 3 0	CC08	7 4 0 7 0 H S 1 5 1 5	D92	7 5 1 1 0 V D 1 5 1 5	D92	7 5 2 3 0 P 1 0 1 0	D31
3 2 3 2 0 - 1 5 3 0	CC08	7 4 0 7 0 L S 1 5 1 5	CP23	7 5 1 2 0 D I 8 2	D59	7 5 2 3 0 S P 1 5 1 5	D50
3 4 0 4 0 - 1 5 3 0	AC31	7 4 0 7 0 L S 3 0 3 0	CP23	7 5 1 2 0 D P 8 1 5	D38	7 5 2 3 0 U 1 0 3	D65
3 4 5 1 0 - 1 5 1 5	AC32	7 4 0 7 0 V 1 5 1 5	CP23	7 5 1 2 0 D U 8 2	D59	7 5 2 3 0 V 1 0 1 0	CP28
3 4 5 1 0 - 1 5 3 0	AC31	7 4 0 7 0 V S 1 5 1 5	D92	7 5 1 2 0 H D 1 5 1 5	D92	7 5 2 3 0 V 1 5 1 5	CP27
3 4 5 3 0 - 1 5 1 5	AC32	7 4 0 9 0 D I 8 2	D59	7 5 1 2 0 S P 1 5 1 5	D50	7 5 2 3 0 V 3 0 3 0	CP27
3 4 5 5 0 - 1 5 3 0	AC31	7 4 0 9 0 D P 8 1 5	D38	7 5 1 2 0 V 1 5 1 5	CP27	7 5 2 3 0 V D 1 5 1 5	D92
3 4 5 8 0 - 1 5 1 5	AC32	7 4 0 9 0 D U 8 2	D59	7 5 1 2 0 V 3 0 3 0	CP27	7 5 4 2 0 D I 8 2	D59
3 6 0 1 0 - 1 5 1 5	AC03	7 4 0 9 0 H S 1 5 1 5	D92	7 5 1 2 0 V D 1 5 1 5	D92	7 5 4 2 0 D P 8 1 5	D38
3 6 0 1 0 - 1 5 3 0	AC02	7 4 0 9 0 L S 1 5 1 5	CP23	7 5 1 3 0 D I 8 2	D59	7 5 4 2 0 D U 8 2	D59
3 6 0 2 0 - 1 5 1 5	AC03	7 4 0 9 0 L S 3 0 3 0	CP23	7 5 1 3 0 D P 8 1 5	D38	7 5 4 2 0 S P 1 5 1 5	D50
3 6 0 3 0 - 1 5 1 5	AC03	7 4 0 9 0 V 1 5 1 5	CP23	7 5 1 3 0 D U 8 2	D59	7 5 4 2 0 V 1 5 1 5	CP26
3 6 0 5 0 - 1 5 3 0	AC02	7 4 0 9 0 V 3 0 3 0	CP23	7 5 1 3 0 H D 1 5 1 5	D92	7 5 4 2 0 V 3 0 3 0	CP25
3 6 0 8 0 - 1 5 3 0	AC02	7 4 0 9 0 V S 1 5 1 5	D92	7 5 1 3 0 S P 1 5 1 5	D50	7 5 4 3 0 A S 1 5 1 5	CP26
3 6 5 1 0 - 1 5 1 5	AC03	7 4 1 1 0 D I 8 2	D59	7 5 1 3 0 V 1 5 1 5	CP27	7 5 4 3 0 D I 8 2	D59
3 6 5 1 0 - 1 5 3 0	AC02	7 4 1 1 0 D P 8 1 5	D38	7 5 1 3 0 V 3 0 3 0	CP27	7 5 4 3 0 D P 8 1 5	D38
3 8 0 1 0 - 1 5 1 5	BC04	7 4 1 1 0 D U 8 2	D59	7 5 1 3 0 V D 1 5 1 5	D92	7 5 4 3 0 D U 8 2	D59
3 8 0 1 0 - 1 5 3 0	BC04	7 4 1 1 0 H S 1 5 1 5	D92	7 5 1 4 0 D I 8 2	D59	7 5 4 3 0 S P 1 5 1 5	D50
3 8 0 1 0 - 3 0 3 0	BC04	7 4 1 1 0 L S 1 5 1 5	CP23	7 5 1 4 0 D P 8 1 5	D38	7 5 4 3 0 V 1 5 1 5	CP26
3 8 0 4 0 - 1 5 1 5	BC04	7 4 1 1 0 V 1 5 1 5	CP23	7 5 1 4 0 D U 8 2	D59	7 5 4 3 0 V 3 0 3 0	CP25
3 8 0 4 0 - 1 5 3 0	BC04	7 4 1 1 0 V S 1 5 1 5	D92	7 5 1 4 0 S P 1 5 1 5	D50	7 5 4 4 0 A S 1 5 1 5	CP26
3 8 0 4 0 - 3 0 3 0	BC04	7 5 0 2 0 D I 8 2	D59	7 5 1 4 0 V 1 5 1 5	CP27	7 5 4 4 0 D I 8 2	D59
3 8 0 5 0 - 1 5 1 5	BC04	7 5 0 2 0 D P 8 1 5	D38	7 5 1 4 0 V 3 0 3 0	CP27	7 5 4 4 0 D P 8 1 5	D38
3 8 0 5 0 - 1 5 3 0	BC04	7 5 0 2 0 D U 8 2	D59	7 5 1 5 0 D I 8 2	D59	7 5 4 4 0 D U 8 2	D59
3 8 0 5 0 - 3 0 3 0	BC04	7 5 0 2 0 S P 1 5 1 5	D50	7 5 1 5 0 D P 8 1 5	D38	7 5 4 4 0 S P 1 5 1 5	D50
3 8 0 6 0 - 1 5 3 0	BC04	7 5 0 2 0 V 1 5 1 5	CP27	7 5 1 5 0 D U 8 2	D59	7 5 4 4 0 V 1 5 1 5	CP26
3 8 0 7 0 - 1 5 1 5	BC04	7 5 0 2 0 V 3 0 3 0	CP27	7 5 1 5 0 S P 1 5 1 5	D50	7 5 4 4 0 V 3 0 3 0	CP25
3 8 0 7 0 - 1 5 3 0	BC04	7 5 0 3 0 D I 8 2	D59	7 5 1 5 0 V 1 5 1 5	CP27	7 5 4 5 0 D I 8 2	D59
3 8 0 7 0 - 3 0 3 0	BC04	7 5 0 3 0 D P 8 1 5	D38	7 5 1 5 0 V 3 0 3 0	CP27	7 5 4 5 0 D P 8 1 5	D38
3 8 5 1 0 - 1 5 1 5	BC04	7 5 0 3 0 D U 8 2	D59	7 5 1 6 0 D I 8 2	D59	7 5 4 5 0 D U 8 2	D59
3 8 5 1 0 - 1 5 3 0	BC04	7 5 0 3 0 H D 1 5 1 5	D92	7 5 1 6 0 D P 8 1 5	D38	7 5 4 5 0 S P 1 5 1 5	D50
3 8 5 1 0 - 3 0 3 0	BC04	7 5 0 3 0 S P 1 5 1 5	D50	7 5 1 6 0 D U 8 2	D59	7 5 4 5 0 T R 3 0 3 0	D148
3 8 5 2 0 - 1 5 1 5	BC04	7 5 0 3 0 V 1 5 1 5	CP27	7 5 1 6 0 H D 1 5 1 5	D92	7 5 4 5 0 V 1 5 1 5	CP26
3 8 5 2 0 - 1 5 3 0	BC04	7 5 0 3 0 V 3 0 3 0	CP27	7 5 1 6 0 S P 1 5 1 5	D50	7 5 4 5 0 V 3 0 3 0	CP25
3 8 5 2 0 - 3 0 3 0	BC04	7 5 0 3 0 V D 1 5 1 5	D92	7 5 1 6 0 V 1 5 1 5	CP27	7 5 4 6 0 A S 1 5 1 5	CP26
3 8 5 3 0 - 1 5 1 5	BC04	7 5 0 4 0 D I 8 2	D59	7 5 1 6 0 V 3 0 3 0	CP27	7 5 4 6 0 D I 8 2	D59
3 8 5 3 0 - 1 5 3 0	BC04	7 5 0 4 0 D P 8 1 5	D38	7 5 1 6 0 V D 1 5 1 5	D92	7 5 4 6 0 D P 8 1 5	D38
3 8 5 3 0 - 3 0 3 0	BC04	7 5 0 4 0 D U 8 2	D59	7 5 1 7 0 D I 8 2	D59	7 5 4 6 0 D U 8 2	D59
4 5 2 1 0 L 1 5 2 0	DC16	7 5 0 4 0 H D 1 5 1 5	D92	7 5 1 7 0 D P 8 1 5	D38	7 5 4 6 0 S P 1 5 1 5	D50
4 5 2 2 0 L 1 5 2 0	DC16	7 5 0 4 0 S P 1 5 1 5	D50	7 5 1 7 0 D U 8 2	D59	7 5 4 6 0 V 1 5 1 5	CP26
4 5 2 6 0 - 2 0 2 5	DC16	7 5 0 4 0 V 1 5 1 5	CP27	7 5 1 7 0 H D 1 5 1 5	D92	7 5 4 6 0 V 3 0 3 0	CP25
4 5 2 6 0 L 1 5 2 0	DC16	7 5 0 4 0 V 3 0 3 0	CP27	7 5 1 7 0 S P 1 5 1 5	D50	7 5 4 7 0 A S 1 5 1 5	CP26
4 5 2 7 0 - 2 0 2 5	DC16	7 5 0 4 0 V D 1 5 1 5	D92	7 5 1 7 0 V 1 5 1 5	CP27	7 5 4 7 0 D I 8 2	D59
4 5 2 7 0 L 1 5 2 0	DC16	7 5 0 5 0 D I 8 2	D59	7 5 1 7 0 V 3 0 3 0	CP27	7 5 4 7 0 D P 8 1 5	D38
7 4 0 0 0 D I 8 2	D59	7 5 0 5 0 D P 8 1 5	D38	7 5 1 7 0 V D 1 5 1 5	D92	7 5 4 7 0 D U 8 2	D59
7 4 0 0 0 D P 8 1 5	D38	7 5 0 5 0 D U 8 2	D59	7 5 1 8 0 D I 8 2	D59	7 5 4 7 0 S P 1 5 1 5	D50
7 4 0 0 0 D U 8 2	D59	7 5 0 5 0 S P 1 5 1 5	D50	7 5 1 8 0 D P 8 1 5	D38	7 5 4 7 0 V 1 5 1 5	CP26
7 4 0 0 0 H S 1 5 1 5	D92	7 5 0 5 0 V 1 5 1 5	CP27	7 5 1 8 0 D U 8 2	D59	7 5 4 7 0 V 3 0 3 0	CP25
7 4 0 0 0 L S 1 5 1 5	CP23	7 5 0 5 0 V 3 0 3 0	CP27	7 5 1 8 0 S P 1 5 1 5	D50	7 5 4 8 0 D I 8 2	D59
7 4 0 0 0 L S 3 0 3 0	CP23	7 5 0 6 0 D I 8 2	D59	7 5 1 8 0 V 1 5 1 5	CP27	7 5 4 8 0 D P 8 1 5	D38
7 4 0 0 0 V 1 5 1 5	CP23	7 5 0 6 0 D P 8 1 5	D38	7 5 1 8 0 V 3 0 3 0	CP27	7 5 4 8 0 D U 8 2	D59
7 4 0 0 0 V S 1 5 1 5	D92	7 5 0 6 0 D U 8 2	D59	7 5 2 0 0 D I 8 2	D59	7 5 4 8 0 S P 1 5 1 5	D50
7 4 0 2 0 D I 8 2	D59	7 5 0 6 0 H D 1 5 1 5	D92	7 5 2 0 0 D P 8 1 5	D38	7 5 4 8 0 V 1 5 1 5	CP26
7 4 0 2 0 D P 8 1 5	D38	7 5 0 6 0 S P 1 5 1 5	D50	7 5 2 0 0 D U 8 2	D59	7 5 4 8 0 V 3 0 3 0	CP25
7 4 0 2 0 D U 8 2	D59	7 5 0 6 0 V 1 5 1 5	CP27	7 5 2 0 0 H D 1 5 1 5	D92	7 5 4 9 0 D I 8 2	D59
7 4 0 2 0 H S 1 5 1 5	D92	7 5 0 6 0 V 3 0 3 0	CP27	7 5 2 0 0 I 1 0 4	D65	7 5 4 9 0 D P 8 1 5	D38
7 4 0 2 0 L S 1 5 1 5	CP23	7 5 0 6 0 V D 1 5 1 5	D92	7 5 2 0 0 P 1 0 1 0	D31	7 5 4 9 0 D U 8 2	D59
7 4 0 2 0 L S 3 0 3 0	CP23	7 5 0 7 0 D I 8 2	D59	7 5 2 0 0 S P 1 5 1 5	D50	7 5 4 9 0 S P 1 5 1 5	D50
7 4 0 2 0 V 1 5 1 5	CP23	7 5 0 7 0 D P 8 1 5	D38	7 5 2 0 0 U 1 0 3	D65	7 5 4 9 0 V 1 5 1 5	CP26
7 4 0 2 0 V S 1 5 1 5	D92	7 5 0 7 0 D U 8 2	D59	7 5 2 0 0 V 1 0 1 0	CP28	7 5 4 9 0 V 3 0 3 0	CP25
7 4 0 3 0 D I 8 2	D59	7 5 0 7 0 H D 1 5 1 5	D92	7 5 2 0 0 V 1 5 1 5	CP27	7 5 5 0 0 A S 1 5 1 5	CP26
7 4 0 3 0 D P 8 1 5	D38	7 5 0 7 0 I 1 0 4	D65	7 5 2 0 0 V 3 0 3 0	CP27	7 5 5 0 0 D I 8 2	D59
7 4 0 3 0 D U 8 2	D59	7 5 0 7 0 P 1 0 1 0	D31	7 5 2 0 0 V D 1 5 1 5	D92	7 5 5 0 0 D P 8 1 5	D38
7 4 0 3 0 H S 1 5 1 5	D92	7 5 0 7 0 S P 1 5 1 5	D50	7 5 2 0 1 G L 3 0 3 0	D248	7 5 5 0 0 D U 8 2	D59
7 4 0 3 0 L S 1 5 1 5	CP23	7 5 0 7 0 U 1 0 3	D65	7 5 2 0 1 G S 3 0 3 0	D248	7 5 5 0 0 S P 1 5 1 5	D50
7 4 0 3 0 L S 3 0 3 0	CP23	7 5 0 7 0 V 1 0 1 0	CP28	7 5 2 1 0 D I 8 2	D59	7 5 5 0 0 V 1 5 1 5	CP26
7 4 0 3 0 V 1 5 1 5	CP23	7 5 0 7 0 V 1 5 1 5	CP27	7 5 2 1 0 D P 8 1 5	D38	7 5 5 0 0 V 3 0 3 0	CP25
7 4 0 3 0 V 3 0 3 0	CP23	7 5 0 7 0 V 3 0 3 0	CP27	7 5 2 1 0 D U 8 2	D59	7 5 5 1 0 A S 1 5 1 5	CP26
7 4 0 3 0 V S 1 5 1 5	D92	7 5 0 7 0 V D 1 5 1 5	D92	7 5 2 1 0 H D 1 5 1 5	D92	7 5 5 1 0 D I 8 2	D59
7 4 0 4 0 D I 8 2	D59	7 5 0 8 0 D I 8 2	D59	7 5 2 1 0 I 1 0 4	D65	7 5 5 1 0 D P 8 1 5	D38
7 4 0 4 0 D P 8 1 5	D38	7 5 0 8 0 D P 8 1 5	D38	7 5 2 1 0 P 1 0 1 0	D31	7 5 5 1 0 D U 8 2	D59
7 4 0 4 0 D U 8 2	D59	7 5 0 8 0 D U 8 2	D59	7 5 2 1 0 S P 1 5 1 5	D50	7 5 5 1 0 S P 1 5 1 5	D50
7 4 0 4 0 H S 1 5 1 5	D92	7 5 0 8 0 S P 1 5 1 5	D50	7 5 2 1 0 U 1 0 3	D65	7 5 5 1 0 V 1 5 1 5	CP26
7 4 0 4 0 L S 1 5 1 5	CP23	7 5 0 8 0 V 1 5 1 5	CP27	7 5 2 1 0 V 1 0 1 0	CP28	7 5 5 1 0 V 3 0 3 0	CP25
7 4 0 4 0 L S 3 0 3 0	CP23	7 5 0 8 0 V 3 0 3 0	CP27	7 5 2 1 0 V 1 5 1 5	CP27	7 5 5 2 0 A S 1 5 1 5	CP26
7 4 0 4 0 V 1 5 1 5	CP23	7 5 0 9 0 D I 8 2	D59	7 5 2 1 0 V 3 0 3 0	CP27	7 5 5 2 0 D I 8 2	D59
7 4 0 4 0 V S 1 5 1 5	D92	7 5 0 9 0 D P 8 1 5	D38	7 5 2 1 0 V D 1 5 1 5	D92	7 5 5 2 0 D P 8 1 5	D38
7 4 0 5 0 D I 8 2	D59	7 5 0 9 0 D U 8 2	D59	7 5 2 1 1 G L 3 0 3 0	D248	7 5 5 2 0 D U 8 2	D59
7 4 0 5 0 D P 8 1 5	D38	7 5 0 9 0 S P 1 5 1 5	D50	7 5 2 1 1 G S 3 0 3 0	D248	7 5 5 2 0 S P 1 5 1 5	D50
7 4 0 5 0 D U 8 2	D59	7 5 0 9 0 V 1 5 1 5	CP27	7 5 2 2 0 D I 8 2	D59	7 5 5 2 0 V 1 5 1 5	CP26
7 4 0 5 0 H S 1 5 1 5	D92	7 5 0 9 0 V 3 0 3 0	CP27	7 5 2 2 0 D P 8 1 5	D38	7 5 5 2 0 V 3 0 3 0	CP25
7 4 0 5 0 L S 1 5 1 5	CP23	7 5 1 0 0 D I 8 2	D59	7 5 2 2 0 D U 8 2	D59	7 5 5 3 0 A S 1 5 1 5	CP26
7 4 0 5 0 L S 3 0 3 0	CP23	7 5 1 0 0 D P 8 1 5	D38	7 5 2 2 0 H D 1 5 1 5	D92	7 5 5 3 0 D I 8 2	D59
7 4 0 5 0 V 1 5 1 5	CP23	7 5 1 0 0 D U 8 2	D59	7 5 2 2 0 I 1 0 4	D65	7 5 5 3 0 D P 8 1 5	D38
7 4 0 5 0 V S 1 5 1 5	D92	7 5 1 0 0 H D 1 5 1 5	D92	7 5 2 2 0 P 1 0 1 0	D31	7 5 5 3 0 D U 8 2	D59
7 4 0 6 0 D I 8 2	D59	7 5 1 0 0 S P 1 5 1 5	D50	7 5 2 2 0 S P 1 5 1 5	D50	7 5 5 3 0 S P 1 5 1 5	D50
7 4 0 6 0 D P 8 1 5	D38	7 5 1 0 0 V 1 5 1 5	CP27	7 5 2 2 0 U 1 0 3	D65	7 5 5 3 0 V 1 5 1 5	CP26
7 4 0 6 0 D U 8 2	D59	7 5 1 0 0 V 3 0 3 0	CP27	7 5 2 2 0 V 1 0 1 0	CP28	7 5 5 3 0 V 3 0 3 0	CP25
7 4 0 6 0 H S 1 5 1 5	D92	7 5 1 0 0 V D 1 5 1 5	D92	7 5 2 2 0 V 1 5 1 5	CP27	7 5 5 4 0 D I 8 2	D59
7 4 0 6 0 L S 1 5 1 5	CP23	7 5 1 1 0 D I 8 2	D59	7 5 2 2 0 V 3 0 3 0	CP27	7 5 5 4 0 D P 8 1 5	D38
7 4 0 6 0 L S 3 0 3 0	CP23	7 5 1 1 0 D P 8 1 5	D38	7 5 2 2 0 V D 1 5 1 5	D92	7 5 5 4 0 D U 8 2	D59
7 4 0 6 0 V 1 5 1 5	CP23	7 5 1 1 0 D U 8 2	D59	7 5 2 3 0 D I 8 2	D59	7 5 5 4 0 S P 1 5 1 5	D50
7 4 0 6 0 V S 1 5 1 5	D92	7 5 1 1 0 H D 1 5 1 5	D92	7 5 2 3 0 D P 8 1 5	D38	7 5 5 4 0 V 1 5 1 5	CP26
7 4 0 7 0 D I 8 2	D59	7 5 1 1 0 S P 1 5 1 5	D50	7 5 2 3 0 D U 8 2	D59	7 5 5 4 0 V 3 0 3 0	CP25

75550DI82	D59	76250DP815	D38	PAB0490LBAAG1	DC35
75550DP815	D38	76250DU82	D59	PAB0490LBAAG2	DC35
75550DU82	D59	76250SP1515	D50	PAB0497LBAAA-A	DC35
75550SP1515	D50	76250V1515	CP27	PAB0497LBAAAG1	DC35
75550V1515	CP26	76250V3030	CP27	PAB0497LBAAAG2	DC35
75550V3030	CP25	76260DI82	D59	PAB13740LBAAA-A	DC35
75560AS1515	CP26	76260DP815	D38	PAB13740LBAAAG1	DC35
75560DI82	D59	76260DU82	D59	PAB13740LBAAAG2	DC35
75560DP815	D38	76260SP1515	D50	PAB16870LBAAA-A	DC35
75560DU82	D59	76260V1515	CP27	PAB16870LBAAAG1	DC35
75560SP1515	D50	76260V3030	CP27	PAB16870LBAAAG2	DC35
75560V1515	CP26	76410DI82	D59	PAB16890LBAAA-A	DC35
75560V3030	CP25	76410DP815	D38	PAB16890LBAAAG1	DC35
75570AS1515	CP26	76410DU82	D59	PAB16890LBAAAG2	DC35
75570DI82	D59	76410SP1515	D50	PAB17050LBAAA-A	DC35
75570DP815	D38	76410V1515	CP26	PAB17050LBAAAG1	DC35
75570DU82	D59	76410V3030	CP25	PAB17050LBAAAG2	DC35
75570SP1515	D50	76640DI82	D59	PAB17060LBAAA-A	DC35
75570V1515	CP26	76640DP815	D38	PAB17060LBAAAG1	DC35
75570V3030	CP25	76640DU82	D59	PAB17060LBAAAG2	DC35
75580DI82	D59	76640SP1515	D50	PAB17070LBAAA-A	DC35
75580DP815	D38	76640V1515	CP26	PAB17070LBAAAG1	DC35
75580DU82	D59	76640V3030	CP25	PAB17070LBAAAG2	DC35
75580SP1515	D50	76650DI82	D59	PAI0490LAAA-A	DC35
75580V1515	CP26	76650DP815	D38	PAI0490LAAG1	DC35
75580V3030	CP25	76650DU82	D59	PAI0490LAAG2	DC35
75600AS1515	CP26	76650SP1515	D50	PAI0497LAAA-A	DC35
75600DI82	D59	76650V1515	CP26	PAI0497LAAG1	DC35
75600DP815	D38	76650V3030	CP25	PAI0497LAAG2	DC35
75600DU82	D59	76660DI82	D59	PAI13740LAAA-A	DC35
75600SP1515	D50	76660DP815	D38	PAI13740LAAG1	DC35
75600TR3030	D148	76660DU82	D59	PAI13740LAAG2	DC35
75600TS1515	CP29	76660SP1515	D50	PAI16870LAAA-A	DC35
75600V1515	CP26	76660V1515	CP26	PAI16870LAAG1	DC35
75600V3030	CP25	76660V3030	CP25	PAI16870LAAG2	DC35
75600WS1515	CP29	76710BN307	D39	PAI16890LAAA-A	DC35
75610AS1515	CP26	76940BN307	D39	PAI16890LAAG1	DC35
75610DI82	D59	76950BN307	D39	PAI16890LAAG2	DC35
75610DP815	D38	76960BN307	D39	PAI17050LAAA-A	DC35
75610DU82	D59	80010HR1515	D92	PAI17050LAAG1	DC35
75610SP1515	D50	80010MR1515	CP51	PAI17050LAAG2	DC35
75610TR3030	D148	80010MR3030	CP51	PAI17060LAAA-A	DC35
75610V1515	CP26	80010VR1515	D92	PAI17060LAAG1	DC35
75610V3030	CP25	80011CS1MR9090	D650	PAI17060LAAG2	DC35
75620AS1515	CP26	80011CW1MR9090	D650	PAI17070LAAA-A	DC35
75620DI82	D59	80020HR1515	D92	PAI17070LAAG1	DC35
75620DP815	D38	80020MR1515	CP51	PAI17070LAAG2	DC35
75620DU82	D59	80020MR3030	CP51	PAJ0490EAAA-A	DC35
75620SP1515	D50	80020VR1515	D92	PAJ0490EAAG1	DC35
75620TR3030	D148	80021CS1MR9090	D650	PAJ0490EAAG2	DC35
75620TS1515	CP29	80021CW1MR9090	D650	PAJ0497EAAA-A	DC35
75620V1515	CP26	80030HR1515	D92	PAJ0497EAAG1	DC35
75620V3030	CP25	80030MR1515	CP51	PAJ0497EAAG2	DC35
75620WS1515	CP29	80030MR3030	CP51	PAJ13740EAAA-A	DC35
75630AS1515	CP26	80030VR1515	D92	PAJ13740EAAG1	DC35
75630DI82	D59	80031CS1MR9090	D650	PAJ13740EAAG2	DC35
75630DP815	D38	80031CW1MR9090	D650	PAJ16870EAAA-A	DC35
75630DU82	D59	80040HR1515	D92	PAJ16870EAAG1	DC35
75630SP1515	D50	80040MR1515	CP51	PAJ16870EAAG2	DC35
75630TR3030	D148	80040MR3030	CP51	PAJ16890EAAA-A	DC35
75630V1515	CP26	80040VR1515	D92	PAJ16890EAAG1	DC35
75630V3030	CP25	80050HR1515	D92	PAJ16890EAAG2	DC35
75630V3030	CP25	80050MR1515	CP51	PAJ17050EAAA-A	DC35
75720BN307	D39	80050MR3030	CP51	PAJ17050EAAG1	DC35
75730BN307	D39	80050VR1515	D92	PAJ17050EAAG2	DC35
75740BN307	D39	80051CS1MR9090	D650	PAJ17060EAAA-A	DC35
75750BN307	D39	80051CW1MR9090	D650	PAJ17060EAAG1	DC35
75760BN307	D39	80060HR1515	D92	PAJ17060EAAG2	DC35
75770BN307	D39	80060MR1515	CP51	PAJ17070EAAA-A	DC35
75780BN307	D39	80060MR3030	CP51	PAJ17070EAAG1	DC35
75790BN307	D39	80060VR1515	D92	PAJ17070EAAG2	DC35
75800BN307	D39	PAA0490LBAAA-A	DC35	PBK80010MRAAAA-A	CP60
75810BN307	D39	PAA0490LBAAAG1	DC35	PBK80020MRAAAA-A	CP60
75820BN307	D39	PAA0490LBAAAG2	DC35	PBK80030MRAAAA-A	CP60
75830BN307	D39	PAA0497LBAAA-A	DC35	PBK80040MRAAAA-A	CP60
75840BN307	D39	PAA0497LBAAAG1	DC35	PBK80050MRAAAA-A	CP60
75850BN307	D39	PAA0497LBAAAG2	DC35	PBK80060MRAAAA-A	CP60
75860BN307	D39	PAA13740LBAAA-A	DC35	PBM80010MRAAAA-A	CP61
75870BN307	D39	PAA13740LBAAAG1	DC35	PBM80020MRAAAA-A	CP61
75880BN307	D39	PAA13740LBAAAG2	DC35	PBM80030MRAAAA-A	CP61
75900BN307	D39	PAA16870LBAAA-A	DC35	PBM80040MRAAAA-A	CP61
75910BN307	D39	PAA16870LBAAAG1	DC35	PBM80050MRAAAA-A	CP61
75920BN307	D39	PAA16870LBAAAG2	DC35	PBM80060MRAAAA-A	CP61
75930BN307	D39	PAA16890LBAAA-A	DC35		
76010DI82	D59	PAA16890LBAAAG1	DC35		
76010DP815	D38	PAA16890LBAAAG2	DC35		
76010DU82	D59	PAA17050LBAAA-A	DC35		
76010SP1515	D50	PAA17050LBAAAG1	DC35		
76010V1515	CP27	PAA17050LBAAAG2	DC35		
76010V3030	CP27	PAA17060LBAAA-A	DC35		
76240DI82	D59	PAA17060LBAAAG1	DC35		
76240DP815	D38	PAA17060LBAAAG2	DC35		
76240DU82	D59	PAA17070LBAAA-A	DC35		
76240SP1515	D50	PAA17070LBAAAG1	DC35		
76240V1515	CP27	PAA17070LBAAAG2	DC35		
76240V3030	CP27	PAB0490LBAAA-A	DC35		
76250DI82	D59				

Mosa.

Wall tiles

10/10 Classics Kho Liang Ie Collection

wandtegels / carreaux de faïence / Wandfliesen / wall tiles
 geglazuurd / émaillé / glasiert / glazed
 niet vorstbestand / non ingélif / nicht frostsicher / not frost proof

no.	mm	inch	pieces/ m ²	pieces/ m ¹	pieces/ box	boxes/ pallet	pieces/ pallet	m ² / pallet	kg/ m ²	kg/ pallet
16900 - 16904	97x97x7,8	3.82x3.82x0.31	100	-	50 = 0,50 m ²	90	4.500	45,0	11,9	561
16905 - 16906	97x97x7,8	3.82x3.82x0.31	100	-	44 = 0,44 m ²	90	3.960	39,6	12,7	528

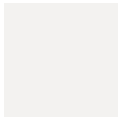

16900-1010 € CC13

accent wit / blanc accent /
Akzent weiß / accent white



85 NCS S 0502-R50B GL



16901-1010 € AC01

accent wit / blanc accent /
Akzent weiß / accent white



85



16902-1010 € AC01

accent wit / blanc accent /
Akzent weiß / accent white



85



16903-1010 € AC01

accent wit / blanc accent /
Akzent weiß / accent white



85



16904-1010 € AC01

accent wit / blanc accent /
Akzent weiß / accent white



85



16905-1010 € AC01

accent wit / blanc accent /
Akzent weiß / accent white



85



16906-1010 € AC01



accent wit / blanc accent /
Akzent weiß / accent white

























85

Colors

wandtegels / carreaux de faïence / Wandfliesen / wall tiles
geglazuurd / émaillé / glasiert / glazed
niet vorstbestand / non ingélif / nicht frostsicher / not frost proof

bijpassende vloertegels / carreaux de sol correspondants /
dazugehörige Bodenfliesen / matching floor tiles
Global Collection   

no.	mm	inch	pieces/ m ²	pieces/ m ¹	pieces/ box	boxes/ pallet	pieces/ pallet	m ² / pallet	kg/ m ²	kg/ pallet
15010 - 18910	97x97x7,8	3.82x3.82x0.31	100	-	50 = 0,50 m ²	90	4.500	45,0	11,9	561

			
15010-1010 € CC13  wit uni / blanc uni / weiß Uni / plain white     78  S 1002-Y50R	6400-1010 € CC13  light grey   49  S 2502-R GL	16660-1010 € CC13  ivoorwit uni / blanc d'ivoire uni / elfenbeinweiß Uni / plain ivory white    82  S 0505-Y10R GL	16850-1010 € CC13  ivoorzwart uni / noir d'ivoire uni / elfenbeinschwarz Uni / plain ivory black     12  S 8000-N GL
			
16880-1010 € CC13  muisgrijs uni / gris de souris uni / mausgrau Uni / plain mouse grey     27  S 5500-N GL	16900-1010 € CC13  accent wit / blanc accent / Akzent weiß / accent white     85  S 0502-R50B GL	16910-1010 € CC13  accent zwart / noir accent / Akzent schwarz / accent black     5  S 9000-N GL	17900-1010 € CC13  macaw green     45  S 0560-G40Y GL
			
17920-1010 € CC13  spectrum blue   6  S 6030-R60B GL	17940-1010 € CC13  ame orange   37  S 2050-Y30R GL	17950-1010 € CC13  spectra yellow   53  S 0570-Y10R GL	17960-1010 € CC13  aurora   69  S 0540-G80Y GL
			
17970-1010 € CC13  pompeian red   22  S 2060-Y80R GL	17990-1010 € CC13  blue curacao   30  S 2040-B20G GL	18910-1010 € CC13  brilliant blue   18  S 3050-R90B GL	

Voor tegelpatronen zie www.mosa.com/nl-nl/grids.
Pour des motifs de carreaux, nous vous invitons à consulter www.mosa.com/fr-fr/trames.
Für Verlegemuster siehe www.mosa.com/de-de/raster.
For tile patterns, see www.mosa.com/en-us/grids or www.mosa.com/en-us/grids.

10/20 Classics Tide

wandtegels / carreaux de faïence / Wandfliesen / wall tiles
 geglazuurd / émaillé / glasiert / glazed
 niet vorstbestand / non ingélif / nicht frostsicher / not frost proof

10/20

no.	mm	inch	pieces/ m ²	pieces/ m ¹	pieces/ box	boxes/ pallet	pieces/ pallet	m ² / pallet	kg/ m ²	kg/ pallet
0601 - 0610	97x197x6,3	3.82x7.76x0.25	50	-	25 = 0,50 m ²	182	4.550	91,0	10,6	990

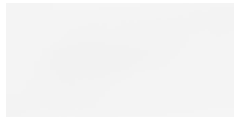

0601-1020 € BC09

serene white
 69



0602-1020 € BC09

blush
 60



0603-1020 € BC09

sage
 44



0604-1020 € BC09

blue mist
 50



0605-1020 € BC09

fog grey
 57



0606-1020 € BC09

bone
 65



0607-1020 € BC09

rust
 11

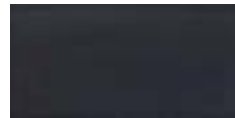

0608-1020 € BC09

charcoal grey
 8



0609-1020 € BC09

sand
 48



0610-1020 € BC09

forest green
 13

10/20 Classics Trocadero

wandtegels / carreaux de faïence / Wandfliesen / wall tiles
 geglaazuurd / émaillé / glasiert / glazed
 niet vorstbestand / non ingélif / nicht frostsicher / not frost proof



no.	mm	inch	pieces/ m ²	pieces/ m ¹	pieces/ box	boxes/ pallet	pieces/ pallet	m ² / pallet	kg/ m ²	kg/ pallet
1001 - 1011	97x197x9	3.82x7.76x0.35	50	-	18 = 0,36 m ²	182	3.276	65,5	14,1	949
1003 - 1013	97x97x9	3.82x3.82x0.35	100	-	25 = 0,25 m ²	256	6.400	64,0	13,3	876



1001-1020

€ BC05

zwart / noir /
schwarz / black



C2C 5

1011-1020

€ BC05

klassiek wit / blanc classique /
weiß klassik / white classic



C2C 82



1003-1010

€ D 21

zwart / noir /
schwarz / black



C2C 5

1013-1010

€ D 21

klassiek wit / blanc classique /
weiß klassik / white classic



C2C 82

1030 Global Collection

wandtegels / carreaux de faïence / Wandfliesen / wall tiles
 geglaazuurd / émaillé / glasiert / glazed
 niet vorstbestand / non ingélif / nicht frostsicher / not frost proof

bijpassende vloertegels / carreaux de sol correspondants /
 dazugehörige Bodenfliesen / matching floor tiles
 Global Collection 1030 1030 1030

no.	mm	inch	pieces/ m ²	pieces/ m ¹	pieces/ box	boxes/ pallet	pieces/ pallet	m ² / pallet	kg/ m ²	kg/ pallet
15010 - 15240	97x297x7,8	3.82x11.69x0.31	33	-	33 = 1,00 m ²	77	2.541	77,0	13,0	1.024

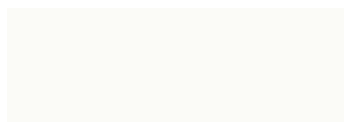

15010-1030 € CC09

M₃ wit uni / blanc uni /
 weiß Uni / plain white



c2c 78 NCS S 1002-Y50R



15030-1030 € CC09

M₃ grijsbeige uni / gris-beige uni /
 graubeige Uni / plain grey beige



c2c 46 NCS S 3005-Y20R



15050-1030 € CC09

M₃ agaatgrijs uni / gris d'agate uni /
 achatgrau Uni / plain agate grey



c2c 24 NCS S 5005-Y50R



15200-1030 € CC09

M₃ ivoorzwart uni / noir d'ivoire uni /
 elfenbeinschwarz Uni / plain ivory black



c2c 10 NCS S 8000-N



15210-1030 € CC09

M₃ ecruwit uni / blanc écru uni /
 weiß ungebleicht Uni /
 plain white unbleached



c2c 68 NCS S 1005-Y10R



15220-1030 € CC09

M₃ grijs uni / gris uni /
 grau Uni / plain grey



c2c 44 NCS S 3000-N



15230-1030 € CC09

M₃ muisgrijs uni / gris de souris uni /
 mausgrau Uni / plain mouse grey



c2c 27 NCS S 5500-N



25240-1030 € CC09

M₃ warm grijs uni / gris chaleureux uni /
 warm grau Uni / plain warm grey



c2c 16 NCS S 7005-Y20R



25250-1030 € CC09

M₃ antraciet uni / anthracite uni /
 anthrazit Uni / plain anthracite



c2c 16 NCS S 6500-N

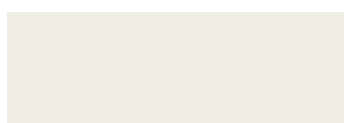

13000-1030 € CC09

M₃ wit / blanc /
 weiß / white



c2c 78 NCS S 0500-N



15240-1030 € CC09

M₃ accent zwart / noir accent /
 Akzent schwarz / accent black



c2c 5 NCS S 9000-N

1030 Global Collection

wandtegels / carreaux de faïence / Wandfliesen / wall tiles
 geglaazuurd / émaillé / glasiert / glazed
 niet vorstbestand / non ingélif / nicht frostsicher / not frost proof

bijpassende vloertegels / carreaux de sol correspondants /
 dazugehörige Bodenfliesen / matching floor tiles
 Global Collection 10 15 30

no.	mm	inch	pieces/ m ²	pieces/ m ¹	pieces/ box	boxes/ pallet	pieces/ pallet	m ² / pallet	kg/ m ²	kg/ pallet
16610 - 17900	97x297x7,8	3.82x11.69x0.31	33	-	33 = 1,00 m ²	77	2.541	77,0	13,0	1.024

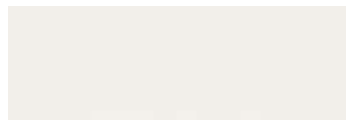

16610-1030 € CC09

roomwit uni / crème-blanc uni /
rahm-weiß Uni / plain cream-white



C2C 84 NCS S 0502-Y GL



16630-1030 € CC09

grijsbeige uni / gris-beige uni /
graubeige Uni / plain grey beige



C2C 52 NCS S 3005-Y20R GL



16650-1030 € CC09

agaatgrijs uni / gris d'agate uni /
achatgrau Uni / plain agate grey



C2C 25 NCS S 5005-Y50R GL

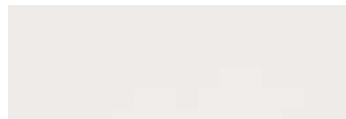

16840-1030 € CC09

koel wit uni / blanc frais uni /
kühl weiß Uni / plain cool white



C2C 78 NCS S 1002-R50B GL



16850-1030 € CC09

ivoorzwart uni / noir d'ivoire uni /
elfenbeinschwarz Uni / plain ivory black



C2C 12 NCS S 8000-N GL

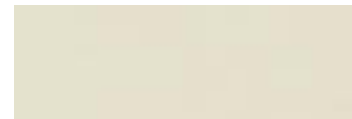

16860-1030 € CC09

ecruwit uni / blanc écri uni /
weiß ungebleicht Uni /
plain white unbleached



C2C 78 NCS S 1005-Y10R GL



16870-1030 € CC09

grijs uni / gris uni /
grau Uni / plain grey



C2C 51 NCS S 3000-N GL



16880-1030 € CC09

muisgrijs uni / gris de souris uni /
mausgrau Uni / plain mouse grey



C2C 27 NCS S 5500-N GL



26240-1030 € CC09

warm grijs uni / gris chaleureux uni /
warm grau Uni / plain warm grey



C2C 15 NCS S 7005-Y20R GL



26250-1030 € CC09

antraciet uni / anthracite uni /
anthrazit Uni / plain anthracite



C2C 16 NCS S 6500-N GL

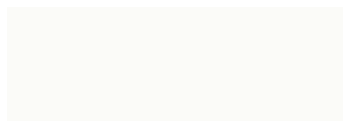

16900-1030 € CC09

accent wit / blanc accent /
Akzent weiß / accent white



C2C 85 NCS S 0502-R50B GL

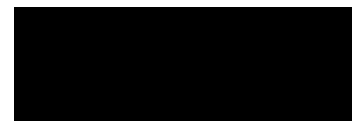

16910-1030 € CC09

accent zwart / noir accent /
Akzent schwarz / accent black



C2C 5 NCS S 9000-N GL



16950-1030 € CC09

accent rood / rouge accent /
Akzent rot / accent red



C2C 18 NCS S 1085-Y90R GL



16980-1030 € CC09

hollandsoranje / Dutch orange /
Dutch orange / Dutch orange



C2C 26 NCS S 0585-Y60R GL



17900-1030 € CC09

macaw green



C2C 45 NCS S 0560-G40Y GL

1515 Classics Foxtrot

wandtegels / carreaux de faïence / Wandfliesen / wall tiles
 geglazuurd / émaillé / glasiert / glazed
 niet vorstbestand / non ingélf / nicht frostsicher / not frost proof

no.	mm	inch	pieces/ m ²	pieces/ m ¹	pieces/ box	boxes/ pallet	pieces/ pallet	m ² / pallet	kg/ m ²	kg/ pallet
7820	147x147x7	5.79x5.79x0.28	44	-	33 = 0,75 m ²	115	3.795	86,3	11,8	1.046
7820RA	147x147x6,8	5.79x5.79x0.27	-	6,67	33 = 4,95 m ¹	100	3.300	-	-	916
7820HA	147x147x6,8	5.79x5.79x0.27	-	-	10	300	3.000	-	-	814
7851	147x25x6,8	5.79x0.98x0.27	-	6,67	20 = 3,00 m ¹	832	16.640	-	-	857



7820-1515 € BC04

ivoor / ivoire /
elfenbein / ivory

RA, HA

C2C 67

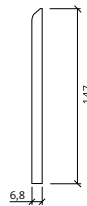

7820RA1515 € D 38

ivoor / ivoire /
elfenbein / ivory

randafdek / bord arrondi /
Randabdeck / round edge (bullnose)

C2C 67

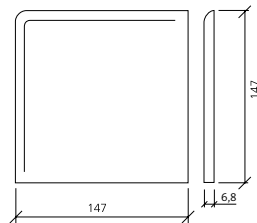

7820HA1515 € D 38

ivoor / ivoire /
elfenbein / ivory

hoekafdek / 2 bords arrondis /
Eckabdeck / 2 round edges (double
bullnose)

C2C 67



7851-153 € D 38



zwart / noir /
schwarz / black

C2C

Voor tegelpatronen zie www.mosa.com/nl-nl/grids.
 Pour des motifs de carreaux, nous vous invitons à consulter www.mosa.com/fr-fr/trames.
 Für Verlegemuster siehe www.mosa.com/de-de/raster.
 For tile patterns, see www.mosa.com/en-us/grids or www.mosa.com/en-us/grids.







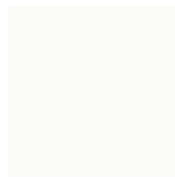

1515 Colors

wandtegels / carreaux de faïence / Wandfliesen / wall tiles
 geglaazuurd / émaillé / glasiert / glazed
 niet vorstbestand / non ingélif / nicht frostsicher / not frost proof





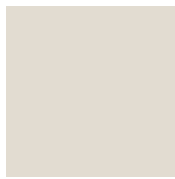

bijpassende vloertegels / carreaux de sol correspondants /
 dazugehörige Bodenfliesen / matching floor tiles
 Global Collection   

no.	mm	inch	pieces/ m ²	pieces/ m ¹	pieces/ box	boxes/ pallet	pieces/ pallet	m ² / pallet	kg/ m ²	kg/ pallet
15010 - 17950	147x147x5,6	5.79x5.79x0.22	44	-	44 = 1,00 m ²	100	4.400	100,0	9,2	940









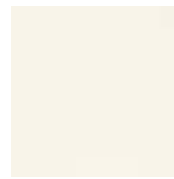

15010-1515   **CC10**
 M3 wit uni / blanc uni /
 weiß Uni / plain white
  
  78  1002-Y50R









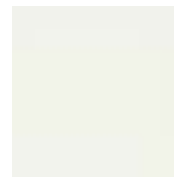

6400-1515  **CC10**
 light grey

  49  2502-R GL







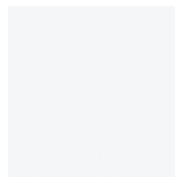



16660-1515   **CC10**
 ivoorwit uni / blanc d'ivoire uni /
 elfenbeinweiß Uni / plain ivory white
  
  82  0505-Y10R GL









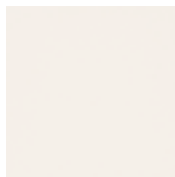

16690-1515   **CC10**
 parelgroen uni / vert de perle uni /
 perlgrün Uni / plain pearl green
 
  80  0505-G20Y GL











16740-1515   **CC10**
 parelblauw uni / bleu de perle uni /
 perlblau Uni / plain pearl blue
 
  80  0505-R90B GL











16790-1515   **CC10**
 ivoor uni / ivoire uni /
 elfenbein Uni / plain ivory
 
  78  1010-Y30R GL









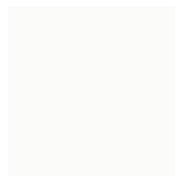

16850-1515   **CC10**
 ivoorzwart uni / noir d'ivoire uni /
 elfenbeinschwarz Uni / plain ivory black
  
  12  8000-N GL









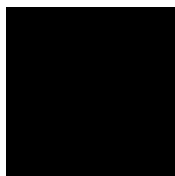

16880-1515   **CC10**
 muisgrijs uni / gris de souris uni /
 mausgrau Uni / plain mouse grey
  
  27  5500-N GL











16900-1515   **CC10**
 accent wit / blanc accent /
 Akzent weiß / accent white
  
  85  0502-R50B GL







16910-1515   **CC10**
 accent zwart / noir accent /
 Akzent schwarz / accent black
  
  5  9000-N GL



17900-1515   **CC10**
 macaw green
  
  45  0560-G40Y GL





17910-1515  **CC10**
 cyan blue
  29  2050-B GL









17920-1515  **CC10**
 spectrum blue

  6  6030-R60B GL









17930-1515  **CC10**
 clover
  14  4040-R40B GL





17940-1515  **CC10**
 ame orange

  37  2050-Y30R GL



17950-1515  **CC10**
 spectra yellow

  53  0570-Y10R GL

15 Colors

wandtegels / carreaux de faïence / Wandfliesen / wall tiles
 geglaazuurd / émaillé / glasiert / glazed
 niet vorstbestand / non ingélf / nicht frostsicher / not frost proof

bijpassende vloertegels / carreaux de sol correspondants /
 dazugehörnde Bodenfliesen / matching floor tiles
 Global Collection   

no.	mm	inch	pieces/ m ²	pieces/ m ¹	pieces/ box	boxes/ pallet	pieces/ pallet	m ² / pallet	kg/ m ²	kg/ pallet
17960 - 19910	147x147x5,6	5.79x5.79x0.22	44	-	44 = 1,00 m ²	100	4.400	100,0	9,2	940



17960-1515  CC10

 aurora
    S 0540-G80Y GL





17970-1515  CC10

 pompeian red
   S 2060-Y80R GL







17980-1515  CC10

 paprika
  S 1070-Y70R GL





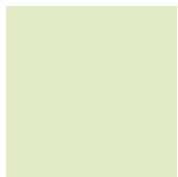

17990-1515  CC10

 blue curacao
   S 2040-B20G GL







18900-1515  CC10

 ambrosia
   S 1020-G40Y GL







18910-1515  CC10

 brilliant blue
   S 3050-R90B GL





18920-1515  CC10

 royal blue
   S 4040-R70B GL



18930-1515  CC10

 chateau rose
   S 3040-R20B GL



18940-1515  CC10

 apricot tan
   S 1040-Y30R GL



18950-1515  CC10

 cornsilk
   S 1030-Y GL



18960-1515  CC10

 pastel yellow
   S 0520-G90Y GL



18970-1515  CC10

 peach blossom
   S 2030-R10B GL





18980-1515  CC10

 seashell pink
   S 2030-Y90R GL







18990-1515  CC10

 brook green
   S 1030-B90G GL



19900-1515  CC10

 buttery green
   S 1030-G30Y GL



19910-1515  CC10

 light blue
   S 0540-B GL

1515 Colors

wandtegels / carreaux de faïence / Wandfliesen / wall tiles
 geglaazuurd / émaillé / glasiert / glazed
 niet vorstbestand / non ingélif / nicht frostsicher / not frost proof

bijpassende vloertegels / carreaux de sol correspondants /
 dazugehörige Bodenfliesen / matching floor tiles
 Global Collection 

no.	mm	inch	pieces/ m ²	pieces/ m ¹	pieces/ box	boxes/ pallet	pieces/ pallet	m ² / pallet	kg/ m ²	kg/ pallet
19920 - 20970	147x147x5,6	5.79x5.79x0.22	44	-	44 = 1,00 m ²	100	4.400	100,0	9,2	940



19920-1515 € CC10

 blue bell
  39  S 2030-R80B GL

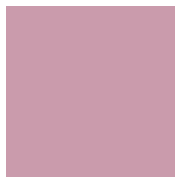

19930-1515 € CC10

 sea pink
  35  S 1040-R20B GL



19940-1515 € CC10

 sierra
  26  S 4030-Y60R GL







19950-1515 € CC10

 golden yellow
  43  S 2040-Y10R GL



19960-1515 € CC10

 cress green
  45  S 2040-G80Y GL







19970-1515 € CC10

 ruby wine
  12  S 4040-R10B GL







19980-1515 € CC10

 aragon
  22  S 4030-Y80R GL







19990-1515 € CC10

 jade green
  37  S 2040-G GL







20900-1515 € CC10

 thyme
  9  S 7010-G10Y GL



20910-1515 € CC10

 mazarine blue
  6  S 7020-R80B GL







20920-1515 € CC10

 persian jewel
  22  S 3040-R70B GL





20930-1515 € CC10

 eggplant
  6  S 8010-R30B GL



20940-1515 € CC10

 cacao brown
  14  S 6010-Y50R GL



20950-1515 € CC10

 medal bronze
  23  S 5020-Y GL



20960-1515 € CC10

 beech
  12  S 7005-G80Y GL



20970-1515 € CC10

 burgundy
  8  S 6020-R20B GL

1515 Colors

wandtegels / carreaux de faïence / Wandfliesen / wall tiles
 geglaazuurd / émaillé / glasiert / glazed
 niet vorstbestand / non ingélif / nicht frostsicher / not frost proof

bijpassende vloertegels / carreaux de sol correspondants /
 dazugehörige Bodenfliesen / matching floor tiles
 Global Collection 

no.	mm	inch	pieces/ m ²	pieces/ m ¹	pieces/ box	boxes/ pallet	pieces/ pallet	m ² / pallet	kg/ m ²	kg/ pallet
20980 - 20990	147x147x5,6	5.79x5.79x0.22	44	-	44 = 1,00 m ²	100	4.400	100,0	9,2	940

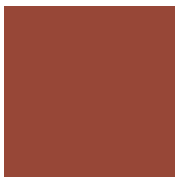

20980-1515

€ CC10



chili

 16  S 3050-Y80R GL

20990-1515

€ CC10





oriental blue

  8  S 6030-B GL









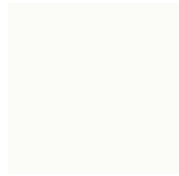

1515 Global Collection

wandtegels / carreaux de faïence / Wandfliesen / wall tiles
 geglaazuurd / émaillé / glasiert / glazed
 niet vorstbestand / non ingélif / nicht frostsicher / not frost proof





bijpassende vloertegels / carreaux de sol correspondants /
 dazugehörige Bodenfliesen / matching floor tiles
 Global Collection   

no.	mm	inch	pieces/ m ²	pieces/ m ¹	pieces/ box	boxes/ pallet	pieces/ pallet	m ² / pallet	kg/ m ²	kg/ pallet
15010 - 15160	147x147x5,6	5.79x5.79x0.22	44	-	44 = 1,00 m ²	100	4.400	100,0	9,2	940









15010-1515   **CC10**
 M₃ wit uni / blanc uni /
 weiß Uni / plain white
  
  78  S 1002-Y50R



15020-1515   **CC10**
 M₃ parelwit uni / blanc de perle uni /
 perlweiß Uni / plain pearl white
  58  S 2005-Y20R









15030-1515   **CC10**
 M₃ grijsbeige uni / gris-beige uni /
 graubeige Uni / plain grey beige
 
  46  S 3005-Y20R







15040-1515   **CC10**
 M₃ aardebruin uni / brune terre uni /
 erdbruun Uni / plain earth brown
  35  S 3010-Y40R







15050-1515   **CC10**
 M₃ agaatgrijs uni / gris d'agate uni /
 achatgrau Uni / plain agate grey
 
  24  S 5005-Y50R







15060-1515   **CC10**
 M₃ napelsgeel uni / jaune de Naples uni /
 Neapelgelb Uni / plain Naples yellow
  45  S 2030-Y20R







15070-1515   **CC10**
 M₃ zandgeel uni / jaune de sable uni /
 sandgelb Uni / plain sand yellow
  54  S 2020-Y20R







15080-1515   **CC10**
 M₃ olijfgroen uni / vert olive uni /
 olivgrün Uni / plain olive green
  37  S 3020-G20Y







15090-1515   **CC10**
 M₃ pastelgroen uni / vert pastel uni /
 pastellgrün Uni / plain pastel green
  49  S 3010-G50Y



15100-1515   **CC10**
 M₃ turkoois uni / turquoise uni /
 türkis Uni / plain turquoise
  21  S 6020-B30G







15110-1515   **CC10**
 M₃ mintgroen uni / vert de menthe uni /
 minzgrün Uni / plain mint green
  47  S 3005-G20Y







15120-1515   **CC10**
 M₃ pruisischblau uni / bleu de Prusse uni /
 Preußischblau Uni / plain Prussian blue
  15  S 6020-R90B

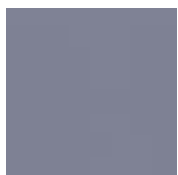





15130-1515   **CC10**
 M₃ sèvresblau uni / bleu de Sèvres uni /
 Sèvresblau Uni / plain Sèvres blue
  40  S 2020-R90B







15140-1515   **CC10**
 M₃ koningsblau uni / bleu royal uni /
 königsblau Uni / plain king's blue
  25  S 5010-R70B

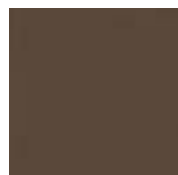

15150-1515   **CC10**
 M₃ duivenblau uni / bleu pigeon uni /
 taubenblau Uni / plain dove blue
  39  S 4005-R80B



15160-1515   **CC10**
 M₃ indischbruin uni / brun Indien uni /
 Indischbraun Uni / plain Indian brown
  14  S 7010-Y70R

1515 Global Collection

wandtegels / carreaux de faïence / Wandfliesen / wall tiles
 geglaazuurd / émaillé / glasiert / glazed
 niet vorstbestand / non ingélf / nicht frostsicher / not frost proof

bijpassende vloertegels / carreaux de sol correspondants /
 dazugehörige Bodenfliesen / matching floor tiles
 Global Collection 1515 1515 1515

no.	mm	inch	pieces/ m ²	pieces/ m ¹	pieces/ box	boxes/ pallet	pieces/ pallet	m ² / pallet	kg/ m ²	kg/ pallet
15170 - 16670	147x147x5,6	5.79x5.79x0.22	44	-	44 = 1,00 m ²	100	4.400	100,0	9,2	940



15170-1515 **CC10**
 koperbruin uni / brun cuivre uni /
 kupferbraun Uni / plain copper brown
 23 S 4030-Y50R



15180-1515 **CC10**
 engelsrood uni / rouge anglais uni /
 Englischrot Uni / plain light oxide red
 30 S 4020-Y70R



15200-1515 **CC10**
 voorzwart uni / noir d'ivoire uni /
 elfenbeinschwarz Uni /
 plain ivory black
 10 S 8000-N



15210-1515 **CC10**
 ecruwit uni / blanc écru uni /
 weiß ungebleicht Uni /
 plain white unbleached
 68 S 1005-Y10R



15220-1515 **CC10**
 grijs uni / gris uni /
 grau Uni / plain grey
 44 S 3000-N



15230-1515 **CC10**
 muisgrijs uni / gris de souris uni /
 mausgrau Uni / plain mouse grey
 27 S 5500-N

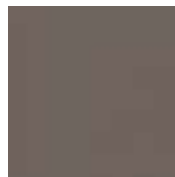

25240-1515 **CC10**
 warm grijs uni / gris chaleureux uni /
 warm grau Uni / plain warm grey
 16 S 7005-Y20R



25250-1515 **CC10**
 antraciet uni / anthracite uni /
 anthrazit Uni / plain anthracite
 16 S 6500-N



25260-1515 **CC10**
 siennarood uni / rouge de Sienna uni /
 Siennarot Uni / plain Sienna red
 14 S 5030-Y70R

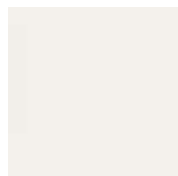

16610-1515 **CC10**
 roomwit uni / crème-blanc uni /
 rahm-weiß Uni / plain cream-white
 84 S 0502-Y GL



16620-1515 **CC10**
 parelwit uni / blanc de perle uni /
 perlweiß Uni / plain pearl white
 62 S 2005-Y20R GL



16630-1515 **CC10**
 grijsbeige uni / gris-beige uni /
 graubeige Uni / plain grey beige
 52 S 3005-Y20R GL



16640-1515 **CC10**
 aardebruin uni / brune terre uni /
 erdbruun Uni / plain earth brown
 41 S 3010-Y40R GL



16650-1515 **CC10**
 agaatgrijs uni / gris d'agate uni /
 achatgrau Uni / plain agate grey
 25 S 5005-Y50R GL

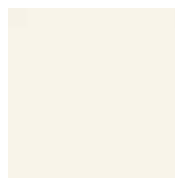

16660-1515 **CC10**
 ivoorwit uni / blanc d'ivoire uni /
 elfenbeinweiß Uni / plain ivory white
 82 S 0505-Y10R GL



16670-1515 **CC10**
 napelsgeel uni / jaune de Naples uni /
 Neapelgelb Uni / plain Naples yellow
 52 S 2030-Y20R GL



1515 Global Collection

wandtegels / carreaux de faïence / Wandfliesen / wall tiles
 geglaazuurd / émaillé / glasiert / glazed
 niet vorstbestand / non ingélif / nicht frostsicher / not frost proof

bijpassende vloertegels / carreaux de sol correspondants /
 dazugehörige Bodenfliesen / matching floor tiles
 Global Collection 1515 1515 1515

no.	mm	inch	pieces/ m ²	pieces/ m ¹	pieces/ box	boxes/ pallet	pieces/ pallet	m ² / pallet	kg/ m ²	kg/ pallet
16680 - 16840	147x147x5,6	5.79x5.79x0.22	44	-	44 = 1,00 m ²	100	4.400	100,0	9,2	940



16680-1515 CC10

zandgeel uni / jaune de sable uni /
sandgelb Uni / plain sand yellow



64 S 2020-Y20R GL

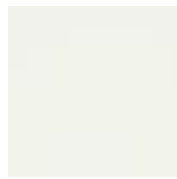

16690-1515 CC10

parelgroen uni / vert de perle uni /
perlgrün Uni / plain pearl green



80 S 0505-G20Y GL



16700-1515 CC10

olifgroen uni / vert olive uni /
olivgrün Uni / plain olive green



36 S 3020-G20Y GL



16710-1515 CC10

pastelgroen uni / vert pastel uni /
pastellgrün Uni / plain pastel green



61 S 3010-G50Y GL



16720-1515 CC10

turkoois uni / turquoise uni /
türkis Uni / plain turquoise



23 S 6020-B30G GL



16730-1515 CC10

mintgroen uni / vert de menthe uni /
minzgrün Uni / plain mint green



62 S 1005-G20Y GL

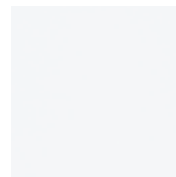

16740-1515 CC10

parelblauw uni / bleu de perle uni /
perlblau Uni / plain pearl blue



80 S 0505-R90B GL



16750-1515 CC10

pruisischblauw uni / bleu de Prusse uni /
Preußischblau Uni / plain Prussian blue



19 S 6020-R90B GL

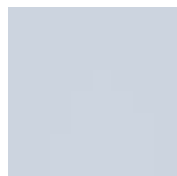

16760-1515 CC10

sèvresblauw uni / bleu de Sèvres uni /
Sèvresblau Uni / plain Sèvres blue



54 S 2020-R90B GL

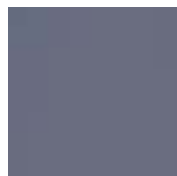

16770-1515 CC10

koningsblauw uni / bleu royal uni /
königsblau Uni / plain king's blue



25 S 5010-R70B GL

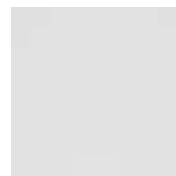

16780-1515 CC10

duivenblauw uni / bleu pigeon uni /
taubenblau Uni / plain dove blue



51 S 4005-R80B GL

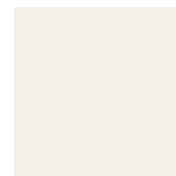

16790-1515 CC10

ivoor uni / ivoire uni /
elfenbein Uni / plain ivory



78 S 1010-Y30R GL

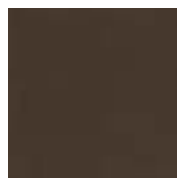

16800-1515 CC10

indischbruin uni / brun Indien uni /
Indischbraun Uni / plain Indian brown



13 S 7010-Y70R GL



16810-1515 CC10

koperbruin uni / brun cuivre uni /
kupferbraun Uni / plain copper brown



37 S 4030-Y50R GL



16820-1515 CC10

engelsrood uni / rouge anglais uni /
Englischrot Uni / plain light oxide red



32 S 4020-Y70R GL



16840-1515 CC10

koelwit uni / blanc frais uni /
kühl weiß Uni / plain cool white



78 S 1002-R50B GL

15 Global Collection

wandtegels / carreaux de faïence / Wandfliesen / wall tiles
 geglaazuurd / émaillé / glasiert / glazed
 niet vorstbestand / non ingélif / nicht frostsicher / not frost proof

bijpassende vloertegels / carreaux de sol correspondants /
 dazugehörige Bodenfliesen / matching floor tiles
 Global Collection 18 19 30

no.	mm	inch	pieces/ m ²	pieces/ m ¹	pieces/ box	boxes/ pallet	pieces/ pallet	m ² / pallet	kg/ m ²	kg/ pallet
16850 - 16970	147x147x5,6	5.79x5.79x0.22	44	-	44 = 1,00 m ²	100	4.400	100,0	9,2	940



16850-1515 CC10
 ivoorzwart uni / noir d'ivoire uni /
 elfenbeinschwarz Uni / plain ivory black
 12 S 8000-N GL

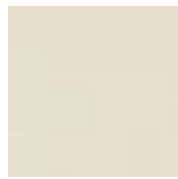

16860-1515 CC10
 ecruwit uni / blanc écre uni /
 weiß ungebleicht Uni /
 plain white unbleached
 78 S 1005-Y10R GL

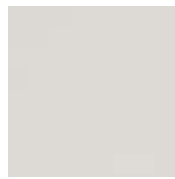

16870-1515 CC10
 grijs uni / gris uni /
 grau Uni / plain grey
 51 S 3000-N GL



16880-1515 CC10
 muisgrijs uni / gris de souris uni /
 mausgrau Uni / plain mouse grey
 27 S 5500-N GL



26240-1515 CC10
 warm grijs uni / gris chaleureux uni /
 warm grau Uni / plain warm grey
 15 S 7005-Y20R GL

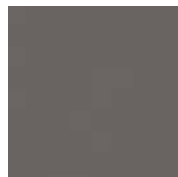

26250-1515 CC10
 antraciet uni / anthracite uni /
 anthrazit Uni / plain anthracite
 16 S 6500-N GL

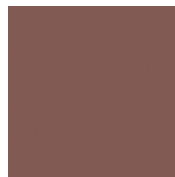

26260-1515 CC10
 siennarood uni / rouge de Sienna uni /
 Siennarot Uni / plain Sienna red
 13 S 5030-Y70R GL

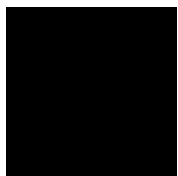

15240-1515 CC10
 accent zwart / noir accent /
 Akzent schwarz / accent black
 5 S 9000-N

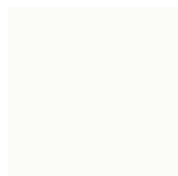

16900-1515 CC10
 accent wit / blanc accent /
 Akzent weiß / accent white
 85 S 0502-R50B GL



16910-1515 CC10
 accent zwart / noir accent /
 Akzent schwarz / accent black
 5 S 9000-N GL



16920-1515 CC10
 accent geel / jaune accent /
 Akzent gelb / accent yellow
 61 S 0570-Y GL



16930-1515 CC10
 accent groen / vert accent /
 Akzent grün / accent green
 17 S 4050-B90G GL



16940-1515 CC10
 accent blauw / bleu accent /
 Akzent blau / accent blue
 13 S 3560-R90B GL



16950S1515 CC10
 accent rood / rouge accent /
 Akzent rot / accent red
 18 S 1085-Y90R GL



16970-1515 CC10
 rood / rouge /
 rot / red
 14 S 1080-R GL

1515 Global Collection

wandtegels / carreaux de faïence / Wandfliesen / wall tiles
 geglaazuurd / émaillé / glasiert / glazed
 niet vorstbestand / non ingélif / nicht frostsicher / not frost proof

bijpassende vloertegels / carreaux de sol correspondants /
 dazugehörige Bodenfliesen / matching floor tiles
 Global Collection 18 19 20



no.	mm	inch	pieces/ m ²	pieces/ m ¹	pieces/ box	boxes/ pallet	pieces/ pallet	m ² / pallet	kg/ m ²	kg/ pallet
16980 - 17900	147x147x5,6	5.79x5.79x0.22	44	-	44 = 1,00 m ²	100	4.400	100,0	9,2	940



16980-1515  € CC10

 hollandsoranje / Dutch orange /
 Dutch orange / Dutch orange



 26  S 0585-Y60R GL

16990-1515  € CC10

 hollandsblauw / Dutch blue /
 Dutch blue / Dutch blue



 25  S 1560-R90B GL

17900-1515  € CC10



 macaw green



 45  S 0560-G40Y GL

1515 Holland 2040

wandtegels / carreaux de faïence / Wandfliesen / wall tiles
 geglaazuurd / émaillé / glasiert / glazed
 niet vorstbestand / non ingélf / nicht frostsicher / not frost proof

bijpassende vloertegels / carreaux de sol correspondants /
 dazugehörige Bodenfliesen / matching floor tiles
 Softline 
 Softgrip 

no.	mm	inch	pieces/ m ²	pieces/ m ¹	pieces/ box	boxes/ pallet	pieces/ pallet	m ² / pallet	kg/ m ²	kg/ pallet
0490M - 0498M	147x147x5,6	5.79x5.79x0.22	44	-	44 = 1,00 m ²	100	4.400	100,0	9,2	940
0490	151x151x5,6	5.94x5.94x0.22	44	-	44 = 1,00 m ²	100	4.400	100,0	9,6	984



0490M1515  € U 0

 wit / blanc /
weiß / white

 HI, HU, II, IU, UI, UU, RE, HE

  81

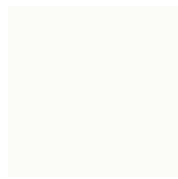

0495M1515  € U 0

 wit / blanc /
weiß / white

 RE, HE

  78

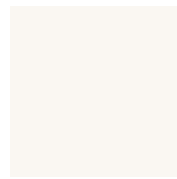

0497M1515  € U 0

 roomwit / crème-blanc /
rahm-weiß / cream-white

 RE, HE

  79

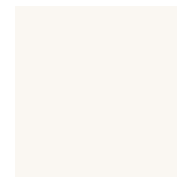

0498M1515  € U 0

 roomwit / crème-blanc /
rahm-weiß / cream-white

 RE, HE

  76

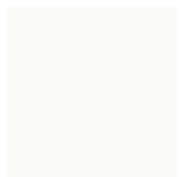

0490-1515  € U 0

 wit / blanc /
weiß / white

 RE

  81

niet moduul / non module /
nicht modul / not module

1515 Matt Collection

wandtegels / carreaux de faïence / Wandfliesen / wall tiles
 geglaazuurd / émaillé / glasiert / glazed
 niet vorstbestand / non ingélif / nicht frostsicher / not frost proof

bijpassende vloertegels / carreaux de sol correspondants /
 dazugehörige Bodenfliesen / matching floor tiles
 Global Collection 

no.	mm	inch	pieces/ m ²	pieces/ m ¹	pieces/ box	boxes/ pallet	pieces/ pallet	m ² / pallet	kg/ m ²	kg/ pallet
15810 - 15960	147x147x5,6	5.79x5.79x0.22	44	-	44 = 1,00 m ²	100	4.400	100,0	9,2	940

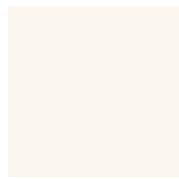

15810-1515 

 porseleinwit uni / blanc porcelaine uni /
 porzellanweiß Uni / plain porcelain white



  79

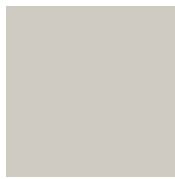

15820-1515 

 grijs uni / gris uni /
 grau Uni / plain grey



  48



15830-1515 

 muisgrijs uni / gris de souris uni /
 mausgrau Uni / plain mouse grey



  28



15840-1515 

 grijsbeige uni / gris-beige uni /
 graubeige Uni / plain grey beige



  49



15850-1515 

 agaatgrijs uni / gris d'agate uni /
 achatgrau Uni / plain agate grey



  23



15890-1515 

 ivoorzwart uni / noir d'ivoire uni /
 elfenbeinschwarz Uni / plain ivory black



  8

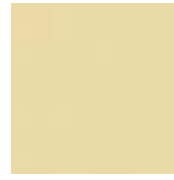

15910-1515 

 zandgeel uni / jaune de sable uni /
 sandgelb Uni / plain sand yellow



  54



15920-1515 

 napelsgeel uni / jaune de Naples uni /
 Neapelgelb Uni / plain Naples yellow



  44



15930-1515 

 koperbruin uni / brun cuivre uni /
 kupferbraun Uni / plain copper brown



  18



15940-1515 

 siennarood uni / rouge de Sienna uni /
 Siennarot Uni / plain Sienna red



  13

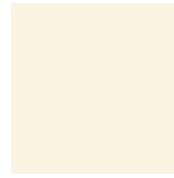

15950-1515 

 biscuit uni / biscuit uni /
 Biskuit Uni / plain biscuit



  67



15960-1515 

 donker warm grijs uni /
 gris chaleureux foncé uni /
 dunkel warm grau Uni /
 plain dark warm grey











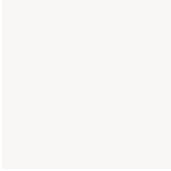
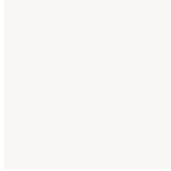
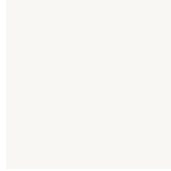
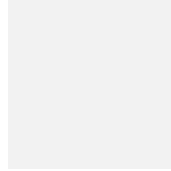



















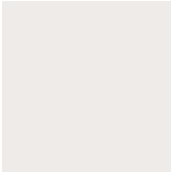
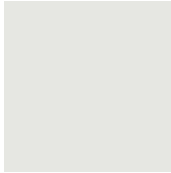
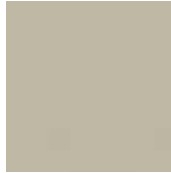







































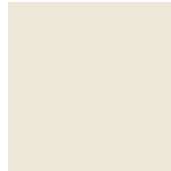







  14

1515 Murals Blend

wandtegels / carreaux de faïence / Wandfliesen / wall tiles
 geglaazuurd / émaillé / glasiert / glazed
 niet vorstbestand / non ingélf / nicht frostsicher / not frost proof

no.	mm	inch	pieces/ m ²	pieces/ m ¹	pieces/ box	boxes/ pallet	pieces/ pallet	m ² / pallet	kg/ m ²	kg/ pallet
30510 - 32030	147x147x7	5.79x5.79x0.28	44	-	33 = 0,75 m ²	115	3.795	86,3	11,7	1.038

			
30510-1515 € CC08  bright white     85  S 0300-N GL	30010-1515 € CC08  bright white     83  S 0300-N	30520-1515 € CC08  light cool grey #1   80  S 0502-R50B GL	30030-1515 € CC08  light cool grey #2   76  S 0502-R50B
			
30540-1515 € CC08  light cool grey #3   73  S 1002-R50B GL	30050-1515 € CC08  light cool grey #4   67  S 1002-R50B	30560-1515 € CC08  mid warm grey #1   45  S 2005-Y50R GL	30070-1515 € CC08  mid warm grey #2   40  S 3005-Y50R
			
30580-1515 € CC08  mid warm grey #3   37  S 3005-Y50R GL	30090-1515 € CC08  mid warm grey #4   31  S 4005-Y50R	30600-1515 € CC08  dark anthracite #1   14  S 7000-N GL	30110-1515 € CC08  dark anthracite #2   12  S 7000-N
			
30620-1515 € CC08  dark anthracite #3   12  S 7500-N GL	30130-1515 € CC08  dark anthracite #4   9  S 8000-N	32010-1515 € CC08  clay beige #1   75  S 0502-Y50R	32030-1515 € CC08  clay beige #3   65  S 1005-Y30R

1515 Murals Blend

wandtegels / carreaux de faïence / Wandfliesen / wall tiles
 geglaazuurd / émaillé / glasiert / glazed
 niet vorstbestand / non ingélif / nicht frostsicher / not frost proof

no.	mm	inch	pieces/ m ²	pieces/ m ¹	pieces/ box	boxes/ pallet	pieces/ pallet	m ² / pallet	kg/ m ²	kg/ pallet
32250 - 32130	147x147x7	5.79x5.79x0.28	44	-	33 = 0,75 m ²	115	3.795	86,3	11,7	1.038



32250-1515 € CC08

M2 silver grey #1
 c2c 58 NCS S 1500-N



32270-1515 € CC08

M2 silver grey #3
 c2c 47 NCS S 2500-N



32110-1515 € CC08

M2 air blue #1
 c2c 55 NCS S 2010-R90B



32090-1515 € CC08

M2 sea blue #1
 c2c 21 NCS S 5010-R70B



32290-1515 € CC08

M2 ocean green #1
 c2c 70 NCS S 1005-G20Y



32130-1515 € CC08

M2 wood green #1
 c2c 24 NCS S 5005-G80Y

Voor tegelpatronen zie de brochure Murals en/of www.mosa.com/nl-nl/grids.
 Pour des motifs de carreaux, nous vous invitons à consulter le dépliant Murals et / ou www.mosa.com/fr-fr/trames.
 Für Verlegemuster siehe der Prospekt Murals und/oder www.mosa.com/de-de/raster.
 For tile patterns, see the Murals brochure and/or www.mosa.com/en/grids or www.mosa.com/en-us/grids.

1515 Murals Change

wandtegels / carreaux de faïence / Wandfliesen / wall tiles
 geglazuurd / émaillé / glasiert / glazed
 niet vorstbestand / non ingélif / nicht frostsicher / not frost proof

no.	mm	inch	pieces/ m ²	pieces/ m ¹	pieces/ box	boxes/ pallet	pieces/ pallet	m ² / pallet	kg/ m ²	kg/ pallet
34510 - 34580	147x147x7	5.79x5.79x0.28	44	-	33 = 0,75 m ²	115	3.795	86,3	11,9	1.053

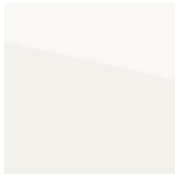

34510-1515 € AC32

M2 ✈ bright white / bright white

1515
 c2c ✈ 83 / 85 NCS S 0300-N / S 0300-N GL

34530-1515 € AC32

M2 ✈ mid warm grey #1 / #3

c2c ✈ 44 / 37 NCS S 2005-Y50R / S 3005-Y50R GL

34580-1515 € AC32

M2 ✈ ocean green #1 / #1

c2c ✈ 70 / 69 NCS S 1005-G20Y / S 1005-B80G GL



1515 Murals Fuse

wandtegels / carreaux de faïence / Wandfliesen / wall tiles
 geglaazuurd / émaillé / glasiert / glazed
 niet vorstbestand / non ingélif / nicht frostsicher / not frost proof

no.	mm	inch	pieces/ m ²	pieces/ m ¹	pieces/ box	boxes/ pallet	pieces/ pallet	m ² / pallet	kg/ m ²	kg/ pallet
38010 - 38070	147x147x7	5.79x5.79x0.28	44	-	33 = 0,75 m ²	115	3.795	86,3	11,7	1.038

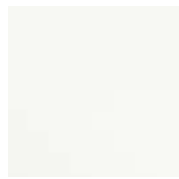

38010-1515 € BC04

M2 bright white

 80 S 0300-N

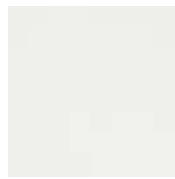

38510-1515 € BC04

M2 bright white

 81 S 0300-N GL



38520-1515 € BC04

M2 light cool grey #4

 66 S 1002-R50B GL

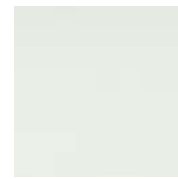

38530-1515 € BC04

M2 ocean green #1

 67 S 1005-G20Y GL



38040-1515 € BC04

M2 sea blue #1

 22 S 5010-R70B



38050-1515 € BC04

M2 mid warm grey #1

 48 S 2005-Y50R



38070-1515 € BC04

M2 dark anthracite #3

 10 S 7500-N

Deze tegels hebben een patroon met een kleurverloop.
 Ces carreaux créent un motif particulier où les couleurs se succèdent.
 Diese Fliesen haben ein Muster mit einem Farbverlauf.
 These tiles have a pattern with a colour gradation.

Voor tegelpatronen zie de brochure Murals en/of www.mosa.com/nl-nl/grids.
 Pour des motifs de carreaux, nous vous invitons à consulter le dépliant Murals et / ou www.mosa.com/fr-fr/trames.
 Für Verlegemuster siehe der Prospekt Murals und/oder www.mosa.com/de-de/raster.
 For tile patterns, see the Murals brochure and/or www.mosa.com/en-grids or www.mosa.com/en-us/grids.

15 15 Murals Lines

wandtegels / carreaux de faïence / Wandfliesen / wall tiles
 geglazuurd / émaillé / glasiert / glazed
 niet vorstbestand / non ingélif / nicht frostsicher / not frost proof

no.	mm	inch	pieces/ m ²	pieces/ m ¹	pieces/ box	boxes/ pallet	pieces/ pallet	m ² / pallet	kg/ m ²	kg/ pallet
36010 - 36020	147x147x7	5.79x5.79x0.28	44	-	29 = 0,659 m ²	115	3.335	75,8	12,0	932



36010-1515

€ AC03

M2 bright white



c2c 83 NCS S 0300-N



36510-1515

€ AC03

M2 bright white



c2c 85 NCS S0300-NGL

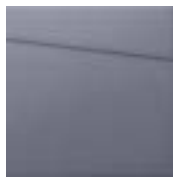

36030-1515

€ AC03

M2 sea blue #1



21 NCS S 5010-R70B



36020-1515

€ AC03

M2 mid warm grey #4







31 NCS S 4005-Y50R



15 20 Holland 2040

wandtegels / carreaux de faïence / Wandfliesen / wall tiles
 geglaazuurd / émaillé / glasiert / glazed
 niet vorstbestand / non ingélif / nicht frostsicher / not frost proof

bijpassende vloertegels / carreaux de sol correspondants /
 dazugehörige Bodenfliesen / matching floor tiles
 Core Collection Terra, nos. 203, 204, 216, 225, 226, 264, 266  
 Softline 
 Softgrip 

no.	mm	inch	pieces/ m ²	pieces/ m ¹	pieces/ box	boxes/ pallet	pieces/ pallet	m ² / pallet	kg/ m ²	kg/ pallet
0495L - 04973	147x197x6,3	5.79x7.76x0.25	33	-	33 = 1,00 m ²	100	3.300	100,0	10,6	1.088

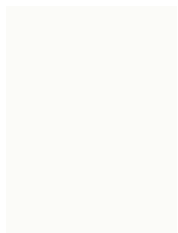

0495L1520  € U 0

 wit (lange zijde geglaazuurd) /
 blanc (côté long émaillé) /
 weiß (Längsseite glasiert) /
 white (longest edge glazed)

 RE, HE



  78

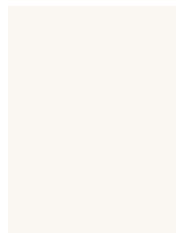

0498L1520  € U 0

 roomwit (lange zijde geglaazuurd) /
 crème-blanc (côté long émaillé) /
 rahm-weiß (Längsseite glasiert) /
 cream-white (longest edge glazed)

 RE, HE



  76

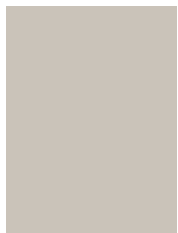

13730L1520  € DC11

 licht warm grijs / gris chaleureux clair /
 hell warm grau / light warm grey



  49



17090L1520  € DC11

 antraciet / anthracite /
 anthrazit / anthracite



  11



04903-1520  € U 0

 wit / blanc /
 weiß / white

  81

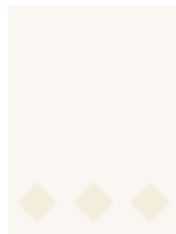

04973-1520  € U 0

 roomwit / crème-blanc /
 rahm-weiß / cream-white

  79

15 20 Holland 2050

wandtegels / carreaux de faïence / Wandfliesen / wall tiles
 geglaazuurd / émaillé / glasiert / glazed
 niet vorstbestand / non ingélif / nicht frostsicher / not frost proof

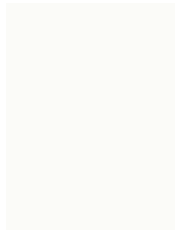

bijpassende vloertegels / carreaux de sol correspondants /
 dazugehörige Bodenfliesen / matching floor tiles
 Holland 2050 

no.	mm	inch	pieces/ m ²	pieces/ m ¹	pieces/ box	boxes/ pallet	pieces/ pallet	m ² / pallet	kg/ m ²	kg/ pallet
0490L - 17070L	147x197x6,3	5.79x7.76x0.25	33	-	33 = 1,00 m ²	100	3.300	100,0	10,6	1.088



0490L1520  € U 0

 wit (lange zijde geglaazuurd) /
 blanc (côté long émaillé) /
 weiß (Längsseite glasiert) /
 white (longest edge glazed)

 HI, HU, II, IU, UI, UU, RE, HE 



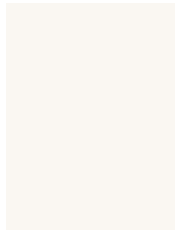

  81



0497L1520  € U 0

 roomwit (lange zijde geglaazuurd) /
 crème-blanc (côté long émaillé) /
 rahm-weiß (Längsseite glasiert) /
 cream-white (longest edge glazed)

 RE, HE 

  79



13740L1520  € U 1

 midden warm grijs /
 gris chaleureux moyen /
 mittel warm grau / mid warm grey

  28

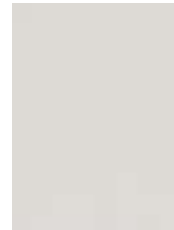

16870L1520  € U 1

 grijs uni / gris uni /
 grau Uni / plain grey

   



 51  S 3000-N GL

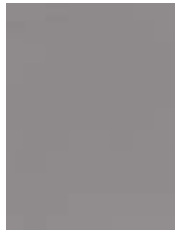

16890L1520  € U 1

 donkergrijs / gris foncé /
 dunkelgrau / dark grey

 



  26

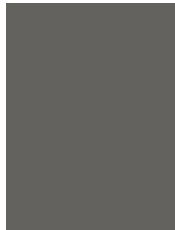

17050L1520  € U 1

 licht antraciet / anthracite clair /
 hell anthrazit / light anthracite

 



  14



17060L1520  € U 1

 beige / beige /
 beige / beige

 



  50



17070L1520  € U 1

 grijsbruin / gris-brun /
 graubraun / grey brown





 



  20

15 20 Ledo

wandtegels / carreaux de faïence / Wandfliesen / wall tiles
 geglaazuurd / émaillé / glasiert / glazed
 niet vorstbestand / non ingélif / nicht frostsicher / not frost proof

bijpassende vloertegels / carreaux de sol correspondants /
 dazugehörige Bodenfliesen / matching floor tiles
 Core Collection Terra, nos. 216, 225, 264, 266  
 Softline, nos. 74000, 74020, 74090, 74110 
 Softgrip, nos. 74000, 74020, 74090, 74110 

no.	mm	inch	pieces/ m ²	pieces/ m ¹	pieces/ box	boxes/ pallet	pieces/ pallet	m ² / pallet	kg/ m ²	kg/ pallet
2880LL - 2900LL	147x197x6,3	5.79x7.76x0.25	33	-	33 = 1,00 m ²	100	3.300	100,0	10,6	1.088



2880LL1520  € DC16

 wit-grijs (lange zijde geglaazuurd) /
 blanc-gris (côté long émaillé) /
 weiß-grau (Längsseite glasiert) /
 white-grey (longest edge glazed)

  82



2900LL1520  € DC16

 wit-pergamon (lange zijde geglaazuurd) /
 blanc-pergamon (côté long émaillé) /
 weiß-pergamon (Längsseite glasiert) /
 white-pergamon (longest edge glazed)

  82

15 20 Vesta

wandtegels / carreaux de faïence / Wandfliesen / wall tiles
 geglazuurd / émaillé / glasiert / glazed
 niet vorstbestand / non ingélif / nicht frostsicher / not frost proof

bijpassende vloertegels / carreaux de sol correspondants /
 dazugehörige Bodenfliesen / matching floor tiles
 Softline, nos. 74020, 74030, 74110 
 Softgrip, nos. 74020, 74030, 74110 

no.	mm	inch	pieces/ m ²	pieces/ m ¹	pieces/ box	boxes/ pallet	pieces/ pallet	m ² / pallet	kg/ m ²	kg/ pallet
45210L - 45220L	147x197x6,3	5.79x7.76x0.25	33	-	33 = 1,00 m ²	100	3.300	100,0	10,6	1.088



45210L1520  € DC16

 wit-grijs (lange zijde geglazuurd) /
 blanc-gris (côté long émaillé) /
 weiß-grau (Längsseite glasiert) /
 white-grey (longest edge glazed)

  77







45220L1520  € DC16

 beige (lange zijde geglazuurd) /
 beige (côté long émaillé) /
 beige (Längsseite glasiert) /
 beige (longest edge glazed)

  76

15/20 Villa

wandtegels / carreaux de faïence / Wandfliesen / wall tiles
 geglazuurd / émaillé / glasiert / glazed
 niet vorstbestand / non ingélif / nicht frostsicher / not frost proof

bijpassende vloertegels / carreaux de sol correspondants /
 dazugehörige Bodenfliesen / matching floor tiles
 Core Collection Terra, nos. 216, 226, 264, 266  
 Softline, nos. 74000, 74020, 74110 
 Softgrip, nos. 74000, 74020, 74110 

no.	mm	inch	pieces/ m ²	pieces/ m ¹	pieces/ box	boxes/ pallet	pieces/ pallet	m ² / pallet	kg/ m ²	kg/ pallet
45260L - 45270L	147x197x6,3	5.79x7.76x0.25	33	-	33 = 1,00 m ²	100	3.300	100,0	10,6	1.088



45260L1520  € DC16

 wit-grijs (lange zijde geglazuurd) /
 blanc-gris (côté long émaillé) /
 weiß-grau (Längsseite glasiert) /
 white-grey (longest edge glazed)

  77





45270L1520  € DC16

 beige (lange zijde geglazuurd) /
 beige (côté long émaillé) /
 beige (Längsseite glasiert) /
 beige (longest edge glazed)

  72

1530 15thirty Accent

wandtegels / carreaux de faïence / Wandfliesen / wall tiles
 geglaazuurd / émaillé / glasiert / glazed
 niet vorstbestand / non ingélif / nicht frostsicher / not frost proof





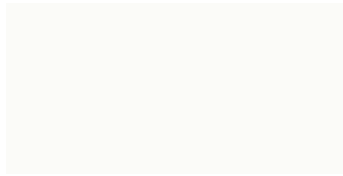

bijpassende vloertegels / carreaux de sol correspondants /
 dazugehörige Bodenfliesen / matching floor tiles
 Core Collection Terra, nos. 203, 204, 216, 225, 226, 264, 266   
 Softline, nos. 74000, 74020, 74030, 74050, 74060, 74070, 74090 
 Softgrip, nos. 74000, 74020, 74030, 74050, 74060, 74070, 74090 

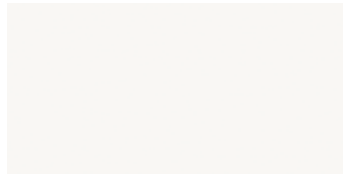
no.	mm	inch	pieces/ m ²	pieces/ m ¹	pieces/ box	boxes/ pallet	pieces/ pallet	m ² / pallet	kg/ m ²	kg/ pallet
0460 - 17090	147x297x7	5.79x11.69x0.28	22	-	21 = 0,955 m ²	80	1.680	76,4	11,6	910









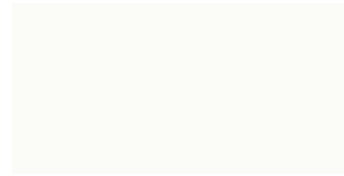



0460-1530   **CC12**
 koel wit / blanc frais /
 kühl weiß / cool white
    
  85  S 0502-R50B GL









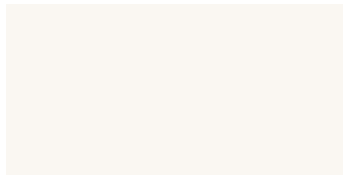

0465-1530   **CC12**
 koel wit / blanc frais /
 kühl weiß / cool white
 
  85









0495-1530   **CC33**
 wit / blanc /
 weiß / white
 
   
  78









0498-1530   **CC33**
 roomwit / crème-blanc /
 rahm-weiß / cream-white
 
  
  76











13810-1530   **CC11**
 wit-grijs / blanc-gris /
 weiß-grau / white-grey
 
  79



13830-1530   **CC11**
 wit-beige / blanc-beige /
 weiß-beige / white-beige
 
  78



17090-1530   **CC11**
 antraciet / anthracite /
 anthrazit / anthracite
 
  
  11

1530 15thirty Accent

wandtegels / carreaux de faïence / Wandfliesen / wall tiles
 geglaazuurd / émaillé / glasiert / glazed
 niet vorstbestand / non ingélif / nicht frostsicher / not frost proof

bijpassende vloertegels / carreaux de sol correspondants /
 dazugehörige Bodenfliesen / matching floor tiles
 Core Collection Terra, nos. 203, 204, 216, 225, 226, 264, 266
 Softline, nos. 74000, 74020, 74030, 74050, 74060, 74070, 74090
 Softgrip, nos. 74000, 74020, 74030, 74050, 74060, 74070, 74090

no.	mm	inch	pieces/ m ²	pieces/ m ¹	pieces/ box	boxes/ pallet	pieces/ pallet	m ² / pallet	kg/ m ²	kg/ pallet
13640 - 30100	147x297x7	5.79x11.69x0.28	22	-	21 = 0,955 m ²	80	1.680	76,4	11,6	910



13640-1530 **CC11**
 M3 midden warm grijs / gris chaleureux moyen /
 mittel warm grau / mid warm grey
 C2C 29



15200-1530 **CC09**
 M3 ivoorzwart uni / noir d'ivoire uni /
 elfenbeinschwarz Uni / plain ivory black

 C2C 10 S 8000-N



15220-1530 **CC09**
 M3 grijs uni / gris uni /
 grau Uni / plain grey

 C2C 44 S 3000-N



15250-1530 **CC11**
 M3 donkergrijs / gris foncé /
 dunkelgrau / dark grey
 C2C 25



15260-1530 **CC11**
 M3 beige / beige /
 beige / beige
 C2C 48



15270-1530 **CC11**
 M3 grijsbruin / gris-brun /
 graubraun / grey brown
 C2C 20



30100-1530 **CC08**
 M2 dark anthracite #1
 C2C 13 S 7000-N



1530 15thirty Greys

wandtegels / carreaux de faïence / Wandfliesen / wall tiles
 geglaazuurd / émaillé / glasiert / glazed
 niet vorstbestand / non ingélf / nicht frostsicher / not frost proof



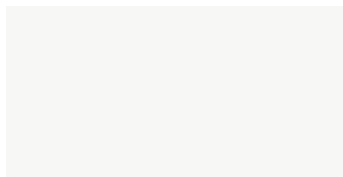

bijpassende vloertegels / carreaux de sol correspondants /
 dazugehörige Bodenfliesen / matching floor tiles
 Core Collection Terra, nos. 203, 204 

no.	mm	inch	pieces/ m ²	pieces/ m ¹	pieces/ box	boxes/ pallet	pieces/ pallet	m ² / pallet	kg/ m ²	kg/ pallet
13710 - 15220	147x297x7	5.79x11.69x0.28	22	-	21 = 0,955 m ²	80	1.680	76,4	11,6	910



13710-1530  **CC11**
 ✈ extra wit / blanc extra /
 ✈ extra weiß / extra white
  78





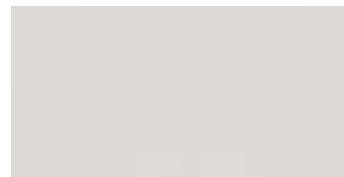

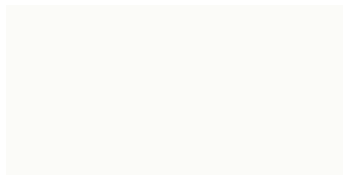

13730-1530  **CC11**
 ✈ licht warm grijs / gris chaleureux clair /
 ✈ hell warm grau / light warm grey
 
  49







16870-1530   **U 1**
 ✈ grijs uni / gris uni /
 ✈ grau Uni / plain grey
   
   S 3000-N GL

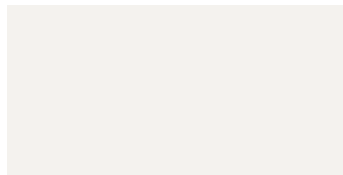





16900-1530  **CC09**
 ✈ accent wit / blanc accent /
 ✈ Akzent weiß / accent white
  
   S 0502-R50B GL









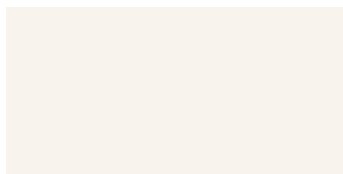

13610-1530  **CC11**
 extra wit / blanc extra /
 extra weiß / extra white
  78





13630-1530  **CC11**
 licht warm grijs / gris chaleureux clair /
 hell warm grau / light warm grey
  42



15010-1530  **CC09**
 wit uni / blanc uni /
 weiß Uni / plain white
  
   S 1002-Y50R



15220-1530   **CC09**
 grijs uni / gris uni /
 grau Uni / plain grey
 
   S 3000-N

1530 Global Collection

wandtegels / carreaux de faïence / Wandfliesen / wall tiles
 geglaazuurd / émaillé / glasiert / glazed
 niet vorstbestand / non ingélf / nicht frostsicher / not frost proof

bijpassende vloertegels / carreaux de sol correspondants /
 dazugehörige Bodenfliesen / matching floor tiles
 Global Collection 1530 1530 1530

no.	mm	inch	pieces/ m ²	pieces/ m ¹	pieces/ box	boxes/ pallet	pieces/ pallet	m ² / pallet	kg/ m ²	kg/ pallet
15010 - 16790	147x297x7	5.79x11.69x0.28	22	-	21 = 0,955 m ²	80	1.680	76,4	11,6	910

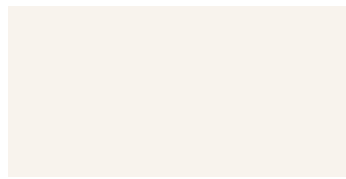

15010-1530 € CC09

M3 wit uni / blanc uni /
 weiß Uni / plain white
 1530 1530 1530
 C2C 78 NCS S 1002-Y50R



15200-1530 2040 € CC09

M3 ivoorzwart uni / noir d'ivoire uni /
 elfenbeinschwarz Uni / plain ivory black
 1530 1530
 C2C 10 NCS S 8000-N



15220-1530 2040 € CC09

M3 grijs uni / gris uni /
 grau Uni / plain grey
 1530 1530
 C2C 44 NCS S 3000-N

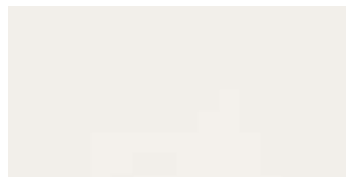

16610-1530 € CC09

M3 roomwit uni / crème-blanc uni /
 rahm-weiß Uni / plain cream-white
 1530 1530
 C2C 84 NCS S 0502-Y GL



16630-1530 € CC09

M3 grijsbeige uni / gris-beige uni /
 graubeige Uni / plain grey beige
 1530 1530
 C2C 52 NCS S 3005-Y20R GL



16650-1530 € CC09

M3 agaatgrijs uni / gris d'agate uni /
 achatgrau Uni / plain agate grey
 1530 1530
 C2C 25 NCS S 5005-Y50R GL

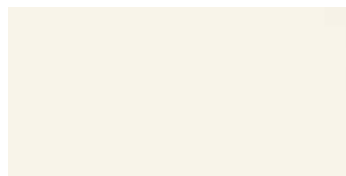

16660-1530 € CC09

M3 ivoorwit uni / blanc d'ivoire uni /
 elfenbeinweiß Uni / plain ivory white
 1530 1530
 C2C 82 NCS S 0505-Y10R GL



16680-1530 € CC09

M3 zandgeel uni / jaune de sable uni /
 sandgelb Uni / plain sand yellow
 1530
 C2C 64 NCS S 2020-Y20R GL



16690-1530 € CC09

M3 parelgroen uni / vert de perle uni /
 perlgrün Uni / plain pearl green
 1530
 C2C 80 NCS S 0505-G20Y GL

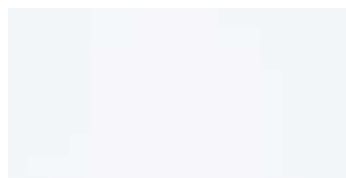

16740-1530 € CC09

M3 parelblauw uni / bleu de perle uni /
 perlblau Uni / plain pearl blue
 1530
 C2C 80 NCS S 0505-R90B GL

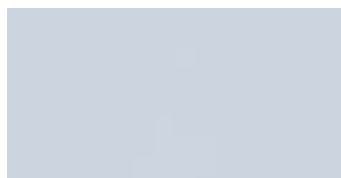

16760-1530 € CC09

M3 sèvresblauw uni / bleu de Sèvres uni /
 Sèvresblau Uni / plain Sèvres blue
 1530
 C2C 54 NCS S 2020-R90B GL

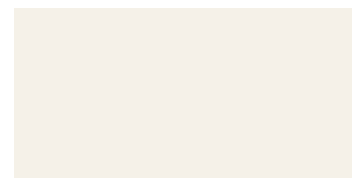

16790-1530 € CC09

M3 ivoor uni / ivoire uni /
 elfenbein Uni / plain ivory
 1530
 C2C 78 NCS S 1010-Y30R GL

1530 Global Collection

wandtegels / carreaux de faïence / Wandfliesen / wall tiles
 geglaazuurd / émaillé / glasiert / glazed
 niet vorstbestand / non ingélif / nicht frostsicher / not frost proof

bijpassende vloertegels / carreaux de sol correspondants /
 dazugehörige Bodenfliesen / matching floor tiles
 Global Collection 10 15 30

no.	mm	inch	pieces/ m ²	pieces/ m ¹	pieces/ box	boxes/ pallet	pieces/ pallet	m ² / pallet	kg/ m ²	kg/ pallet
16840 - 17900	147x297x7	5.79x11.69x0.28	22	-	21 = 0,955 m ²	80	1.680	76,4	11,6	910

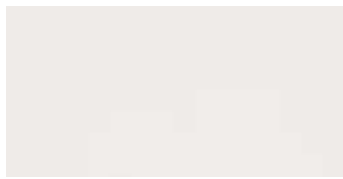

16840-1530 € CC09

koel wit uni / blanc frais uni /
 kühl weiß Uni / plain cool white



c2c 78 NCS S 1002-R50B GL



16850-1530 € CC09

ivoorzwart uni / noir d'ivoire uni /
 elfenbeinschwarz Uni / plain ivory black



c2c 12 NCS S 8000-N GL



16860-1530 € CC09

ecruwit uni / blanc écru uni /
 weiß ungebleicht Uni /
 plain white unbleached



c2c 78 NCS S 1005-Y10R GL



16870-1530 2020 € U 1

grijs uni / gris uni /
 grau Uni / plain grey



c2c 51 NCS S 3000-N GL



16880-1530 € CC09

muisgrijs uni / gris de souris uni /
 mausgrau Uni / plain mouse grey



c2c 27 NCS S 5500-N GL



26240-1530 € CC09

warm grijs uni / gris chaleureux uni /
 warm grau Uni / plain warm grey



c2c 15 NCS S 7005-Y20R GL



26250-1530 € CC09

antraciet uni / anthracite uni /
 anthrazit Uni / plain anthracite



c2c 16 NCS S 6500-N GL

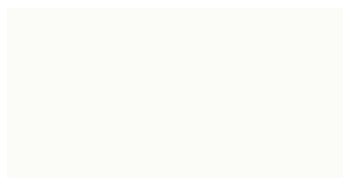

16900-1530 € CC09

accent wit / blanc accent /
 Akzent weiß / accent white



c2c 85 NCS S 0502-R50B GL

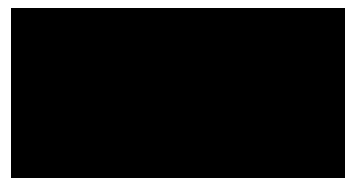

16910-1530 € CC09

accent zwart / noir accent /
 Akzent schwarz / accent black



c2c 5 NCS S 9000-N GL



17900-1530 € CC09

macaw green



c2c 45 NCS S 0560-G40Y GL

Voor tegelpatronen zie www.mosa.com/nl-nl/grids.
 Pour des motifs de carreaux, nous vous invitons à consulter www.mosa.com/fr-fr/trames.
 Für Verlegemuster siehe www.mosa.com/de-de/raster.
 For tile patterns, see www.mosa.com/en-us/grids or www.mosa.com/en-us/grids.

15 30 Holland 2050

wandtegels / carreaux de faïence / Wandfliesen / wall tiles
 geglaazuurd / émaillé / glasiert / glazed
 niet vorstbestand / non ingélif / nicht frostsicher / not frost proof

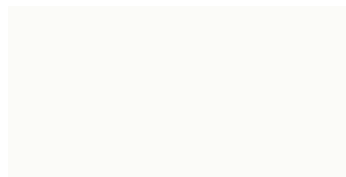

bijpassende vloertegels / carreaux de sol correspondants /
 dazugehörige Bodenfliesen / matching floor tiles
 Holland 2050 

no.	mm	inch	pieces/ m ²	pieces/ m ¹	pieces/ box	boxes/ pallet	pieces/ pallet	m ² / pallet	kg/ m ²	kg/ pallet
0490 - 17070	147x297x7	5.79x11.69x0.28	22	-	21 = 0,955 m ²	80	1.680	76,4	11,6	910



0490-1530  € CC33

 wit / blanc /
weiß / white

 HI, HU, II, IU, UI, UU, RE, HE 



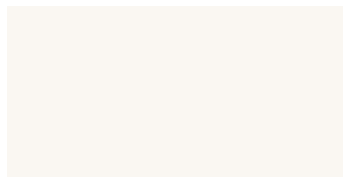

  81



0497-1530  € CC33

 roomwit / crème-blanc /
rahm-weiß / cream-white

 RE, HE 

  79



13740-1530  € U 1

 midden warm grijs / gris chaleureux moyen /
mittel warm grau / mid warm grey

 



  28



16870-1530  € U 1

 grijs / gris /
grau / grey

   



  51  S 3000-N GL



16890-1530  € U 1

 donkergrijs / gris foncé /
dunkelgrau / dark grey

 



  26



17050-1530  € U 1

 licht antraciet / anthracite clair /
hell anthrazit / light anthracite

 



  14



17060-1530  € U 1

 beige / beige /
beige / beige

 



  50



17070-1530  € U 1

 grijsbruin / gris-brun /
graubraun / grey brown

 



  20

1530 Matt Collection

wandtegels / carreaux de faïence / Wandfliesen / wall tiles
 geglaazuurd / émaillé / glasiert / glazed
 niet vorstbestand / non ingélf / nicht frostsicher / not frost proof

bijpassende vloertegels / carreaux de sol correspondants /
 dazugehörige Bodenfliesen / matching floor tiles
 Global Collection 

no.	mm	inch	pieces/ m ²	pieces/ m ¹	pieces/ box	boxes/ pallet	pieces/ pallet	m ² / pallet	kg/ m ²	kg/ pallet
15810 - 15960	147x297x7	5.79x11.69x0.28	22	-	21 = 0,955 m ²	80	1.680	76,4	11,6	910

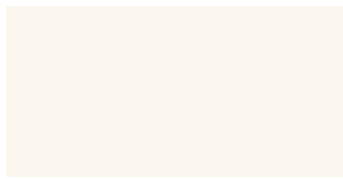

15810-1530  BC06

 porseleinwit uni / blanc porcelaine uni /
 porzellanweiß Uni / plain porcelain white



  79



15820-1530  BC06

 grijs uni / gris uni /
 grau Uni / plain grey



  48



15830-1530  BC06

 muisgrijs uni / gris de souris uni /
 mausgrau Uni / plain mouse grey



  28



15840-1530  BC06

 grijsbeige uni / gris-beige uni /
 graubeige Uni / plain grey beige



  49



15850-1530  BC06

 agaatgrijs uni / gris d'agate uni /
 achatgrau Uni / plain agate grey



  23



15890-1530  BC06

 ivoorzwart uni / noir d'ivoire uni /
 elfenbeinschwarz Uni / plain ivory black



  8

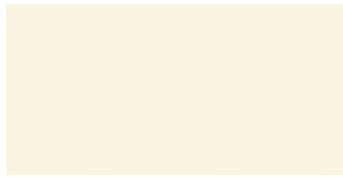

15950-1530  BC06

 biscuit uni / biscuit uni /
 Biskuit Uni / plain biscuit



  67



15960-1530  BC06

 donker warm grijs uni /
 gris chaleureux foncé uni /
 dunkel warm grau Uni /
 plain dark warm grey



  14

1530 Murals Blend

wandtegels / carreaux de faïence / Wandfliesen / wall tiles
 geglaazuurd / émaillé / glasiert / glazed
 niet vorstbestand / non ingélif / nicht frostsicher / not frost proof

no.	mm	inch	pieces/ m ²	pieces/ m ¹	pieces/ box	boxes/ pallet	pieces/ pallet	m ² / pallet	kg/ m ²	kg/ pallet
30010 - 30610	147x297x7	5.79x11.69x0.28	22	-	21 = 0,955 m ²	80	1.680	76,4	12,0	939

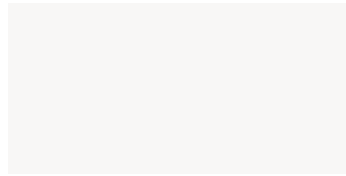

30010-1530 € CC08

M2 bright white
 1530
 c2c 83 NCS S 0300-N

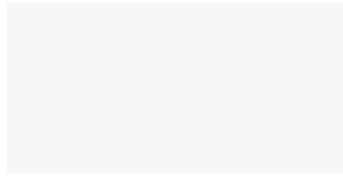

30510-1530 € CC08

M2 bright white
 1530
 c2c 85 NCS S 0300-N GL

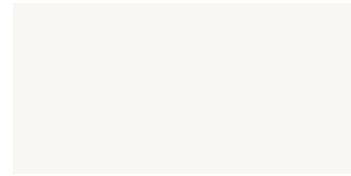

30020-1530 € CC08

M2 light cool grey #1
 c2c 81 NCS S 0502-R50B



30530-1530 € CC08

M2 light cool grey #2
 c2c 78 NCS S 0502-R50B GL

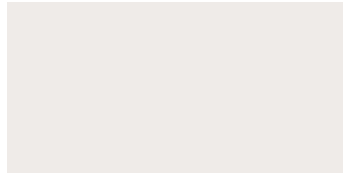

30040-1530 € CC08

M2 light cool grey #3
 c2c 72 NCS S 1002-R50B

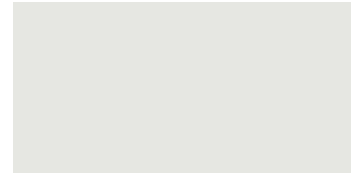

30550-1530 € CC08

M2 light cool grey #4
 c2c 70 NCS S 1002-R50B GL



30060-1530 € CC08

M2 mid warm grey #1
 c2c 44 NCS S 2005-Y50R



30570-1530 € CC08

M2 mid warm grey #2
 c2c 40 NCS S 3005-Y50R GL



30080-1530 € CC08

M2 mid warm grey #3
 c2c 36 NCS S 3005-Y50R



30590-1530 € CC08

M2 mid warm grey #4
 c2c 32 NCS S 4005-Y50R GL



30100-1530 2040 € CC08

M2 dark anthracite #1
 c2c 13 NCS S 7000-N



30610-1530 € CC08

M2 dark anthracite #2
 c2c 13 NCS S 7000-N GL

15/30 Murals Blend

wandtegels / carreaux de faïence / Wandfliesen / wall tiles
 geglaazuurd / émaillé / glasiert / glazed
 niet vorstbestand / non ingélif / nicht frostsicher / not frost proof

no.	mm	inch	pieces/ m ²	pieces/ m ¹	pieces/ box	boxes/ pallet	pieces/ pallet	m ² / pallet	kg/ m ²	kg/ pallet
30120 - 32240	147x297x7	5.79x11.69x0.28	22	-	21 = 0,955 m ²	80	1.680	76,4	12,0	939



30120-1530 € CC08

M₂ dark anthracite #3
 c2c 10 NGS S 7500-N



30630-1530 € CC08

M₂ dark anthracite #4
 c2c 10 NGS S 8000-N GL

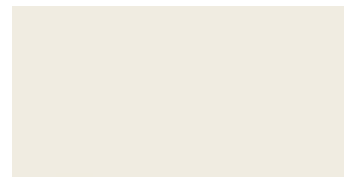

32020-1530 € CC08

M₂ clay beige #2
 c2c 71 NGS S 1002-Y50R

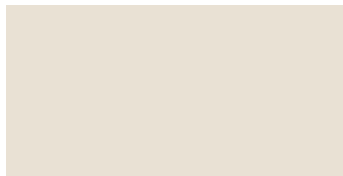

32040-1530 € CC08

M₂ clay beige #4
 c2c 62 NGS S 1505-Y40R



32260-1530 € CC08

M₂ silver grey #2
 c2c 52 NGS S 2000-N



32280-1530 € CC08

M₂ silver grey #4
 c2c 43 NGS S 3000-N



32120-1530 € CC08

M₂ air blue #2
 c2c 43 NGS S 3005-R80B



32100-1530 € CC08

M₂ sea blue #2
 c2c 14 NGS S 6010-R70B



32300-1530 € CC08

M₂ ocean green #2
 c2c 58 NGS S 1010-G20Y



32140-1530 € CC08

M₂ wood green #2
 c2c 16 NGS S 7005-G80Y



32320-1530 € CC08

M₂ oxide red #2
 c2c 21 NGS S 5020-Y70R



32180-1530 € CC08

M₂ earth brown #2
 c2c 10 NGS S 7005-Y20R

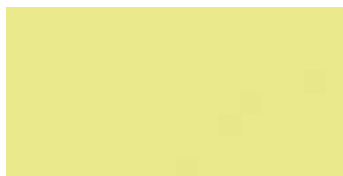

32200-1530 € CC08

M₂ brimstone yellow #2
 c2c 71 NGS S 1040-G80Y



32240-1530 € CC08

M₂ brass brown #2
 c2c 24 NGS S 5030-Y

Voor tegelpatronen zie de brochure Murals en/of www.mosa.com/nl-nl/grids.
 Pour des motifs de carreaux, nous vous invitons à consulter le dépliant Murals et / ou www.mosa.com/fr-fr/trames.
 Für Verlegemuster siehe der Prospekt Murals und/oder www.mosa.com/de-de/raster.
 For tile patterns, see the Murals brochure and/or www.mosa.com/en-grids or www.mosa.com/en-us-grids.

1530 Murals Change

wandtegels / carreaux de faïence / Wandfliesen / wall tiles
 geglaazuurd / émaillé / glasiert / glazed
 niet vorstbestand / non ingélif / nicht frostsicher / not frost proof

no.	mm	inch	pieces/ m ²	pieces/ m ¹	pieces/ box	boxes/ pallet	pieces/ pallet	m ² / pallet	kg/ m ²	kg/ pallet
34510 - 34550	147x297x7	5.79x11.69x0.28	22	-	21 = 0,955 m ²	80	1.680	76,4	12,4	969

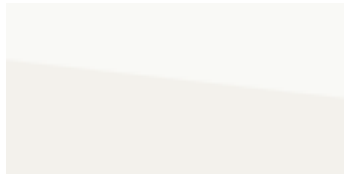

34510-1530 **€** AC31

M2 bright white / bright white



c2c 83 / 85 **NGS** S 0300-N / S 0300-N GL



34040-1530 **€** AC31

M2 **M2** clay beige #2 / #1



71 / 75 **NGS** S 1002-Y50R / S 0502-Y50R



34550-1530 **€** AC31

M2 dark anthracite #4 / #4



9 / 10 **NGS** S 8000-N / S 8000-N GL

15/30 Murals Fuse

wandtegels / carreaux de faïence / Wandfliesen / wall tiles
 geglaazuurd / émaillé / glasiert / glazed
 niet vorstbestand / non ingélf / nicht frostsicher / not frost proof

no.	mm	inch	pieces/ m ²	pieces/ m ¹	pieces/ box	boxes/ pallet	pieces/ pallet	m ² / pallet	kg/ m ²	kg/ pallet
38010 - 38070	147x297x7	5.79x11.69x0.28	22	-	21 = 0,955 m ²	80	1.680	76,4	12,0	939

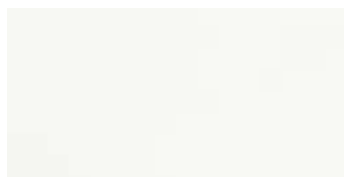

38010-1530 € BC04

M₂ bright white
 80 NCS S 0300-N

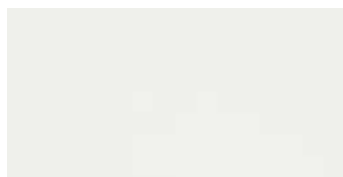

38510-1530 € BC04

M₂ bright white
 81 NCS S 0300-N GL



38520-1530 € BC04

M₂ light cool grey #4
 66 NCS S 1002-R50B GL

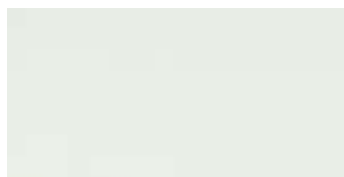

38530-1530 € BC04

M₂ ocean green #1
 67 NCS S 1005-G20Y GL



38040-1530 € BC04

M₂ sea blue #1
 22 NCS S 5010-R70B



38050-1530 € BC04

M₂ mid warm grey #1
 48 NCS S 2005-Y50R



38060-1530 € BC04

M₂ brass brown #1
 32 NCS S 3030-Y



38070-1530 € BC04

M₂ dark anthracite #3
 10 NCS S 7500-N

Deze tegels hebben een patroon met een kleurverloop.
 Ces carreaux créent un motif particulier où les couleurs se succèdent.
 Diese Fliesen haben ein Muster mit einem Farbverlauf.
 These tiles have a pattern with a colour gradation.

Voor tegelpatronen zie de brochure Murals en/of www.mosa.com/nl-nl/grids.
 Pour des motifs de carreaux, nous vous invitons à consulter le dépliant Murals et / ou www.mosa.com/fr-fr/trames.
 Für Verlegemuster siehe der Prospekt Murals und/oder www.mosa.com/de-de/raster.
 For tile patterns, see the Murals brochure and/or www.mosa.com/en-us/grids or www.mosa.com/en-us/grids.

15 30 Murals Lines

wandtegels / carreaux de faïence / Wandfliesen / wall tiles
 geglaazuurd / émaillé / glasiert / glazed
 niet vorstbestand / non ingélif / nicht frostsicher / not frost proof

no.	mm	inch	pieces/ m ²	pieces/ m ¹	pieces/ box	boxes/ pallet	pieces/ pallet	m ² / pallet	kg/ m ²	kg/ pallet
36010 - 36050	147x297x7	5.79x11.69x0.28	22	-	18 = 0,818 m ²	80	1.440	65,5	12,6	847



36010-1530 AC02

bright white



83 S 0300-N



36510-1530 AC02

bright white



85 S 0300-N GL



36080-1530 AC02

silver grey #1



57 S 1500-N



36050-1530 AC02





dark anthracite #1



13 S 7000-N

2025 Holland 2040

wandtegels / carreaux de faïence / Wandfliesen / wall tiles
 geglaazuurd / émaillé / glasiert / glazed
 niet vorstbestand / non ingélf / nicht frostsicher / not frost proof

bijpassende vloertegels / carreaux de sol correspondants /
 dazugehörige Bodenfliesen / matching floor tiles
 Core Collection Terra, nos. 203, 204, 216, 225, 226, 264, 266  
 Softline 
 Softgrip 

no.	mm	inch	pieces/ m ²	pieces/ m ¹	pieces/ box	boxes/ pallet	pieces/ pallet	m ² / pallet	kg/ m ²	kg/ pallet
0495 - 04975	197x247x7,4	7.76x9.72x0.29	20	-	20 = 1,00 m ²	84	1.680	84,0	12,6	1.080

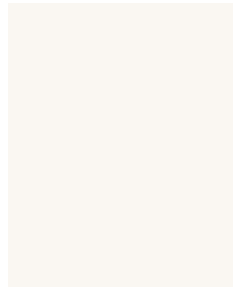
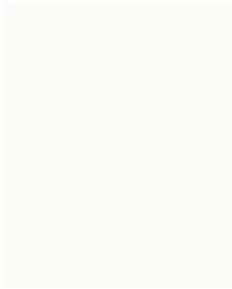

0495-2025  € U 0

M3 wit / blanc /
weiß / white



RE, HE



78

0498-2025  € U 0

M3 roomwit / crème-blanc /
rahm-weiß / cream-white



RE, HE



76

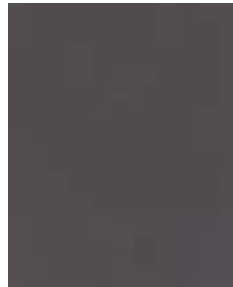
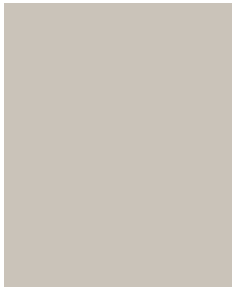

13730-2025  € DC11

licht warm grijs / gris chaleureux clair /
hell warm grau / light warm grey



49

17090-2025  € DC11

antraciet / anthracite /
anthrazit / anthracite



11

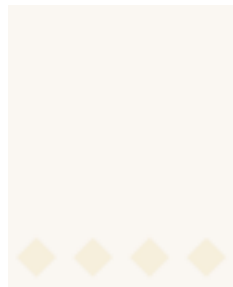

04905-2025  € U 0

wit / blanc /
weiß / white



RE, HE

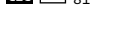

81

04975-2025  € U 0

roomwit / crème-blanc /
rahm-weiß / cream-white



RE, HE



79

Holland 2050

wandtegels / carreaux de faïence / Wandfliesen / wall tiles
 geglaazuurd / émaillé / glasiert / glazed
 niet vorstbestand / non ingélif / nicht frostsicher / not frost proof

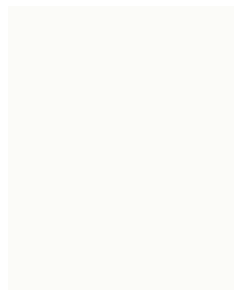

bijpassende vloertegels / carreaux de sol correspondants /
 dazugehörige Bodenfliesen / matching floor tiles
 Holland 2050 

no.	mm	inch	pieces/ m ²	pieces/ m ¹	pieces/ box	boxes/ pallet	pieces/ pallet	m ² / pallet	kg/ m ²	kg/ pallet
0490 - 17070	197x247x7,4	7.76x9.72x0.29	20	-	20 = 1,00 m ²	84	1.680	84,0	12,6	1.080



0490-2025  € U 0

 wit / blanc /
weiß / white

 HI, HU, II, IU, UI, UU, RE, HE 

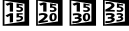

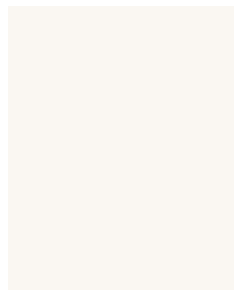

  81



0497-2025  € U 0

 roomwit / crème-blanc /
rahm-weiß / cream-white

 RE, HE 



  79



13740-2025  € U 1

 midden warm grijs /
gris chaleureux moyen /
mittel warm grau / mid warm grey







  28



16870-2025  € U 1

 grijs uni / gris uni /
grau Uni / plain grey

 



  51  S 3000-N GL



16890-2025  € U 1

 donkergrijs / gris foncé /
dunkelgrau / dark grey





  26

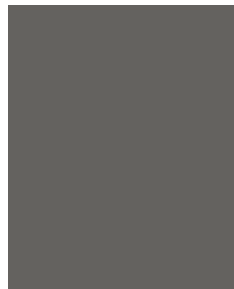

17050-2025  € U 1

 licht antraciet / anthracite clair /
hell anthrazit / light anthracite





  14



17060-2025  € U 1

 beige / beige /
beige / beige





  50



17070-2025  € U 1

 grijsbruin / gris-brun /
graubraun / grey brown









  20

2025 Villa

wandtegels / carreaux de faïence / Wandfliesen / wall tiles
 geglaazuurd / émaillé / glasiert / glazed
 niet vorstbestand / non ingélif / nicht frostsicher / not frost proof

bijpassende vloertegels / carreaux de sol correspondants /
 dazugehörige Bodenfliesen / matching floor tiles
 Core Collection Terra, nos. 216, 226, 264, 266  
 Softline, nos. 74000, 74020, 74110 
 Softgrip, nos. 74000, 74020, 74110 

no.	mm	inch	pieces/ m ²	pieces/ m ¹	pieces/ box	boxes/ pallet	pieces/ pallet	m ² / pallet	kg/ m ²	kg/ pallet
45260 - 45270	197x247x7,4	7.76x9.72x0.29	20	-	20 = 1,00 m ²	84	1.680	84,0	12,6	1.080



45260-2025   DC16

 wit-grijs / blanc-gris /
weiß-grau / white-grey

   77



45270-2025   DC16

 beige / beige /
beige / beige

   72

Holland Plus

wandtegels / carreaux de faïence / Wandfliesen / wall tiles
 geglaazuurd / émaillé / glasiert / glazed
 niet vorstbestand / non ingélif / nicht frostsicher / not frost proof

bijpassende vloertegels / carreaux de sol correspondants /
 dazugehörige Bodenfliesen / matching floor tiles
 Core Collection Terra, nos. 204, 216, 225, 226, 264, 266 
 Softline, nos. 74000, 74020, 74030, 74060, 74070, 74090 
 Softgrip, nos. 74000, 74020, 74030, 74060, 74070, 74090 

no.	mm	inch	pieces/ m ²	pieces/ m ¹	pieces/ box	boxes/ pallet	pieces/ pallet	m ² / pallet	kg/ m ²	kg/ pallet
0490 - 0495	247x327x8,3	9.72x12.87x0.33	12,1	-	17 = 1,405 m ²	51	867	71,7	14,4	1.055

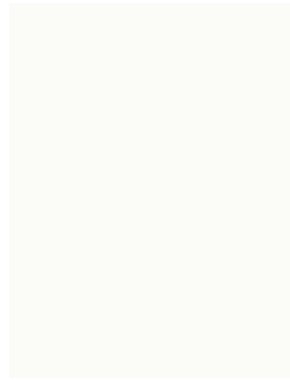
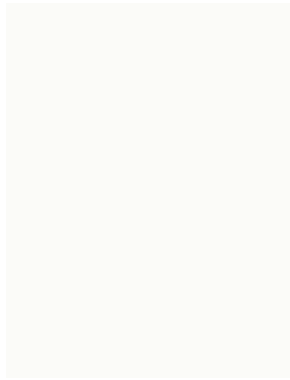

0490-2533   DC11

 wit / blanc /
weiß / white

 HI, HU, II, IU, UI, UU, RE, HE



   

  81

0495-2533   DC11

 wit / blanc /
weiß / white

 RE, HE

   

  78

3030 Murals Blend

wandtegels / carreaux de faïence / Wandfliesen / wall tiles
 geglaazuurd / émaillé / glasiert / glazed
 niet vorstbestand / non ingélif / nicht frostsicher / not frost proof

no.	mm	inch	pieces/ m ²	pieces/ m ¹	pieces/ box	boxes/ pallet	pieces/ pallet	m ² / pallet	kg/ m ²	kg/ pallet
30510 - 30010	297x297x7	11.69x11.69x0.28	11	-	10 = 0,909 m ²	68	680	61,8	11,7	749

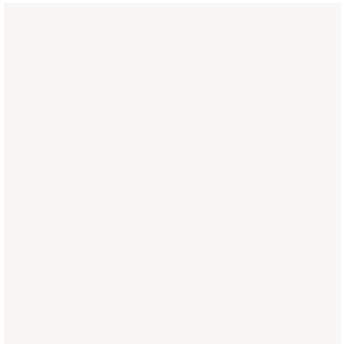



30510-3030  CC08

 bright white

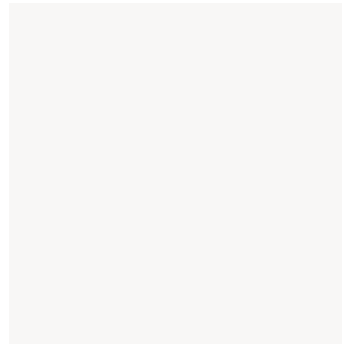

   S 0300-N GL



30010-3030  CC08

 bright white



   S 0300-N

3030 Murals Fuse

wandtegels / carreaux de faïence / Wandfliesen / wall tiles
 geglaazuurd / émaillé / glasiert / glazed
 niet vorstbestand / non ingélif / nicht frostsicher / not frost proof

no.	mm	inch	pieces/ m ²	pieces/ m ¹	pieces/ box	boxes/ pallet	pieces/ pallet	m ² / pallet	kg/ m ²	kg/ pallet
38010 - 38070	297x297x7	11.69x11.69x0.28	11	-	10 = 0,909 m ²	68	680	61,8	11,7	749



38010-3030 BC04
 M2 bright white

 80 S 0300-N

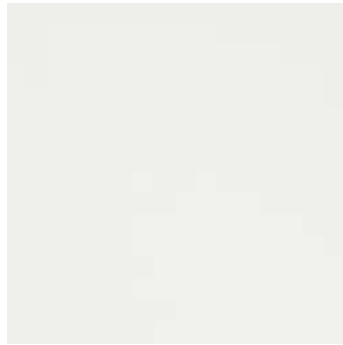

38510-3030 BC04
 bright white

 81 S 0300-N GL



38520-3030 BC04
 light cool grey #4

 66 S 1002-R50B GL

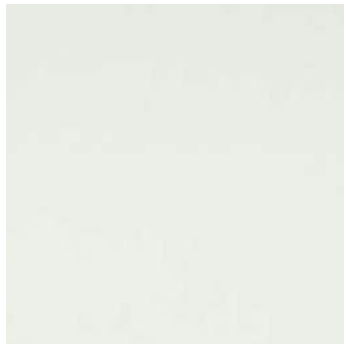

38530-3030 BC04
 ocean green #1

 67 S 1005-G20Y GL



38040-3030 BC04
 M2 sea blue #1

 22 S 5010-R70B

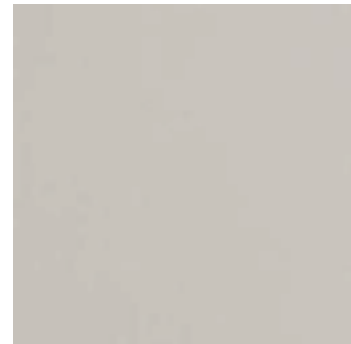

38050-3030 BC04
 M2 mid warm grey #1

 48 S 2005-Y50R



38070-3030 BC04
 M2 dark anthracite #3

 10 S 7500-N

Deze tegels hebben een patroon met een kleurverloop.
 Ces carreaux créent un motif particulier où les
 couleurs se succèdent.
 Diese Fliesen haben ein Muster mit einem Farbverlauf.
 These tiles have a pattern with a colour gradation.

3060 Murals Blend

wandtegels / carreaux de faïence / Wandfliesen / wall tiles
 geglazuurd / émaillé / glasiert / glazed
 niet vorstbestand / non ingélif / nicht frostsicher / not frost proof

no.	mm	inch	pieces/ m ²	pieces/ m ¹	pieces/ box	boxes/ pallet	pieces/ pallet	m ² / pallet	kg/ m ²	kg/ pallet
31510 - 31070	297x597x8,1	11.69x23.50x0.32	5,56	-	7 = 1,259 m ²	40	280	50,4	13,6	710

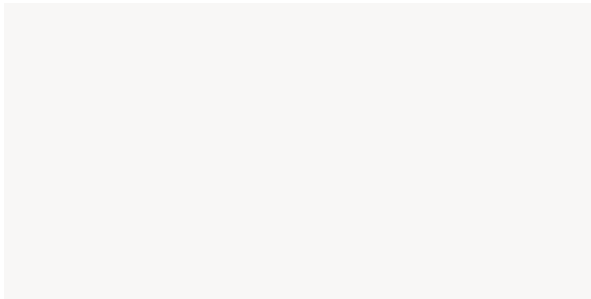

31510-3060-A € CC07

bright white
 85 S 0300-N GL

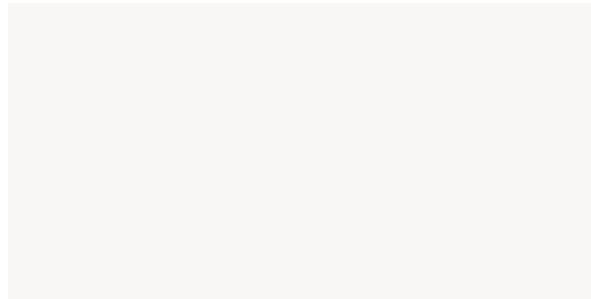

31010-3060-A € CC07

bright white
 83 S 0300-N

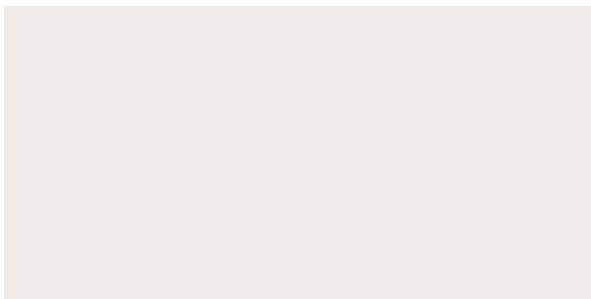

31540-3060-A € CC07

light cool grey #3
 73 S 1002-R50B GL

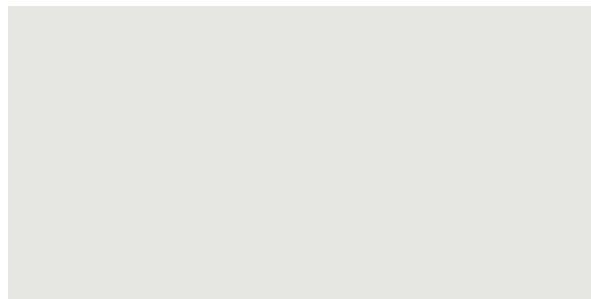

31050-3060-A € CC07

light cool grey #4
 67 S 1002-R50B



31560-3060-A € CC07

mid warm grey #1
 45 S 2005-Y50R GL



31070-3060-A € CC07

mid warm grey #2
 40 S 3005-Y50R

3060 Murals Blend

wandtegels / carreaux de faïence / Wandfliesen / wall tiles
 geglaazuurd / émaillé / glasiert / glazed
 niet vorstbestand / non ingélif / nicht frostsicher / not frost proof

no.	mm	inch	pieces/ m ²	pieces/ m ¹	pieces/ box	boxes/ pallet	pieces/ pallet	m ² / pallet	kg/ m ²	kg/ pallet
31620 - 31130	297x597x8,1	11.69x23.50x0.32	5,56	-	7 = 1,259 m ²	40	280	50,4	13,6	710

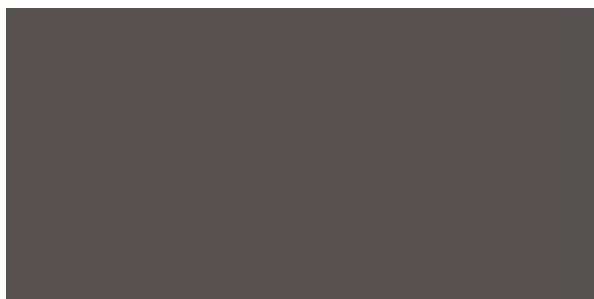

31620-3060-A € CC07



dark anthracite #3



12



S 7500-N GL



31130-3060-A € CC07



dark anthracite #4



9



S 8000-N

Strips / Frises / Bordüren / Listels

wandtegels / carreaux de faïence / Wandfliesen / wall tiles
 geglaazuurd / émaillé / glasiert / glazed
 niet vorstbestand / non ingélf / nicht frostsicher / not frost proof

no.	mm	inch	pieces/ m ²	pieces/ m ¹	pieces/ box	boxes/ pallet	pieces/ pallet	m ² / pallet	kg/ m ²	kg/ pallet
7851	147x25x6,8	5.79x0.98x0.27	-	6,67	20 = 3,00 m ¹	832	16.640	-	-	857
8314M	147x25x5,4	5.79x0.98x0.21	-	6,67	25 = 3,75 m ¹	546	13.650	-	-	530
8314	151x25x5,4	5.94x0.98x0.21	-	6,67	25 = 3,75 m ¹	832	20.800	-	-	774
8334	147x45x5,4	5.79x1.77x0.21	-	6,67	25 = 3,75 m ¹	448	11.200	-	-	731
8364	197x40x6,8	7.76x1.57x0.27	-	5,00	25 = 5,00 m ¹	252	6.300	-	-	598



7851-153  D 38

 zwart / noir /
schwarz / black





8314M153  D 16

 zwart / noir /
schwarz / black





8314-153  D 16

 zwart / noir /
schwarz / black





8334-155  D 21

 zwart / noir /
schwarz / black





8364-204  D 28

 zwart / noir /
schwarz / black





HI, HU, II, IU, UI, UU Holland 2040

wandtegels / carreaux de faïence / Wandfliesen / wall tiles
 geglaazuurd / émaillé / glasiert / glazed
 niet vorstbestand / non ingélf / nicht frostsicher / not frost proof

accessoires / accessoires / Formteile / accessories

no.	mm	inch	pieces/ m ²	pieces/ m ¹	pieces/ box	boxes/ pallet	pieces/ pallet	m ² / pallet	kg/ m ²	kg/ pallet
0490HI	147x25x5,8	5.79x0.98x0.23	-	6,67	25 = 3,75 m ¹	546	13.650	-	-	530
0490HU	147x25x5,8	5.79x0.98x0.23	-	6,67	25 = 3,75 m ¹	546	13.650	-	-	530
0490HI	197x25x5,8	7.76x0.98x0.23	-	5,00	25 = 5,00 m ¹	312	7.800	-	-	407
0490HU	197x25x5,8	7.76x0.98x0.23	-	5,00	25 = 5,00 m ¹	312	7.800	-	-	407
0490II - 0490IU	25x25x5,3	0.98x0.98x0.21	-	-	10	546	5.460	-	-	91
0490UI - 0490UU	45x25x5,3	1.77x0.98x0.21	-	-	10	546	5.460	-	-	134

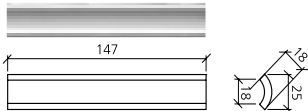

0490HI153 € D 48

☒ kwartrond, inwendig geglaazuurd /
 gorge, intérieur émaillé /
 Rinnleiste, innen glasiert /
 cove, internal glaze

C2C

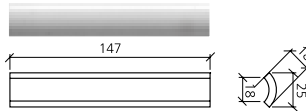

0490HU153 € D 48

☒ kwartrond, uitwendig geglaazuurd /
 baguette, extérieur émaillé /
 Eckleiste, außen glasiert /
 bead, external glaze

C2C

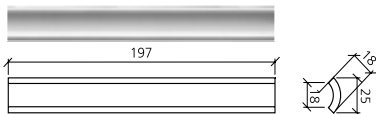

0490HI203 € D 48

☒ kwartrond, inwendig geglaazuurd /
 gorge, intérieur émaillé /
 Rinnleiste, innen glasiert /
 cove, internal glaze

C2C

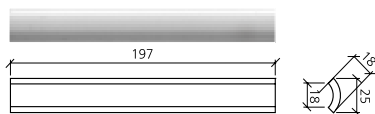

0490HU203 € D 48

☒ kwartrond, uitwendig geglaazuurd /
 baguette, extérieur émaillé /
 Eckleiste, außen glasiert /
 bead, external glaze

C2C

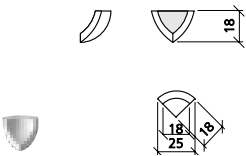

0490II33 € D 107

☒ inwendig hoekje voor HI, inwendig
 geglaazuurd / angle intérieur pour HI,
 intérieur émaillé / Innenecke für HI,
 innen glasiert / internal angle for HI,
 internal glaze (cove in)

C2C

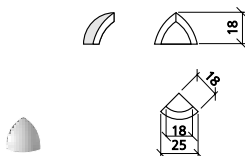

0490IU33 € D 107

☒ uitwendig hoekje voor HU, uitwendig
 geglaazuurd / angle extérieur pour HU,
 extérieur émaillé / Außenecke für HU,
 außen glasiert / external angle for HU,
 external glaze (bead out)

C2C

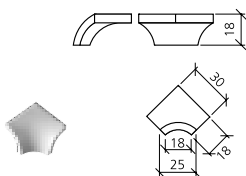

0490UI53 € D 107

☒ inwendig hoekje voor HI, inwendig
 geglaazuurd / angle intérieur pour HI,
 intérieur émaillé / Innenecke für HI,
 innen glasiert / internal angle for HI,
 internal glaze (bead in)

C2C

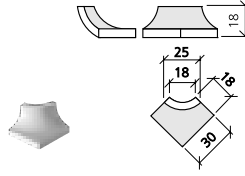

0490UU53 € D 107

☒ uitwendig hoekje voor HU, uitwendig
 geglaazuurd / angle extérieur pour HU,
 extérieur émaillé / Außenecke für HU,
 außen glasiert / external angle for HU,
 external glaze (cove out)

C2C





wandtegels / carreaux de faïence / Wandfliesen / wall tiles
 geglazuurd / émaillé / glasiert / glazed
 niet vorstbestand / non ingélif / nicht frostsicher / not frost proof

accessoires / accessoires / Formteile / accessories

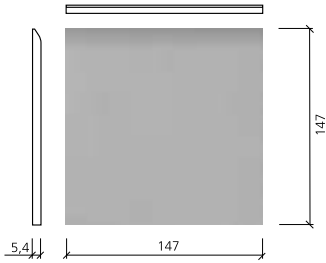
no.	mm	inch	pieces/ m ²	pieces/ m ¹	pieces/ box	boxes/ pallet	pieces/ pallet	m ² / pallet	kg/ m ²	kg/ pallet
0490RE - 0498RE	147x147x5,3	5.79x5.79x0.21	-	6,67	44 = 6,60 m ¹	100	4.400	-	-	909
04900RE	151x151x5,3	5.94x5.94x0.21	-	6,67	44 = 6,60 m ¹	100	4.400	-	-	909
0490HE - 0498HE	147x147x5,3	5.79x5.79x0.21	-	-	44	100	4.400	-	-	870



...RE1515  D 0

 afdek / bord arrondi /
Abdeck / round edge (bullnose)

0490, 0497

 afdek / bord arrondi /
Abdeck / round edge (bullnose)

0495, 0498



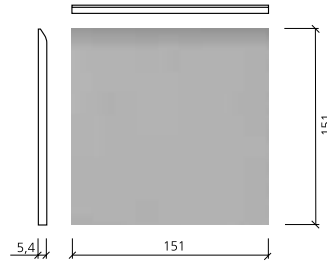



04900RE1515  D 0

 afdek / bord arrondi /
Abdeck / round edge (bullnose)

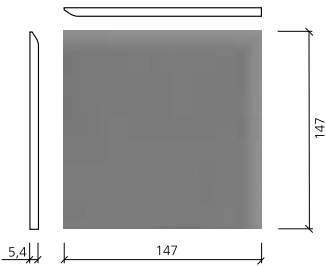



...HE1515  D 0

 hoekafdek / 2 bords arrondis /
Eckenabdeck / 2 rounded edges
(double bullnose)

0490, 0497

 hoekafdek / 2 bords arrondis /
Eckenabdeck / 2 rounded edges
(double bullnose)

0495, 0498



Mosa.

Floor tiles

10 Global Collection

vloertegels / carreaux de sol / Bodenfliesen / floor tiles
 Ultragres ongeglazuurd / non émaillé / unglasiert / unglazed
 vorstbestand / ingélif / frostsicher / frost proof

bijpassende wandtegels / carreaux de faïence correspondants /
 dazugehörige Wandfliesen / matching wall tiles
 Global Collection 10 11 12

no.	mm	inch	pieces/ m ²	pieces/ m ¹	pieces/ box	boxes/ pallet	pieces/ pallet	m ² / pallet	kg/ m ²	kg/ pallet
75070V - 75230V	96x96x8	3.78x3.78x0.31	100	-	66 = 0,66 m ²	90	5.940	59,4	17,6	1.070



75070V1010 € CP28

M zandgeel uni / jaune de sable uni /
 sandgelb Uni / plain sand yellow

P, I, U, DP, DI, DU, SP



R10 A

c2c 51 MCS S 2020-Y20R



75200V1010 € CP28

M ivoorzwart uni / noir d'ivoire uni /
 elfenbeinschwarz Uni / plain ivory black

P, I, U, DP, DI, DU, SP, 75201GL, 75201GS



R10 A

c2c 7 MCS S 8000-N



75210V1010 € CP28

M ecruwit uni / blanc écri uni /
 weiß ungebleicht Uni /
 plain white unbleached

P, I, U, DP, DI, DU, SP, 75211GL, 75211GS



R10 A

c2c 59 MCS S 1005-Y10R



75220V1010 € CP28

M grijs uni / gris uni /
 grau Uni / plain grey

P, I, U, DP, DI, DU, SP



R10 A

c2c 38 MCS S 3000-N



75230V1010 € CP28

M muisgrijs uni / gris de souris uni /
 mausgrau Uni / plain mouse grey

P, I, U, DP, DI, DU, SP



R10 A

c2c 23 MCS S 5500-N

Voor tegelpatronen zie www.mosa.com/nl-nl/grids.

Pour des motifs de carreaux, nous vous invitons à consulter www.mosa.com/fr-fr/trames.

Für Verlegemuster siehe www.mosa.com/de-de/raster.

For tile patterns, see www.mosa.com/en-us/grids or www.mosa.com/en-us/grids.

15 Core Collection Terra

vloertegels / carreaux de sol / Bodenfliesen / floor tiles
 Ultragres ongeglazuurd / non émaillé / unglasiert / unglazed
 vorstbestand / ingélf / frostsicher / frost proof

no.	mm	inch	pieces/ m ²	pieces/ m ¹	pieces/ box	boxes/ pallet	pieces/ pallet	m ² / pallet	kg/ m ²	kg/ pallet
203VV - 266VV	146x146x7,5	5.75x5.75x0.30	44	-	33 = 0,75 m ²	92	3.036	69,0	16,5	1.164



203VV1515 BP21

M cool black
 BP, 103VM, 103HM, TVG, HV

 RM
 R10 8



204VV1515 BP21

M mid warm grey
 304SP, BP, 104VM, 104HM, TVG, HV

 RM
 R10 22



206VV1515 BP21

M mid grey
 306SP, BP, TVG, HV

 RM
 R10 34



216VV1515 BP21

M anthracite
 316SP, BP, 116VM, 116HM, TVG, HV

 RM
 R10 12



225VV1515 BP21

M light cool grey
 BP, 125VM, 125HM

 RM
 R10 40



226VV1515 BP21

M mid cool grey
 BP, 126VM, 126HM, TVG, HV

 RM
 R10 23



264VV1515 BP21

M grey brown
 BP, 164VM, 164HM

 RM
 R10 15



266VV1515 BP21

M light beige
 BP, 166VM, 166HM

 RM
 R10 49

Voor de bijbehorende reliëftegelcollectie Core Collection Terra in dit formaat zie pagina 199.
 Pour la collection en relief correspondante Core Collection Terra dans ce format voir page 199.
 Für die dazugehörige Relieffkollektion Core Collection Terra in diesen Format siehe Seite 199.
 For the matching Core Collection Terra relief tiles in this size see page 199.

1515 Global Collection

vloertegels / carreaux de sol / Bodenfliesen / floor tiles
 Ultragres ongeglazuurd / non émaillé / unglasiert / unglazed
 vorstbestand / ingélif / frostsicher / frost proof

bijpassende wandtegels / carreaux de faïence correspondants /
 dazugehörige Wandfliesen / matching wall tiles
 Global Collection 30 13 13

no.	mm	inch	pieces/ m ²	pieces/ m ¹	pieces/ box	boxes/ pallet	pieces/ pallet	m ² / pallet	kg/ m ²	kg/ pallet
75020V - 75130V	146x146x7	5.75x5.75x0.28	44	-	33 = 0,75 m ²	92	3.036	69,0	15,3	1.082



75020V1515 CP27

M parelwit uni / blanc de perle uni /
 perlweiß Uni / plain pearl white

DP, DI, DU, SP



R10 A

57 S 2005-Y20R



75030V1515 CP27

M grijsbeige uni / gris-beige uni /
 graubeige Uni / plain grey beige

DP, DI, DU, SP



R10 A

41 S 3005-Y20R



75040V1515 CP27

M aardebruin uni / brune terre uni /
 erdbraun Uni / plain earth brown

DP, DI, DU, SP



R10 A

28 S 3010-Y40R

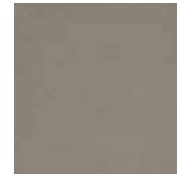

75050V1515 CP27

M agaatgrijs uni / gris d'agate uni /
 achatgrau Uni / plain agate grey

DP, DI, DU, SP



R10 A

20 S 5005-Y50R



75060V1515 CP27

M napelsgeel uni / jaune de Naples uni /
 Neapelgelb Uni / plain Naples yellow

DP, DI, DU, SP



R10 A

39 S 2030-Y20R



75070V1515 CP27

M zandgeel uni / jaune de sable uni /
 sandgelb Uni / plain sand yellow

P, I, U, DP, DI, DU, SP



R10 A

51 S 2020-Y20R



75080V1515 CP27

M olijfgroen uni / vert olive uni /
 olivgrün Uni / plain olive green

DP, DI, DU, SP



R10 A

29 S 3020-G20Y



75090V1515 CP27

M pastelgroen uni / vert pastel uni /
 pastellgrün Uni / plain pastel green

DP, DI, DU, SP



R10 A

41 S 3010-G50Y



75100V1515 CP27

M turkoois uni / turquoise uni /
 türkis Uni / plain turquoise

DP, DI, DU, SP



R10 A

16 S 6020-B30G



75110V1515 CP27

M mintgroen uni / vert de menthe uni /
 minzegrün Uni / plain mint green

DP, DI, DU, SP



R10 A

40 S 3010-G



75120V1515 CP27

M pruisischblau uni / bleu de Prusse uni /
 Preußischblau Uni / plain Prussian blue

DP, DI, DU, SP



R10 A

11 S 6020-R90B



75130V1515 CP27

M sèvresblau uni / bleu de Sèvres uni /
 Sèvresblau Uni / plain Sèvres blue

DP, DI, DU, SP



R10 A

36 S 2020-R90B

15 Global Collection

vloertegels / carreaux de sol / Bodenfliesen / floor tiles
 Ultragres ongeglazuurd / non émaillé / unglasiert / unglazed
 vorstbestand / ingélf / frostsicher / frost proof

bijpassende wandtegels / carreaux de faïence correspondants /
 dazugehörige Wandfliesen / matching wall tiles
 Global Collection 30 15 30

no.	mm	inch	pieces/ m ²	pieces/ m ¹	pieces/ box	boxes/ pallet	pieces/ pallet	m ² / pallet	kg/ m ²	kg/ pallet
75140V - 76250V	146x146x7	5.75x5.75x0.28	44	-	33 = 0,75 m ²	92	3.036	69,0	15,3	1.082



75140V1515 CP27

M koningsblauw uni / bleu royal uni /
 königsblau Uni / plain king's blue

DP, DI, DU, SP



R10 A

S 5010-R70B



75150V1515 CP27

M duivenblauw uni / bleu pigeon uni /
 taubenblau Uni / plain dove blue

DP, DI, DU, SP



R10 A

S 4005-R80B



75160V1515 CP27

M indischbruin uni / brun Indien uni /
 Indischbraun Uni / plain Indian brown

DP, DI, DU, SP



R10 A

S 7010-Y70R



75170V1515 CP27

M koperbruin uni / brun cuivre uni /
 kupferbraun Uni / plain copper brown

DP, DI, DU, SP



R10 A

S 4030-Y50R



75180V1515 CP27

M engelsrood uni / rouge anglais uni /
 Englischrot Uni / plain light oxide red

DP, DI, DU, SP



R10 A

S 4020-Y70R



75200V1515 CP27

M ivoorzwart uni / noir d'ivoire uni /
 elfenbeinschwarz Uni / plain ivory black

P, I, U, DP, DI, DU, SP, 75201GL, 75201GS



R10 A

S 8000-N



75210V1515 CP27

M ecruwit uni / blanc écru uni /
 weiß ungebleicht Uni / plain white unbleached

P, I, U, DP, DI, DU, SP, 75211GL, 75211GS



R10 A

S 1005-Y10R



75220V1515 CP27

M grijs uni / gris uni /
 grau Uni / plain grey

P, I, U, DP, DI, DU, SP



R10 A

S 3000-N

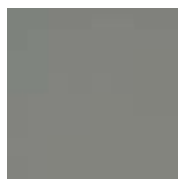

75230V1515 CP27

M muisgrijs uni / gris de souris uni /
 mausgrau Uni / plain mouse grey

P, I, U, DP, DI, DU, SP



R10 A

S 5500-N

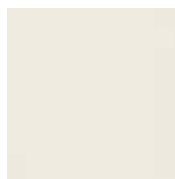

76010V1515 CP27

M porseleinwit uni / blanc porcelaine uni /
 porzellanweiß Uni / plain porcelain white

DP, DI, DU, SP



R10 A

S 0500-N

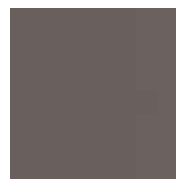

76240V1515 CP27

M warm grijs uni / gris chaleureux uni /
 warm grau Uni / plain warm grey

DP, DI, DU, SP



R10 A

S 7005-Y20R



76250V1515 CP27

M antraciet uni / anthracite uni /
 anthrazit Uni / plain anthracite

DP, DI, DU, SP



R10 A

S 6500-N

15 Global Collection

vloertegels / carreaux de sol / Bodenfliesen / floor tiles
 Ultragres ongeglazuurd / non émaillé / unglasiert / unglazed
 vorstbestand / îngelif / frostsicher / frost proof

bijpassende wandtegels / carreaux de faïence correspondants /
 dazugehörige Wandfliesen / matching wall tiles
 Global Collection 30 43 33

no.	mm	inch	pieces/ m ²	pieces/ m ¹	pieces/ box	boxes/ pallet	pieces/ pallet	m ² / pallet	kg/ m ²	kg/ pallet
76260V - 75520V	146x146x7	5.75x5.75x0.28	44	-	33 = 0,75 m ²	92	3.036	69,0	15,3	1.082



76260V1515 **CP27**
M siennarood uni / rouge de Sienna uni /
 Siennarot Uni / plain Sienna red
 DP, DI, DU, SP
 50
 R10 A
 C2C 12 S 5030-Y70R



75420V1515 **CP26**
M parelwit jn gespikkeld / blanc de perle
 petits grains / perlweiß Feinkorn /
 small speckled pearl white
 DP, DI, DU, SP, 75720BN
 50
 R10 A
 C2C 48 S 2005-Y20R

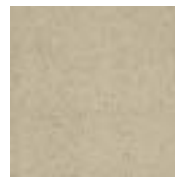

75430V1515 **CP26**
M grijsbeige jn gespikkeld / gris-beige
 petits grains / graubeige Feinkorn /
 small speckled grey beige
 DP, DI, DU, SP, 75730BN
 50
 AS
 R10 A
 C2C 42 S 3005-Y20R

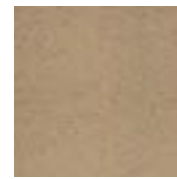

75440V1515 **CP26**
M aardebruin jn gespikkeld / brune terre
 petits grains / erdbraun Feinkorn /
 small speckled earth brown
 DP, DI, DU, SP, 75740BN
 50
 AS
 R10 A
 C2C 25 S 3010-Y40R

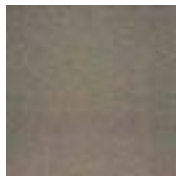

75450V1515 **CP26**
M agaatgrijs jn gespikkeld / gris d'agate
 petits grains / achatgrau Feinkorn /
 small speckled agate grey
 DP, DI, DU, SP, 75750BN, TR
 50
 R10 A
 C2C 22 S 5005-Y50R



75460V1515 **CP26**
M napelsgeel jn gespikkeld / jaune de
 Naples petits grains / Neapelgelb
 Feinkorn / small speckled Naples yellow
 DP, DI, DU, SP, 75760BN
 50 AS
 R10 A
 C2C 38 S 2030-Y20R



75470V1515 **CP26**
M zandgeel jn gespikkeld / jaune de sable
 petits grains / sandgelb Feinkorn /
 small speckled sand yellow
 DP, DI, DU, SP, 75770BN
 50 AS
 R10 A
 C2C 44 S 2020-Y20R



75480V1515 **CP26**
M olijfgroen jn gespikkeld / vert olive
 petits grains / olivgrün Feinkorn /
 small speckled olive green
 DP, DI, DU, SP, 75780BN
 50
 R10 A
 C2C 30 S 3020-G20Y



75490V1515 **CP26**
M pastelgroen jn gespikkeld / vert pastel
 petits grains / pastellgrün Feinkorn /
 small speckled pastel green
 DP, DI, DU, SP, 75790BN
 50
 R10 A
 C2C 39 S 3010-G50Y

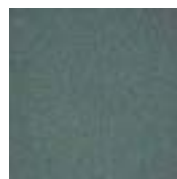

75500V1515 **CP26**
M turkoois jn gespikkeld /
 turquoise petits grains / türkis Feinkorn /
 small speckled turquoise
 DP, DI, DU, SP, 75800BN
 50 AS
 R10 A
 C2C 17 S 6020-B30G

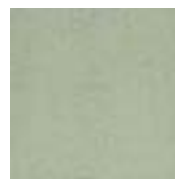

75510V1515 **CP26**
M mintgroen jn gespikkeld / vert de
 menthe petits grains / minzegrün
 Feinkorn / small speckled mint green
 DP, DI, DU, SP, 75810BN
 50 AS
 R10 A
 C2C 38 S 3010-G

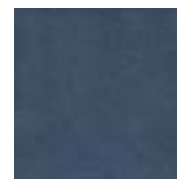

75520V1515 **CP26**
M pruisischblauw jn gespikkeld / bleu de
 Prusse petits grains / Preußischblau
 Feinkorn / small speckled Prussian blue
 DP, DI, DU, SP, 75820BN
 50 AS
 R10 A
 C2C 13 S 6020-R90B

15 Global Collection

vloertegels / carreaux de sol / Bodenfliesen / floor tiles
 Ultragres ongeglazuurd / non émaillé / unglasiert / unglazed
 vorstbestand / ingélif / frostsicher / frost proof

bijpassende wandtegels / carreaux de faïence correspondants /
 dazugehörige Wandfliesen / matching wall tiles
 Global Collection 30 15 30



no.	mm	inch	pieces/ m ²	pieces/ m ¹	pieces/ box	boxes/ pallet	pieces/ pallet	m ² / pallet	kg/ m ²	kg/ pallet
75530V - 76640V	146x146x7	5.75x5.75x0.28	44	-	33 = 0,75 m ²	92	3.036	69,0	15,3	1.082



75530V1515 **CP26**
M sévresblauw in gespikkeld / bleu de Sèvres petits grains / Sèvresblau Feinkorn / small speckled Sèvres blue
 DP, DI, DU, SP, 75830BN
 AS
 R10 A
 C2C S 2020-R90B

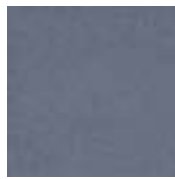

75540V1515 **CP26**
M koningsblauw in gespikkeld / bleu royal petits grains / königsblau Feinkorn / small speckled king's blue
 DP, DI, DU, SP, 75840BN
 AS
 R10 A
 C2C S 5010-R70B



75550V1515 **CP26**
M duivenblauw in gespikkeld / bleu pigeon petits grains / taubenblau Feinkorn / small speckled dove blue
 DP, DI, DU, SP, 75850BN
 AS
 R10 A
 C2C S 4005-R80B

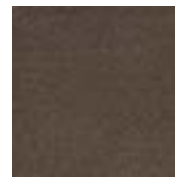

75560V1515 **CP26**
M indischbruin in gespikkeld / brun indien petits grains / Indischbruin Feinkorn / small speckled Indian brown
 DP, DI, DU, SP, 75860BN
 AS
 R10 A
 C2C S 7010-Y70R



75570V1515 **CP26**
M koperbruin in gespikkeld / brun cuivre petits grains / kupferbraun Feinkorn / small speckled copper brown
 DP, DI, DU, SP, 75870BN
 AS
 R10 A
 C2C S 4030-Y50R



75580V1515 **CP26**
M engelsrood in gespikkeld / rouge anglais petits grains / Englischrot Feinkorn / small speckled light oxide red
 DP, DI, DU, SP, 75880BN
 AS
 R10 A
 C2C S 4020-Y70R

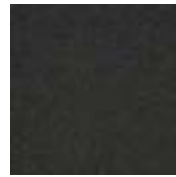

75600V1515 **CP26**
M ivoorzwart in gespikkeld / noir d'ivoire petits grains / elfenbeinschwarz Feinkorn / small speckled ivory black
 DP, DI, DU, SP, 75900BN, TR
 AS, TS, WS
 R10 A
 C2C S 8000-N



75610V1515 **CP26**
M ecruwit in gespikkeld / blanc écru petits grains / weiß ungebleicht Feinkorn / small speckled white unbleached
 DP, DI, DU, SP, 75910BN, TR
 AS
 R10 A
 C2C S 1005-Y10R



75620V1515 **CP26**
M grijs in gespikkeld / gris petits grains / grau Feinkorn / small speckled grey
 DP, DI, DU, SP, 75920BN, TR
 AS, TS, WS
 R10 A
 C2C S 3000-N



75630V1515 **CP26**
M muisgrijs in gespikkeld / gris de souris petits grains / mausgrau Feinkorn / small speckled mouse grey
 DP, DI, DU, SP, 75930BN, TR
 AS
 R10 A
 C2C S 5500-N

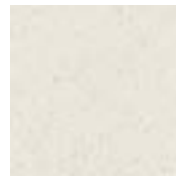

76410V1515 **CP26**
M porseleinwit in gespikkeld / blanc porcelaine petits grains / porzellanweiß Feinkorn / small speckled porcelain white
 DP, DI, DU, SP, 76710BN
 AS
 R10 A
 C2C S 0500-N



76640V1515 **CP26**
M warm grijs in gespikkeld / gris chaleureux petits grains / warm grau Feinkorn / small speckled warm grey
 DP, DI, DU, SP, 76940BN
 AS
 R10 A
 C2C S 7005-Y20R

Global Collection

vloertegels / carreaux de sol / Bodenfliesen / floor tiles
 Ultragres ongeglazuurd / non émaillé / unglasiert / unglazed
 vorstbestand / ingélif / frostsicher / frost proof

bijpassende wandtegels / carreaux de faïence correspondants /
 dazugehörige Wandfliesen / matching wall tiles
 Global Collection 

no.	mm	inch	pieces/ m ²	pieces/ m ¹	pieces/ box	boxes/ pallet	pieces/ pallet	m ² / pallet	kg/ m ²	kg/ pallet
76650V - 76660V	146x146x7	5.75x5.75x0.28	44	-	33 = 0,75 m ²	92	3.036	69,0	15,3	1.082



76650V1515 CP26

 antraciet in gespikkeld / anthracite
 petits grains / anthrazit Feinkorn /
 small speckled anthracite

 DP, DI, DU, SP, 76950BN



 R10  A

   S 6500-N

76660V1515 CP26

 siennarood in gespikkeld / rouge de
 Sienna petits grains / Siennarot
 Feinkorn / small speckled Sienna red

 DP, DI, DU, SP, 76960BN



 R10  A

   S 5030-Y70R

Voor de bijbehorende reliëftegelfcollectie Globalgrip in dit formaat zie pagina's 204 en 205.
 Pour la collection en relief correspondante Globalgrip dans ce format voir pages 204 et 205.
 Für die dazugehörige Relieffkollection Globalgrip in diesen Format siehe Seiten 204 und 205.
 For the matching Globalgrip relief tiles in this size see pages 204 and 205.

Voor tegelpatronen zie www.mosa.com/nl-nl/grids.
 Pour des motifs de carreaux, nous vous invitons à consulter www.mosa.com/fr-fr/trames.
 Für Verlegemuster siehe www.mosa.com/de-de/raster.
 For tile patterns, see www.mosa.com/en-us/grids or www.mosa.com/en-us/grids.

15 Scenes

vloertegels / carreaux de sol / Bodenfliesen / floor tiles
 Ultragres ongeglazuurd / non émaillé / unglasiert / unglazed
 vorstbestand / ingélif / frostsicher / frost proof

no.	mm	inch	pieces/ m ²	pieces/ m ¹	pieces/ box	boxes/ pallet	pieces/ pallet	m ² / pallet	kg/ m ²	kg/ pallet
6110V - 6142V	146x146x7,5	5.75x5.75x0.30	44	-	33 = 0,75 m ²	92	3.036	69,0	16,5	1.164



6110V1515 € BP22

M white grey grain
 6114 (DP, DI, DU, SP)
 MR
 R10 A C2C 59



6111V1515 € BP22

M white grey clay
 6114 (DP, DI, DU, SP)
 R10 A C2C 51

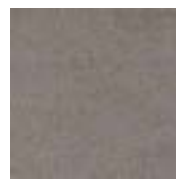

6112V1515 € BP22

M white grey sand
 6114 (DP, DI, DU, SP)
 R10 A C2C 44



6120V1515 € BP22

M cool grey grain
 6124 (DP, DI, DU, SP)
 MR
 R10 A C2C 40



6121V1515 € BP22

M cool grey clay
 6124 (DP, DI, DU, SP)
 R10 A C2C 37



6122V1515 € BP22

M cool grey sand
 6124 (DP, DI, DU, SP)
 R10 A C2C 28



6130V1515 € BP22

M green grey grain
 6134 (DP, DI, DU, SP)
 MR
 R10 A C2C 22



6131V1515 € BP22

M green grey clay
 6134 (DP, DI, DU, SP)
 R10 A C2C 21

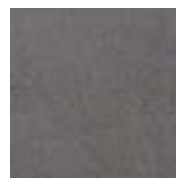

6132V1515 € BP22

M green grey sand
 6134 (DP, DI, DU, SP)
 R10 A C2C 16

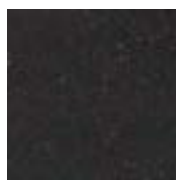

6140V1515 € BP22

M dark anthracite grain
 6144 (DP, DI, DU, SP)
 MR
 R10 A C2C 11

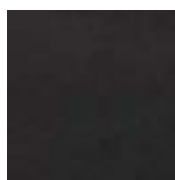

6141V1515 € BP22

M dark anthracite clay
 6144 (DP, DI, DU, SP)
 R10 A C2C 10



6142V1515 € BP22

M dark anthracite sand
 6144 (DP, DI, DU, SP)
 R10 A C2C 9

15 Scenes

vloertegels / carreaux de sol / Bodenfliesen / floor tiles
 Ultragres ongeglazuurd / non émaillé / unglasiert / unglazed
 vorstbestand / ingélif / frostsicher / frost proof

no.	mm	inch	pieces/ m ²	pieces/ m ¹	pieces/ box	boxes/ pallet	pieces/ pallet	m ² / pallet	kg/ m ²	kg/ pallet
6150V - 6172V	146x146x7,5	5.75x5.75x0.30	44	-	33 = 0,75 m ²	92	3.036	69,0	16,5	1.164



6150V1515 € BP22

M mid beige grain
 6154 (DP, DI, DU, SP)
 MR
 R10 A C2C 44

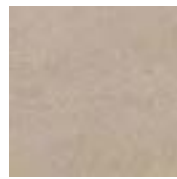

6151V1515 € BP22

M mid beige clay
 6154 (DP, DI, DU, SP)
 R10 A C2C 35



6152V1515 € BP22

M mid beige sand
 6154 (DP, DI, DU, SP)
 R10 A C2C 33



6160V1515 € BP22

M warm ochre grain
 6164 (DP, DI, DU, SP)
 MR
 R10 A C2C 31

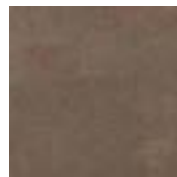

6161V1515 € BP22

M warm ochre clay
 6164 (DP, DI, DU, SP)
 R10 A C2C 29

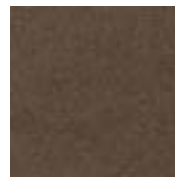

6162V1515 € BP22

M warm ochre sand
 6164 (DP, DI, DU, SP)
 R10 A C2C 23

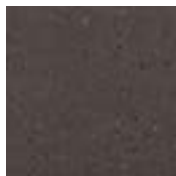

6170V1515 € BP22

M warm grey grain
 6174 (DP, DI, DU, SP)
 MR
 R10 A C2C 18

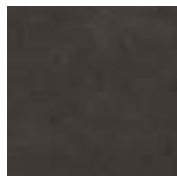

6171V1515 € BP22

M warm grey clay
 6174 (DP, DI, DU, SP)
 R10 A C2C 15

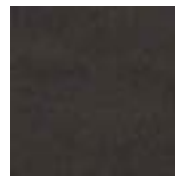

6172V1515 € BP22

M warm grey sand
 6174 (DP, DI, DU, SP)
 R10 A C2C 14

Voor de bijbehorende reliëftegelcollectie Scenes in dit formaat zie pagina 207.
 Pour la collection en relief correspondante Scenes dans ce format voir page 207.
 Für die dazugehörige Reliefkollektion Scenes in diesen Format siehe Seite 207.
 For the matching Scenes relief tiles in this size see page 207.

vloertegels / carreaux de sol / Bodenfliesen / floor tiles
 Ultragres ongeglazuurd / non émaillé / unglasiert / unglazed
 vorstbestand / ingélf / frostsicher / frost proof

no.	mm	inch	pieces/ m ²	pieces/ m ¹	pieces/ box	boxes/ pallet	pieces/ pallet	m ² / pallet	kg/ m ²	kg/ pallet
74000V - 74110V	146x146x7	5.75x5.75x0.28	44	-	33 = 0,75 m ²	92	3.036	69,0	15,3	1.082



74000V1515 CP23

M porseleinwit / blanc porcelaine /
porzellanweiß / porcelain white

DP, DI, DU, VS, HS

LS1515, LS3030

70



74020V1515 CP23

M grijs / gris /
grau / grey

DP, DI, DU, VS, HS

LS1515, LS3030

38



74030V1515 CP23

M muisgrijs / gris de souris /
mausgrau / mouse grey

DP, DI, DU, VS, HS

LS1515, LS3030

24



74040V1515 CP23

M licht warm grijs / gris chaleureux clair /
hell warm grau / light warm grey

DP, DI, DU, VS, HS

LS1515, LS3030

32



74050V1515 CP23

M midden warm grijs /
gris chaleureux moyen /
mittel warm grau / mid warm grey

DP, DI, DU, VS, HS

LS1515, LS3030

22

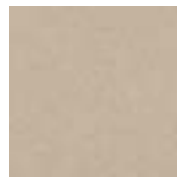

74060V1515 CP23

M beige / beige /
beige / beige

DP, DI, DU, VS, HS

LS1515, LS3030

42



74070V1515 CP23

M grijsbruin / gris-brun /
graubraun / grey brown

DP, DI, DU, VS, HS

LS1515, LS3030

12



74090V1515 CP23

M ivoorzwart / noir d'ivoire /
elfenbeinschwarz / ivory black

DP, DI, DU, VS, HS

LS1515, LS3030

9



74110V1515 CP23

M lichtbeige / beige clair /
hellbeige / light beige

DP, DI, DU, VS, HS

LS1515

58





Voor de bijbehorende reliëftegelfcollectie Softgrip in dit formaat zie pagina 208.
 Pour la collection en relief correspondante Softgrip dans ce format voir page 208.
 Für die dazugehörige Relieffkollection Softgrip in diesen Format siehe Seite 208.
 For the matching Softgrip relief tiles in this size see page 208.

Core Collection Terra

vloertegels / carreaux de sol / Bodenfliesen / floor tiles
 Ultragres ongeglazuurd / non émaillé / unglasiert / unglazed
 vorstbestand / ingélf / frostsicher / frost proof

no.	mm	inch	pieces/ m ²	pieces/ m ¹	pieces/ box	boxes/ pallet	pieces/ pallet	m ² / pallet	kg/ m ²	kg/ pallet
203V - 229V	296x296x10	11.65x11.65x0.39	11	-	10 = 0,909 m ²	48	480	43,6	23,3	1.043



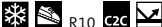



203V3030   **BP19**
M cool black
 BP, 103VM, 103HM, TVG, HV

 RL
 8





204V3030   **BP19**
M mid warm grey
 304SP, BP, 104VM, 104HM, TVG, HV

 RL
 22



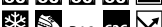

206V3030  **BP19**
M mid grey
 306SP, BP, TVG, HV

 RL
 34





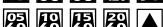
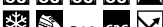

211V3030  **BP19**
M avalon beige
 BP, TVG, HV

 RL
 51



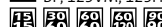
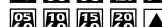

216V3030   **BP19**
M anthracite
 316SP, BP, 116VM, 116HM, TVG, HV

 RL
 12



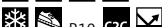

225V3030   **BP19**
M light cool grey
 BP, 125VM, 125HM

 RL
 40



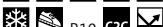

226V3030   **BP19**
M mid cool grey
 BP, 126VM, 126HM, TVG, HV

 RL
 23



227V3030  **BP19**
M dark cool grey
 BP, TVG, HV

 RL
 14



229V3030  **BP19**
M dark warm grey
 BP, TVG, HV

 RL
 14













Core Collection Terra

vloertegels / carreaux de sol / Bodenfliesen / floor tiles
 Ultragres ongeglazuurd / non émaillé / unglasiert / unglazed
 vorstbestand / ingélif / frostsicher / frost proof

no.	mm	inch	pieces/ m ²	pieces/ m ¹	pieces/ box	boxes/ pallet	pieces/ pallet	m ² / pallet	kg/ m ²	kg/ pallet
264V - 266V	296x296x10	11.65x11.65x0.39	11	-	10 = 0,909 m ²	48	480	43,6	23,3	1.043















264V3030   BP19

 grey brown
 BP, 164VM, 164HM
  
    
   15



266V3030   BP19

 light beige
 BP, 166VM, 166HM
  
     RL
   49

Voor de bijbehorende reliëftegelcollectie Core Collection Terra in dit formaat zie pagina 200.
 Pour la collection en relief correspondante Core Collection Terra dans ce format voir page 200.
 Für die dazugehörige Reliefkollektion Core Collection Terra in diesem Format siehe Seite 200.
 For the matching Core Collection Terra relief tiles in this size see page 200.

3030 Global Collection

vloertegels / carreaux de sol / Bodenfliesen / floor tiles
 Ultragres ongeglazuurd / non émaillé / unglasiert / unglazed
 vorstbestand / ingélif / frostsicher / frost proof

bijpassende wandtegels / carreaux de faïence correspondants /
 dazugehörige Wandfliesen / matching wall tiles
 Global Collection 30 15 30

no.	mm	inch	pieces/ m ²	pieces/ m ¹	pieces/ box	boxes/ pallet	pieces/ pallet	m ² / pallet	kg/ m ²	kg/ pallet
75020V - 75100V	296x296x8	11.65x11.65x0.31	11	-	13 = 1,182 m ²	48	624	56,7	18,3	1.063



75020V3030 **CP27**
 M parelwit uni / blanc de perle uni /
 perlweiß Uni / plain pearl white
 DP, DI, DU, SP
 S 2005-Y20R



75030V3030 **CP27**
 M grijsbeige uni / gris-beige uni /
 graubeige Uni / plain grey beige
 DP, DI, DU, SP
 S 3005-Y20R



75040V3030 **CP27**
 M aardebruin uni / brune terre uni /
 erdbraun Uni / plain earth brown
 DP, DI, DU, SP
 S 3010-Y40R



75050V3030 **CP27**
 M agaatgrijs uni / gris d'agate uni /
 achatgrau Uni / plain agate grey
 DP, DI, DU, SP
 S 5005-Y50R



75060V3030 **CP27**
 M napelsgeel uni / jaune de Naples uni /
 Neapelgelb Uni / plain Naples yellow
 DP, DI, DU, SP
 S 2030-Y20R



75070V3030 **CP27**
 M zandgeel uni / jaune de sable uni /
 sandgelb Uni / plain sand yellow
 P, I, U, DP, DI, DU, SP
 S 2020-Y20R



75080V3030 **CP27**
 M olijfgroen uni / vert olive uni /
 olivgrün Uni / plain olive green
 DP, DI, DU, SP
 S 3020-G20Y



75090V3030 **CP27**
 M pastelgroen uni / vert pastel uni /
 pastellgrün Uni / plain pastel green
 DP, DI, DU, SP
 S 3010-G50Y



75100V3030 **CP27**
 M turkoois uni / turquoise uni /
 türkis Uni / plain turquoise
 DP, DI, DU, SP
 S 6020-B30G

3030 Global Collection

vloertegels / carreaux de sol / Bodenfliesen / floor tiles
 Ultragres ongeglazuurd / non émaillé / unglasiert / unglazed
 vorstbestand / ingélif / frostsicher / frost proof

bijpassende wandtegels / carreaux de faïence correspondants /
 dazugehörige Wandfliesen / matching wall tiles
 Global Collection 30 30 30

no.	mm	inch	pieces/ m ²	pieces/ m ¹	pieces/ box	boxes/ pallet	pieces/ pallet	m ² / pallet	kg/ m ²	kg/ pallet
75110V - 75200V	296x296x8	11.65x11.65x0.31	11	-	13 = 1,182 m ²	48	624	56,7	18,3	1.063



75110V3030 **CP27**
M mintgroen uni / vert de menthe uni /
 minzgrün Uni / plain mint green
 DP, DI, DU, SP
 S 3010-G

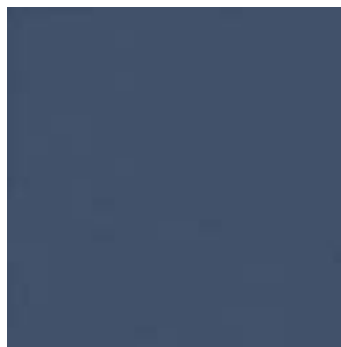

75120V3030 **CP27**
M pruisischblauw uni / bleu de Prusse uni /
 Preußischblau Uni / plain Prussian blue
 DP, DI, DU, SP
 S 6020-R90B

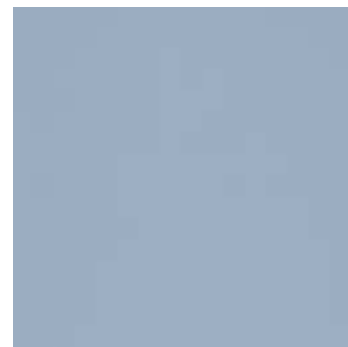

75130V3030 **CP27**
M sèvresblauw uni / bleu de Sèvres uni /
 Sèvresblau Uni / plain Sèvres blue
 DP, DI, DU, SP
 S 2020-R90B

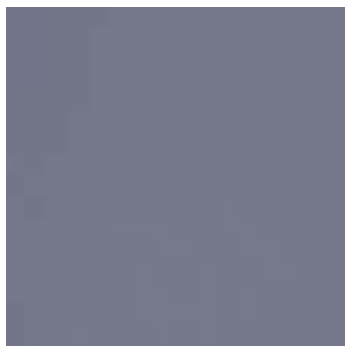

75140V3030 **CP27**
M koningsblauw uni / bleu royal uni /
 königsblau Uni / plain king's blue
 DP, DI, DU, SP
 S 5010-R70B



75150V3030 **CP27**
M duivenblauw uni / bleu pigeon uni /
 taubenblau Uni / plain dove blue
 DP, DI, DU, SP
 S 4005-R80B

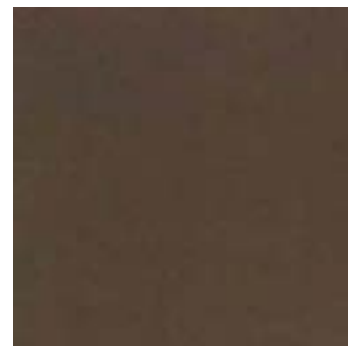

75160V3030 **CP27**
M indischbruin uni / brun Indien uni /
 Indischbraun Uni / plain Indian brown
 DP, DI, DU, SP
 S 7010-Y70R



75170V3030 **CP27**
M koperbruin uni / brun cuivre uni /
 kupferbraun Uni / plain copper brown
 DP, DI, DU, SP
 S 4030-Y50R



75180V3030 **CP27**
M engelsrood uni / rouge anglais uni /
 Englischrot Uni / plain light oxide red
 DP, DI, DU, SP
 S 4020-Y70R



75200V3030 **CP27**
M ivoorzwart uni / noir d'ivoire uni /
 elfenbeinschwarz Uni / plain ivory black
 P, I, U, DP, DI, DU, SP, 75201GL, 75201GS
 S 8000-N

3030 Global Collection

vloertegels / carreaux de sol / Bodenfliesen / floor tiles
 Ultragres ongeglazuurd / non émaillé / unglasiert / unglazed
 vorstbestand / ingélif / frostsicher / frost proof

bijpassende wandtegels / carreaux de faïence correspondants /
 dazugehörige Wandfliesen / matching wall tiles
 Global Collection 30 15 30

no.	mm	inch	pieces/ m ²	pieces/ m ¹	pieces/ box	boxes/ pallet	pieces/ pallet	m ² / pallet	kg/ m ²	kg/ pallet
75210V - 75430V	296x296x8	11.65x11.65x0.31	11	-	13 = 1,182 m ²	48	624	56,7	18,3	1.063



75210V3030
 M ecruwit uni / blanc écreu uni /
 weiß ungebleicht Uni / plain white unbleached
 P, I, U, DP, DI, DU, SP, 75211GL, 75211GS
 S 1005-Y10R



75220V3030
 M grijs uni / gris uni /
 grau Uni / plain grey
 P, I, U, DP, DI, DU, SP
 S 3000-N



75230V3030
 M muiskgrijs uni / gris de souris uni /
 mausgrau Uni / plain mouse grey
 P, I, U, DP, DI, DU, SP
 S 5500-N



76010V3030
 M porseleinwit uni / blanc porcelaine uni /
 porzellanweiß Uni / plain porcelain white
 DP, DI, DU, SP
 S 0500-N



76240V3030
 M warm grijs uni / gris chaleureux uni /
 warm grau Uni / plain warm grey
 DP, DI, DU, SP
 S 7005-Y20R



76250V3030
 M antraciet uni / anthracite uni /
 anthrazit Uni / plain anthracite
 DP, DI, DU, SP
 S 6500-N



76260V3030
 M siennarood uni / rouge de Sienna uni /
 Siennarot Uni / plain Sienna red
 DP, DI, DU, SP
 S 5030-Y70R



75420V3030
 M parelwit in gespikkeld / blanc de perle petits grains /
 perlweiß Feinkorn / small speckled pearl white
 DP, DI, DU, SP, 75720BN
 S 2005-Y20R



75430V3030
 M grijsbeige in gespikkeld / gris-beige petits grains /
 graubeige Feinkorn / small speckled grey beige
 DP, DI, DU, SP, 75730BN
 AS1515
 S 3005-Y20R

30 Global Collection

vloertegels / carreaux de sol / Bodenfliesen / floor tiles
 Ultragres ongeglazuurd / non émaillé / unglasiert / unglazed
 vorstbestand / ingélif / frostsicher / frost proof

bijpassende wandtegels / carreaux de faïence correspondants /
 dazugehörige Wandfliesen / matching wall tiles
 Global Collection

no.	mm	inch	pieces/ m ²	pieces/ m ¹	pieces/ box	boxes/ pallet	pieces/ pallet	m ² / pallet	kg/ m ²	kg/ pallet
75440V - 75520V	296x296x8	11.65x11.65x0.31	11	-	13 = 1,182 m ²	48	624	56,7	18,3	1.063



75440V3030 **CP25**
M aardebruin jn gespikkeld / brune terre petits grains /
 erdbruin Feinkorn / small speckled earth brown
 DP, DI, DU, SP, 75740BN
 AS1515
 S 3010-Y40R



75450V3030 **CP25**
M agaatgrijs jn gespikkeld / gris d'agate petits grains /
 achatgrau Feinkorn / small speckled agate grey
 DP, DI, DU, SP, 75750BN, TR
 AS1515
 S 5005-Y50R



75460V3030 **CP25**
M napelsgeel jn gespikkeld / jaune de Naples petits grains /
 Neapelgelb Feinkorn / small speckled Naples yellow
 DP, DI, DU, SP, 75760BN
 AS1515
 S 2030-Y20R



75470V3030 **CP25**
M zandgeel jn gespikkeld / jaune de sable petits grains /
 sandgelb Feinkorn / small speckled sand yellow
 DP, DI, DU, SP, 75770BN
 AS1515
 S 2020-Y20R



75480V3030 **CP25**
M olijfgroen jn gespikkeld / vert olive petits grains /
 olivgrün Feinkorn / small speckled olive green
 DP, DI, DU, SP, 75780BN
 AS1515
 S 3020-G20Y



75490V3030 **CP25**
M pastelgroen jn gespikkeld / vert pastel petits grains /
 pastelgrün Feinkorn / small speckled pastel green
 DP, DI, DU, SP, 75790BN
 AS1515
 S 3010-G50Y



75500V3030 **CP25**
M turkoois jn gespikkeld / turquoise petits grains /
 türkis Feinkorn / small speckled turquoise
 DP, DI, DU, SP, 75800BN
 AS1515
 S 6020-B30G



75510V3030 **CP25**
M mintgroen jn gespikkeld / vert de menthe petits grains /
 minzegrün Feinkorn / small speckled mint green
 DP, DI, DU, SP, 75810BN
 AS1515
 S 3010-G



75520V3030 **CP25**
M pruisischblauw jn gespikkeld / bleu de Prusse petits grains /
 Preußischblau Feinkorn / small speckled Prussian blue
 DP, DI, DU, SP, 75820BN
 AS1515
 S 6020-R90B

30 Global Collection

vloertegels / carreaux de sol / Bodenfliesen / floor tiles
 Ultragres ongeglazuurd / non émaillé / unglasiert / unglazed
 vorstbestand / ingélif / frostsicher / frost proof

bijpassende wandtegels / carreaux de faïence correspondants /
 dazugehörige Wandfliesen / matching wall tiles
 Global Collection 30 13 30

no.	mm	inch	pieces/ m ²	pieces/ m ¹	pieces/ box	boxes/ pallet	pieces/ pallet	m ² / pallet	kg/ m ²	kg/ pallet
75530V - 75620V	296x296x8	11.65x11.65x0.31	11	-	13 = 1,182 m ²	48	624	56,7	18,3	1.063



75530V3030 CP25
 sévresblauw in gespikkeld / bleu de Sévres petits grains /
 Sévresblau Feinkorn / small speckled Sévres blue
 DP, DI, DU, SP, 75830BN
 AS1515
 R10 A C2C 34 S 2020-R90B



75540V3030 CP25
 koningsblauw in gespikkeld / bleu royal petits grains /
 königsblau Feinkorn / small speckled king's blue
 DP, DI, DU, SP, 75840BN
 AS1515
 R10 A C2C 21 S 5010-R70B



75550V3030 CP25
 duivenblauw in gespikkeld / bleu pigeon petits grains /
 taubenblau Feinkorn / small speckled dove blue
 DP, DI, DU, SP, 75850BN
 AS1515
 R10 A C2C 35 S 4005-R80B



75560V3030 CP25
 indischbruin in gespikkeld / brun Indien petits grains /
 Indischbraun Feinkorn / small speckled Indian brown
 DP, DI, DU, SP, 75860BN
 AS1515
 R10 A C2C 11 S 7010-Y70R



75570V3030 CP25
 koperbruin in gespikkeld / brun cuivre petits grains /
 kupferbraun Feinkorn / small speckled copper brown
 DP, DI, DU, SP, 75870BN
 AS1515
 R10 A C2C 20 S 4030-Y50R



75580V3030 CP25
 engelsrood in gespikkeld / rouge anglais petits grains /
 Englischrot Feinkorn / small speckled light oxide red
 DP, DI, DU, SP, 75880BN
 AS1515
 R10 A C2C 25 S 4020-Y70R



75600V3030 CP25
 ivoorzwart in gespikkeld / noir d'ivoire petits grains /
 elfenbeinschwarz Feinkorn / small speckled ivory black
 DP, DI, DU, SP, 75900BN, TR
 AS1515, TS, WS
 R10 A C2C 8 S 8000-N





75610V3030 CP25
 ecruwit in gespikkeld / blanc écreu petits grains / weiß
 ungebleicht Feinkorn / small speckled white unbleached
 DP, DI, DU, SP, 75910BN, TR
 AS1515
 R10 A C2C 52 S 1005-Y10R



75620V3030 CP25
 grijs in gespikkeld / gris petits grains /
 grau Feinkorn / small speckled grey
 DP, DI, DU, SP, 75920BN, TR
 AS1515, TS, WS
 R10 A C2C 37 S 3000-N

30 Global Collection

vloertegels / carreaux de sol / Bodenfliesen / floor tiles
 Ultragres ongeglazuurd / non émaillé / unglasiert / unglazed
 vorstbestand / ingelif / frostsicher / frost proof

bijpassende wandtegels / carreaux de faïence correspondants /
 dazugehörige Wandfliesen / matching wall tiles
 Global Collection   

no.	mm	inch	pieces/ m ²	pieces/ m ¹	pieces/ box	boxes/ pallet	pieces/ pallet	m ² / pallet	kg/ m ²	kg/ pallet
75630V - 76660V	296x296x8	11.65x11.65x0.31	11	-	13 = 1,182 m ²	48	624	56,7	18,3	1.063



75630V3030   **CP25**
 muisgrijs jn gespikkeld / gris de souris petits grains /
 mausgrau Feinkorn / small speckled mouse grey
 DP, DI, DU, SP, 75930BN, TR
 AS1515
 R10  A  C2C  24  NCS S 5500-N



76410V3030   **CP25**
 porseleinwit jn gespikkeld / blanc porcelaine petits grains /
 porzellanweiß Feinkorn / small speckled porcelain white
 DP, DI, DU, SP, 76710BN

 R10  A  C2C  67  NCS S 0500-N



76640V3030   **CP25**
 warm grijs jn gespikkeld / gris chaleureux petits grains /
 warm grau Feinkorn / small speckled warm grey
 DP, DI, DU, SP, 76940BN

 R10  A  C2C  15  NCS S 7005-Y20R



76650V3030   **CP25**
 antraciet jn gespikkeld / anthracite
 petits grains / anthrazit Feinkorn /
 small speckled anthracite
 DP, DI, DU, SP, 76950BN

 R10  A  C2C  15  NCS S 6500-N



76660V3030   **CP25**
 siennarood jn gespikkeld / rouge de
 Sienna petits grains / Siennarot
 Feinkorn / small speckled Sienna red
 DP, DI, DU, SP, 76960BN

 R10  A  C2C  14  NCS S 5030-Y70R





Voor tegelpatronen zie www.mosa.com/nl-nl/grids.
 Pour des motifs de carreaux, nous vous invitons à consulter www.mosa.com/fr-fr/trames.
 Für Verlegemuster siehe www.mosa.com/de-de/raster.
 For tile patterns, see www.mosa.com/en-us/grids or www.mosa.com/en-us/grids.

Softline



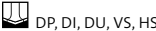

vloertegels / carreaux de sol / Bodenfliesen / floor tiles
 Ultragres ongeglazuurd / non émaillé / unglasiert / unglazed
 vorstbestand / ingélif / frostsicher / frost proof

no.	mm	inch	pieces/ m ²	pieces/ m ¹	pieces/ box	boxes/ pallet	pieces/ pallet	m ² / pallet	kg/ m ²	kg/ pallet
74030V - 74090V	296x296x8	11.65x11.65x0.31	11	-	13 = 1,182 m ²	48	624	56,7	18,3	1.063



74030V3030   CP23
 muisgrijs / gris de souris /
 mausgrau / mouse grey
 DP, DI, DU, VS, HS
 LS1515, LS3030
 R10 A C2C 24

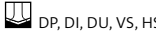

74090V3030   CP23
 ivoorzwart / noir d'ivoire /
 elfenbeinschwarz / ivory black
 DP, DI, DU, VS, HS
 LS1515, LS3030
 R10 A C2C 9

Voor de bijbehorende reliëftegelfcollectie Softgrip in dit formaat zie pagina 208.
 Pour la collection en relief correspondante Softgrip dans ce format voir page 208.
 Für die dazugehörige Reliefkollektion Softgrip in diesen Format siehe Seite 208.
 For the matching Softgrip relief tiles in this size see page 208.











Core Collection Solids

vloertegels / carreaux de sol / Bodenfliesen / floor tiles
 Ultragres ongeglazuurd / non émaillé / unglasiert / unglazed
 vorstbestand / ingélif / frostsicher / frost proof

no.	mm	inch	pieces/ m ²	pieces/ m ¹	pieces/ box	boxes/ pallet	pieces/ pallet	m ² / pallet	kg/ m ²	kg/ pallet
5102V - 5112V	297x597x12	11.69x23.50x0.47	5,56	-	4 = 0,719 m ²	48	192	34,5	26,5	941











5102V3060  BP03

 vivid white
 5002SP, BP, TVG, HV
 
  
    58



5104V3060  BP03

 clay grey
 BP, TVG, HV
 
    28









5106V3060  BP03

 agate grey
 5006SP, BP, TVG, HV
 
    15













5108V3060  BP03

 stone grey
 5008SP, BP, TVG, HV
 
  
    33













5110V3060  BP03

 basalt grey
 5010SP, BP, TVG, HV
 
  
    16



5112V3060  BP03

 graphite black
 BP, TVG, HV
 
  
    10

30/60 Core Collection Solids

vloertegels / carreaux de sol / Bodenfliesen / floor tiles
 Ultragres ongeglazuurd / non émaillé / unglasiert / unglazed
 vorstbestand / ingélif / frostsicher / frost proof

no.	mm	inch	pieces/ m ²	pieces/ m ¹	pieces/ box	boxes/ pallet	pieces/ pallet	m ² / pallet	kg/ m ²	kg/ pallet
5114V - 5126V	297x597x12	11.69x23.50x0.47	5,56	-	4 = 0,719 m ²	48	192	34,5	26,5	941



5114V3060 € BP03

M sand beige
 5014SP, BP, TVG, HV
 30/60
 R10 C2C 37

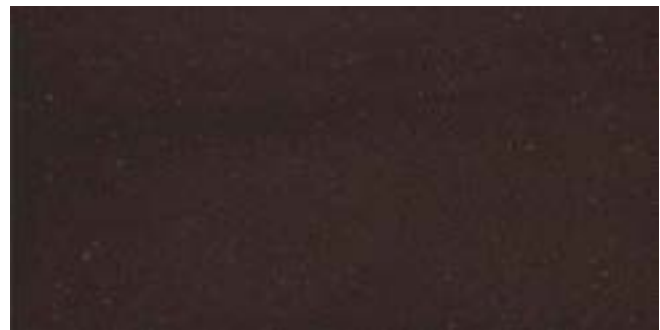

5118V3060 € BP03

M rust red
 BP, TVG, HV
 30/60
 R10 C2C 10



5120V3060 € BP03

M jade grey
 5020SP, BP, TVG, HV
 30/60
 R10 C2C 25



5126V3060 € BP03

M natural beige
 BP, TVG, HV
 30/60
 R10 C2C 52

Voor tegelpatronen zie www.mosa.com/nl-nl/grids.
 Pour des motifs de carreaux, nous vous invitons à consulter www.mosa.com/fr-fr/trames.
 Für Verlegemuster siehe www.mosa.com/de-de/raster.
 For tile patterns, see www.mosa.com/en-us/grids or www.mosa.com/en-us/grids.



Core Collection Terra

vloertegels / carreaux de sol / Bodenfliesen / floor tiles
 Ultragres ongeglazuurd / non émaillé / unglasiert / unglazed
 vorstbestand / ingélif / frostsicher / frost proof

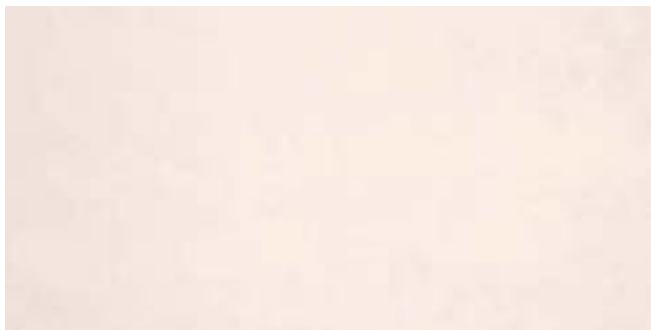
no.	mm	inch	pieces/ m ²	pieces/ m ¹	pieces/ box	boxes/ pallet	pieces/ pallet	m ² / pallet	kg/ m ²	kg/ pallet
200V - 214V	297x597x12	11.69x23.50x0.47	5,56	-	4 = 0,719 m ²	48	192	34,5	26,5	941



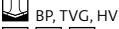

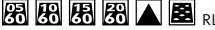
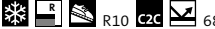

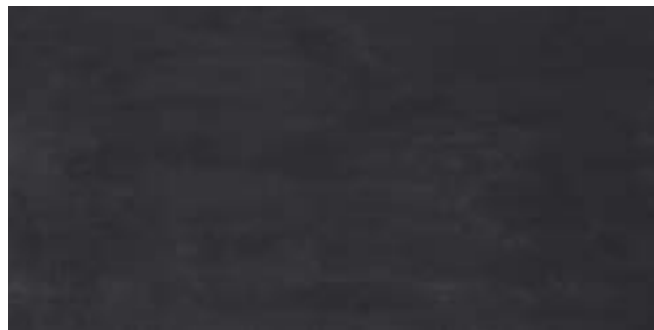
200V3060 

 cool porcelain white

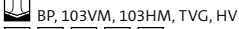
 RL

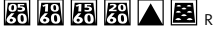







203V3060 

 cool black

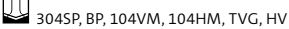
 RL





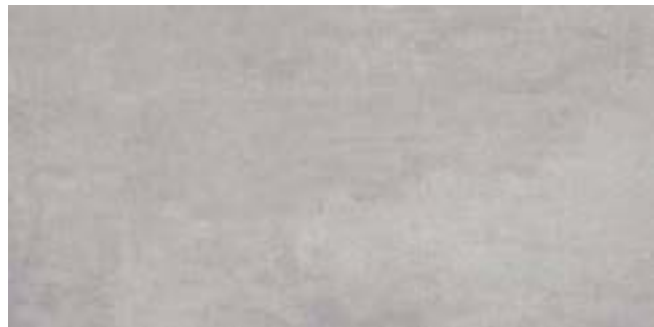



204V3060 

 mid warm grey

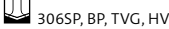
 RL

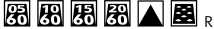







206V3060 

 mid grey

 RL







211V3060 

 avalon beige

 RL



214V3060 

 grey



30/60 Core Collection Terra

vloertegels / carreaux de sol / Bodenfliesen / floor tiles
 Ultragres ongeglazuurd / non émaillé / unglasiert / unglazed
 vorstbestand / ingélif / frostsicher / frost proof

no.	mm	inch	pieces/ m ²	pieces/ m ¹	pieces/ box	boxes/ pallet	pieces/ pallet	m ² / pallet	kg/ m ²	kg/ pallet
215V - 227V	297x597x12	11.69x23.50x0.47	5,56	-	4 = 0,719 m ²	48	192	34,5	26,5	941



215V3060 € BP16

M grey green
 315SP, BP
 60
 R10 C2C 18

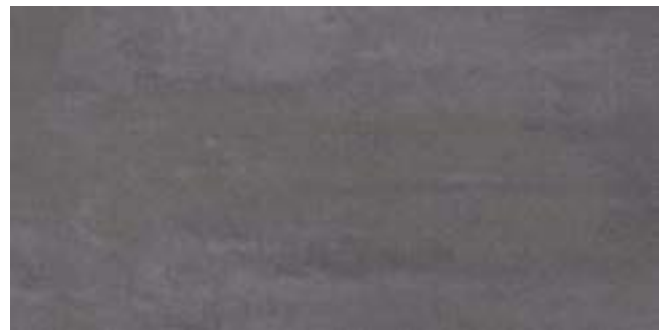

216V3060 € BP16

M anthracite
 316SP, BP, 116VM, 116HM, TVG, HV
 15 30 60 120 90
 60 60 60 60 60 RL
 R10 C2C 12

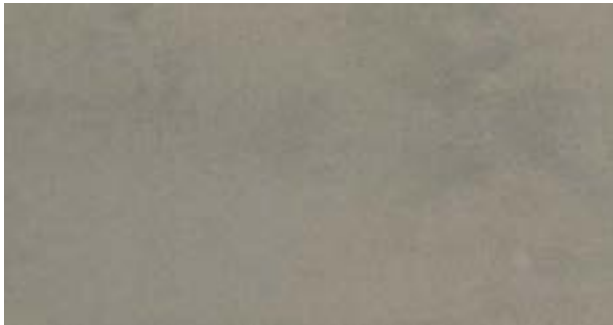

222V3060 € BP16

M mid moss-grey
 BP
 60
 60 60 60 60 60
 R10 C2C 25



225V3060 € BP16

M light cool grey
 BP, 125VM, 125HM
 15 30 60 120 90
 60 60 60 60 60
 R10 C2C 40



226V3060 € BP16

M mid cool grey
 BP, 126VM, 126HM, TVG, HV
 15 30 60 120 90
 60 60 60 60 60
 R10 C2C 23



227V3060 € BP16

M dark cool grey
 BP, TVG, HV
 30 60 120
 60 60 60 60
 R10 C2C 14











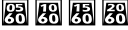
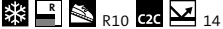

Core Collection Terra

vloertegels / carreaux de sol / Bodenfliesen / floor tiles
 Ultragres ongeglazuurd / non émaillé / unglasiert / unglazed
 vorstbestand / ingélif / frostsicher / frost proof

no.	mm	inch	pieces/ m ²	pieces/ m ¹	pieces/ box	boxes/ pallet	pieces/ pallet	m ² / pallet	kg/ m ²	kg/ pallet
229V - 264V	297x597x12	11.69x23.50x0.47	5,56	-	4 = 0,719 m ²	48	192	34,5	26,5	941







229V3060  BP16

 dark warm grey
 BP, TVG, HV
  
    
    14









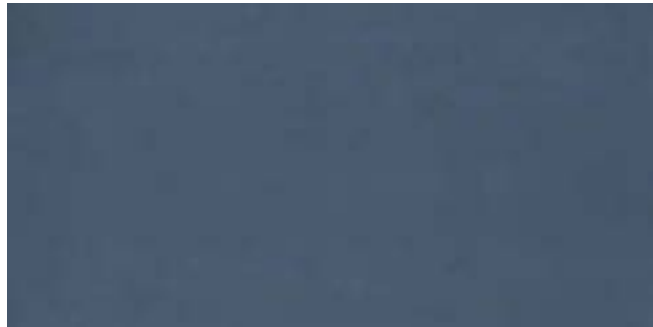



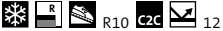

238V3060  BP16

 cool grey
 BP

    31

















239V3060  BP16

 blue
 BP

    
    12















262V3060  BP16

 light grey beige
 362SP, BP, TVG, HV
  
    
    61

















263V3060  BP16

 grey beige
 BP

    
    31



264V3060  BP16

 grey brown
 BP, 164VM, 164HM
  
    
    15



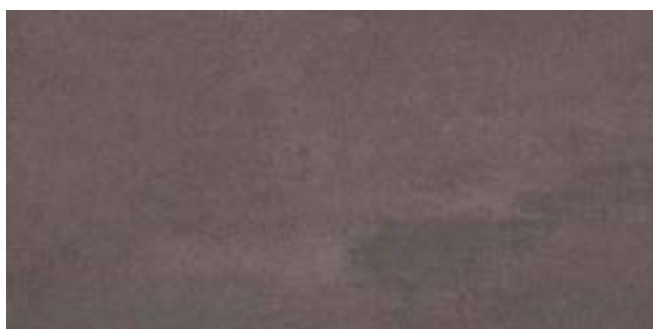

Core Collection Terra

vloertegels / carreaux de sol / Bodenfliesen / floor tiles
 Ultragres ongeglazuurd / non émaillé / unglasiert / unglazed
 vorstbestand / ingélif / frostsicher / frost proof

no.	mm	inch	pieces/ m ²	pieces/ m ¹	pieces/ box	boxes/ pallet	pieces/ pallet	m ² / pallet	kg/ m ²	kg/ pallet
265V - 270V	297x597x12	11.69x23.50x0.47	5,56	-	4 = 0,719 m ²	48	192	34,5	26,5	941





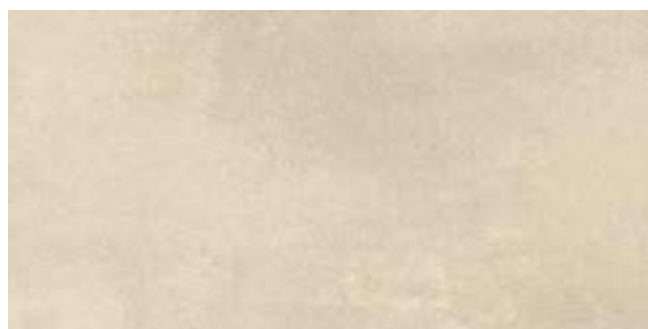

265V3060  BP16

 dark grey brown
 BP, TVG

 R10 C2C 9





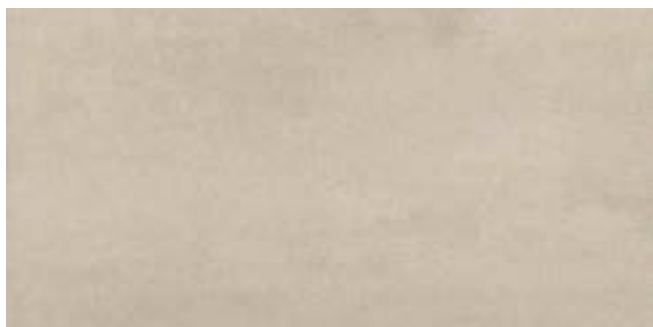

266V3060  BP16

 light beige
 BP, 166VM, 166HM

 R10 C2C 49

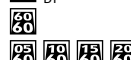

270V3060  BP16

 light red beige
 BP

 R10 C2C 40

Voor de bijbehorende reliëftegelcollectie Core Collection Terra in dit formaat zie pagina's 201 - 203.
 Pour la collection en relief correspondante Core Collection Terra dans ce format voir pages 201 - 203.
 Für die dazugehörige Reliefkollektion Core Collection Terra in diesen Format siehe Seiten 201 - 203.
 For the matching Core Collection Terra relief tiles in this size see pages 201 - 203.

Voor tegelpatronen zie www.mosa.com/nl-nl/grids.
 Pour des motifs de carreaux, nous vous invitons à consulter www.mosa.com/fr-fr/trames.
 Für Verlegemuster siehe www.mosa.com/de-de/raster.
 For tile patterns, see www.mosa.com/en-us/grids or www.mosa.com/en-us/grids.

Mosa Stage

vloertegels / carreaux de sol / Bodenfliesen / floor tiles
 Ultragres ongeglazuurd / non émaillé / unglasiert / unglazed
 vorstbestand / ingélif / frostsicher / frost proof

no.	mm	inch	pieces/ m ²	pieces/ m ¹	pieces/ box	boxes/ pallet	pieces/ pallet	m ² / pallet	kg/ m ²	kg/ pallet
3502CR - 3512CR	297x597x12	11.69x23.50x0.47	5,56	-	4 = 0,719 m ²	48	192	34,5	26,5	941



3502CR3060  BP16

 cool white









3504CR3060  BP16

 light cool grey









3506CR3060  BP16

 dark cool grey

   









3508CR3060  BP16

 light warm grey

   









3510CR3060  BP16

 mid warm grey

   



3512CR3060  BP16

 dark plum brown

   

Mosa Stage

vloertegels / carreaux de sol / Bodenfliesen / floor tiles
 Ultragres ongeglazuurd / non émaillé / unglasiert / unglazed
 vorstbestand / ingélif / frostsicher / frost proof

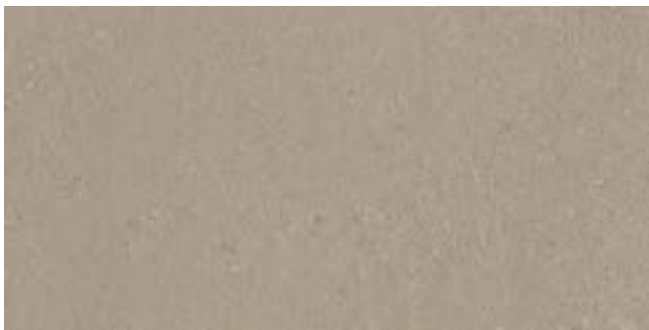
no.	mm	inch	pieces/ m ²	pieces/ m ¹	pieces/ box	boxes/ pallet	pieces/ pallet	m ² / pallet	kg/ m ²	kg/ pallet
3514CR - 3518CR	297x597x12	11.69x23.50x0.47	5,56	-	4 = 0,719 m ²	48	192	34,5	26,5	941



3514CR3060 

 sienna beige

 BP, TCG

    35

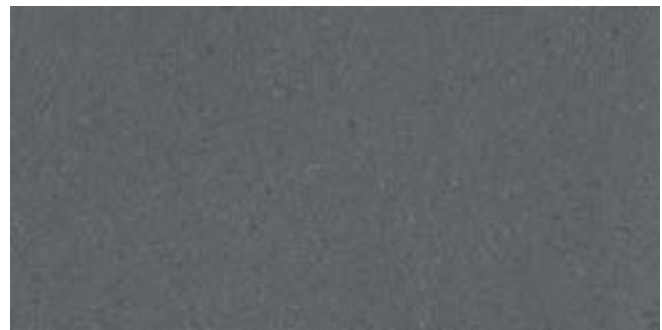

3516CR3060 

 paynes grey

 BP, TCG

    14



3518CR3060 

 ivory black

 BP, TCG

    8

Voor tegelpatronen zie www.mosa.com/nl-nl/grids.
 Pour des motifs de carreaux, nous vous invitons à consulter www.mosa.com/fr-fr/trames.
 Für Verlegemuster siehe www.mosa.com/de-de/raster.
 For tile patterns, see www.mosa.com/en-grids or www.mosa.com/en-us/grids.







Terra Tones

vloertegels / carreaux de sol / Bodenfliesen / floor tiles
 Ultragres ongeglazuurd / non émaillé / unglasiert / unglazed
 vorstbestand / ingélif / frostsicher / frost proof

no.	mm	inch	pieces/ m ²	pieces/ m ¹	pieces/ box	boxes/ pallet	pieces/ pallet	m ² / pallet	kg/ m ²	kg/ pallet
200XV - 203ZV	297x597x12	11.69x23.50x0.47	5,56	-	4 = 0,719 m ²	48	192	34,5	26,5	941







200XV3060 
 200YV3060
 200ZV3060

 cool porcelain white

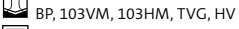





203XV3060 
 203YV3060
 203ZV3060

 cool black







Terra Tones

vloertegels / carreaux de sol / Bodenfliesen / floor tiles
 Ultragres ongeglazuurd / non émaillé / unglasiert / unglazed
 vorstbestand / ingélif / frostsicher / frost proof

no.	mm	inch	pieces/ m ²	pieces/ m ¹	pieces/ box	boxes/ pallet	pieces/ pallet	m ² / pallet	kg/ m ²	kg/ pallet
204XV - 206ZV	297x597x12	11.69x23.50x0.47	5,56	-	4 = 0,719 m ²	48	192	34,5	26,5	941





204XV3060  AP01
 204YV3060
 204ZV3060









 mid warm grey
 304SP, BP, 104VM, 104HM, TVG, HV

  
   R10  22



206XV3060  AP01
 206YV3060
 206ZV3060

 mid grey
 306SP, BP, TVG, HV

  
   R10  34







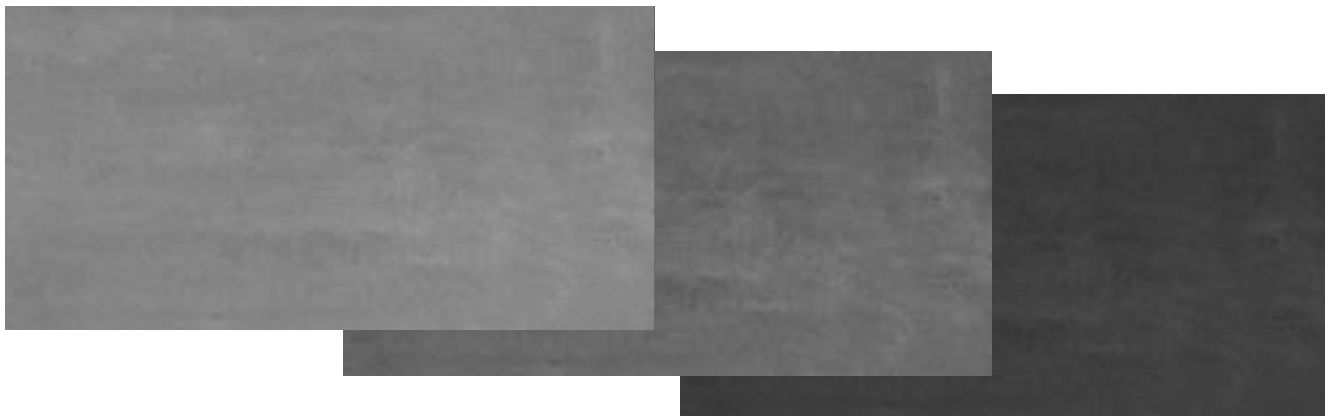

Terra Tones

vloertegels / carreaux de sol / Bodenfliesen / floor tiles
 Ultragres ongeglazuurd / non émaillé / unglasiert / unglazed
 vorstbestand / îngélif / frostsicher / frost proof

no.	mm	inch	pieces/ m ²	pieces/ m ¹	pieces/ box	boxes/ pallet	pieces/ pallet	m ² / pallet	kg/ m ²	kg/ pallet
215XV - 216ZV	297x597x12	11.69x23.50x0.47	5,56	-	4 = 0,719 m ²	48	192	34,5	26,5	941











215XV3060 
 215YV3060
 215ZV3060

 grey green
 315SP, BP



 R10   18



216XV3060 
 216YV3060
 216ZV3060

 anthracite
 316SP, BP, 116VM, 116HM, TVG, HV



 R10   12

Terra Tones

vloertegels / carreaux de sol / Bodenfliesen / floor tiles
 Ultragres ongeglazuurd / non émaillé / unglasiert / unglazed
 vorstbestand / ingélif / frostsicher / frost proof

no.	mm	inch	pieces/ m ²	pieces/ m ¹	pieces/ box	boxes/ pallet	pieces/ pallet	m ² / pallet	kg/ m ²	kg/ pallet
266XV - 266ZV	297x597x12	11.69x23.50x0.47	5,56	-	4 = 0,719 m ²	48	192	34,5	26,5	941



266XV3060 

266YV3060

266ZV3060

 light beige

 BP, 166VM, 166HM



   R10 C2C 49

Elke kleurgroep telt lichte (X), midden (Y) en donkere (Z) tonen. Per kleurgroep worden, per formaat, willekeurige hoeveelheden van X, Y en Z geleverd.
 Chaque groupe de couleur compte des tons clairs (X), moyens (Y) et foncés (Z). Les quantités aléatoires de X, Y et Z sont fournies par format et par groupe de couleur.
 Jede Farbgruppe enthält helle (X), mittlere (Y) und dunkle (Z) Töne. Pro Farbgruppe sind pro Format zufälligen Mengen von X, Y und Z erhältlich.
 Each colour group has light (X), medium (Y), and dark (Z) shades. For each colour group and size, random quantities of X, Y, and Z are supplied.

Voor tegelpatronen zie www.mosa.com/nl-nl/grids.

Pour des motifs de carreaux, nous vous invitons à consulter www.mosa.com/fr-fr/trames.

Für Verlegemuster siehe www.mosa.com/de-de/raster.

For tile patterns, see www.mosa.com/en-grids or www.mosa.com/en-us/grids.

Voor uitgebreide verwerkingsadviezen zie www.mosa.com.

On peut trouver toutes les directives de pose sur www.mosa.com.

Für komplette Hinweise zur Verarbeitung siehe www.mosa.com.

The complete guidelines for installation can be found on www.mosa.com.







Core Collection Quartz

vloertegels / carreaux de sol / Bodenfliesen / floor tiles
 Ultragres ongeglazuurd / non émaillé / unglasiert / unglazed
 vorstbestand / ingélif / frostsicher / frost proof

no.	mm	inch	pieces/ m ²	pieces/ m ¹	pieces/ box	boxes/ pallet	pieces/ pallet	m ² / pallet	kg/ m ²	kg/ pallet
4101V - 4104V	597x597x12	23.50x23.50x0.47	2,8	-	3 = 1,071 m ²	30	90	32,1	27,8	918







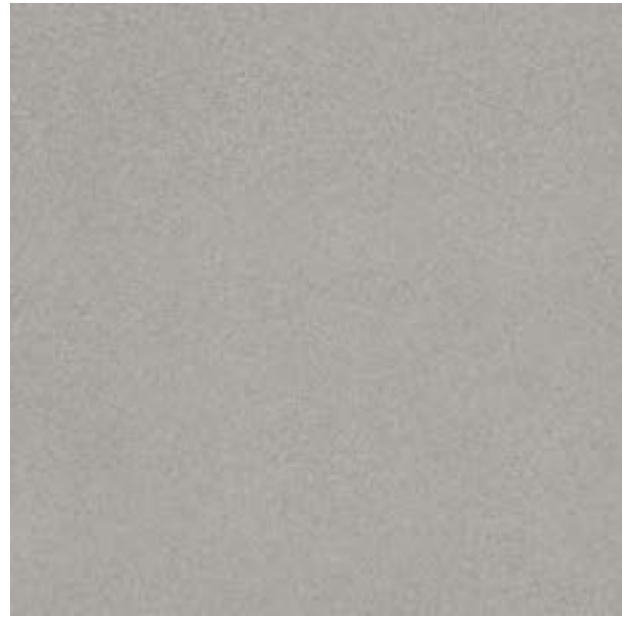

4101V6060 

 chalk white
 BP
 RQ
 R
 C2C
 64



4102V6060 

 slate grey
 BP
 RQ
 R
 C2C
 39

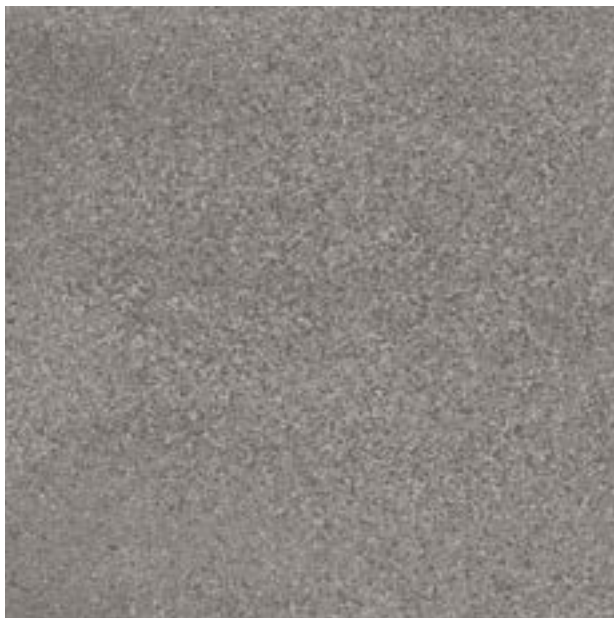





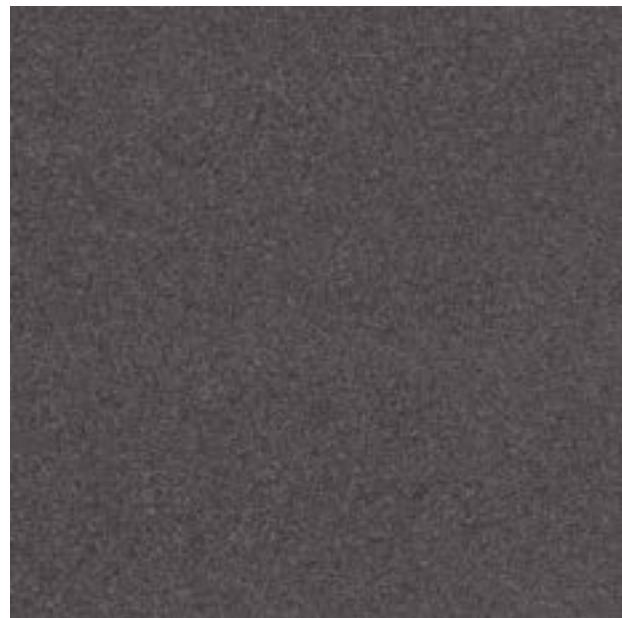

4103V6060 

 basalt grey
 BP
 RQ
 R
 C2C
 20



4104V6060 

 anthracite black
 BP
 RQ
 R
 C2C
 9

Core Collection Quartz

vloertegels / carreaux de sol / Bodenfliesen / floor tiles
 Ultragres ongeglazuurd / non émaillé / unglasiert / unglazed
 vorstbestand / ingélif / frostsicher / frost proof

no.	mm	inch	pieces/ m ²	pieces/ m ¹	pieces/ box	boxes/ pallet	pieces/ pallet	m ² / pallet	kg/ m ²	kg/ pallet
4105V - 4107V	597x597x12	23.50x23.50x0.47	2,8	-	3 = 1,071 m ²	30	90	32,1	27,8	918









4105V6060  AP10

 sand beige
 BP
 RQ
 R  C2C  53



4107V6060  AP10

 agate grey
 BP
 RQ
 R  C2C  19

Voor de bijbehorende reliëftegelcollectie Core Collection Quartz in dit formaat zie pagina's 195 en 196.
 Pour la collection en relief correspondante Core Collection Quartz dans ce format voir pages 195 et 196.
 Für die dazugehörige Reliefkollektion Core Collection Quartz in diesem Format siehe Seiten 195 und 196.
 For the matching Core Collection Quartz relief tiles in this size see pages 195 and 196.

Voor tegelpatronen zie www.mosa.com/nl-nl/grids.
 Pour des motifs de carreaux, nous vous invitons à consulter www.mosa.com/fr-fr/trames.
 Für Verlegemuster siehe www.mosa.com/de-de/raster.
 For tile patterns, see www.mosa.com/en-us/grids or www.mosa.com/en-us/grids.











Core Collection Solids

vloertegels / carreaux de sol / Bodenfliesen / floor tiles
 Ultragres ongeglazuurd / non émaillé / unglasiert / unglazed
 vorstbestand / ingélif / frostsicher / frost proof

no.	mm	inch	pieces/ m ²	pieces/ m ¹	pieces/ box	boxes/ pallet	pieces/ pallet	m ² / pallet	kg/ m ²	kg/ pallet
5102V - 5108V	597x597x12	23.50x23.50x0.47	2,8	-	3 = 1,071 m ²	30	90	32,1	27,8	918







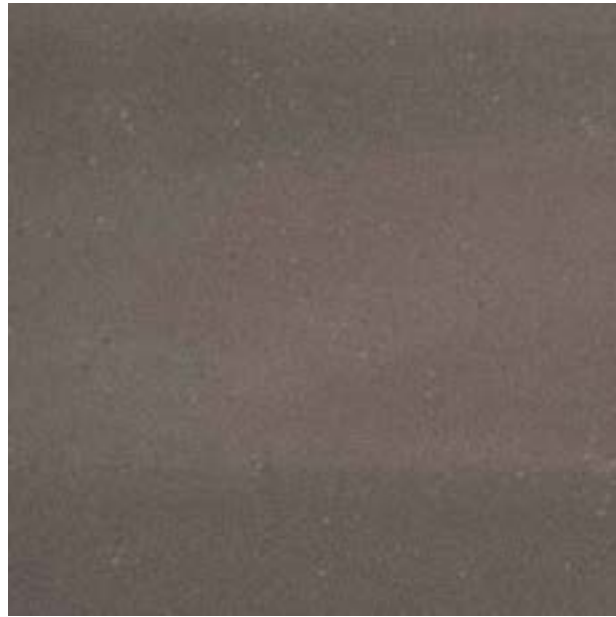

5102V6060 

 vivid white
 5002SP, BP, TVG, HV
 
  
 MR
   58











5104V6060 

 clay grey
 BP, TVG, HV
 
   28













5106V6060 

 agate grey
 5006SP, BP, TVG, HV
 
 MR
   15



5108V6060 

 stone grey
 5008SP, BP, TVG, HV
 
   MR
   33

60 60 Core Collection Solids

vloertegels / carreaux de sol / Bodenfliesen / floor tiles
 Ultragres ongeglazuurd / non émaillé / unglasiert / unglazed
 vorstbestand / ingélif / frostsicher / frost proof

no.	mm	inch	pieces/ m ²	pieces/ m ¹	pieces/ box	boxes/ pallet	pieces/ pallet	m ² / pallet	kg/ m ²	kg/ pallet
5110V - 5118V	597x597x12	23.50x23.50x0.47	2,8	-	3 = 1,071 m ²	30	90	32,1	27,8	918



5110V6060 € BP03

M basalt grey
 5010SP, BP, TVG, HV
 60 90
 60 60 60 ▲ MR
 R10 C2C 16



5112V6060 € BP03

M graphite black
 BP, TVG, HV
 60 90
 60 60 60 ▲ MR
 R10 C2C 10



5114V6060 € BP03

M sand beige
 5014SP, BP, TVG, HV
 60 90
 60 60 60 ▲ MR
 R10 C2C 37



5118V6060 € BP03

M rust red
 BP, TVG, HV
 60 90
 60 60 60 ▲ MR
 R10 C2C 10



Core Collection Solids

vloertegels / carreaux de sol / Bodenfliesen / floor tiles
 Ultragres ongeglazuurd / non émaillé / unglasiert / unglazed
 vorstbestand / ingélif / frostsicher / frost proof

no.	mm	inch	pieces/ m ²	pieces/ m ¹	pieces/ box	boxes/ pallet	pieces/ pallet	m ² / pallet	kg/ m ²	kg/ pallet
5120V - 5126V	597x597x12	23.50x23.50x0.47	2,8	-	3 = 1,071 m ²	30	90	32,1	27,8	918



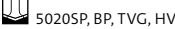

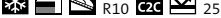
5120V6060 

 jade grey
 5020SP, BP, TVG, HV

 MR
 R10 C2C 25

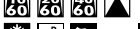
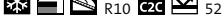

5126V6060 

 natural beige
 BP, TVG, HV

 R10 C2C 52

Voor de bijbehorende reliëftegelcollectie Core Collection Solids in dit formaat zie pagina's 197 en 198.
 Pour la collection en relief correspondante Core Collection Solids dans ce format voir pages 197 et 198.
 Für die dazugehörige Reliefkollektion Core Collection Solids in diesen Format siehe Seiten 197 und 198.
 For the matching Core Collection Solids relief tiles in this size see pages 197 and 198.

Voor tegelpatronen zie www.mosa.com/nl-nl/grids.
 Pour des motifs de carreaux, nous vous invitons à consulter www.mosa.com/fr-fr/trames.
 Für Verlegemuster siehe www.mosa.com/de-de/raster.
 For tile patterns, see www.mosa.com/en-us/grids or www.mosa.com/en-us/grids.

60 60 Core Collection Terra

vloertegels / carreaux de sol / Bodenfliesen / floor tiles
 Ultragres ongeglazuurd / non émaillé / unglasiert / unglazed
 vorstbestand / ingélif / frostsicher / frost proof

no.	mm	inch	pieces/ m ²	pieces/ m ¹	pieces/ box	boxes/ pallet	pieces/ pallet	m ² / pallet	kg/ m ²	kg/ pallet
200V - 206V	597x597x12	23.50x23.50x0.47	2,8	-	3 = 1,071 m ²	30	90	32,1	27,8	918



200V6060 € BP16

M cool porcelain white
 BP, TVG, HV
 60 60 120 90
 60 60 60 60 60 ▲ RL
 R10 C2C 68



203V6060 € BP16

M cool black
 BP, 103VM, 103HM, TVG, HV
 60 60 60 60 60 60
 60 60 60 60 60 ▲ RL
 R10 C2C 8



204V6060 € BP16

M mid warm grey
 304SP, BP, 104VM, 104HM, TVG, HV
 60 60 60 60 60
 60 60 60 60 60 ▲ RL
 R10 C2C 22



206V6060 € BP16

M mid grey
 306SP, BP, TVG, HV
 60 60 60 60 60
 60 60 60 60 60 ▲ RL
 R10 C2C 34

60 Core Collection Terra

vloertegels / carreaux de sol / Bodenfliesen / floor tiles
 Ultragres ongeglazuurd / non émaillé / unglasiert / unglazed
 vorstbestand / ingélif / frostsicher / frost proof

no.	mm	inch	pieces/ m ²	pieces/ m ¹	pieces/ box	boxes/ pallet	pieces/ pallet	m ² / pallet	kg/ m ²	kg/ pallet
211V - 216V	597x597x12	23.50x23.50x0.47	2,8	-	3 = 1,071 m ²	30	90	32,1	27,8	918



211V6060 € BP16

M avalon beige
 BP, TVG, HV
 30 60 120
 60 10 15 20 30 45
 RL
 R10 C2C 51

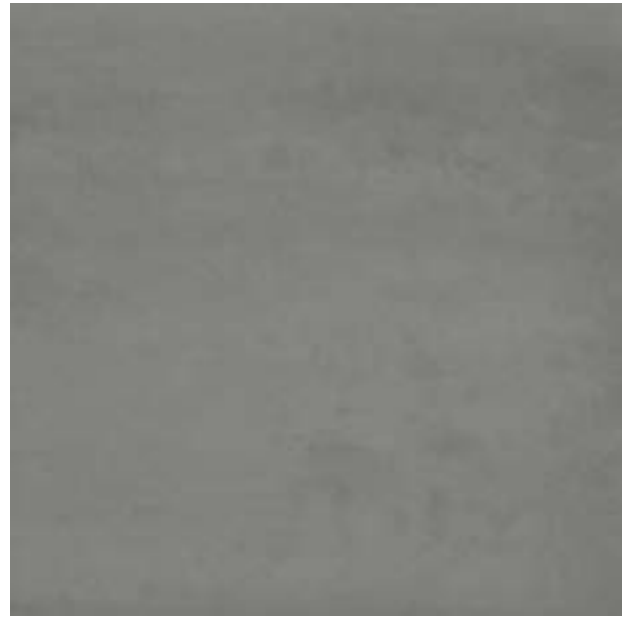

214V6060 € BP16

M grey
 BP
 30 60
 R10 C2C 21



215V6060 € BP16

M grey green
 315SP, BP
 30 60
 R10 C2C 18



216V6060 € BP16

M anthracite
 316SP, BP 116VM, 116HM, TVG, HV
 15 30 60 120 90
 60 60 60 60
 RL
 R10 C2C 12













Core Collection Terra

vloertegels / carreaux de sol / Bodenfliesen / floor tiles
 Ultragres ongeglazuurd / non émaillé / unglasiert / unglazed
 vorstbestand / ingélif / frostsicher / frost proof

no.	mm	inch	pieces/ m ²	pieces/ m ¹	pieces/ box	boxes/ pallet	pieces/ pallet	m ² / pallet	kg/ m ²	kg/ pallet
222V - 227V	597x597x12	23.50x23.50x0.47	2,8	-	3 = 1,071 m ²	30	90	32,1	27,8	918







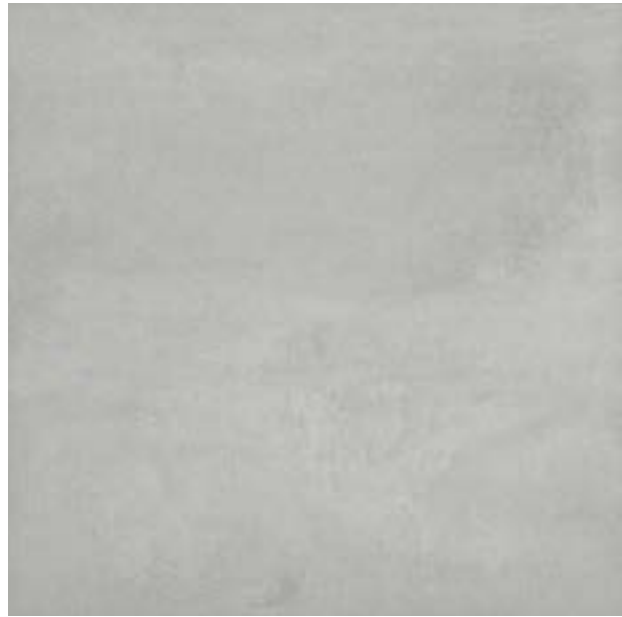





222V6060  BP16

 mid moss-grey
 BP
       
   25







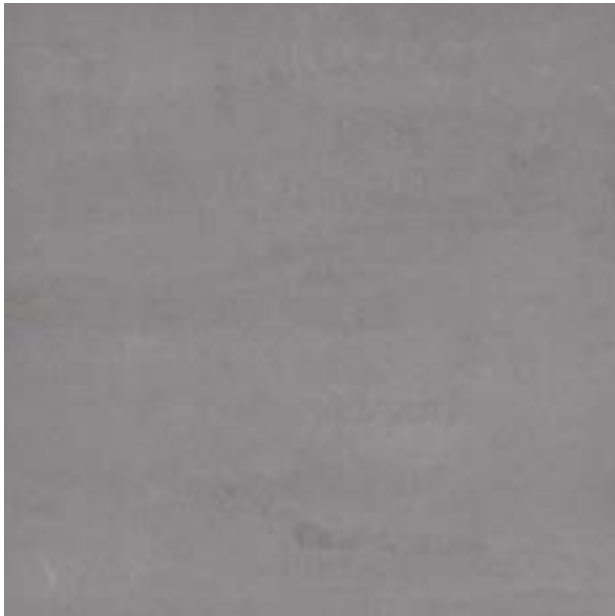







225V6060  BP16

 light cool grey
 BP, 125VM, 125HM
      
   40















226V6060  BP16

 mid cool grey
 BP, 126VM, 126HM, TVG, HV
      
   23



227V6060  BP16

 dark cool grey
 BP, TVG, HV
      
   14

60 Core Collection Terra

vloertegels / carreaux de sol / Bodenfliesen / floor tiles
 Ultragres ongeglazuurd / non émaillé / unglasiert / unglazed
 vorstbestand / ingélif / frostsicher / frost proof

no.	mm	inch	pieces/ m ²	pieces/ m ¹	pieces/ box	boxes/ pallet	pieces/ pallet	m ² / pallet	kg/ m ²	kg/ pallet
229V - 262V	597x597x12	23.50x23.50x0.47	2,8	-	3 = 1,071 m ²	30	90	32,1	27,8	918



229V6060 € BP16

M dark warm grey
 BP, TVG, HV

 R10 C2C 14



238V6060 € BP16

M cool grey
 BP

 R10 C2C 31



239V6060 € BP16

M blue
 BP

 R10 C2C 12



262V6060 € BP16

M light grey beige
 362SP, BP, TVG, HV

 R10 C2C 61



60 60 Core Collection Terra

vloertegels / carreaux de sol / Bodenfliesen / floor tiles
 Ultragres ongeglazuurd / non émaillé / unglasiert / unglazed
 vorstbestand / ingélif / frostsicher / frost proof

no.	mm	inch	pieces/ m ²	pieces/ m ¹	pieces/ box	boxes/ pallet	pieces/ pallet	m ² / pallet	kg/ m ²	kg/ pallet
263V - 266V	597x597x12	23.50x23.50x0.47	2,8	-	3 = 1,071 m ²	30	90	32,1	27,8	918



263V6060 € BP16

M grey beige
 BP
 60 60 60 60
 60 60 60 60
 R10 C2C 31



264V6060 € BP16

M grey brown
 BP, 164VM, 164HM
 60 60 60
 60 60 60 60
 R10 C2C 15



265V6060 € BP16

M dark grey brown
 BP, TVG
 60 60 60 60
 60 60 60 60
 R10 C2C 9



266V6060 € BP16

M light beige
 BP, 166VM, 166HM
 60 60 60
 60 60 60 60
 R10 C2C 49

Core Collection Terra

vloertegels / carreaux de sol / Bodenfliesen / floor tiles
 Ultragres ongeglazuurd / non émaillé / unglasiert / unglazed
 vorstbestand / ingélif / frostsicher / frost proof

no.	mm	inch	pieces/ m ²	pieces/ m ¹	pieces/ box	boxes/ pallet	pieces/ pallet	m ² / pallet	kg/ m ²	kg/ pallet
270V	597x597x12	23.50x23.50x0.47	2,8	-	3 = 1,071 m ²	30	90	32,1	27,8	918



270V6060  BP16

 light red beige

 BP

 6060

 6060

 R10  C2C  40

Voor de bijbehorende reliëftegelcollectie Core Collection Terra in dit formaat zie pagina's 201 - 203.
 Pour la collection en relief correspondante Core Collection Terra dans ce format voir pages 201 - 203.
 Für die dazugehörige Reliefkollektion Core Collection Terra in diesen Format siehe Seiten 201 - 203.
 For the matching Core Collection Terra relief tiles in this size see pages 201 - 203.

Voor tegelpatronen zie www.mosa.com/nl-nl/grids.
 Pour des motifs de carreaux, nous vous invitons à consulter www.mosa.com/fr-fr/trames.
 Für Verlegemuster siehe www.mosa.com/de-de/raster.
 For tile patterns, see www.mosa.com/en-us/grids or www.mosa.com/en-us/grids.

Mosa Stage

vloertegels / carreaux de sol / Bodenfliesen / floor tiles
 Ultragres ongeglazuurd / non émaillé / unglasiert / unglazed
 vorstbestand / ingélif / frostsicher / frost proof

no.	mm	inch	pieces/ m ²	pieces/ m ¹	pieces/ box	boxes/ pallet	pieces/ pallet	m ² / pallet	kg/ m ²	kg/ pallet
3502CR - 3508CR	597x597x12	23.50x23.50x0.47	2,8	-	3 = 1,071 m ²	30	90	32,1	27,8	918









3502CR6060  BP16

 cool white
 BP, TCG

    60









3504CR6060  BP16

 light cool grey
 BP, TCG

    38









3506CR6060  BP16

 dark cool grey
 BP, TCG

    17



3508CR6060  BP16

 light warm grey
 BP, TCG

    42

Mosa Stage

vloertegels / carreaux de sol / Bodenfliesen / floor tiles
 Ultragres ongeglazuurd / non émaillé / unglasiert / unglazed
 vorstbestand / ingélif / frostsicher / frost proof

no.	mm	inch	pieces/ m ²	pieces/ m ¹	pieces/ box	boxes/ pallet	pieces/ pallet	m ² / pallet	kg/ m ²	kg/ pallet
3510CR - 3516CR	597x597x12	23.50x23.50x0.47	2,8	-	3 = 1,071 m ²	30	90	32,1	27,8	918







3510CR6060  BP16

 mid warm grey









3512CR6060  BP16

 dark plum brown









3514CR6060  BP16

 sienna beige





3516CR6060  BP16

 paynes grey





Mosa Stage

vloertegels / carreaux de sol / Bodenfliesen / floor tiles
 Ultragres oneglazuurd / non émaillé / unglasiert / unglazed
 vorstbestand / ingélif / frostsicher / frost proof

no.	mm	inch	pieces/ m ²	pieces/ m ¹	pieces/ box	boxes/ pallet	pieces/ pallet	m ² / pallet	kg/ m ²	kg/ pallet
3518CR	597x597x12	23.50x23.50x0.47	2,8	-	3 = 1,071 m ²	30	90	32,1	27,8	918



3518CR6060  BP16

 ivory black

 BP, TCG

Voor tegelpatronen zie www.mosa.com/nl-nl/grids.
 Pour des motifs de carreaux, nous vous invitons à consulter www.mosa.com/fr-fr/trames.
 Für Verlegemuster siehe www.mosa.com/de-de/raster.
 For tile patterns, see www.mosa.com/en-us/grids or www.mosa.com/en-us/grids.











Terra Tones

vloertegels / carreaux de sol / Bodenfliesen / floor tiles
 Ultragres ongeglazuurd / non émaillé / unglasiert / unglazed
 vorstbestand / ingélif / frostsicher / frost proof

no.	mm	inch	pieces/ m ²	pieces/ m ¹	pieces/ box	boxes/ pallet	pieces/ pallet	m ² / pallet	kg/ m ²	kg/ pallet
200XV - 200ZV	597x597x12	23.50x23.50x0.47	2,8	-	3 = 1,071 m ²	30	90	32,1	27,8	918



200XV6060 
 200YV6060
 200ZV6060

 cool porcelain white
 BP, TVG, HV

  
    68

Terra Tones

vloertegels / carreaux de sol / Bodenfliesen / floor tiles
 Ultragres ongeglazuurd / non émaillé / unglasiert / unglazed
 vorstbestand / ingélif / frostsicher / frost proof

no.	mm	inch	pieces/ m ²	pieces/ m ¹	pieces/ box	boxes/ pallet	pieces/ pallet	m ² / pallet	kg/ m ²	kg/ pallet
203XV - 203ZV	597x597x12	23.50x23.50x0.47	2,8	-	3 = 1,071 m ²	30	90	32,1	27,8	918



203XV6060  AP01

203YV6060

203ZV6060



cool black



BP, 103VM, 103HM, TVG, HV



R10 C2C 8

Terra Tones

vloertegels / carreaux de sol / Bodenfliesen / floor tiles
 Ultragres ongeglazuurd / non émaillé / unglasiert / unglazed
 vorstbestand / ingélif / frostsicher / frost proof

no.	mm	inch	pieces/ m ²	pieces/ m ¹	pieces/ box	boxes/ pallet	pieces/ pallet	m ² / pallet	kg/ m ²	kg/ pallet
204XV - 204ZV	597x597x12	23.50x23.50x0.47	2,8	-	3 = 1,071 m ²	30	90	32,1	27,8	918



204XV6060  AP01
 204YV6060
 204ZV6060

 mid warm grey
 304SP, BP, 104VM, 104HM, TVG, HV

  
   R10  22

Terra Tones

vloertegels / carreaux de sol / Bodenfliesen / floor tiles
 Ultragres ongeglazuurd / non émaillé / unglasiert / unglazed
 vorstbestand / ingélif / frostsicher / frost proof

no.	mm	inch	pieces/ m ²	pieces/ m ¹	pieces/ box	boxes/ pallet	pieces/ pallet	m ² / pallet	kg/ m ²	kg/ pallet
206XV - 206ZV	597x597x12	23.50x23.50x0.47	2,8	-	3 = 1,071 m ²	30	90	32,1	27,8	918

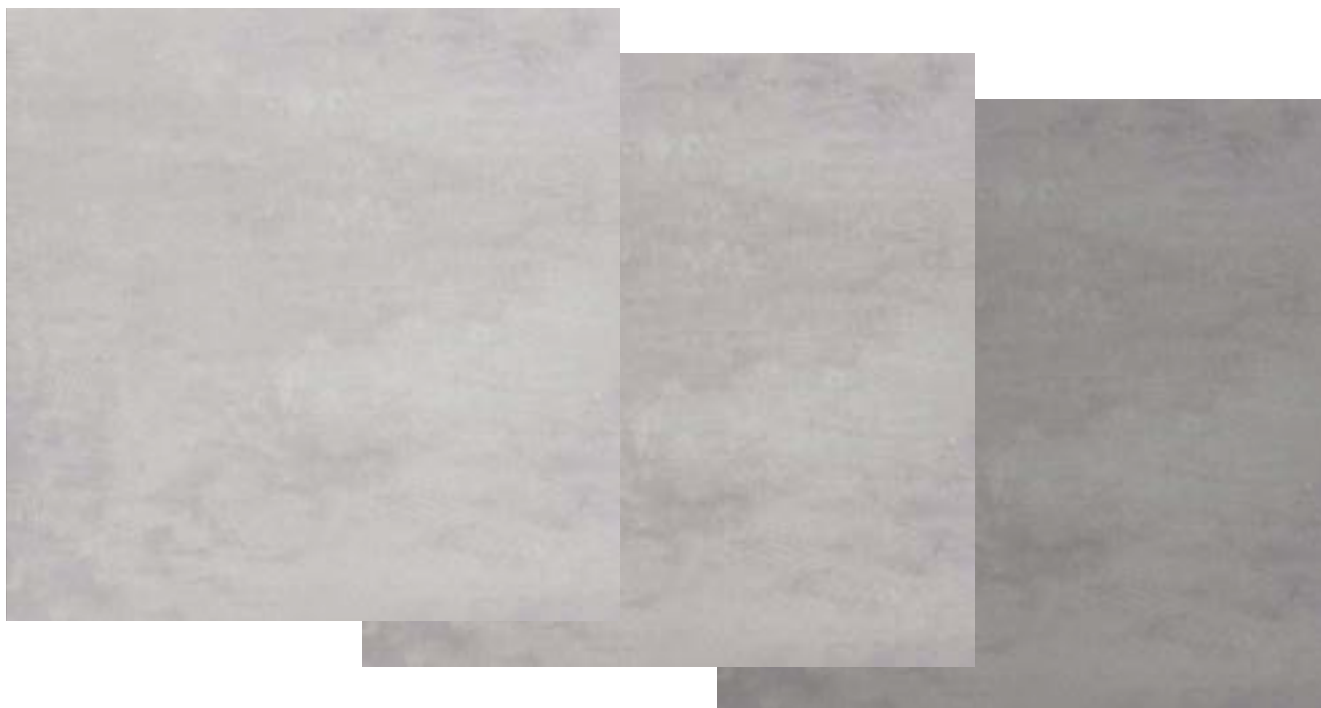

206XV6060  AP01

206YV6060

206ZV6060



mid grey



306SP, BP, TVG, HV



R10 C2C 34

Terra Tones

vloertegels / carreaux de sol / Bodenfliesen / floor tiles
 Ultragres ongeglazuurd / non émaillé / unglasiert / unglazed
 vorstbestand / ingélif / frostsicher / frost proof

no.	mm	inch	pieces/ m ²	pieces/ m ¹	pieces/ box	boxes/ pallet	pieces/ pallet	m ² / pallet	kg/ m ²	kg/ pallet
215XV - 215ZV	597x597x12	23.50x23.50x0.47	2,8	-	3 = 1,071 m ²	30	90	32,1	27,8	918

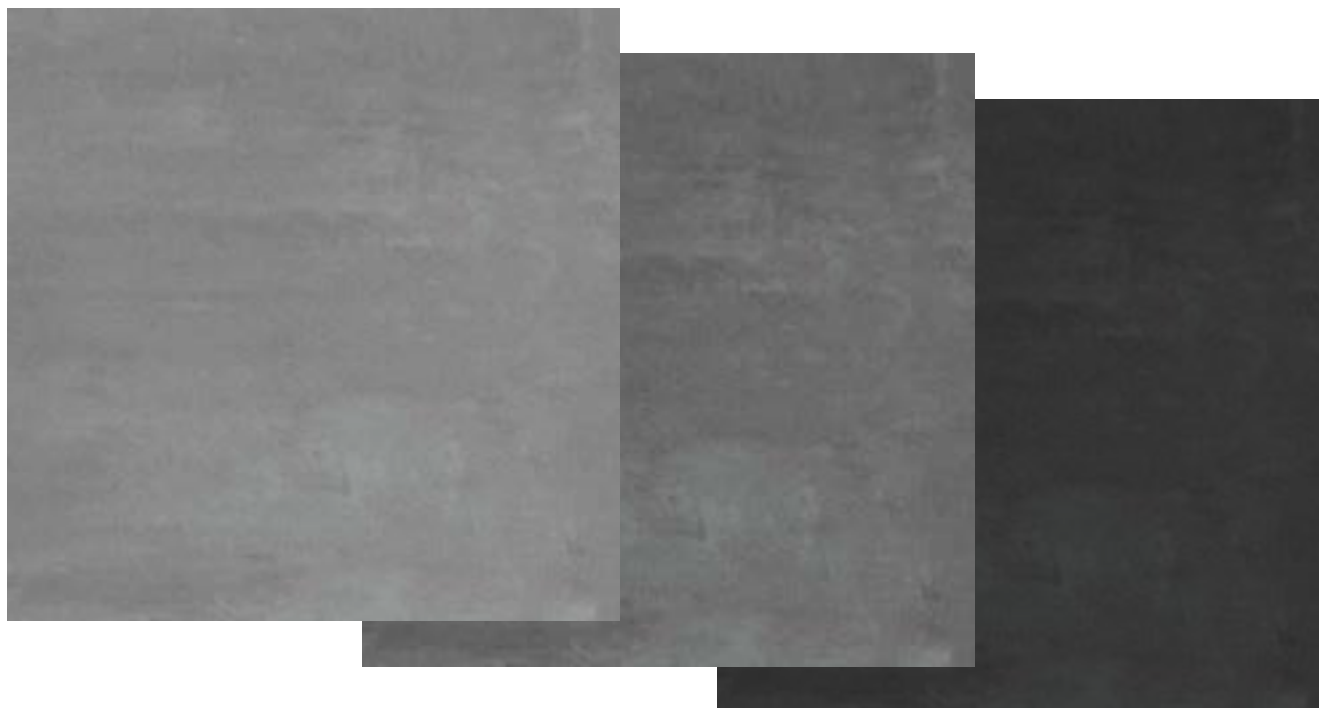

215XV6060  AP01

215YV6060

215ZV6060

 grey green

 315SP, BP

 6060

 0560

 1060

 1560

 R

 c2c

 18

 R10

 c2c

 18

Terra Tones

vloertegels / carreaux de sol / Bodenfliesen / floor tiles
 Ultragres ongeglazuurd / non émaillé / unglasiert / unglazed
 vorstbestand / ingélif / frostsicher / frost proof

no.	mm	inch	pieces/ m ²	pieces/ m ¹	pieces/ box	boxes/ pallet	pieces/ pallet	m ² / pallet	kg/ m ²	kg/ pallet
216XV - 216ZV	597x597x12	23.50x23.50x0.47	2,8	-	3 = 1,071 m ²	30	90	32,1	27,8	918

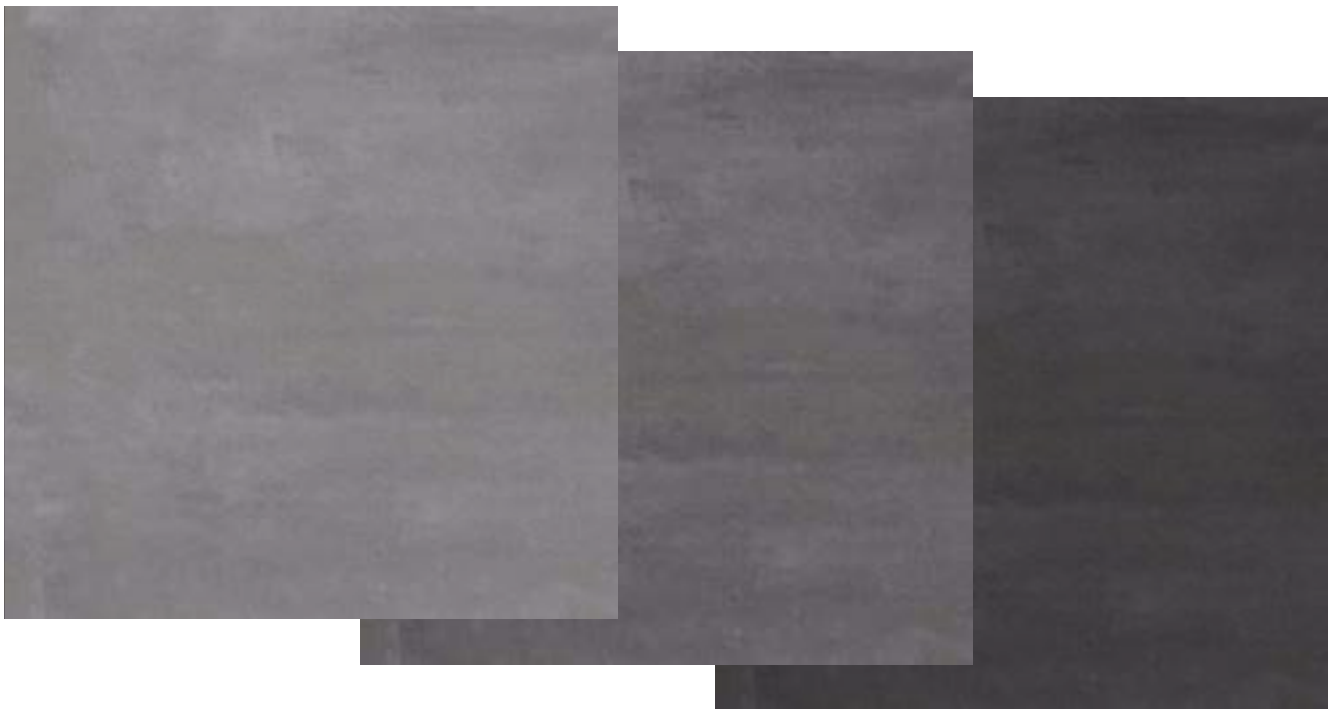

216XV6060  AP01

216YV6060

216ZV6060

 anthracite

 316SP, BP, 116VM, 116HM, TVG, HV





   R10 C2C 12

Terra Tones

vloertegels / carreaux de sol / Bodenfliesen / floor tiles
 Ultragres ongeglazuurd / non émaillé / unglasiert / unglazed
 vorstbestand / ingélif / frostsicher / frost proof

no.	mm	inch	pieces/ m ²	pieces/ m ¹	pieces/ box	boxes/ pallet	pieces/ pallet	m ² / pallet	kg/ m ²	kg/ pallet
266XV - 266ZV	597x597x12	23.50x23.50x0.47	2,8	-	3 = 1,071 m ²	30	90	32,1	27,8	918

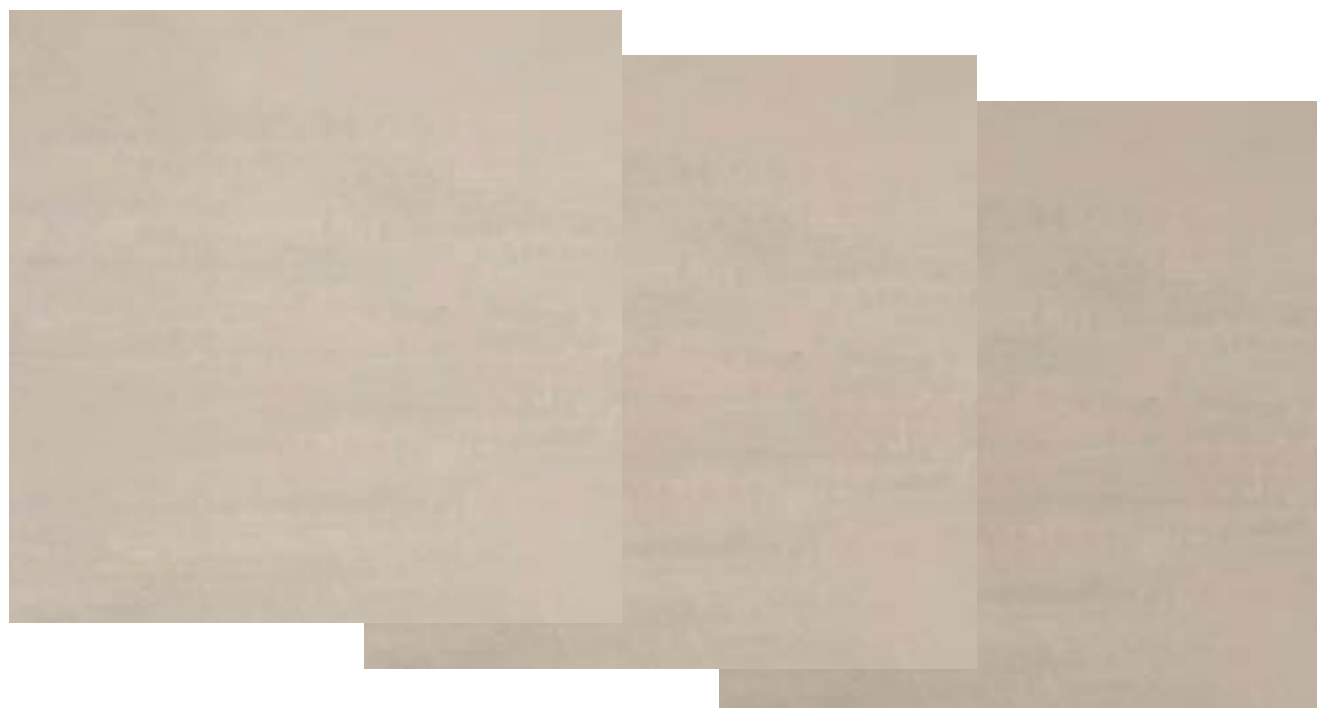

266XV6060  AP01

266YV6060

266ZV6060



light beige



BP, 166VM, 166HM



Elke kleurgroep telt lichte (X), midden (Y) en donkere (Z) tonen. Per kleurgroep worden, per formaat, willekeurige hoeveelheden van X, Y en Z geleverd.
 Chaque groupe de couleur compte des tons clairs (X), moyens (Y) et foncés (Z). Les quantités aléatoires de X, Y et Z sont fournies par format et par groupe de couleur.
 Jede Farbgruppe enthält helle (X), mittlere (Y) und dunkle (Z) Töne. Pro Farbgruppe sind pro Format zufälligen Mengen von X, Y und Z erhältlich.
 Each colour group has light (X), medium (Y), and dark (Z) shades. For each colour group and size, random quantities of X, Y, and Z are supplied.

Voor tegelpatronen zie www.mosa.com/nl-nl/grids.
 Pour des motifs de carreaux, nous vous invitons à consulter www.mosa.com/fr-fr/trames.
 Für Verlegemuster siehe www.mosa.com/de-de/raster.
 For tile patterns, see www.mosa.com/en/grids or www.mosa.com/en-us/grids.

Voor uitgebreide verwerkingsadviezen zie www.mosa.com.
 On peut trouver toutes les directives de pose sur www.mosa.com.
 Für komplette Hinweise zur Verarbeitung siehe www.mosa.com.
 The complete guidelines for installation can be found on www.mosa.com.



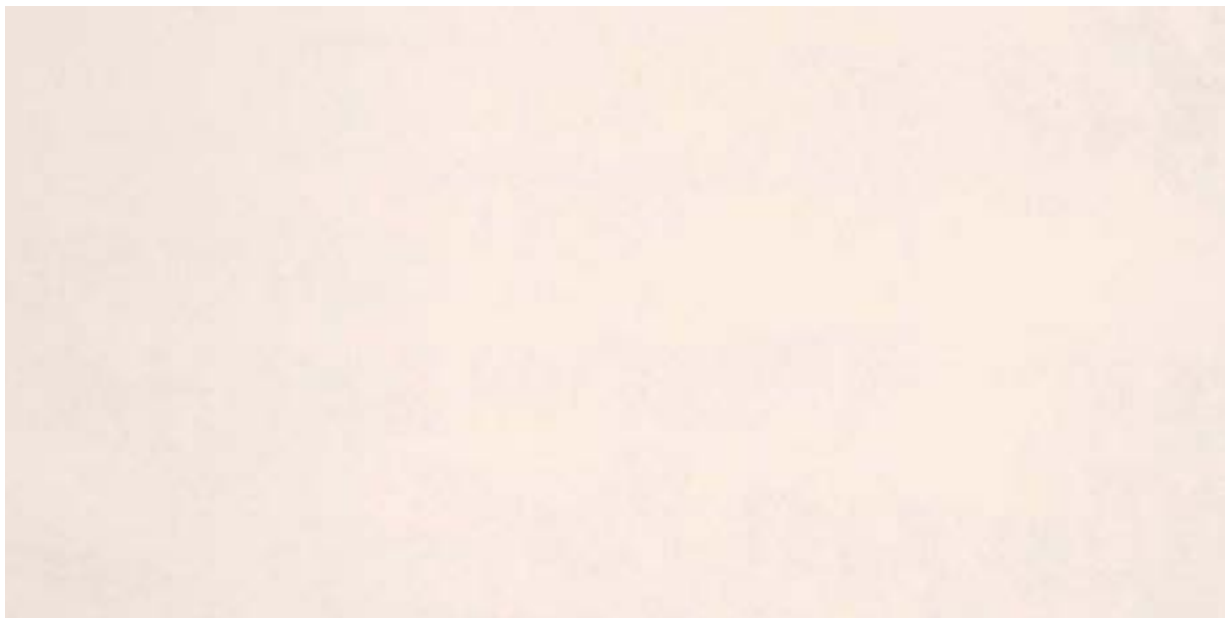

Core Collection Terra

vloertegels / carreaux de sol / Bodenfliesen / floor tiles
 Ultragres ongeglazuurd / non émaillé / unglasiert / unglazed
 vorstbestand / ingélif / frostsicher / frost proof

no.	mm	inch	pieces/ m ²	pieces/ m ¹	pieces/ box	boxes/ pallet	pieces/ pallet	m ² / pallet	kg/ m ²	kg/ pallet
200V - 203V	597x1197x13	23.50x47.13x0.51	1,4	-	1 = 0,714 m ²	35	35	25,0	30,5	787





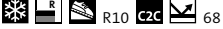

200V60120 

-  cool porcelain white
-  BP, TVG, HV
-  60 60 90
-  60 10 15 20
-  R10 C2C 68

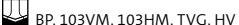

203V60120 

-  cool black
-  BP, 103VM, 103HM, TVG, HV
-  15 30 60 90
-  60 10 15 20
-  R10 C2C 8



Core Collection Terra

vloertegels / carreaux de sol / Bodenfliesen / floor tiles
Ultragres ongeglazuurd / non émaillé / unglasiert / unglazed
vorstbestand / ingélif / frostsicher / frost proof

no.	mm	inch	pieces/ m ²	pieces/ m ¹	pieces/ box	boxes/ pallet	pieces/ pallet	m ² / pallet	kg/ m ²	kg/ pallet
204V - 206V	597x1197x13	23.50x47.13x0.51	1,4	-	1 = 0,714 m ²	35	35	25,0	30,5	787



204V60120 BP12



mid warm grey



304SP, BP, 104VM, 104HM, TVG, HV



206V60120 BP12



mid grey



306SP, BP, TVG, HV

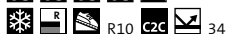



Core Collection Terra

vloertegels / carreaux de sol / Bodenfliesen / floor tiles
 Ultragres ongeglazuurd / non émaillé / unglasiert / unglazed
 vorstbestand / ingélif / frostsicher / frost proof

no.	mm	inch	pieces/ m ²	pieces/ m ¹	pieces/ box	boxes/ pallet	pieces/ pallet	m ² / pallet	kg/ m ²	kg/ pallet
211V - 216V	597x1197x13	23.50x47.13x0.51	1,4	-	1 = 0,714 m ²	35	35	25,0	30,5	787



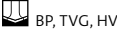

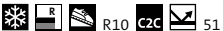

211V60120 

 avalon beige





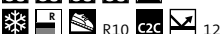

216V60120 

 anthracite







Core Collection Terra

vloertegels / carreaux de sol / Bodenfliesen / floor tiles
Ultragres oneglazuurd / non émaillé / unglasiert / unglazed
vorstbestand / ingélif / frostsicher / frost proof

no.	mm	inch	pieces/ m ²	pieces/ m ¹	pieces/ box	boxes/ pallet	pieces/ pallet	m ² / pallet	kg/ m ²	kg/ pallet
225V - 226V	597x1197x13	23.50x47.13x0.51	1,4	-	1 = 0,714 m ²	35	35	25,0	30,5	787



225V60120 BP12

light cool grey
 BP, 125VM, 125HM
 13 50 60 60 90
 60 60 60 60
 R10 C2C 40



226V60120 BP12

mid cool grey
 BP, 126VM, 126HM, TVG, HV
 13 50 60 60 90
 60 60 60 60
 R10 C2C 23













Core Collection Terra

vloertegels / carreaux de sol / Bodenfliesen / floor tiles
 Ultragres ongeglazuurd / non émaillé / unglasiert / unglazed
 vorstbestand / ingélif / frostsicher / frost proof

no.	mm	inch	pieces/ m ²	pieces/ m ¹	pieces/ box	boxes/ pallet	pieces/ pallet	m ² / pallet	kg/ m ²	kg/ pallet
227V - 229V	597x1197x13	23.50x47.13x0.51	1,4	-	1 = 0,714 m ²	35	35	25,0	30,5	787















227V60120 

-  dark cool grey
-  BP, TVG, HV
-   
-     
-   



229V60120 

-  dark warm grey
-  BP, TVG, HV
-    
-    
-   



Core Collection Terra

vloertegels / carreaux de sol / Bodenfliesen / floor tiles
Ultragres ongeglazuurd / non émaillé / unglasiert / unglazed
vorstbestand / ingélif / frostsicher / frost proof

no.	mm	inch	pieces/ m ²	pieces/ m ¹	pieces/ box	boxes/ pallet	pieces/ pallet	m ² / pallet	kg/ m ²	kg/ pallet
262V - 265V	597x1197x13	23.50x47.13x0.51	1,4	-	1 = 0,714 m ²	35	35	25,0	30,5	787



262V60120 BP12

- light grey beige
- 362SP, BP, TVG, HV
- 60 60 60
- 60 60 60 60
- R10 C2C 61



265V60120 BP12

- dark grey brown
- BP, TVG
- 60 60
- 60 60 60 60
- R10 C2C 9

Voor de bijbehorende reliëftegelcollectie Core Collection Terra in dit formaat zie pagina's 201 - 203.
Pour la collection en relief correspondante Core Collection Terra dans ce format voir pages 201 - 203.
Für die dazugehörige Reliefkollektion Core Collection Terra in diesen Format siehe Seiten 201 - 203.
For the matching Core Collection Terra relief tiles in this size see pages 201 - 203.

Voor tegelpatronen zie www.mosa.com/nl-nl/grids.
Pour des motifs de carreaux, nous vous invitons à consulter www.mosa.com/fr-fr/trames.
Für Verlegemuster siehe www.mosa.com/de-de/raster.
For tile patterns, see www.mosa.com/en/grids or www.mosa.com/en-us/grids.













Core Collection Solids

vloertegels / carreaux de sol / Bodenfliesen / floor tiles
 Ultragres ongeglazuurd / non émaillé / unglasiert / unglazed
 vorstbestand / ingélif / frostsicher / frost proof

no.	mm	inch	pieces/ m ²	pieces/ m ¹	pieces/ box	boxes/ pallet	pieces/ pallet	m ² / pallet	kg/ m ²	kg/ pallet
5102V - 5108V	897x897x13	35.31x35.31x0.51	1,23	-	1 = 0,813 m ²	36	36	29,3	30,2	909











5102V9090 

 vivid white
 5002SP, BP, TVG, HV
 
   
    R10 c2c 58











5104V9090 

 clay grey
 BP, TVG, HV
 
    R10 c2c 28















5106V9090 

 agate grey
 5006SP, BP, TVG, HV
 
    R10 c2c 15



5108V9090 

 stone grey
 5008SP, BP, TVG, HV
 
   
    R10 c2c 33













Core Collection Solids

vloertegels / carreaux de sol / Bodenfliesen / floor tiles
 Ultragres ongeglazuurd / non émaillé / unglasiert / unglazed
 vorstbestand / ingélif / frostsicher / frost proof

no.	mm	inch	pieces/ m ²	pieces/ m ¹	pieces/ box	boxes/ pallet	pieces/ pallet	m ² / pallet	kg/ m ²	kg/ pallet
5110V - 5112V	897x897x13	35.31x35.31x0.51	1,23	-	1 = 0,813 m ²	36	36	29,3	30,2	909















5110V9090  BP02

 basalt grey
 5010SP, BP, TVG, HV
 
   
   R10   16



5112V9090  BP02

 graphite black
 BP, TVG, HV
 
   
   R10   10

90/90 Core Collection Terra

vloertegels / carreaux de sol / Bodenfliesen / floor tiles
 Ultragres ongeglazuurd / non émaillé / unglasiert / unglazed
 vorstbestand / ingélif / frostsicher / frost proof

no.	mm	inch	pieces/ m ²	pieces/ m ¹	pieces/ box	boxes/ pallet	pieces/ pallet	m ² / pallet	kg/ m ²	kg/ pallet
200V - 206V	897x897x13	35.31x35.31x0.51	1,23	-	1 = 0,813 m ²	36	36	29,3	30,2	909



200V9090 € BP12

M cool porcelain white
 BP, TVG, HV
 R10 C2C 68



203V9090 € BP12

M cool black
 BP, 103VM, 103HM, TVG, HV
 R10 C2C 8



204V9090 € BP12

M mid warm grey
 304SP, BP, 104VM, 104HM, TVG, HV
 R10 C2C 22



206V9090 € BP12

M mid grey
 306SP, BP, TVG, HV
 R10 C2C 34

90 Core Collection Terra

vloertegels / carreaux de sol / Bodenfliesen / floor tiles
 Ultragres ongeglazuurd / non émaillé / unglasiert / unglazed
 vorstbestand / ingélif / frostsicher / frost proof

no.	mm	inch	pieces/ m ²	pieces/ m ¹	pieces/ box	boxes/ pallet	pieces/ pallet	m ² / pallet	kg/ m ²	kg/ pallet
216V - 229V	897x897x13	35.31x35.31x0.51	1,23	-	1 = 0,813 m ²	36	36	29,3	30,2	909



216V9090 € BP12

M anthracite
 316SP, BP, 116VM, 116HM, TVG, HV
 15 30 60 60 120
 60 10 15 30 60
 R10 C2C 12



225V9090 € BP12

M light cool grey
 BP, 125VM, 125HM
 15 30 60 60 120
 60 10 15 30 60
 R10 C2C 40

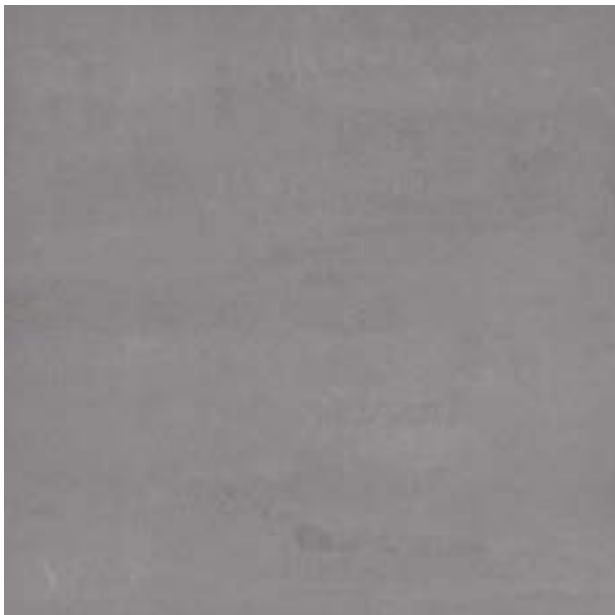

226V9090 € BP12

M mid cool grey
 BP, 126VM, 126HM, TVG, HV
 15 30 60 60 120
 60 10 15 30 60
 R10 C2C 23



229V9090 € BP12

M dark warm grey
 BP, TVG, HV
 15 30 60 60 120
 60 10 15 30 60
 R10 C2C 14



Core Collection Terra

vloertegels / carreaux de sol / Bodenfliesen / floor tiles
 Ultragres ongeglazuurd / non émaillé / unglasiert / unglazed
 vorstbestand / ingélif / frostsicher / frost proof

no.	mm	inch	pieces/ m ²	pieces/ m ¹	pieces/ box	boxes/ pallet	pieces/ pallet	m ² / pallet	kg/ m ²	kg/ pallet
262V	897x897x13	35.31x35.31x0.51	1,23	-	1 = 0,813 m ²	36	36	29,3	30,2	909

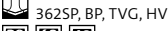

262V9090  BP12

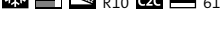
 light grey beige





Voor de bijbehorende reliëftegelcollectie Core Collection Terra in dit formaat zie pagina's 201 - 203.
 Pour la collection en relief correspondante Core Collection Terra dans ce format voir pages 201 - 203.
 Für die dazugehörige Reliefkollektion Core Collection Terra in diesen Format siehe Seiten 201 - 203.
 For the matching Core Collection Terra relief tiles in this size see pages 201 - 203.

Mosa Stage

vloertegels / carreaux de sol / Bodenfliesen / floor tiles
 Ultragres ongeglazuurd / non émaillé / unglasiert / unglazed
 vorstbestand / ingélif / frostsicher / frost proof

no.	mm	inch	pieces/ m ²	pieces/ m ¹	pieces/ box	boxes/ pallet	pieces/ pallet	m ² / pallet	kg/ m ²	kg/ pallet
3502CR - 3508CR	897x897x13	35.31x35.31x0.51	1,23	-	1 = 0,813 m ²	36	36	29,3	30,2	909









3502CR9090  BP12

 cool white
 BP, TCG
 60
 R10  B  C2C  60









3504CR9090  BP12

 light cool grey
 BP, TCG
 60
 R10  B  C2C  38









3506CR9090  BP12

 dark cool grey
 BP, TCG
 60
 R10  B  C2C  17



3508CR9090  BP12

 light warm grey
 BP, TCG
 60
 R10  B  C2C  42





Mosa Stage

vloertegels / carreaux de sol / Bodenfliesen / floor tiles
 Ultragres ongeglazuurd / non émaillé / unglasiert / unglazed
 vorstbestand / ingélif / frostsicher / frost proof

no.	mm	inch	pieces/ m ²	pieces/ m ¹	pieces/ box	boxes/ pallet	pieces/ pallet	m ² / pallet	kg/ m ²	kg/ pallet
3510CR - 3516CR	897x897x13	35.31x35.31x0.51	1,23	-	1 = 0,813 m ²	36	36	29,3	30,2	909







3510CR9090  BP12

 mid warm grey









3512CR9090  BP12

 dark plum brown









3514CR9090  BP12

 sienna beige





3516CR9090  BP12

 paynes grey





Mosa Stage

vloertegels / carreaux de sol / Bodenfliesen / floor tiles
 Ultragres oneglazuurd / non émaillé / unglasiert / unglazed
 vorstbestand / ingélif / frostsicher / frost proof

no.	mm	inch	pieces/ m ²	pieces/ m ¹	pieces/ box	boxes/ pallet	pieces/ pallet	m ² / pallet	kg/ m ²	kg/ pallet
3518CR	897x897x13	35.31x35.31x0.51	1,23	-	1 = 0,813 m ²	36	36	29,3	30,2	909



3518CR9090  BP12

 ivory black

 BP, TCG

    R10 B C2C 8

Voor tegelpatronen zie www.mosa.com/nl-nl/grids.
 Pour des motifs de carreaux, nous vous invitons à consulter www.mosa.com/fr-fr/trames.
 Für Verlegemuster siehe www.mosa.com/de-de/raster.
 For tile patterns, see www.mosa.com/en-grids or www.mosa.com/en-us/grids.

Shapes

Size details in millimeter

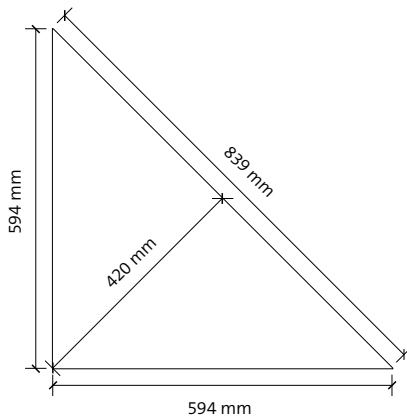

Triangle A
839 x 420 mm

driehoek A
triangle A
Dreieck A
triangle A

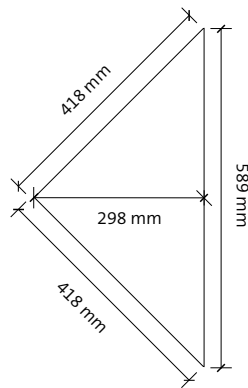

Triangle B
589 x 298 mm

driehoek B
triangle B
Dreieck B
triangle B

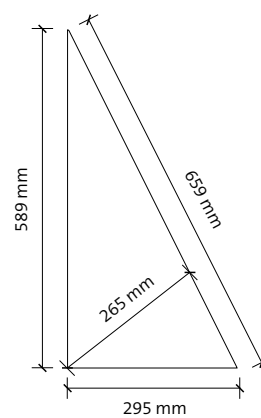

Triangle C1
659 x 265 mm

driehoek C1
triangle C1
Dreieck C1
triangle C1

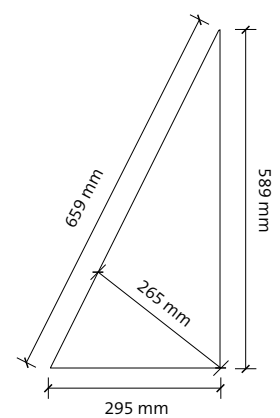

Triangle C2
265 x 659 mm

driehoek C2
triangle C2
Dreieck C2
triangle C2

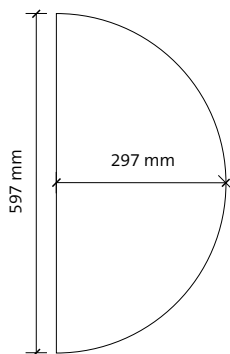

Semi circle D
597 x 297 mm

halve cirkel D
demi-cercle D
Halbkreis D
semi circle D

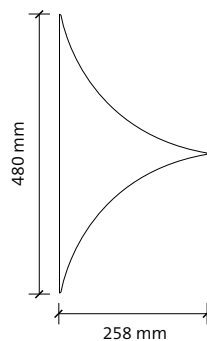

Circle link E
480 x 258 mm

cirkel link E
liaison de cercle E
Kreisverbindung E
circle link E

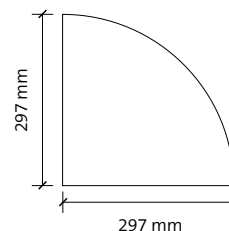

Quarter circle F
297 x 297 mm

kwart cirkel F
quart de cercle F
Viertelkreis F
quarter circle F

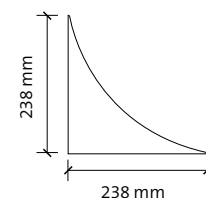

Circle end E1
238 x 238 mm

cirkeleinde E1
n de cercle E1
Kreise E1
circle end E1

Voor tegelpatronen zie www.mosa.com/nl-nl/grids.
Pour des motifs de carreaux, nous vous invitons à consulter www.mosa.com/fr-fr/trames.
Für Verlegemuster siehe www.mosa.com/de-de/raster.
For tile patterns, see www.mosa.com/en-grids or www.mosa.com/en-us/grids.

Voor uitgebreide verwerkingsadviezen zie www.mosa.com.
On peut trouver toutes les directives de pose sur www.mosa.com.
Für komplette Hinweise zur Verarbeitung siehe www.mosa.com.
The complete guidelines for installation can be found on www.mosa.com.

Shapes

Size details in inches

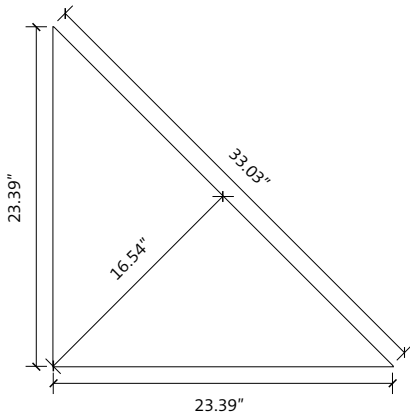

Triangle A
33.03 x 16.54 inch

driehoek A
triangle A
Dreieck A
triangle A

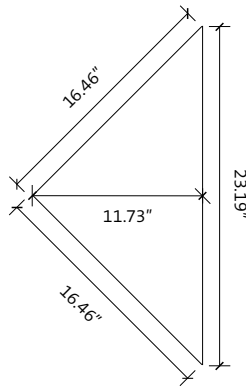

Triangle B
23.19 x 11.73 inch

driehoek B
triangle B
Dreieck B
triangle B

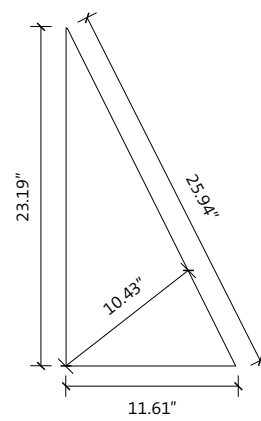

Triangle C1
25.94 x 10.43 inch

driehoek C1
triangle C1
Dreieck C1
triangle C1

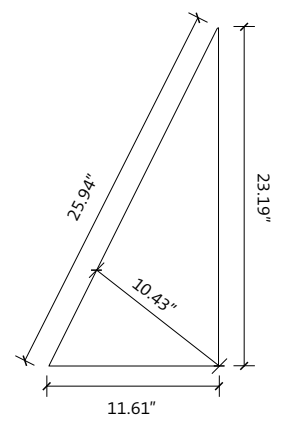

Triangle C2
10.43 x 25.94 inch

driehoek C2
triangle C2
Dreieck C2
triangle C2

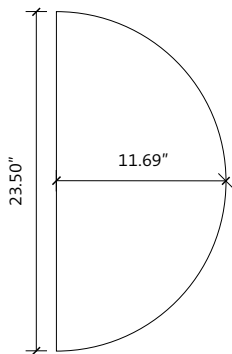

Semi circle D
23.50 x 11.69 inch

halve cirkel D
demi-cercle D
Halbkreis D
semi circle D

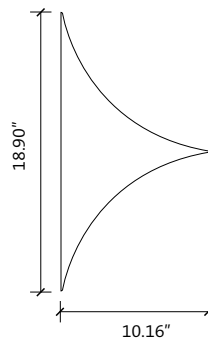

Circle link E
18.90 x 10.16 inch

cirkel link E
liaison de cercle E
Kreisverbindung E
circle link E

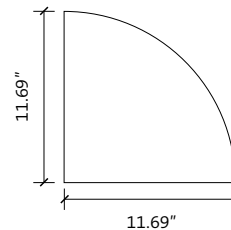

Quarter circle F
11.69 x 11.69 inch

kwart cirkel F
quart de cercle F
Viertelkreis F
quarter circle F

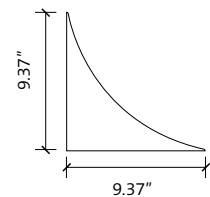

Circle end E1
9.37 x 9.37 inch

cirkeleinde E1
n de cercle E1
Kreisende E1
circle end E1

Voor tegelpatronen zie www.mosa.com/nl-nl/grids.
Pour des motifs de carreaux, nous vous invitons à consulter www.mosa.com/fr-fr/trames.
Für Verlegemuster siehe www.mosa.com/de-de/raster.
For tile patterns, see www.mosa.com/en-grids or www.mosa.com/en-us/grids.

Voor uitgebreide verwerkingsadviezen zie www.mosa.com.
On peut trouver toutes les directives de pose sur www.mosa.com.
Für komplette Hinweise zur Verarbeitung siehe www.mosa.com.
The complete guidelines for installation can be found on www.mosa.com.

Core Collection Quartz

vloertegels / carreaux de sol / Bodenfliesen / floor tiles
 Ultragres ongeglazuurd / non émaillé / unglasiert / unglazed
 vorstbestand / ingélif / frostsicher / frost proof

no.	mm	inch	pieces/ m ²	pieces/ m ¹	pieces/ box	boxes/ pallet	pieces/ pallet	m ² / pallet	kg/ m ²	kg/ pallet
4101V	839x420x12	33.03x16.54x0.47	5,65	-	5 = 0,88 m ²	26	130	23,0	31,2	743
4101V	589x298x12	23.19x11.73x0.47	11,38	-	10 = 0,88 m ²	26	260	22,8	31,0	732
4101V	659x265x12	25.94x10.43x0.47	11,41	-	10 = 0,88 m ²	26	260	22,8	31,2	736
4101V	265x659x12	10.43x25.94x0.47	11,41	-	10 = 0,88 m ²	26	260	22,8	31,2	736
4101V	597x297x12	23.50x11.69x0.47	7,19	-	5 = 0,70 m ²	39	195	27,1	29,8	833
4101V	480x258x12	18.90x10.16x0.47	27,41	-	5 = 0,18 m ²	39	195	7,1	38,8	300
4101V	297x297x12	11.69x11.69x0.47	14,47	-	10 = 0,69 m ²	39	390	26,9	29,8	827
4101V	238x238x12	9.37x9.37x0.47	56,05	-	10 = 0,18 m ²	39	390	7,0	38,7	296



4101V8442 



4101V5930 



4101V6627 



4101V2766 



4101V5929 



4101V4926 



4101V2929 



4101V2424 

 chalk white

 BP

 60

 R10

 C2C

 64

Voor meer informatie over shapes zie pagina's 163 en 164.
 Pour plus d'informations sur les shapes voir pages 163 et 164.
 Weitere Informationen zu Shapes finden Sie auf Seiten 163 und 164.
 For more information about shapes see pages 163 and 164.

Core Collection Quartz

vloertegels / carreaux de sol / Bodenfliesen / floor tiles
 Ultragres ongeglazuurd / non émaillé / unglasiert / unglazed
 vorstbestand / ingélif / frostsicher / frost proof

no.	mm	inch	pieces/ m ²	pieces/ m ¹	pieces/ box	boxes/ pallet	pieces/ pallet	m ² / pallet	kg/ m ²	kg/ pallet
4102V	839x420x12	33.03x16.54x0.47	5,65	-	5 = 0,88 m ²	26	130	23,0	31,2	743
4102V	589x298x12	23.19x11.73x0.47	11,38	-	10 = 0,88 m ²	26	260	22,8	31,0	732
4102V	659x265x12	25.94x10.43x0.47	11,41	-	10 = 0,88 m ²	26	260	22,8	31,2	736
4102V	265x659x12	10.43x25.94x0.47	11,41	-	10 = 0,88 m ²	26	260	22,8	31,2	736
4102V	597x297x12	23.50x11.69x0.47	7,19	-	5 = 0,70 m ²	39	195	27,1	29,8	833
4102V	480x258x12	18.90x10.16x0.47	27,41	-	5 = 0,18 m ²	39	195	7,1	38,8	300
4102V	297x297x12	11.69x11.69x0.47	14,47	-	10 = 0,69 m ²	39	390	26,9	29,8	827
4102V	238x238x12	9.37x9.37x0.47	56,05	-	10 = 0,18 m ²	39	390	7,0	38,7	296



4102V8442  AP48



4102V5930  AP49



4102V6627  AP49



4102V2766  AP49



4102V5929  AP50



4102V4926  AP50



4102V2929  AP50



4102V2424  D 103

 slate grey

 BP

 60

   39

Voor meer informatie over shapes zie pagina's 163 en 164.
 Pour plus d'informations sur les shapes voir pages 163 et 164.
 Weitere Informationen zu Shapes finden Sie auf Seiten 163 und 164.
 For more information about shapes see pages 163 and 164.

Core Collection Quartz

vloertegels / carreaux de sol / Bodenfliesen / floor tiles
 Ultragres ongeglazuurd / non émaillé / unglasiert / unglazed
 vorstbestand / ingélif / frostsicher / frost proof

no.	mm	inch	pieces/ m ²	pieces/ m ¹	pieces/ box	boxes/ pallet	pieces/ pallet	m ² / pallet	kg/ m ²	kg/ pallet
4104V	839x420x12	33.03x16.54x0.47	5,65	-	5 = 0,88 m ²	26	130	23,0	31,2	743
4104V	589x298x12	23.19x11.73x0.47	11,38	-	10 = 0,88 m ²	26	260	22,8	31,0	732
4104V	659x265x12	25.94x10.43x0.47	11,41	-	10 = 0,88 m ²	26	260	22,8	31,2	736
4104V	265x659x12	10.43x25.94x0.47	11,41	-	10 = 0,88 m ²	26	260	22,8	31,2	736
4104V	597x297x12	23.50x11.69x0.47	7,19	-	5 = 0,70 m ²	39	195	27,1	29,8	833
4104V	480x258x12	18.90x10.16x0.47	27,41	-	5 = 0,18 m ²	39	195	7,1	38,8	300
4104V	297x297x12	11.69x11.69x0.47	14,47	-	10 = 0,69 m ²	39	390	26,9	29,8	827
4104V	238x238x12	9.37x9.37x0.47	56,05	-	10 = 0,18 m ²	39	390	7,0	38,7	296

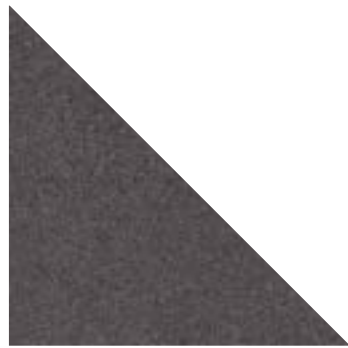

4104V8442  AP48

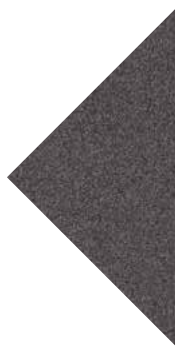

4104V5930  AP49



4104V6627  AP49



4104V2766  AP49



4104V5929  AP50

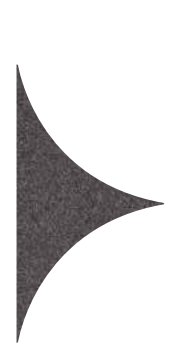

4104V4926  AP50



4104V2929  AP50



4104V2424  D 103

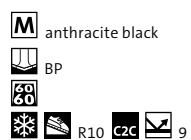

Voor meer informatie over shapes zie pagina's 163 en 164.
 Pour plus d'informations sur les shapes voir pages 163 et 164.
 Weitere Informationen zu Shapes finden Sie auf Seiten 163 und 164.
 For more information about shapes see pages 163 and 164.

Core Collection Solids

vloertegels / carreaux de sol / Bodenfliesen / floor tiles
 Ultragres ongeglazuurd / non émaillé / unglasiert / unglazed
 vorstbestand / ingélif / frostsicher / frost proof

no.	mm	inch	pieces/ m ²	pieces/ m ¹	pieces/ box	boxes/ pallet	pieces/ pallet	m ² / pallet	kg/ m ²	kg/ pallet
5102V	839x420x12	33.03x16.54x0.47	5,65	-	5 = 0,88 m ²	26	130	23,0	31,2	743
5102V	589x298x12	23.19x11.73x0.47	11,38	-	10 = 0,88 m ²	26	260	22,8	31,0	732
5102V	659x265x12	25.94x10.43x0.47	11,41	-	10 = 0,88 m ²	26	260	22,8	31,2	736
5102V	265x659x12	10.43x25.94x0.47	11,41	-	10 = 0,88 m ²	26	260	22,8	31,2	736
5102V	597x297x12	23.50x11.69x0.47	7,19	-	5 = 0,70 m ²	39	195	27,1	29,8	833
5102V	480x258x12	18.90x10.16x0.47	27,41	-	5 = 0,18 m ²	39	195	7,1	38,8	300
5102V	297x297x12	11.69x11.69x0.47	14,47	-	10 = 0,69 m ²	39	390	26,9	29,8	827
5102V	238x238x12	9.37x9.37x0.47	56,05	-	10 = 0,18 m ²	39	390	7,0	38,7	296



5102V8442  AP48



5102V5930  AP49



5102V6627  AP49



5102V2766  AP49



5102V5929  AP50







5102V4926  AP50



5102V2929  AP50

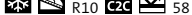

5102V2424  D 103

 vivid white
 5002SP, BP, TVG, HV
 60 60 60
 60 60 60
 R10 C2C 58

Voor meer informatie over shapes zie pagina's 163 en 164.
 Pour plus d'informations sur les shapes voir pages 163 et 164.
 Weitere Informationen zu Shapes finden Sie auf Seiten 163 und 164.
 For more information about shapes see pages 163 and 164.

Core Collection Solids

vloertegels / carreaux de sol / Bodenfliesen / floor tiles
 Ultragres ongeglazuurd / non émaillé / unglasiert / unglazed
 vorstbestand / ingélif / frostsicher / frost proof

no.	mm	inch	pieces/ m ²	pieces/ m ¹	pieces/ box	boxes/ pallet	pieces/ pallet	m ² / pallet	kg/ m ²	kg/ pallet
5108V	839x420x12	33.03x16.54x0.47	5,65	-	5 = 0,88 m ²	26	130	23,0	31,2	743
5108V	589x298x12	23.19x11.73x0.47	11,38	-	10 = 0,88 m ²	26	260	22,8	31,0	732
5108V	659x265x12	25.94x10.43x0.47	11,41	-	10 = 0,88 m ²	26	260	22,8	31,2	736
5108V	265x659x12	10.43x25.94x0.47	11,41	-	10 = 0,88 m ²	26	260	22,8	31,2	736
5108V	597x297x12	23.50x11.69x0.47	7,19	-	5 = 0,70 m ²	39	195	27,1	29,8	833
5108V	480x258x12	18.90x10.16x0.47	27,41	-	5 = 0,18 m ²	39	195	7,1	38,8	300
5108V	297x297x12	11.69x11.69x0.47	14,47	-	10 = 0,69 m ²	39	390	26,9	29,8	827
5108V	238x238x12	9.37x9.37x0.47	56,05	-	10 = 0,18 m ²	39	390	7,0	38,7	296



5108V8442 € AP48



5108V5930 € AP49



5108V6627 € AP49



5108V2766 € AP49



5108V5929 € AP50

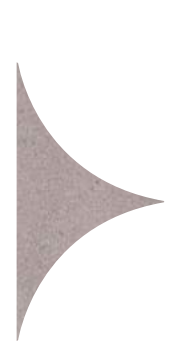

5108V4926 € AP50



5108V2929 € AP50



5108V2424 € D 103

M stone grey
 S008SP, BP, TVG, HV

 R10 C2C

Voor meer informatie over shapes zie pagina's 163 en 164.
 Pour plus d'informations sur les shapes voir pages 163 et 164.
 Weitere Informationen zu Shapes finden Sie auf Seiten 163 und 164.
 For more information about shapes see pages 163 and 164.

Core Collection Solids

vloertegels / carreaux de sol / Bodenfliesen / floor tiles
 Ultragres ongeglazuurd / non émaillé / unglasiert / unglazed
 vorstbestand / ingélif / frostsicher / frost proof

no.	mm	inch	pieces/ m ²	pieces/ m ¹	pieces/ box	boxes/ pallet	pieces/ pallet	m ² / pallet	kg/ m ²	kg/ pallet
5110V	839x420x12	33.03x16.54x0.47	5,65	-	5 = 0,88 m ²	26	130	23,0	31,2	743
5110V	589x298x12	23.19x11.73x0.47	11,38	-	10 = 0,88 m ²	26	260	22,8	31,0	732
5110V	659x265x12	25.94x10.43x0.47	11,41	-	10 = 0,88 m ²	26	260	22,8	31,2	736
5110V	265x659x12	10.43x25.94x0.47	11,41	-	10 = 0,88 m ²	26	260	22,8	31,2	736
5110V	597x297x12	23.50x11.69x0.47	7,19	-	5 = 0,70 m ²	39	195	27,1	29,8	833
5110V	480x258x12	18.90x10.16x0.47	27,41	-	5 = 0,18 m ²	39	195	7,1	38,8	300
5110V	297x297x12	11.69x11.69x0.47	14,47	-	10 = 0,69 m ²	39	390	26,9	29,8	827
5110V	238x238x12	9.37x9.37x0.47	56,05	-	10 = 0,18 m ²	39	390	7,0	38,7	296



5110V8442  AP48



5110V5930  AP49



5110V6627  AP49



5110V2766  AP49



5110V5929  AP50





5110V4926  AP50



5110V2929  AP50

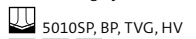

5110V2424  D 103

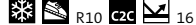
 basalt grey





Voor meer informatie over shapes zie pagina's 163 en 164.
 Pour plus d'informations sur les shapes voir pages 163 et 164.
 Weitere Informationen zu Shapes finden Sie auf Seiten 163 und 164.
 For more information about shapes see pages 163 and 164.



Core Collection Solids

vloertegels / carreaux de sol / Bodenfliesen / floor tiles
Ultragres ongeglazuurd / non émaillé / unglasiert / unglazed
vorstbestand / ingélif / frostsicher / frost proof

no.	mm	inch	pieces/ m ²	pieces/ m ¹	pieces/ box	boxes/ pallet	pieces/ pallet	m ² / pallet	kg/ m ²	kg/ pallet
5112V	839x420x12	33.03x16.54x0.47	5,65	-	5 = 0,88 m ²	26	130	23,0	31,2	743
5112V	589x298x12	23.19x11.73x0.47	11,38	-	10 = 0,88 m ²	26	260	22,8	31,0	732
5112V	659x265x12	25.94x10.43x0.47	11,41	-	10 = 0,88 m ²	26	260	22,8	31,2	736
5112V	265x659x12	10.43x25.94x0.47	11,41	-	10 = 0,88 m ²	26	260	22,8	31,2	736
5112V	597x297x12	23.50x11.69x0.47	7,19	-	5 = 0,70 m ²	39	195	27,1	29,8	833
5112V	480x258x12	18.90x10.16x0.47	27,41	-	5 = 0,18 m ²	39	195	7,1	38,8	300
5112V	297x297x12	11.69x11.69x0.47	14,47	-	10 = 0,69 m ²	39	390	26,9	29,8	827
5112V	238x238x12	9.37x9.37x0.47	56,05	-	10 = 0,18 m ²	39	390	7,0	38,7	296



5112V8442 € AP48

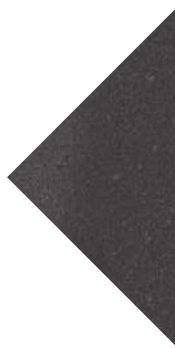

5112V5930 € AP49



5112V6627 € AP49



5112V2766 € AP49



5112V5929 € AP50



5112V4926 € AP50

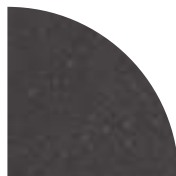

5112V2929 € AP50



5112V2424 € D 103

graphite black

BP, TVG, HV

60x60, 30x60, 60x30

60x60, 30x60, 60x30

R10 C2C 10

Voor meer informatie over shapes zie pagina's 163 en 164.
Pour plus d'informations sur les shapes voir pages 163 et 164.
Weitere Informationen zu Shapes finden Sie auf Seiten 163 und 164.
For more information about shapes see pages 163 and 164.

Core Collection Solids

vloertegels / carreaux de sol / Bodenfliesen / floor tiles
 Ultragres ongeglazuurd / non émaillé / unglasiert / unglazed
 vorstbestand / ingélif / frostsicher / frost proof

no.	mm	inch	pieces/ m ²	pieces/ m ¹	pieces/ box	boxes/ pallet	pieces/ pallet	m ² / pallet	kg/ m ²	kg/ pallet
5126V	839x420x12	33.03x16.54x0.47	5,65	-	5 = 0,88 m ²	26	130	23,0	31,2	743
5126V	589x298x12	23.19x11.73x0.47	11,38	-	10 = 0,88 m ²	26	260	22,8	31,0	732
5126V	659x265x12	25.94x10.43x0.47	11,41	-	10 = 0,88 m ²	26	260	22,8	31,2	736
5126V	265x659x12	10.43x25.94x0.47	11,41	-	10 = 0,88 m ²	26	260	22,8	31,2	736
5126V	597x297x12	23.50x11.69x0.47	7,19	-	5 = 0,70 m ²	39	195	27,1	29,8	833
5126V	480x258x12	18.90x10.16x0.47	27,41	-	5 = 0,18 m ²	39	195	7,1	38,8	300
5126V	297x297x12	11.69x11.69x0.47	14,47	-	10 = 0,69 m ²	39	390	26,9	29,8	827
5126V	238x238x12	9.37x9.37x0.47	56,05	-	10 = 0,18 m ²	39	390	7,0	38,7	296



5126V8442  AP48



5126V5930  AP49



5126V6627  AP49



5126V2766  AP49



5126V5929  AP50



5126V4926  AP50

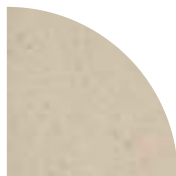

5126V2929  AP50



5126V2424  D 103

 natural beige

 BP, TVG, HV

 60

 60

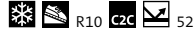
 R10 C2C 52

Voor meer informatie over shapes zie pagina's 163 en 164.

Pour plus d'informations sur les shapes voir pages 163 et 164.

Weitere Informationen zu Shapes finden Sie auf Seiten 163 und 164.

For more information about shapes see pages 163 and 164.

Core Collection Terra

vloertegels / carreaux de sol / Bodenfliesen / floor tiles
 Ultragres ongeglazuurd / non émaillé / unglasiert / unglazed
 vorstbestand / ingélif / frostsicher / frost proof

no.	mm	inch	pieces/ m ²	pieces/ m ¹	pieces/ box	boxes/ pallet	pieces/ pallet	m ² / pallet	kg/ m ²	kg/ pallet
200V	839x420x12	33.03x16.54x0.47	5,65	-	5 = 0,88 m ²	26	130	23,0	31,2	743
200V	589x298x12	23.19x11.73x0.47	11,38	-	10 = 0,88 m ²	26	260	22,8	31,0	732
200V	659x265x12	25.94x10.43x0.47	11,41	-	10 = 0,88 m ²	26	260	22,8	31,2	736
200V	265x659x12	10.43x25.94x0.47	11,41	-	10 = 0,88 m ²	26	260	22,8	31,2	736
200V	597x297x12	23.50x11.69x0.47	7,19	-	5 = 0,70 m ²	39	195	27,1	29,8	833
200V	480x258x12	18.90x10.16x0.47	27,41	-	5 = 0,18 m ²	39	195	7,1	38,8	300
200V	297x297x12	11.69x11.69x0.47	14,47	-	10 = 0,69 m ²	39	390	26,9	29,8	827
200V	238x238x12	9.37x9.37x0.47	56,05	-	10 = 0,18 m ²	39	390	7,0	38,7	296

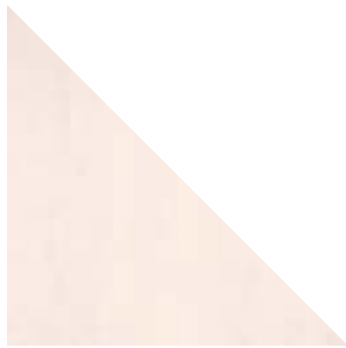

200V8442 € AP48



200V5930 € AP49



200V6627 € AP49



200V2766 € AP49



200V5929 € AP50

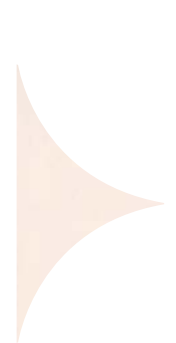

200V4926 € AP50



200V2929 € AP50



200V2424 € D 103

M cool porcelain white
 BP, TVG, HV
 R10 C2C 68

Voor meer informatie over shapes zie pagina's 163 en 164.
 Pour plus d'informations sur les shapes voir pages 163 et 164.
 Weitere Informationen zu Shapes finden Sie auf Seiten 163 und 164.
 For more information about shapes see pages 163 and 164.

Core Collection Terra

vloertegels / carreaux de sol / Bodenfliesen / floor tiles
 Ultragres ongeglazuurd / non émaillé / unglasiert / unglazed
 vorstbestand / ingélif / frostsicher / frost proof

no.	mm	inch	pieces/ m ²	pieces/ m ¹	pieces/ box	boxes/ pallet	pieces/ pallet	m ² / pallet	kg/ m ²	kg/ pallet
203V	839x420x12	33.03x16.54x0.47	5,65	-	5 = 0,88 m ²	26	130	23,0	31,2	743
203V	589x298x12	23.19x11.73x0.47	11,38	-	10 = 0,88 m ²	26	260	22,8	31,0	732
203V	659x265x12	25.94x10.43x0.47	11,41	-	10 = 0,88 m ²	26	260	22,8	31,2	736
203V	265x659x12	10.43x25.94x0.47	11,41	-	10 = 0,88 m ²	26	260	22,8	31,2	736
203V	597x297x12	23.50x11.69x0.47	7,19	-	5 = 0,70 m ²	39	195	27,1	29,8	833
203V	480x258x12	18.90x10.16x0.47	27,41	-	5 = 0,18 m ²	39	195	7,1	38,8	300
203V	297x297x12	11.69x11.69x0.47	14,47	-	10 = 0,69 m ²	39	390	26,9	29,8	827
203V	238x238x12	9.37x9.37x0.47	56,05	-	10 = 0,18 m ²	39	390	7,0	38,7	296



203V8442  AP48



203V5930  AP49



203V6627  AP49



203V2766  AP49



203V5929  AP50

















203V4926  AP50



203V2929  AP50



203V2424  D 103

 cool black
 BP, 103VM, 103HM, TVG, HV
 15  30  60  90  120  150
 60  70  15  30
 R10  C2C  8

Voor meer informatie over shapes zie pagina's 163 en 164.
 Pour plus d'informations sur les shapes voir pages 163 et 164.
 Weitere Informationen zu Shapes finden Sie auf Seiten 163 und 164.
 For more information about shapes see pages 163 and 164.

Core Collection Terra

vloertegels / carreaux de sol / Bodenfliesen / floor tiles
 Ultragres ongeglazuurd / non émaillé / unglasiert / unglazed
 vorstbestand / ingélif / frostsicher / frost proof

no.	mm	inch	pieces/ m ²	pieces/ m ¹	pieces/ box	boxes/ pallet	pieces/ pallet	m ² / pallet	kg/ m ²	kg/ pallet
206V	839x420x12	33.03x16.54x0.47	5,65	-	5 = 0,88 m ²	26	130	23,0	31,2	743
206V	589x298x12	23.19x11.73x0.47	11,38	-	10 = 0,88 m ²	26	260	22,8	31,0	732
206V	659x265x12	25.94x10.43x0.47	11,41	-	10 = 0,88 m ²	26	260	22,8	31,2	736
206V	265x659x12	10.43x25.94x0.47	11,41	-	10 = 0,88 m ²	26	260	22,8	31,2	736
206V	597x297x12	23.50x11.69x0.47	7,19	-	5 = 0,70 m ²	39	195	27,1	29,8	833
206V	480x258x12	18.90x10.16x0.47	27,41	-	5 = 0,18 m ²	39	195	7,1	38,8	300
206V	297x297x12	11.69x11.69x0.47	14,47	-	10 = 0,69 m ²	39	390	26,9	29,8	827
206V	238x238x12	9.37x9.37x0.47	56,05	-	10 = 0,18 m ²	39	390	7,0	38,7	296



206V8442 



206V5930 



206V6627 



206V2766 



206V5929 





206V4926 



206V2929 

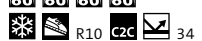

206V2424 

 mid grey



Voor meer informatie over shapes zie pagina's 163 en 164.
 Pour plus d'informations sur les shapes voir pages 163 et 164.
 Weitere Informationen zu Shapes finden Sie auf Seiten 163 und 164.
 For more information about shapes see pages 163 and 164.



Core Collection Terra

vloertegels / carreaux de sol / Bodenfliesen / floor tiles
Ultragres ongeglazuurd / non émaillé / unglasiert / unglazed
vorstbestand / ingélif / frostsicher / frost proof

no.	mm	inch	pieces/ m ²	pieces/ m ¹	pieces/ box	boxes/ pallet	pieces/ pallet	m ² / pallet	kg/ m ²	kg/ pallet
216V	839x420x12	33.03x16.54x0.47	5,65	-	5 = 0,88 m ²	26	130	23,0	31,2	743
216V	589x298x12	23.19x11.73x0.47	11,38	-	10 = 0,88 m ²	26	260	22,8	31,0	732
216V	659x265x12	25.94x10.43x0.47	11,41	-	10 = 0,88 m ²	26	260	22,8	31,2	736
216V	265x659x12	10.43x25.94x0.47	11,41	-	10 = 0,88 m ²	26	260	22,8	31,2	736
216V	597x297x12	23.50x11.69x0.47	7,19	-	5 = 0,70 m ²	39	195	27,1	29,8	833
216V	480x258x12	18.90x10.16x0.47	27,41	-	5 = 0,18 m ²	39	195	7,1	38,8	300
216V	297x297x12	11.69x11.69x0.47	14,47	-	10 = 0,69 m ²	39	390	26,9	29,8	827
216V	238x238x12	9.37x9.37x0.47	56,05	-	10 = 0,18 m ²	39	390	7,0	38,7	296



216V8442 AP48

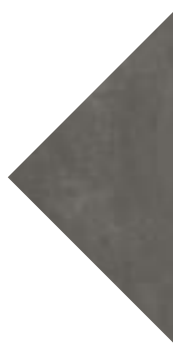

216V5930 AP49



216V6627 AP49



216V2766 AP49



216V5929 AP50

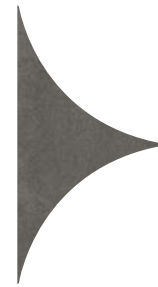

216V4926 AP50



216V2929 AP50

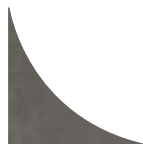

216V2424 D 103

anthracite

Voor meer informatie over shapes zie pagina's 163 en 164.

Pour plus d'informations sur les shapes voir pages 163 et 164.

Weitere Informationen zu Shapes finden Sie auf Seiten 163 und 164.

For more information about shapes see pages 163 and 164.

Core Collection Terra

vloertegels / carreaux de sol / Bodenfliesen / floor tiles
 Ultragres ongeglazuurd / non émaillé / unglasiert / unglazed
 vorstbestand / ingélif / frostsicher / frost proof

no.	mm	inch	pieces/ m ²	pieces/ m ¹	pieces/ box	boxes/ pallet	pieces/ pallet	m ² / pallet	kg/ m ²	kg/ pallet
222V	839x420x12	33.03x16.54x0.47	5,65	-	5 = 0,88 m ²	26	130	23,0	31,2	743
222V	589x298x12	23.19x11.73x0.47	11,38	-	10 = 0,88 m ²	26	260	22,8	31,0	732
222V	659x265x12	25.94x10.43x0.47	11,41	-	10 = 0,88 m ²	26	260	22,8	31,2	736
222V	265x659x12	10.43x25.94x0.47	11,41	-	10 = 0,88 m ²	26	260	22,8	31,2	736
222V	597x297x12	23.50x11.69x0.47	7,19	-	5 = 0,70 m ²	39	195	27,1	29,8	833
222V	480x258x12	18.90x10.16x0.47	27,41	-	5 = 0,18 m ²	39	195	7,1	38,8	300
222V	297x297x12	11.69x11.69x0.47	14,47	-	10 = 0,69 m ²	39	390	26,9	29,8	827
222V	238x238x12	9.37x9.37x0.47	56,05	-	10 = 0,18 m ²	39	390	7,0	38,7	296

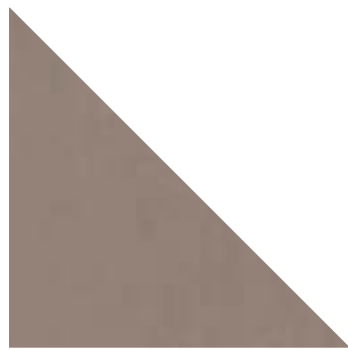

222V8442  AP48



222V5930  AP49



222V6627  AP49



222V2766  AP49



222V5929  AP50

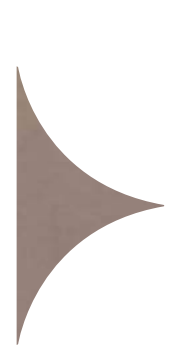









222V4926  AP50



222V2929  AP50



222V2424  D 103

 mid moss-grey
 BP
 60
 60
 60
 60
 R10
 C2C
 25

Voor meer informatie over shapes zie pagina's 163 en 164.
 Pour plus d'informations sur les shapes voir pages 163 et 164.
 Weitere Informationen zu Shapes finden Sie auf Seiten 163 und 164.
 For more information about shapes see pages 163 and 164.

Core Collection Terra

vloertegels / carreaux de sol / Bodenfliesen / floor tiles
 Ultragres ongeglazuurd / non émaillé / unglasiert / unglazed
 vorstbestand / ingélif / frostsicher / frost proof

no.	mm	inch	pieces/ m ²	pieces/ m ¹	pieces/ box	boxes/ pallet	pieces/ pallet	m ² / pallet	kg/ m ²	kg/ pallet
225V	839x420x12	33.03x16.54x0.47	5,65	-	5 = 0,88 m ²	26	130	23,0	31,2	743
225V	589x298x12	23.19x11.73x0.47	11,38	-	10 = 0,88 m ²	26	260	22,8	31,0	732
225V	659x265x12	25.94x10.43x0.47	11,41	-	10 = 0,88 m ²	26	260	22,8	31,2	736
225V	265x659x12	10.43x25.94x0.47	11,41	-	10 = 0,88 m ²	26	260	22,8	31,2	736
225V	597x297x12	23.50x11.69x0.47	7,19	-	5 = 0,70 m ²	39	195	27,1	29,8	833
225V	480x258x12	18.90x10.16x0.47	27,41	-	5 = 0,18 m ²	39	195	7,1	38,8	300
225V	297x297x12	11.69x11.69x0.47	14,47	-	10 = 0,69 m ²	39	390	26,9	29,8	827
225V	238x238x12	9.37x9.37x0.47	56,05	-	10 = 0,18 m ²	39	390	7,0	38,7	296

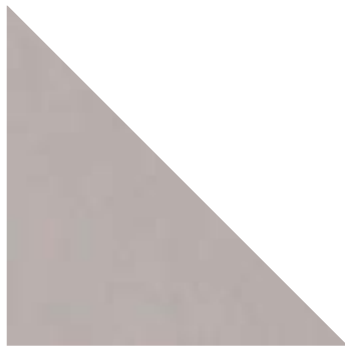

225V8442  AP48



225V5930  AP49



225V6627  AP49



225V2766  AP49



225V5929  AP50

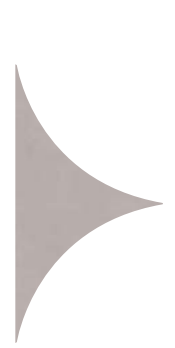

225V4926  AP50









225V2929  AP50







225V2424  D 103

 light cool grey

 BP, 125VM, 125HM

 15  30  60  60  60  90

 60  60  60  60

 R10  C2C  40

Voor meer informatie over shapes zie pagina's 163 en 164.

Pour plus d'informations sur les shapes voir pages 163 et 164.

Weitere Informationen zu Shapes finden Sie auf Seiten 163 und 164.

For more information about shapes see pages 163 and 164.

Core Collection Terra

vloertegels / carreaux de sol / Bodenfliesen / floor tiles
 Ultragres ongeglazuurd / non émaillé / unglasiert / unglazed
 vorstbestand / ingélif / frostsicher / frost proof

no.	mm	inch	pieces/ m ²	pieces/ m ¹	pieces/ box	boxes/ pallet	pieces/ pallet	m ² / pallet	kg/ m ²	kg/ pallet
227V	839x420x12	33.03x16.54x0.47	5,65	-	5 = 0,88 m ²	26	130	23,0	31,2	743
227V	589x298x12	23.19x11.73x0.47	11,38	-	10 = 0,88 m ²	26	260	22,8	31,0	732
227V	659x265x12	25.94x10.43x0.47	11,41	-	10 = 0,88 m ²	26	260	22,8	31,2	736
227V	265x659x12	10.43x25.94x0.47	11,41	-	10 = 0,88 m ²	26	260	22,8	31,2	736
227V	597x297x12	23.50x11.69x0.47	7,19	-	5 = 0,70 m ²	39	195	27,1	29,8	833
227V	480x258x12	18.90x10.16x0.47	27,41	-	5 = 0,18 m ²	39	195	7,1	38,8	300
227V	297x297x12	11.69x11.69x0.47	14,47	-	10 = 0,69 m ²	39	390	26,9	29,8	827
227V	238x238x12	9.37x9.37x0.47	56,05	-	10 = 0,18 m ²	39	390	7,0	38,7	296

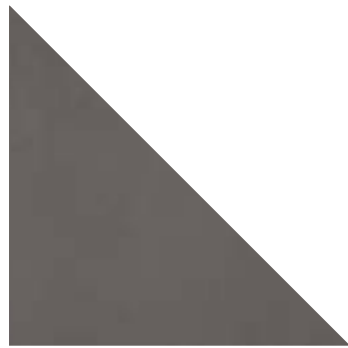

227V8442  AP48



227V5930  AP49

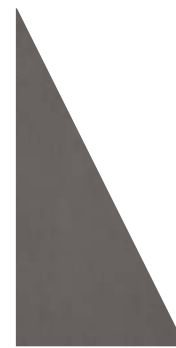

227V6627  AP49



227V2766  AP49



227V5929  AP50







227V4926  AP50



227V2929  AP50

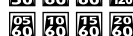

227V2424  D 103

 dark cool grey





Voor meer informatie over shapes zie pagina's 163 en 164.
 Pour plus d'informations sur les shapes voir pages 163 et 164.
 Weitere Informationen zu Shapes finden Sie auf Seiten 163 und 164.
 For more information about shapes see pages 163 and 164.



Core Collection Terra

vloertegels / carreaux de sol / Bodenfliesen / floor tiles
Ultragres ongeglazuurd / non émaillé / unglasiert / unglazed
vorstbestand / ingélif / frostsicher / frost proof

no.	mm	inch	pieces/ m ²	pieces/ m ¹	pieces/ box	boxes/ pallet	pieces/ pallet	m ² / pallet	kg/ m ²	kg/ pallet
239V	839x420x12	33.03x16.54x0.47	5,65	-	5 = 0,88 m ²	26	130	23,0	31,2	743
239V	589x298x12	23.19x11.73x0.47	11,38	-	10 = 0,88 m ²	26	260	22,8	31,0	732
239V	659x265x12	25.94x10.43x0.47	11,41	-	10 = 0,88 m ²	26	260	22,8	31,2	736
239V	265x659x12	10.43x25.94x0.47	11,41	-	10 = 0,88 m ²	26	260	22,8	31,2	736
239V	597x297x12	23.50x11.69x0.47	7,19	-	5 = 0,70 m ²	39	195	27,1	29,8	833
239V	480x258x12	18.90x10.16x0.47	27,41	-	5 = 0,18 m ²	39	195	7,1	38,8	300
239V	297x297x12	11.69x11.69x0.47	14,47	-	10 = 0,69 m ²	39	390	26,9	29,8	827
239V	238x238x12	9.37x9.37x0.47	56,05	-	10 = 0,18 m ²	39	390	7,0	38,7	296



239V8442 AP48



239V5930 AP49



239V6627 AP49



239V2766 AP49



239V5929 AP50



239V4926 AP50

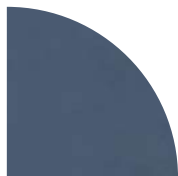

239V2929 AP50



239V2424 D 103

blue

BP

60

60

60

60

R10

C2C

12

Voor meer informatie over shapes zie pagina's 163 en 164.

Pour plus d'informations sur les shapes voir pages 163 et 164.

Weitere Informationen zu Shapes finden Sie auf Seiten 163 und 164.

For more information about shapes see pages 163 and 164.

Core Collection Terra

vloertegels / carreaux de sol / Bodenfliesen / floor tiles
 Ultragres ongeglazuurd / non émaillé / unglasiert / unglazed
 vorstbestand / ingélif / frostsicher / frost proof

no.	mm	inch	pieces/ m ²	pieces/ m ¹	pieces/ box	boxes/ pallet	pieces/ pallet	m ² / pallet	kg/ m ²	kg/ pallet
262V	839x420x12	33.03x16.54x0.47	5,65	-	5 = 0,88 m ²	26	130	23,0	31,2	743
262V	589x298x12	23.19x11.73x0.47	11,38	-	10 = 0,88 m ²	26	260	22,8	31,0	732
262V	659x265x12	25.94x10.43x0.47	11,41	-	10 = 0,88 m ²	26	260	22,8	31,2	736
262V	265x659x12	10.43x25.94x0.47	11,41	-	10 = 0,88 m ²	26	260	22,8	31,2	736
262V	597x297x12	23.50x11.69x0.47	7,19	-	5 = 0,70 m ²	39	195	27,1	29,8	833
262V	480x258x12	18.90x10.16x0.47	27,41	-	5 = 0,18 m ²	39	195	7,1	38,8	300
262V	297x297x12	11.69x11.69x0.47	14,47	-	10 = 0,69 m ²	39	390	26,9	29,8	827
262V	238x238x12	9.37x9.37x0.47	56,05	-	10 = 0,18 m ²	39	390	7,0	38,7	296



262V8442 € AP48



262V5930 € AP49



262V6627 € AP49



262V2766 € AP49



262V5929 € AP50



262V4926 € AP50



262V2929 € AP50



262V2424 € D 103

M light grey beige
 362SP, BP, TVG, HV

 R10 C2C 61

Voor meer informatie over shapes zie pagina's 163 en 164.
 Pour plus d'informations sur les shapes voir pages 163 et 164.
 Weitere Informationen zu Shapes finden Sie auf Seiten 163 und 164.
 For more information about shapes see pages 163 and 164.

Core Collection Terra

vloertegels / carreaux de sol / Bodenfliesen / floor tiles
 Ultragres ongeglazuurd / non émaillé / unglasiert / unglazed
 vorstbestand / ingélif / frostsicher / frost proof

no.	mm	inch	pieces/ m ²	pieces/ m ¹	pieces/ box	boxes/ pallet	pieces/ pallet	m ² / pallet	kg/ m ²	kg/ pallet
263V	839x420x12	33.03x16.54x0.47	5,65	-	5 = 0,88 m ²	26	130	23,0	31,2	743
263V	589x298x12	23.19x11.73x0.47	11,38	-	10 = 0,88 m ²	26	260	22,8	31,0	732
263V	659x265x12	25.94x10.43x0.47	11,41	-	10 = 0,88 m ²	26	260	22,8	31,2	736
263V	265x659x12	10.43x25.94x0.47	11,41	-	10 = 0,88 m ²	26	260	22,8	31,2	736
263V	597x297x12	23.50x11.69x0.47	7,19	-	5 = 0,70 m ²	39	195	27,1	29,8	833
263V	480x258x12	18.90x10.16x0.47	27,41	-	5 = 0,18 m ²	39	195	7,1	38,8	300
263V	297x297x12	11.69x11.69x0.47	14,47	-	10 = 0,69 m ²	39	390	26,9	29,8	827
263V	238x238x12	9.37x9.37x0.47	56,05	-	10 = 0,18 m ²	39	390	7,0	38,7	296



263V8442  AP48



263V5930  AP49



263V6627  AP49



263V2766  AP49



263V5929  AP50



263V4926  AP50



263V2929  AP50



263V2424  D 103

 grey beige

 BP

 60 60

 60 60

 60 60

 60 60

 R10  C2C  31

Voor meer informatie over shapes zie pagina's 163 en 164.
 Pour plus d'informations sur les shapes voir pages 163 et 164.
 Weitere Informationen zu Shapes finden Sie auf Seiten 163 und 164.
 For more information about shapes see pages 163 and 164.

Core Collection Terra

vloertegels / carreaux de sol / Bodenfliesen / floor tiles
 Ultragres ongeglazuurd / non émaillé / unglasiert / unglazed
 vorstbestand / ingélif / frostsicher / frost proof

no.	mm	inch	pieces/ m ²	pieces/ m ¹	pieces/ box	boxes/ pallet	pieces/ pallet	m ² / pallet	kg/ m ²	kg/ pallet
264V	839x420x12	33.03x16.54x0.47	5,65	-	5 = 0,88 m ²	26	130	23,0	31,2	743
264V	589x298x12	23.19x11.73x0.47	11,38	-	10 = 0,88 m ²	26	260	22,8	31,0	732
264V	659x265x12	25.94x10.43x0.47	11,41	-	10 = 0,88 m ²	26	260	22,8	31,2	736
264V	265x659x12	10.43x25.94x0.47	11,41	-	10 = 0,88 m ²	26	260	22,8	31,2	736
264V	597x297x12	23.50x11.69x0.47	7,19	-	5 = 0,70 m ²	39	195	27,1	29,8	833
264V	480x258x12	18.90x10.16x0.47	27,41	-	5 = 0,18 m ²	39	195	7,1	38,8	300
264V	297x297x12	11.69x11.69x0.47	14,47	-	10 = 0,69 m ²	39	390	26,9	29,8	827
264V	238x238x12	9.37x9.37x0.47	56,05	-	10 = 0,18 m ²	39	390	7,0	38,7	296



264V8442 



264V5930 



264V6627 



264V2766 



264V5929 

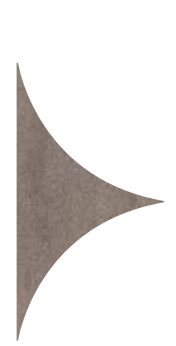

















264V4926 



264V2929 



264V2424 

 grey brown
 BP 164VM, 164HM
 F15
 F30
 F60
 F90
 F120
 F150
 F180
 F210
 F240
 F270
 F300
 R10
 C2C
 15

Voor meer informatie over shapes zie pagina's 163 en 164.
 Pour plus d'informations sur les shapes voir pages 163 et 164.
 Weitere Informationen zu Shapes finden Sie auf Seiten 163 und 164.
 For more information about shapes see pages 163 and 164.





Core Collection Solids

vloertegels / carreaux de sol / Bodenfliesen / floor tiles
 Ultragres ongeglazuurd / non émaillé / unglasiert / unglazed
 vorstbestand / ingélif / frostsicher / frost proof

no.	mm	inch	pieces/ m ²	pieces/ m ¹	pieces/ box	boxes/ pallet	pieces/ pallet	m ² / pallet	kg/ m ²	kg/ pallet
5102V - 5112V	97x597x12	3.82x23.50x0.47	16,7	-	6 = 0,36 m ²	108	648	38,8	27,2	1.080
5102V - 5112V	197x597x12	7.76x23.50x0.47	8,3	-	6 = 0,721 m ²	45	270	32,5	27,7	925
5102V - 5112V	397x597x12	15.63x23.50x0.47	4,16	-	3 = 0,72 m ²	45	135	32,5	26,3	880







5102V1060 (10x60 cm) € BP04
 5102V2060 (20x60 cm) € BP04
 5102V4060 (40x60 cm) € BP04

 vivid white
 5002SP, BP, TVG, HV

 R10 C2C 58







5108V1060 (10x60 cm) € BP04
 5108V2060 (20x60 cm) € BP04
 5108V4060 (40x60 cm) € BP04

 stone grey
 5008SP, BP, TVG, HV

 R10 C2C 33







5110V1060 (10x60 cm) € BP04
 5110V2060 (20x60 cm) € BP04
 5110V4060 (40x60 cm) € BP04

 basalt grey
 5010SP, BP, TVG, HV

 R10 C2C 16



5112V1060 (10x60 cm) € BP04
 5112V2060 (20x60 cm) € BP04
 5112V4060 (40x60 cm) € BP04

 graphite black
 BP, TVG, HV

 R10 C2C 10

10 x 60 cm / 4 x 24 inch

20 x 60 cm / 8 x 24 inch

40 x 60 cm / 16 x 24 inch



Core Collection Solids

vloertegels / carreaux de sol / Bodenfliesen / floor tiles
 Ultragres ongeglazuurd / non émaillé / unglasiert / unglazed
 vorstbestand / ingéelif / frostsicher / frost proof

no.	mm	inch	pieces/ m ²	pieces/ m ¹	pieces/ box	boxes/ pallet	pieces/ pallet	m ² / pallet	kg/ m ²	kg/ pallet
5120V - 5126V	97x597x12	3.82x23.50x0.47	16,7	-	6 = 0,36 m ²	108	648	38,8	27,2	1.080
5120V - 5126V	197x597x12	7.76x23.50x0.47	8,3	-	6 = 0,721 m ²	45	270	32,5	27,7	925
5120V - 5126V	397x597x12	15.63x23.50x0.47	4,16	-	3 = 0,72 m ²	45	135	32,5	26,3	880



5120V1060 (10x60 cm) € BP04
 5120V2060 (20x60 cm) € BP04
 5120V4060 (40x60 cm) € BP04



jade grey



5020SP, BP, TVG, HV



R10 C2C 25

5126V1060 (10x60 cm) € BP04
 5126V2060 (20x60 cm) € BP04
 5126V4060 (40x60 cm) € BP04



natural beige



BP, TVG, HV



R10 C2C 52

Voor tegelpatronen zie www.mosa.com/nl-nl/grids.
 Pour des motifs de carreaux, nous vous invitons à consulter www.mosa.com/fr-fr/trames.
 Für Verlegemuster siehe www.mosa.com/de-de/raster.
 For tile patterns, see www.mosa.com/en-us/grids or www.mosa.com/en-us/grids.

Voor uitgebreide verwerkingsadviezen zie www.mosa.com.
 On peut trouver toutes les directives de pose sur www.mosa.com.
 Für komplette Hinweise zur Verarbeitung siehe www.mosa.com.
 The complete guidelines for installation can be found on www.mosa.com.

10 x 60 cm / 4 x 24 inch

20 x 60 cm / 8 x 24 inch

40 x 60 cm / 16 x 24 inch



Core Collection Terra

vloertegels / carreaux de sol / Bodenfliesen / floor tiles
 Ultragres ongeglazuurd / non émaillé / unglasiert / unglazed
 vorstbestand / ingélif / frostsicher / frost proof

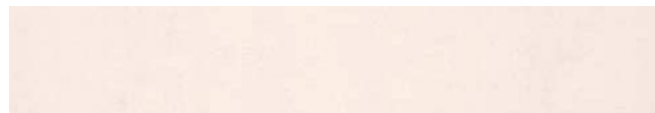
no.	mm	inch	pieces/ m ²	pieces/ m ¹	pieces/ box	boxes/ pallet	pieces/ pallet	m ² / pallet	kg/ m ²	kg/ pallet
200V - 216V	47x597x12	1.85x23.50x0.47	33,3	-	24 = 0,721 m ²	56	1.344	40,4	26,5	1.096
200V - 216V	97x597x12	3.82x23.50x0.47	16,7	-	12 = 0,721 m ²	56	672	40,4	27,2	1.119
200V - 216V	147x597x12	5.79x23.50x0.47	11,1	-	8 = 0,721 m ²	56	448	40,4	27,0	1.115
200V - 216V	197x597x12	7.76x23.50x0.47	8,3	-	6 = 0,721 m ²	45	270	32,5	27,7	925



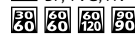

- 200V560 (5x60 cm) € BP17
- 200V1060 (10x60 cm) € BP17
- 200V1560 (15x60 cm) € BP17
- 200V2060 (20x60 cm) € BP17

M cool porcelain white
 BP, TVG, HV





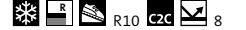

- 203V560 (5x60 cm) € BP17
- 203V1060 (10x60 cm) € BP17
- 203V1560 (15x60 cm) € BP17
- 203V2060 (20x60 cm) € BP17

M cool black
 BP, 103VM, 103HM, TVG, HV



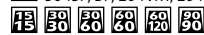

- 204V560 (5x60 cm) € BP17
- 204V1060 (10x60 cm) € BP17
- 204V1560 (15x60 cm) € BP17
- 204V2060 (20x60 cm) € BP17

M mid warm grey
 304SP, BP, 104VM, 104HM, TVG, HV







- 206V560 (5x60 cm) € BP17
- 206V1060 (10x60 cm) € BP17
- 206V1560 (15x60 cm) € BP17
- 206V2060 (20x60 cm) € BP17

M mid grey
 306SP, BP, TVG, HV





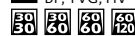



- 211V560 (5x60 cm) € BP17
- 211V1060 (10x60 cm) € BP17
- 211V1560 (15x60 cm) € BP17
- 211V2060 (20x60 cm) € BP17

M avalon beige
 BP, TVG, HV





- 216V560 (5x60 cm) € BP17
- 216V1060 (10x60 cm) € BP17
- 216V1560 (15x60 cm) € BP17
- 216V2060 (20x60 cm) € BP17

M anthracite
 316SP, BP, 116VM, 116HM, TVG, HV



5 x 60 cm / 2 x 24 inch

10 x 60 cm / 4 x 24 inch

15 x 60 cm / 6 x 24 inch

20 x 60 cm / 8 x 24 inch



Core Collection Terra

vloertegels / carreaux de sol / Bodenfliesen / floor tiles
Ultragres ongeglazuurd / non émaillé / unglasiert / unglazed
vorstbestand / ingélif / frostsicher / frost proof

no.	mm	inch	pieces/ m ²	pieces/ m ¹	pieces/ box	boxes/ pallet	pieces/ pallet	m ² / pallet	kg/ m ²	kg/ pallet
222V - 239V	47x597x12	1.85x23.50x0.47	33,3	-	24 = 0,721 m ²	56	1.344	40,4	26,5	1.096
222V - 239V	97x597x12	3.82x23.50x0.47	16,7	-	12 = 0,721 m ²	56	672	40,4	27,2	1.119
222V - 239V	147x597x12	5.79x23.50x0.47	11,1	-	8 = 0,721 m ²	56	448	40,4	27,0	1.115
222V - 239V	197x597x12	7.76x23.50x0.47	8,3	-	6 = 0,721 m ²	45	270	32,5	27,7	925



- 222V560 (5x60 cm) € BP17
- 222V1060 (10x60 cm) € BP17
- 222V1560 (15x60 cm) € BP17
- 222V2060 (20x60 cm) € BP17

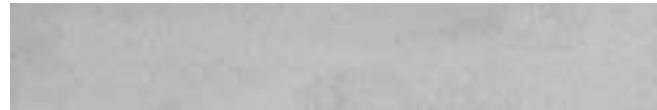
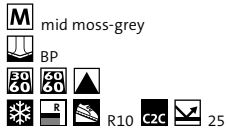

- 225V560 (5x60 cm) € BP17
- 225V1060 (10x60 cm) € BP17
- 225V1560 (15x60 cm) € BP17
- 225V2060 (20x60 cm) € BP17

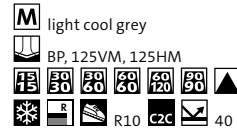

- 226V560 (5x60 cm) € BP17
- 226V1060 (10x60 cm) € BP17
- 226V1560 (15x60 cm) € BP17
- 226V2060 (20x60 cm) € BP17

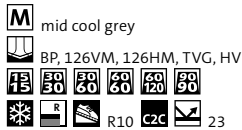

- 227V560 (5x60 cm) € BP17
- 227V1060 (10x60 cm) € BP17
- 227V1560 (15x60 cm) € BP17
- 227V2060 (20x60 cm) € BP17

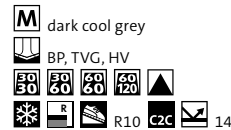

- 229V560 (5x60 cm) € BP17
- 229V1060 (10x60 cm) € BP17
- 229V1560 (15x60 cm) € BP17
- 229V2060 (20x60 cm) € BP17

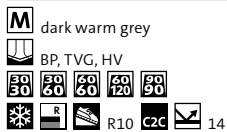

- 239V560 (5x60 cm) € BP17
- 239V1060 (10x60 cm) € BP17
- 239V1560 (15x60 cm) € BP17
- 239V2060 (20x60 cm) € BP17

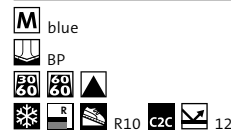

5 x 60 cm / 2 x 24 inch

10 x 60 cm / 4 x 24 inch

15 x 60 cm / 6 x 24 inch

20 x 60 cm / 8 x 24 inch

Core Collection Terra

vloertegels / carreaux de sol / Bodenfliesen / floor tiles
 Ultragres ongeglazuurd / non émaillé / unglasiert / unglazed
 vorstbestand / ingélif / frostsicher / frost proof

no.	mm	inch	pieces/ m ²	pieces/ m ¹	pieces/ box	boxes/ pallet	pieces/ pallet	m ² / pallet	kg/ m ²	kg/ pallet
262V - 270V	47x597x12	1.85x23.50x0.47	33,3	-	12 = 0,36 m ²	108	1.296	38,9	26,5	1.058
262V - 270V	97x597x12	3.82x23.50x0.47	16,7	-	6 = 0,36 m ²	108	648	38,8	27,2	1.080
262V - 270V	147x597x12	5.79x23.50x0.47	11,1	-	8 = 0,721 m ²	56	448	40,4	27,0	1.115
262V - 270V	197x597x12	7.76x23.50x0.47	8,3	-	6 = 0,721 m ²	45	270	32,5	27,7	925



262V560 (5x60 cm) € BP17
 262V1060 (10x60 cm) € BP17
 262V1560 (15x60 cm) € BP17
 262V2060 (20x60 cm) € BP17



263V560 (5x60 cm) € BP17
 263V1060 (10x60 cm) € BP17
 263V1560 (15x60 cm) € BP17
 263V2060 (20x60 cm) € BP17

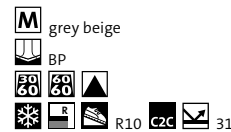

264V560 (5x60 cm) € BP17
 264V1060 (10x60 cm) € BP17
 264V1560 (15x60 cm) € BP17
 264V2060 (20x60 cm) € BP17

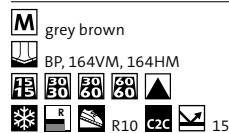

265V560 (5x60 cm) € BP17
 265V1060 (10x60 cm) € BP17
 265V1560 (15x60 cm) € BP17
 265V2060 (20x60 cm) € BP17

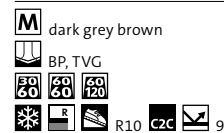

266V560 (5x60 cm) € BP17
 266V1060 (10x60 cm) € BP17
 266V1560 (15x60 cm) € BP17
 266V2060 (20x60 cm) € BP17

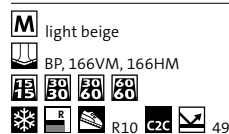

270V560 (5x60 cm) € BP17
 270V1060 (10x60 cm) € BP17
 270V1560 (15x60 cm) € BP17
 270V2060 (20x60 cm) € BP17

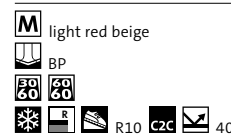

Voor tegelpatronen zie www.mosa.com/nl-nl/grids.
 Pour des motifs de carreaux, nous vous invitons à consulter www.mosa.com/fr-fr/trames.
 Für Verlegemuster siehe www.mosa.com/de-de/raster.
 For tile patterns, see www.mosa.com/en-grids or www.mosa.com/en-us/grids.

Voor uitgebreide verwerkingsadviezen zie www.mosa.com.
 On peut trouver toutes les directives de pose sur www.mosa.com.
 Für komplette Hinweise zur Verarbeitung siehe www.mosa.com.
 The complete guidelines for installation can be found on www.mosa.com.

5 x 60 cm / 2 x 24 inch

10 x 60 cm / 4 x 24 inch

15 x 60 cm / 6 x 24 inch

20 x 60 cm / 8 x 24 inch



Core Collection Terra

vloertegels / carreaux de sol / Bodenfliesen / floor tiles
Ultragres ongeglazuurd / non émaillé / unglasiert / unglazed
vorstbestand / ingélif / frostsicher / frost proof

no.	mm	inch	pieces/ m ²	pieces/ m ¹	pieces/ box	boxes/ pallet	pieces/ pallet	m ² / pallet	kg/ m ²	kg/ pallet
200RL - 216RL	47x597x12	1.85x23.50x0.47	33,3	-	24 = 0,721 m ²	56	1.344	40,4	26,5	1.096
200RL - 216RL	97x597x12	3.82x23.50x0.47	16,7	-	12 = 0,721 m ²	56	672	40,4	27,2	1.119
200RL - 216RL	147x597x12	5.79x23.50x0.47	11,1	-	8 = 0,721 m ²	56	448	40,4	27,0	1.115
200RL - 216RL	197x597x12	7.76x23.50x0.47	8,3	-	6 = 0,721 m ²	45	270	32,5	27,7	925



- 200RL560 (5x60 cm) € BP17
- 200RL1060 (10x60 cm) € BP17
- 200RL1560 (15x60 cm) € BP17
- 200RL2060 (20x60 cm) € BP17

M cool porcelain white
BP, TVG, HV
50 60 60
R11 C C2C 68
reliëftegels / carreaux en relief /
Relie iesen / relief tiles



- 203RL560 (5x60 cm) € BP17
- 203RL1060 (10x60 cm) € BP17
- 203RL1560 (15x60 cm) € BP17
- 203RL2060 (20x60 cm) € BP17

M cool black
BP, 103VM, 103HM, TVG, HV
50 60 60
R11 C C2C 9
reliëftegels / carreaux en relief /
Relie iesen / relief tiles



- 204RL560 (5x60 cm) € BP17
- 204RL1060 (10x60 cm) € BP17
- 204RL1560 (15x60 cm) € BP17
- 204RL2060 (20x60 cm) € BP17

M mid warm grey
304SP, BP, 104VM, 104HM, TVG, HV
50 60 60
R11 C C2C 23
reliëftegels / carreaux en relief /
Relie iesen / relief tiles



- 206RL560 (5x60 cm) € BP17
- 206RL1060 (10x60 cm) € BP17
- 206RL1560 (15x60 cm) € BP17
- 206RL2060 (20x60 cm) € BP17

M mid grey
306SP, BP, TVG, HV
50 60 60
R11 C C2C 36
reliëftegels / carreaux en relief /
Relie iesen / relief tiles



- 211RL560 (5x60 cm) € BP17
- 211RL1060 (10x60 cm) € BP17
- 211RL1560 (15x60 cm) € BP17
- 211RL2060 (20x60 cm) € BP17

M avalon beige
BP, TVG, HV
50 60 60
R11 C C2C 53
reliëftegels / carreaux en relief /
Relie iesen / relief tiles



- 216RL560 (5x60 cm) € BP17
- 216RL1060 (10x60 cm) € BP17
- 216RL1560 (15x60 cm) € BP17
- 216RL2060 (20x60 cm) € BP17

M anthracite
316SP, BP, 116VM, 116HM, TVG, HV
50 60 60
R11 C C2C 14
reliëftegels / carreaux en relief /
Relie iesen / relief tiles

Voor tegelpatronen zie www.mosa.com/nl-nl/grids.
Pour des motifs de carreaux, nous vous invitons à consulter www.mosa.com/fr-fr/trames.
Für Verlegemuster siehe www.mosa.com/de-de/raster.
For tile patterns, see www.mosa.com/en-us/grids or www.mosa.com/en-us/grids.

Voor uitgebreide verwerkingsadviezen zie www.mosa.com.
On peut trouver toutes les directives de pose sur www.mosa.com.
Für komplette Hinweise zur Verarbeitung siehe www.mosa.com.
The complete guidelines for installation can be found on www.mosa.com.

5 x 60 cm / 2 x 24 inch

10 x 60 cm / 4 x 24 inch

15 x 60 cm / 6 x 24 inch

20 x 60 cm / 8 x 24 inch



Terra Tones

vloertegels / carreaux de sol / Bodenfliesen / floor tiles
 Ultragres ongeglazuurd / non émaillé / unglasiert / unglazed
 vorstbestand / ingélif / frostsicher / frost proof

no.	mm	inch	pieces/ m ²	pieces/ m ¹	pieces/ box	boxes/ pallet	pieces/ pallet	m ² / pallet	kg/ m ²	kg/ pallet
200XV - 203ZV	47x597x12	1.85x23.50x0.47	33,3	-	12 = 0,36 m ²	108	1.296	38,9	26,5	1.058
200XV - 203ZV	97x597x12	3.82x23.50x0.47	16,7	-	6 = 0,36 m ²	108	648	38,8	27,2	1.080
200XV - 203ZV	147x597x12	5.79x23.50x0.47	11,1	-	8 = 0,721 m ²	56	448	40,4	27,0	1.115



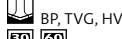

- 200XV560 (5x60 cm) € AP07
 200YV560
 200ZV560
 200XV1060 (10x60 cm) € AP07
 200YV1060
 200ZV1060
 200XV1560 (15x60 cm) € AP07
 200YV1560
 200ZV1560

 cool porcelain white
 BP, TVG, HV
 60 60
 R10 C2C 68

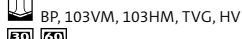

- 203XV560 (5x60 cm) € AP07
 203YV560
 203ZV560
 203XV1060 (10x60 cm) € AP07
 203YV1060
 203ZV1060
 203XV1560 (15x60 cm) € AP07
 203YV1560
 203ZV1560

 cool black
 BP, 103VM, 103HM, TVG, HV
 60 60
 R10 C2C 8

5 x 60 cm / 2 x 24 inch

10 x 60 cm / 4 x 24 inch

15 x 60 cm / 6 x 24 inch



Terra Tones

vloertegels / carreaux de sol / Bodenfliesen / floor tiles
Ultragres ongeglazuurd / non émaillé / unglasiert / unglazed
vorstbestand / ingélif / frostsicher / frost proof

no.	mm	inch	pieces/ m ²	pieces/ m ¹	pieces/ box	boxes/ pallet	pieces/ pallet	m ² / pallet	kg/ m ²	kg/ pallet
204XV - 206ZV	47x597x12	1.85x23.50x0.47	33,3	-	12 = 0,36 m ²	108	1.296	38,9	26,5	1.058
204XV - 206ZV	97x597x12	3.82x23.50x0.47	16,7	-	6 = 0,36 m ²	108	648	38,8	27,2	1.080
204XV - 206ZV	147x597x12	5.79x23.50x0.47	11,1	-	8 = 0,721 m ²	56	448	40,4	27,0	1.115



- 204XV560 (5x60 cm) € AP07
- 204YV560
- 204ZV560
- 204XV1060 (10x60 cm) € AP07
- 204YV1060
- 204ZV1060
- 204XV1560 (15x60 cm) € AP07
- 204YV1560
- 204ZV1560



mid warm grey



304SP, BP, 104VM, 104HM, TVG, HV



R10



C2C



22



- 206XV560 (5x60 cm) € AP07
- 206YV560
- 206ZV560
- 206XV1060 (10x60 cm) € AP07
- 206YV1060
- 206ZV1060
- 206XV1560 (15x60 cm) € AP07
- 206YV1560
- 206ZV1560



mid grey



306SP, BP, TVG, HV



R10



C2C



34

5 x 60 cm / 2 x 24 inch

10 x 60 cm / 4 x 24 inch

15 x 60 cm / 6 x 24 inch

Terra Tones

vloertegels / carreaux de sol / Bodenfliesen / floor tiles
 Ultragres ongeglazuurd / non émaillé / unglasiert / unglazed
 vorstbestand / ingélif / frostsicher / frost proof

no.	mm	inch	pieces/ m ²	pieces/ m ¹	pieces/ box	boxes/ pallet	pieces/ pallet	m ² / pallet	kg/ m ²	kg/ pallet
215XV - 216ZV	47x597x12	1.85x23.50x0.47	33,3	-	12 = 0,36 m ²	108	1.296	38,9	26,5	1.058
215XV - 216ZV	97x597x12	3.82x23.50x0.47	16,7	-	6 = 0,36 m ²	108	648	38,8	27,2	1.080
215XV - 216ZV	147x597x12	5.79x23.50x0.47	11,1	-	8 = 0,721 m ²	56	448	40,4	27,0	1.115



- 215XV560 (5x60 cm) € AP07
 215YV560
 215ZV560
 215XV1060 (10x60 cm) € AP07
 215YV1060
 215ZV1060
 215XV1560 (15x60 cm) € AP07
 215YV1560
 215ZV1560

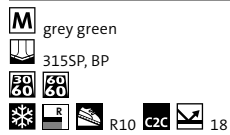

- 216XV560 (5x60 cm) € AP07
 216YV560
 216ZV560
 216XV1060 (10x60 cm) € AP07
 216YV1060
 216ZV1060
 216XV1560 (15x60 cm) € AP07
 216YV1560
 216ZV1560

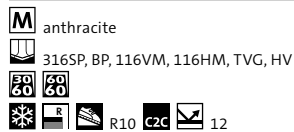

5 x 60 cm / 2 x 24 inch

10 x 60 cm / 4 x 24 inch

15 x 60 cm / 6 x 24 inch



Terra Tones

vloertegels / carreaux de sol / Bodenfliesen / floor tiles
 Ultragres ongeglazuurd / non émaillé / unglasiert / unglazed
 vorstbestand / ingélif / frostsicher / frost proof

no.	mm	inch	pieces/ m ²	pieces/ m ¹	pieces/ box	boxes/ pallet	pieces/ pallet	m ² / pallet	kg/ m ²	kg/ pallet
265XV - 266ZV	47x597x12	1.85x23.50x0.47	33,3	-	12 = 0,36 m ²	108	1.296	38,9	26,5	1.058
265XV - 266ZV	97x597x12	3.82x23.50x0.47	16,7	-	6 = 0,36 m ²	108	648	38,8	27,2	1.080
265XV - 266ZV	147x597x12	5.79x23.50x0.47	11,1	-	8 = 0,721 m ²	56	448	40,4	27,0	1.115



- 266XV560 (5x60 cm) € AP07
 266YV560
 266ZV560
 266XV1060 (10x60 cm) € AP07
 266YV1060
 266ZV1060
 266XV1560 (15x60 cm) € AP07
 266YV1560
 266ZV1560



light beige



BP, 166VM, 166HM



R10 C2C 49

Elke kleurgroep telt lichte (X), midden (Y) en donkere (Z) tonen. Per kleurgroep worden, per formaat, willekeurige hoeveelheden van X, Y en Z geleverd.
 Chaque groupe de couleur compte des tons clairs (X), moyens (Y) et foncés (Z). Les quantités aléatoires de X, Y et Z sont fournies par format et par groupe de couleur.
 Jede Farbgruppe enthält helle (X), mittlere (Y) und dunkle (Z) Töne. Pro Farbgruppe sind pro Format zufälligen Mengen von X, Y und Z erhältlich.
 Each colour group has light (X), medium (Y), and dark (Z) shades. For each colour group and size, random quantities of X, Y, and Z are supplied.

Voor tegelpatronen zie www.mosa.com/nl-nl/grids.
 Pour des motifs de carreaux, nous vous invitons à consulter www.mosa.com/fr-fr/trames.
 Für Verlegemuster siehe www.mosa.com/de-de/raster.
 For tile patterns, see www.mosa.com/en-en/grids or www.mosa.com/en-us/grids.

Voor uitgebreide verwerkingsadviezen zie www.mosa.com.
 On peut trouver toutes les directives de pose sur www.mosa.com.
 Für komplette Hinweise zur Verarbeitung siehe www.mosa.com.
 The complete guidelines for installation can be found on www.mosa.com.

5 x 60 cm / 2 x 24 inch

10 x 60 cm / 4 x 24 inch

15 x 60 cm / 6 x 24 inch

Core Collection Quartz

vloertegels / carreaux de sol / Bodenfliesen / floor tiles
 Ultragres ongeglazuurd / non émaillé / unglasiert / unglazed
 vorstbestand / ingélif / frostsicher / frost proof

reliëftegels / carreaux en relief / Relie iesen / relief tiles





no.	mm	inch	pieces/ m ²	pieces/ m ¹	pieces/ box	boxes/ pallet	pieces/ pallet	m ² / pallet	kg/ m ²	kg/ pallet
4101RQ - 4104RQ	597x597x12	23.50x23.50x0.47	2,8	-	3 = 1,071 m ²	30	90	32,1	27,8	918



4101RQ6060  AP10

 chalk white

 BP

    63

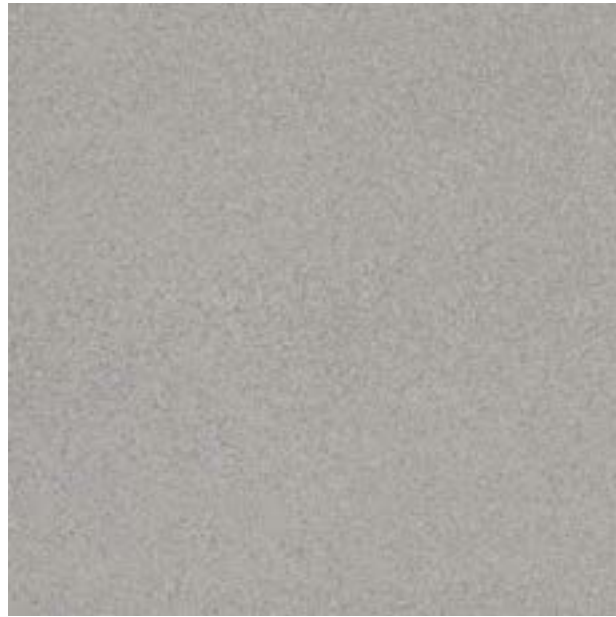

4102RQ6060  AP10

 slate grey

 BP

    39

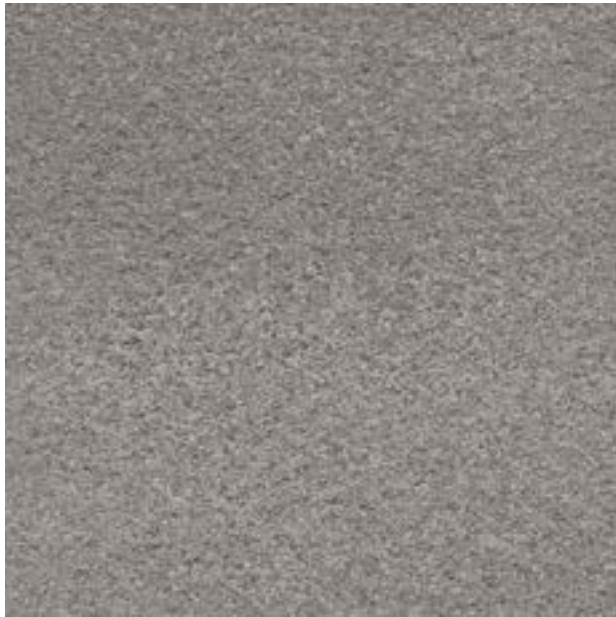

4103RQ6060  AP10

 basalt grey

 BP

    21



4104RQ6060  AP10

 anthracite black

 BP

    10



Core Collection Quartz

vloertegels / carreaux de sol / Bodenfliesen / floor tiles
 Ultragres ongeglazuurd / non émaillé / unglasiert / unglazed
 vorstbestand / ingélif / frostsicher / frost proof

reliëftegels / carreaux en relief / Relie iesen / relief tiles

no.	mm	inch	pieces/ m ²	pieces/ m ¹	pieces/ box	boxes/ pallet	pieces/ pallet	m ² / pallet	kg/ m ²	kg/ pallet
4105RQ - 4107RQ	597x597x12	23.50x23.50x0.47	2,8	-	3 = 1,071 m ²	30	90	32,1	27,8	918



4105RQ6060  AP10

 sand beige
 BP
    53



4107RQ6060  AP10

 agate grey
 BP
    20

Core Collection Solids



vloertegels / carreaux de sol / Bodenfliesen / floor tiles
 Ultragres ongeglazuurd / non émaillé / unglasiert / unglazed
 vorstbestand / ingélif / frostsicher / frost proof

reliëftegels / carreaux en relief / Relie iesen / relief tiles

no.	mm	inch	pieces/ m ²	pieces/ m ¹	pieces/ box	boxes/ pallet	pieces/ pallet	m ² / pallet	kg/ m ²	kg/ pallet
5102MR - 5110MR	597x597x12	23.50x23.50x0.47	2,8	-	3 = 1,071 m ²	30	90	32,1	27,8	918









5102MR6060  BP03

 vivid white
 5002SP, BP, TVG, HV
  R10  B  C2C  58









5106MR6060  BP03

 agate grey
 5006SP, BP, TVG, HV
  R10  B  C2C  15



5108MR6060  BP03

 stone grey
 5008SP, BP, TVG, HV
  R10  B  C2C  33



5110MR6060  BP03

 basalt grey
 5010SP, BP, TVG, HV
  R10  B  C2C  16



Core Collection Solids

vloertegels / carreaux de sol / Bodenfliesen / floor tiles
 Ultragres oneglazurd / non émaillé / unglasiert / unglazed
 vorstbestand / ingélif / frostsicher / frost proof

reliëftegels / carreaux en relief / Relie iesen / relief tiles

no.	mm	inch	pieces/ m ²	pieces/ m ¹	pieces/ box	boxes/ pallet	pieces/ pallet	m ² / pallet	kg/ m ²	kg/ pallet
5114MR - 5120MR	597x597x12	23.50x23.50x0.47	2,8	-	3 = 1,071 m ²	30	90	32,1	27,8	918



5114MR6060  BP03



sand beige



5014SP, BP, TVG, HV



R10  B  C2C  37



5120MR6060  BP03



jade grey



5020SP, BP, TVG, HV



R10  B  C2C  25

Voor tegelpatronen zie www.mosa.com/nl-nl/grids.
 Pour des motifs de carreaux, nous vous invitons à consulter www.mosa.com/fr-fr/trames.
 Für Verlegemuster siehe www.mosa.com/de-de/raster.
 For tile patterns, see www.mosa.com/en-us/grids or www.mosa.com/en-us/grids.

Core Collection Terra

vloertegels / carreaux de sol / Bodenfliesen / floor tiles
 Ultragres ongeglazuurd / non émaillé / unglasiert / unglazed
 vorstbestand / ingélif / frostsicher / frost proof

reliëftegels / carreaux en relief / Relie iesen / relief tiles

no.	mm	inch	pieces/ m ²	pieces/ m ¹	pieces/ box	boxes/ pallet	pieces/ pallet	m ² / pallet	kg/ m ²	kg/ pallet
203RM - 266RM	146x146x7,5	5.75x5.75x0.30	44	-	33 = 0,75 m ²	92	3.036	69,0	16,5	1.164









203RM1515   BP21

 cool black
 BP, 103VM, 103HM, TVG, HV
    9









204RM1515   BP21

 mid warm grey
 304SP, BP, 104VM, 104HM, TVG, HV
    23





206RM1515  BP21

 mid grey
 306SP, BP, TVG, HV
    36



216RM1515   BP21

 anthracite
 316SP, BP, 116VM, 116HM, TVG, HV
    14



225RM1515   BP21

 light cool grey
 BP, 125VM, 125HM
    41



226RM1515   BP21

 mid cool grey
 BP, 126VM, 126HM, TVG, HV
    24



264RM1515   BP21

 grey brown
 BP, 164VM, 164HM
    16

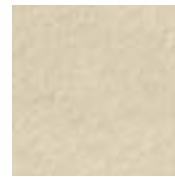

266RM1515   BP21

 light beige
 BP, 166VM, 166HM
    55



Core Collection Terra

vloertegels / carreaux de sol / Bodenfliesen / floor tiles
 Ultragres ongeglazuurd / non émaillé / unglasiert / unglazed
 vorstbestand / ingélif / frostsicher / frost proof









reliëftegels / carreaux en relief / Relie iesen / relief tiles

no.	mm	inch	pieces/ m ²	pieces/ m ¹	pieces/ box	boxes/ pallet	pieces/ pallet	m ² / pallet	kg/ m ²	kg/ pallet
203RL - 266RL	296x296x10	11.65x11.65x0.39	11	-	10 = 0,909 m ²	48	480	43,6	23,3	1.043









203RL3030   **BP19**
 cool black
 BP, 103VM, 103HM, TVG, HV
    9











204RL3030   **BP19**
 mid warm grey
 304SP, BP, 104VM, 104HM, TVG, HV
    23



206RL3030   **BP19**
 mid grey
 306SP, BP, TVG, HV
    36











211RL3030   **BP19**
 avalon beige
 BP, TVG, HV
    53



216RL3030   **BP19**
 anthracite
 316SP, BP, 116VM, 116HM, TVG, HV
    14



266RL3030   **BP19**
 light beige
 BP, 166VM, 166HM
    54





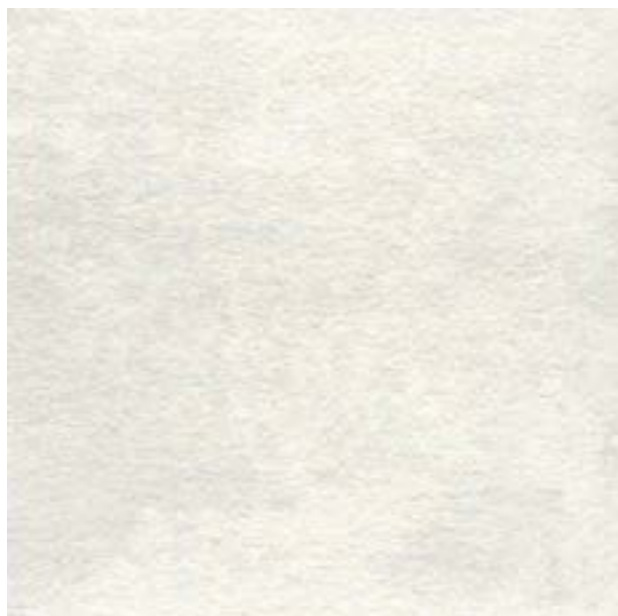

Core Collection Terra

vloertegels / carreaux de sol / Bodenfliesen / floor tiles
 Ultragres ongeglazuurd / non émaillé / unglasiert / unglazed
 vorstbestand / ingélif / frostsicher / frost proof

reliëftegels / carreaux en relief / Relie iesen / relief tiles

no.	mm	inch	pieces/ m ²	pieces/ m ¹	pieces/ box	boxes/ pallet	pieces/ pallet	m ² / pallet	kg/ m ²	kg/ pallet
200RL - 203RL	297x597x12	11.69x23.50x0.47	5,56	-	4 = 0,719 m ²	48	192	34,5	26,5	941
200RL - 203RL	597x597x12	23.50x23.50x0.47	2,8	-	3 = 1,071 m ²	30	90	32,1	27,8	918
200RL - 203RL	47x597x12	1.85x23.50x0.47	33,3	-	24 = 0,721 m ²	56	1.344	40,4	26,5	1.096
200RL - 203RL	97x597x12	3.82x23.50x0.47	16,7	-	12 = 0,721 m ²	56	672	40,4	27,2	1.119
200RL - 203RL	147x597x12	5.79x23.50x0.47	11,1	-	8 = 0,721 m ²	56	448	40,4	27,0	1.115
200RL - 203RL	197x597x12	7.76x23.50x0.47	8,3	-	6 = 0,721 m ²	45	270	32,5	27,7	925









200RL3060		 BP16
200RL6060		 BP16
200RL560	(5x60 cm)	 BP17
200RL1060	(10x60 cm)	 BP17
200RL1560	(15x60 cm)	 BP17
200RL2060	(20x60 cm)	 BP17

 cool porcelain white

 BP, TVG, HV

 R11 C C2C 68

203RL3060		 BP16
203RL6060		 BP16
203RL560	(5x60 cm)	 BP17
203RL1060	(10x60 cm)	 BP17
203RL1560	(15x60 cm)	 BP17
203RL2060	(20x60 cm)	 BP17

 cool black

 BP, 103VM, 103HM, TVG, HV

 R11 C C2C 9



Core Collection Terra

vloertegels / carreaux de sol / Bodenfliesen / floor tiles
 Ultragres ongeglazuurd / non émaillé / unglasiert / unglazed
 vorstbestand / ingélif / frostsicher / frost proof

reliëftegels / carreaux en relief / Relie iesen / relief tiles

no.	mm	inch	pieces/ m ²	pieces/ m ¹	pieces/ box	boxes/ pallet	pieces/ pallet	m ² / pallet	kg/ m ²	kg/ pallet
204RL - 206RL	297x597x12	11.69x23.50x0.47	5,56	-	4 = 0,719 m ²	48	192	34,5	26,5	941
204RL - 206RL	597x597x12	23.50x23.50x0.47	2,8	-	3 = 1,071 m ²	30	90	32,1	27,8	918
204RL - 206RL	47x597x12	1.85x23.50x0.47	33,3	-	24 = 0,721 m ²	56	1.344	40,4	26,5	1.096
204RL - 206RL	97x597x12	3.82x23.50x0.47	16,7	-	12 = 0,721 m ²	56	672	40,4	27,2	1.119
204RL - 206RL	147x597x12	5.79x23.50x0.47	11,1	-	8 = 0,721 m ²	56	448	40,4	27,0	1.115
204RL - 206RL	197x597x12	7.76x23.50x0.47	8,3	-	6 = 0,721 m ²	45	270	32,5	27,7	925



204RL3060		BP16
204RL6060		BP16
204RL560	(5x60 cm)	BP17
204RL1060	(10x60 cm)	BP17
204RL1560	(15x60 cm)	BP17
204RL2060	(20x60 cm)	BP17

mid warm grey
 304SP, BP, 104VM, 104HM, TVG, HV

206RL3060		BP16
206RL6060		BP16
206RL560	(5x60 cm)	BP17
206RL1060	(10x60 cm)	BP17
206RL1560	(15x60 cm)	BP17
206RL2060	(20x60 cm)	BP17

mid grey
 306SP, BP, TVG, HV







Core Collection Terra

vloertegels / carreaux de sol / Bodenfliesen / floor tiles
 Ultragres ongeglazuurd / non émaillé / unglasiert / unglazed
 vorstbestand / ingélif / frostsicher / frost proof

reliëftegels / carreaux en relief / Relie iesen / relief tiles

no.	mm	inch	pieces/ m ²	pieces/ m ¹	pieces/ box	boxes/ pallet	pieces/ pallet	m ² / pallet	kg/ m ²	kg/ pallet
211RL - 216RL	297x597x12	11.69x23.50x0.47	5,56	-	4 = 0,719 m ²	48	192	34,5	26,5	941
211RL - 216RL	597x597x12	23.50x23.50x0.47	2,8	-	3 = 1,071 m ²	30	90	32,1	27,8	918
211RL - 216RL	47x597x12	1.85x23.50x0.47	33,3	-	24 = 0,721 m ²	56	1.344	40,4	26,5	1.096
211RL - 216RL	97x597x12	3.82x23.50x0.47	16,7	-	12 = 0,721 m ²	56	672	40,4	27,2	1.119
211RL - 216RL	147x597x12	5.79x23.50x0.47	11,1	-	8 = 0,721 m ²	56	448	40,4	27,0	1.115
211RL - 216RL	197x597x12	7.76x23.50x0.47	8,3	-	6 = 0,721 m ²	45	270	32,5	27,7	925









211RL3060		 BP16
211RL6060		 BP16
211RL560	(5x60 cm)	 BP17
211RL1060	(10x60 cm)	 BP17
211RL1560	(15x60 cm)	 BP17
211RL2060	(20x60 cm)	 BP17

 avalon beige

 BP, TVG, HV

 R11 C C2C 53

216RL3060		 BP16
216RL6060		 BP16
216RL560	(5x60 cm)	 BP17
216RL1060	(10x60 cm)	 BP17
216RL1560	(15x60 cm)	 BP17
216RL2060	(20x60 cm)	 BP17

 anthracite

 316SP, BP, 116VM, 116HM, TVG, HV

 R11 C C2C 14



vloertegels / carreaux de sol / Bodenfliesen / floor tiles
 Ultragres ongeglazuurd / non émaillé / unglasiert / unglazed
 vorstbestand / ingélif / frostsicher / frost proof

reliëftegels / carreaux en relief / Relie iesen / relief tiles

no.	mm	inch	pieces/ m ²	pieces/ m ¹	pieces/ box	boxes/ pallet	pieces/ pallet	m ² / pallet	kg/ m ²	kg/ pallet
75430AS - 75630AS	146x146x7,3	5.75x5.75x0.29	44	-	31 = 0,705 m ²	92	2.852	64,8	15,0	1.000



75430AS1515 CP26

M grijsbeige jn gespikkeld / gris-beige petits grains / graubeige Feinkorn / small speckled grey beige

DP, DI, DU, SP, 75030VD, 75030HD
 R11 C
 42 S 3005-Y20R



75440AS1515 CP26

M aardebruin jn gespikkeld / brune terre petits grains / erdbraun Feinkorn / small speckled earth brown

DP, DI, DU, SP, 75040VD, 75040HD
 R11 C
 25 S 3010-Y40R



75460AS1515 CP26

M napelsgeel jn gespikkeld / jaune de Naples petits grains / Neapelgelb Feinkorn / small speckled Naples yellow

DP, DI, DU, SP, 75060VD, 75060HD
 R11 C
 38 S 2030-Y20R



75470AS1515 CP26

M zandgeel jn gespikkeld / jaune de sable petits grains / sandgelb Feinkorn / small speckled sand yellow

DP, DI, DU, SP, 75070VD, 75070HD
 R11 C
 44 S 2020-Y20R

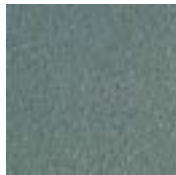

75500AS1515 CP26

M turkoois jn gespikkeld / turquoise petits grains / türkis Feinkorn / small speckled turquoise

DP, DI, DU, SP, 75100VD, 75100HD
 R11 C
 17 S 6020-B30G



75510AS1515 CP26

M mintgroen jn gespikkeld / vert de menthe petits grains / minzegrün Feinkorn / small speckled mint green

DP, DI, DU, SP, 75110VD, 75110HD
 R11 C
 38 S 3010-G

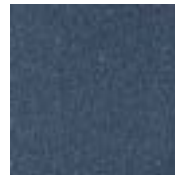

75520AS1515 CP26

M pruisischblauw jn gespikkeld / bleu de Prusse petits grains / Preußischblau Feinkorn / small speckled Prussian blue

DP, DI, DU, SP, 75120VD, 75120HD
 R11 C
 13 S 6020-R90B



75530AS1515 CP26

M sèvresblauw jn gespikkeld / bleu de Sèvres petits grains / Sèvresblau Feinkorn / small speckled Sèvres blue

DP, DI, DU, SP, 75130VD, 75130HD
 R11 C
 34 S 2020-R90B

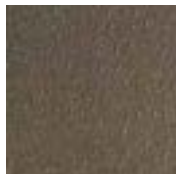

75560AS1515 CP26

M indischbruin jn gespikkeld / brun Indien petits grains / Indischbraun Feinkorn / small speckled Indian brown

DP, DI, DU, SP, 75160VD, 75160HD
 R11 C
 11 S 7010-Y70R



75570AS1515 CP26

M koperbruin jn gespikkeld / brun cuivre petits grains / kupferbraun Feinkorn / small speckled copper brown

DP, DI, DU, SP, 75170VD, 75170HD
 R11 C
 20 S 4030-Y50R



75600AS1515 CP26

M ivoorzwart jn gespikkeld / noir d'ivoire petits grains / elfenbeinschwarz Feinkorn / small speckled ivory black

DP, DI, DU, SP, 75200VD, 75200HD
 R11 C
 8 S 8000-N

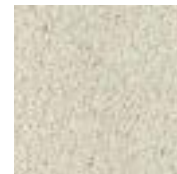

75610AS1515 CP26

M ecruwit jn gespikkeld / blanc écru petits grains / weiß ungebleicht Feinkorn / small speckled white unbleached

DP, DI, DU, SP, 75210VD, 75210HD
 R11 C
 52 S 1005-Y10R



75620AS1515 CP26

M grijs jn gespikkeld / gris petits grains / grau Feinkorn / small speckled grey

DP, DI, DU, SP, 75220VD, 75220HD
 R11 C
 37 S 3000-N



75630AS1515 CP26

M muisgrijs jn gespikkeld / gris de souris petits grains / mausgrau Feinkorn / small speckled mouse grey

DP, DI, DU, SP, 75230VD, 75230HD
 R11 C
 24 S 5500-N

Voor de bijbehorende vloertegels Global Collection in dit formaat zie pagina's 96 - 100.

Pour la collection carreaux de sol correspondants Global Collection dans ce format voir pages 96 - 100.

Für die dazugehörigen Bodenfliesen Global Collection in diesen Format siehe Seiten 96 - 100.

For the matching Global Collection floor tiles in this size see pages 96 - 100.

Globalgrip

vloertegels / carreaux de sol / Bodenfliesen / floor tiles
 Ultragres ongeglazuurd / non émaillé / unglasiert / unglazed
 vorstbestand / ingélif / frostsicher / frost proof

reliëftegels / carreaux en relief / Relie iesen / relief tiles

no.	mm	inch	pieces/ m ²	pieces/ m ¹	pieces/ box	boxes/ pallet	pieces/ pallet	m ² / pallet	kg/ m ²	kg/ pallet
75600TS-75620TS	146x146x7,4	5.75x5.75x0.29	44	-	31 = 0,705 m ²	92	2.852	64,8	15,4	1.026
75600WS-75620WS	146x146x7,6	5.75x5.75x0.30	44	-	31 = 0,705 m ²	92	2.852	64,8	15,2	1.009



75600TS1515 

M ivoorzwart in gespikkeld / noir d'ivoire
 petits grains / elfenbeinschwarz
 Feinkorn / small speckled ivory black

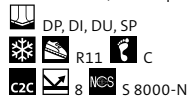

75620TS1515 

M grijs in gespikkeld / gris petits grains /
 grau Feinkorn / small speckled grey

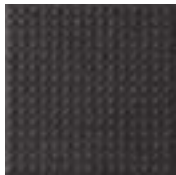
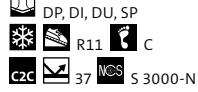

75600WS1515 

M ivoorzwart in gespikkeld / noir d'ivoire
 petits grains / elfenbeinschwarz
 Feinkorn / small speckled ivory black

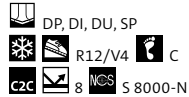

75620WS1515 

M grijs in gespikkeld / gris petits grains /
 grau Feinkorn / small speckled grey

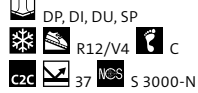

Voor accessoires zie serie Global Collection.
 Pour accessoires voir la série Global Collection.
 Für Formteile siehe Serie Global Collection.
 For accessories see series Global Collection.

Voor de bijbehorende vloertegels Global Collection in dit formaat zie pagina's 96 - 100.
 Pour la collection carreaux de sol correspondants Global Collection dans ce format voir pages 96 - 100.
 Für die dazugehörigen Bodenfliesen Global Collection in diesen Format siehe Seiten 96 - 100.
 For the matching Global Collection floor tiles in this size see pages 96 - 100.



Holland 2050

vloertegels / carreaux de sol / Bodenfliesen / floor tiles
 Ultragres ongeglazuurd / non émaillé / unglasiert / unglazed
 vorstbestand / ingélif / frostsicher / frost proof



reliëftegels / carreaux en relief / Relie iesen / relief tiles

no.	mm	inch	pieces/ m ²	pieces/ m ¹	pieces/ box	boxes/ pallet	pieces/ pallet	m ² / pallet	kg/ m ²	kg/ pallet
80010MR - 80060MR	146x146x7	5.75x5.75x0.28	44	-	33 = 0,75 m ²	92	3.036	69,0	15,3	1.082
80010MR - 80060MR	296x296x8	11.65x11.65x0.31	11	-	13 = 1,182 m ²	48	624	56,7	18,3	1.063



80010MR1515  € CP51
 80010MR3030  € CP51

M licht koel grijs / gris frais clair /
 hell kühl grau / light cool grey



 VR, HR, 80011CS1MR, 80011CW1MR  1515

    40



80020MR1515  € CP51
 80020MR3030  € CP51

M donkergrijs / gris foncé /
 dunkelgrau / dark grey

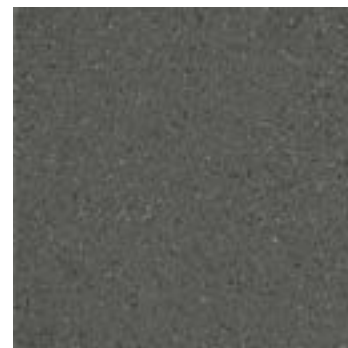

 VR, HR, 80021CS1MR, 80021CW1MR  1515

    25



80030MR1515  € CP51
 80030MR3030  € CP51

M licht antraciet / anthracite clair /
 hell anthrazit / light anthracite



 VR, HR, 80031CS1MR, 80031CW1MR  1515

    13



80040MR1515  € CP51
 80040MR3030  € CP51

M beige / beige /
 beige / beige

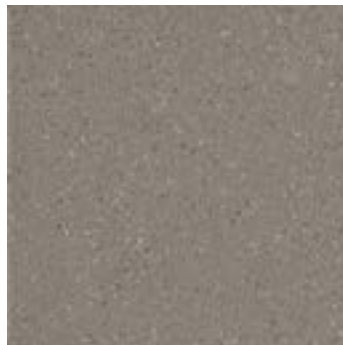

 VR, HR  1515

    49



80050MR1515  € CP51
 80050MR3030  € CP51

M midden warm grijs / gris chaleureux moyen /
 mittel warm grau / mid warm grey



 VR, HR, 80051CS1MR, 80051CW1MR  1515

    25



80060MR1515  € CP51
 80060MR3030  € CP51

M grijsbruin / gris-brun /
 graubraun / grey brown

 VR, HR  1515

    16

Scenes



vloertegels / carreaux de sol / Bodenfliesen / floor tiles
 Ultragres ongeglazuurd / non émaillé / unglasiert / unglazed
 vorstbestand / ingélf / frostsicher / frost proof

reliëftegels / carreaux en relief / Reliefiesen / relief tiles

no.	mm	inch	pieces/ m ²	pieces/ m ¹	pieces/ box	boxes/ pallet	pieces/ pallet	m ² / pallet	kg/ m ²	kg/ pallet
6110MR- 6170MR	146x146x7,5	5.75x5.75x0.30	44	-	33 = 0,75 m ²	92	3.036	69,0	16,5	1.164



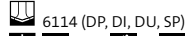

6110MR1515  BP22

 white grey grain
 6114 (DP, DI, DU, SP)
 R10 B C2C 59



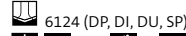

6120MR1515  BP22

 cool grey grain
 6124 (DP, DI, DU, SP)
 R10 B C2C 40





6130MR1515  BP22

 green grey grain
 6134 (DP, DI, DU, SP)
 R10 B C2C 22



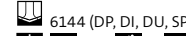

6140MR1515  BP22

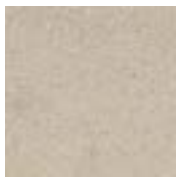
 dark anthracite grain
 6144 (DP, DI, DU, SP)
 R10 B C2C 11



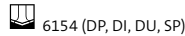

6150MR1515  BP22

 mid beige grain
 6154 (DP, DI, DU, SP)
 R10 B C2C 44



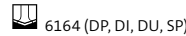

6160MR1515  BP22

 warm ochre grain
 6164 (DP, DI, DU, SP)
 R10 B C2C 31

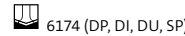

6170MR1515  BP22

 warm grey grain
 6174 (DP, DI, DU, SP)
 R10 B C2C 18

Voor de bijbehorende vloertegels Scenes in dit formaat zie pagina's 101 en 102.
 Pour la collection carreaux de sol correspondants Scenes dans ce format voir pages 101 et 102.
 Für die dazugehörigen Bodenfliesen Scenes in diesen Format siehe Seiten 101 und 102.
 For the matching Scenes floor tiles in this size see pages 101 and 102.

Voor tegelpatronen zie www.mosa.com/nl-nl/grids.
 Pour des motifs de carreaux, nous vous invitons à consulter www.mosa.com/fr-fr/trames.
 Für Verlegemuster siehe www.mosa.com/de-de/raster.
 For tile patterns, see www.mosa.com/en-us/grids or www.mosa.com/en-us/grids.





Softgrip

vloertegels / carreaux de sol / Bodenfliesen / floor tiles
 Ultragres ongeglazuurd / non émaillé / unglasiert / unglazed
 vorstbestand / ingélif / frostsicher / frost proof

reliëftegels / carreaux en relief / Relie iesen / relief tiles

no.	mm	inch	pieces/ m ²	pieces/ m ¹	pieces/ box	boxes/ pallet	pieces/ pallet	m ² / pallet	kg/ m ²	kg/ pallet
74000LS - 74110LS	146x146x7	5.75x5.75x0.28	44	-	33 = 0,75 m ²	92	3.036	69,0	15,3	1.082
74000LS - 74090LS	296x296x8	11.65x11.65x0.31	11	-	13 = 1,182 m ²	48	624	56,7	18,3	1.063



74000LS1515  € CP23
 74000LS3030  € CP23



M porseleinwit / blanc porcelaine /
 porzellanweiß / porcelain white

 DP, DI, DU, VS, HS

 R11  B

  70



74020LS1515  € CP23
 74020LS3030  € CP23



M grijs / gris /
 grau / grey

 DP, DI, DU, VS, HS

 R11  B

  38



74030LS1515  € CP23
 74030LS3030  € CP23



M muisgrijs / gris de souris /
 mausgrau / mouse grey

 DP, DI, DU, VS, HS

 R11  B

  24



74040LS1515  € CP23
 74040LS3030  € CP23



M licht warm grijs / gris chaleureux clair /
 hell warm grau / light warm grey

 DP, DI, DU, VS, HS

 R11  B

  32



74050LS1515  € CP23
 74050LS3030  € CP23



M midden warm grijs /
 gris chaleureux moyen /
 mittel warm grau / mid warm grey

 DP, DI, DU, VS, HS

 R11  B

  22



74060LS1515  € CP23
 74060LS3030  € CP23



M beige / beige /
 beige / beige

 DP, DI, DU, VS, HS

 R11  B

  42



74070LS1515  € CP23
 74070LS3030  € CP23



M grijsbruin / gris-brun /
 graubraun / grey brown

 DP, DI, DU, VS, HS

 R11  B

  12



74090LS1515  € CP23
 74090LS3030  € CP23

M ivoorzwart / noir d'ivoire /
 elfenbeinschwarz / ivory black

 DP, DI, DU, VS, HS

 R11  B

  9



74110LS1515  € CP23

M lichtbeige / beige clair /
 hellbeige / light beige

 DP, DI, DU, VS, HS

 R11  B

  58

Voor de bijbehorende vloertegels Softline in deze formaten zie pagina's 103 en 113.
 Pour la collection carreaux de sol correspondants Softline dans ces formats voir pages 103 et 113.
 Für die dazugehörigen Bodenfliesen Softline in diesen Formaten siehe Seiten 103 und 113.
 For the matching Softline floor tiles in these sizes see pages 103 and 113.

vloertegels / carreaux de sol / Bodenfliesen / floor tiles
 Ultragres ongeglazuurd / non émaillé / unglasiert / unglazed
 vorstbestand / ingélif / frostsicher / frost proof

accessoires / accessoires / Formteile / accessories

no.	mm	inch	pieces/ m ²	pieces/ m ¹	pieces/ box	boxes/ pallet	pieces/ pallet	m ² / pallet	kg/ m ²	kg/ pallet
75070P - 75230P	103x96x10	4.06x3.78x0.39	-	10,00	50 = 5,00 m ¹	98	4.900	-	-	956
75070I - 75230I	103x35x8	4.06x1.38x0.31	-	-	99	90	8.910	-	-	613
75070U - 75230U	103x25x8	4.06x0.98x0.31	-	-	72	90	6.480	-	-	161

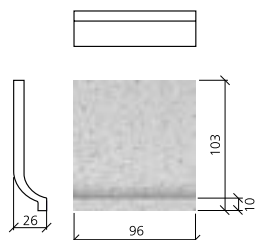

...P1010  D 31

M holplint /
 plinthe à gorge /
 Hohlkehlsocbel /
 coved skirting (cove base)

 75070, 75200, 75210, 75220, 75230

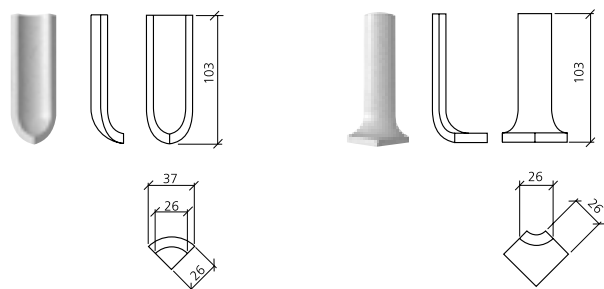

...I104  D 65

M inwendig hoekje voor P /
 angle intérieur pour P /
 Innenecke für P /
 internal angle for P (inside angle)

 75070, 75200, 75210, 75220, 75230



...U103  D 65

M uitwendig hoekje voor P /
 angle extérieur pour P /
 Außenecke für P /
 external angle for P (outside angle)

 75070, 75200, 75210, 75220, 75230



Door de productiewijze kan de maatvoering van deze accessoires enige variatie vertonen.
 En raison de la méthode de production, les dimensions de ces accessoires peuvent présenter des variations.
 Aufgrund des Herstellungsverfahrens dieser Formteile kann eine geringe Abweichung der angestrebten Abmessungen nicht ausgeschlossen werden.
 Due to the production method, the dimensions of these accessories may show some variation.

Accessoire	In kleur	Artikelnummer
Accessoire	En couleur	Numéro d'article
Formteil	In der Farbe	Artikelnummer
Accessory	In colour	Item number
...P1010	+ 75070	= 75070P1010





DP, DI, DU Global Collection, Scenes, Softline

vloertegels / carreaux de sol / Bodenfliesen / floor tiles
 Ultragres ongeglazuurd / non émaillé / unglasiert / unglazed
 vorstbestand / ingélf / frostsicher / frost proof

accessoires / accessoires / Formteile / accessories

no.	mm	inch	pieces/ m ²	pieces/ m ¹	pieces/ box	boxes/ pallet	pieces/ pallet	m ² / pallet	kg/ m ²	kg/ pallet
6114DP - 76660DP	75x146x5,5	2.95x5.75x0.22	-	6,67	30 = 4,50 m ¹	192	5.760	-	-	912
6114DI - 76660DU	75x20x5,5	2.95x0.79x0.22	-	-	100	200	20.000	-	-	505

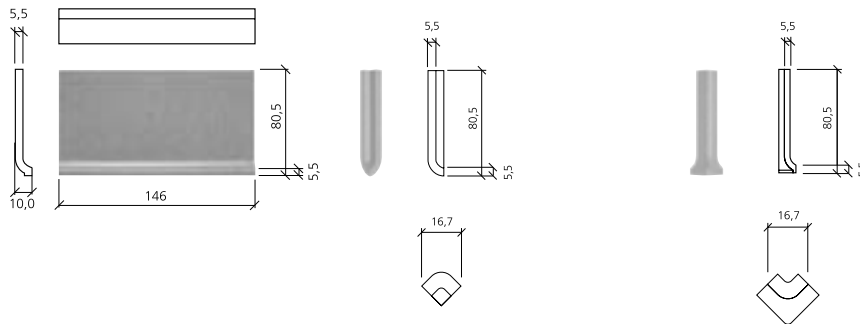

...DP815 € D 38

M dunne holplint /
 plinthe à gorge ne /
 dünner Hohlkehlsocbel /
 thin coved skirting (thin cove base)

❄ 6114, 6124, 6134, 6144, 6154,
 6164, 6174, 74000, 74020, 74030,
 74040, 74050, 74060, 74070, 74090,
 74110, 75020, 75030, 75040, 75050,
 75060, 75070, 75080, 75090, 75100,
 75110, 75120, 75130, 75140, 75150,
 75160, 75170, 75180, 75200, 75210,
 75220, 75230, 75420, 75430, 75440,
 75450, 75460, 75470, 75480, 75490,
 75500, 75510, 75520, 75530, 75540,
 75550, 75560, 75570, 75580, 75600,
 75610, 75620, 75630, 76010, 76240,
 76250, 76260, 76410, 76640, 76650,
 76660

c2c

...DI82 € D 59

M inwendig hoekje voor DP /
 angle intérieur pour DP /
 Innenecke für DP /
 internal angle for DP (inside angle)

❄ 6114, 6124, 6134, 6144, 6154,
 6164, 6174, 74000, 74020, 74030,
 74040, 74050, 74060, 74070, 74090,
 74110, 75020, 75030, 75040, 75050,
 75060, 75070, 75080, 75090, 75100,
 75110, 75120, 75130, 75140, 75150,
 75160, 75170, 75180, 75200, 75210,
 75220, 75230, 75420, 75430, 75440,
 75450, 75460, 75470, 75480, 75490,
 75500, 75510, 75520, 75530, 75540,
 75550, 75560, 75570, 75580, 75600,
 75610, 75620, 75630, 76010, 76240,
 76250, 76260, 76410, 76640, 76650,
 76660

c2c

...DU82 € D 59

M uitwendig hoekje voor DP /
 angle extérieur pour DP /
 Außenecke für DP /
 external angle for DP (outside angle)

❄ 6114, 6124, 6134, 6144, 6154,
 6164, 6174, 74000, 74020, 74030,
 74040, 74050, 74060, 74070, 74090,
 74110, 75020, 75030, 75040, 75050,
 75060, 75070, 75080, 75090, 75100,
 75110, 75120, 75130, 75140, 75150,
 75160, 75170, 75180, 75200, 75210,
 75220, 75230, 75420, 75430, 75440,
 75450, 75460, 75470, 75480, 75490,
 75500, 75510, 75520, 75530, 75540,
 75550, 75560, 75570, 75580, 75600,
 75610, 75620, 75630, 76010, 76240,
 76250, 76260, 76410, 76640, 76650,
 76660

c2c

Artikelnummer
 Numéro d'article
 Artikelnummer
 Item number

Bijbehorende dunne holplint
 Plinthe à gorge fine correspondante
 Dazu gehörende dünner Hohlkehlsocbel
 Matching thin coved skirting (thin cove base)

6110V1515	6110MR1515	6111V1515	6112V1515	6114DP815
6120V1515	6120MR1515	6121V1515	6122V1515	6124DP815
6130V1515	6130MR1515	6131V1515	6132V1515	6134DP815
6140V1515	6140MR1515	6141V1515	6142V1515	6144DP815
6150V1515	6150MR1515	6151V1515	6152V1515	6154DP815
6160V1515	6160MR1515	6161V1515	6162V1515	6164DP815
6170V1515	6170MR1515	6171V1515	6172V1515	6174DP815

Door de productiewijze kan de maatvoering van deze accessoires enige variatie vertonen.

En raison de la méthode de production, les dimensions de ces accessoires peuvent présenter des variations.

Aufgrund des Herstellungsverfahrens dieser Formteile kann eine geringe Abweichung der angestrebten Abmessungen nicht ausgeschlossen werden.

Due to the production method, the dimensions of these accessories may show some variation.

Accessoire Accessoire Formteil Accessory	In kleur En couleur In der Farbe In colour	Artikelnummer Numéro d'article Artikelnummer Item number
...DP815 +	6114 =	6114DP815





vloertegels / carreaux de sol / Bodenfliesen / floor tiles
 Ultragres ongeglazuurd / non émaillé / unglasiert / unglazed
 vorstbestand / ingélif / frostsicher / frost proof

accessoires / accessoires / Formteile / accessories

no.	mm	inch	pieces/ m ²	pieces/ m ¹	pieces/ box	boxes/ pallet	pieces/ pallet	m ² / pallet	kg/ m ²	kg/ pallet
6114SP - 76660SP	155x146x8	6.10x5.75x0.31	-	6,67	24 = 3,60 m ¹	84	2.016	-	-	848

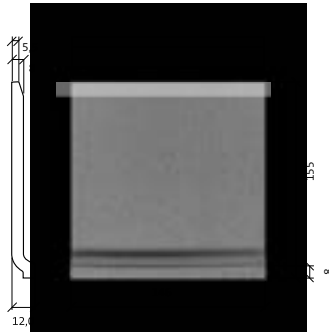

...SP1515 D 50

M holplint /
 plinthe à gorge /
 Hohlkehlsöckel /
 coved skirting (cove base)

- 6114, 6124, 6134, 6144, 6154,
 6164, 6174, 75020, 75030, 75040,
 75050, 75060, 75070, 75080, 75090,
 75100, 75110, 75120, 75130, 75140,
 75150, 75160, 75170, 75180, 75200,
 75210, 75220, 75230, 75420, 75430,
 75440, 75450, 75460, 75470, 75480,
 75490, 75500, 75510, 75520, 75530,
 75540, 75550, 75560, 75570, 75580,
 75600, 75610, 75620, 75630, 76010,
 76240, 76250, 76260, 76410, 76640,
 76650, 76660



Artikelnummer Numéro d'article Artikelnummer Item number	Bijbehorende holplint Plinthe à gorge correspondante Dazu gehörende Hohlkehlsöckel Matching coved skirting (cove base)			
6110V1515	6110MR1515	6111V1515	6112V1515	6114SP1515
6120V1515	6120MR1515	6121V1515	6122V1515	6124SP1515
6130V1515	6130MR1515	6131V1515	6132V1515	6134SP1515
6140V1515	6140MR1515	6141V1515	6142V1515	6144SP1515
6150V1515	6150MR1515	6151V1515	6152V1515	6154SP1515
6160V1515	6160MR1515	6161V1515	6162V1515	6164SP1515
6170V1515	6170MR1515	6171V1515	6172V1515	6174SP1515

Accessoire Accessoire Formteil Accessory	In kleur En couleur In der Farbe In colour	Artikelnummer Numéro d'article Artikelnummer Item number
...SP1515 +	6114 =	6114SP1515





vloertegels / carreaux de sol / Bodenfliesen / floor tiles
 Ultragres ongeglazuurd / non émaillé / unglasiert / unglazed
 vorstbestand / ingélif / frostsicher / frost proof

accessoires / accessoires / Formteile / accessories

no.	mm	inch	pieces/ m ²	pieces/ m ¹	pieces/ box	boxes/ pallet	pieces/ pallet	m ² / pallet	kg/ m ²	kg/ pallet
5002SP - 362SP	146x297x8	5.75x11.69x0.31	-	3,33	12 = 3,60 m ¹	84	1.008	-	-	857

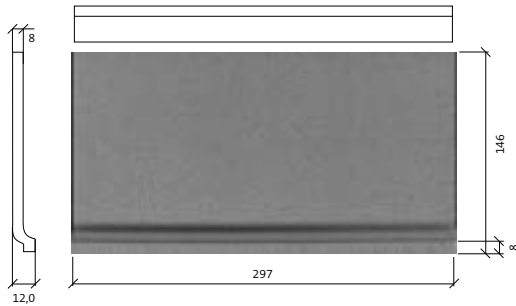

...SP1530

€ D 82

M holplint /
 plinthe à gorge /
 Hohlkehlsoclel /
 coved skirting (cove base)

5002, 5006, 5008, 5010, 5014,
 5020



...SP1530

€ D 76

M holplint /
 plinthe à gorge /
 Hohlkehlsoclel /
 coved skirting (cove base)

304, 306, 315, 316, 362



Artikelnummer Numéro d'article Artikelnummer Item number	Bijbehorende holplint Plinthe à gorge correspondante Dazu gehörende Hohlkehlsoclel Matching coved skirting (cove base)
5102V . 5102MR6060	5002SP1530
5106V . 5106MR6060	5006SP1530
5108V . 5108MR6060	5008SP1530
5110V . 5110MR6060	5010SP1530
5114V . 5114MR6060	5014SP1530
5120V . 5120MR6060	5020SP1530
204V .	304SP1530
206V .	306SP1530
215V .	315SP1530
216V .	316SP1530
262V .	362SP1530

Accessoire	In kleur	Artikelnummer
Accessoire	En couleur	Numéro d'article
Formteil	In der Farbe	Artikelnummer
Accessory	In colour	Item number
...SP1530	+	5002
	=	5002SP1530





VD, HD, VS, HS, VM, HM, VR, HR

Globalgrip, Holland 2050, Softgrip, Core Collection Terra

vloertegels / carreaux de sol / Bodenfliesen / floor tiles
Ultragres ongeglazuurd / non émaillé / unglasiert / unglazed
vorstbestand / ingélif / frostsicher / frost proof

accessoires / accessoires / Formteile / accessories

no.	mm	inch	pieces/ m ²	pieces/ m ¹	pieces/ box	boxes/ pallet	pieces/ pallet	m ² / pallet	kg/ m ²	kg/ pallet
75030VD - 75230VD	146x146x8(-16)	5.75x5.75x0.31(-0.63)	-	6,67	21 = 3,15 m ¹	80	1.680	-	-	910
75030HD - 75230HD	146x146x8(-16)	5.75x5.75x0.31(-0.63)	-	-	16	80	1.280	-	-	729
74000VS - 74110VS	146x146x8(-16)	5.75x5.75x0.31(-0.63)	-	6,67	21 = 3,15 m ¹	80	1.680	-	-	910
74000HS - 74110HS	146x146x8(-16)	5.75x5.75x0.31(-0.63)	-	-	16	80	1.280	-	-	729

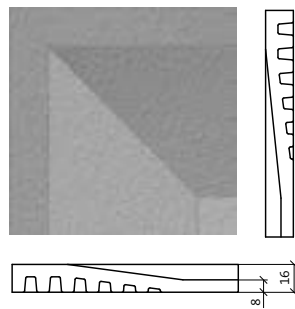
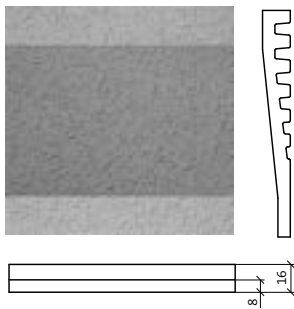

...VD1515 € D 92

M douchebakplint /
pièce courante /
Gefälleformstück /
sloping shower edge tile

75030, 75040, 75060, 75070, 75100,
75110, 75120, 75130, 75160, 75170,
75200, 75210, 75220, 75230



relieftegels / carreaux en relief /
Relie iesen / relief tiles

...HD1515 € D 92

M douchebakhoekplint /
angle rentrant /
Eckformstück /
sloping shower corner piece

75030, 75040, 75060, 75070, 75100,
75110, 75120, 75130, 75160, 75170,
75200, 75210, 75220, 75230



relieftegels / carreaux en relief /
Relie iesen / relief tiles

Artikelnummer Numéro d'article Artikelnummer Item number	Bijbehorende douchebakplint Pièce courante correspondante Dazu gehörend Gefälleformstück Matching sloping shower edge tile	Bijbehorende douchebakhoekplint Angle rentrant correspondant Dazu gehörend Eckformstück Matching sloping shower corner piece
75430AS1515	75030VD1515	75030HD1515
75440AS1515	75040VD1515	75040HD1515
75460AS1515	75060VD1515	75060HD1515
75470AS1515	75070VD1515	75070HD1515
75500AS1515	75100VD1515	75100HD1515
75510AS1515	75110VD1515	75110HD1515
75520AS1515	75120VD1515	75120HD1515
75530AS1515	75130VD1515	75130HD1515
75560AS1515	75160VD1515	75160HD1515
75570AS1515	75170VD1515	75170HD1515
75600AS1515	75200VD1515	75200HD1515
75610AS1515	75210VD1515	75210HD1515
75620AS1515	75220VD1515	75220HD1515
75630AS1515	75230VD1515	75230HD1515

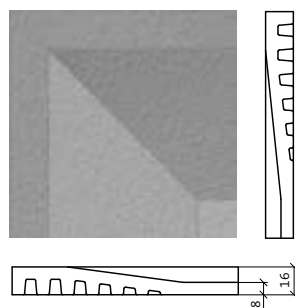
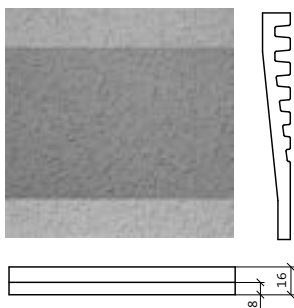

...VS1515 2040 € D 92

M douchebakplint /
pièce courante /
Gefälleformstück /
sloping shower edge tile

74000, 74020, 74030, 74040, 74050,
74060, 74070, 74090, 74110



relieftegels / carreaux en relief /
Relie iesen / relief tiles

...HS1515 2040 € D 92

M douchebakhoekplint /
angle rentrant /
Eckformstück /
sloping shower corner piece

74000, 74020, 74030, 74040, 74050,
74060, 74070, 74090, 74110



relieftegels / carreaux en relief /
Relie iesen / relief tiles

Voor uitgebreide verwerkingsadviezen zie
www.mosa.com.
On peut trouver toutes les directives de pose sur
www.mosa.com.
Für komplette Hinweise zur Verarbeitung siehe
www.mosa.com.
The complete guidelines for installation can be
found on www.mosa.com.

Accessoire	In kleur	Artikelnummer
Accessoire	En couleur	Numéro d'article
Formteil	In der Farbe	Artikelnummer
Accessory	In colour	Item number
...VD1515	+ 75030	= 75030VD1515





VD, HD, VS, HS, VM, HM, VR, HR

Globalgrip, Holland 2050, Softgrip, Core Collection Terra

vloertegels / carreaux de sol / Bodenfliesen / floor tiles
Ultragres ongeglazuurd / non émaillé / unglasiert / unglazed
vorstbestand / ingélfif / frostsicher / frost proof

accessoires / accessoires / Formteile / accessories

no.	mm	inch	pieces/ m ²	pieces/ m ¹	pieces/ box	boxes/ pallet	pieces/ pallet	m ² / pallet	kg/ m ²	kg/ pallet
103VM - 166VM	146x146x8(-16)	5.75x5.75x0.31(-0.63)	-	6,67	21 = 3,15 m ¹	80	1.680	-	-	910
103HM - 166HM	146x146x8(-16)	5.75x5.75x0.31(-0.63)	-	-	16	80	1.280	-	-	729
80010VR - 80060VR	146x146x8(-16)	5.75x5.75x0.31(-0.63)	-	6,67	21 = 3,15 m ¹	80	1.680	-	-	910
80010HR - 80060HR	146x146x8(-16)	5.75x5.75x0.31(-0.63)	-	-	16	80	1.280	-	-	729

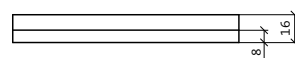
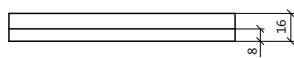
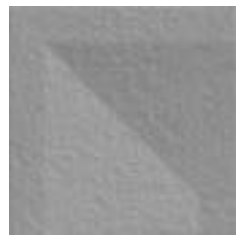

...VM1515 € D 92

M douchebakplint /
pièce courante /
Gefälleformstück /
sloping shower edge tile

103, 104, 116, 125, 126,
164, 166

R11 B C2C

reliéftegels / carreaux en relief /
Relie iesen / relief tiles

...HM1515 € D 92

M douchebakhoekplint /
angle rentrant /
Eckformstück /
sloping shower corner piece

103, 104, 116, 125, 126,
164, 166

R11 B C2C

reliéftegels / carreaux en relief /
Relie iesen / relief tiles

...VR1515 € D 92

M douchebakplint /
pièce courante /
Gefälleformstück /
sloping shower edge tile

80010, 80020, 80030, 80040, 80050,
80060

R10 B C2C

reliéftegels / carreaux en relief /
Relie iesen / relief tiles

...HR1515 € D 92

M douchebakhoekplint /
angle rentrant /
Eckformstück /
sloping shower corner piece

80010, 80020, 80030, 80040, 80050,
80060

R10 B C2C

reliéftegels / carreaux en relief /
Relie iesen / relief tiles

Artikelnummer Numéro d'article Artikelnummer Item number	Bijbehorende douchebakplint Pièce courante correspondante Dazu gehörend Gefälleformstück Matching sloping shower edge tile	Bijbehorende douchebakhoekplint Angle rentrant correspondant Dazu gehörend Eckformstück Matching sloping shower corner piece
203RM1515	103VM1515	103HM1515
204RM1515	104VM1515	104HM1515
216RM1515	116VM1515	116HM1515
225RM1515	125VM1515	125HM1515
226RM1515	126VM1515	126HM1515
264RM1515	164VM1515	164HM1515
266RM1515	166VM1515	166HM1515

Voor uitgebreide verwerkingsadviezen zie www.mosa.com.
On peut trouver toutes les directives de pose sur www.mosa.com.
Für komplette Hinweise zur Verarbeitung siehe www.mosa.com.
The complete guidelines for installation can be found on www.mosa.com.

Accessoire Accessoire Formteil Accessory	In kleur En couleur In der Farbe In colour	Artikelnummer Numéro d'article Artikelnummer Item number
...VM1515	+ 103	= 103VM1515





vloertegels / carreaux de sol / Bodenfliesen / floor tiles
 Ultragres ongeglazuurd / non émaillé / unglasiert / unglazed
 vorstbestand / ingélif / frostsicher / frost proof

accessoires / accessoires / Formteile / accessories

no.	mm	inch	pieces/ m ²	pieces/ m ¹	pieces/ box	boxes/ pallet	pieces/ pallet	m ² / pallet	kg/ m ²	kg/ pallet
75201GL - 75211GL	296x296x12,5	11.65x11.65x0.49	-	3,33	9 = 2,70 m ¹	44	396	-	-	895
75201GS - 75211GS	296x296x14,5	11.65x11.65x0.57	-	3,33	9 = 2,70 m ¹	44	396	-	-	895

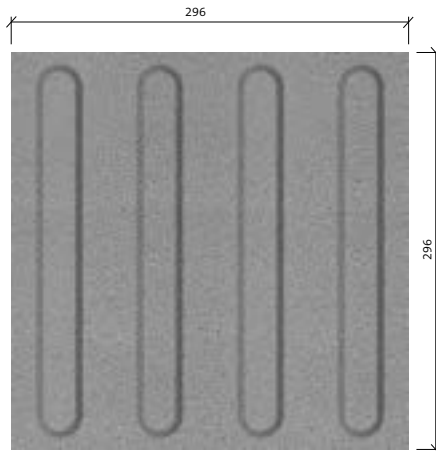

...GL3030 **€** D 248

M guideline /
 guideline /
 guideline /
 guideline

75201, 75211

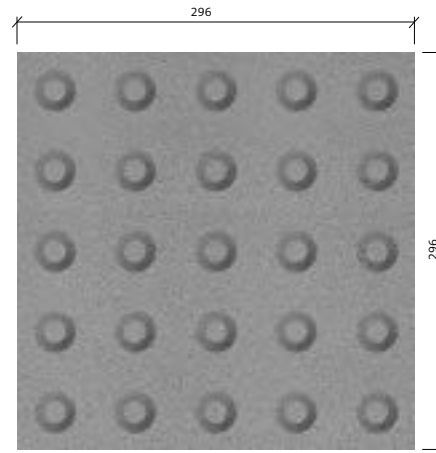

...GS3030 **€** D 248

M guidestop /
 guidestop /
 guidestop /
 guidestop

75201, 75211

Artikelnummer Numéro d'article Artikelnummer Item number	Bijbehorende guideline Guideline correspondant Dazu gehörende guideline Matching guideline	Bijbehorende guidestop Guidestop correspondant Dazu gehörende guidestop Matching guidestop
75200V .	75201GL3030	75201GS3030
75210V .	75211GL3030	75211GS3030

Accessoire Accessoire Formteil Accessory	In kleur En couleur In der Farbe In colour	Artikelnummer Numéro d'article Artikelnummer Item number
...GL3030 +	75201 =	75201GL3030





vloertegels / carreaux de sol / Bodenfliesen / floor tiles
 Ultragres ongeglazuurd / non émaillé / unglasiert / unglazed
 vorstbestand / ingélif / frostsicher / frost proof

accessoires / accessoires / Formteile / accessories

no.	mm	inch	pieces/ m ²	pieces/ m ¹	pieces/ box	boxes/ pallet	pieces/ pallet	m ² / pallet	kg/ m ²	kg/ pallet
75720BN - 76960BN	296x70x8	11.65x2.76x0.31	-	3,33	25 = 7,51 m ¹	108	2.700	-	-	1.059

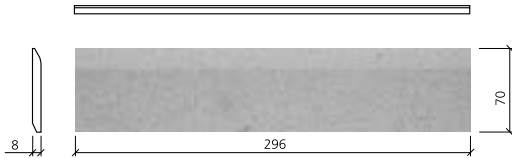

...BN307



M plint /
 plinthe droite /
 Stehsockel /
 skirting (bullnose)

✱ 75720, 75730, 75740, 75750, 75760,
 75770, 75780, 75790, 75800, 75810,
 75820, 75830, 75840, 75850, 75860,
 75870, 75880, 75900, 75910, 75920,
 75930, 76710, 76940, 76950, 76960



Artikelnummer Numéro d'article Artikelnummer Item number	Bijbehorende plint Plinthe droite correspondante Dazu gehörende Stehsockel Matching skirting
75420V .	75720BN307
75430V .	75730BN307
75440V .	75740BN307
75450V .	75750BN307
75460V .	75760BN307
75470V .	75770BN307
75480V .	75780BN307
75490V .	75790BN307
75500V .	75800BN307
75510V .	75810BN307
75520V .	75820BN307
75530V .	75830BN307
75540V .	75840BN307
75550V .	75850BN307
75560V .	75860BN307
75570V .	75870BN307
75580V .	75880BN307
75600V .	75900BN307
75610V .	75910BN307
75620V .	75920BN307
75630V .	75930BN307
76410V .	76710BN307
76640V .	76940BN307
76650V .	76950BN307
76660V .	76960BN307

Accessoire	In kleur	Artikelnummer
Accessoire	En couleur	Numéro d'article
Formteil	In der Farbe	Artikelnummer
Accessory	In colour	Item number
...BN307	+	75720
	=	75720BN307





BP Core Collection Quartz, Core Collection Solids, Core Collection Terra, Mosa Stage

vloertegels / carreaux de sol / Bodenfliesen / floor tiles
 Ultragres ongeglazuurd / non émaillé / unglasiert / unglazed
 vorstbestand / ingélif / frostsicher / frost proof

accessoires / accessoires / Formteile / accessories

no.	mm	inch	pieces/ m ²	pieces/ m ¹	pieces/ box	boxes/ pallet	pieces/ pallet	m ² / pallet	kg/ m ²	kg/ pallet
203BP - 266BP	296x95x10	11.65x3.74x0.39	-	3,33	21 = 6,31 m ¹	66	1.386	-	-	934
200BP - 5126BP	597x95x12	23.50x3.74x0.47	-	1,67	12 = 7,19 m ¹	56	672	-	-	1.071
200BP - 5112BP	897x95x13	35.31x3.74x0.51	-	1,11	6 = 5,41 m ¹	48	288	-	-	746

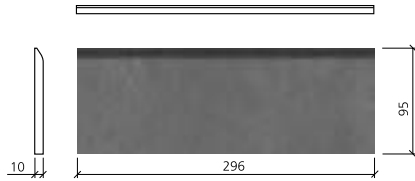

...BP3010 € D 69

M plint / plinthe droite /
 Stehsockel / skirting (bullnose)

❄ 203, 204, 206, 211, 216,
 225, 226, 227, 229, 264,
 266

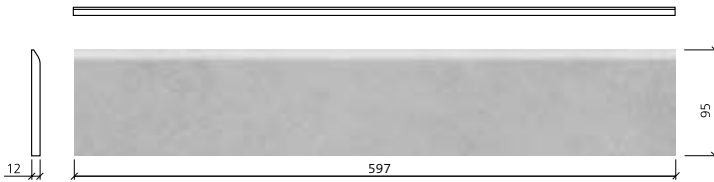

...BP6010 € D 117

M plint / plinthe droite /
 Stehsockel / skirting (bullnose)

❄ 200, 203, 204, 206, 211,
 214, 215, 216, 222, 225,
 226, 227, 229, 238, 239,
 262, 263, 264, 265, 266,
 270, 3502, 3504, 3506, 3508,
 3510, 3512, 3514, 3516, 3518,
 4101, 4102, 4103, 4104, 4105,
 4107, 5102, 5104, 5106, 5108,
 5110, 5112, 5114, 5118, 5120,
 5126

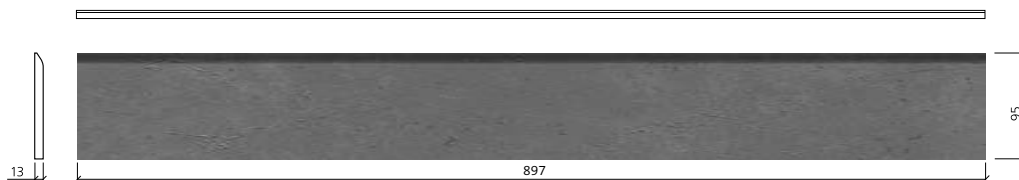

...BP9010 € D 249

M plint / plinthe droite /
 Stehsockel / skirting (bullnose)

❄ 200, 203, 204, 206, 211,
 216, 225, 226, 227, 229,
 262, 265, 3502, 3504, 3506,
 3508, 3510, 3512, 3514, 3516,
 3518, 5102, 5104, 5106, 5108,
 5110, 5112

Accessoire	In kleur	Artikelnummer
Accessoire	En couleur	Numéro d'article
Formteil	In der Farbe	Artikelnummer
Accessory	In colour	Item number
...BP3010	+	203
	=	203BP3010





vloertegels / carreaux de sol / Bodenfliesen / floor tiles
 Ultragres ongeglazuurd / non émaillé / unglasiert / unglazed
 vorstbestand / ingélif / frostsicher / frost proof

accessoires / accessoires / Formteile / accessories

no.	mm	inch	pieces/ m ²	pieces/ m ¹	pieces/ box	boxes/ pallet	pieces/ pallet	m ² / pallet	kg/ m ²	kg/ pallet
75450TR - 75630TR	296x296x8	11.65x11.65x0.31	-	3,33	13 = 3,90 m ¹	48	624	-	-	1.065

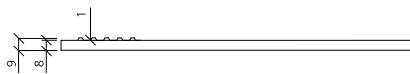
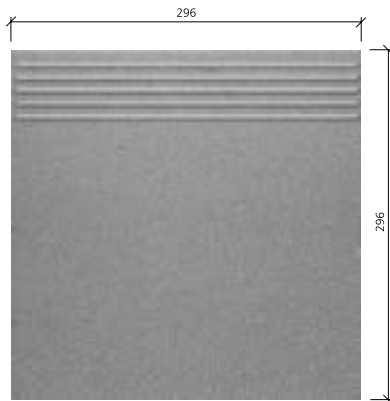

...TR3030

D 148

M traptegel (rechte voorzijde, volledige toplaag) /
 nez de marche (bord droit, pleine masse) /
 Treppenfliese (eckige Kante, durchgefärbt) /
 stair tread (straight edge, full body)



75450, 75600, 75610, 75620, 75630



R10



A



C2C

Accessoire	In kleur	Artikelnummer
Accessoire	En couleur	Numéro d'article
Formteil	In der Farbe	Artikelnummer
Accessory	In colour	Item number
..TR3030	+	75450
	=	75450TR3030



vloertegels / carreaux de sol / Bodenfliesen / floor tiles
 Ultragres ongeglazuurd / non émaillé / unglasiert / unglazed
 vorstbestand / ingélif / frostsicher / frost proof

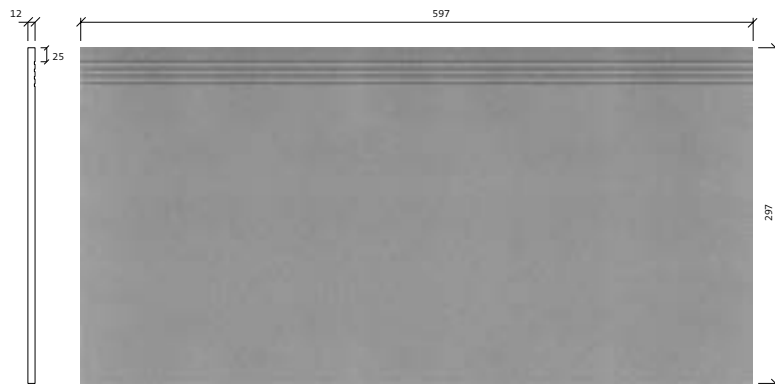

accessoires / accessoires / Formteile / accessories

no.	mm	inch	pieces/ m ²	pieces/ m ¹	pieces/ box	boxes/ pallet	pieces/ pallet	m ² / pallet	kg/ m ²	kg/ pallet
5102TVG - 5126TVG	297x597x12	11.69x23.50x0.47	-	1,67	4 = 2,40 m ¹	48	192	-	-	941
200TVG - 265TVG	297x1197x13	11.69x47.13x0.51	-	0,83	2 = 2,41 m ¹	42	84	-	-	922



...TVG3060  D 289

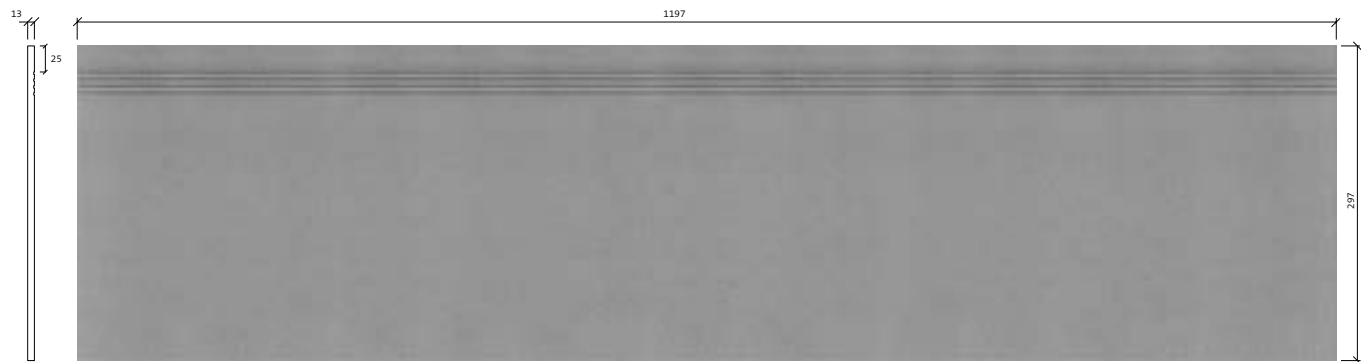

M traptegel (rechte, geglazuurde voorzijde) /
 nez de marche (bord droit, côté émaillé) /
 Treppen iese (eckige, überglastierte Kante) /
 stair tread (straight, glazed edge)

 5102, 5104, 5106, 5108, 5110,
 5112, 5114, 5118, 5120, 5126
 R10



...TVG30120  D 380

M traptegel (rechte, geglazuurde voorzijde) /
 nez de marche (bord droit, côté émaillé) /
 Treppen iese (eckige, überglastierte Kante) /
 stair tread (straight, glazed edge)

 200, 203, 204, 206, 211,
 216, 226, 227, 229, 262,
 265
 R10

Accessoire	In kleur	Artikelnummer
Accessoire	En couleur	Numéro d'article
Formteil	In der Farbe	Artikelnummer
Accessory	In colour	Item number
...TVG3060	+ 5102	= 5102TVG3060



vloertegels / carreaux de sol / Bodenfliesen / floor tiles
 Ultragres ongeglazuurd / non émaillé / unglasiert / unglazed
 vorstbestand / ingélif / frostsicher / frost proof

accessoires / accessoires / Formteile / accessories

no.	mm	inch	pieces/ m ²	pieces/ m ¹	pieces/ box	boxes/ pallet	pieces/ pallet	m ² / pallet	kg/ m ²	kg/ pallet
3502TCG - 3518TCG	297x597x12	11.69x23.50x0.47	-	1,67	4 = 2,40 m ¹	48	192	-	-	941

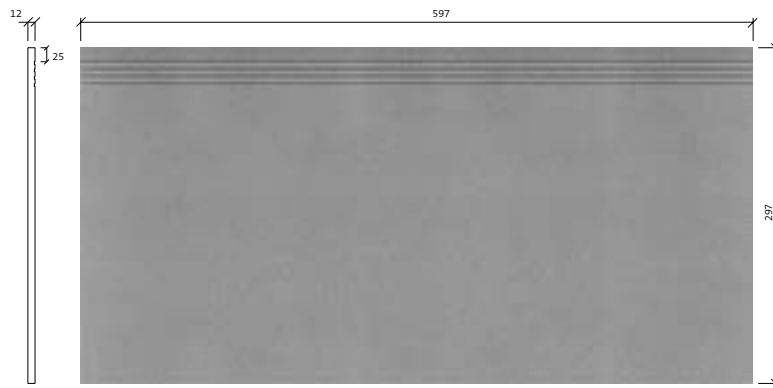

...TCG3060

€ D 289

M traptegel (rechte, geglazuurde voorzijde) /
 nez de marche (bord droit, côté émaillé) /
 Treppeniese (eckige, überglasierte Kante) /
 stair tread (straight, glazed edge)

3502, 3504, 3506, 3508, 3510,
 3512, 3514, 3516, 3518
 R10 B

Accessoire	In kleur	Artikelnummer
Accessoire	En couleur	Numéro d'article
Formteil	In der Farbe	Artikelnummer
Accessory	In colour	Item number
...TCG3060	+ 3502	= 3502TCG3060





HV Core Collection Solids, Core Collection Terra

vloertegels / carreaux de sol / Bodenfliesen / floor tiles
 Ultragres ongeglazuurd / non émaillé / unglasiert / unglazed
 vorstbestand / ingélif / frostsicher / frost proof

accessoires / accessoires / Formteile / accessories

no.	mm	inch	pieces/ m ²	pieces/ m ¹	pieces/ box	boxes/ pallet	pieces/ pallet	m ² / pallet	kg/ m ²	kg/ pallet
5102HV - 5126HV	297x597x12	11.69x23.50x0.47	-	1,67	2 = 1,20 m ¹	24	48	-	-	306
200HV - 262HV	297x1197x13	11.69x47.13x0.51	-	0,83	2 = 2,41 m ¹	22	44	-	-	541

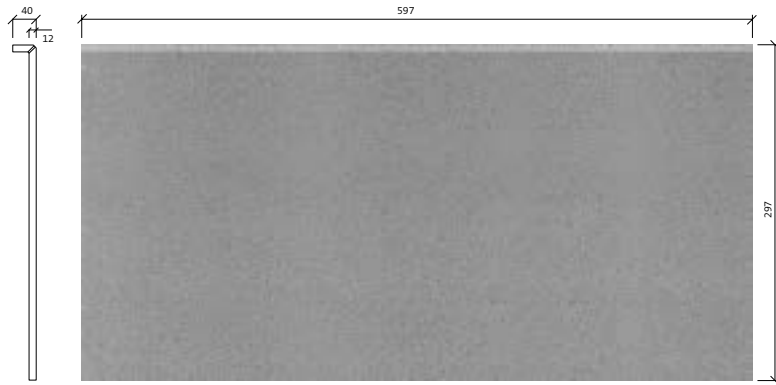

...HV3060 € D 641

M traptegel (met hoek) /
 nez de marche (avec coin) /
 Treppeniese (mit Ecke) /
 stair tread (with corner)

5102, 5104, 5106, 5108, 5110,
 5112, 5114, 5118, 5120, 5126
 R10



...HV30120 € D 676

M traptegel (met hoek) /
 nez de marche (avec coin) /
 Treppeniese (mit Ecke) /
 stair tread (with corner)

200, 203, 204, 206, 211,
 216, 226, 227, 229, 262
 R10

Accessoire	In kleur	Artikelnummer
Accessoire	En couleur	Numéro d'article
Formteil	In der Farbe	Artikelnummer
Accessory	In colour	Item number
...HV3060	+	5102
	=	5102HV3060





CS1MR, CW1MR Holland 2050

vloertegels / carreaux de sol / Bodenfliesen / floor tiles
 Ultragres ongeglazuurd / non émaillé / unglasiert / unglazed
 vorstbestand / ingélif / frostsicher / frost proof

accessoires / accessoires / Formteile / accessories

no.	mm	inch	pieces/ m ²	pieces/ m ¹	pieces/ box	boxes/ pallet	pieces/ pallet	m ² / pallet	kg/ m ²	kg/ pallet
80011CS1MR - 80051CW1MR	897x897x13	35.31x35.31x0.51	1,23	-	1 = 0,813 m ²	10	10	8,1	30,2	245

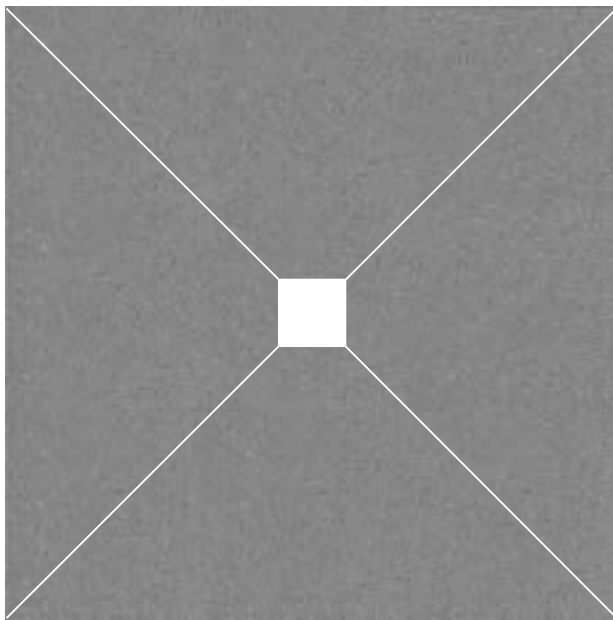

...CS1MR9090 € D 650

M douchetegel Schlüter Systems: Kerdi Shower TT 90x90 /
 shower tile Schlüter Systems: Kerdi Shower TT 90x90

80011, 80021, 80031, 80051

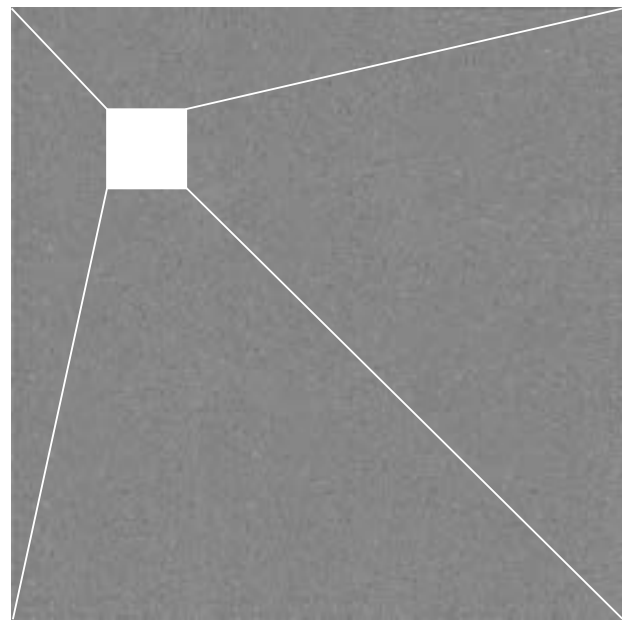

...CW1MR9090 € D 650

M douchetegel WEDI: Fundo Ligno Plus 90x90 /
 shower tile WEDI: Fundo Ligno Plus 90x90

80011, 80021, 80031, 80051

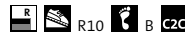

Artikelnummer Numéro d'article Artikelnummer Item number	Artikelnummer Numéro d'article Artikelnummer Item number	Bijbehorende douchetegel Schlüter Systems Shower tile correspondante Schlüter Systems Dazu gehörende shower tile Schlüter Systems Matching shower tile Schlüter Systems	Bijbehorende douchetegel WEDI Shower tile correspondante WEDI Dazu gehörende shower tile WEDI Matching shower tile WEDI
80010MR1515	80010MR3030	80011CS1MR9090	80011CW1MR9090
80020MR1515	80020MR3030	80021CS1MR9090	80021CW1MR9090
80030MR1515	80030MR3030	80031CS1MR9090	80031CW1MR9090
80050MR1515	80050MR3030	80051CS1MR9090	80051CW1MR9090

Accessoire	In kleur	Artikelnummer
Accessoire	En couleur	Numéro d'article
Formteil	In der Farbe	Artikelnummer
Accessory	In colour	Item number

...CS1MR9090 + 80011 = 80011CS1MR9090

