

RUBBER FLOORING
FOR SUSTAINABLE ARCHITECTURE



artigo

RUBBER FLOORING
FOR SUSTAINABLE ARCHITECTURE

INTRO	p 02
CERTIFICATIONS	p 06
VISIONS	p 12
TECHNICALS	p 49

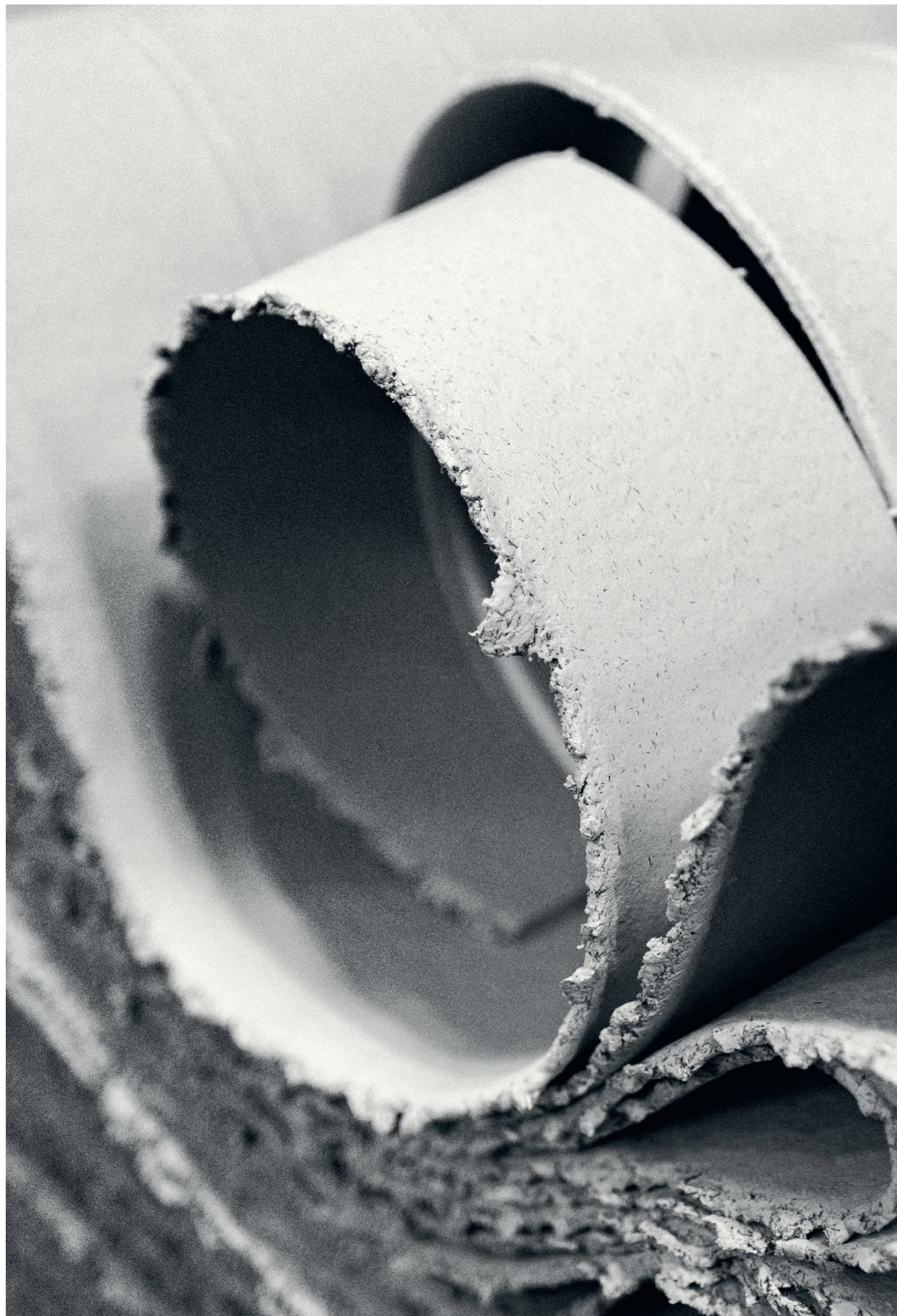

ph Valentina Sommariva

IT ALL BEGINS WITH RUBBER

Rubber is the foundation of our entire business. It has been since 1962 when the Pirelli Group gave birth to Artigo, a division dedicated to the development of rubber flooring. In 1992 the company was acquired by Gruppo Mondo, a leader in rubber surfaces for the commercial and athletic sectors. Gruppo Mondo was able to rapidly develop the rubber flooring market with the use of advanced technologies and the fundamental addition of specific skills and extensive experience.

Rubber is a raw material with few rivals where resilience and basic elasticity are concerned. Using advanced processes that perfect its characteristics we are able to increase its technical performance. The production has always taken place in Italy: from the historical plant south of Milan in the 60s, in 1995 we moved to Cairo Montenotte where production is now concentrated. The plant has grown over the years, adding a modern, high-performance "mixing room" to the department where the flooring is embossed. We work twenty-four hours a day, for minimum of 5 days a week, to avoid interrupting the process. This schedule best uses the efficiency and quality advantages of our modern vulcanising lines.

The exclusive process, engineered within the group, customized the assembly of various units of machinery. Rubber flooring production follows precise and complex rules. Unlike plastic material, the essential nature of rubber is very delicate. It demands more precision than other resilient flooring materials. While many production stages, like vulcanisation, have undergone major improvements in reduction of waste, they essentially remain those used at inception. These important aspects make us practically unique.

With the Mondo creative technology, we can now fully integrate production of flooring in sheets. Today, the vulcanization lines are simply fed with the mix and 60 m further along the sheets of finished product are automatically packed, reducing the impact of labour and consequently the cost.

We are proud to have succeeded in devising a system that allows us to automatically recover the waste generated during production. This excellent example of respect for the environment, a primary inspiration of our research, is made even more credible synergized with cost reductions, according to the principles of reduce-reuse-recycle.

La gomma è al centro di tutta la nostra attività, lo è da quando nel 1962 all'interno del Gruppo Pirelli nasce Artigo, la divisione dedicata allo sviluppo dei pavimenti in gomma. Nel 1992 l'acquisizione da parte del Gruppo Mondo, leader nel settore delle superfici in gomma in ambito commerciale e sportivo, con il rapido sviluppo di tecnologie avanzate e l'apporto fondamentale di professionalità specifiche e di grande esperienza.

La gomma è una materia prima con pochi eguali per resistenza ed elasticità di base, capace di aumentare le proprie performance tecniche attraverso processi evoluti che ne perfezionano le caratteristiche.

Da sempre la produzione avviene in Italia: prima a sud di Milano, negli anni '60, e dal 1995 nello stabilimento di Cairo Montenotte (SV). Lo stabilimento è cresciuto negli anni integrando alla stamperia dei pavimenti una "sala mescole" moderna e performante. Si lavora ventiquattro ore al giorno per almeno 5 giorni alla settimana in modo da non interrompere il processo e sfruttare al meglio tutti i vantaggi di efficienza e qualità delle nostre moderne linee di vulcanizzazione.

Il processo è esclusivo, ingegnerizzato all'interno del gruppo assemblando macchinari diversi che in questo modo vengono personalizzati. La produzione dei pavimenti in gomma segue regole precise e complesse ed ammette ancor meno imprecisioni rispetto ad altri pavimenti resilienti a causa della natura stessa della gomma, che non è un materiale plastico.

Molte fasi della produzione, come la vulcanizzazione, nonostante abbiano subito importanti migliorie a livello di riduzione degli sprechi, rimangono le stesse degli albori. Sono tutti aspetti importanti, che ci rendono praticamente unici.

La tecnologia del Gruppo Mondo ci ha permesso di integrare completamente la produzione dei pavimenti a teli. Oggi le linee di vulcanizzazione vengono semplicemente alimentate con la mescola e 60 metri più a valle si imballano automaticamente i teli di prodotto finito, riducendo così l'impatto della manodopera e di conseguenza i costi; la gomma è un materiale nobile ma non economico e il raggiungimento della massima efficienza è necessario per contenerne i costi.

Abbiamo ideato un sistema che ci consente di riuscire a recuperare gli sfridi generati nel processo automaticamente in corso di produzione: un ottimo esempio di come il rispetto dell'ambiente, che ha sempre animato la nostra ricerca, sia più credibile quando si riesce a renderlo sinergico con la riduzione dei costi, secondo i principi del reduce-reuse-recycle.



Der Kautschuk bildet den Mittelpunkt unseres Wirkens, und zwar seit 1962, als innerhalb des Konzerns Pirelli Artigo gegründet wurde, ein auf die Entwicklung von Bodenbelägen spezialisierter Unternehmensbereich. 1992 erfolgt die Übernahme durch die Mondo-Gruppe, ein führendes Unternehmen im Sektor der Kautschukoberflächen im Objekt- und Sportbereich, mit der schnellen Weiterentwicklung hochmoderner Technologien und dem ausschlaggebenden Beitrag fachspezifischer Kenntnisse und großer Erfahrung.

Kautschuk ist ein Rohstoff, dem hinsichtlich seiner grundlegenden Merkmale in Bezug auf Beständigkeit und Elastizität nur wenige ebenbürtig sind und der in der Lage ist, seine technischen Leistungen durch hoch entwickelte Verfahren zu steigern, die seine Eigenschaften perfektionieren.

Produziert wird seit jeher in Italien: Zunächst, in den Sechzigerjahren, im Süden von Mailand, später dann, ab 1995, im Werk in Cairo Montenotte in der Provinz Savona. Das Werk wuchs im Verlauf der Jahre heran, das Presswerk für die Böden wurden mit einem modernen und leistungsfähigen „Mischraum“ ergänzt. Gearbeitet wird an mindestens fünf Tagen in der Woche rund um die Uhr, um den Prozess nicht zu unterbrechen und das gesamte Leistungs- und Qualitätsvolumen unserer modernen Vulkanisationslinien optimal zu nutzen.

Bei diesem exklusiven Verfahren, das innerhalb unserer Gruppe entwickelt wurde, werden verschiedene Maschinen zusammengesetzt und auf diese Weise personalisiert. Die Fertigung von Fußböden aus Kautschuk folgt genauen und komplexen Regeln und gestattet gegenüber anderen, nachgiebigeren Böden keinerlei Ungenauigkeiten. Grund ist die Beschaffenheit des Kautschuk, der kein plastisches Material ist. Viele Fertigungsschritte, wie etwa die Vulkanisation, sind, auch wenn sie bei der Vermeidung von Materialverschwendung stark verbessert wurden, immer noch die der Anfangszeit. All das sind wichtige Aspekte, die unsere Einzigartigkeit ausmachen.

Die Technologie der Mondo Gruppe hat es uns ermöglicht, die Fertigung von Fußböden in Bahnen komplett zu integrieren. Heute werden die Vulkanisationslinien einfach mit der Mischung befüllt und 60 Meter weiter rollen sie die Bahnen des Endprodukts automatisch auf. Dadurch werden Arbeitskraft und Kosten eingespart. Kautschuk ist ein edles, aber kein preisgünstiges Produkt und nur mit höchster Effizienz gelingt es, die Kosten im Griff zu halten.

Wir haben ein System entwickelt, das es uns ermöglicht, die während des automatischen Prozesses entstehenden Materialabfälle zu verwerten. Dies ist ein hervorragendes Beispiel dafür, dass die Achtung vor der Umwelt, die unsere Forschung stets beflügelt hat, umso glaubwürdiger wird, je mehr Synergien dabei durch die Einsparung von Kosten nach den Prinzipien von Absenkung,



ph Valentina Sommariva

Le caoutchouc est au centre de toutes nos activités, et ce depuis 1962 lors de la naissance au sein du groupe Pirelli d'Artigo, la division spécialisée dans le développement des revêtements de sol. L'année 1992 a vu l'acquisition de la part du groupe Mondo, leader du secteur des surfaces en caoutchouc dans le domaine commercial et sportif, avec le développement rapide de technologies avancées et l'apport fondamental de professionnels spécifiques et de grande expérience.

Par sa résistance et son élasticité de base, le caoutchouc est une matière première ayant peu d'égal. Il est en mesure de découpler ses performances via des procédés modernes, qui en optimisent les propriétés. Depuis toujours, la production s'effectue en Italie.

D'abord au sud de Milan, dans les années 60, puis depuis 1995 dans le site de production de Cairo Montenotte, dans la province de Savona. Le site de production s'est développé au cours des années en ajoutant à l'atelier de moulage des revêtements de sol, une « salle de malaxage » moderne et performante.

On y travaille en continu, 24 h/24 h pendant 5 jours par semaine au moins, pour ne pas interrompre le procédé et exploiter au mieux tous les avantages d'efficacité et de qualité des lignes de vulcanisation avant-gardistes. Le procédé est exclusif et ingénierisé dans le groupe en assemblant des machines différentes, qui sont ensuite personnalisées.

La production des revêtements de sol en caoutchouc suit des règles précises et complexes n'admettant aucune imprécision par rapport aux autres revêtements de sol résilients en raison de la nature même du caoutchouc, qui n'est pas un matériau plastique.

Même si elles ont été soumises à de nombreuses avancées au niveau de la réduction des déchets, plusieurs étapes de production, telle que la vulcanisation, sont les mêmes depuis le début. Ce sont tous des aspects importants qui nous rendent pratiquement uniques.

La technologie du Groupe Mondo a permis d'intégrer complètement la production des revêtements de sol en lès. Aujourd'hui, les lignes de vulcanisation sont simplement alimentées avec le mélange et 60 m plus en aval, les lès de produit fini sont conditionnés automatiquement, en réduisant ainsi la main-d'œuvre et donc les coûts.

Nous avons conçu un système permettant de recycler les déchets produits au cours de la production. Un excellent exemple pour la préservation de l'environnement qui anime l'entreprise, en l'intégrant à la réduction des coûts selon le principe de « reduce-reuse-recycle » (réduire, réutiliser et recycler).

Todas nuestras actividades se basan en el caucho, desde que en 1962 en el marco del Grupo Pirelli se fundó Artigo, la división dedicada al desarrollo de pavimentos. En 1992 tuvo lugar su adquisición por parte del Grupo Mondo, líder en el sector de las superficies de caucho a nivel comercial y deportivo, con el rápido desarrollo de tecnologías avanzadas y la aportación esencial de profesionales con experiencia.

La goma es una materia prima difícilmente igualable por su resistencia y su elasticidad básica, capaz de aumentar sus prestaciones técnicas a través de procesos avanzados que perfeccionan sus características.

Desde siempre, la producción se realiza en Italia: primero en el sur de Milán, en los años 60, y desde 1995, en la planta de Cairo Montenotte (SV). La planta ha crecido a lo largo de los años integrando en la prensa de pavimentos una «sala de mezclas» moderna y de alto rendimiento.

Se trabaja veinticuatro horas al día durante al menos 5 días a la semana para no interrumpir el proceso y aprovechar al máximo todas las ventajas de eficiencia y calidad de nuestras modernas líneas de vulcanización.

El proceso es exclusivo, diseñado dentro del grupo ensamblando maquinaria diversa que de este modo se personaliza. La producción de pavimentos de goma sigue reglas precisas y complejas y admite aún menos imprecisiones que otros pavimentos resilientes a causa de la propia naturaleza de la goma, que no es un material plástico. Muchas fases de la producción, como la vulcanización, aunque se hayan mejorado mucho a nivel de reducción de desperdicios, siguen siendo las mismas que se utilizaban en los albores. Todos son aspectos importantes que nos hacen prácticamente únicos.

La tecnología del Grupo Mondo nos ha permitido integrar completamente la producción de los pavimentos de lonas. En la actualidad, las líneas de vulcanización se alimentan simplemente con la mezcla y 60 metros más abajo se embalan automáticamente las lonas de producto acabado, reduciendo así el impacto de la mano de obra y por consiguiente los costes; la goma es un material noble, pero no económico y es necesario alcanzar la máxima eficiencia para reducir sus costes.

Hemos ideado un sistema que nos permite lograr recuperar los desperdicios generados en el proceso automáticamente en curso de producción: un óptimo ejemplo de cómo el respeto del medio ambiente, que siempre ha impulsado nuestra investigación, es más creíble cuando se logra combinarlo con la reducción de costes, según los principios del reduce-reuse-recycle.

SUSTAINABILITY, CERTIFIED

The topic of sustainable architecture is of crucial importance for companies like Artigo, whose products are placed in large public or private buildings. Hospitals, libraries, and schools provide services for the community while also creating environments that are open to all and that must increasingly be oriented towards collective health and well-being. Artigo's first commitment is to the people who use our floors: we work for them constantly to ensure that our products are free of PVC, heavy metals, halogens and volatile plasticizers, guaranteeing reduced VOC emissions. But the impact of a work of architecture, with all its constituent elements, must also be evaluated in terms of the broader ecosystem. We therefore base our sustainability on real and numerically verifiable objectives and have our floors tested by the most prestigious international standards, which has earned us an increasing number of environmental certifications. The professionals who choose our products can verify our compliance with the most important international standards with complete transparency. These standards are part of an integrated and sustainable process shared by the main construction companies and the most prestigious design firms in the world.

Il tema dell'architettura sostenibile è diventato imprescindibile per aziende come Artigo, che collocano i propri prodotti in costruzioni di grandi dimensioni, pubbliche o private. Un ospedale, una biblioteca, una scuola rappresentano un servizio alle rispettive comunità e, nello stesso tempo, definiscono degli spazi di fruizione aperti a tutti, che sempre più si devono orientare verso la salute e il benessere collettivo. Il primo impegno di Artigo è proprio verso le persone che usufruiscono dei nostri pavimenti: per loro lavoriamo costantemente per assicurare che i nostri prodotti siano privi di pvc, metalli pesanti, alogeni e plastificanti volatili, garantendo ridotte emissioni di VOC. Ma è altrettanto importante riconoscere l'impatto di un'architettura, con tutti gli elementi che la compongono, in un contesto di ecosistema. In questo senso, abbiamo scelto di fondare la nostra sostenibilità su obiettivi reali e numericamente verificabili, facendo testare i nostri pavimenti dai più prestigiosi standard internazionali, acquisendo così un sempre maggior numero di certificazioni ambientali. I professionisti che scelgono i nostri prodotti possono verificare, in modo totalmente trasparente, il nostro rispetto dei più importanti standard internazionali, gli stessi che fanno parte del medesimo processo integrato e sostenibile condiviso dai più prestigiosi studi di progettazione del mondo e dalle principali aziende edilizie.

Le thème de l'architecture durable est devenu incontournable pour des entreprises comme Artigo, qui installent leurs produits dans de grands bâtiments publics ou privés. Un hôpital, une bibliothèque, une école représentent un service à leurs communautés respectives tout en définissant des espaces d'utilisation ouverts à tous, qui doivent de plus en plus être orientés vers la santé et le bien-être collectif. Le premier engagement d'Artigo est précisément envers les personnes qui utilisent nos revêtements de sol : nous travaillons constamment pour elles afin d'assurer des produits exempts de PVC, de métaux lourds, d'halogènes et de plastifiants volatils dans le but de garantir une réduction des émissions de COV. Mais il est tout aussi important de reconnaître l'impact d'une architecture, avec tous les éléments qui la composent, dans un contexte écosystémique. En ce sens, nous avons choisi de fonder notre durabilité sur des objectifs réels et numériquement vérifiables, en faisant tester nos revêtements de sol par les organismes de contrôle internationaux les plus prestigieux, ce qui nous a permis d'acquérir un nombre croissant de certifications environnementales. Les professionnels qui choisissent nos produits peuvent vérifier, en toute transparence, notre conformité aux normes internationales les plus importantes, celles qui font partie du processus intégré et durable partagé par les plus grands bureaux de conception au monde et par les principales entreprises de construction.

Für Unternehmen wie Artigo, dessen Produkte in großen, öffentlichen oder privaten Bauten eingesetzt werden, ist das Thema der nachhaltigen Architektur in den Mittelpunkt gerückt. Ein Krankenhaus, eine Bibliothek oder eine Schule dienen den jeweiligen Gemeinschaften und definieren gleichzeitig der Öffentlichkeit zugängliche Räume, die zunehmend auf kollektive Gesundheit und Wohlbefinden ausgerichtet sein müssen. Zunächst engagiert sich Artigo gerade für jene, die unsere Böden nutzen: Für sie arbeiten wir ständig daran, dass unsere Produkte frei von PVC, Schwermetallen, Halogenen und flüchtigen Weichmachern sind, um die VOC-Emissionen zu reduzieren. Jedoch ist es ebenso wichtig, die Auswirkungen einer Architektur, einschließlich all ihrer Bestandteile, im Kontext eines Ökosystems zu erkennen. In dieser Hinsicht haben wir uns entschieden, unsere Nachhaltigkeit auf reale und numerisch überprüfbare Ziele zu stützen, und lassen unsere Böden nach den renommiertesten internationalen Standards testen. Dadurch erhalten wir eine zunehmende Anzahl von Umweltzertifizierungen. Fachleute, die sich für unsere Produkte entscheiden, können unsere Einhaltung der wichtigsten internationalen Standards völlig transparent überprüfen. Diese sind Teil desselben integrierten und nachhaltigen Prozesses, der von den renommiertesten Designstudios der Welt und von den wichtigsten Bauunternehmen angewendet wird.

El tema de la arquitectura sostenible se ha convertido en una cuestión esencial para empresas como Artigo, que montan sus productos en grandes edificios públicos o privados. Los hospitales, las bibliotecas y las escuelas ofrecen un servicio a sus comunidades y, al mismo tiempo, constituyen espacios de disfrute abiertos a todos, que deben orientarse cada vez más hacia la salud y el bienestar colectivo. El primer compromiso de Artigo es precisamente con las personas que utilizan nuestros pavimentos: trabajamos constantemente para ellos, a fin de garantizar que nuestros productos no contengan PVC, metales pesados, halógenos ni plastificantes volátiles, garantizando una baja emisión de COV. Pero también es importante reconocer el impacto de la arquitectura, con todos sus elementos constitutivos, en el contexto de un ecosistema. En este sentido, hemos optado por basar nuestra sostenibilidad en objetivos reales y numéricamente verificables, haciendo que nuestros pavimentos cumplan las normas internacionales más prestigiosas y obteniendo cada vez más certificaciones medioambientales. Los profesionales que eligen nuestros productos pueden comprobar, de forma totalmente transparente, que cumplimos las normas internacionales más importantes, las mismas que forman parte de ese proceso integrado y sostenible que comparten los estudios de diseño más prestigiosos del mundo y las principales empresas constructoras.

CRADLE TO CRADLE CERTIFIED®



Cradle to Cradle Certified® is a globally recognised measure of safer, more sustainable products made for the circular economy. Aimed at having a positive impact on people and the planet, Cradle to Cradle® design principles apply to product assessed for environmental and social performance across five critical sustainability categories: material health; material reutilization; renewable energy and carbon management; water stewardship; social fairness. Cradle to Cradle Certified® is recognised as a preferred product certification by many organisations and sustainability standards, including BREEAM and LEED.

Cradle to Cradle Certified® è uno standard di misurazione riconosciuto a livello internazionale, che identifica prodotti più sicuri e sostenibili fatti per l'economia circolare. Con l'obiettivo di avere un impatto positivo sulle persone e sul pianeta, i principi stabiliti da Cradle to Cradle® si applicano a prodotti valutati nelle loro performances ambientali e sociali, attraverso cinque categorie di sostenibilità: salubrità dei materiali; riutilizzo dei materiali; energia rinnovabile e Carbon Management; tutela dell'acqua; equità sociale. Cradle to Cradle Certified® è riconosciuto da molte organizzazioni e standard di sostenibilità, fra cui BREEAM e LEED.

Cradle to Cradle Certified® est un label mondialement reconnu attribué à des produits plus sûrs et plus durables s'inscrivant dans l'économie circulaire. Les principes de conception Cradle to Cradle® visent une empreinte positive sur les personnes et la planète et s'appliquent à des produits évalués pour leurs performances environnementales et sociales dans cinq domaines de durabilité critiques : toxicité des matériaux; réutilisation des matériaux; énergie renouvelable et gestion du carbone; gestion de l'eau; responsabilité sociale. Nombreuses sont les organisations et systèmes de certification environnementale, y compris BREEAM et LEED, qui ont adopté la certification Cradle to Cradle Certified® pour les produits.

Cradle to Cradle Certified® ist ein weltweit anerkannter Maßstab für sicherere, nachhaltigere Produkte, die für die Kreislaufwirtschaft hergestellt werden. Die Cradle to Cradle®-Designprinzipien zielen darauf ab, eine positive Auswirkung auf die Menschen und den Planeten zu haben.

Sie gelten für Produkte, die in fünf kritischen Nachhaltigkeitskategorien auf ihre Leistungen im sozialen und ökologischen Bereich geprüft werden: Materialgesundheit; Kreislauffähigkeit des Materials; Erneuerbare Energien und Kohlenstoffmanagement; Verantwortungsvoller Umgang mit Wasser; Soziale Gerechtigkeit. Cradle to Cradle Certified® wird von vielen Organisationen und Nachhaltigkeitsstandards, darunter BREEAM und LEED, als bevorzugte Produktzertifizierung anerkannt.

Cradle to Cradle Certified® es un sistema de certificación mundialmente reconocido de productos más seguros y sostenibles, fabricados para la economía circular. El objetivo de Cradle to Cradle® es lograr un impacto positivo en las personas y el planeta. Por eso, sus principios de diseño se aplican a los productos que se evalúan en función de su comportamiento medioambiental y social en cinco categorías clave de sostenibilidad: salud de los materiales; reutilización de materiales; energía renovable y gestión del carbono; gestión del agua; equidad social. Cradle to Cradle Certified® es una certificación de producto prestigiosa y reconocida por muchas organizaciones y normas de sostenibilidad, como BREEAM y LEED.

Certified products
Granito, Grain, Kayar, Nd Uni, Natura, Dharma, Screed, Lava, Zeus

BLAUER ENGEL



www.blauer-engel.de/uz120

Identifies the best products from an ecological and environmental point of view; it ensures the non-toxicity of the finished product and its components, and ensures very low VOC emissions within buildings.

Identifica i migliori prodotti a livello ecologico ed ambientale; assicura la non tossicità del prodotto finito e dei suoi componenti, e garantisce bassissime emissioni VOC all'interno degli edifici.

Identifie les produits les plus performants d'un point de vu écologique et environnemental. Il garantit la non toxicité du produit de ses composants, ainsi que la très faible émission de COV dans les bâtiments.

Das renommierte deutsche Umweltzeichen, das die besten Produkte aus ökologischer und umweltpolitischer Sicht kennzeichnet. Das Siegel gewährleistet die Unbedenklichkeit des Endprodukts und seiner einzelnen Komponenten, sowie sehr niedrige VOC-Emissionen innerhalb von Gebäuden.

Identifica a los mejores productos a nivel ecológico y ambiental; garantiza la no toxicidad del producto acabado y de sus componentes, y asegura muy bajas emisiones de VOC dentro de los edificios.

Certified products
Nd Uni, Kayar, Grain, Granito, Zeus, Screed, Natura, Lava, Dharma, BS



Gives assurance that products designed for use in indoor spaces (and thus providing good indoor air quality) meet strict chemical emissions limits, which contribute to the creation of healthier interiors. Ensures that a product has met some of the world's most rigorous and comprehensive standards for low emissions of volatile organic compounds (VOCs) into indoor air. The Greenguard Gold standard includes health based criteria for additional chemicals and also requires lower total VOC emissions levels to ensure that products are acceptable for use in environments such as schools and healthcare facilities.

Assicura che un prodotto progettato per installazione in interni rispetti severi limiti di emissioni chimiche, contribuendo così alla creazione di spazi interni più salubri. È la garanzia che un prodotto è stato sottoposto ai più severi standard del mondo per la bassa emissione di VOC.

La certificazione Greenguard Gold stabilisce uno standard ancora più severo per quanto riguarda le emissioni di VOC (escludendone in assoluto ben 360) e inoltre prende in esame uno spettro più ampio di sostanze chimiche, per garantire che un prodotto può essere usato in assoluta sicurezza all'interno di scuole, ospedali o ambulatori.

Assure qu'un produit conçu pour un usage interne soit conforme aux seuils stricts d'émissions chimiques et contribue à la création de lieux sains. C'est la garantie qu'un produit a été soumis aux tests les plus sévères au monde en matière d'émission de VOC.

La certification Greenguard Gold établit un standard encore plus strict sur les émissions de VOC (en excluant bien 360) et prend en examen un spectre plus large de substances chimiques afin de garantir qu'un produit est utilisable en toute sécurité au sein d'écoles, hôpitaux ou cabinets médicaux.

Das Zertifizierungsprogramm Greenguard gewährleistet, dass ein für Innenräume entwickeltes Produkt strenge Beschränkungen für die Emission chemischer Stoffe einhält und damit zur Schaffung gesünderer Innenräume beiträgt. Es garantiert, dass ein Produkt den weltweit strengsten Prüfungen zu niedrigen VOC-Emissionen unterzogen wurde.



The lowest emission class of the Finnish voluntary emission classification system, and requires VOC and formaldehyde testing in an emission chamber after 28 days. It includes an odour testing, distinguishing the M1 label from any other low VOC specification around the Globe.

La classificazione volontaria finlandese delle emissioni dei materiali da costruzione. M1 è il nome della classe di emissioni più bassa di questo sistema e richiede il test di VOC e formaldeide in una camera di emissione dopo 28 giorni. Include un test dell'odore, distinguendo l'etichetta M1 da qualsiasi altra specifica a basso VOC in tutto il mondo.

Le niveau de "classe d'émission" le plus performant de cette évaluation, qui quantifie les COV et formaldéhyde dans une chambre d'émissions après 28 jours. Un test olfactif (odeurs) est également inclus, ce qui distingue l'étiquette M1 de tous les autres labels de par le monde qui garantissent aussi la faible teneur en COV d'un matériau de construction.

Die freiwillige finnische Emissionsklassifizierung von Baumaterialien. M1 steht in der Tat für die niedrigste Emissionsklasse dieses Systems und es erfordert eine VOC- und Formaldehydprüfung in einer Emissionskammer nach 28 Tagen. Es beinhaltet eine Geruchsprüfung, die das M1-Label von allen anderen Emissions-Spezifikationen weltweit unterscheidet.

La clasificación de emisiones voluntarias finlandesas de materiales de construcción. M1 es de hecho el nombre de la clase de emisión más baja de ese sistema, y requiere pruebas de VOC y formaldehído en una cámara de emisión después de 28 días. Incluye una prueba de olor, distinguiendo la etiqueta M1 de cualquier otra especificación de VOC baja en todo el planeta.

Certified products

Nd Uni, Kayar, Grain, Granito, Zeus, Screed, Natura, Lava, Dharma, BS



Shows compliance of product emissions with the criteria of all legal specifications issued by authorities in the European Union and its Member States and also with most of the voluntary labels on VOC emissions from products. This makes Indoor Air Comfort GOLD the most ambitious low-emitting label in whole Europe. Indoor Air Comfort GOLD include more than testing: this program includes an internal quality program at the production site to ensure continuous manufacture of low-emitting products, including on-site audits, re-testing and certification – all together giving a very high level of reliability of the statement on very low VOC emissions.

Questa certificazione prova la conformità ai requisiti legali sulle emissioni (VOC) dei prodotti da costruzione imposti dalle varie Autorità nell'Unione Europea e dai relativi Stati Membri, ma risponde anche ai requisiti della maggior parte delle etichette volontarie sulle emissioni dei VOC. Ciò rende Air Comfort GOLD l'etichetta più ambiziosa esistente in Europa sulle emissioni dei prodotti. Indoor Air Comfort GOLD non è solo un test ma un programma completo di certificazione che include: un programma qualità interno del produttore atto a sostenere una continua attenzione alla produzione di materiali basso-emissivi, audit regolari presso il produttore, test di verifica, il tutto al fine di garantire una completa ed elevata affidabilità delle caratteristiche dei prodotti certificati.

Cette certification montre la conformité d'un produit aux critères de faibles émissions de COV définis par les autorités de l'Union européenne et de ses États membres. La certification GOLD prend également en compte les critères de nombreuses spécifications volontaires émises par les écolabels les plus pertinents. Cela fait d'Indoor Air Comfort GOLD l'étiquette la plus ambitieuse à faible émission sur le continent Européen. Indoor Air Comfort GOLD comprend plus que des tests. Ces programmes incluent un contrôle de qualité interne sur le site de production pour assurer la fabrication continue de produits à faible émission, y compris des audits sur site, des tests et une certification, le tout donne un très haut niveau de fiabilité et de déclaration sur les très bas niveau d'émission de COV.

Dieses bescheinigung zeigt die Einhaltung der Anforderungskriterien für Produktemissionen aller gesetzlichen Vorgaben von Behörden in der Europäischen Union und ihren Mitgliedsstaaten sowie mit den meisten freiwilligen Labels für VOC-Emissionen von Bauprodukten. Dies macht Indoor Air Comfort GOLD zum ehrgeizigsten Label für niedrige Emissionswerte in ganz Europa. Indoor Air Comfort GOLD umfasst mehr als nur Tests: Dieses Programm umfasst ein internes Qualitätsprogramm am Produktionsstandort, um die kontinuierliche Herstellung von Bauprodukten mit niedrigen Emissionswerten zu gewährleisten, einschließlich Audits vor Ort, wiederkehrende Tests und Zertifizierung – alles zusammengenommen ergibt sich ein sehr hohes Maß an Zuverlässigkeit der Aussage über sehr niedrige VOC-Emissionen.

Esta certificación muestra el cumplimiento de las emisiones del producto con los criterios de todas las especificaciones legales emitidas por las autoridades de la Unión Europea y sus Estados miembros y también con la mayoría de las etiquetas voluntarias sobre emisiones de VOC de los productos. Esto hace que Indoor Air Comfort GOLD sea la etiqueta de producto más ambiciosa en toda Europa. Indoor Air Comfort GOLD incluye más que pruebas: este programa incluye un programa de calidad interna en el sitio de producción para garantizar la fabricación continua de productos de baja emisión, incluidas auditorías in situ, nuevas pruebas y certificación, todo en conjunto, lo que brinda un nivel muy alto de fiabilidad de la declaración sobre emisiones de COV muy bajas.

Certified products

Zeus, Granito, Kayar, Lava, Natura, Dharma, Screed, Uni, Grain, BS, Ant 48

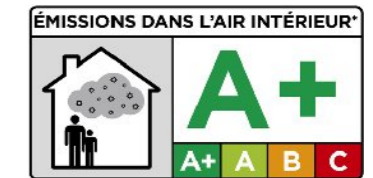

Certifying in a simple and direct way the level of emissions of volatile organic compounds according to French law. All of our products have obtained the highest class A+.

Certifica in modo semplice e diretto il livello di emissioni dei composti organici volatili secondo la legge francese. La lettera indica la classe di emissione e tutti i nostri prodotti hanno ottenuto la classe più nobile A+.

Le label atteste de façon simple et direct le niveau de composés organiques volatils conformément à la loi française. La lettre indique la classe d'émission, l'ensemble de nos produits ont obtenu la classe la plus valorisante A+.

Das Label, das auf einfache und direkte Weise das Emissions-Level von flüchtigen organischer Verbindungen (VOC) nach dem französischen Recht bescheinigt. Die Emissionsklasse wird in Buchstabe kategorisiert und alle unsere Produkte haben die bestmögliche Klasse A+ erhalten.

La etiqueta debe certificar de forma sencilla y directa el nivel de las emisiones de compuestos orgánicos volátiles de acuerdo con la legislación francesa. La letra indica la clase de emisión y todos nuestros productos han obtenido la más noble clase A+.

Certified products

Nd Uni, Kayar, Grain, Granito, Zeus, Screed, Natura, Lava, Dharma, BS, LL, X-Elastic, Ant 48



The Green Building Council Italy is a non profit organization that is part of the international network of GBC present in many other countries; it is a member of the World GBC and partner of USGBC. These associations share the objectives of promoting and accelerating the creation of a building culture of sustainability, raising public awareness and the institutional standards on the impact that the methods of design and construction of buildings have on the quality of life of citizens, providing clear parameters to the industry, encouraging the comparison between the industry by creating a community of sustainable building. Artigo is member of GBC Italy since 2010.

Il Green Building Council Italia è un'associazione no profit che fa parte della rete internazionale dei GBC presenti in molti altri paesi: è membro del World GBC e partner di USGBC. Con queste associazioni condivide gli obiettivi di favorire e accelerare la diffusione di una cultura dell'edilizia sostenibile, sensibilizzare l'opinione pubblica e le istituzioni sull'impatto che le modalità di progettazione e costruzione degli edifici hanno sulla qualità della vita dei cittadini, fornire parametri di riferimento chiari agli operatori del settore, incentivare il confronto tra gli operatori del settore creando una community dell'edilizia sostenibile. Artigo è socio del GBC Italia dal 2010.

Le Conseil du bâtiment durable Italien est un organisme à but non lucratif qui fait partie du réseau international GBC présent dans de nombreux autres pays. Il est un membre du World GBC et partenaire de l'USGBC. Avec ces associations, ils partagent les objectifs de promotion et de diffusion d'une culture durable, par la sensibilisation du public et des institutions, de l'impact sur la qualité de vie des citoyens, des méthodes de conception et de construction des bâtiments. Il fournit des paramètres références clairs à l'industrie, encourage la comparaison entre industrie, en créant une communauté de la construction durable. Artigo est membre du GBC Italie depuis 2010.

Das Green Building Council Italien ist eine gemeinnützige Organisation und Teil des internationalen Netzwerks von GBC, das in vielen Ländern vertreten ist. Es ist ein Mitglied des „World Green Building Councils“ und Partner der „USGBC“. Diese Verbände haben das gemeinsame Ziel der Förderung und schnelleren Verbreitung einer Kultur der Nachhaltigkeit, Sensibilisierung der Öffentlichkeit und Institutionen, dass Design und Konstruktion eines Gebäudes Einfluss auf die Lebensqualität der Bürgerinnen und Bürger haben. Sie stellen der Industrie klare Parameter zur Verfügung und fördern den Vergleich von Industrieprodukten durch die Schaffung einer Gemeinschaft des nachhaltigen Bauens. Artigo ist seit 2010 Mitglied der GBC Italien.

El Green Building Council Italia es una organización sin fines de lucro que forma parte de la red internacional de GBC presente en muchos otros países; es miembro del GBC Mundial y socio de USGBC. Con estas asociaciones comparten los objetivos de promover y acelerar la difusión de una cultura de sostenible, aumentar la conciencia pública y de las instituciones sobre el impacto que los métodos para el diseño y construcción de edificios tienen en la calidad de vida de los ciudadanos, proporcionando parámetros clara referencia a la industria, el fomento de la comparación entre la industria mediante la creación de una comunidad de la construcción sostenible. Artigo es miembro del GBC Italia desde 2010.



The Guarantee of Origin (GO) is an electronic certification that certifies the renewable origin of the sources used by the plants, and is able to guarantee that the electricity it uses in its production plants comes 100% from renewable sources: wind, sun, water.

Artigo ha acquisito la Garanzia di Origine (GO), una certificazione elettronica che attesta l'origine rinnovabile delle fonti utilizzate dagli impianti. Artigo è in grado di garantire che l'elettricità che utilizza nei propri impianti di produzione proviene al 100% da fonti rinnovabili: vento, sole, acqua.

Artigo a acquisi cette Garantie d'Origine. Nous garantissons que l'électricité utilisée au sein de notre usine de production provient à 100 % de sources renouvelables: vent, soleil, eau.

Artigo wurde mit dem Herkunftsnachweis (GO) zertifiziert. Dies ist ein elektronisches Zertifikat, das die Herkunft aus erneuerbaren Quellen bescheinigt. Artigo kann garantieren, dass der für die Produktionsanlagen benötigte Strom, zu 100% aus erneuerbaren Quellen stammt: Wind, Sonne, Wasser.

Artigo ha conseguido la Garantía de Origen (GO), una certificación electrónica que atestigua el origen renovable de las fuentes utilizadas por las plantas. Artigo es capaz de garantizar que la electricidad que utiliza en sus instalaciones de producción proviene al 100% de fuentes renovables: viento, sol, agua.



The international standard that outlines the modalities to achieve high performance by implementing processes to improve operational efficiency at all levels. It aims to enhance customer satisfaction through the quality assurance process and that products are compliant with the applicable requirements.

Lo standard internazionale che delinea le modalità per raggiungere alte prestazioni mettendo in atto processi che consentono di migliorare l'efficienza operativa a tutti i livelli. Mira ad aumentare la soddisfazione del cliente attraverso l'assicurazione della qualità dei processi e che i prodotti siano in conformità con i requisiti applicabili.

La norme internationale qui décrit les moyens d'atteindre la haute performance, par la mise en œuvre de processus qui améliorent l'efficacité opérationnelle à tous les niveaux. Elle vise à améliorer la satisfaction du client, à travers le processus d'assurance qualité, et la conformité des produits avec les exigences applicables.

Der internationale Standard, der die Modalitäten zur Erreichung hoher Leistungen durch die Implementierung von Prozessen zur Verbesserung der betrieblichen Effizienz auf allen Ebenen umreißt. Es zielt darauf ab, die Kundenzufriedenheit durch den Qualitätssicherungsprozess zu erhöhen und sicherzustellen, dass die Produkte den geltenden Anforderungen entsprechen.

La norma internacional que describe maneras de lograr un alto rendimiento mediante la implementación de procesos para mejorar la eficiencia operativa en todos los niveles. Su objetivo es mejorar la satisfacción del cliente a través del proceso de aseguramiento de la calidad y que los productos están en conformidad con los requisitos aplicables.



The internationally recognized standard for the certification of the environmental management system of a company that provides a systematic framework for the integration of practices to protect the environment, prevent pollution, reduce the amount of waste, consumption of energy and materials.

Lo standard riconosciuto a livello internazionale per la certificazione del Sistema di Gestione Ambientale di un'azienda che fornisce un quadro sistematico per l'integrazione delle pratiche a protezione dell'ambiente, prevenendo l'inquinamento, riducendo l'entità dei rifiuti, il consumo di energia e dei materiali.

La norme reconnue internationalement pour la certification du système de management environnemental d'une entreprise. Elle fournit un cadre systématique pour l'intégration des pratiques de protection de l'environnement, prévention de la pollution, réduction des déchets, diminution des consommations d'énergie et de matériaux.

Der international anerkannte Standard für die Zertifizierung des Umweltmanagementsystems eines Unternehmens, der einen systematischen Rahmen für die Integration von Praktiken zum Schutz der Umwelt, zur Vermeidung von Umweltverschmutzung, zur Reduzierung von Abfall, Energie- und Materialverbrauch bietet.

El estándar reconocido internacionalmente para la certificación del sistema de gestión ambiental de una empresa que ofrece un marco sistemático para la integración de las prácticas para proteger el medio ambiente, la prevención de la contaminación, lo que reduce la cantidad de residuos, el consumo energía y materiales. La empresa se dedica a un general del proceso dinámico y continuo es necesario para alcanzar las metas más ambiciosas en términos de desempeño ambiental.

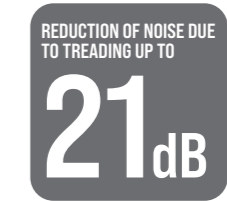

Reduction of noise due to treading up to 21 dB. Reference standard EN ISO 10140-1: 2016 – EN ISO 10140-3:2010 – EN ISO 717-2:2013. Certified by CSI, test report 0041/DC/ACU/18_2 date 08/06/2018. Also certified by Cofrac/CSTB for noise reduction 18 dB. All test reports available on request.

Riduzione del rumore da calpestio fino a 21 dB. Norme di riferimento EN ISO 10140-1: 2016 – EN ISO 10140-3:2010 – EN ISO 717-2:2013. Certificazione CSI, test report 0041/DC/ACU/18_2 in data 08/06/2018. Certificati anche da Cofrac/CSTB fino a 18 dB. Tutti i risultati dei test sono disponibili su richiesta.

Diminution du bruit de piétinement jusqu'à 21 dB. Normes de référence EN ISO 10140-1: 2016 – EN ISO 10140-3:2010 – EN ISO 717-2:2013. Certification CSI, test report 0041/DC/ACU/18_2 du 08/06/2018. Certifiés aussi par Cofrac/CSTB jusqu'à 18 dB. Tous les résultats des tests sont disponibles sur demande.

Trittschalldämpfung bis 21 dB. Referenznormen EN ISO 10140-1: 2016 – EN ISO 10140-3:2010 – EN ISO 717-2:2013. CSI-Zertifizierung, Testbericht 0041/DC/ACU/18_2 vom 08.06.2018. Zertifizierungen auch von Cofrac/CSTB bis zu 18 dB. Alle Prüfergebnisse sind auf Anfrage erhältlich.

Reducción del ruido de las pisadas hasta 21 dB. Normas de referencia EN ISO 10140-1: 2016 – EN ISO 10140-3:2010 – EN ISO 717-2:2013. Certificación CSI, informe de la prueba 0041/DC/ACU/18_2 con fecha de 08/06/2018. También están certificados por Cofrac/CSTB hasta 18 dB. Los resultados de todas las pruebas están disponibles a petición.

X-Elastic acoustic flooring
Granito, Kayar, Nd Uni, Screed, Grain, Natura, Lava

VISIONS

GRANITO	p 14	KAYAR	p 28	LOOSE LAY	p 42
GRAIN	p 18	BS CLASSIC	p 32	NATURA	p 44
DHARMA	p 22	SCREED	p 34	LAVA	p 46
ND UNI	p 26	ZEUS	p 38		





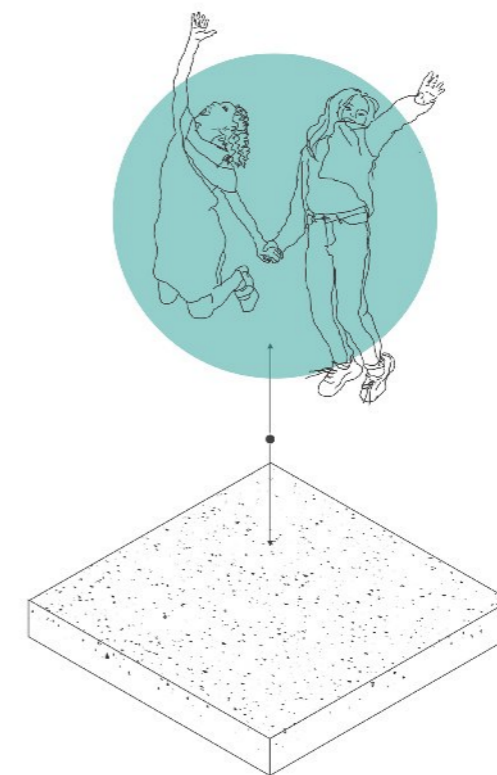

In kindergartens the floor is more than something you just walk on. For the children, it is just another part of the environment to play with. Also, they often go around with naked feet. Artigo floors ensure considerable reduction of treading noise, proving to be the ideal solution for nurseries.

Chiunque li abbia frequentati, sa che negli asili-nido il pavimento è molto di più di qualcosa che si calpesta. Per i bambini è parte integrante del panorama di gioco. Non solo ci camminano a piedi nudi ma si rotolano, si sdraiano. I pavimenti in gomma Artigo garantiscono un'eccezionale riduzione del rumore da calpestio e pertanto rappresentano una soluzione ideale per gli asili.

Quiconque est allé dans une crèche sait que le revêtement de sol est beaucoup plus qu'une surface que l'on piétine. Pour les enfants le sol fait partie intégrale de leur aire de jeu. Non seulement ils y marchent sans chaussures, mais ils s'y roulent par terre ou s'y couchent.

Les revêtements de sol Artigo assurent une réduction considérable du bruit dû au piétinement, s'avérant ainsi la solution idéale pour les crèches.

Wer jemals selbst hingegangen ist, weiß, dass in einem Kindergarten der Fußboden sehr viel mehr ist, als etwas, worauf man geht. Für Kinder gehört der Fußboden zur Szenerie des Spielens. Sie laufen nicht nur mit bloßen Füßen darauf herum, sondern rollen sich und zappeln darauf herum und strecken sich darauf aus.

Artigo-Böden garantieren eine außergewöhnliche Reduzierung des Trittschalls und stellen daher eine ideale Lösung für Kindergärten dar.

Quien haya estado alguna vez, sabe que en las guarderías el suelo es mucho más que algo que se pisa. Para los niños, forma parte de su ambiente de juego. No sólo caminan descalzos, se revuelcan, se tumban.

Los pavimentos Artigo garantizan una reducción considerable del ruido de paso, por lo que son una solución perfecta para las guarderías.



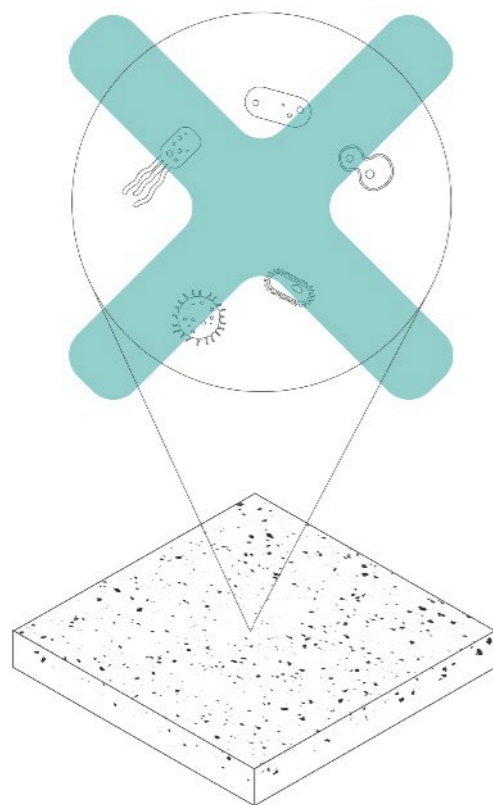

Any open seams in flooring can become hotspots for bacteria: rubber flooring doesn't open at the seams, since no plasticisers are used and the flooring doesn't shrink over time. The surface of rubber flooring is not porous. It can be sealed at the seams and therefore does not offer spaces for bacteria to multiply.

Eventuali giunti aperti possono diventare focolai di batteri: i pavimenti in gomma non si aprono sui giunti, dal momento che non contengono plastificanti e non sono quindi soggetti a ritiro nel tempo. Le superfici dei nostri pavimenti per ambienti ospedalieri non sono porose, sono sigillabili sui giunti e quindi non forniscono ai batteri spazio in cui moltiplicarsi.

Les joints ouverts dans les sols peuvent devenir des nids de bactéries : les revêtements de sol en caoutchouc pour hôpitaux ne s'ouvrent pas au niveau des joints, car ils ne contiennent pas de plastifiants et ne sont donc pas sujets au retrait au fil du temps. Les surfaces des revêtements de sol en caoutchouc pour hôpitaux ne sont pas poreuses, elles peuvent être scellées au niveau des joints et ne fournissent donc pas aux bactéries un foyer dans lequel se multiplier.

Eventuelle offene Fugen in den Böden können zu Bakterienherden führen: Die Gummiböden für Krankenhäuser öffnen sich nicht an den Fugen, da sie keine Weichmacher enthalten und somit keiner Schrumpfung im Laufe der Zeit unterliegen. Die Oberflächen unserer Böden für Krankenhausumgebungen sind nicht porös und an den Fugen versiegelbar. Daher liefern sie Bakterien keinen Raum zur Vervielfältigung.

Las juntas abiertas en los suelos pueden convertirse en focos de bacterias: los suelos de goma para hospitales no se abren en las juntas, ya que no contienen plastificantes y por tanto no sufren contracciones a lo largo del tiempo. Las superficies de nuestros suelos para ambientes hospitalarios no son porosas, pueden sellarse en las juntas y por tanto no dejan espacio para que se multipliquen las bacterias.





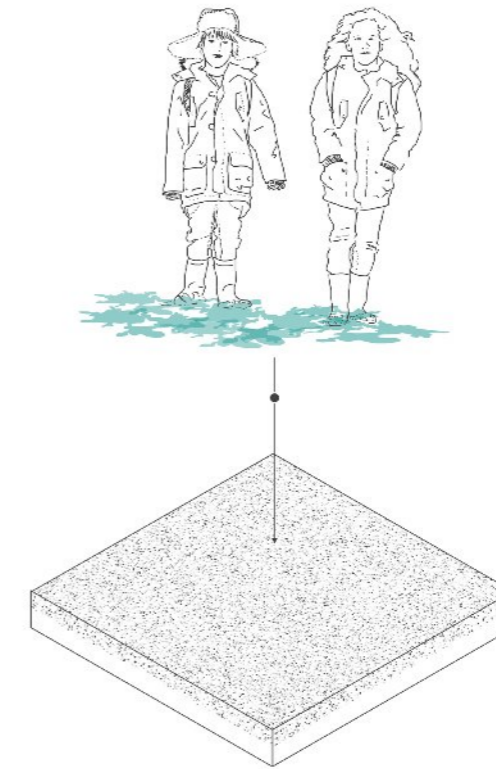

Rubber is the anti-slipping material by definition: Artigo flooring are all classified R9 or R10 according to DIN 51130, determination of anti-slip properties.

La gomma rappresenta il materiale anti-scivolo per definizione: le pavimentazioni Artigo sono classificate R9 o R10 secondo la norma europea DIN 51130 che determina le proprietà antiscivolo dei materiali per pavimenti.

Le caoutchouc est un matériau anti-dérapant par définition : Les revêtements de sol Artigo sont classés R9 ou R10 selon la norme DIN 51130, pour la détermination des propriétés anti-dérapantes.

Kautschuk ist per Definition das rutschhemmende Material: Artigo-Böden sind alle mit R9 oder R10 nach DIN 51130, Bestimmung der Rutschhemmung, klassifiziert.

El caucho es el material antideslizante por excelencia; los pavimentos Artigo tienen una clasificación R9 o R10, según establece la norma DIN 51130 de determinación de las propiedades de resistencia al resbalamiento.





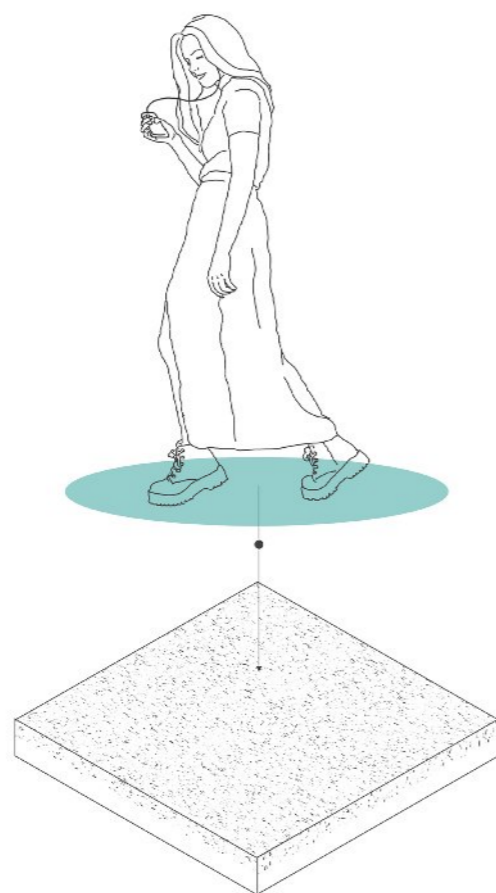

Studies show that people who live and work in environments with good IAQ (Indoor Air Quality) have significantly higher cognitive function scores. Cognitive performance is directly affected by the environment: according to German Blue Angel and US Greenguard certifications, our rubber flooring emit very few pollutants to the indoor air and, thus, do not affect the health of the inhabitants.

Un sempre maggiore numero di studi rivela come chi vive e lavora in ambienti con una buona Qualità dell'Aria Interna può vantare migliori prestazioni cognitive. Questo vale sia per gli alunni che per gli insegnanti. Secondo le più accreditate certificazioni internazionali, fra la quali la tedesca Blue Angel e la US Greenguard, le pavimentazioni in gomma hanno una ridottissima emissione di sostanze nell'aria interna degli ambienti.

Un nombre toujours plus croissant d'études et de tests médicaux démontrent l'importance d'une bonne qualité de l'air intérieur. Les performances cognitives sont directement liées à l'environnement. Selon les certifications internationales les plus accréditées, notamment l'allemande Blue Angel et l'américaine Greenguard, les revêtements de sol en caoutchouc émettent une quantité négligeable de substances dans l'air intérieur et ne nuisent donc pas à la santé de leurs habitants.

Immer mehr Untersuchungen und medizinischen Tests zeigen die Bedeutung einer guten Raumluft. Die kognitiven Leistungen werden von der Umgebung direkt beeinflusst. Laut den glaubwürdigsten internationalen Zertifizierungen wie der deutsche Blaue Engel und die Greenguard aus den USA geben Kautschukbeläge nur eine sehr geringe Menge von Stoffen an die Raumluft ab und haben deshalb auch keine Auswirkungen auf die Gesundheit der Bewohner.

Cada vez son más los estudios y pruebas médicas que demuestran la importancia de una buena calidad del aire interior. El rendimiento cognitivo está directamente influenciado por el ambiente circundante. Según las certificaciones internacionales más prestigiosas, como la alemana Blue Angel y la estadounidense Greenguard, los pavimentos de goma emiten muy pocas sustancias al aire interior de las habitaciones, por lo que no afectan a la salud de sus habitantes.





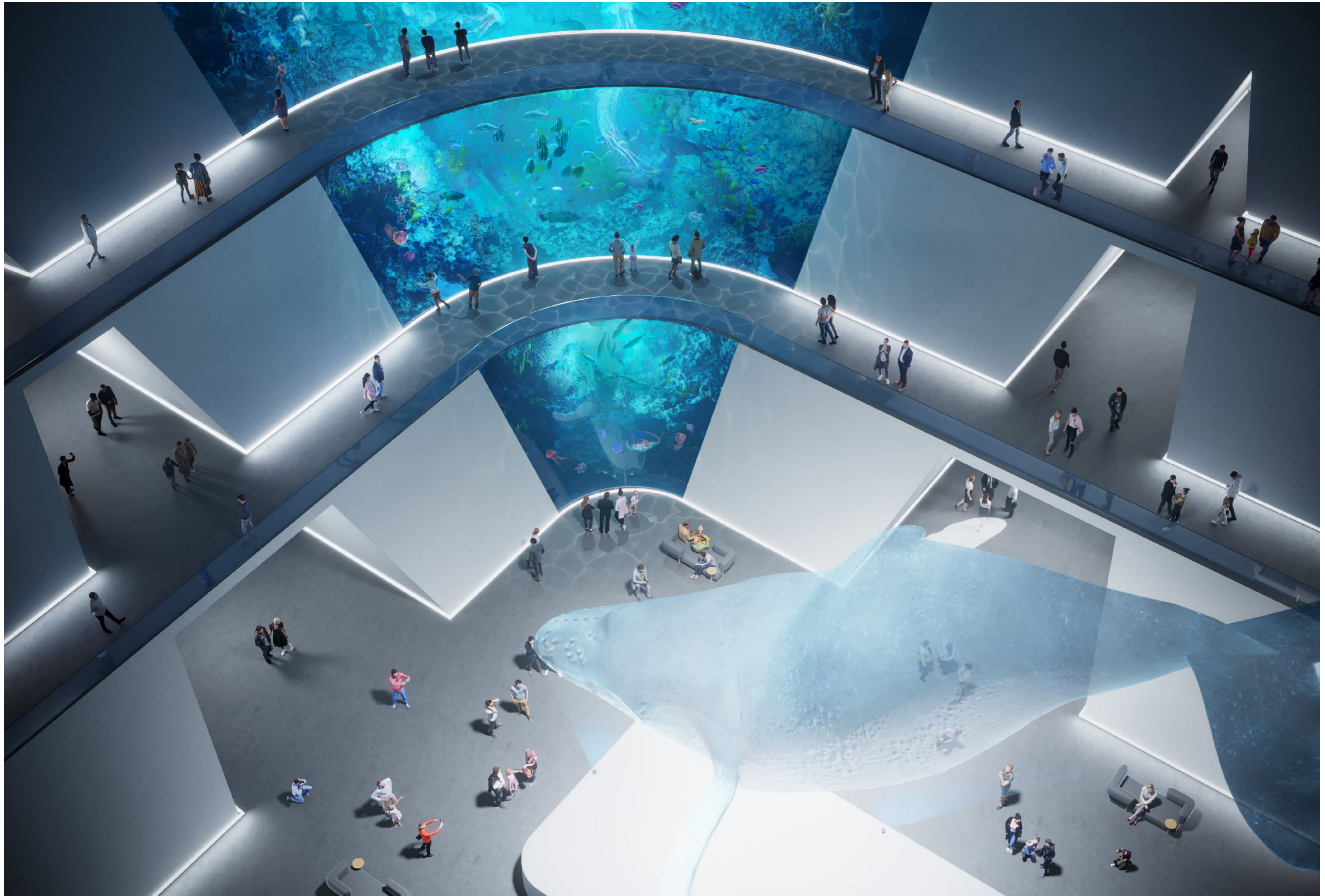

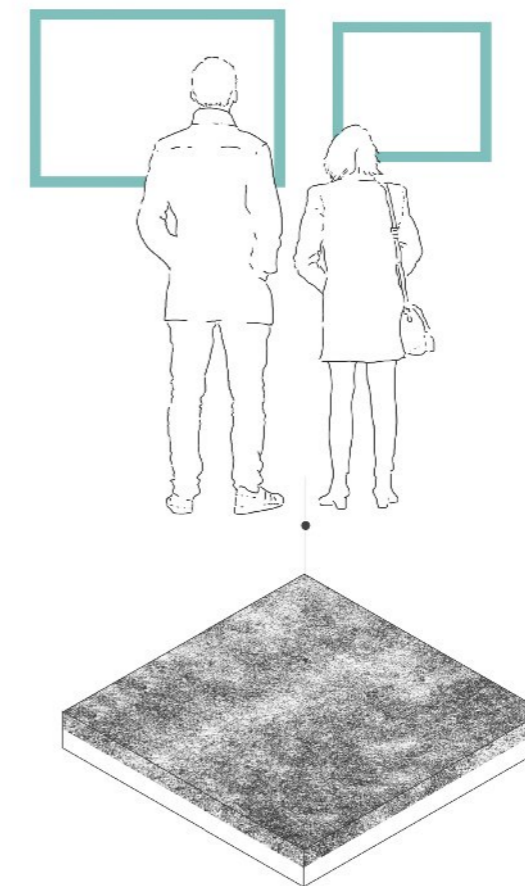

Libraries and museums are increasingly designed to create an experience and an emotional bond with the public. They are changing from mere exhibition spaces to environments that encourage people to return from time to time. Artigo has extensive experience supplying rubber flooring for museums and libraries, having worked with some of the most important architectural firms in the sector.

Pensati sempre di più come luoghi esperienziali, in cui il pubblico possa sviluppare un legame affettivo, biblioteche e musei sono chiamati a trasformarsi da spazi espositivi a luoghi in cui ritornare periodicamente. Artigo possiede una grande esperienza di fornitura di pavimenti in gomma per musei e biblioteche, frutto di collaborazioni con alcuni dei più importanti studi di architettura del settore.

Conçus de plus en plus comme des lieux d'expérience, où le public peut développer un lien affectif, les bibliothèques et les musées sont appelés à se transformer d'espaces d'exposition en lieux de fréquentation régulière. Artigo possède une vaste expérience dans la fourniture de revêtements de sol en caoutchouc pour les musées et les bibliothèques, fruit de collaborations avec certains des plus importants cabinets d'architectes du secteur.

Bibliotheken und Museen werden immer mehr als Erfahrungsräume konzipiert, in denen die Menschen eine sentimentale Beziehung aufbauen können. Daher müssen sie sich von Ausstellungsräumen in Orte verwandeln, an die man regelmäßig zurückkehrt. Artigo verfügt über eine große Erfahrung im Bereich der Gummiböden für Museen und Bibliotheken, die das Ergebnis einer Zusammenarbeit mit den wichtigsten Architekturbüros der Branche ist.

Las bibliotecas y los museos, que se conciben cada vez más como lugares experienciales, en los que el público pueda desarrollar un vínculo afectivo, han de transformarse de espacios expositivos en lugares a los que se vuelve periódicamente. Artigo tiene una gran experiencia en el suministro de suelos de goma para museos y bibliotecas resultante de la colaboración con algunos de los más importantes estudios de arquitectura del sector.



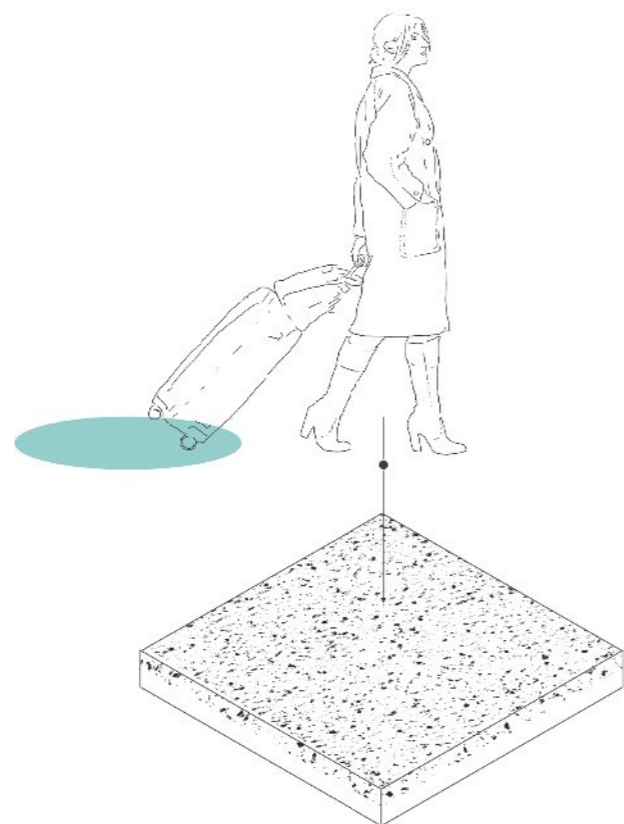

Resilience is a strong feature of Artigo's flooring: durability through time has always been one of our strong points, with examples that go back to Line 1 of Milan Metro Stations, designed in the 60s by Franco Albini.

La resilienza delle pavimentazioni in gomma Artigo - e di conseguenza la loro durata nel tempo - è testimoniata da un'ampia casistica che include casi di eccellenza assoluta, come i pavimenti e le pensiline della linea 1 della Metropolitana Milanese, progettata da Franco Albini all'inizio degli anni sessanta.

La résilience est une caractéristique importante des revêtements de sol Artigo : la durabilité dans le temps a toujours été un de nos points forts, avec des exemples qui remontent à la Ligne 1 des Stations de métro de Milan, conçue dans les années 60 par Franco Albini.

Die Widerstandsfähigkeit von Artigo-kautschukböden - und folglich ihre Langlebigkeit - wird durch eine Vielzahl von Gehäusen bezeugt, darunter Gehäuse von absoluter Exzellenz, wie die Böden und Unterstände der Linie 1 der Mailänder Metro, die Anfang der sechziger Jahre von Franco Albini entworfen wurden.

La resistencia es otra importante ventaja de los pavimentos Artigo. Y es que la durabilidad siempre ha sido uno de nuestros puntos fuertes. Lo hemos demostrado en proyectos como las estaciones de metro de la línea 1 de Milán, diseñadas por Franco Albini en la década de los 60.











TECHNICALS

AT A GLANCE	p 50	GRANITO	p 62	DISSIPATIVE FLOORINGS	p 74
ND UNI	p 52	DHARMA	p 64	SURFACE TREATMENTS	p 76
LAVA	p 54	NATURA	p 66	STAIRSYSTEM	p 78
SCREED	p 56	LOOSE LAY	p 68	CHARACTERISTICS	p 84
KAYAR	p 58	BS CLASSIC	p 70		
GRAIN	p 60	ZEUS	p 72		

AT A GLANCE

SMOOTH SURFACES

2,0 mm

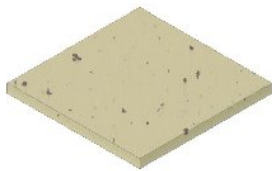

GRANITO p62

3,0 mm

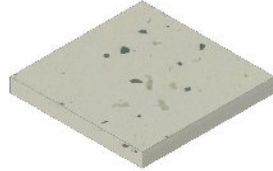

GRAIN p60

4,0 mm X-Elastic

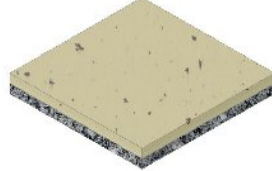

GRANITO p62

5,0 mm X-Elastic



GRAIN p60

5,0 mm Loose Lay



ND UNI p69



GRANITO DISSIPATIVE FLOORING p74



KAYAR p58



DHARMA p64



KAYAR p58



KAYAR p68



DHARMA p64



ND UNI p52



ND UNI p52



SCREED p56

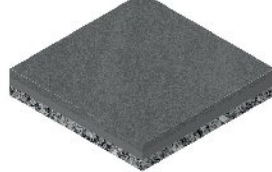

SCREED p56



NATURA p66



NATURA p66

EMBOSSED SURFACES

3,0 mm



LAVA p54

3,5 mm



ZEUS p72

5,0 mm X-Elastic



LAVA p54

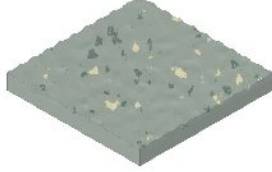

ZEUS DISSIPATIVE FLOORING p74

STUDED SURFACES

2,7 mm

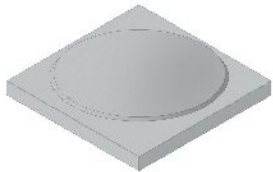

BS CLASSIC p70

4,0 mm

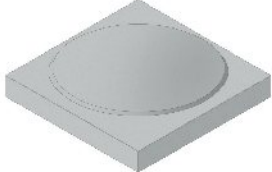

BS STRONG p70

MULTIFLOOR ND UNI

Smooth surface in solid colours
 Superficie liscia in tinta unita
 Surface lisse en teinte unie
 Glatte Oberfläche in einfarbiger Version
 Superficie lisa en color único

standard flooring
 3,0 mm
 5,1 kg/m²



T 610 × 610 mm

R 1,90 × 10 m



Classification UPEC U₁ P₃ E₂ C₂

* Classified C₁ if greasy substances are not used

X-Elastic acoustic flooring
 5,0 mm
 5,7 kg/m²



R 1,90 × 10 m



Classification UPEC U₁ P₃ E₂ C₂

* Classified C₁ if greasy substances are used



U 106 Bamboo



U 107 Lime



U 95 Summer



U 129 Horizon



U 36 Silk



U 54 Greige



U 124 Fossil



U 55 Stone

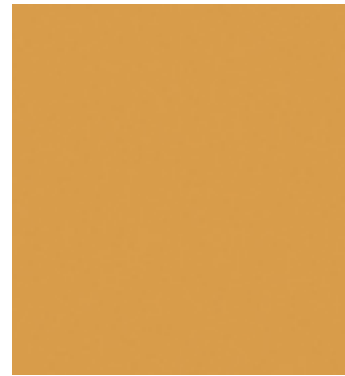

U 11 Gold

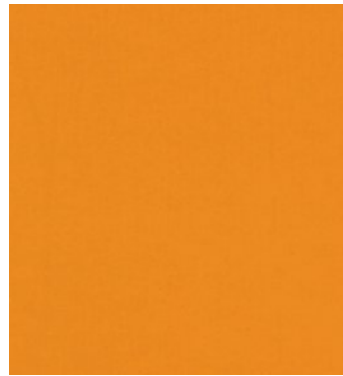

U 105 Tangerine



U 108 Canary



U 87 Cream



U 109 Pearl



U 20 Smoke



U 17 Metal



U 110 Slate

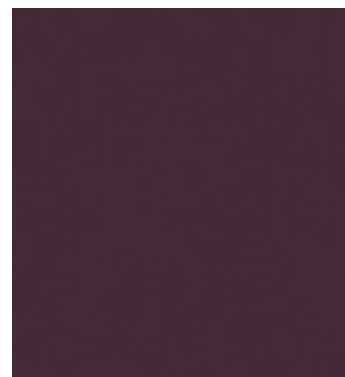

U 14 Mahogany

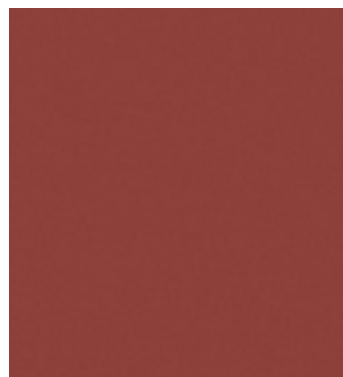

U 13 Firebrik



U 130 Crimson



U 18 Grape



U 26 Steel

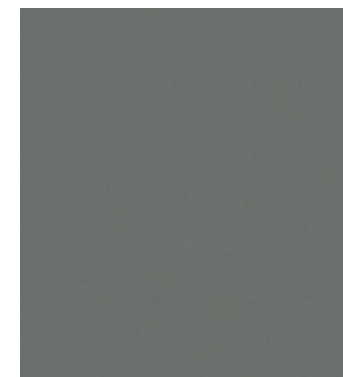

U 16 Avio



U 21 Eiffel



U 00 Carbon



U 99 Ice



U 27 Sand



U 128 Cashmere



U 56 Navajo

LAVA

Stone effect embossed surface
 Superficie gofrata con effetto pietra
 Surface gaufrée aspect pierre
 Geprägte Oberfläche mit Steinoptik
 Superficie gofrada con aspect piedra

standard flooring
 3,0 mm
 4,7 kg/m²



T 610 × 610 mm

R 1,90 × 10 m



Classification UPEC **U₁ P₂ E_{2/3} C₊**
 * Classified C₁ if greasy substances are not used

X-Elastic acoustic flooring
 5,0 mm
 5,3 kg/m²



R 1,90 × 10 m



Classification UPEC **U₁ P₂ E_{2/3} C₊**
 * Classified C₁ if greasy substances are used



L 15 Hekla



L 16 Erebus

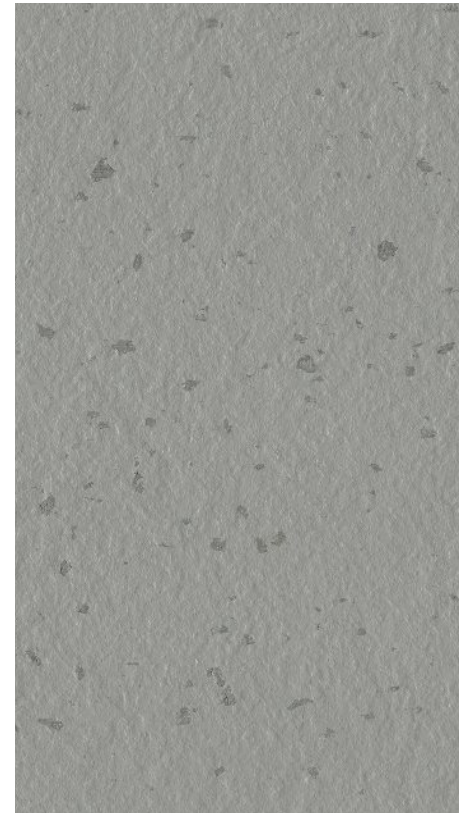

L 17 Sajama

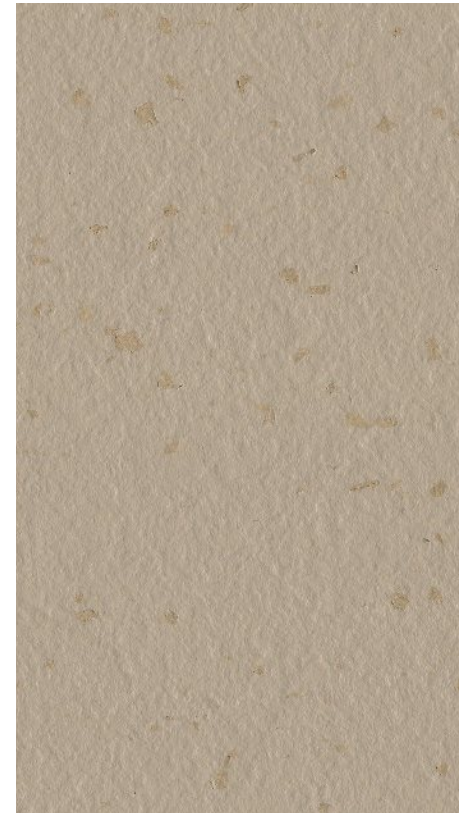

L 19 Kronotsky



L 03 Vesuvio

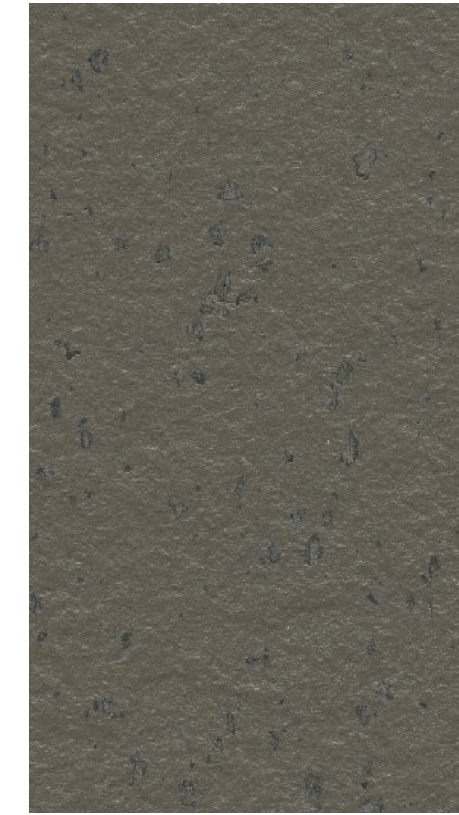

L 02 Teide

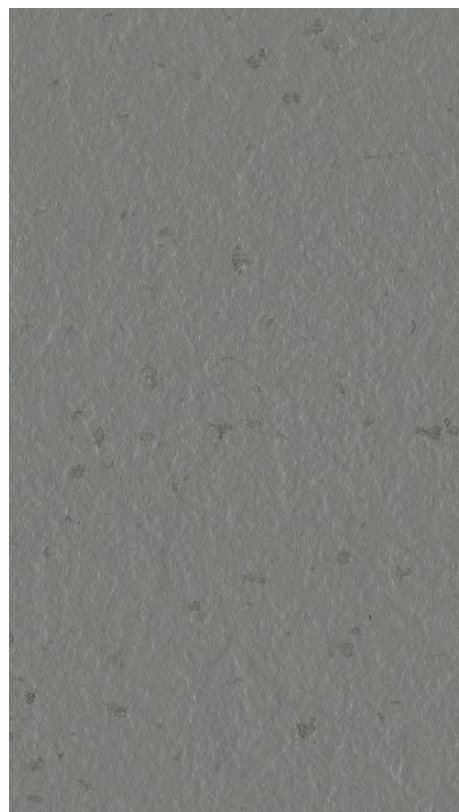

L 18 Meru



L 06 Fuji



L 01 Merapi



L 05 Etna

SCREED

Smooth surface with painted concrete look
 Superficie liscia con aspetto spatolato
 Surface lisse aspect béton taloché
 Glatte Oberfläche mit gestrichener Betonoptik
 Superficie lisa con aspecto fratasado

standard flooring
 3,0 mm
 4,8 kg/m²



T 610 × 610 mm

R 1,90 × 10 m



Classification UPEC **U₁ P₁ E_{1/2} C₁**
 * Classified C₁ if greasy substances are not used

X-Elastic acoustic flooring
 5,0 mm
 5,4 kg/m²



R 1,90 × 10 m



Classification UPEC **U₁ P₁ E_{1/2} C₁**
 * Classified C₁ if greasy substances are used



S 01 Ivory

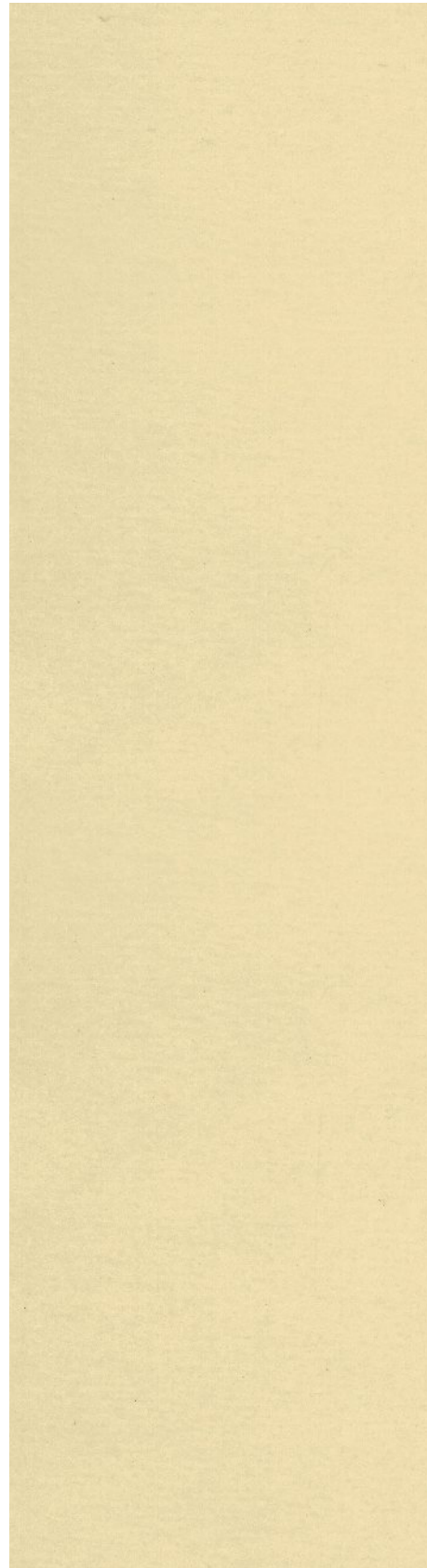

S 02 Antique



S 03 Greige



S 04 Haze



S 05 Cement



S 06 Charcoal

KAYAR

design Sottsass Associati

Smooth surface with natural fibers

Superficie liscia con fibre naturali
Surface lisse avec fibres naturelles
Glatte Oberfläche mit Naturfasern
Superficie lisa con fibras naturales

standard flooring
3,0 mm
4,8 kg/m²



T 610 × 610 mm

R 1,90 × 10 m



Classification UPEC U, P, E, C_s
* Classified C_s if greasy substances are not used

X-Elastic acoustic flooring
5,0 mm
5,4 kg/m²



R 1,90 × 10 m



Classification UPEC U, P, E, C_s
* Classified C_s if greasy substances are used



K 70



K 74



K 71



K 72



K 73



K 27



K 54

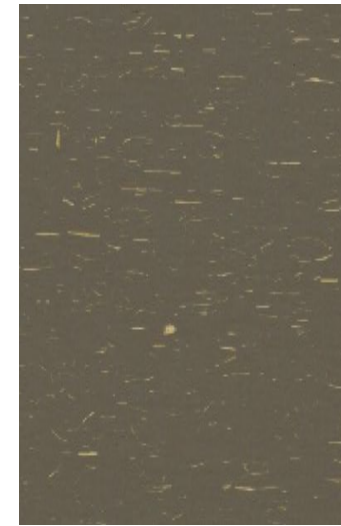

K 103



K 63



K 61



K 39



K 38

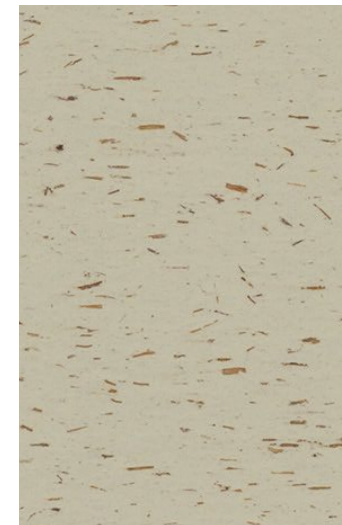

K 104



K 17



K 21



K 01

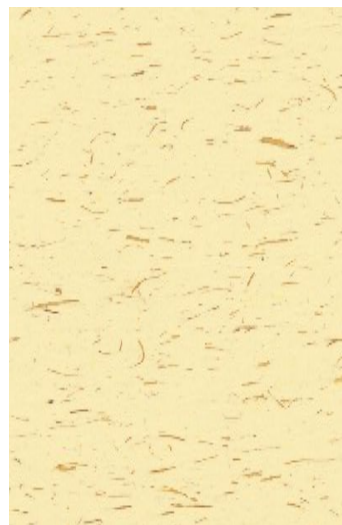

K 52



K 58

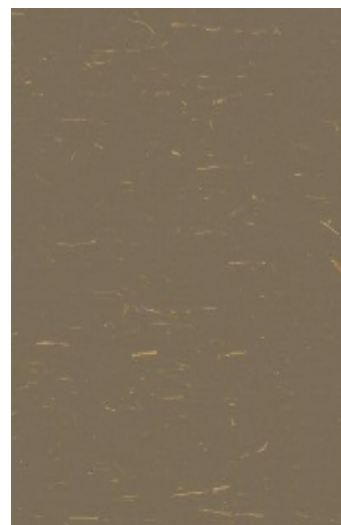

K 48



K 102

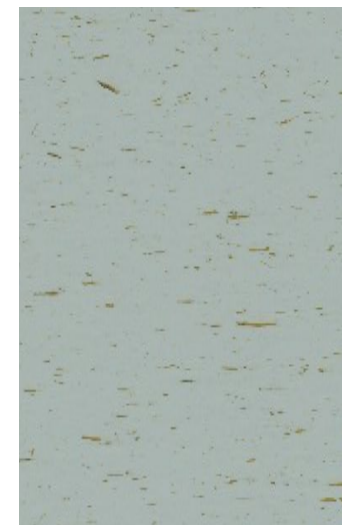

K 49

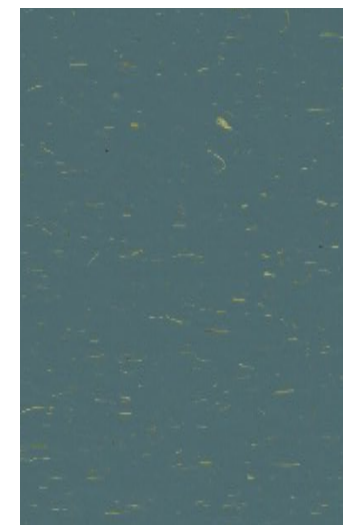

K 64



K 62



K 00

GRAIN

Smooth surface with multicoloured granules
 Superficie liscia con grani multicolori
 Surface lisse avec de granules multicolores incorporés
 Glatte Oberfläche mit verschiedenfarbiger Körnung
 Superficie lisa con partículas multicolores.

standard flooring
 3,0 mm
 4,7 kg/m²



T 610 × 610 mm

R 1,90 × 10 m



Classification UPEC U₁ P₁ E_{1/2} C₁
 * Classified C₁ if greasy substances are not used

X-Elastic acoustic flooring
 5,0 mm
 5,3 kg/m²



R 1,90 × 10 m



Classification UPEC U₁ P₁ E_{1/2} C₁
 * Classified C₁ if greasy substances are used



HG 511



HG 512

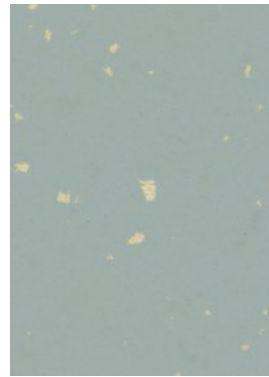

HG 513

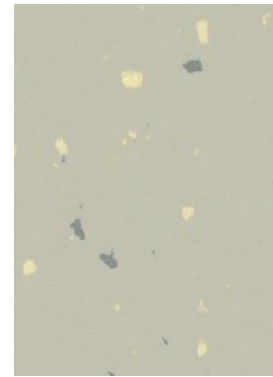

HG 506

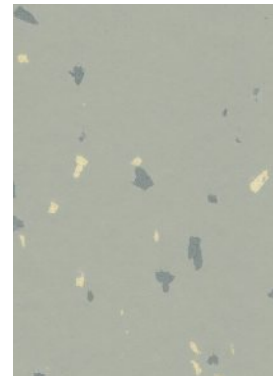

HG 507

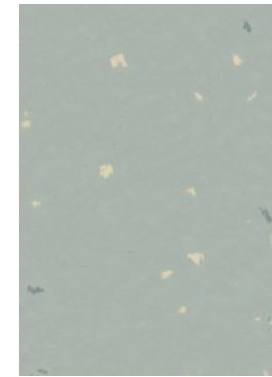

HG 508

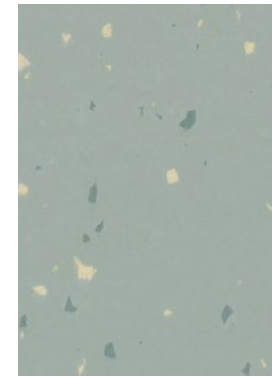

HG 509

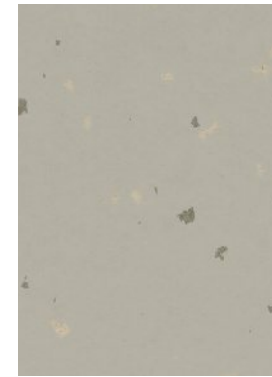

HG 493

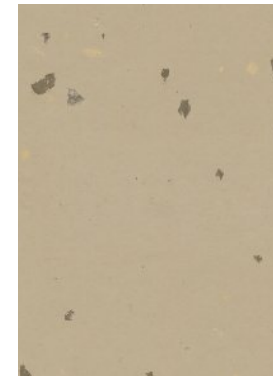

HG 492



HG 526

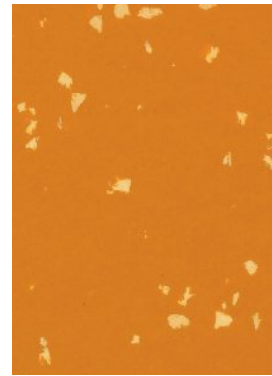

HG 515



HG 516

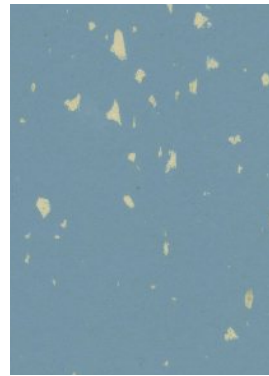

HG 517

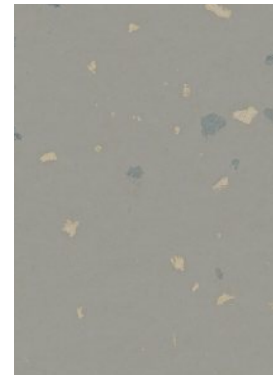

HG 502

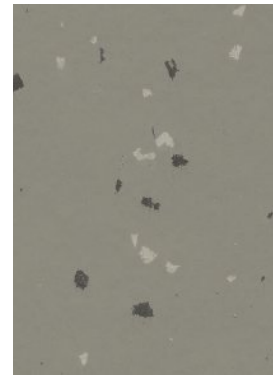

HG 503

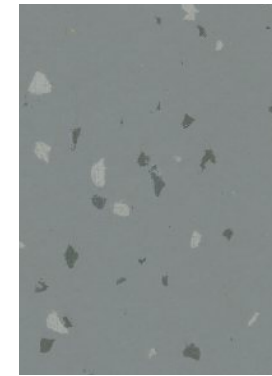

HG 504

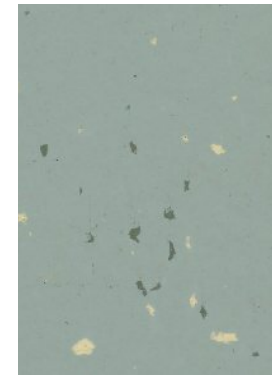

HG 505

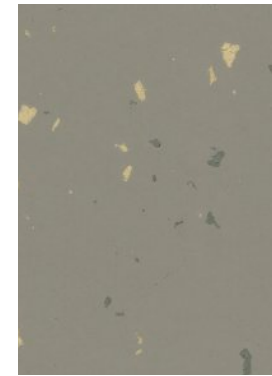

HG 487

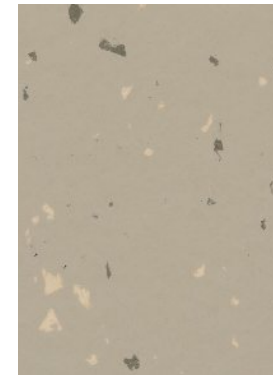

HG 486

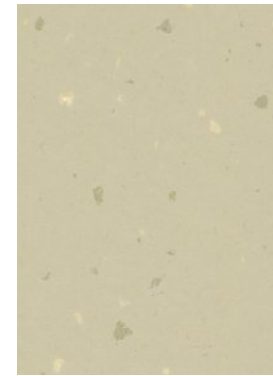

HG 485

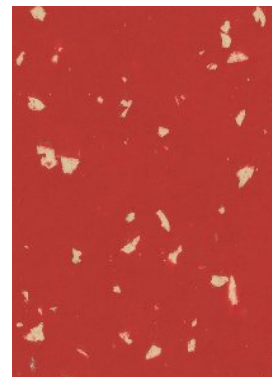

HG 519

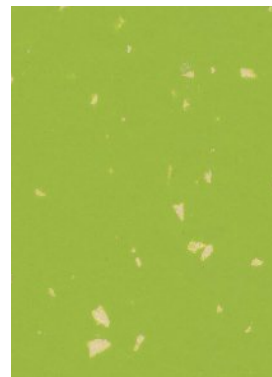

HG 520

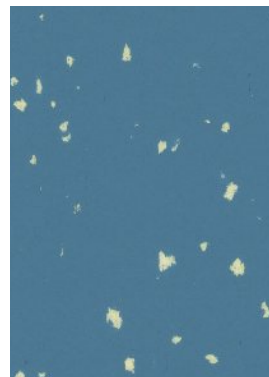

HG 521

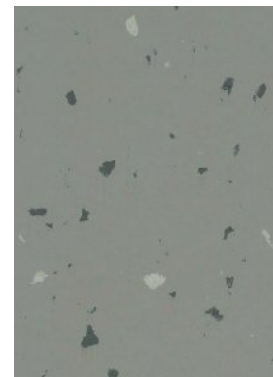

HG 498

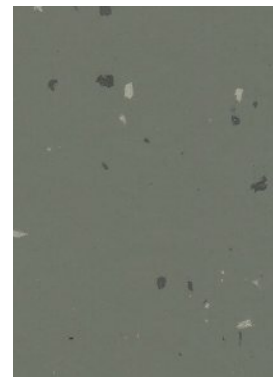

HG 499

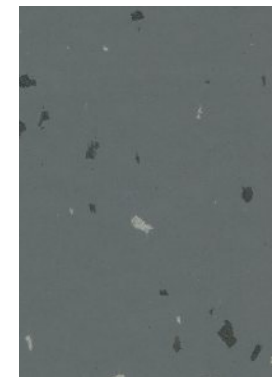

HG 500

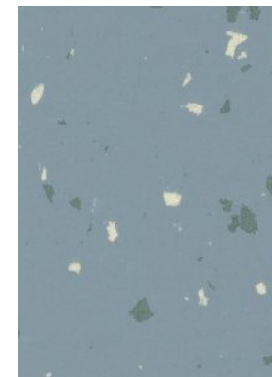

HG 501



HG 484

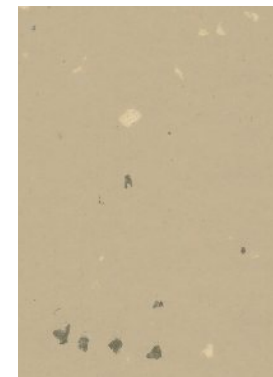

HG 483



HG 481



HG 523

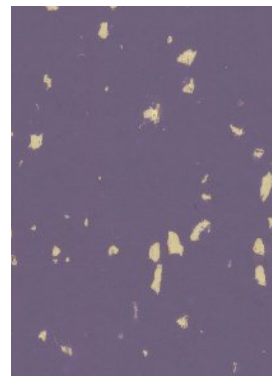

HG 524

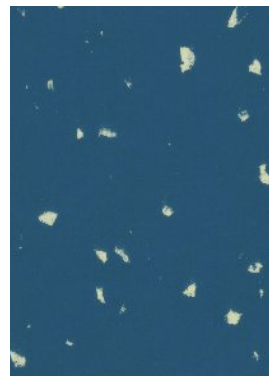

HG 525

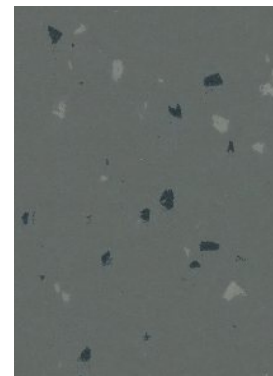

HG 494

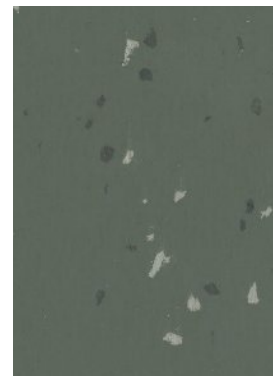

HG 495

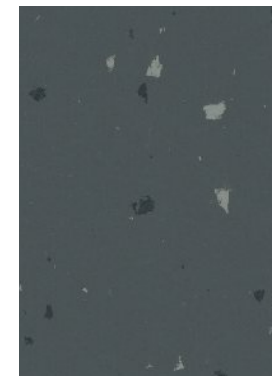

HG 496

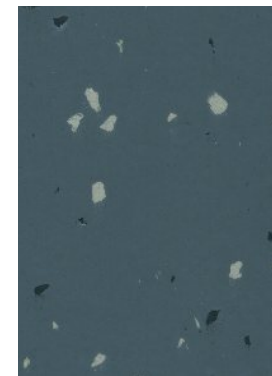

HG 497

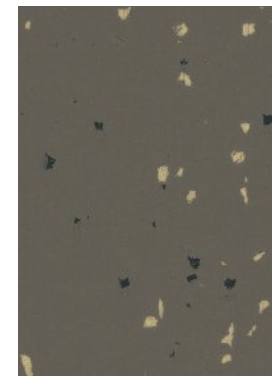

HG 488

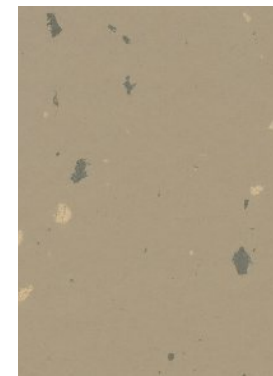

HG 489



HG 490

GRANITO

Smooth surface with multicoloured granules
 Superficie liscia con finissimi grani multicolori
 Surface lisse avec de très fins granules multicolores incorporés
 Glatte Oberfläche mit sehr feiner verschiedenfarbiger Körnung
 Superficie lisa con pequeñas partículas multicolores

standard flooring
 2,0 mm
 3,1 kg/m²



T 610 × 610 mm

R 1,90 × 14 m



Classification UPEC U₁ P₁ E_{2/3} C₊
 * Classified C₁ if greasy substances are not used

X-Elastic acoustic flooring
 4,0 mm
 3,7 kg/m²



R 1,90 × 14 m



Classification UPEC U₁ P₁ E_{2/3} C₊
 * Classified C₁ if greasy substances are used

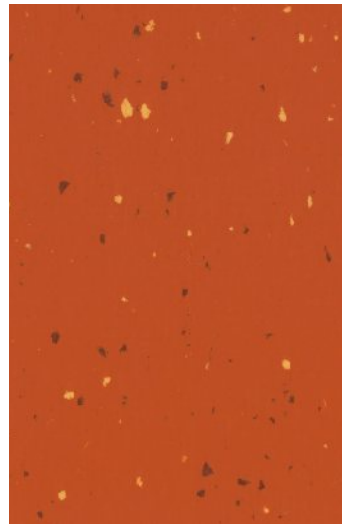

G 367

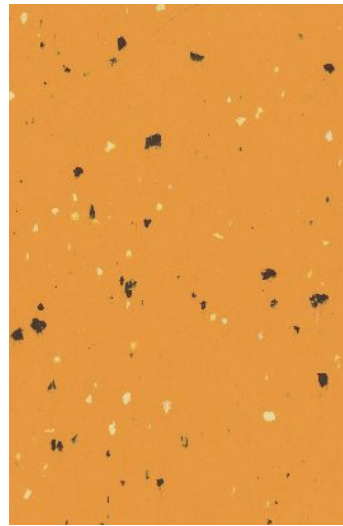

G 472

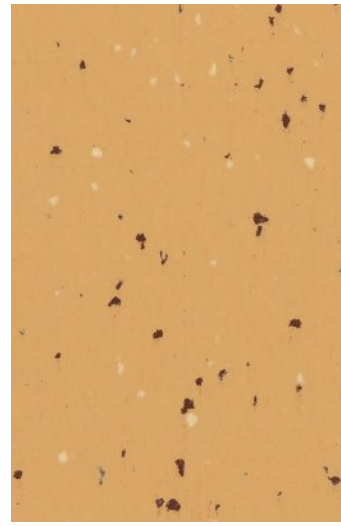

G 365

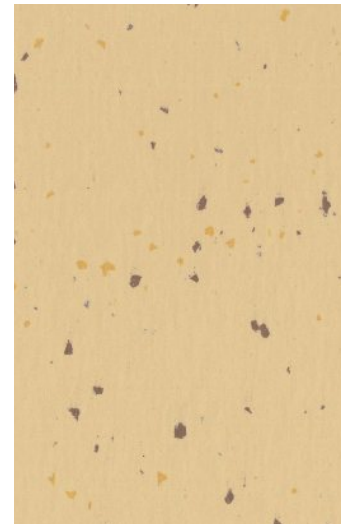

G 363

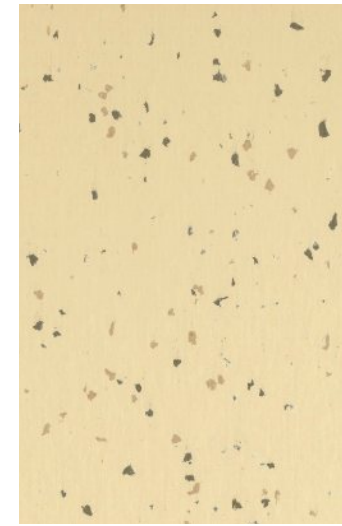

G 479

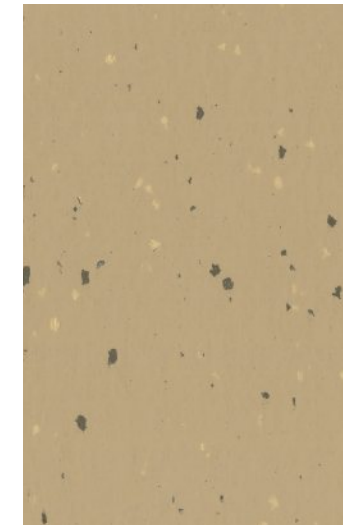

G 475

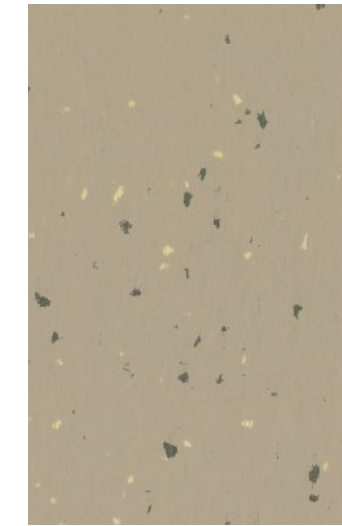

G 368

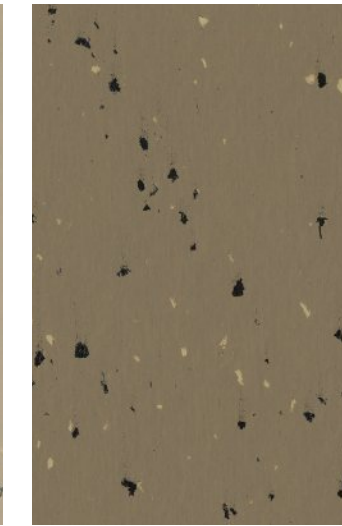

G 474

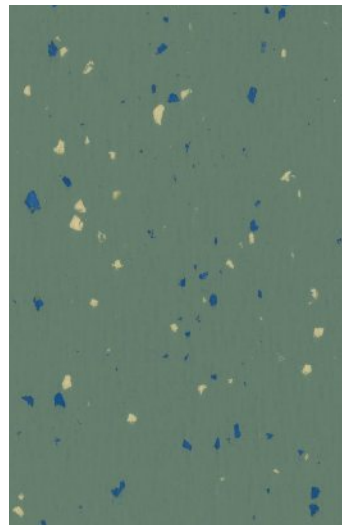

G 336

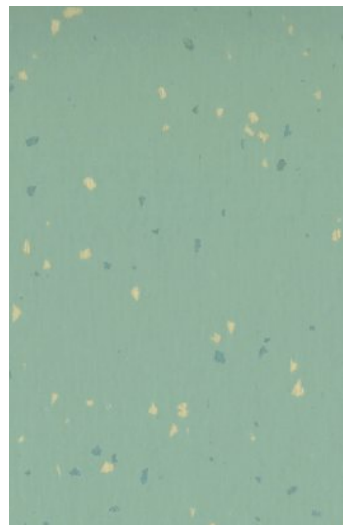

G 378

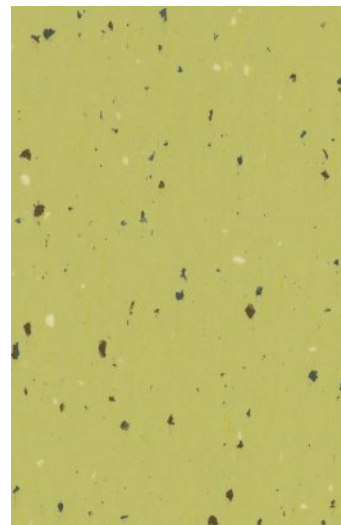

G 473

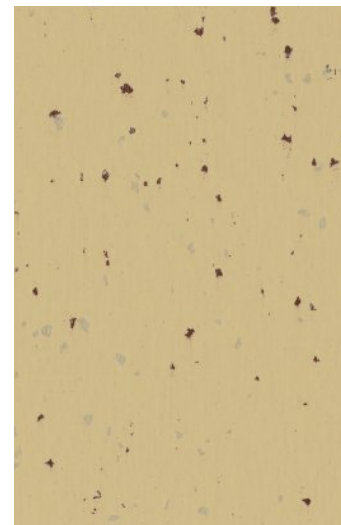

G 315

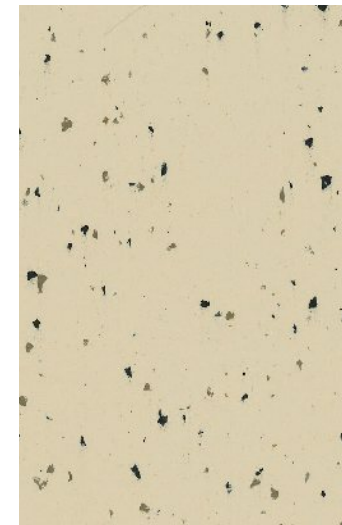

G 431

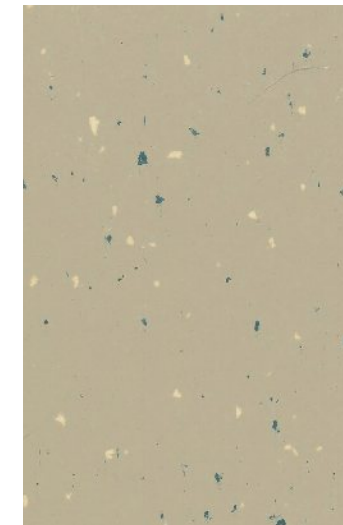

G 480

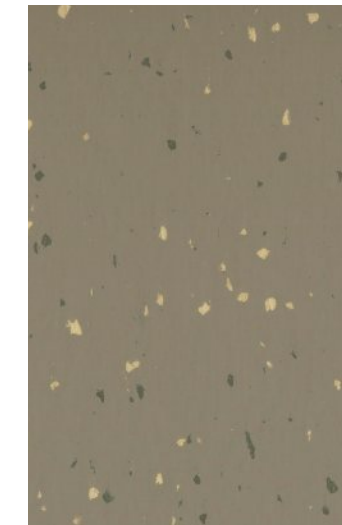

G 478

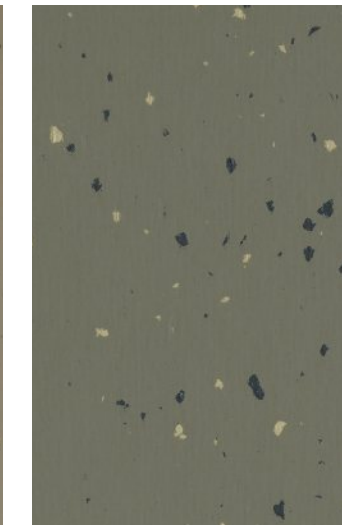

G 477



G 370

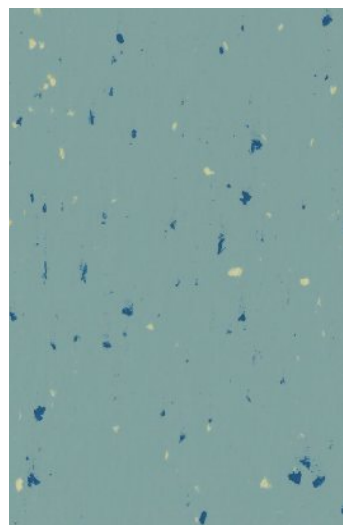

G 371

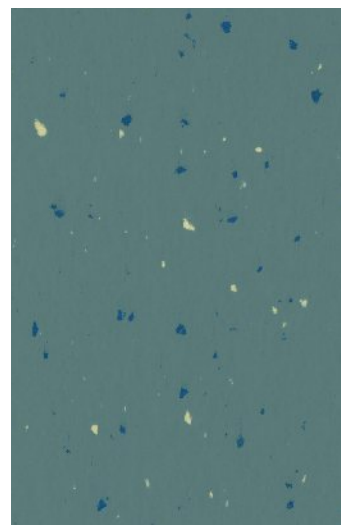

G 372

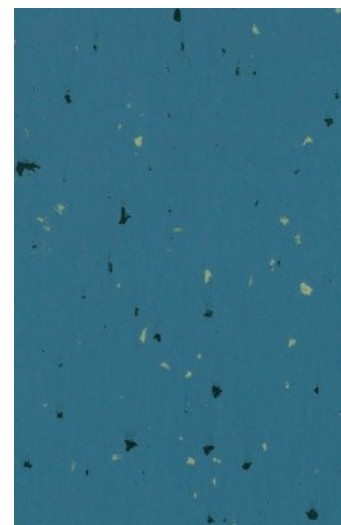

G 342



G 305

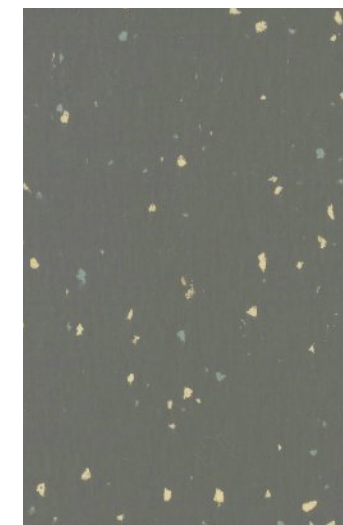

G 306

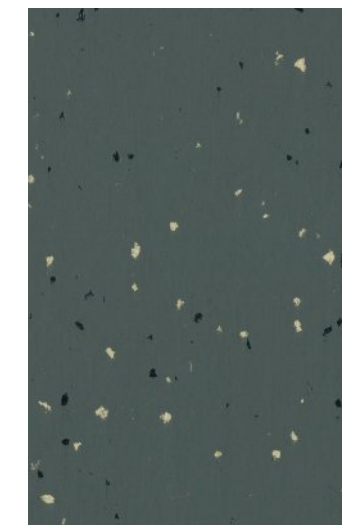

G 308

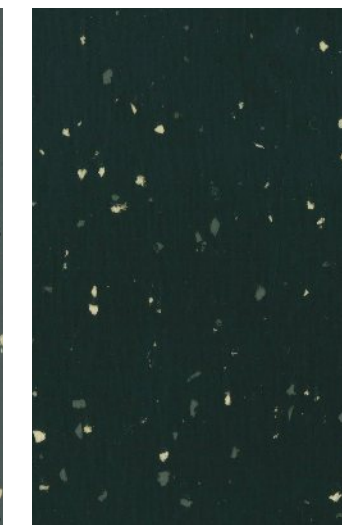

G 476

DHARMA

Smooth surface with micro granules

Superficie liscia con micro granuli
Surface lisse avec micro granules
Glatte Oberfläche mit Mikrokörnung
Superficie lisa con micro gránulos

standard flooring
2,0 mm
3,1 kg/m²



T 610 × 610 mm

R 1,90 × 14 m



X-Elastic acoustic flooring
4,0 mm
3,8 kg/m²



R 1,90 × 14 m



D 19 Pompei



D 20 Papaya



D 18 Saffron



D 17 Cedar

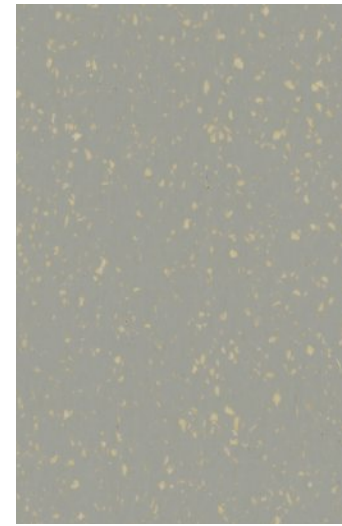

D 07 Palladium

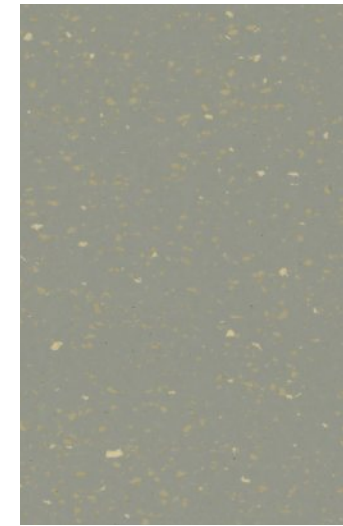

D 11 Musk

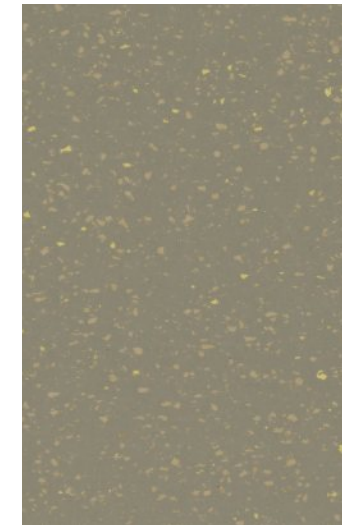

D 15 Almond

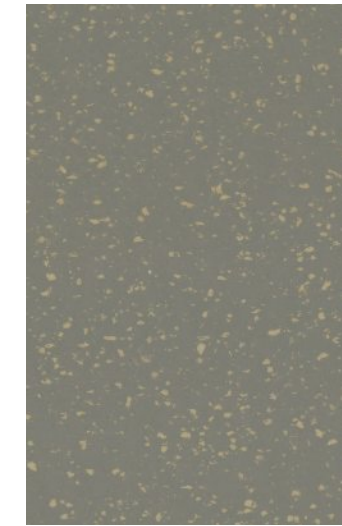

D 13 Oak



D 02 Linen



D 12 Vanilla



D 16 Spice

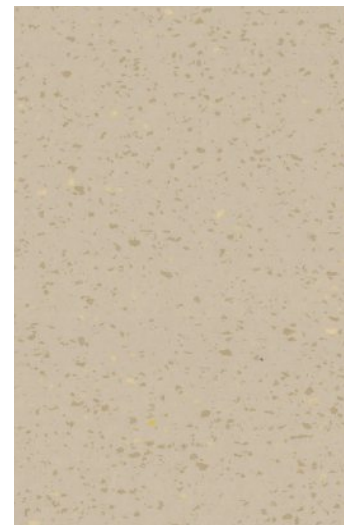

D 14 Juta



D 09 Ash



D 04 Elephant



D 03 Seal



D 01 Onyx

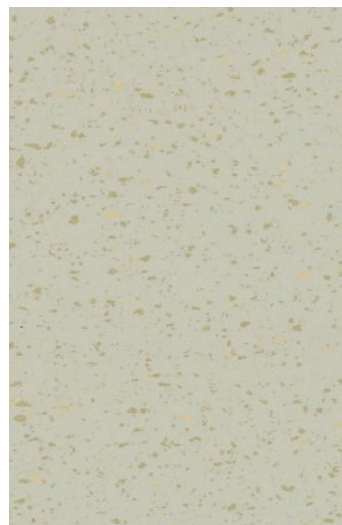

D 10 Moon



D 08 Air



D 06 Island

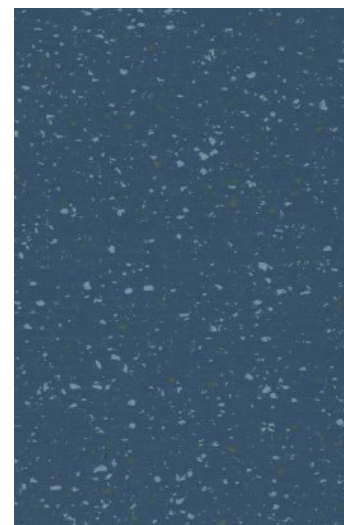

D 05 Midnight

NATURA

Smooth surface with linear marbling
 Superficie liscia con marmorizzazione lineare
 Surface lisse à marbrures linéaires
 Glatte Oberfläche mit linearer Marmorierung
 Superficie lisa con marmoleado lineal

standard flooring
 3,0 mm
 4,9 kg/m²



T 610 × 610 mm

R 1,90 × 10 m



Classification UPEC **U₁ P₂ E₂ C₊**
 * Classified C₊ if greasy substances are not used

X-Elastic acoustic flooring
 5,0 mm
 5,5 kg/m²



R 1,90 × 10 m



Classification UPEC **U₁ P₂ E₂ C₊**
 * Classified C₊ if greasy substances are used



NA 01 Cream



NA 02 Hay

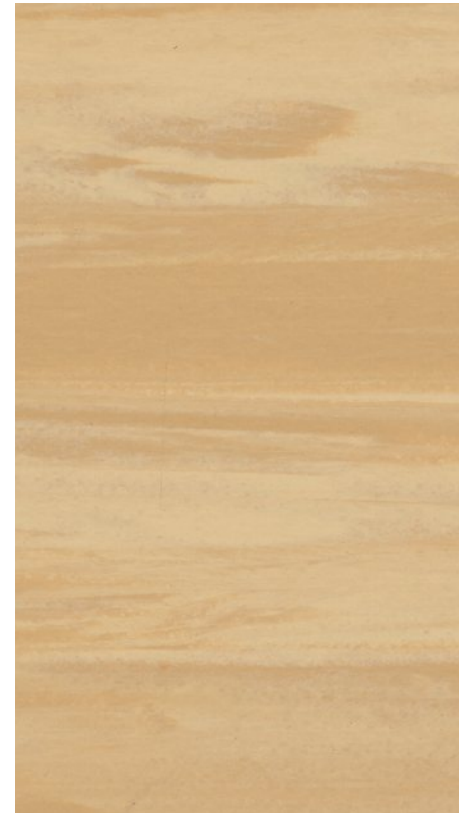

NA 03 Summer



NA 04 Sand



NA 08 Desert



NA 06 Walnut



NA 07 Ecreu



NA 05 Greige

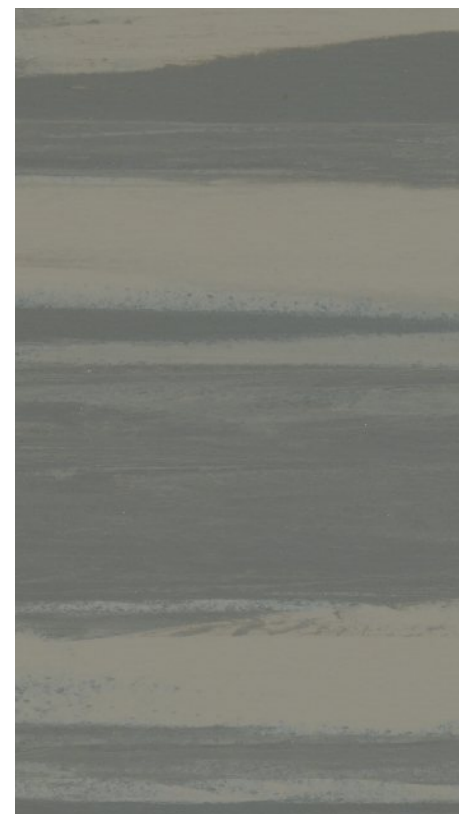

NA 09 Cliff



NA 10 Nimbus



NA 11 Metal



NA 12 Charcoal

KAYAR / LL

design Sottsass Associati

Loose lay
Autoposante
Autoportant
Zur losen Verlegung
Autoposante

Smooth surface with natural fibers

Superficie liscia con fibre naturali
Surface lisse avec fibres naturelles
Glatte Oberfläche mit Naturfasern
Superficie lisa con fibras naturales

5,0 mm
7,9 kg/m²



T 610 × 610 mm



UNI / LL

Loose lay
Autoposante
Autoportant
Zur losen Verlegung
Autoposante

Smooth surface in solid colour

Superficie liscia in tinta unita
Surface lisse en teinte unie
Glatte Oberfläche in einfarbiger Version
Superficie lisa en color único

5,0 mm
8,3 kg/m²



T 610 × 610 mm

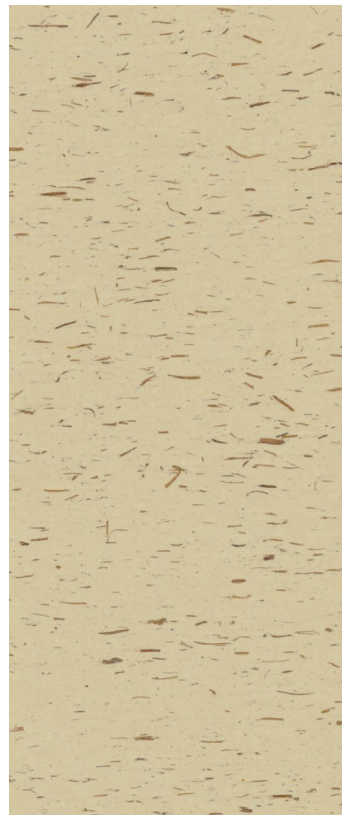

K 73



K 54

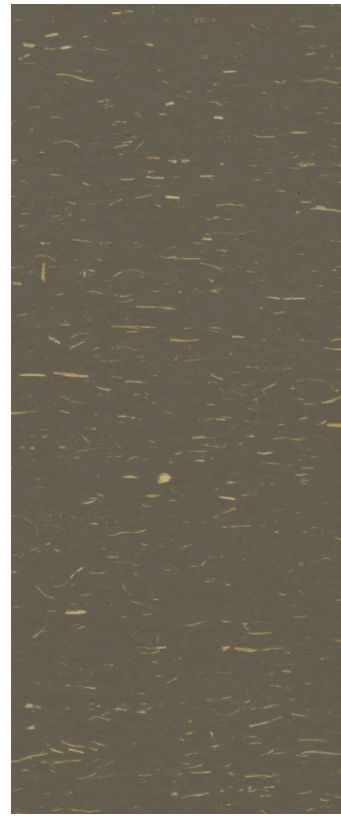

K 103



K 72



U 99



U 27



U 55

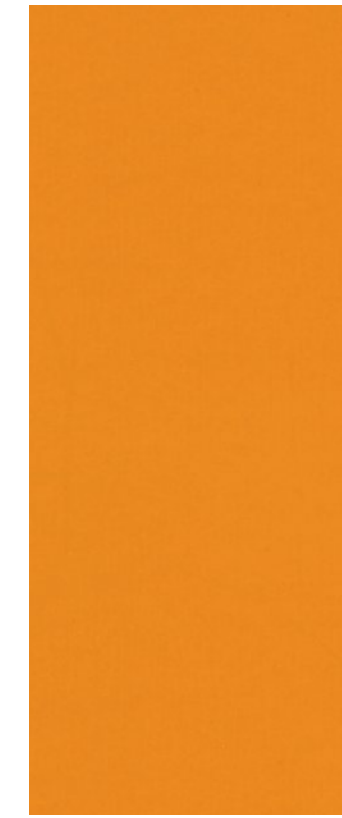

U 105



K 104



K 17

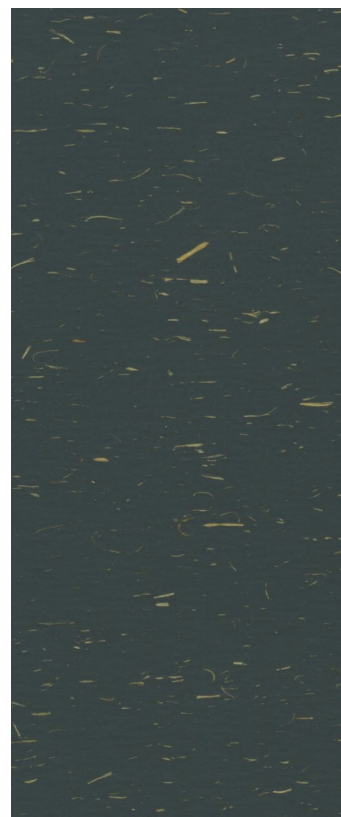

K 21

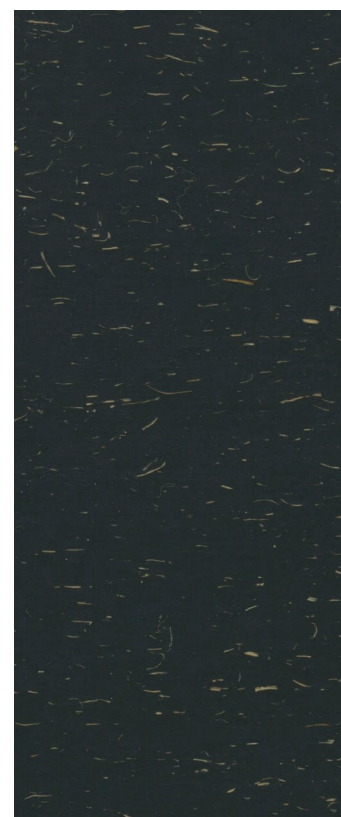

K 01



U 54

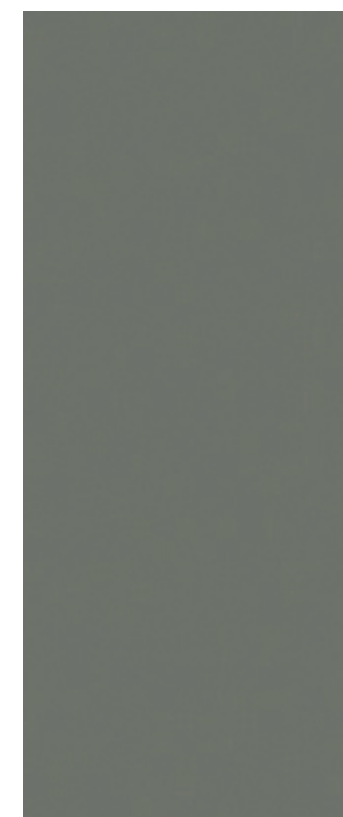

U 17



U 21

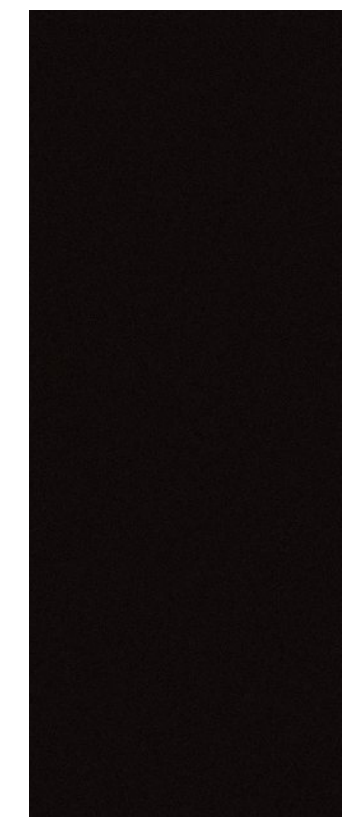

U 00

BS CLASSIC

BS STRONG

Solid colour round studded tiles

Piastrelle monocolor con rilievi a bolli
 Dalles en teinte unie avec relief à pastille ronde
 Einfarbige Fliesen mit Hohlkehl-Rundnoppen
 Baldosas monocolor con relieve de circulos con perfil redondeado

The numbers in bold type indicate the price category.

I numeri in grassetto indicano la categoria di prezzo.
Les numéros en gras indiquent la catégorie de prix.
Die fett gedruckten Zahlen geben die Preiskategorien an.
Los números en negrita indican la categoría de precio.

BS classic

2,7 mm
 3,7 kg/m²



T 500 × 500 mm



Classification UPEC U₄ P₃ E_{2/3} C₊
 * Classified C₊ if greasy substances are not used

BS strong • Standard: N004, G847, G805, G804, G820, B207, R922

4,0 mm
 5,4 kg/m²



T 1000 × 1000 mm



Classification UPEC U₄ P₃ E_{2/3} C₊
 * Classified C₊ if greasy substances are not used

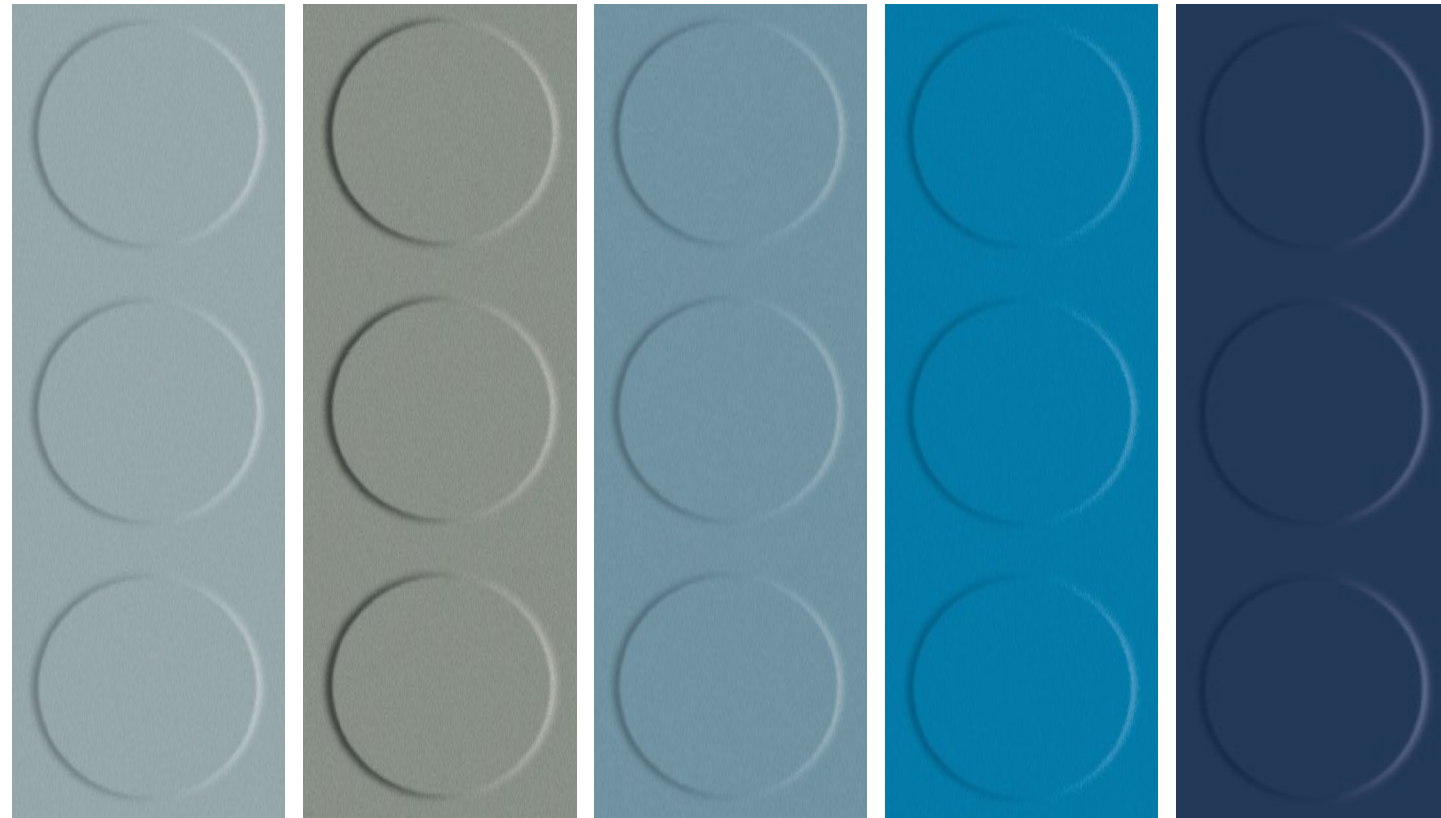

G 814 Titanium **2** G 815 Stone **2** B 212 Sky **3** B 218 Lagoon **3** B 207 Jeans • **2**

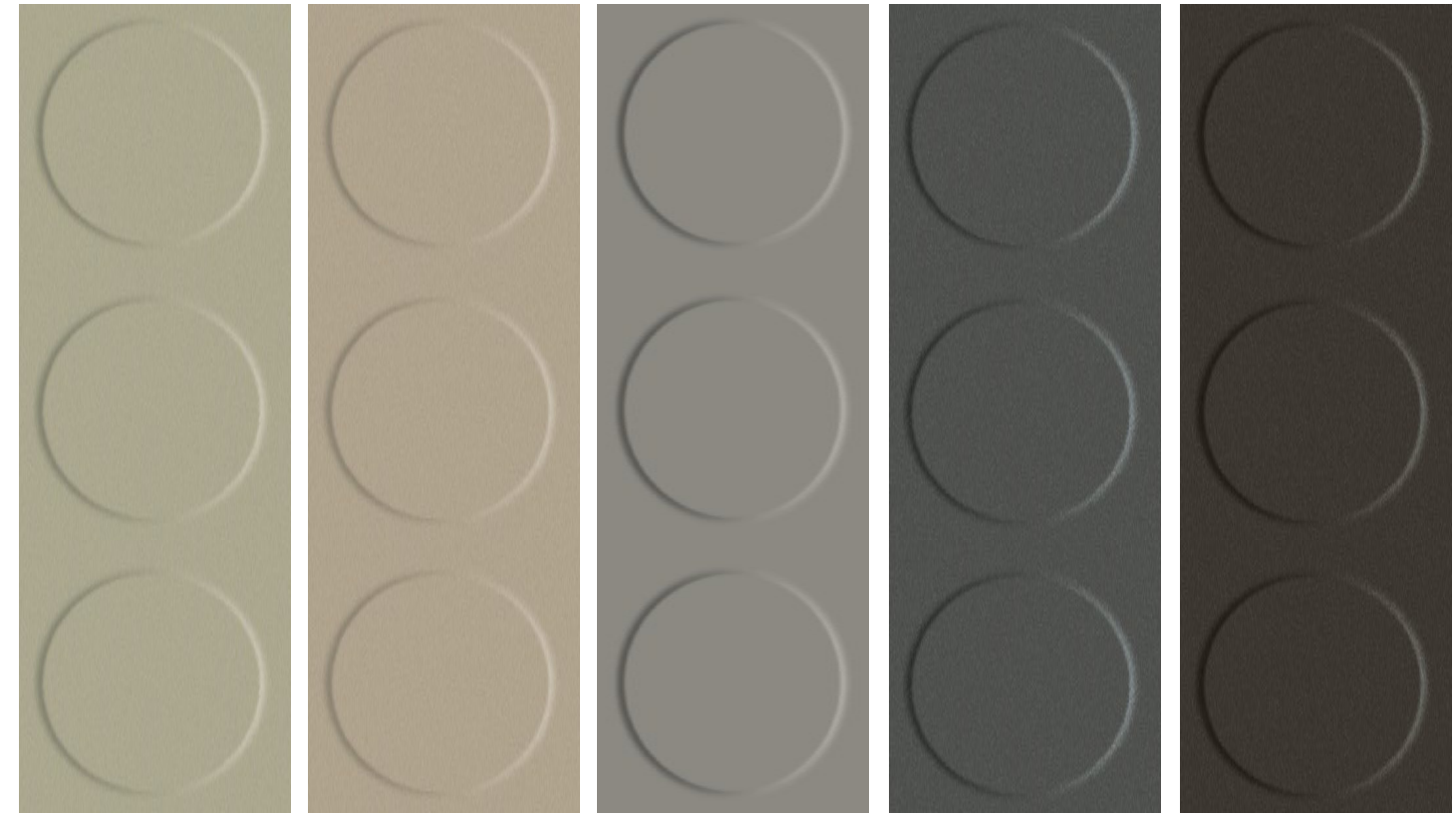

G 816 Glacier **2** G 810 Canvas **2** G 811 Silver **2** G 813 Falcon **2** M 123 Brown **2**



R 922 Love • **3** Y 510 Orange **3** Y 507 Helios **3** V 755 Lime **3** V 713 Meadow **3**

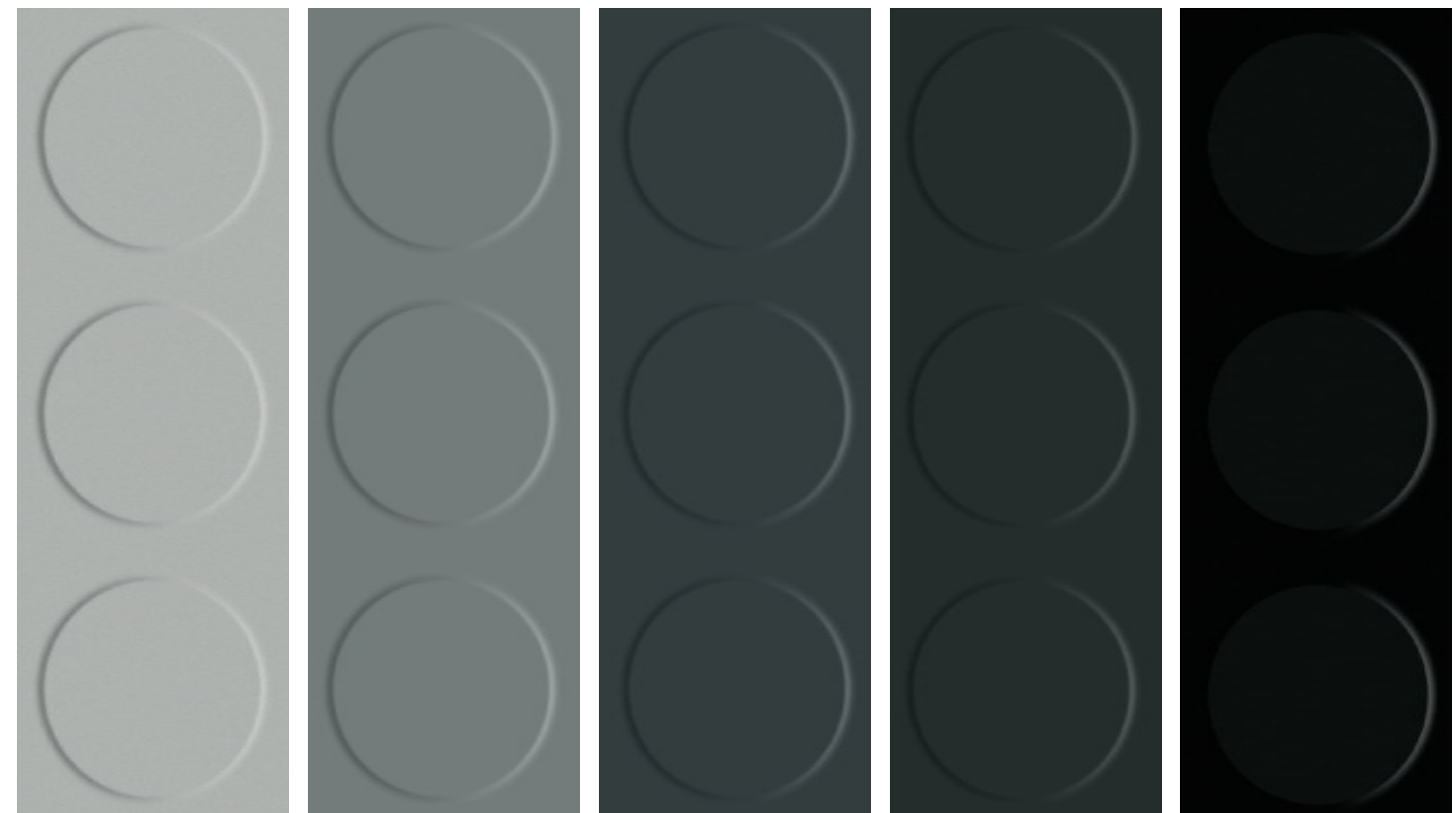

G 820 Pearl • **2** G 804 Metal • **2** G 805 Eiffel • **2** G 847 Slate • **2** N 004 Carbon • **1**

ZEUS

Multicoloured tiles with a hammered surface
Piastrelle multicolori con superficie martellata
Dalles multicolores avec surface martelée
Mehrfarbige Fliesen mit Hammerschlagoberfläche
Baldosas multicolores con superficie martilleada

standard flooring
3,5 mm
5,5 kg/m²



T 1000 x 1000 mm



Classification UPEC U, P, E₂, C₊

* Classified C₊ if greasy substances are not used

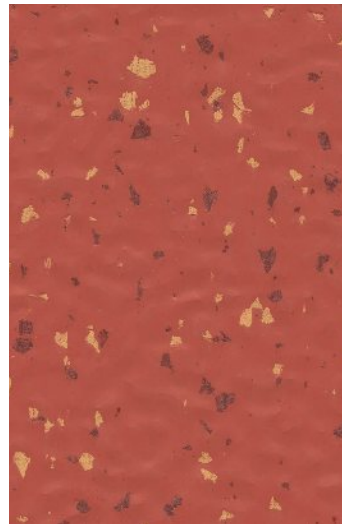

Z 677

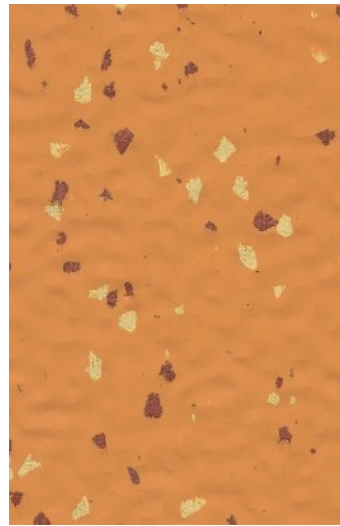

Z 678

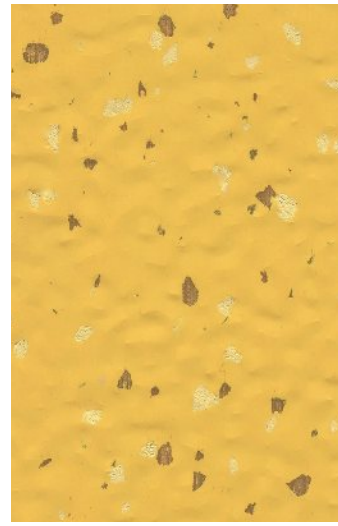

Z 679

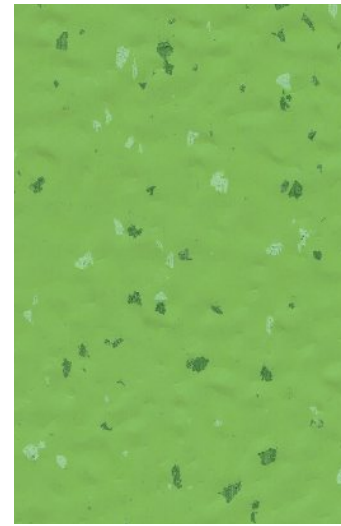

Z 680

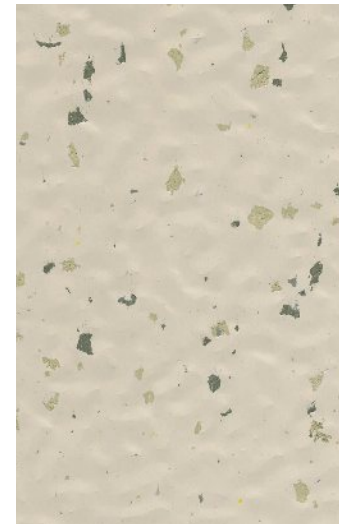

Z 676

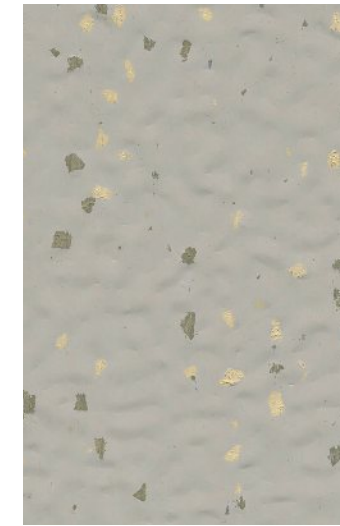

Z 675

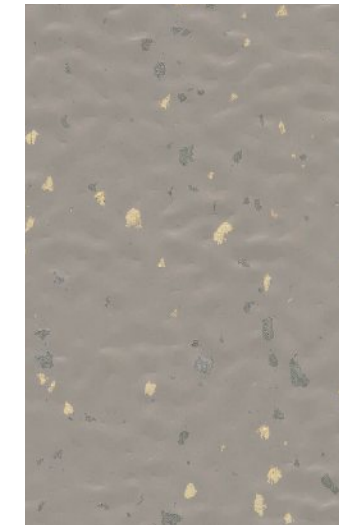

Z 674



Z 673

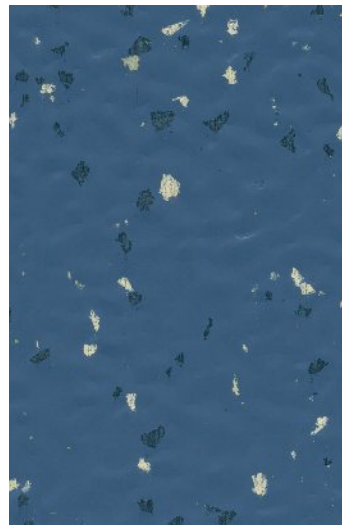

Z 682

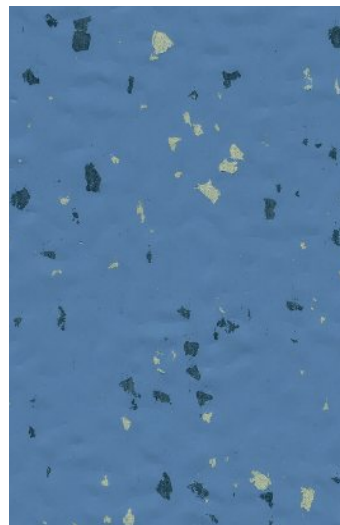

Z 683

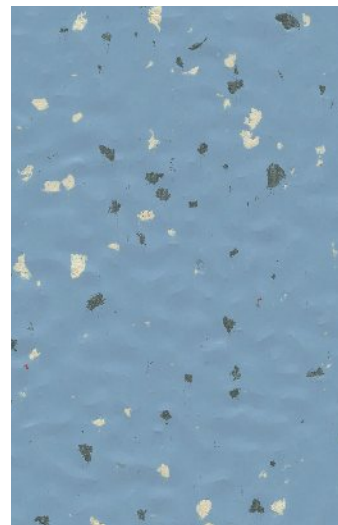

Z 684

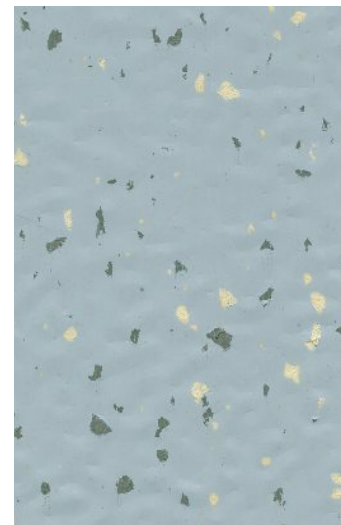

Z 685

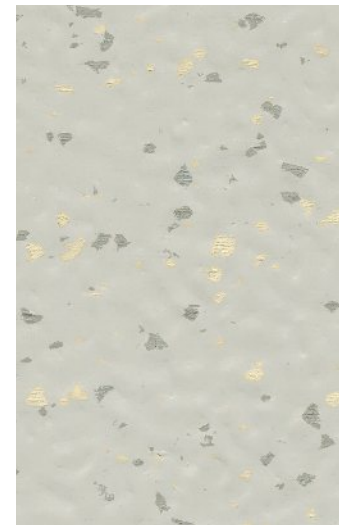

Z 669

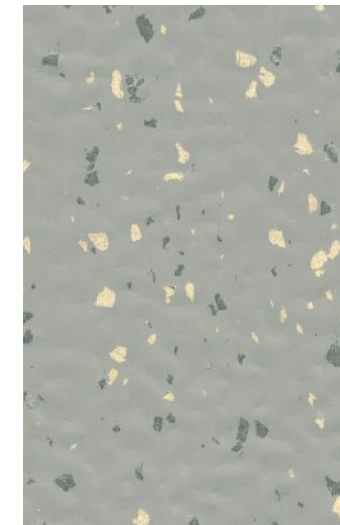

Z 626

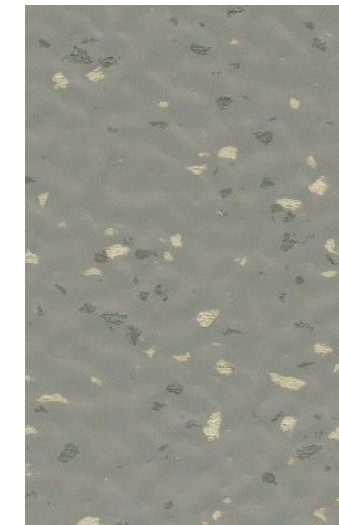

Z 639

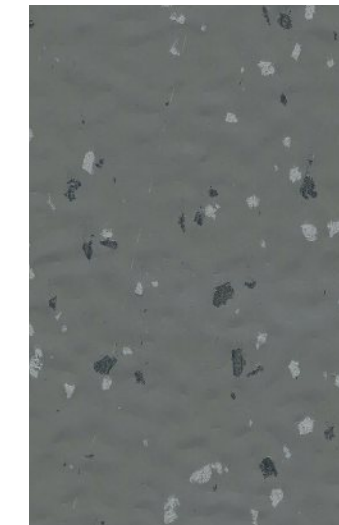

Z 681

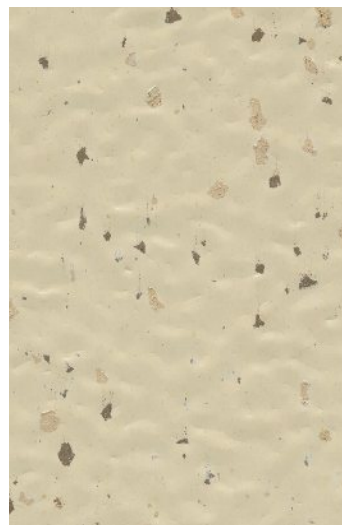

Z 670

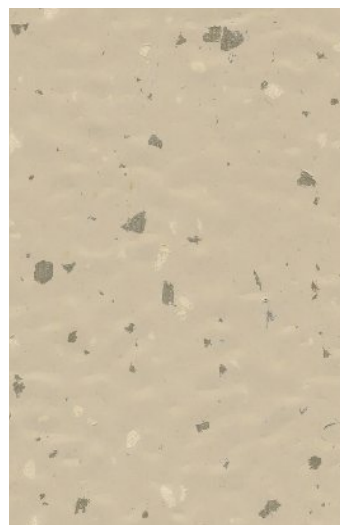

Z 671

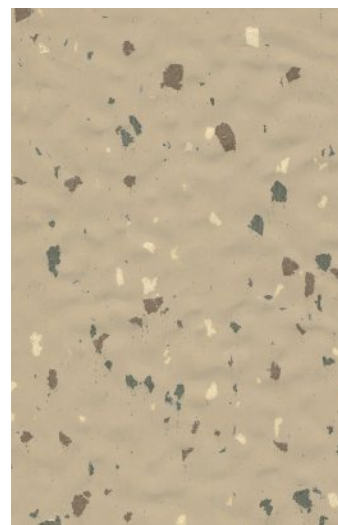

Z 628

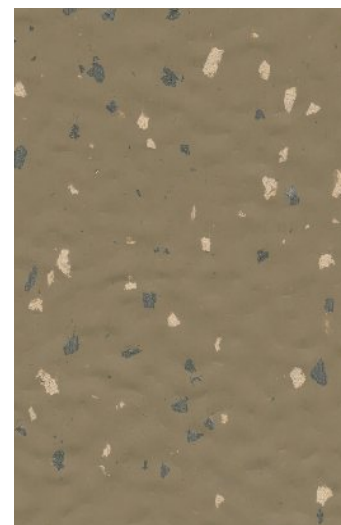

Z 672

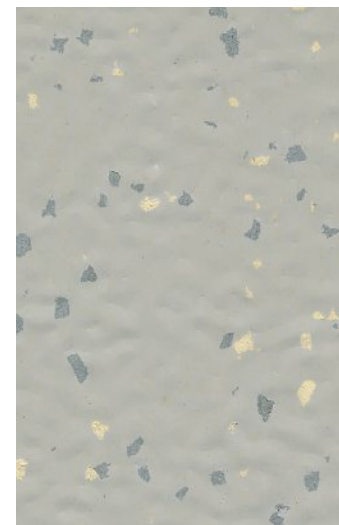

Z 686

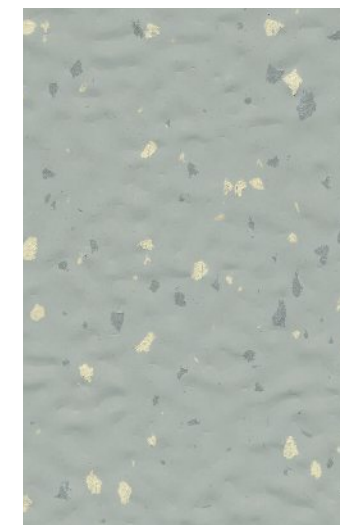

Z 687

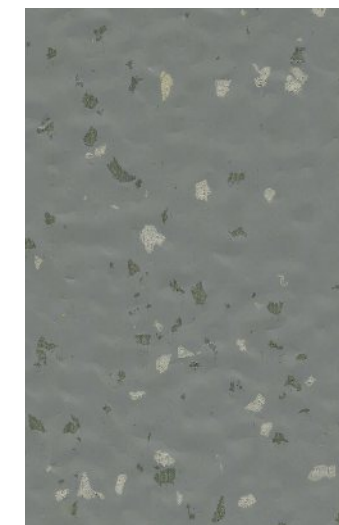

Z 688

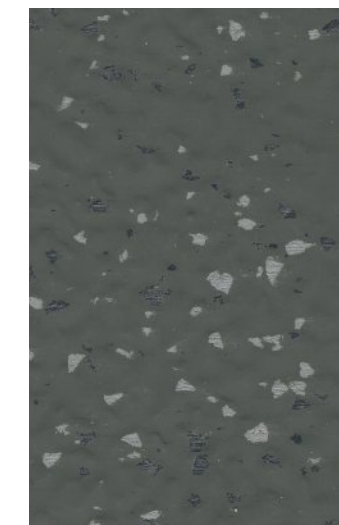

Z 689

DISSIPATIVE FLOORINGS

All Artigo rubber floors are antistatic. In areas where static electricity is potentially harmful to electronic equipment and components, it is necessary to create additional protection from discharges even of small intensity and not noticeable by the human being.

This protection is obtained with adequate systems and earthing aimed at limiting and dissipating in a controlled way all the electrostatic charges generated in the environment.

The flooring must also be designed for this purpose, being an integral part of the system; Artigo proposes ANT48 dissipative floors (according to EN 14041) which, installed with conductive adhesives and adequate earthing systems (copper strips), allow precisely electrostatic dissipation in a controlled way in order to avoid harmful effects on ESD (Electrostatic Sensitive) equipment Device). The areas sensitive to this problem are typically related to companies that produce electronic components, data centers, pharmaceutical companies, and all cases in which equipment sensitive to electrostatic charges exists.

Tutti i pavimenti in gomma Artigo sono antistatici. Nei settori in cui l'elettricità statica è potenzialmente dannosa per le apparecchiature ed i componenti elettronici, è necessario creare una ulteriore protezione da scariche anche di piccola intensità e non avvertibili dall'essere umano. Questa protezione si ottiene con adeguati sistemi e di messa a terra volti a limitare e dissipare in modo controllato tutte le cariche elettrostatiche generate nell'ambiente. Anche la pavimentazione deve essere progettata a questo fine essendo parte integrante del sistema; Artigo propone i pavimenti ANT48 dissipativi (secondo EN 14041) che, installati mediante adesivi conduttivi e adeguati sistemi di messa a terra (bandelle in rame), permettono appunto la dissipazione elettrostatica in modo controllato al fine di evitare effetti dannosi alle apparecchiature ESD (Electrostatic Sensitive Device). Le aree sensibili a questa problematica sono tipicamente riferibili alle aziende che producono componenti elettronici, i centri dati, le aziende farmaceutiche, e tutti i casi nei quali esistano apparecchiature sensibili alle cariche elettrostatiche.

Tous les sols caoutchouc ARTIGO sont antistatiques. Dans les espaces où l'électricité statique est potentiellement nocive pour les équipements et composants électroniques, il est nécessaire de créer une protection complémentaire des décharges même de faible intensité et non perceptible par l'être humain. Cette protection est obtenue avec des systèmes adéquats de mise à la terre qui vise à limiter en dissipant de manière contrôlée toutes les charges électrostatiques générées dans l'environnement. Le revêtement de sol doit aussi être conçu à cet effet en faisant partie intégrante du système. ARTIGO propose les revêtements dissipatifs ANT 48 (selon la norme EN 14041) qui mis en oeuvre avec un adhésif conducteur avec des systèmes de mise à la terre adéquats (bande de cuivre) permet une dissipation électrostatique précise et contrôlée afin d'éviter les effets néfastes d'ESD (sensibilité à l'électricité statique). Les domaines sensibles à ce problème sont généralement liés aux entreprises qui produisent des composants électroniques, les Data Center, les Entreprises pharmaceutiques et dans tous les cas là où les équipements sont sensibles aux charges électrostatiques présentes.

Alle Artigo Kautschukbeläge sind antistatisch. In Bereichen, in denen statische Elektrizität für elektronische Geräte und Komponenten potenziell schädlich sein kann, ist ein zusätzlicher Schutz vor Entladungen auch geringer Intensität notwendig und zugleich von Menschen nicht wahrnehmbar sein. Dieser Schutz wird durch geeignete Systeme und Erdung erreicht, die darauf ausgelegt sind, alle in der Umgebung erzeugten elektrostatischen Ladungen zu begrenzen und kontrolliert abzuleiten. Der Bodenbelag muss ebenfalls für diesen Zweck geeignet sein, da er ein integraler Bestandteil des Systems ist; Artigo bietet mit "ANT48" ableitende Böden (gemäß EN 14041) an, die, mit leitfähigen Klebstoffen und geeigneten Erdungssystemen (Kupferbänder) verlegt, eine präzise und kontrollierte elektrostatische Ableitung ermöglichen, um schädliche Auswirkungen auf ESD-Geräte (Electrostatic Sensitive Devices) zu vermeiden. Die für dieses Problem sensiblen Bereiche betreffen typischerweise Unternehmen, die elektronische Komponenten herstellen, Rechenzentren, pharmazeutische Unternehmen und alle Fälle, in denen Geräte eingesetzt werden, die empfindlich auf elektrostatische Ladungen reagieren.

Todos los pavimentos de caucho Artigo son antiestáticos. En áreas donde la electricidad estática es potencialmente dañina para los equipos y componentes electrónicos, es necesario crear protección adicional contra descargas incluso de pequeña intensidad y que el ser humano no perciba. Esta protección se obtiene con sistemas de toma de tierra adecuados para limitar y disipar de forma controlada todas las cargas electrostáticas generadas en el medio ambiente. El piso también debe estar diseñado para este propósito, siendo una parte integral del sistema; Artigo propone pisos disipativos ANT48 (según EN 14041) que, instalados con adhesivos conductores y sistemas toma de tierra adecuados (tiras de cobre), permiten una disipación electrostática precisa de forma controlada para evitar efectos nocivos en el dispositivo del equipo ESD (Sensible electrostático). Las áreas sensibles a este problema generalmente están relacionadas con compañías que producen componentes electrónicos, centros de datos, compañías farmacéuticas y todos los casos en los que existen equipos sensibles a las cargas electrostáticas.

GRANITO /ANT48

Embossed surface
Superficie gofrata
Surface gaufrée
Reflexbrechende Oberfläche
Superficie gofrada

2,0 mm
3,1 kg/m²

T 610 × 610 mm

R 1,90 × 10 m

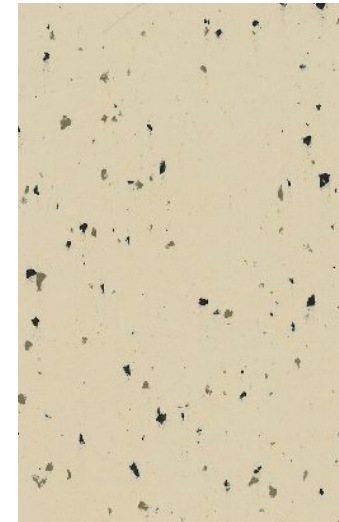

G 479

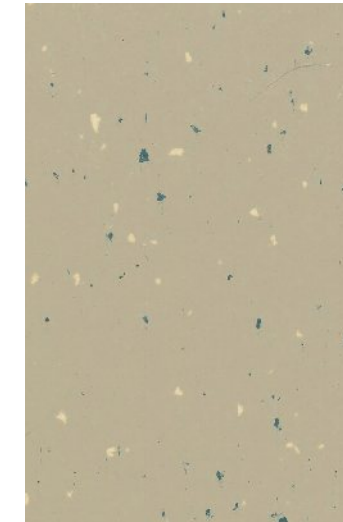

G 480

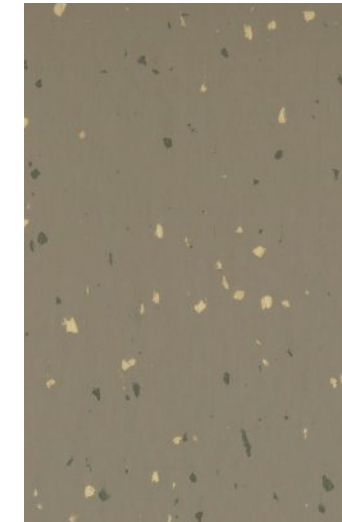

G 305

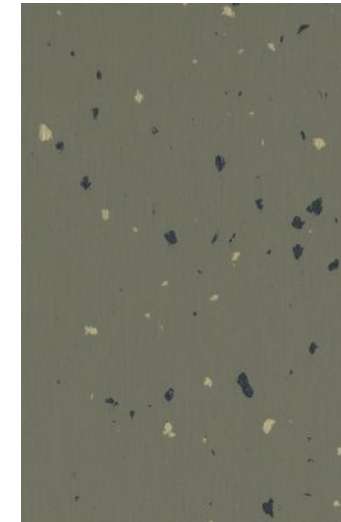

G 308

ZEUS /ANT48

Multicoloured tiles with a hammered surface
Superficie martellata multicolore
Dalles multicolores avec surface martelée
Mehrfarbige Fliesen mit Hammerschlagoberfläche
Baldosas multicolores con superficie martilleada

3,5 mm
5,5 kg/m²



T 1000 x 1000 mm

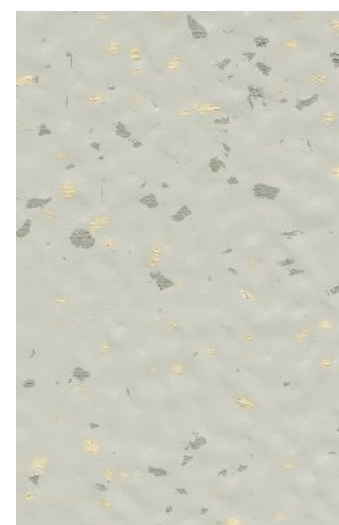

Z 669

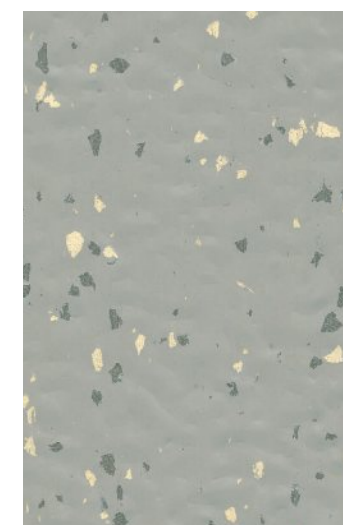

Z 626

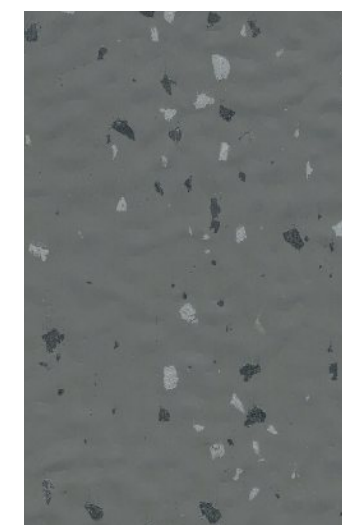

Z 681

SURFACE TREATMENTS

PRO

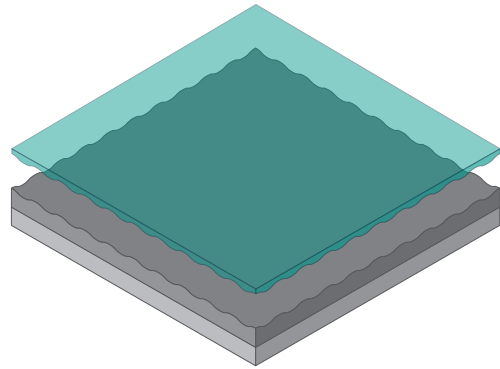

PRODUCTS
GRAIN
GRANITO
KAYAR
KAYAR LL
NATURA
SCREED
MULTIFLOOR / ND - UNI
UNI LL
DHARMA

A surface treatment utilising the latest generation UV linked polymeric coating technology. The coating finish protects the surface, improves performance and reduces the need for cleaning and maintenance.

Advantages of PRO treatment compared with standard flooring

- High protection against dirt and scratches
- Enhanced resistance to stains and chemical agents
- No further wax/polishing necessary [except for added protection in very high traffic areas]
- Easier cleaning and maintenance
- Saving in water, detergents and energy
- Excellent economical impact on lifecycle cost
- Lower TVOC emission

Trattamento superficiale realizzato tramite spalmatura di coating polimerico di ultima generazione fissato con reticolazione UV. La copertura polimerica protegge la superficie migliorandone le performance riducendo gli interventi di pulizia e manutenzione.

Vantaggi del trattamento PRO rispetto al pavimento tradizionale

- Ottima protezione da sporco e graffi
- Migliore resistenza a macchie ed agenti chimici
- Non è necessaria la ceratura [ad eccezione delle aree ad alto traffico, come ulteriore protezione]
- Facilità di pulizia e manutenzione
- Risparmio di acqua, detersivi ed energia
- Ottimo impatto economico sul ciclo di vita del prodotto
- Ridotta emissione di TVOC

Traitement de la surface réalisé par enduisage d'un coating de polymères de la dernière génération fixé avec réticulation UV. La couverture polymérique protège la surface, en améliorant les performances et en réduisant les opérations de nettoyage et entretien.

Avantages du traitement PRO par rapport au sol traditionnel

- Excellente protection de la saleté et des égratignures
- Résistance meilleure aux taches et aux agents chimiques
- Pas de cirage [à l'exception de zones à passage intense comme ultérieure protection]
- Facilité de nettoyage et entretien
- Economie d'eau, détergents et énergie
- Excellent résultat économique sur le cycle vital du produit
- Emissions réduites d'après TVOC test

Oberflächenbehandlung, bei der eine Polymervergütung der letzten Generation aufgebracht und UV- vernetzt wird. Die Vergütung schützt die Oberfläche, verbessert die Widerstandsfähigkeit und reduziert Pflege- und Reinigungskosten.

Vorteile der PRO Oberflächenvergütung im Vergleich mit Standardbodenbelägen

- Hoher Schutz gegen Schmutz und Zerkratzen
- Bessere Widerstandsfähigkeit gegen Flecken und chemische Substanzen
- Einlassen ist nicht notwendig [nur zum zusätzlicher Schutz in extrem beanspruchten Bereichen]
- Leichtere Reinigung und Pflege
- Einsparung von Wasser, Reinigungsmittel und Energie
- Kosteneinsparung über den gesamten Lebenszyklus des Bodenbelags
- Geringere Emission von flüchtigen organischen Verbindungen (VOC)

Tratamiento superficial realizado a través de la aplicación del coating polimerico de última generación fijado con reticulación UV. La cobertura polimérica protege la superficie mejorando la performance reduciendo las operaciones de limpieza y manutención.

Ventajas del tratamiento PRO respecto al pavimento tradicional

- Óptima protección de la suciedad y rasguños
- Mejor resistencia a las manchas y agentes químicos
- No es necesario el encerado [excepto en zonas de alto tráfico, como ulterior protección]
- Facilidad de limpieza y manutención
- Ahorro de agua, detergents y energía
- Óptimo impacto económico en el ciclo de vida del producto
- Reducida emisión de TVOC

TXL

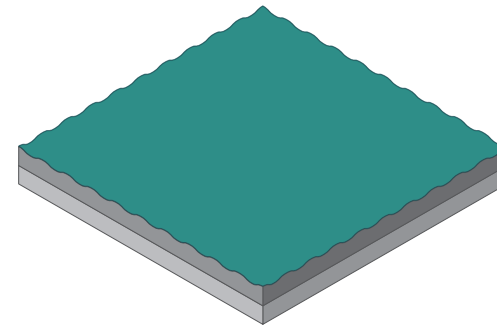

PRODUCTS
BS CLASSIC
BS STRONG
LAVA
ZEUS

Post vulcanization treatment that achieves a lower surface density whilst increasing surface resistance, enhancing cleaning, dirt and scratch resistant properties.

Advantages of TXL treatment compared with standard flooring

- Enhanced protection against dirt and scratches
- No further wax/polishing necessary in low traffic areas
- Easier cleaning and maintenance
- Saving in water, detergents and energy
- Appreciable economical impact on lifecycle cost

Trattamento superficiale di postvulcanizzazione che incrementa la resistenza e densità superficiale. La minor porosità della superficie ne migliora la pulibilità e la resistenza allo sporco.

Vantaggi del trattamento TXL rispetto al pavimento tradizionale

- Maggiore protezione da sporco e graffi
- Non è necessaria la ceratura per applicazioni soggette a manutenzione regolare con utilizzo di monospazzola
- Facilità di pulizia e manutenzione
- Risparmio di acqua, detersivi ed energia
- Buon impatto economico sul ciclo di vita del prodotto

Traitement superficiel de post vulcanisation qui augmente la résistance et la densité de la surface. La moindre porosité de la surface améliore le nettoyage et la résistance à la saleté.

Avantages du traitement TXL par rapport au sol traditionnel

- Protection meilleure de la saleté et des égratignures
- Cirage non pas nécessaire en cas d'entretien régulier avec mono brosse.
- Facilité de nettoyage et entretien
- Economie d'eau, détergents et énergie
- Excellent résultat économique sur le cycle vital du produit

Postvulkanisationsbehandlung, welche die Dichte und Widerstandsfähigkeit der Oberfläche erhöht. Eine niedrigere Oberflächenporosität verbessert Reinigungs- und Anschmutzverhalten.

Vorteile der TXL Oberflächenverdichtung im Vergleich mit Standardbodenbelägen

- Besserer Schutz gegen Schmutz und Zerkratzen
- Einlassen ist in Bereichen mit niedriger Frequenz nicht notwendig, wenn mit Einscheibenmaschinen u. ähnliches regelmäßig gereinigt wird
- Leichtere Reinigung und Pflege
- Einsparung von Wasser, Reinigungsmittel und Energie
- Merkbare Kostenersparnis über den gesamten Lebenszyklus des Bodenbelags

Tratamiento superficial de postvulcanización que incrementa la resistencia y densidad superficial. La menor porosidad de la superficie mejora la limpieza y la resistencia a la suciedad.

Ventajas del tratamiento TXL respecto al pavimento tradicional

- Mayor protección a la suciedad y a los rasguños
- No es necesario el encerado para aplicaciones sometidas a manutención regular de utilización de mono-escoba
- Facilidad de limpieza y manutención
- Ahorro de agua, detergents y energía
- Buen impacto económico sobre el ciclo de vida del producto

STAIRSYSTEM

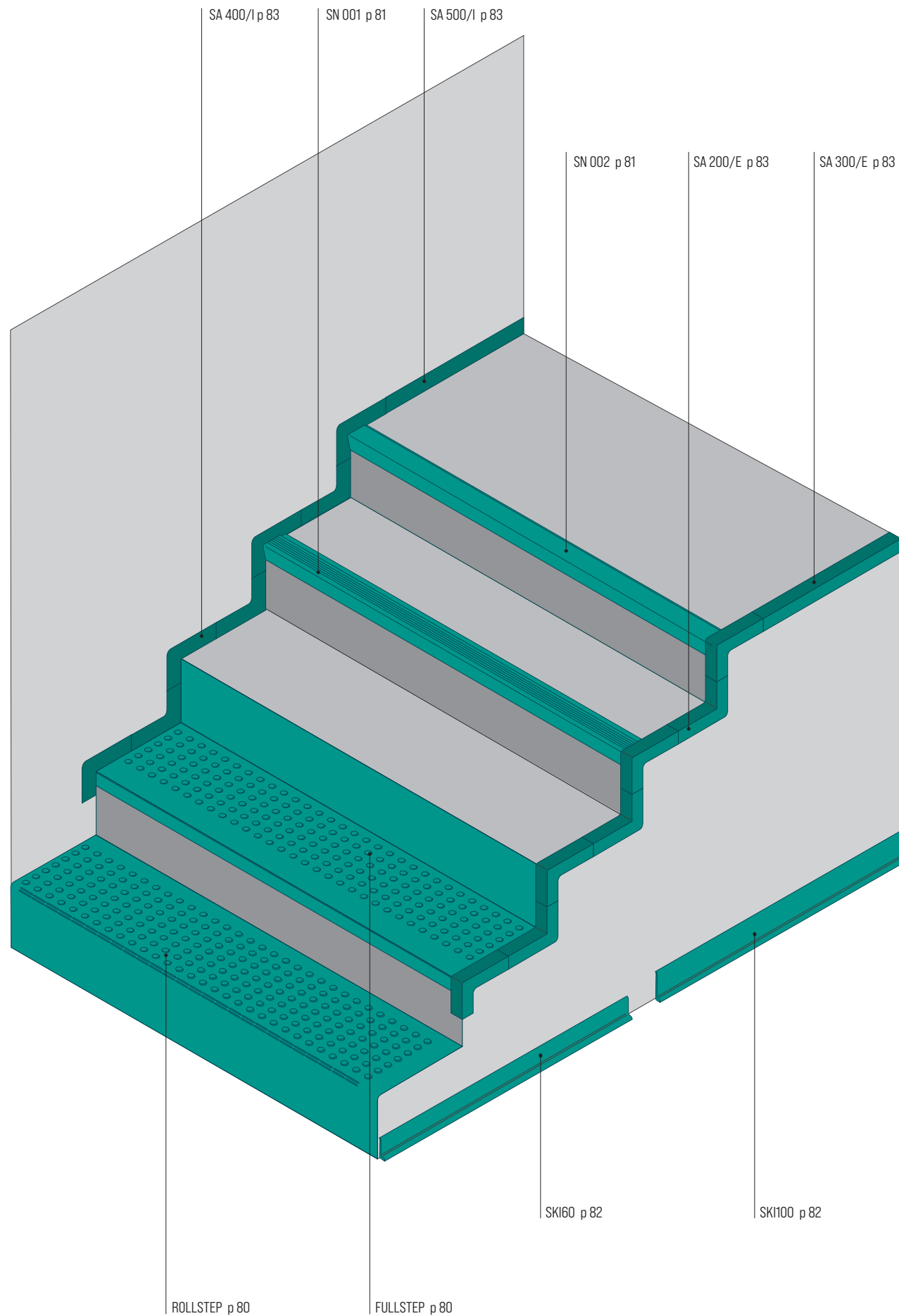

FULLSTEP

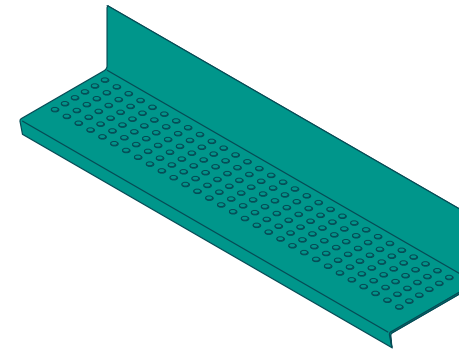

Square nosed step covering. One-piece step covering with studded tread, smooth nosing and riser

Rivestimenti gradini a spigolo vivo. Rivestimento gradino costituito da pedata con rilievo a bolli bassi, paraspigolo e alzata liscia in un sol pezzo

Marches integrales pour escalier à nez vif. Marche intégrale constituée d'une marche avec relief à pastille basse, nez de marche et contremarche lisse dans une seule pièce

Beläge für stufen mit rechtwinkligen kanten. Einteiliges Formtreppenteil, mit genopptem Trittstufenteil, Treppenkante und glatter Setzstufe

Revestimiento de peldaños con bordes vivos. Revestimiento de peldaño formado por peldaño en relieve a círculos bajos, moldura y contrapeldaño en una sola pieza

ROLLSTEP

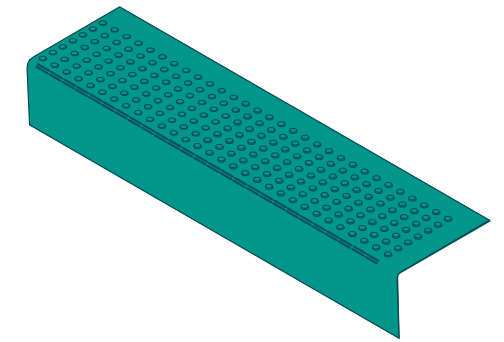

Round nosed step covering. Step covering in rolls (12 m) with a low studded tread ribbed nosing and smooth riser

Rivestimenti gradini a spigolo arrotondato. Rivestimento gradino costituito da pedata con rilievo a bolli bassi, paraspigolo con rigature trasversali e alzata liscia

Marches integrales pour escaliers à nez arrondi. Marche intégrale en rouleaux constituée d'une marche avec relief à pastille basse, de nez de marche cannelé et de contremarche lisse

Beläge für stufen mit gerundeten kanten. Rollen- Formtreppenstufen: Trittstufe mit Rundnoppen, gerippten Treppenkanten mit geringem Verschnitt und glatter Setzstufe

Revestimiento de peldaños con bordes redondeados. Revestimiento de peldaños formado por el peldaño con relieve a círculos bajos, moldura con estrias transversales y contrapeldaño liso

SA 400/I

Internal stair angles for square nosed steps

Angolari interni per gradini a spigolo vivo

Angles intérieurs d'escaliers à nez vif pour paliers

Treppenwinkel wandseitig (für scharfkantige Stufen)

Angulares interiores para peldaños con bordes vivos

SA 500/I

Internal skirting for landing

Battiscopa interno per pianerottolo

Plinthe intérieure pour palier

Podestleiste wandseitig

Zócalo interior para rellanos

SA 200/E

External stair angles for square nosed steps

Angolari esterni per gradini a spigolo vivo

Angles extérieurs d'escalier à nez vif pour palier

Treppenwinkel aussen (für scharfkantige Stufen)

Angulares exteriores para peldaños con bordes vivos

SA 300/E

External skirting for landing

Battiscopa esterno per pianerottolo

Plinthe extérieure pour palier

Podestleiste aussen

Zócalo exterior para rellanos

SN 001

Ribbed stair nosing for square nosed steps

Paragradino rigato per gradini a spigolo vivo

Nez de marches striés pour marches à nez vif

Treppenkante gerillt (für scharfkantige Stufen)

Moldura con estrias para peldaños con bordes vivos

SN 002

Smooth stair nosing for square nosed steps

Paragradino liscio per gradini a spigolo vivo

Nez de marches lisses pour marches à nez vif

Treppenkante glatt (für scharfkantige Stufen)

Moldura lisa para peldaños con bordes vivos

SK160

Skirting ca. 60 mm in height

Battiscopa altezza ca. 60 mm

Plinthe hauteur ca. 60 mm

Sockelleiste ca. 60 mm hoch

Zócalo de ca. 60 mm de altura

SK1100

Skirting ca. 100 mm in height

Battiscopa altezza ca. 100 mm

Plinthe hauteur ca. 100 mm

Sockelleiste ca. 100 mm hoch

Zócalo de ca. 100 mm de altura

FULLSTEP / ROLLSTEP

FULLSTEP

Square nosed step covering
 Rivestimenti gradini a spigolo vivo
 Marches integrales pour escalier à nez vif
 Beläge für stufen mit rechtwinkligen kanten
 Revestimiento de peldaños con bordes vivos

54 x 120/360 cm

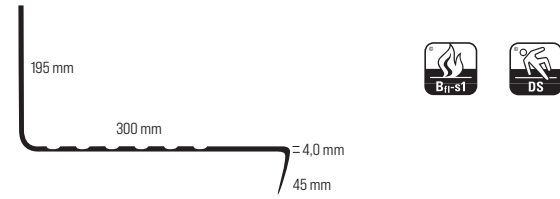

ROLLSTEP

Round nosed step covering
 Rivestimenti gradini a spigolo arrotondato
 Marches integrales pour escaliers à nez arrondi
 Beläge für stufen mit gerundeten kanten
 Revestimiento de peldaños con bordes redondeados

52 x 1200 cm

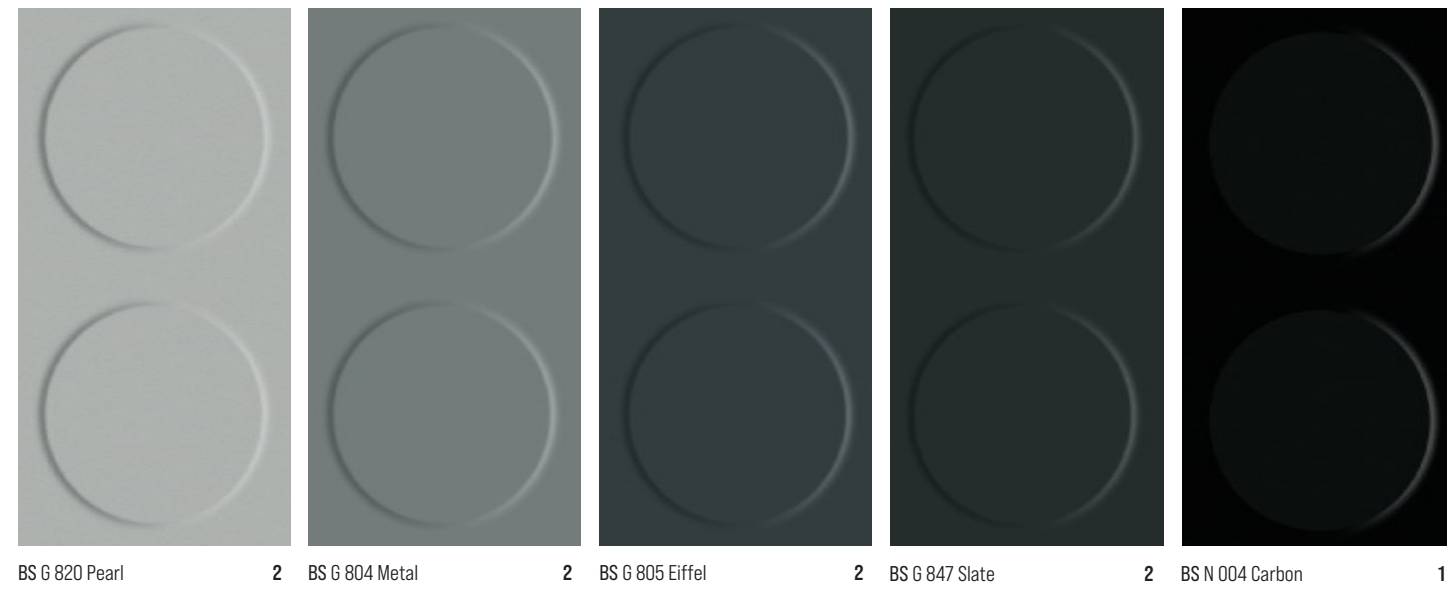
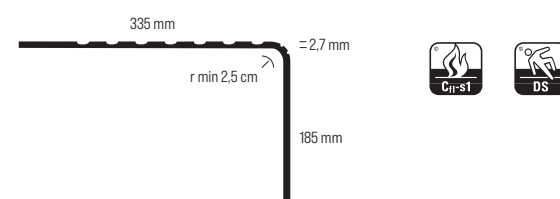

80 BS G 820 Pearl 2 BS G 804 Metal 2 BS G 805 Eiffel 2 BS G 847 Slate 2 BS N 004 Carbon 1



BS R 922 Love 3

SN 001 / 002

Rubber profiles for sharp-edged steps
 Profili in gomma per gradini a spigolo vivo
 Profils en caoutchouc pour marches à arête vive
 Kautschukprofile zur Verkleidung von scharfkantigen Stufen
 Perfiles en goma para peldaños de arista viva

SN 001

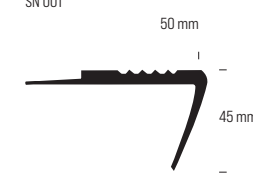

SN 002

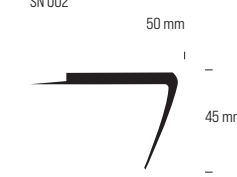

Y 507

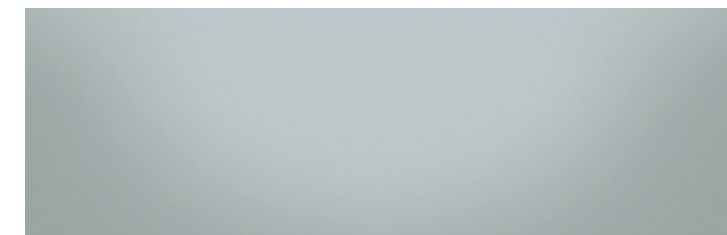

SILVER



G 804



TITAN



G 805

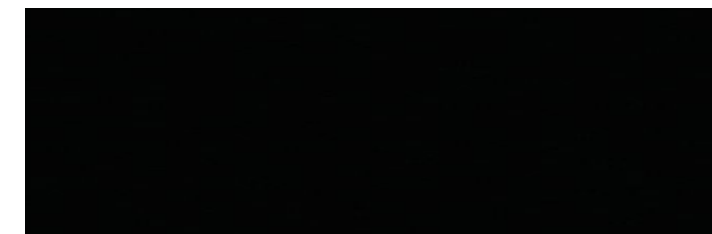

N 004

SNA

Aluminium profiles for sharp-edged steps
 Profili in alluminio per gradini a spigolo vivo
 Profils aluminium pour nez de marche à arête vive
 Aluminiumprofile zur Verkleidung von scharfkantigen Stufen
 Perfiles de aluminio para de peldaños de arista viva

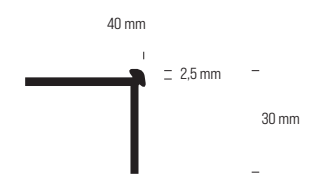
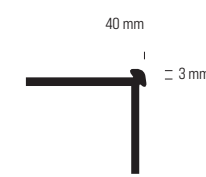

SKI 60 / SKI 100

Rubber profiles for skirtings
 Profili in gomma per battiscopa
 Profils en caoutchouc pour plinthes
 Kautschukprofile für Sockelleisten
 Perfil de goma para zócalos

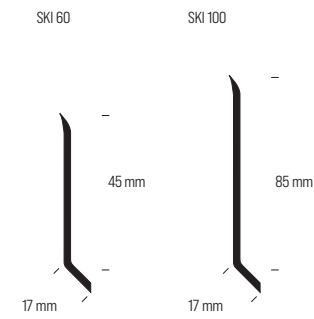

B 207

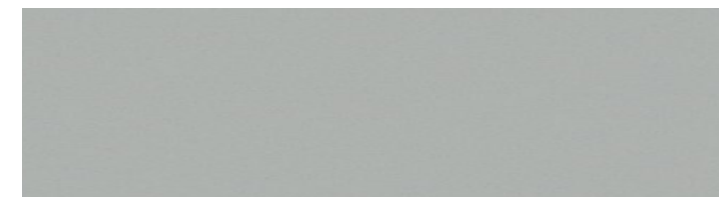

G 820



G 804



G 805



N 004

PS 25

Cove former
 Profilo per sguscia
 Profilés pour remontée
 Hohlkehprofil
 Perfil de salida

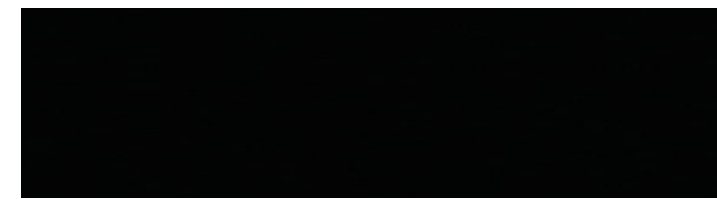
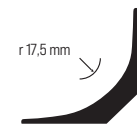

N 004

SA

Stair profiles
 Profili per scale
 Plinthes pour escalier
 Treppenwinkel
 Perfiles para escaleras

SA 400/1 - SA 500/1

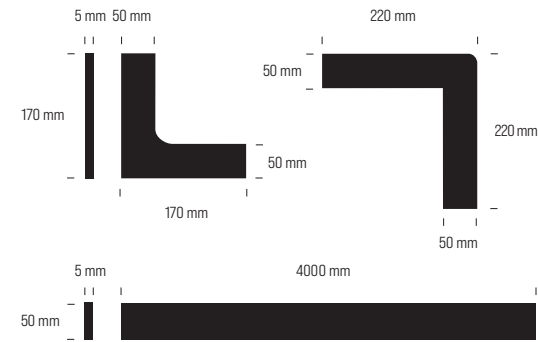

G 804



G 805



N 004

SA 200/E - SA 300/E

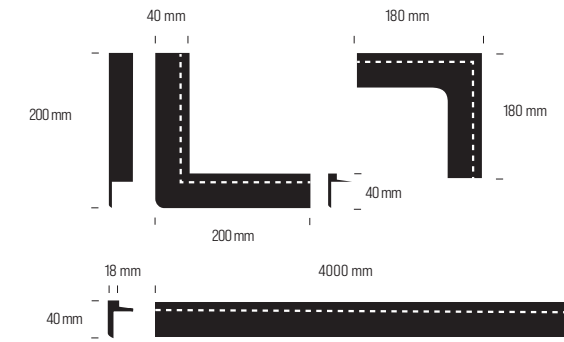

Physical and mechanical characteristics

Caratteristiche fisico-meccaniche

Caracteristiques mecaniques et physiques

Technische Eigenschaften

Características físicas y mecánicas

	Standard <i>Norma</i> <i>Norme</i> <i>Norm</i> <i>Norma</i>	Unit <i>U. di misura</i> <i>Unité</i> <i>Masseinheit</i> <i>Unidad</i>	Requirements <i>Requisiti</i> <i>Exigences</i> <i>Anforderung</i> <i>Valores</i>	DHARMA	KAYAR ND UNI NATURA	GRAIN SCREED	GRANITO	GRANITO ANT 48	X-Elastic versions
Hardness Durezza Dureté Härte Dureza	ISO 48-4 (ISO 7619)	Shore A	≥ 75	85	90 85 88	90 88	90	85	88 84 (Dharma)
Residual indentation Impronta Residua Poinçonnement rémanent Resteindruck Punzonamiento residual	EN/ISO 24343-1 mm (EN 433)		≤ 0,15 ≤ 0,20 ≤ 0,25	0,03	- 0,04 -	- 0,04 -	0,03 -	0,03 -	- - 0,20
Abrasion resistance Resistenza all'abrasione Résistance à l'abrasion Abriebfestigkeit Resistencia a la abrasión	ISO 4649 (Met. A-5N)	mm ³	≤ 250	130	175 165 145	150 165	150	130	Kayar 190 Nd Uni 165 Natura 145 Grain 150 Screed 165 Granito 150 Lava 150 Dharma 130
Dimensional stability Stabilità dimensionale Stabilité dimensionnelle Maßbeständigkeit Estabilidad dimensional	EN/ISO 23999 (EN 434)	%	± 0,40 max	± 0,30	± 0,30				
Flexibility Flessibilità Flexibilité Biegsamkeit Flexibilidad	EN/ISO 24344 Met. A Ø 20 mm (EN 435)		No fissuring Nessuna fessurazione Pas de fissuration Keine Rißbildung Ninguna fisura	Comply Conforme	Comply Conforme				
Colour fastness to artificial light Solidità del colore alla luce artificiale Essais de tenue des couleurs à la lumière artificielle Farbbeständigkeit gegenüber künstlichem Licht geeignet Solidez del color a la luz artificial	ISO105-B02 Met. 3	Degree Grado Degré Stufe	≥ 6 blue scale ≥ 3 grey scale ≥ 6 scala dei blu ≥ 3 scala dei grigi ≥ 6 échelle de bleu ≥ 3 échelle de gris ≥ 6 des Blaumaßstabs ≥ 3 des Graumaßstabs ≥ 6 escala de azules ≥ 3 escala de grises	Comply Conforme	Comply Conforme				
Cigarette burn Effetto bruciatura sigaretta Résistance aux cigarettes incandescentes Einwirkung glimmender Tabakwaren Efecto quemadura cigarrillos	EN 1399	Rating Stufe	Met. A ≥ 4 Met. B ≥ 3	Comply Conforme	Comply Conforme				

	Standard <i>Norma</i> <i>Norme</i> <i>Norm</i> <i>Norma</i>	Unit <i>U. di misura</i> <i>Unité</i> <i>Masseinheit</i> <i>Unidad</i>	Requirements <i>Requisiti</i> <i>Exigences</i> <i>Anforderung</i> <i>Valores</i>	DHARMA	KAYAR ND UNI NATURA	GRAIN SCREED	GRANITO	GRANITO ANT 48	X-Elastic versions
Fire behaviour Reazione al fuoco Comportement au feu Brandverhalten Reacción al fuego	EN 13501-1	Class Classe Clase Klasse		Bfl-s1	Bfl-s1 Kayar Nd Uni Cfl-s1 Natura	Bfl-s1 Grain Cfl-s1 Screed	Bfl-s1	Bfl-s1	Cfl-s1
Slip resistance Resistenza allo scivolamento Résistance au glissement Rutschhemmung Resistencia al deslizamiento	EN 13893	Class Classe Clase Klasse	≥ 0,30 (DS)	≥ 0,30	≥ 0,30				
Resistance to stains Resistenza alle macchie Résistance aux taches Chemikalienbeständigkeit Resistencia a las manchas	EN/ISO 26987 (EN 423)			Resistent ⁽¹⁾ Resistente ⁽¹⁾ Résistant ⁽¹⁾ Beständig ⁽¹⁾	Resistent ⁽¹⁾ Resistente ⁽¹⁾ Résistant ⁽¹⁾ Beständig ⁽¹⁾				
Electrostatic charge Carica elettrostatica da calpestio Charge électrostatique à la marche Elektrostatisches Verhalten C beim Begehen arga electrostática a la pisada	EN 1815	kV		≤ 2	≤ 2				
Reduction of sound due to treading Riduzione del rumore da calpestio Insolation acoustique à la marche Trittschallverbesserungsmaß Reducción del ruido a la pisada	ISO 10140-3	dB	Up to Fino a	6	10	10	6	6	20
Castor chairs Effetto sedia a rotelle L'action d'une chaise à roulettes Stuhlrollenversuch Efecto de las sillas de ruedas	EN/ISO 4918 (EN 425)				Suitable for W castors Adatto con ruote tipo W Convient aux chaises à roulettes type W Geeignet für Rollen Typ W Adecuado con ruedas tipo W				
Electrical behaviour Comportamento elettrico Comportement électrique Erdableitwiderstand Comportamiento eléctrico	EN 1081	ohm	Ant 48: Rv ≤ 10 ⁹ static dissipative						≤ 10 ⁹

⁽¹⁾ In base a concentrazione e tempo di contatto, per agenti specifici inoltrare richiesta.

Depending on concentration and time of contact, for specific agents please ask.

Dépend du produit de sa concentration et de sa durée de contact avec le revêtement. Pour plus d'informations contactez nos services techniques.

Abhängig von Konzentration und Einwirkzeit, bei speziellen Chemikalien ist Rücksprache erforderlich.

En función a la concentración y el tiempo de contacto, consultar para productos específicos.

Physical and mechanical characteristics

Caratteristiche fisico-meccaniche

Caracteristiques mecaniques et physiques

Technische Eigenschaften

Caracteristicas fisicas y mecanicas

	Standard	Unit	Requirements	UNI/LL KAYAR/LL	BS- CLASSIC STRONG	LAVA	ZEUS	ZEUS ANT 48
	Norma	U. di misura	Requisiti					
	Norme	Unité	Exigences					
	Norm	Masseinheit	Anforderung					
	Norma	Unidad	Valores					
Hardness Durezza Dureté Härte Dureza	ISO 48-4 (ISO 7619)	Shore A	≥ 70 ≥ 75	86	90	90	90	85
Residual indentation Impronta Residua Poinçonnement rémanent Resteindruck Punzonamiento residual	EN/ISO 24343-1 mm (EN 433)		≤ 0,20 ≤ 0,25	≤ 0,20	0,08 0,12	0,09 -	- 0,06	- 0,15
Abrasion resistance Resistenza all'abrasione Résistance à l'abrasion Abriebfestigkeit Resistencia a la abrasión	ISO 4649 (Met. A-5N)	mm ³	≤ 250	150 175	160	150	140	160
Dimensional stability Stabilità dimensionale Stabilité dimensionnelle Maßbeständigkeit Estabilidad dimensional	EN/ISO 23999 (EN 434)	%	± 0,40 max	± 0,30				
Flexibility Flessibilità Flexibilité Biegsamkeit Flexibilidad	EN/ISO 24344 Met. A Ø 20 mm (EN 435)		No fissuring Nessuna fessurazione Pas de fissuration Keine Rißbildung Ninguna fisura	Comply Conforme				
Colour fastness to artificial light Solidità del colore alla luce artificiale Essais de tenue des couleurs à la lumière artificielle Farbbeständigkeit gegenüber künstlichem Licht geeignet Solidez del color a la luz artificial	ISO105-B02 Met. 3	Degree Grado Degré Stufe	≥ 6 blue scale ≥ 3 grey scale ≥ 6 scala dei blu ≥ 3 scala dei grigi ≥ 6 échelle de bleu ≥ 3 échelle de gris ≥ 6 des Blaumaßstabs ≥ 3 des Graumaßstabs ≥ 6 escala de azules ≥ 3 escala de grises	Comply Conforme				
Cigarette burn Effetto bruciatura sigaretta Résistance aux cigarettes incandescentes Einwirkung glimmender Tabakwaren Efecto quemadura cigarrillos	EN 1399	Rating Stufe	Met. A ≥ 4 Met. B ≥ 3	Comply Conforme				

	Standard	Unit	Requirements	UNI/LL KAYAR/LL	BS- CLASSIC STRONG	LAVA	ZEUS	ZEUS ANT 48
	Norma	U. di misura	Requisiti					
	Norme	Unité	Exigences					
	Norm	Masseinheit	Anforderung					
	Norma	Unidad	Valores					
Fire behaviour Reazione al fuoco Comportement au feu Brandverhalten Reacción al fuego	EN 13501-1	Class Classe Clase Klasse		Bfl-s1	Bfl-s1	Bfl-s1	Bfl-s1	Bfl-s1
Slip resistance Resistenza allo scivolamento Résistance au glissement Rutschhemmung Resistencia al deslizamiento	EN 13893	Class Classe Clase Klasse	≥ 0,30 (DS)	≥ 0,30				
Resistance to stains Resistenza alle macchie Résistance aux taches Chemikalienbeständigkeit Resistencia a las manchas	EN/ISO 26987 (EN 423)			Resistent ⁽¹⁾ Resistente ⁽¹⁾ Résistant ⁽¹⁾ Beständig ⁽¹⁾				
Electrostatic charge Carica elettrostatica da calpestio Charge électrostatique à la marche Elektrostatisches Verhalten C beim Begehen arga electrostática a la pisada	EN 1815	kV		≤ 2				
Reduction of sound due to treading Riduzione del rumore da calpestio Insolation acoustique à la marche Trittschallverbesserungsmaß Reducción del ruido a la pisada	ISO 10140-3	dB	Up to Fino a	16	8 10	10	12	12
Castor chairs Effetto sedia a rotelle L'action d'une chaise à roulettes Stuhlröllenversuch Efecto de las sillas de ruedas	EN/ISO 4918 (EN 425)			Suitable for W castors Adatto con ruote tipo W Convient aux chaises à roulettes type W Geeignet für Rollen Typ W Adecuado con ruedas tipo W				
Electrical behaviour Comportamento elettrico Comportement électrique Erdableitwiderstand Comportamiento eléctrico	EN 1081 Met. A	ohm	Ant 48: Rv ≤ 10 ⁹ static dissipative					≤ 10 ⁹

⁽¹⁾ In base a concentrazione e tempo di contatto, per agenti specifici inoltrare richiesta.

Depending on concentration and time of contact, for specific agents please ask.

Dépend du produit de sa concentration et de sa durée de contact avec le revêtement. Pour plus d'informations contactez nos services techniques.

Abhängig von Konzentration und Einwirkzeit, bei speziellen Chemikalien ist Rücksprache erforderlich.

En función a la concentración y el tiempo de contacto, consultar para productos específicos.

SALES OFFICES

Artigo Spa - Società Unipersonale
Via Cascina Vione 3
20079 Basiglio (Mi) · Italy
Tel +39 0290786415
Fax +39 0290786449

Artigo France Sarl
24 Rue Firmin Gillot
75 015 Paris · France
Tel +33 142770000
Fax +33 143487731

Artigo Iberica SL
Profesor Beltran Baguena 4
46009 Valencia · Spain
Tel +34 963498899
Fax +34 963498713

HEADQUARTERS

Artigo Spa - Società Unipersonale
Via Cortemilia 32
Loc. Carpeneto
17014 Cairo Montenotte (SV) · Italy
Tel +39 019509011
Fax +39 019505513

www.artigo.com

art direction
& graphic design
Sunjester

3D illustrations
Davit & Mary Jilavyan
/ **Lemeal Studio**

print
AZ Color

I dati tecnici riportati in questo catalogo possono essere soggetti a modifiche senza preavviso.

The technical details shown in this catalogue are subject to change without notice.

Les données techniques figurant dans ce catalogue peuvent être sujettes à modifications sans avis préalable.

Die in diesem Katalog wieder-gegebenen technischen Daten können ohne Vorankündigung verändert werden.

Los datos técnicos indicados en este catálogo pueden ser modificados sin aviso previo.

